

# Production Based Energy Management Tools for the Food Processing Industry

1<sup>st</sup> Colloquium of the Munich School of Engineering  
“Sustainable Energy Supply for the Future”

**Dipl.-Ing. Sven Franke**

Chair of Food Packaging Technology

Prof. Dr. rer. nat. Horst-Christian Langowski

# Approach of the production based energy management

- Plant data capture and data analysis
- Establishing measuring points for energy monitoring and energy performance analysis
- Development of models for describing and forecasting the plants demand for energy
- Structured analysis of manufacturing schedules
- Compliance with manufacturing and technological boundary conditions

# Methods of the production based energy management

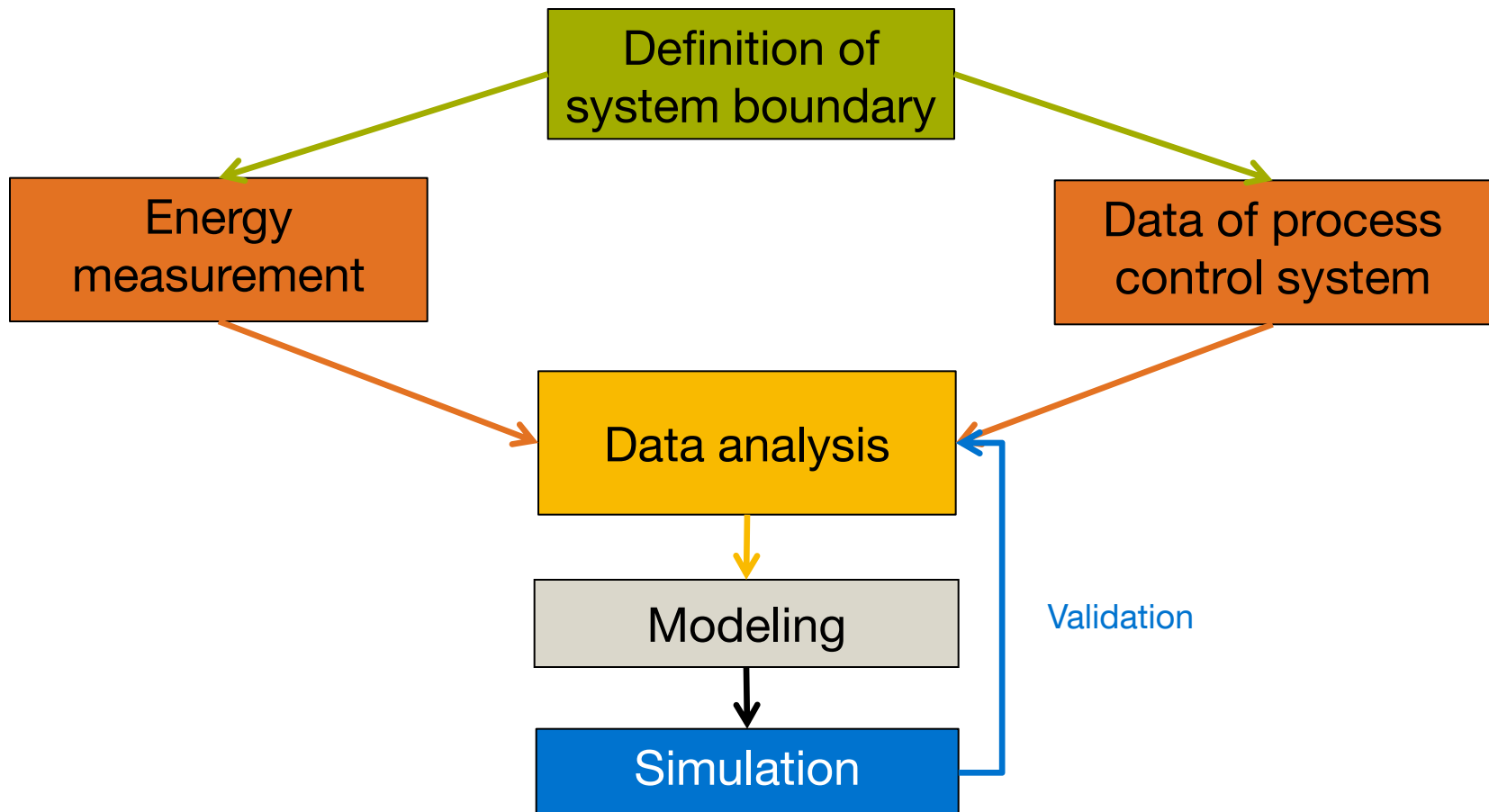

# Overview of energy consumption units

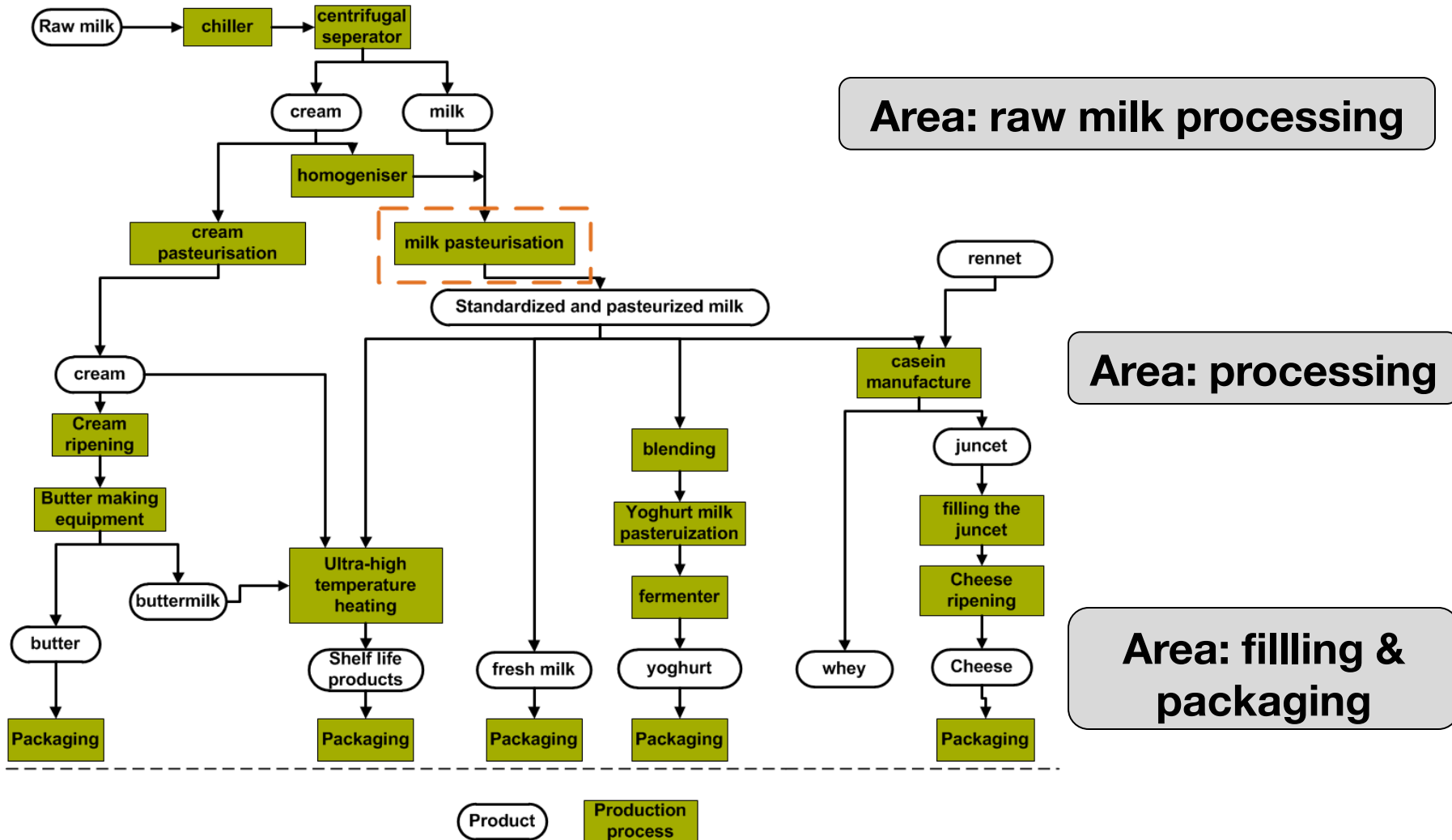

# Overview of energy consumption units

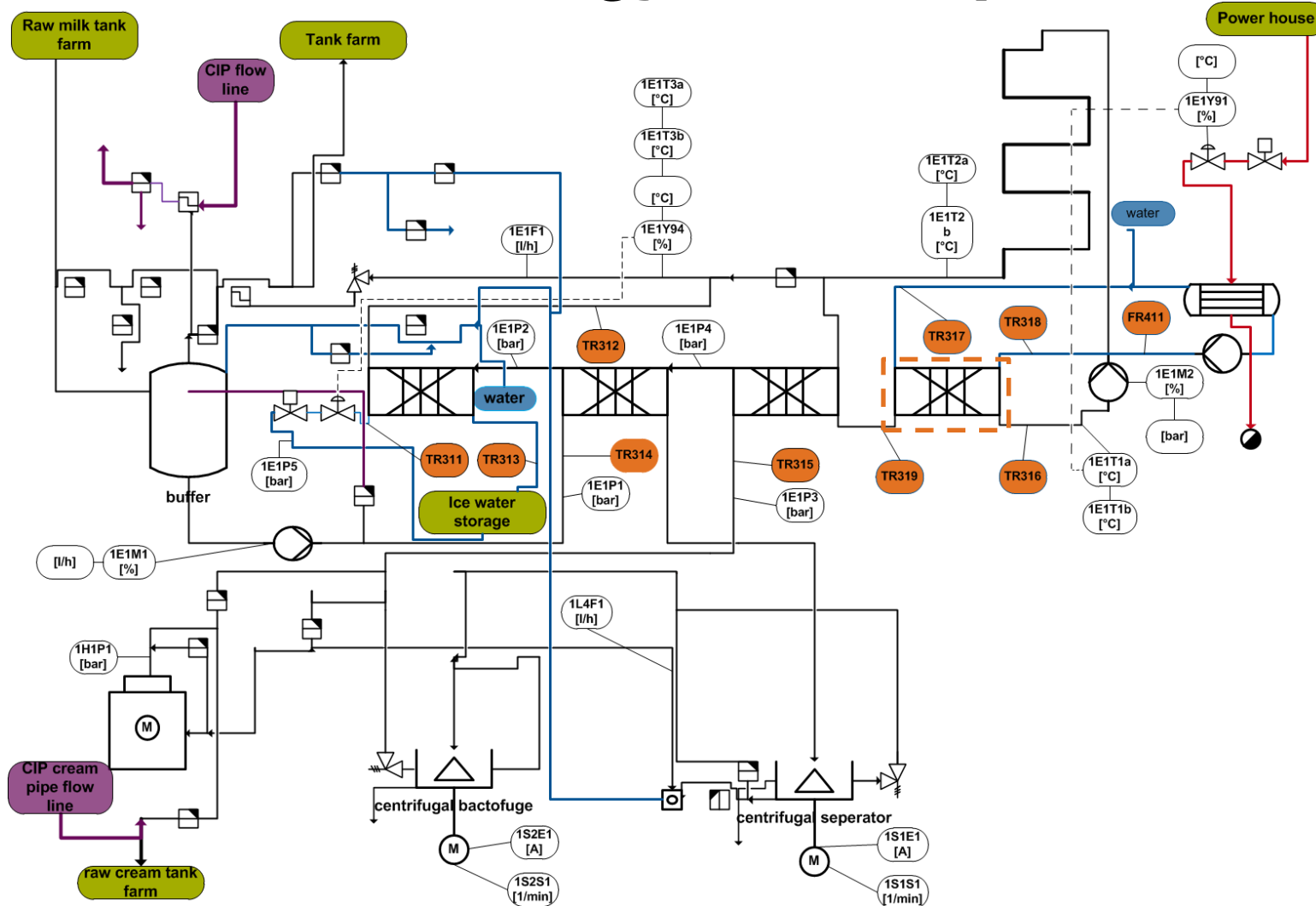

# Measurement methods

Temperature measurement:  
 -PT 1000 surface temperature sensors  
 -data logging system

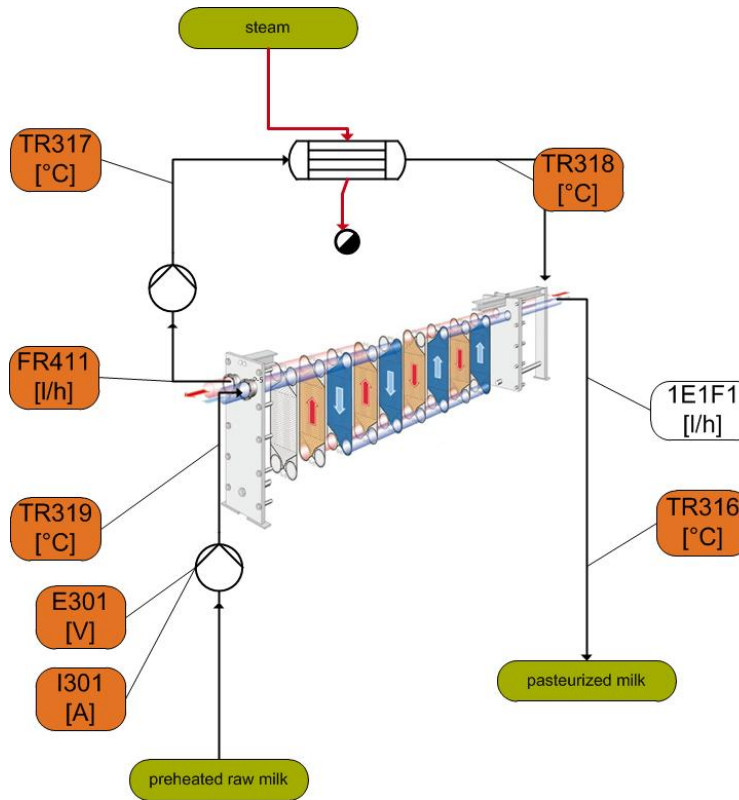

Flow measurement:  
 -Clamp-on ultrasonic sensor  
 -data logging system

Electrical power:  
 -Clamp ammeter  
 -Measuring at the switching cabinet of each consumer

Process control system:  
 -Using sensor values of the control system  
 -SQL data base storage

# Energy based phase tracking

Classification of the plant status into phases

**Production Process**

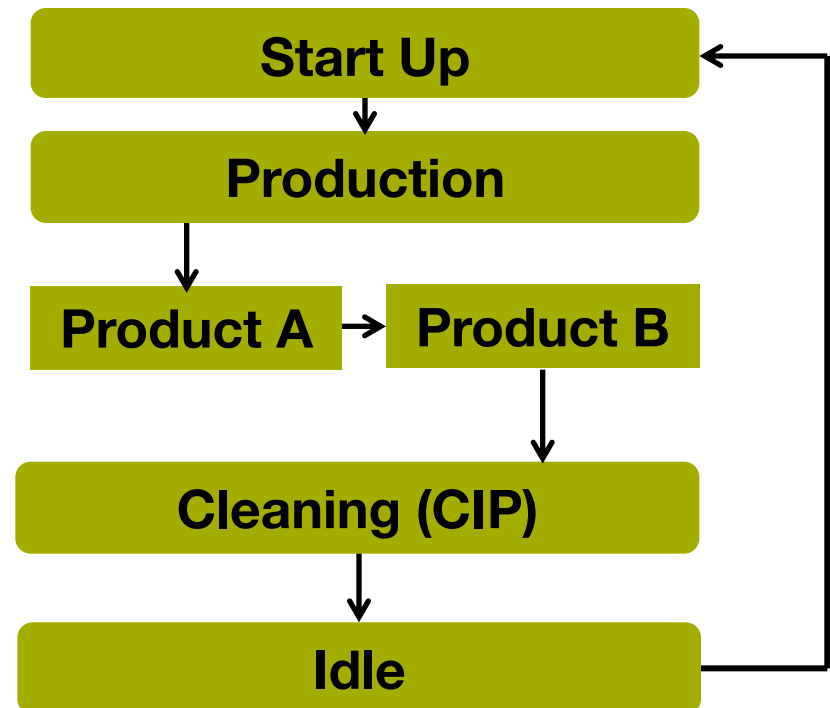

➔ Calculation of production based green indicators

# Visualisation of the stationary energy flow by a Sankey diagram

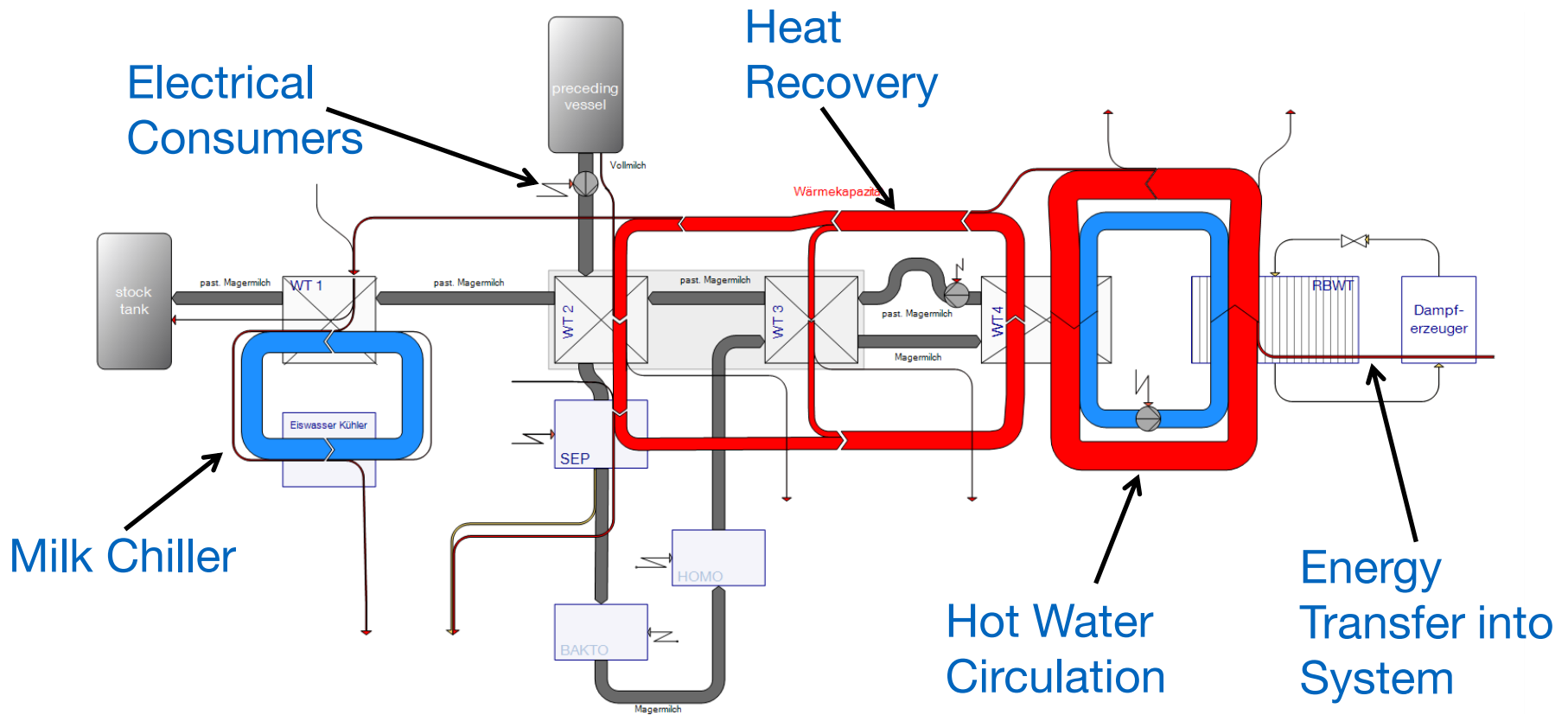



# Production based as-is analysis: graphical approach, time series

Pasteurization  
Temperature

Heat Transfer  
Hot Water  
Circulation

- Diagnostic function for historical data
- Time behaviour of the process
- Calculation of phase based energy key indicators

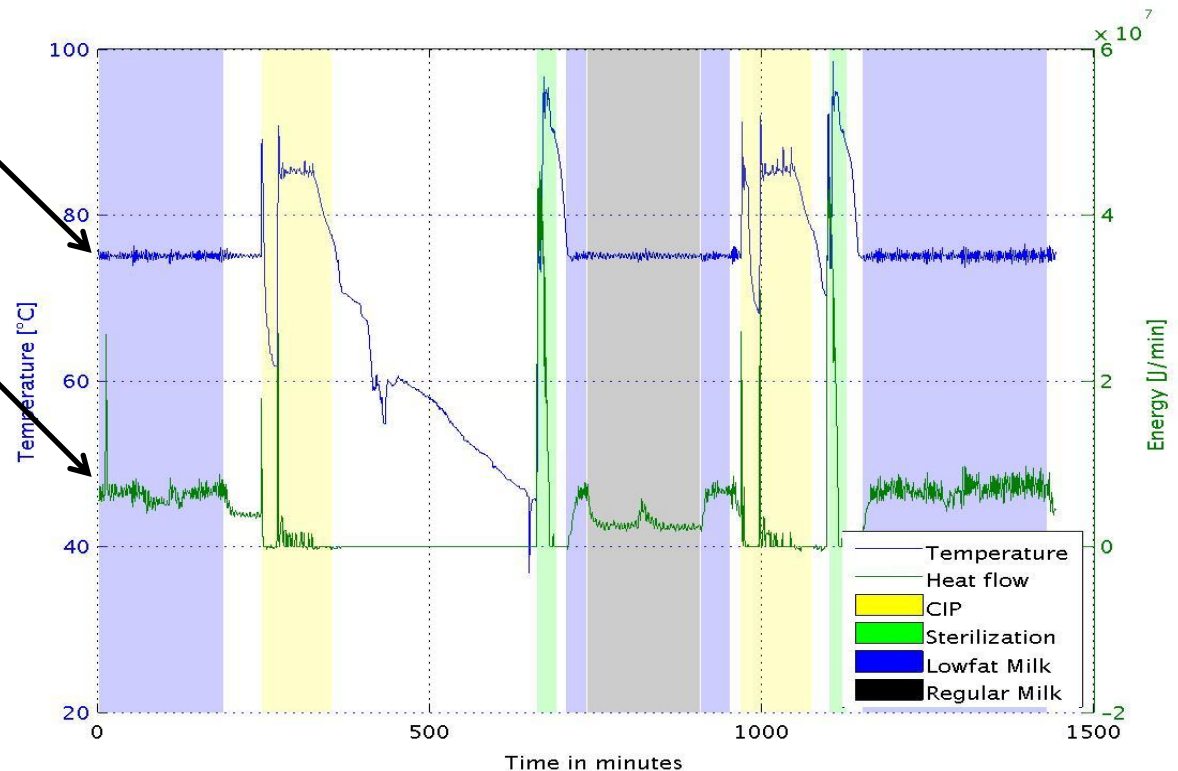

# Energy based process simulation – component library

Electrolytischer  
Energieerzeugendes  
systemer system  
separator

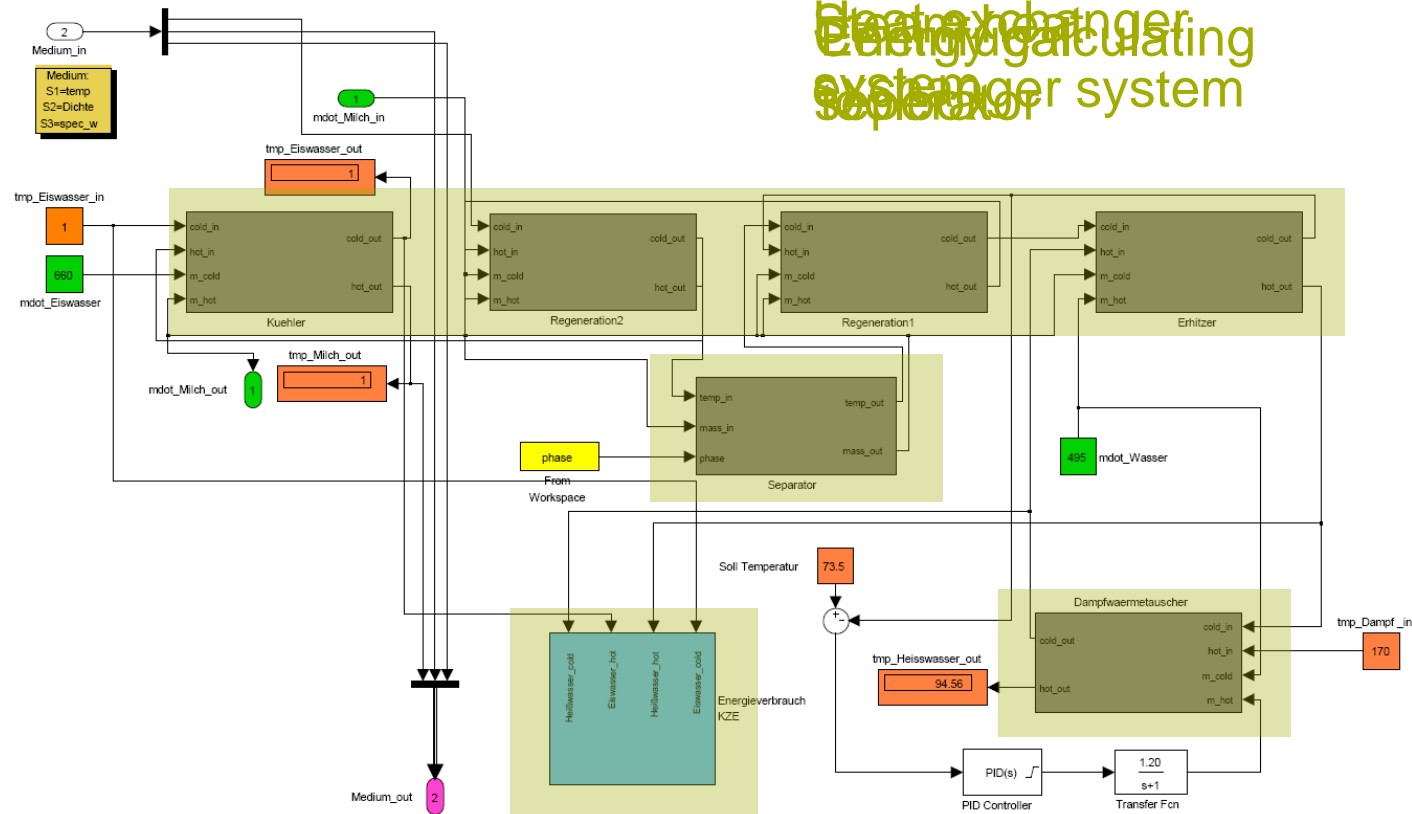

# Energy based process simulation – model validation

- Blue curve: simulation data
- Red curve: measured data
- Validation results show a good accordance
- Simulation recognizes the different process phases
- Simulation of the time response

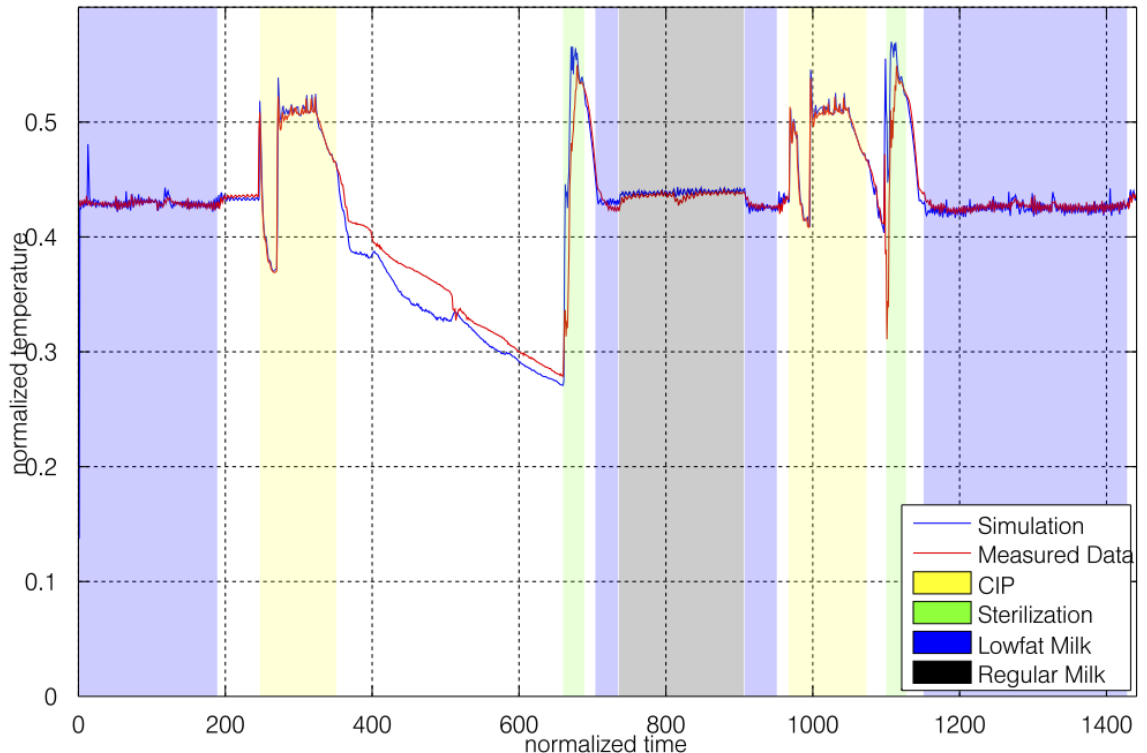

# Energy based process simulation – energy plot with forecasting function

- Calculated energy by the toolbox
- Energy consumption of the simulation process
- Identifying energy key indicators of each phase
- Simulation helps to forecast the energy demand for a production process
- Testing new production schedules

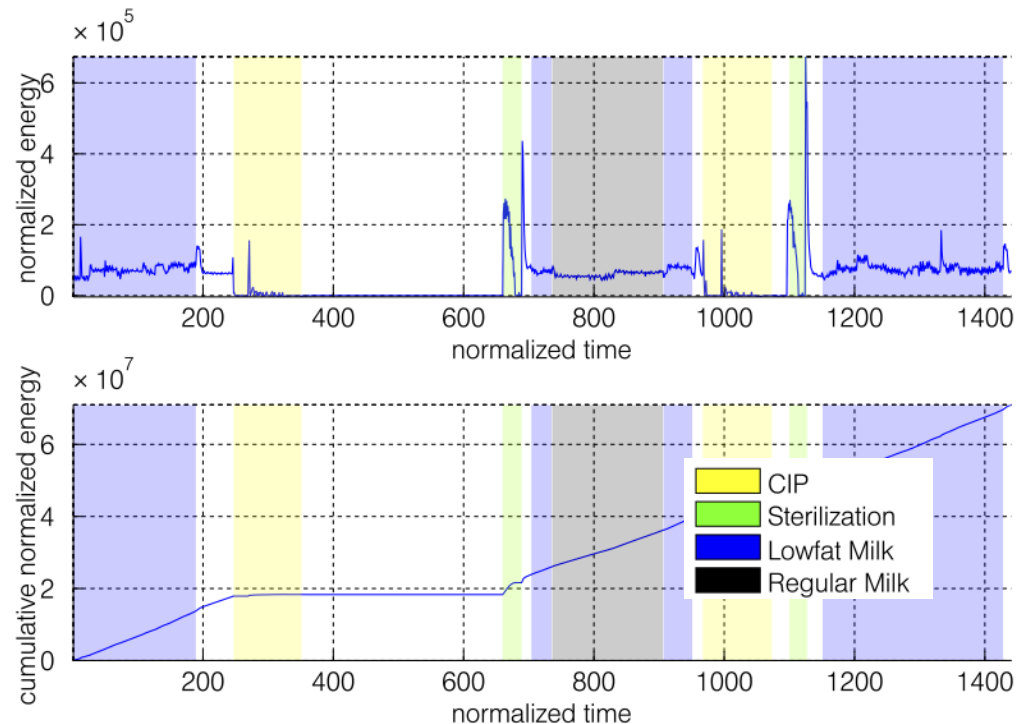

# Next steps

- Simulation of technical optimization
- Analyzing the manufacturing schedules
- Modeling an optimization approach for production scheduling
- Validate the optimized schedules with the process simulation
- Integration of green production indicators into an MES

# Thank you for your attention

**Sven Franke<sup>a</sup>, Josef Höfler<sup>c</sup>, Winfried Russ<sup>b</sup>, Tobias Voigt<sup>a</sup>, Hannes Petermeier<sup>c</sup>, Horst-Christian Langowski<sup>a</sup>**

<sup>a</sup> *Lehrstuhl für Lebensmittelverpackungstechnik, Freising-Weihenstephan, Germany,*

<sup>b</sup> *Arbeitsgruppe Umwelttechnik in der Lebensmittelindustrie, Freising-Weihenstephan, Germany*

<sup>c</sup> *Fachgebiet Biostatistik, Freising-Weihenstephan, Germany*

The work is funded by the “Bayrisches Staatsministerium für Wissenschaft, Forschung und Kunst” in the “Forschungsverbund energieeffiziente Technologie und Anwendungen” program initiated in October 2009

