

AgTecCollection

(Agrartechnische Kollektion)

in

mediaTUM[®]

Bilder Downloads 2014

H. Auernhammer

A. Seifert

Freising

2015

Vorwort

Zum Jahresende 2014 war in der agrartechnischen Kollektion (AgTecCollection) in mediaTUM® die Erschließung der gescannten Bilder weitgehend abgeschlossen. Der öffentlich verfügbare Bestand setzt sich wie folgt zusammen:

| | | |
|--|---------------------------------------|--------|
| Öffentlich verfügbare Objekte (Bilder) | | 44.172 |
| Herkunft | Landtechnik Weihenstephan TUM | 34.541 |
| | Lehrstuhl für Landmaschinen TUM | 4.358 |
| | Humboldt Universität Berlin HUB | 5.139 |
| | Justus Liebig Universität Gießen JLUG | 134 |
| Bild-Typ | Fotografie | 26.640 |
| | Übersicht | 2.510 |
| | Schemazeichnung | 4.680 |
| | Diagramm | 4.658 |
| | Kartierung | 489 |
| | Nicht typisiert | 5.195 |
| Bild-Farbe | schwarzweiß | 11.756 |
| | farbig | 25.789 |
| | einfarbig | 1.737 |
| | Keine Farbuweisung | 4.890 |

Daneben befanden sich 2.156 vollständig erschlossene Bilder in internen Verzeichnissen „Landtechnik Weihenstephan TUM“. Auch ein erster Film aus Lehrveranstaltungen ist in einem internen Verzeichnis abgelegt.

Erstmals konnten für das Jahr 2014 exakte Zugriffs- und Downloaddaten mit Länderzuordnung aus den log-Files erstellt werden. Deren Analyse wird in den folgenden Abschnitten anhand der alphabetisch angeordneten Internetkodes der Länder dargestellt.

Diese Schrift ist verfügbar unter:

<http://mediatum.ub.tum.de/id=1243281>

| Inhalt | Seite |
|--|--------------|
| 1 Übersicht „Zugriffe auf und Downloads von Bildern nach Ländern“ | 4 |
| 2 Bilderbezogene Downloads mit Downloadzahlen nach Ländern (Gesamtdownloads 2014 ≥ 5) | 6 |
| 3 Länderspezifische Downloads | 32 |
| 3.1 A2 Satelliten Provider (Satellite Prvider) | 33 |
| 3.2 AT Österreich (Austria) | 34 |
| 3.3 BA Bosnien-Herzegowina (Bosnia and Herzegovina) | 52 |
| 3.4 BE Belgien (Belgium) | 53 |
| 3.5 BG Bulgarien (Bulgaria) | 54 |
| 3.6 BR Brasilien (Brazil) | 55 |
| 3.7 CA Kanada (Canada) | 56 |
| 3.8 CH Schweiz (Switzerland) | 58 |
| 3.9 CN China (China) | 64 |
| 3.10 CZ Tschechische Republik (Czech Republic) | 65 |
| 3.11 DE Deutschland (Germany) | 66 |
| 3.12 DK Dänemark (Denmark) | 239 |
| 3.13 EE Estland (Estonia) | 240 |
| 3.14 EG Ägypten (Egypt) | 241 |
| 3.15 ES Spanien (Spain) | 242 |
| 3.16 FI Finnland (Finland) | 243 |
| 3.17 FR Frankreich (France) | 244 |
| 3.18 GB Großbritannien UK (Great Britain (UK)) | 245 |
| 3.19 GR Griechenland (Greece) | 246 |
| 3.20 HR Kroatien (Hrvatska) (Croatia (Hrvatska)) | 247 |
| 3.21 HU Ungarn (Hungary) | 248 |
| 3.22 IE Irland (Ireland) | 249 |
| 3.23 IN Indien (India) | 250 |
| 3.24 IS Island (Iceland) | 251 |
| 3.25 IT Italien (Italy) | 253 |
| 3.26 JP Japan (Japan) | 254 |
| 3.27 KW Kuwait (Kuwait) | 255 |
| 3.28 LT Litauen (Lithuania) | 256 |
| 3.29 LU Luxemburg (Luxembourg) | 257 |
| 3.30 LV Lettland (Latvia) | 259 |
| 3.31 NL Niederlande (Netherlands)260 | 260 |
| 3.32 NO Norwegen (Norway) | 265 |
| 3.33 NZ Neuseeland (New Zealand (Aotearoa)) | 266 |
| 3.34 PL Polen (Poland) | 267 |
| 3.35 PT Portugal (Portugal) | 280 |
| 3.36 RO Rumänien (Romania) | 281 |
| 3.37 RU Russische Föderation (Russian Federation) | 282 |
| 3.38 SE Schweden (Sweden) | 283 |
| 3.39 SI Slowenien (Slovenia) | 284 |
| 3.40 SK Slowakische Republik (Slovak Republic) | 285 |
| 3.41 TM Turkmenistan (Turkmenistan) | 286 |
| 3.42 TR Türkei (Turkey) | 287 |
| 3.43 UA Ukraine (Ukraine) | 288 |
| 3.44 US Vereinigte Staaten von Amerika (United States) | 289 |
| 3.45 ZA Südafrika (South Africa) | 300 |







1 Übersicht „Zugriffe auf und Downloads von Bildern nach Ländern“





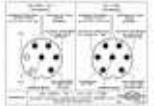
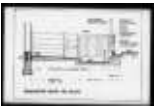
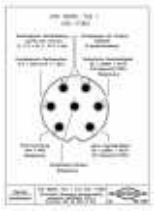



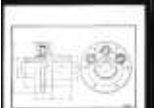

| Länderzuordnung | | | Zugriffe | | | Downloads | | |
|-----------------|---------------------|-----------------------|---------------------------|----------------|------------------|---------------------------|-----------------|-------------------|
| Lfn. Nr. | IT – Kennung & Name | | Zugriffs-Objekte (Bilder) | Summe Zugriffe | Zugriffe je Bild | Download-Objekte (Bilder) | Summe Downloads | Downloads je Bild |
| 1 | A2 | Satelliten Provider | 5 | 8 | 1,6 | 3 | 5 | 1,7 |
| 2 | AR | Argentinien | 1 | 1 | 1,0 | | | |
| 3 | AT | Österreich | 1.432 | 2.506 | 1,8 | 436 | 703 | 1,6 |
| 4 | AU | Australien | 2 | 2 | 1,0 | | | |
| 5 | BA | Bosnien-Herzegowina | 3 | 4 | 1,3 | 2 | 2 | 1,0 |
| 6 | BE | Belgien | 65 | 81 | 1,3 | 21 | 46 | 2,2 |
| 7 | BG | Bulgarien | 10 | 15 | 1,5 | 4 | 7 | 1,8 |
| 8 | BR | Brasilien | 1 | 1 | 1,0 | 1 | 2 | 2,0 |
| 9 | BY | Belorusland | 1 | 1 | 1,0 | | | |
| 10 | CA | Kanada | 96 | 124 | 1,3 | 31 | 35 | 1,1 |
| 11 | CH | Schweiz | 722 | 1.073 | 1,5 | 141 | 195 | 1,4 |
| 12 | CN | China | 327 | 426 | 1,3 | 3 | 5 | 1,7 |
| 13 | CO | Kolumbien | 2 | 2 | 1,0 | | | |
| 14 | CZ | Tschechische Republik | 35 | 43 | 1,2 | 15 | 20 | 1,3 |
| 15 | DE | Deutschland | 15.988 | 38.512 | 2,4 | 4.939 | 9.153 | 1,9 |
| 16 | DK | Dänemark | 23 | 30 | 1,0 | 11 | 17 | 1,5 |
| 17 | DZ | Algerien | 1 | 1 | 1,4 | | | |
| 18 | EE | Estland | 16 | 23 | 1,0 | 8 | 12 | 1,5 |
| 19 | EG | Ägypten | 2 | 2 | 1,0 | 1 | 1 | 1,0 |
| 20 | ES | Spanien | 9 | 9 | 1,3 | 5 | 5 | 1,0 |
| 21 | EU | Europäische Union | 6 | 8 | 1,1 | | | |
| 22 | FI | Finnland | 36 | 40 | 1,0 | 8 | 10 | 1,3 |
| 23 | FR | Frankreich | 54 | 132 | 2,4 | 15 | 21 | 1,4 |
| 24 | GB | Großbritannien UK | 47 | 72 | 1,5 | 20 | 24 | 1,2 |
| 25 | GR | Griechenland | 7 | 8 | 1,1 | 3 | 3 | 1,0 |
| 26 | HR | Kroatien | 17 | 28 | 1,7 | 6 | 10 | 1,7 |
| 27 | HU | Ungarn | 1.204 | 1.894 | 1,6 | 29 | 34 | 1,2 |
| 28 | IE | Irland | 2 | 3 | 1,5 | 2 | 2 | 1,0 |
| 29 | IL | Israel | 5 | 5 | 1,0 | | | |
| 30 | IN | Indien | 4 | 5 | 1,3 | 3 | 3 | 1,0 |
| 31 | IS | Island | 1 | 1 | 1,0 | 1 | 1 | 1,0 |
| 32 | IT | Italien | 102 | 134 | 1,3 | 41 | 59 | 1,4 |
| 33 | JP | Japan | 6 | 6 | 1,0 | 2 | 2 | 1,0 |
| 34 | KR | Südkorea | 279 | 404 | 1,5 | | | |
| 35 | KW | Kuwait | 2 | 2 | 1,0 | 1 | 1 | 1,0 |
| 36 | LT | Litauen | 4 | 4 | 1,0 | 2 | 2 | 1,0 |

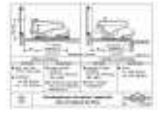
| | | | | | | | | |
|---|----|--------------------------|---------------|----------------|------------|--------------|---------------|------------|
| 37 | LU | Luxemburg | 138 | 168 | 1,2 | 43 | 52 | 1,2 |
| 38 | LV | Lettland | 9 | 10 | 1,1 | 4 | 4 | 1,0 |
| 39 | MD | Moldawien | 1 | 1 | 1,0 | | | |
| 40 | MK | Mazedonien | 1 | 2 | 2,0 | | | |
| 41 | NL | Niederlande | 1.216 | 1.561 | 1,3 | 132 | 176 | 1,3 |
| 42 | NO | Norwegen | 4 | 5 | 1,3 | 2 | 2 | 1,0 |
| 43 | NZ | Neuseeland | 3 | 4 | 1,3 | 2 | 2 | 1,0 |
| 44 | PL | Polen | 508 | 595 | 1,2 | 412 | 457 | 1,1 |
| 45 | PT | Portugal | 2 | 3 | 1,5 | 1 | 2 | 2,0 |
| 46 | RO | Rumänien | 25 | 33 | 1,3 | 7 | 8 | 1,1 |
| 47 | RS | Serbien | 5 | 5 | 1,0 | | | |
| 48 | RU | Russische Föderation | 16 | 21 | 1,3 | 7 | 11 | 1,6 |
| 49 | SE | Schweden | 10 | 13 | 1,3 | 5 | 6 | 1,2 |
| 50 | SI | Slowenien | 21 | 30 | 1,4 | 9 | 17 | 1,9 |
| 51 | SK | Slowakische Republik | 4 | 5 | 1,3 | 3 | 5 | 1,7 |
| 52 | TM | Turkmenistan | 11 | 16 | 1,5 | 3 | 7 | 2,3 |
| 53 | TR | Türkei | 9 | 22 | 2,4 | 6 | 7 | 1,2 |
| 54 | UA | Ukraine | 6 | 6 | 1,0 | 4 | 4 | 1,0 |
| 55 | US | Ver. Staaten von Amerika | 42.695 | 259.760 | 6,1 | 261 | 329 | 1,3 |
| 59 | UY | Uruguay | 2 | 3 | 1,5 | | | |
| 57 | VE | Venezuela | 1 | 1 | 1,0 | | | |
| 58 | ZA | Südafrika | 4 | 5 | 1,3 | 4 | 6 | 1,5 |
| Länder | | | 58 | | | 45 | | |
| Insgesamt | | | 43.388 | 307.879 | 7,1 | 5.833 | 11.475 | 2,0 |
| Deutschsprachige Länder (AT, CH, DE) | | | 16.671 | 42.091 | 2,5 | 5.246 | 10.051 | 1,9 |
| Nicht-Deutschsprachige Länder | | | 42.827 | 265.788 | 6,2 | 988 | 1.424 | 1,4 |



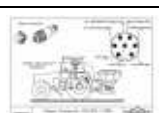

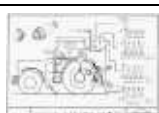
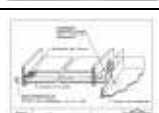

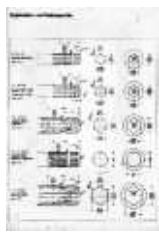

2 Bilderbezogene Downloads mit Downloadzahlen nach Ländern für Bilder mit Gesamtdownloads 2014 ≥ 5

In der folgenden Übersicht werden alle im Jahre 2014 heruntergeladenen Bilder mit mehr als 4 Downloads mit Autor, Jahr, Titel, Bilderkenndaten (Typ [Sprache], Farbe, ZNr (ID)) und mit Rang, Gesamtdownloads und Downloads in die Länder dargestellt. Bei den Zeichnungsnummern (ZNR) sind: LTW = Landtechnik Weihenstephan TUM, LTM = Landmaschinen Garching TUM, HUB = Humboldt Universität Berlin, JLU = Justus Liebig Universität Gießen.





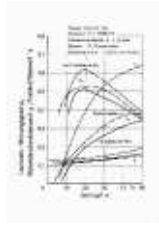
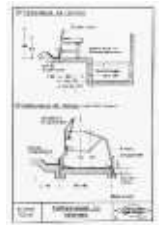







| Bild | Kenndaten | Rang mit Downloads |
|---|---|--|
|  | N.N., 1971: MTM-Normzeitwertkarte. Übersicht [de], schwarzweiß (id=708251) | Rang 1 mit 131 Downloads: AT=3; BR=2; DE=111; FR=2; GB=1; IE=1; RU=1; US=10; |
|  | N.N., ????: Systemtraktor mit Messkabine. Fotografie, farbig, ZNR=LTM-1.1.445 (id=717109) | Rang 2 mit 125 Downloads: AT=1; CA=2; CH=2; DE=111; DK=1; IN=1; LU=1; NL=1; NO=1; US=4; |
|  | Auernhammer, H., 1993: DIN 9684, Teil 1 und ISO 11786 (Draufsicht Steckdose schlepperseitig, entspricht AMPHEMOL C16-1, Schutzart DIN 40 050-IP 65). Schemazeichnung [de], schwarzweiß, ZNR=LTW-932287 (id=716664) | Rang 3 mit 121 Downloads: AT=4; BE=1; CH=3; CZ=1; DE=83; DK=4; EE=3; ES=1; FI=1; FR=3; GB=3; IT=1; JP=1; NL=4; NZ=1; PL=2; SE=1; US=1; ZA=3; |
|  | Boxberger, J., ????: Querschnitt durch die Bucht. Schemazeichnung [de], schwarzweiß (id=12277) | Rang 4 mit 95 Downloads: A2=2; AT=15; CA=2; DE=69; LU=2; LV=1; SI=2; US=2; |
|  | Demmel, M., Auernhammer, H., 1996: DIN 9684, Teil 1 und ISO 11786 (Draufsicht Steckdose schlepperseitig, entspricht AMPHENOL C16-1, Schutzart DIN40 050 - IP 65). Schemazeichnung [de], schwarzweiß, ZNR=LTW-962086 (id=731997) | Rang 5 mit 83 Downloads: AT=2; BE=1; CH=8; CZ=1; DE=35; DK=3; EE=3; FI=3; FR=1; GB=3; HU=3; IT=3; NL=7; NO=1; PL=4; RU=3; TR=1; US=1; |
|  | Boxberger, J., Widmann, B., 1996: Querschnitt durch einen Tretmiststall für Rinder. Schemazeichnung [de], schwarzweiß, ZNR=LTW-962138 (id=732043) | Rang 6 mit 71 Downloads: A2=2; AT=13; CA=1; DE=46; HR=3; LU=1; PL=1; SI=2; US=2; |
|  | Boxberger, J., Widmann, B., 1996: Rinder-Tretmiststall. Schemazeichnung [de], schwarzweiß, ZNR=LTW-962152 (id=732055) | Rang 7 mit 65 Downloads: AT=10; CA=1; DE=47; EE=1; HR=2; IT=1; SI=2; US=1; |
|  | N.N., ????: Ohne Titel. Fotografie, farbig (id=14044) | Rang 8 mit 60 Downloads: AT=17; CA=1; DE=39; LU=2; PL=1; |
|  | Thomé, F.-J., ????: Greifarten (nach Bullinger). Schemazeichnung [de], einfarbig, ZNR=LTW-380100 (id=729097) | Rang 9 mit 58 Downloads: AT=6; CH=1; DE=50; US=1; |
|  | N.N., ????: MAN - Hülsenfederkupplung. Fotografie, schwarzweiß, ZNR=HUB-4614 (id=638341) | Rang 10 mit 56 Downloads: AT=49; DE=7; |



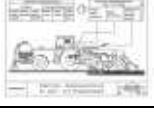









| | | |
|---|---|--|
|  | N.N., ????: Hydrauliksystem Elektronische Hubwerksregelung EHR FARMER 200 S. Fotografie [de], farbig, ZNr=LTM-1.2.264 (id=717444) | Rang 11 mit 51 Downloads: AT=3; BE=22; CA=1; DE=16; ES=1; US=8; |
|  | Perwanger, A., 1975: Ohne Titel. Fotografie, farbig (id=12665) | Rang 12 mit 43 Downloads: AT=1; CH=1; DE=38; GB=1; HU=2; |
|  | N.N., ????: Ohne Titel. Fotografie, farbig (id=703578) | Rang 13 mit 41 Downloads: AT=5; CA=1; DE=34; SI=1; |
|  | Schön, H., Haidn, B., 2000: Wandliegeboxen mit weicher Liegemulde oder mit Kotstufe für Kühe. Schemazeichnung [de], schwarzweiß, ZNr=LTW-002058 (id=733193) | Rang 14 mit 41 Downloads: AT=8; CH=5; DE=23; LU=1; SI=2; SK=2; |
|  | Auernhammer, H., Hemmen, Lueth, 1995: Laufstall für 60 Kühe mit Nachzucht. Schemazeichnung [de], schwarzweiß, ZNr=LTW-952239 (id=731745) | Rang 15 mit 37 Downloads: AT=2; CH=1; DE=28; JP=1; LU=3; NL=1; US=1; |
|  | N.N., ????: Ohne Titel. Fotografie, farbig (id=14404) | Rang 16 mit 37 Downloads: CH=1; DE=23; FR=3; US=10; |
|  | N.N., ????: Maße des 2 x 6 Fischgrätmelkstandes. Übersicht [de], schwarzweiß (id=704610) | Rang 17 mit 33 Downloads: AT=8; CA=1; CH=1; DE=21; GB=1; US=1; |
|  | N.N., ????: Wirkungsweise einer Stiftschaltung. Schemazeichnung [de], schwarzweiß (id=12981) | Rang 18 mit 32 Downloads: AT=3; CH=1; DE=23; HU=2; NL=1; SE=2; |
|  | Auernhammer, H., 1993: Signal Connector ISO/DIS 11786 (Step 1: Basic signals from tractor). Schemazeichnung [en], schwarzweiß, ZNr=LTW-932387 (id=710156) | Rang 19 mit 32 Downloads: AT=1; BE=1; CA=1; CZ=5; DE=18; DK=1; EE=1; NL=3; NZ=1; |
|  | Auernhammer, H., ????: SCHLÜTER Allradtraktor mit GASSNER Aufsattel-Volldrehpflug. Fotografie, farbig (id=730653) | Rang 20 mit 27 Downloads: CH=1; DE=24; PL=1; US=1; |
|  | Auernhammer, H., 1990: Signalsteckdose am Ackerschlepper nach DIN 9684. Schemazeichnung [de], schwarzweiß, ZNr=LTW-902308 (id=708542) | Rang 21 mit 27 Downloads: AT=1; CZ=2; DE=18; DK=1; FR=1; GB=1; NL=2; PL=1; |
|  | Boxberger, J., Widmann, B., 1996: Staumistverfahren, Staukanal. Schemazeichnung [de], schwarzweiß, ZNr=LTW-962012 (id=731940) | Rang 22 mit 26 Downloads: DE=20; IT=5; TM=1; |
|  | Auernhammer, H., 1997: Amerikanerwand. Fotografie, farbig (id=730456) | Rang 23 mit 25 Downloads: AT=3; DE=20; KW=1; US=1; |
|  | N.N., ????: Ohne Titel. Fotografie, farbig (id=15581) | Rang 24 mit 24 Downloads: AT=1; DE=21; NL=2; |











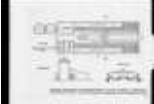

| | | |
|---|---|--|
|  | N.N., ????: Schlüter Eurotrac. Fotografie, farbig (id=13353) | Rang 25 mit 23 Downloads: DE=21; IT=1; US=1; |
|  | Schön, H., Bauer, R., 1993: Hydraulische Rohrentmistung mit Presskolbenschieber. Schemazeichnung [de], schwarzweiß, ZNr=LTW-932272 (id=731296) | Rang 26 mit 23 Downloads: A2=1; AT=11; DE=6; IT=1; LU=1; PL=2; RU=1; |
|  | N.N., ????: Ohne Titel. Fotografie, farbig (id=701340) | Rang 27 mit 21 Downloads: AT=7; DE=11; LU=2; US=1; |
|  | Schön, H., Widmann, B., 1996: Halmgutbergung Ballenautomat 'System KEMPER'. Schemazeichnung [de], schwarzweiß, ZNr=LTW-962321 (id=732182) | Rang 28 mit 21 Downloads: BE=1; BG=3; DE=12; HR=1; NL=1; PL=2; US=1; |
|  | N.N., ????: Ohne Titel. Fotografie, farbig (id=695190) | Rang 29 mit 20 Downloads: DE=20; |
|  | Haidn, B., Schürzinger, H., ????: Funktionsmaße im Tieflaufstall. Schemazeichnung [de], schwarzweiß (id=13987) | Rang 30 mit 20 Downloads: AT=6; DE=12; LU=1; US=1; |
|  | N.N., ????: Trigon-Melkstand. Fotografie, farbig, ZNr=LTM-18756 (id=721500) | Rang 31 mit 19 Downloads: AT=1; DE=17; US=1; |
|  | N.N., ????: Ohne Titel. Fotografie, farbig (id=14052) | Rang 32 mit 18 Downloads: AT=6; CA=1; DE=10; LU=1; |
|  | N.N., ????: Ohne Titel. Fotografie, farbig (id=695088) | Rang 33 mit 17 Downloads: DE=17; |
|  | N.N., ????: Ohne Titel. Fotografie, farbig (id=690286) | Rang 34 mit 17 Downloads: AT=1; DE=14; IT=2; |
|  | Estler, M., 1994: Grubber-Bauarten und Bauteile. Schemazeichnung [de], schwarzweiß (id=14639) | Rang 35 mit 16 Downloads: DE=16; |
|  | N.N., ????: Rau Kombi-System. Fotografie, schwarzweiß, ZNr=HUB-2721 (id=640899) | Rang 36 mit 16 Downloads: DE=15; US=1; |
|  | Schön, H., 2001: Aufbau von herkömmlichen Tangential-Dreschwerk und Axial-Dreschwerk. Schemazeichnung [de], schwarzweiß, ZNr=LTW-012184 (id=733519) | Rang 37 mit 15 Downloads: CH=1; DE=14; |
|  | N.N., ????: Scharformen. Schemazeichnung [de], schwarzweiß (id=724349) | Rang 38 mit 15 Downloads: AT=4; DE=11; |

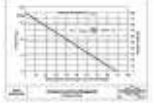





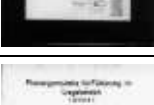

| | | |
|---|---|---|
|  | N.N., ????: Zapfwellen- und Nabenprofile. Übersicht [de], schwarzweiß (id=725877) | Rang 39 mit 15 Downloads: AT=5; DE=8; IT=2; |
|  | N.N., ????: Ryholmaufstallung. Fotografie, farbig (id=701490) | Rang 40 mit 15 Downloads: DE=13; US=2; |
|  | N.N., ????: Kartoffel-Vollernter, HASSIA, Typ KRB. Fotografie [de], farbig, ZNr=LTM-21223 (id=720540) | Rang 41 mit 15 Downloads: CZ=1; DE=7; GR=1; HR=1; PL=2; RO=2; US=1; |
|  | N.N., ????: Kartoffelroder Schatzgräber 224. Fotografie, schwarzweiß, ZNr=HUB-2351 (id=641727) | Rang 42 mit 14 Downloads: DE=14; |
|  | N.N., ????: Ohne Titel. Fotografie, farbig (id=14050) | Rang 43 mit 14 Downloads: AT=4; DE=10; |
|  | N.N., ????: Klettersäge zur mechanischen Entastung. Fotografie, farbig (id=724336) | Rang 44 mit 14 Downloads: AT=2; CH=2; DE=10; |
|  | Schön, H., Boxberger, J., 1971: Grundform 'Fressboxenstall'. Schemazeichnung [de], schwarzweiß, ZNr=LTW-0/155 (id=14423) | Rang 45 mit 14 Downloads: AT=1; DE=11; IT=2; |
|  | N.N., ????: Laufwerk Wirkungsgrad, Rollwiderstandsbeiwert, Triebkraftbeiwert. Diagramm [de], schwarzweiß (id=711677) | Rang 46 mit 13 Downloads: DE=13; |
|  | Boxberger, J., Kirchner, M., 1984: Freßliegeboxen für Milchvieh. Schemazeichnung [de], schwarzweiß, ZNr=LTW-842151 (id=14420) | Rang 47 mit 13 Downloads: AT=1; DE=12; |
|  | N.N., ????: Ohne Titel. Fotografie, farbig (id=690278) | Rang 48 mit 13 Downloads: AT=1; DE=12; |
|  | N.N., ????: Ertragsabfälle in den feuchten Tropen bei zunehmender Dauer der Ackerntzung im System der Waldbrandwirtschaft (nach Nye et al. 27) . Diagramm [de], einfarbig (id=702243) | Rang 49 mit 13 Downloads: CH=1; DE=12; |

| | | |
|---|---|---|
|  | Demmel, M., Auernhammer, H., 1998: Umschlingungsgetriebe mit Kettenwandler Bauart Hurth/P.I.V. Reimers für Schlüter Eurotrac. Schemazeichnung [de], schwarzweiß, ZNr=LTW-982307 (id=732888) | Rang 50 mit 13 Downloads: BE=1; DE=12; |
|  | N.N., ????: Ohne Titel. Fotografie, farbig (id=711737) | Rang 51 mit 13 Downloads: DE=11; NL=1; US=1; |
|  | Zeisig, H.-D., 1980: Ohne Titel. Fotografie, farbig (id=692058) | Rang 52 mit 12 Downloads: DE=12; |
|  | N.N., ????: Kippbare Kabine. Fotografie, farbig (id=711771) | Rang 53 mit 12 Downloads: DE=12; |
|  | N.N., ????: Pflugsaa. Fotografie, farbig, ZNr=LTM-46817 (id=719618) | Rang 54 mit 12 Downloads: DE=12; |
|  | Langenegger, G., 1996: Staukanal-Rinnenentmistung. Schemazeichnung [de], schwarzweiß, ZNr=LTW-962014 (id=731942) | Rang 55 mit 12 Downloads: DE=10; IT=2; |
|  | Renius, T., Sauer, H., 1994: Getriebe mit Vierfach-Lastschaltung, Bauart Fendt-ZF, für Favorit 500 C (70 bis 103kW, 1993). Schemazeichnung [de], einfarbig, ZNr=LTM-1.3.323, 6268 (id=718032) | Rang 56 mit 12 Downloads: AT=2; DE=7; SI=3; |
|  | N.N., ????: Dächertrockner als Umlaufrockner. Fotografie, farbig (id=712027) | Rang 57 mit 12 Downloads: AT=1; DE=5; US=6; |
|  | N.N., ????: Ohne Titel. Fotografie, farbig, ZNr=LTM-7.6.143 (id=721254) | Rang 58 mit 12 Downloads: DE=2; NL=7; US=3; |
|  | N.N., ????: Taumelegge. Fotografie, farbig (id=713255) | Rang 59 mit 11 Downloads: DE=11; |
|  | N.N., ????: Schlepper-Heuwender zum Zetten, Heuwenden und Schwadenziehen. Fotografie [de], schwarzweiß, ZNr=LTM-12850 (id=720631) | Rang 60 mit 11 Downloads: DE=11; |
|  | N.N., ????: Kraftmeßbolzen. Fotografie [de], farbig, ZNr=LTM-1.2.245 (id=717426) | Rang 61 mit 11 Downloads: AT=1; DE=10; |
|  | N.N., ????: Ohne Titel. Fotografie, farbig (id=695447) | Rang 62 mit 11 Downloads: AT=2; DE=9; |
|  | N.N., ????: Ohne Titel. Fotografie, farbig, ZNr=LTM-5.2.204 (id=719575) | Rang 63 mit 11 Downloads: DE=10; GB=1; |













| | | |
|---|--|---|
|  | N.N., 1955: Ruhrstahl-Landmaschine mit Gebläselader im Zwischenachsenanbau mit Frontschwader und pickup. Fotografie, schwarzweiß, ZNr=HUB-2812 (id=639234) | Rang 64 mit 11 Downloads: AT=1; DE=9; US=1; |
|  | N.N., ????: Ohne Titel. Fotografie, farbig (id=701548) | Rang 65 mit 11 Downloads: AT=3; DE=7; LU=1; |
|  | Auernhammer, H., 1990: Signalsteckdose am Ackerschlepper nach DIN 9684. Schemazeichnung [de], schwarzweiß, ZNr=LTW-903308 (id=709457) | Rang 66 mit 11 Downloads: AT=1; BE=1; DE=8; NL=1; |
|  | N.N., ????: Ohne Titel. Fotografie, farbig (id=13986) | Rang 67 mit 11 Downloads: AT=5; CA=1; DE=4; LU=1; |
|  | Schön, H., Haidn, B., 1998: Einrichtungen und Masse eines Kurzstandes für Milchvieh. Schemazeichnung [de], schwarzweiß, ZNr=LTW-982365 (id=732937) | Rang 68 mit 11 Downloads: AT=3; DE=5; IT=1; RO=1; US=1; |
|  | N.N., ????: Boxenlaufstall mit Spaltenbodenauflfläche, Unterflurentmistung und mechanischer Fütterung. Fotografie [de], schwarzweiß (id=704103) | Rang 69 mit 11 Downloads: DE=8; FI=1; IS=1; US=1; |
|  | Auernhammer, H., Worstorff, H., 1987: The five phases of a lactation curve (by Huth, 1981). Diagramm [en], schwarzweiß, ZNr=LTW-872290 (id=15877) | Rang 70 mit 11 Downloads: AT=2; DE=6; RO=1; SI=2; |
|  | Auernhammer, H., 1991: Elektronik-Spezialausstattung für Saat- und Pflegeschlepper. Schemazeichnung [de], schwarzweiß, ZNr=LTW-912119 (id=708543) | Rang 71 mit 11 Downloads: CH=1; CZ=1; DE=5; DK=1; NL=1; PL=1; RU=1; |
|  | N.N., ????: Einzelkornsamt von Mais unter Folie. Fotografie, farbig (id=698047) | Rang 72 mit 10 Downloads: DE=10; |
|  | N.N., ????: Ohne Titel. Fotografie [de], farbig (id=701273) | Rang 73 mit 10 Downloads: DE=10; |
|  | N.N., ????: Ohne Titel. Fotografie, farbig, ZNr=LTM-1.1.111 (id=716810) | Rang 74 mit 10 Downloads: DE=10; |
|  | Boxberger, J., Widmann, B., 1995: Fressliegebucht. Schemazeichnung [de], schwarzweiß, ZNr=LTW-952331 (id=731820) | Rang 75 mit 10 Downloads: AT=1; DE=9; |
|  | Boxberger, J., Widmann, B., 1995: Schweinemast-Offenfrontstall mit Tiefstreu. Schemazeichnung [de], schwarzweiß, ZNr=LTW-952284 (id=731778) | Rang 76 mit 10 Downloads: AT=6; DE=4; |











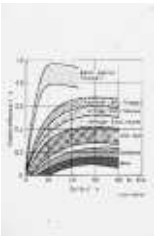

| | | |
|---|--|--|
|  | Auernhammer, H., 1995: Funktionsprüfung EHR. Übersicht [de], schwarzweiß, ZNr=LTW-952AN046 (id=708767) | Rang 77 mit 10 Downloads: DE=9; DK=1; |
|  | N.N., ????: Triebwerksschema des Overdrive-Vollsynchrongetriebes. Fotografie [de], farbig, ZNr=LTM-22706 (id=717794) | Rang 78 mit 10 Downloads: DE=9; UA=1; |
|  | Eichhorn, H., ????: Boxenlaufstall mit getrenntem Liege- und Freßplatz in einem Gebäude (rat. Selbstfütterung in Flachsilos, Fischgräten - Melkstand, Spaltenboden - Lauffläche und Flüssigmistanlage). Schemazeichnung [de], schwarzweiß (id=1198409) | Rang 79 mit 10 Downloads: DE=9; US=1; |
|  | N.N., ????: Durchtreibemelkstand. Fotografie, farbig (id=705308) | Rang 80 mit 10 Downloads: AT=1; DE=8; US=1; |
|  | Schön, H., Rittel, L., ????: Vierreihiger Liegeboxenlaufstall für 77 Kühe o. J. und AMS. Schemazeichnung [de], schwarzweiß (id=13992) | Rang 81 mit 10 Downloads: DE=8; US=2; |
|  | Auernhammer, H., ????: Müller-Elektronik, MFC 5005 mit BEE Card. Fotografie, farbig (id=15050) | Rang 82 mit 10 Downloads: DE=8; PL=2; |
|  | Wenner, H.-L., 1980: Liegeboxenstall - dreireihig mit Nachzucht. Schemazeichnung [de], schwarzweiß, ZNr=LTW-802173 (id=14060) | Rang 83 mit 10 Downloads: AT=2; DE=6; US=2; |
|  | Bauer, R., 1993: Querschnitt eines Fischgrätenmelkstandes. Schemazeichnung [de], schwarzweiß, ZNr=LTW-932269 (id=731293) | Rang 84 mit 10 Downloads: AT=8; GB=1; US=1; |
|  | Boxberger, J., Langenegger, G., 1984: Fließmistverfahren. Schemazeichnung [de], schwarzweiß, ZNr=LTW-842067 (id=13076) | Rang 85 mit 10 Downloads: DE=7; TM=3; |
|  | N.N., ????: Selbstfahrender Ladewagen Rapid Cargotrac 20, schwarz gedruckte Masse: Rapid Cargotrac 30). Schemazeichnung [de], schwarzweiß, ZNr=LTM-46514 (id=720972) | Rang 86 mit 10 Downloads: BG=2; CH=7; US=1; |
|  | N.N., ????: Ladewagen-Selbstfahrer. Fotografie, farbig, ZNr=LTM-16199 (id=720987) | Rang 87 mit 10 Downloads: CH=1; DE=4; US=5; |
|  | N.N., ????: Ohne Titel. Fotografie, farbig (id=694659) | Rang 88 mit 9 Downloads: DE=9; |

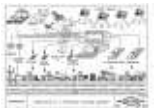



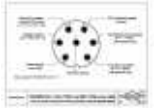







| | | |
|---|---|---|
|  | N.N., ????: Ohne Titel. Fotografie, farbig (id=695061) | Rang 89 mit 9 Downloads: DE=9; |
|  | N.N., ????: Ohne Titel. Fotografie, farbig (id=696114) | Rang 90 mit 9 Downloads: DE=9; |
|  | Eichhorn, H., ????: Zweireihiger Boxenlaufstall mit Spaltenbodenlauffläche und versetzbarem Melkstand (2 * 2 Reihenstand) auf befahrbarem Futtertisch. Unterflurentmistung über Schleppschaufel oder Flüssigmistbereitung. Schemazeichnung [de], schwarzweiß (id=1198405) | Rang 91 mit 9 Downloads: DE=9; |
|  | N.N., ????: Ohne Titel. Fotografie, farbig (id=14884) | Rang 92 mit 9 Downloads: AT=1; DE=8; |
|  | Strehler, A., Auernhammer, H., 2007: Heizwert und Feuchtegehalt (Hackschnitzel). Diagramm [de], schwarzweiß, ZNr=LTW-072014 (id=734391) | Rang 93 mit 9 Downloads: AT=1; DE=8; |
|  | Schulz, H., 1970: Ohne Titel. Fotografie, farbig (id=12207) | Rang 94 mit 9 Downloads: AT=2; DE=7; |
|  | N.N., ????: Ohne Titel. Fotografie, farbig (id=712388) | Rang 95 mit 9 Downloads: AT=2; DE=7; |
|  | N.N., ????: Ohne Titel. Fotografie, farbig (id=14051) | Rang 96 mit 9 Downloads: AT=4; DE=5; |
|  | Estler, M., 1995: Arbeitsweise von Beet- und Kehrflug. Schemazeichnung [de], schwarzweiß, ZNr=LTW-952069 (id=712631) | Rang 97 mit 9 Downloads: AT=4; DE=5; |
|  | N.N., ????: Systeme von Heutrocknungsanlagen. Fotografie, schwarzweiß, ZNr=HUB-3401 (id=643007) | Rang 98 mit 9 Downloads: CH=9; |
|  | N.N., ????: Planungsmodelle für Fütterung im Liegebereich (40 Kühe). Schemazeichnung [de], schwarzweiß (id=721900) | Rang 99 mit 9 Downloads: AT=1; DE=7; IT=1; |
|  | Wenner, H.-L., 1990: Ohne Titel. Fotografie, farbig (id=690055) | Rang 100 mit 9 Downloads: DE=7; PL=2; |

| | | |
|---|--|--|
|  | N.N., ????: Fendt-Tronic. Fotografie [de], farbig, ZNr=LTM-1.2.268 (id=717446) | Rang 101 mit 9 Downloads: DE=7; FR=1; PL=1; |
|  | Boxberger, J., Langenegger, G., 1996: Rohrentmistung. Schemazeichnung [de], schwarzweiß, ZNr=LTW-962011 (id=731939) | Rang 102 mit 9 Downloads: CA=1; DE=6; LU=2; |
|  | Auernhammer, H., Neumair, B., 1995: Verfügbarkeit der Signalsteckdose nach DIN 9684, Teil 1 oder ISO 11786 bei in Deutschland angebotenen Traktoren. Übersicht [de], schwarzweiß, ZNr=LTW-952AM017 (id=709464) | Rang 103 mit 9 Downloads: BE=1; CZ=1; DE=5; DK=1; EE=1; |
|  | Wenner, H.-L., 1990: Ohne Titel. Fotografie, farbig (id=12090) | Rang 104 mit 9 Downloads: AT=1; CH=1; DE=3; PL=2; SI=2; |
|  | Brenner, W., 1965: Schnittbild eines Reimers- Kettenwandlers. Schemazeichnung, farbig (id=12862) | Rang 105 mit 8 Downloads: DE=8; |
|  | N.N., ????: Strohlose Freißboxe und Freißboxe mit Tiefstreu. Schemazeichnung [de], schwarzweiß (id=14439) | Rang 106 mit 8 Downloads: DE=8; |
|  | N.N., ????: Ideales Verbrauchs- und Leistungskennfeld. Fotografie, schwarzweiß, ZNr=HUB-2846 (id=642353) | Rang 107 mit 8 Downloads: DE=8; |
|  | Brenner, W., Wenner, H.-L., ????: Ohne Titel. Fotografie, farbig (id=689659) | Rang 108 mit 8 Downloads: DE=8; |
|  | N.N., ????: Ohne Titel. Fotografie, farbig (id=694789) | Rang 109 mit 8 Downloads: DE=8; |
|  | N.N., ????: Ohne Titel. Fotografie, farbig (id=694964) | Rang 110 mit 8 Downloads: DE=8; |
|  | N.N., ????: Ohne Titel. Fotografie, farbig (id=695067) | Rang 111 mit 8 Downloads: DE=8; |
|  | N.N., ????: Ohne Titel. Fotografie, farbig (id=695352) | Rang 112 mit 8 Downloads: DE=8; |
|  | N.N., ????: Ohne Titel. Fotografie, farbig (id=695385) | Rang 113 mit 8 Downloads: DE=8; |
|  | N.N., ????: Ohne Titel. Fotografie, farbig (id=695457) | Rang 114 mit 8 Downloads: DE=8; |











| | | |
|---|---|--|
|  | N.N., ????: Erzeuger- und Betriebsmittelpreise (Preisindizes, 1980=100, Preise ohne Mehrwertsteuer). Diagramm [de], schwarzweiß (id=702331) | Rang 115 mit 8 Downloads: DE=8; |
|  | N.N., ????: Ohne Titel. Fotografie, farbig (id=703712) | Rang 116 mit 8 Downloads: DE=8; |
|  | N.N., ????: Ohne Titel. Fotografie, farbig (id=705325) | Rang 117 mit 8 Downloads: DE=8; |
|  | N.N., ????: Massey Ferguson Allradtraktor mit Anbaubeetpflug. Fotografie, farbig (id=730657) | Rang 118 mit 8 Downloads: DE=8; |
|  | N.N., ????: Ohne Titel. Fotografie, farbig (id=14718) | Rang 119 mit 8 Downloads: AT=1; DE=7; |
|  | N.N., ????: Ohne Titel. Fotografie, farbig, ZNr=LTM-35496 (id=720690) | Rang 120 mit 8 Downloads: CH=4; DE=4; |
|  | Boxberger, J., Widmann, B., 1995: Eingestreute Aufstallungen für Schweine Tiefstreubucht mit planbefestigtem Fressplatz und Vorratsfütterung. Schemazeichnung [de], schwarzweiß, ZNr=LTW-952318 (id=731808) | Rang 121 mit 8 Downloads: AT=4; DE=4; |
|  | Eichhorn, H., 1968: Schema einer Kuhstall-Schwemmentmistung. Schemazeichnung [de], schwarzweiß (id=12332) | Rang 122 mit 8 Downloads: AT=1; CH=1; DE=5; IT=1; |
|  | Brenner, W., Wenner, H.-L., ????: Transportwagen, Mengele, Anwelkguternte. Fotografie, farbig (id=12076) | Rang 123 mit 8 Downloads: DE=7; US=1; |
|  | Brenner, W., Wenner, H.-L., ????: Ohne Titel. Fotografie, farbig (id=689670) | Rang 124 mit 8 Downloads: DE=7; NL=1; |
|  | N.N., ????: Ohne Titel. Fotografie, farbig, ZNr=LTM-47276 (id=721153) | Rang 125 mit 8 Downloads: DE=7; US=1; |
|  | Schön, H., Hartmann, H., Widmann, B., 1996: Pelletierung von Halmgut Prinzip Kollergangpresse mit Ringmatrize. Schemazeichnung [de], schwarzweiß, ZNr=LTW-962312 (id=732174) | Rang 126 mit 8 Downloads: BA=1; DE=7; |
|  | Demmel, M., Auernhammer, H., 1996: Triebkraftbeiwerte in Abhängigkeit vom Schlupf bei Gummiraupen- und Radschleppern (gepflügter-lockerer Boden, BASHFORD 1988). Diagramm [de], schwarzweiß, ZNr=LTW-962445 (id=732255) | Rang 127 mit 8 Downloads: DE=7; US=1; |

| | | |
|---|--|--|
|  | Rittel, L., Schön, H., 1997: Eingestreute Laufställe für Rinder. Schemazeichnung [de], schwarzweiß (id=14063) | Rang 128 mit 8 Downloads: AT=1; DE=6; US=1; |
|  | N.N., ????: Ohne Titel. Fotografie, farbig (id=705169) | Rang 129 mit 8 Downloads: AT=3; DE=4; LU=1; |
|  | N.N., ????: Gleichdruckeinrichtung, Rau-Quantometer, Zentraler Druckfilter mit Selbstreinigung. Fotografie [de], farbig (id=705913) | Rang 130 mit 8 Downloads: AT=1; DE=5; IT=1; SE=1; |
|  | Schön, H., Bauer, R., 1993: Hydraulische Rohrentmischung mit Presskanalschieber. Schemazeichnung [de], schwarzweiß, ZNr=LTW-932277 (id=731299) | Rang 131 mit 8 Downloads: AT=2; DE=3; LU=2; PL=1; |
|  | N.N., ????: Alltronik. Fotografie, farbig (id=707893) | Rang 132 mit 8 Downloads: DE=3; PL=5; |
|  | N.N., ????: Ohne Titel. Fotografie, farbig, ZNr=LTM-1.4.187 (id=718258) | Rang 133 mit 8 Downloads: PL=8; |
|  | Brenner, W., Wenner, H.-L., 1964: Anbaufeldhäcksler, Eigenbau, Landtechnik, Seiteneinzug. Fotografie, farbig (id=12044) | Rang 134 mit 7 Downloads: DE=7; |
|  | N.N., ????: Anbaumähdrescher Mörthl. Fotografie, farbig (id=13368) | Rang 135 mit 7 Downloads: DE=7; |
|  | N.N., ????: Abkühlungs- und Erhitzungskurve von reinem Eisen. Fotografie, schwarzweiß, ZNr=HUB-3235 (id=640888) | Rang 136 mit 7 Downloads: DE=7; |
|  | N.N., ????: Wandständige Futtervorlage mit Schubstangenförderer. Fotografie, farbig (id=690184) | Rang 137 mit 7 Downloads: DE=7; |
|  | N.N., ????: Ohne Titel. Fotografie, farbig (id=690460) | Rang 138 mit 7 Downloads: DE=7; |
|  | N.N., ????: Ohne Titel. Fotografie, schwarzweiß (id=695483) | Rang 139 mit 7 Downloads: DE=7; |

| | | |
|---|---|--|
|  | N.N., ????: Ohne Titel. Fotografie, farbig (id=695853) | Rang 140 mit 7 Downloads: DE=7; |
|  | N.N., ????: MB Trac mit angebauten Zuckerrübenköpfrdebunker und Frontköpfer mit Blattüberladeeinrichtung. Fotografie, farbig (id=696829) | Rang 141 mit 7 Downloads: DE=7; |
|  | N.N., ????: Triebkraftbeiwert und Schlupf (nach Söhne). Diagramm [de], schwarzweiß (id=702764) | Rang 142 mit 7 Downloads: DE=7; |
|  | N.N., ????: Ohne Titel. Fotografie, farbig (id=706028) | Rang 143 mit 7 Downloads: DE=7; |
|  | Auernhammer, H., 1997: Electronics in a 'Precision Farming System'. Schemazeichnung [de], schwarzweiß, ZNr=LTW-972155 (id=710413) | Rang 144 mit 7 Downloads: DE=7; |
|  | N.N., ????: Ohne Titel. Fotografie, farbig (id=711318) | Rang 145 mit 7 Downloads: DE=7; |
|  | N.N., ????: Mais-Kolbenpflücker. Fotografie, farbig (id=711461) | Rang 146 mit 7 Downloads: DE=7; |
|  | N.N., ????: Ohne Titel. Fotografie, farbig, ZNr=LTM-27798 (id=721362) | Rang 147 mit 7 Downloads: DE=7; |
|  | Auernhammer, H., Demmel, M., 2002: Informationstechnologie in der Landnutzung. Übersicht [de, en], schwarzweiß, ZNr=LTW-022073 (id=733650) | Rang 148 mit 7 Downloads: DE=7; |
|  | Auernhammer, H., 2004: DIN 9684/Teil 1 (Feb. 1997) and ISO 11786 (June 1994),View of tractor connector socket protection class IP 65 (IEC 60529). Schemazeichnung [en], schwarzweiß, ZNr=LTW-042085 (id=734272) | Rang 149 mit 7 Downloads: DE=7; |
|  | N.N., ????: Ohne Titel. Fotografie, farbig (id=702085) | Rang 150 mit 7 Downloads: AT=1; CH=1; DE=5; |
|  | N.N., ????: Ohne Titel. Fotografie, farbig (id=703820) | Rang 151 mit 7 Downloads: AT=4; DE=3; |
|  | N.N., ????: Ohne Titel. Fotografie, farbig (id=711306) | Rang 152 mit 7 Downloads: DE=6; NL=1; |



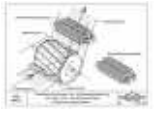







| | | |
|---|--|--|
|  | N.N., ????: Ohne Titel. Fotografie, farbig (id=715185) | Rang 153 mit 7 Downloads: DE=6; NL=1; |
|  | N.N., ????: MTM-Standard-Daten Basiswerte. Diagramm [de], schwarzweiß (id=715862) | Rang 154 mit 7 Downloads: AT=1; DE=5; FR=1; |
|  | N.N., ????: Selbstfahrender Feldhäcksler REX (Ködel & Böhm). Fotografie, schwarzweiß, ZNr=HUB-5360 (id=638752) | Rang 155 mit 7 Downloads: DE=5; NL=1; US=1; |
|  | N.N., ????: Ackerbürste, in Transportstellung. Fotografie, schwarzweiß, ZNr=HUB-2012 (id=643316) | Rang 156 mit 7 Downloads: DE=5; US=2; |
|  | N.N., ????: Hydrauliksystem für Farmer. Fotografie [de], farbig, ZNr=LTM-1.2.263 (id=717443) | Rang 157 mit 7 Downloads: BE=2; DE=5; |
|  | N.N., ????: Wechseelpflug mit Handaushebung. Fotografie, schwarzweiß, ZNr=LTM-37261 (id=719070) | Rang 158 mit 7 Downloads: CA=1; DE=5; HU=1; |
|  | N.N., ????: Liegeboxenlaufstall mit komb. Funktionsbereichen (Milchvieh mit Nachzucht) 40 Kühe. Schemazeichnung [de], schwarzweiß (id=14452) | Rang 159 mit 7 Downloads: AT=1; DE=4; US=2; |
|  | N.N., ????: Ohne Titel. Fotografie, farbig (id=711308) | Rang 160 mit 7 Downloads: DE=4; NL=3; |
|  | N.N., ????: In den zwanziger Jahren gab es Tausende solcher Motortrappflüge in Deutschland. Fotografie [de], schwarzweiß (id=715504) | Rang 161 mit 7 Downloads: DE=4; NL=3; |
|  | N.N., ????: Pendelausgleich, Hangausgleich. Fotografie [de], farbig (id=699990) | Rang 162 mit 7 Downloads: AT=1; DE=3; LU=3; |
|  | N.N., ????: Ohne Titel. Fotografie, farbig, ZNr=LTM-18665 (id=720020) | Rang 163 mit 7 Downloads: DE=1; PL=6; |
|  | Estler, M., 1970: Gezogener Mähdrescher Claas Garant. Fotografie, farbig (id=12435) | Rang 164 mit 6 Downloads: DE=6; |
|  | Auernhammer, H., ????: Mercedes Benz, Unicomp 1. Fotografie, farbig (id=15572) | Rang 165 mit 6 Downloads: DE=6; |
|  | N.N., ????: Trommeldarre. Fotografie, schwarzweiß, ZNr=HUB-2625 (id=640794) | Rang 166 mit 6 Downloads: DE=6; |



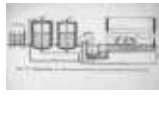







| | | |
|---|---|------------------------------------|
|  | N.N., ????: Hackmaschine. Fotografie, schwarzweiß, ZNr=HUB-169 (id=642385) | Rang 167 mit 6 Downloads: DE=6; |
|  | Brenner, W., Wenner, H.-L., ????: Ohne Titel. Fotografie, farbig (id=689731) | Rang 168 mit 6 Downloads: DE=6; |
|  | N.N., ????: Ohne Titel. Fotografie, farbig (id=690187) | Rang 169 mit 6 Downloads: DE=6; |
|  | N.N., ????: Ohne Titel. Fotografie, farbig (id=690191) | Rang 170 mit 6 Downloads: DE=6; |
|  | N.N., ????: Abschiebevorrichtung in Frontladergabel. Fotografie, farbig (id=694868) | Rang 171 mit 6 Downloads: DE=6; |
|  | N.N., ????: Ohne Titel. Fotografie, farbig (id=695165) | Rang 172 mit 6 Downloads: DE=6; |
|  | N.N., ????: Ohne Titel. Fotografie, farbig (id=695178) | Rang 173 mit 6 Downloads: DE=6; |
|  | N.N., ????: Ohne Titel. Fotografie, farbig (id=695188) | Rang 174 mit 6 Downloads: DE=6; |
|  | N.N., ????: Ohne Titel. Fotografie, farbig (id=696482) | Rang 175 mit 6 Downloads: DE=6; |
|  | Auernhammer, H., 1998: Ohne Titel. Fotografie, farbig (id=696496) | Rang 176 mit 6 Downloads: DE=6; |
|  | Demmel, M., ????: Ohne Titel. Fotografie, farbig (id=698466) | Rang 177 mit 6 Downloads: DE=6; |
|  | N.N., ????: Ohne Titel. Fotografie, farbig (id=700553) | Rang 178 mit 6 Downloads: DE=6; |
|  | N.N., ????: Ohne Titel. Fotografie, farbig (id=700559) | Rang 179 mit 6 Downloads: DE=6; |

| | | |
|---|---|--|
|  | N.N., ????: Ohne Titel. Fotografie, farbig (id=706434) | Rang 180 mit 6 Downloads: DE=6; |
|  | N.N., ????: Göpel zum Antrieb einer Kreissäge. Fotografie, schwarzweiß (id=715509) | Rang 181 mit 6 Downloads: DE=6; |
|  | N.N., ????: Ohne Titel. Fotografie, farbig (id=715952) | Rang 182 mit 6 Downloads: DE=6; |
|  | N.N., ????: Ohne Titel. Fotografie, farbig, ZNr=LTM-46753 (id=716743) | Rang 183 mit 6 Downloads: DE=6; |
|  | Renius, T., ????: Deutz Power train 68/72 HP Type TW 55.4 . Schemazeichnung [en], einfarbig, ZNr=LTM-1.3.159, 4888 (id=717880) | Rang 184 mit 6 Downloads: DE=6; |
|  | Rempfer, M., Schwanghart, H., 1995: Triebkraft eines Lufttreifens auf nachgiebiger Fahrbahn. Diagramm [de], einfarbig, ZNr=LTM-4.2.227, 6271 (id=718845) | Rang 185 mit 6 Downloads: DE=6; |
|  | N.N., ????: Ohne Titel. Fotografie, farbig, ZNr=LTM-43989 (id=721144) | Rang 186 mit 6 Downloads: DE=6; |
|  | N.N., ????: Ohne Titel. Fotografie, farbig (id=722450) | Rang 187 mit 6 Downloads: DE=6; |
|  | N.N., ????: Ohne Titel. Fotografie, farbig (id=723421) | Rang 188 mit 6 Downloads: DE=6; |
|  | Gronauer, A., Boxberger, J., 1996: Flüssigmist-Separatoren Siebtrommelpresse. Schemazeichnung [de], schwarzweiß, ZNr=LTW-962029 (id=731953) | Rang 189 mit 6 Downloads: DE=6; |
|  | Schön, H., Widmann, B., 1997: Zusatzeinrichtungen zur Körnerzerkleinerung bei Mais und Ganzpflanzensilage -Zerkleinerungsscheiben-. Schemazeichnung [de], schwarzweiß, ZNr=LTW-972032 (id=732291) | Rang 190 mit 6 Downloads: DE=6; |
|  | Schön, H., Demmel, M., 2001: Mähdrescher-Trennsysteme, Teil I. Übersicht [de], schwarzweiß, ZNr=LTW-012192 (id=733526) | Rang 191 mit 6 Downloads: DE=6; |
|  | Schön, H., 1976: Rindermast 'Flachlaufstall' für 100 Bullen. Schemazeichnung [de], schwarzweiß, ZNr=LTW-762150 (id=12281) | Rang 192 mit 6 Downloads: AT=1; DE=5; |

| | | |
|---|--|--|
|  | Rittel, L., 1993: Milchviehlaufstall mit Liegeboxen für 41 Kühe (Kaltstall). Schemazeichnung [de], schwarzweiß, ZNr=LTW-930115 (id=701627) | Rang 193 mit 6 Downloads: AT=1; DE=5; |
|  | N.N., ????: Ohne Titel. Fotografie, farbig (id=703731) | Rang 194 mit 6 Downloads: AT=1; DE=5; |
|  | Schön, H., Boxberger, J., ????: Funktionsskizze eines Tretmiststalles (Schön und Boxberger). Schemazeichnung [de], schwarzweiß (id=704111) | Rang 195 mit 6 Downloads: AT=1; DE=5; |
|  | N.N., ????: 1Mann-Häckseldrusch . System Speiser. Fotografie [de], farbig (id=722484) | Rang 196 mit 6 Downloads: AT=1; DE=5; |
|  | Kormann, G., Peterreins, M., Auernhammer, H., 1999: Vergleich zwischen Reihensaat und Gleichstandsamt. Schemazeichnung [de], schwarzweiß, ZNr=LTW-992123 (id=733051) | Rang 197 mit 6 Downloads: AT=1; DE=5; |
|  | N.N., ????: Ohne Titel. Fotografie, farbig, ZNr=LTM-7.3.202 (id=720782) | Rang 198 mit 6 Downloads: CH=2; DE=4; |
|  | N.N., ????: Alldog mit Frontanbau-Kastendüngerstreuer und Zwischenachs-Federzinkengrubber. Fotografie, farbig (id=722921) | Rang 199 mit 6 Downloads: AT=2; DE=4; |
|  | Schön, H., Bauer, R., 1993: Kreiselrechwender. Schemazeichnung [de], schwarzweiß, ZNr=LTW-932062 (id=731173) | Rang 200 mit 6 Downloads: AT=1; CH=1; DE=4; |
|  | N.N., ????: Ohne Titel. Fotografie, farbig (id=701480) | Rang 201 mit 6 Downloads: AT=3; DE=3; |
|  | N.N., ????: Ohne Titel. Fotografie, farbig (id=701166) | Rang 202 mit 6 Downloads: AT=1; CH=3; DE=1; IT=1; |
|  | Estler, M., 1970: Ohne Titel. Fotografie, farbig (id=12395) | Rang 203 mit 6 Downloads: CA=1; DE=5; |
|  | N.N., ????: Rau, Quantotronik XS. Fotografie, farbig (id=14347) | Rang 204 mit 6 Downloads: DE=5; LT=1; |
|  | N.N., ????: Ohne Titel. Fotografie, farbig (id=14381) | Rang 205 mit 6 Downloads: DE=5; NL=1; |













| | | |
|---|---|--|
|  | Boxberger, J., Kirchner, M., 1986: Fressboxenstall für 60 Kühe (nach ALB Bayern). Schemazeichnung [de], schwarzweiß, ZNr=LTW-862145 (id=14419) | Rang 206 mit 6 Downloads: BA=1; DE=5; |
|  | N.N., ????: Kettenschlepper KS 07/62. Fotografie, schwarzweiß, ZNr=HUB-3319 (id=638758) | Rang 207 mit 6 Downloads: DE=5; GR=1; |
|  | N.N., ????: Ohne Titel. Fotografie, farbig (id=690323) | Rang 208 mit 6 Downloads: DE=5; PL=1; |
|  | N.N., ????: Ohne Titel. Fotografie, farbig (id=695783) | Rang 209 mit 6 Downloads: DE=5; NL=1; |
|  | Steinkampf, H., ????: Reifenkennlinien. Diagramm [de], einfarbig, ZNr=LTW-385122 (id=705566) | Rang 210 mit 6 Downloads: DE=5; US=1; |
|  | N.N., ????: Schema für das Anlegen von Fahrgassen - Fahrtrichtung beim Drillen. Diagramm [de], einfarbig (id=705822) | Rang 211 mit 6 Downloads: DE=5; GB=1; |
|  | N.N., ????: Ohne Titel. Fotografie, farbig (id=712647) | Rang 212 mit 6 Downloads: DE=5; PL=1; |
|  | N.N., ????: Ohne Titel. Fotografie, farbig (id=715770) | Rang 213 mit 6 Downloads: DE=5; NL=1; |
|  | N.N., 1962: Der Winkeldrehpflug 'Roland' für die Regelhydraulik (Bayerische Pflugfabrik GmbH Landsberg / Lech). Fotografie [de], farbig, ZNr=LTM-5.1.43, DE 318 (id=719103) | Rang 214 mit 6 Downloads: DE=5; HU=1; |
|  | N.N., ????: Selbstfütterung im Flachsilo. Fotografie, farbig (id=721833) | Rang 215 mit 6 Downloads: BE=1; DE=5; |
|  | Auernhammer, H., ????: Ohne Titel. Fotografie, farbig (id=730453) | Rang 216 mit 6 Downloads: DE=5; PL=1; |
|  | N.N., ????: EHR Bedienpult. Fotografie, farbig (id=15109) | Rang 217 mit 6 Downloads: AT=1; DE=4; PL=1; |

| | | |
|---|--|--|
|  | N.N., ????: Ohne Titel. Fotografie, farbig (id=14919) | Rang 218 mit 6 Downloads: AT=2; DE=3; LU=1; |
|  | Wenner, H.-L., Pirkelmann, H., 1982: Entnahmefräsen für Hochsilos. Diagramm [de], schwarzweiß, ZNr=LTW-822344 (id=13077) | Rang 219 mit 6 Downloads: AT=1; CH=3; DE=1; US=1; |
|  | N.N., ????: Heck- / Frontpflugkombination. Fotografie, farbig (id=696779) | Rang 220 mit 6 Downloads: DE=4; NL=1; PL=1; |
|  | Renius, T., Reiter, H., 1989: Hydrostatisches Zusatzgetriebe Fendt - ZF (1987). Schemazeichnung [de], einfarbig, ZNr=LTM-1.3.238, 5540 (id=717951) | Rang 221 mit 6 Downloads: DE=4; NL=1; UA=1; |
|  | N.N., ????: Quantotron TA und AirPlus. Fotografie, farbig (id=15297) | Rang 222 mit 6 Downloads: CH=1; DE=3; HU=2; |
|  | N.N., ????: Biogasanlage mit Schwemmentmistung (System Schmidt-Eggersglüss). Schemazeichnung [de], schwarzweiß (id=695408) | Rang 223 mit 6 Downloads: CH=1; DE=3; PT=2; |
|  | N.N., ????: Ohne Titel. Fotografie, farbig (id=697598) | Rang 224 mit 6 Downloads: AT=1; CA=1; DE=3; US=1; |
|  | N.N., ????: Signalsteckdose nach DIN 9684/1. Fotografie, farbig (id=709644) | Rang 225 mit 6 Downloads: CZ=1; DE=3; DK=1; ZA=1; |
|  | Wenner, H.-L., 1988: Brutto-Stromerzeugung in der BR Deutschland 1986 nach Energieträgern (insges. 408,3 TWh). Diagramm [de], schwarzweiß, ZNr=LTW-882115 (id=691474) | Rang 226 mit 6 Downloads: NL=6; |
|  | Wenner, H.-L., Pirkelmann, H., ????: Silageentnahme mit Frontlader aus Flachsilo. Fotografie, farbig (id=12158) | Rang 227 mit 5 Downloads: DE=5; |
|  | N.N., 1967: Ohne Titel. Fotografie, farbig (id=12993) | Rang 228 mit 5 Downloads: DE=5; |
|  | N.N., ????: Druckregelung in der Fronthydraulik. Schemazeichnung [de], farbig (id=13343) | Rang 229 mit 5 Downloads: DE=5; |

| | | |
|---|--|------------------------------------|
|  | N.N., ????: Heuma. Fotografie, farbig (id=14366) | Rang 230 mit 5 Downloads: DE=5; |
|  | Auernhammer, H., ????: Müller-Elektronik,MFC 5005 zur Mähdrescherüberwachung. Fotografie, farbig (id=14994) | Rang 231 mit 5 Downloads: DE=5; |
|  | N.N., ????: Ohne Titel. Fotografie, farbig (id=15906) | Rang 232 mit 5 Downloads: DE=5; |
|  | N.N., ????: Ackerbürste. Fotografie, schwarzweiß, ZNr=HUB-540 (id=638050) | Rang 233 mit 5 Downloads: DE=5; |
|  | N.N., ????: Getriebeschema Fendt 'Farmer 3 S'. Fotografie, schwarzweiß, ZNr=HUB-5349 (id=638956) | Rang 234 mit 5 Downloads: DE=5; |
|  | N.N., ????: Anlasshilfe im Vorkammermotor (Lunte oder Glühkerze). Fotografie, schwarzweiß, ZNr=HUB-667 (id=639926) | Rang 235 mit 5 Downloads: DE=5; |
|  | N.N., ????: Pöhl-Ackerbaumaschine. Fotografie, schwarzweiß, ZNr=HUB-4541 (id=642842) | Rang 236 mit 5 Downloads: DE=5; |
|  | Brenner, W., Wenner, H.-L., ????: Ohne Titel. Fotografie, farbig (id=689660) | Rang 237 mit 5 Downloads: DE=5; |
|  | Brenner, W., Wenner, H.-L., ????: Ohne Titel. Fotografie, farbig (id=689719) | Rang 238 mit 5 Downloads: DE=5; |
|  | N.N., ????: Ohne Titel. Fotografie, farbig (id=690407) | Rang 239 mit 5 Downloads: DE=5; |
|  | N.N., ????: Ohne Titel. Fotografie, farbig (id=690644) | Rang 240 mit 5 Downloads: DE=5; |







| | | |
|---|---|------------------------------------|
|  | N.N., ????: Ohne Titel. Schemazeichnung [de], schwarzweiß (id=691482) | Rang 241 mit 5 Downloads: DE=5; |
|  | N.N., ????: Ohne Titel. Fotografie, farbig (id=694719) | Rang 242 mit 5 Downloads: DE=5; |
|  | N.N., ????: Anpflügen mit Beetpflug (Spaltfurche). Fotografie, farbig (id=694759) | Rang 243 mit 5 Downloads: DE=5; |
|  | N.N., ????: Ohne Titel. Fotografie, farbig (id=694825) | Rang 244 mit 5 Downloads: DE=5; |
|  | N.N., ????: Ohne Titel. Fotografie, farbig (id=695060) | Rang 245 mit 5 Downloads: DE=5; |
|  | N.N., ????: Ohne Titel. Fotografie, farbig (id=695090) | Rang 246 mit 5 Downloads: DE=5; |
|  | N.N., ????: Ohne Titel. Fotografie, farbig (id=695220) | Rang 247 mit 5 Downloads: DE=5; |
|  | N.N., ????: Ohne Titel. Fotografie, farbig (id=695451) | Rang 248 mit 5 Downloads: DE=5; |
|  | N.N., ????: Ohne Titel. Fotografie, schwarzweiß (id=695482) | Rang 249 mit 5 Downloads: DE=5; |
|  | N.N., ????: Ohne Titel. Fotografie, farbig (id=696462) | Rang 250 mit 5 Downloads: DE=5; |
|  | N.N., ????: Ohne Titel. Fotografie, farbig (id=697033) | Rang 251 mit 5 Downloads: DE=5; |
|  | Demmel, M., ????: Ohne Titel. Fotografie, farbig (id=698319) | Rang 252 mit 5 Downloads: DE=5; |
|  | Demmel, M., ????: Ohne Titel. Fotografie, farbig (id=698820) | Rang 253 mit 5 Downloads: DE=5; |
|  | Schön, H., 2000: Anforderungen an Liegeboxen für Hochleistungskühe. Schemazeichnung [de], schwarzweiß, ZNr=LTW-002002 (id=701572) | Rang 254 mit 5 Downloads: DE=5; |

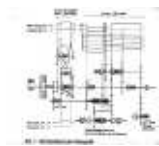
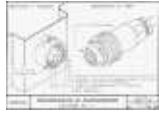

| | | |
|---|---|------------------------------------|
|  | N.N., ????: Ohne Titel. Fotografie, farbig (id=703479) | Rang 255 mit 5 Downloads: DE=5; |
|  | N.N., ????: Ohne Titel. Fotografie, farbig (id=703498) | Rang 256 mit 5 Downloads: DE=5; |
|  | N.N., ????: Ohne Titel. Fotografie, farbig (id=703682) | Rang 257 mit 5 Downloads: DE=5; |
|  | N.N., ????: Ohne Titel. Fotografie, farbig (id=704033) | Rang 258 mit 5 Downloads: DE=5; |
|  | Auernhammer, H., ????: Gesamtübersicht zum Kriterium 'Arbeit' in Milchviehställen. Diagramm [de], einfarbig, ZNr=LTW-286105 (id=704483) | Rang 259 mit 5 Downloads: DE=5; |
|  | N.N., ????: Ohne Titel. Fotografie, farbig (id=704700) | Rang 260 mit 5 Downloads: DE=5; |
|  | N.N., ????: Ohne Titel. Fotografie, farbig (id=710157) | Rang 261 mit 5 Downloads: DE=5; |
|  | N.N., ????: Ohne Titel. Fotografie, farbig (id=711302) | Rang 262 mit 5 Downloads: DE=5; |
|  | N.N., ????: Ohne Titel. Fotografie, farbig (id=711827) | Rang 263 mit 5 Downloads: DE=5; |
|  | N.N., ????: Ohne Titel. Fotografie, farbig (id=713743) | Rang 264 mit 5 Downloads: DE=5; |
|  | N.N., ????: Ohne Titel. Fotografie, farbig (id=715792) | Rang 265 mit 5 Downloads: DE=5; |
|  | N.N., ????: Ohne Titel. Fotografie, farbig, ZNr=LTM-1.1.127 (id=716826) | Rang 266 mit 5 Downloads: DE=5; |
|  | N.N., ????: Ohne Titel. Fotografie, farbig, ZNr=LTM-1.1.128 (id=716827) | Rang 267 mit 5 Downloads: DE=5; |
|  | Renius, T., 1995: Getriebe mit Hi-Lo-Lastsch, für Case-ICH Traktoren 3200 (33/38/44kW) u. 4200 (52 bis 66kW), 1993. Schemazeichnung [de], einfarbig, ZNr=LTM-1.3.324, 6255 (id=718033) | Rang 268 mit 5 Downloads: DE=5; |
|  | Renius, T., 1998: Bandlaufwerk gegen Allradantrieb: Laufwerkswirkungsgrade. Diagramm [de], einfarbig, ZNr=LTM-4.2.244, 6654 (id=718862) | Rang 269 mit 5 Downloads: DE=5; |

| | | |
|---|---|------------------------------------|
|  | N.N., ????: Ohne Titel. Fotografie, farbig, ZNr=LTM-17204 (id=720016) | Rang 270 mit 5 Downloads: DE=5; |
|  | N.N., ????: Ohne Titel. Fotografie, farbig, ZNr=LTM-7.1.238 (id=720400) | Rang 271 mit 5 Downloads: DE=5; |
|  | N.N., ????: Gallischer Mähwagen (ältere und neuere Rekonstruktion). Fotografie [de], schwarzweiß, ZNr=LTM-36957 (id=720599) | Rang 272 mit 5 Downloads: DE=5; |
|  | N.N., ????: Ohne Titel. Fotografie, farbig, ZNr=LTM-34400 (id=720689) | Rang 273 mit 5 Downloads: DE=5; |
|  | N.N., ????: Ohne Titel. Fotografie, farbig, ZNr=LTM-7.5.127 (id=721066) | Rang 274 mit 5 Downloads: DE=5; |
|  | N.N., ????: Ohne Titel. Fotografie, farbig (id=723611) | Rang 275 mit 5 Downloads: DE=5; |
|  | N.N., ????: Ohne Titel. Fotografie, schwarzweiß (id=727583) | Rang 276 mit 5 Downloads: DE=5; |
|  | N.N., ????: Arbeit der Netzegge vor und nach dem Auflaufen. Fotografie [de], schwarzweiß (id=728887) | Rang 277 mit 5 Downloads: DE=5; |
|  | N.N., ????: Mobile Trochnungsanlage CLAAS Apollo. Fotografie, farbig (id=729226) | Rang 278 mit 5 Downloads: DE=5; |
|  | Rittel, L., 1982: Greiferhalle, Heubergehalle, Heuturm. Schemazeichnung [de], schwarzweiß, ZNr=LTW-1083/3 (id=729256) | Rang 279 mit 5 Downloads: DE=5; |
|  | Estler, M., Peisl, S., 1993: LBS - Direkteinspeisungssystem. Schemazeichnung [de], schwarzweiß, ZNr=LTW-932341 (id=731331) | Rang 280 mit 5 Downloads: DE=5; |
|  | Boxberger, J., Widmann, B., 1995: Aufteilung konventioneller Abferkelbuchten. Schemazeichnung [de], schwarzweiß, ZNr=LTW-952283 (id=731777) | Rang 281 mit 5 Downloads: DE=5; |
|  | Gronauer, A., Amon, H., 1996: Flüssigmist-Separatoren Pressschnecke. Schemazeichnung [de], schwarzweiß, ZNr=LTW-962026 (id=731950) | Rang 282 mit 5 Downloads: DE=5; |

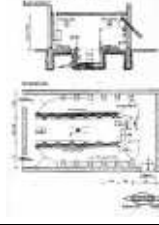
| | | |
|---|--|--|
|  | Schön, H., Bauer, R., 2002: Exakt-Feldhäckslер. Schemazeichnung [de], schwarzweiß, ZNr=LTW-022060 (id=733637) | Rang 283 mit 5 Downloads: DE=5; |
|  | Auernhammer, H., 2003: Fischgrätenmelkstand (Germania). Fotografie [de], farbig, ZNr=LTW-032265 (id=734146) | Rang 284 mit 5 Downloads: DE=5; |
|  | N.N., ????: Ohne Titel. Fotografie, schwarzweiß (id=1208362) | Rang 285 mit 5 Downloads: DE=5; |
|  | Brenner, W., Wenner, H.-L., ????: Ohne Titel. Fotografie, farbig (id=12082) | Rang 286 mit 5 Downloads: AT=1; DE=4; |
|  | N.N., ????: Ohne Titel. Fotografie, farbig (id=14034) | Rang 287 mit 5 Downloads: AT=1; DE=4; |
|  | Auernhammer, H., 1986: Ackerschlepper mit elektronischer Schlupfregelung (nach BOSCH (Werkbild)). Schemazeichnung [de], schwarzweiß, ZNr=LTW-862169 (id=14989) | Rang 288 mit 5 Downloads: AT=1; DE=4; |
|  | N.N., ????: Ohne Titel. Fotografie, farbig (id=703495) | Rang 289 mit 5 Downloads: AT=1; DE=4; |
|  | N.N., ????: Ohne Titel. Fotografie, farbig, ZNr=LTM-5.2.138 (id=719516) | Rang 290 mit 5 Downloads: AT=1; DE=4; |
|  | N.N., ????: Fischgrätenmelkstand. Fotografie [de], farbig (id=728833) | Rang 291 mit 5 Downloads: AT=1; DE=4; |
|  | N.N., ????: Westfalia Melkanlagen. Fotografie [de], farbig (id=15482) | Rang 292 mit 5 Downloads: AT=2; DE=3; |
|  | Haidn, B., Schürzinger, H., 1995: Mastschweineestall mit Ruheboxen (nach Wiedmann). Schemazeichnung [de], schwarzweiß (id=701901) | Rang 293 mit 5 Downloads: CH=2; DE=3; |
|  | N.N., ????: Die wichtigsten Anforderungen an Rohrmelkanlagen. Schemazeichnung [de], schwarzweiß (id=728392) | Rang 294 mit 5 Downloads: AT=1; CH=1; DE=3; |

| | | |
|---|--|--|
|  | Auernhammer, H., 1997: Signalsteckdose an Ackerschleppern nach DIN 9684/1. Schemazeichnung [de], schwarzweiß, ZNr=LTW-972471 (id=732576) | Rang 295 mit 5 Downloads: CH=2; DE=3; |
|  | Estler, M., ????: No-Till 1040. Fotografie, farbig (id=15822) | Rang 296 mit 5 Downloads: CH=3; DE=2; |
|  | N.N., ????: Kennliniengleich von Radial- und Axial-Heulüfter. Diagramm [de], schwarzweiß (id=694756) | Rang 297 mit 5 Downloads: CH=4; DE=1; |
|  | N.N., ????: Schlitzdosierung. Schemazeichnung [de], farbig (id=722920) | Rang 298 mit 5 Downloads: AT=4; DE=1; |
|  | N.N., ????: Fahrbarer Erntedrescher, 1836 patentiert für Briggs und G.C. Carpenter (keine technischen Einzelheiten überliefert). Schemazeichnung [de], schwarzweiß (id=706167) | Rang 299 mit 5 Downloads: AT=5; |
|  | Wenner, H.-L., Boxberger, J., ????: Ohne Titel. Fotografie, farbig (id=12134) | Rang 300 mit 5 Downloads: DE=4; US=1; |
|  | Schulz, H., 1975: Ohne Titel. Fotografie, farbig (id=12419) | Rang 301 mit 5 Downloads: DE=4; NL=1; |
|  | N.N., ????: Ohne Titel. Fotografie, farbig (id=12947) | Rang 302 mit 5 Downloads: DE=4; US=1; |
|  | Boxberger, J., Schön, H., 1975: Liegeboxenlaufstall- Erweiterung. Schemazeichnung [de], schwarzweiß, ZNr=LTW-11/24/1975 (id=14454) | Rang 303 mit 5 Downloads: DE=4; US=1; |
|  | N.N., ????: Ohne Titel. Fotografie, farbig (id=15845) | Rang 304 mit 5 Downloads: DE=4; US=1; |
|  | N.N., ????: Futterdämpfer. Fotografie, schwarzweiß, ZNr=HUB-614 (id=642228) | Rang 305 mit 5 Downloads: DE=4; EG=1; |
|  | Brenner, W., Wenner, H.-L., ????: Ohne Titel. Fotografie, farbig (id=689671) | Rang 306 mit 5 Downloads: DE=4; NL=1; |

| | | |
|---|---|--|
|  | N.N., ????: Getriebschema des Unimog 406. Schemazeichnung [de], schwarzweiß (id=697271) | Rang 307 mit 5 Downloads: DE=4; FR=1; |
|  | Auernhammer, H., 1995: Ohne Titel. Fotografie, farbig (id=707013) | Rang 308 mit 5 Downloads: DE=4; LU=1; |
|  | Auernhammer, H., 1990: Signalsteckdose an Ackerschleppern (DIN 9684, Teil 1). Schemazeichnung [de], schwarzweiß, ZNr=LTW-902284 (id=709460) | Rang 309 mit 5 Downloads: CZ=1; DE=4; |
|  | Auernhammer, H., ????: Ohne Titel. Fotografie, farbig (id=709664) | Rang 310 mit 5 Downloads: DE=4; PL=1; |
|  | Auernhammer, H., 1993: Ohne Titel. Fotografie, farbig (id=710560) | Rang 311 mit 5 Downloads: BE=1; DE=4; |
|  | N.N., ????: Ohne Titel. Fotografie, farbig (id=711303) | Rang 312 mit 5 Downloads: DE=4; NL=1; |
|  | N.N., ????: Ohne Titel. Fotografie, farbig (id=711900) | Rang 313 mit 5 Downloads: DE=4; PL=1; |
|  | N.N., ????: Ohne Titel. Fotografie, farbig (id=712968) | Rang 314 mit 5 Downloads: DE=4; US=1; |
|  | N.N., ????: Ohne Titel. Fotografie, farbig, ZNr=LTM-1.1.294 (id=716968) | Rang 315 mit 5 Downloads: DE=4; PL=1; |
|  | N.N., ????: Ohne Titel. Fotografie, farbig, ZNr=LTM-34127 (id=721216) | Rang 316 mit 5 Downloads: DE=4; PL=1; |
|  | N.N., ????: Ohne Titel. Fotografie, farbig (id=722448) | Rang 317 mit 5 Downloads: DE=4; NL=1; |
|  | Schön, H., 1976: Fischgrätmelkstand. Schemazeichnung [de], schwarzweiß, ZNr=LTW-762173 (id=728605) | Rang 318 mit 5 Downloads: DE=4; FI=1; |
|  | Boxberger, J., Widmann, B., 1995: Deckzentrum für ca.60 Sauen (kontin. Stallbelegung ohne künstliche Besamung) nach LORENZ. Schemazeichnung [de], schwarzweiß, ZNr=LTW-952281 (id=731775) | Rang 319 mit 5 Downloads: CA=1; DE=4; |
|  | Auernhammer, H., 1999: Seitlich gelagerte Querschwinge, Fendt Favorit 500 C, 800, 900, Xylon. Schemazeichnung [de], schwarzweiß, ZNr=LTW-992037 (id=732975) | Rang 320 mit 5 Downloads: DE=4; EE=1; |

| | | |
|---|--|--|
|  | Estler, M., ????: Ohne Titel. Fotografie, farbig (id=13223) | Rang 321 mit 5 Downloads: DE=3; PL=2; |
|  | N.N., ????: Fischgrätmelkstand. Schemazeichnung [de], schwarzweiß (id=14513) | Rang 322 mit 5 Downloads: DE=3; US=2; |
|  | N.N., ????: Ohne Titel. Fotografie, farbig (id=15430) | Rang 323 mit 5 Downloads: DE=3; NL=2; |
|  | N.N., ????: Ohne Titel. Fotografie, farbig (id=700483) | Rang 324 mit 5 Downloads: DE=3; US=2; |
|  | N.N., ????: Ohne Titel. Fotografie, farbig (id=711969) | Rang 325 mit 5 Downloads: BE=1; DE=3; PL=1; |
|  | N.N., ????: Ohne Titel. Fotografie, farbig (id=695423) | Rang 326 mit 5 Downloads: AT=2; IT=3; |
|  | N.N., ????: Furchentiefe mit Regelhydraulik für Anbaupflug und Aufsattelpflug. Schemazeichnung [de], schwarzweiß (id=712632) | Rang 327 mit 5 Downloads: DE=2; SK=2; US=1; |
|  | N.N., ????: Ohne Titel. Fotografie, schwarzweiß, ZNr=LTM-44201 (id=719088) | Rang 328 mit 5 Downloads: DE=1; NL=4; |
|  | N.N., ????: Vergleich verschiedener Fressgitterformen (4-stündige Versuche, 2-malige Wiederholung, 6 Färsen, Maissilage). Diagramm [de], einfarbig (id=729490) | Rang 329 mit 5 Downloads: CA=3; DE=1; US=1; |
|  | N.N., ????: Einbauweise von Höhen- und Seitenförderer. Schemazeichnung [de], schwarzweiß (id=695790) | Rang 330 mit 5 Downloads: US=5; |

3 Länderspezifische Downloads

Nachfolgend werden alle Länder mit Downloads in 2014 einzeln dargestellt. Tabellarisch in 3-spaltiger Anordnung sind die Bilder mit den Kenndaten zum Bild in der Form:

- Internetkode-Rang _ Downloadanzahl dieses Landes (Gesamtanzahl Downloads dieses Bildes in 2014)
- Id als Identifikation in der AgTecCollection in mediaTUM
- FileName als Originalname des gescannten Bildes

aufgeführt.



Beim Original-Dateinamen (FileName) ist zu beachten, dass alle Bilder vom Lehrstuhl für Landmaschinen der TUM innerhalb der TUM-Bilder mit der Endung „tif“ enthalten sind. Hingegen besitzen alle Bilder der Humboldt Universität zu Berlin den Präfix „HUB-“.

Bei Bedarf können Bilder von Interesse ganz einfach über die ID in der AgTecCollection direkt angesprochen werden, wenn dazu in der Adresszeile die id mit vorangehendem Fragezeichen (Beispiel id=12277) in der Form



<http://mediatum.ub.tum.de/?id=12277>

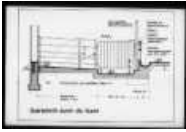





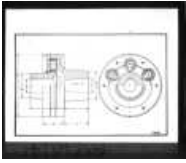
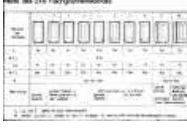

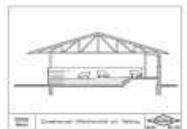



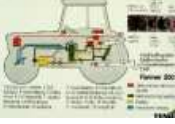

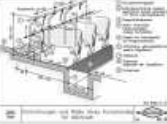

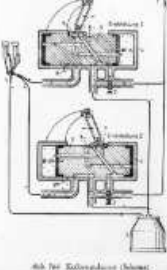



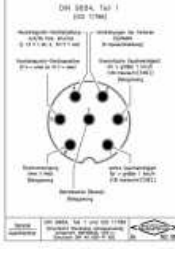

angegeben wird. Folgebilder können über die Änderung der entsprechenden ID wiederum direkt angezeigt werden!





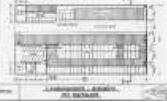













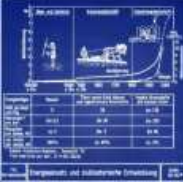

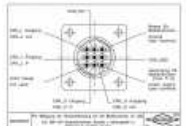
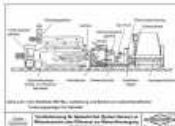

3.1 Bilder-Downloads 2014: A2 (Satelliten Provider)

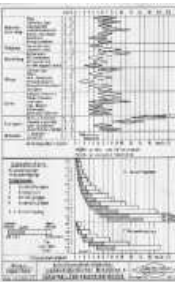















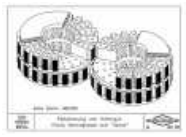

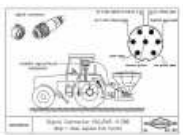
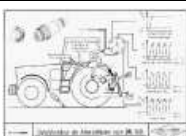

| <i>Bild</i> | <i>Kennwerte</i> | <i>Bild</i> | <i>Kennwerte</i> | <i>Bild</i> | <i>Kennwerte</i> |
|---|---|---|--|---|--|
|  | A2-0001_2(95) id=12277 00001971.tif |  | A2-0002_2(71) id=732043 962138.png |  | A2-0003_1(23) id=731296 932272.png |

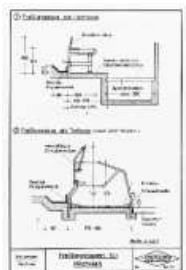

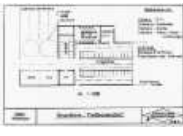
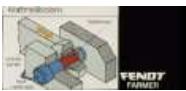
3.2 Bilder-Downloads 2014: AT (Österreich)

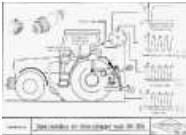

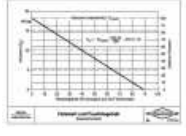
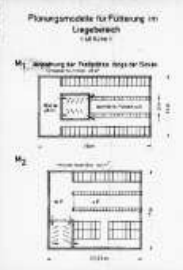



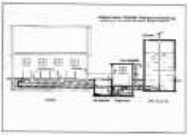

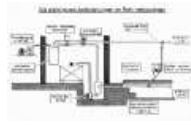











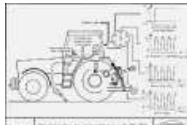





| Bild | Kennwerte | Bild | Kennwerte | Bild | Kennwerte |
|---|--|---|--|---|--|
|  | AT-0001_49(56) id=638341 hub-04614.tif |  | AT-0002_17(60) id=14044 00015810.tif |  | AT-0003_15(95) id=12277 00001971.tif |
|  | AT-0004_13(71) id=732043 962138.png |  | AT-0005_11(23) id=731296 932272.png |  | AT-0006_10(65) id=732055 962152.png |
|  | AT-0007_8(41) id=733193 002058.png |  | AT-0008_8(33) id=704610 00019845.tif |  | AT-0009_8(10) id=731293 932269.png |
|  | AT-0010_7(21) id=701340 00015426.tif |  | AT-0011_6(58) id=729097 00049735.tif |  | AT-0012_6(20) id=13987 00015704.tif |
|  | AT-0013_6(18) id=14052 00015822.tif |  | AT-0014_6(10) id=731778 952284.png |  | AT-0015_5(41) id=703578 00018485.tif |
|  | AT-0016_5(15) id=725877 00046327.tif |  | AT-0017_5(11) id=13986 00015701.tif |  | AT-0018_5(5) id=706167 00021903.tif |
|  | AT-0019_4(121) id=716664 932287.png |  | AT-0020_4(15) id=724349 00044715.tif |  | AT-0021_4(14) id=14050 00015820.tif |
|  | AT-0022_4(9) id=14051 00015821.tif |  | AT-0023_4(9) id=712631 952069.png |  | AT-0024_4(8) id=731808 952318.png |
|  | AT-0025_4(7) id=703820 00018787.tif |  | AT-0026_4(5) id=722920 00043168.tif |  | AT-0027_4(4) id=695634 00007485.tif |













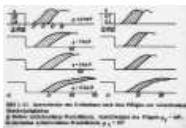

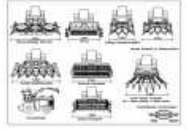
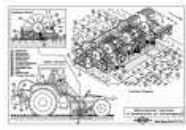



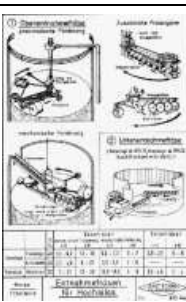

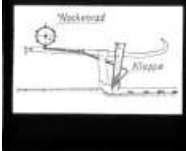
| | | | | | |
|---|--|---|---|---|---|
|  | <p>AT-0028_3(131) id=708251 00025123.tif</p> |  | <p>AT-0029_3(32) id=12981 00007302.tif</p> |  | <p>AT-0030_3(25) id=730456 00051267.tif</p> |
|  | <p>AT-0031_3(51) id=717444 00036976.tif</p> |  | <p>AT-0032_3(11) id=701548 00015683.tif</p> |  | <p>AT-0033_3(11) id=732937 982365.png</p> |
|  | <p>AT-0034_3(8) id=705169 00020571.tif</p> |  | <p>AT-0035_3(6) id=701480 00015604.tif</p> |  | <p>AT-0036_3(4) id=704581 00019804.tif</p> |
|  | <p>AT-0037_3(3) id=694739 00006371.tif</p> |  | <p>AT-0038_3(3) id=721465 00041410.tif</p> |  | <p>AT-0039_3(3) id=728652 00049232.tif</p> |
|  | <p>AT-0040_2(83) id=731997 962086.png</p> |  | <p>AT-0041_2(37) id=731745 952239.png</p> |  | <p>AT-0042_2(14) id=724336 00044701.tif</p> |
|  | <p>AT-0043_2(11) id=695447 00007226.tif</p> |  | <p>AT-0044_2(12) id=718032 00037618.tif</p> |  | <p>AT-0045_2(9) id=122207 00001207.tif</p> |
|  | <p>AT-0046_2(9) id=712388 00031136.tif</p> |  | <p>AT-0047_2(11) id=15877 00035921.tif</p> |  | <p>AT-0048_2(10) id=14060 00015845.tif</p> |
|  | <p>AT-0049_2(6) id=722921 00043169.tif</p> |  | <p>AT-0050_2(8) id=731299 932277.png</p> |  | <p>AT-0051_2(6) id=14919 00023658.tif</p> |



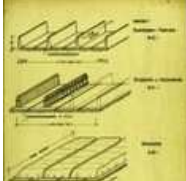







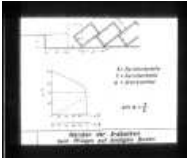



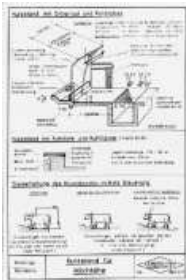







| | | | | | |
|---|--|---|---|---|---|
|  | <p>AT-0052_2(5) id=15482 00027743.tif</p> |  | <p>AT-0053_2(4) id=12609 00004286.tif</p> |  | <p>AT-0054_2(4) id=14771 00023101.tif</p> |
|  | <p>AT-0055_2(4) id=690009 00000483.tif</p> |  | <p>AT-0056_2(4) id=734002 032117.png</p> |  | <p>AT-0057_2(4) id=1208369 00052068.tif</p> |
|  | <p>AT-0058_2(4) id=696609 00008301.tif</p> |  | <p>AT-0059_2(3) id=640939 hub-01153.tif</p> |  | <p>AT-0060_2(3) id=702288 00016599.tif</p> |
|  | <p>AT-0061_2(3) id=703825 00018792.tif</p> |  | <p>AT-0062_2(3) id=721925 00042069.tif</p> |  | <p>AT-0063_2(3) id=732131 962262.png</p> |
|  | <p>AT-0064_2(3) id=732503 972367.png</p> |  | <p>AT-0065_2(3) id=733546 012214.png</p> |  | <p>AT-0066_2(5) id=695423 00007196.tif</p> |
|  | <p>AT-0067_2(3) id=731194 932097.png</p> |  | <p>AT-0068_2(2) id=12376 00002969.tif</p> |  | <p>AT-0069_2(2) id=642372 hub-02268.tif</p> |
|  | <p>AT-0070_2(2) id=694998 00006675.tif</p> |  | <p>AT-0071_2(2) id=695464 00007243.tif</p> |  | <p>AT-0072_2(2) id=701391 00015498.tif</p> |
|  | <p>AT-0073_2(2) id=703022 00017839.tif</p> |  | <p>AT-0074_2(2) id=705599 00021149.tif</p> |  | <p>AT-0075_2(2) id=706784 00022801.tif</p> |

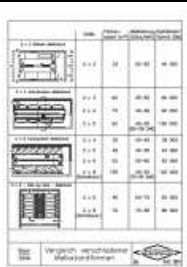















| | | | | | |
|---|--|---|---|---|---|
|  | AT-0076_2(2) id=722924 00043172.tif |  | AT-0077_2(2) id=723540 00043859.tif |  | AT-0078_2(2) id=728912 00049521.tif |
|  | AT-0079_2(2) id=730155 00050878.tif |  | AT-0080_2(2) id=730223 00050947.tif |  | AT-0081_2(2) id=730557 00051388.tif |
|  | AT-0082_2(2) id=732197 962355.png |  | AT-0083_2(2) id=732642 982027.png |  | AT-0084_1(125) id=717109 00036613.tif |
|  | AT-0085_1(43) id=12665 00004609.tif |  | AT-0086_1(24) id=15581 00028309.tif |  | AT-0087_1(32) id=710156 932387.png |
|  | AT-0088_1(27) id=708542 00025604.tif |  | AT-0089_1(19) id=721500 00041446.tif |  | AT-0090_1(17) id=690286 00000847.tif |
|  | AT-0091_1(13) id=14420 00018902.tif |  | AT-0092_1(13) id=690278 00000834.tif |  | AT-0093_1(14) id=14423 00018932.tif |
|  | AT-0094_1(11) id=717426 00036957.tif |  | AT-0095_1(11) id=639234 hub-02812.tif |  | AT-0096_1(10) id=731820 952331.png |
|  | AT-0097_1(11) id=709457 00027024.tif |  | AT-0098_1(10) id=705308 00020750.tif |  | AT-0099_1(9) id=14884 00023440.tif |
|  | AT-0100_1(9) id=734391 072014.png |  | AT-0101_1(9) id=721900 00042042.tif |  | AT-0102_1(8) id=14718 00022215.tif |



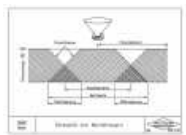
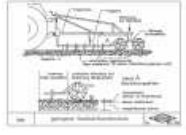
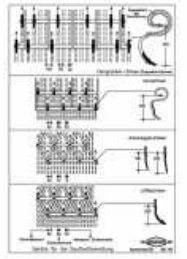
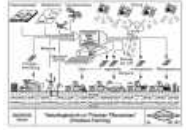
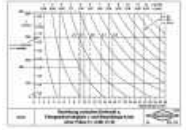
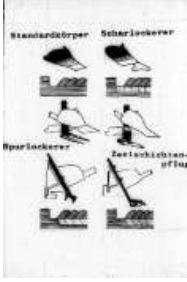

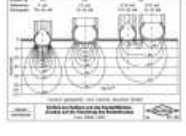

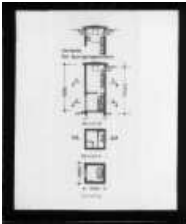











| | | | | | |
|---|---|---|--|---|---|
|  | AT-0103_1(8) id=14063 00015857.tif |  | AT-0104_1(12) id=712027 00030740.tif |  | AT-0105_1(8) id=12332 00002487.tif |
|  | AT-0106_1(8) id=705913 00021580.tif |  | AT-0107_1(7) id=702085 00016405.tif |  | AT-0108_1(7) id=715862 00035133.tif |
|  | AT-0109_1(6) id=12281 00002001.tif |  | AT-0110_1(6) id=701627 00015844.tif |  | AT-0111_1(6) id=703731 00018680.tif |
|  | AT-0112_1(6) id=704111 00019215.tif |  | AT-0113_1(6) id=722484 00042664.tif |  | AT-0114_1(6) id=733051 992123.png |
|  | AT-0115_1(7) id=14452 00019176.tif |  | AT-0116_1(6) id=15109 00024668.tif |  | AT-0117_1(6) id=731173 932062.png |
|  | AT-0118_1(5) id=12082 00000525.tif |  | AT-0119_1(5) id=14034 00015784.tif |  | AT-0120_1(5) id=14989 00024034.tif |
|  | AT-0121_1(5) id=703495 00018383.tif |  | AT-0122_1(5) id=719516 00039208.tif |  | AT-0123_1(5) id=728833 00049430.tif |
|  | AT-0124_1(9) id=12090 00000563.tif |  | AT-0125_1(7) id=699990 00013529.tif |  | AT-0126_1(6) id=697598 00009608.tif |
|  | AT-0127_1(5) id=728392 00048955.tif |  | AT-0128_1(4) id=13190 00009656.tif |  | AT-0129_1(4) id=13988 00015705.tif |

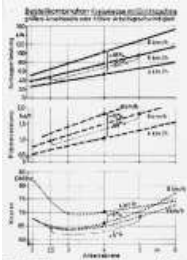

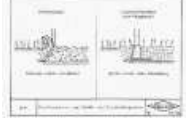

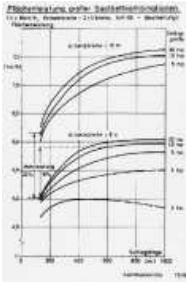
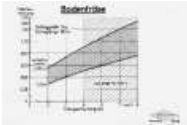
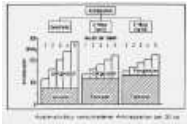





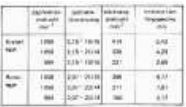

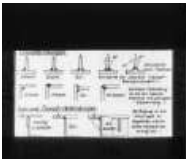

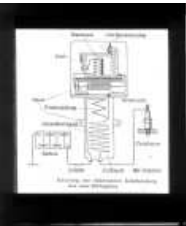

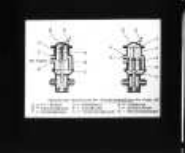
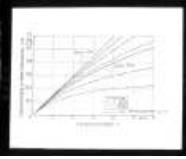
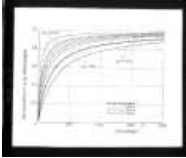
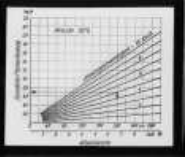
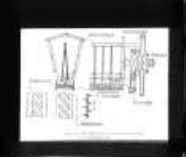

| | | | | | |
|---|--|---|--|---|--|
|  | AT-0130_1(4) id=15459 00027669.tif |  | AT-0131_1(4) id=638919 hub-01644.tif |  | AT-0132_1(4) id=701094 00015123.tif |
|  | AT-0133_1(4) id=701446 00015565.tif |  | AT-0134_1(4) id=702559 00016926.tif |  | AT-0135_1(4) id=712128 00030849.tif |
|  | AT-0136_1(4) id=714848 00033962.tif |  | AT-0137_1(4) id=719095 00038760.tif |  | AT-0138_1(4) id=729210 00049851.tif |
|  | AT-0139_1(4) id=12073 00000473.tif |  | AT-0140_1(4) id=703648 00018568.tif |  | AT-0141_1(4) id=716467 00035858.tif |
|  | AT-0142_1(4) id=717320 00036836.tif |  | AT-0143_1(4) id=1208363 00052100.tif |  | AT-0144_1(3) id=13239 00010047.tif |
|  | AT-0145_1(3) id=13793 00012349.tif |  | AT-0146_1(3) id=14750 00022785.tif |  | AT-0147_1(3) id=14845 00023330.tif |
|  | AT-0148_1(3) id=639286 hub-01950.tif |  | AT-0149_1(3) id=640934 hub-01156.tif |  | AT-0150_1(3) id=640936 hub-01154.tif |
|  | AT-0151_1(3) id=690322 00000888.tif |  | AT-0152_1(3) id=695643 00007495.tif |  | AT-0153_1(3) id=700351 00014254.tif |
|  | AT-0154_1(3) id=700357 00014260.tif |  | AT-0155_1(3) id=701609 00015802.tif |  | AT-0156_1(3) id=712634 00031483.tif |

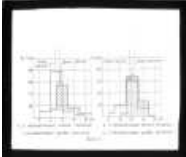
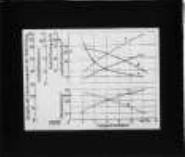
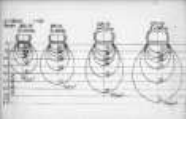
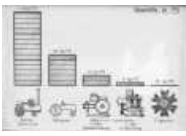

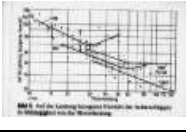

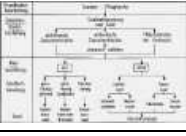





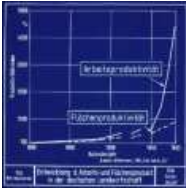
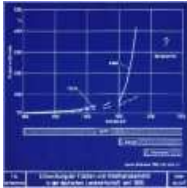
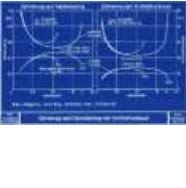
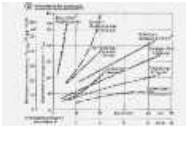
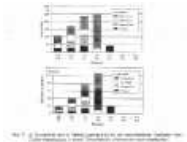
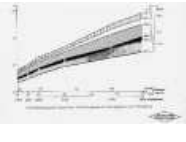

| | | | | | |
|---|--|---|---|---|---|
|  | AT-0157_1(3) id=722928 00043179.tif |  | AT-0158_1(3) id=729751 00050455.tif |  | AT-0159_1(3) id=730652 00051502.tif |
|  | AT-0160_1(3) id=731771 952276.png |  | AT-0161_1(3) id=732160 962297.png |  | AT-0162_1(3) id=732421 972235.png |
|  | AT-0163_1(3) id=732958 992019.png |  | AT-0164_1(3) id=733969 032077.png |  | AT-0165_1(3) id=1208367 00052138.tif |
|  | AT-0166_1(6) id=13077 00008535.tif |  | AT-0167_1(6) id=701166 00015210.tif |  | AT-0168_1(3) id=13989 00015711.tif |
|  | AT-0169_1(3) id=643312 hub-03365.tif |  | AT-0170_1(3) id=696589 00008279.tif |  | AT-0171_1(3) id=704682 00019947.tif |
|  | AT-0172_1(3) id=722410 00042584.tif |  | AT-0173_1(3) id=730797 912086.png |  | AT-0174_1(3) id=811796 JLUG-00068.tif |
|  | AT-0175_1(2) id=12744 00005060.tif |  | AT-0176_1(2) id=12818 00005684.tif |  | AT-0177_1(2) id=13661 00011902.tif |
|  | AT-0178_1(2) id=14038 00015798.tif |  | AT-0179_1(2) id=14520 00019944.tif |  | AT-0180_1(2) id=14846 00023331.tif |

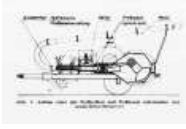
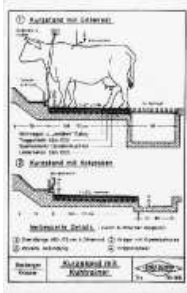
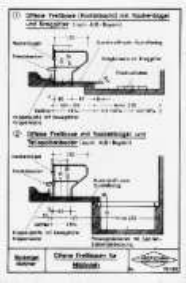







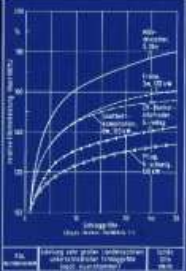

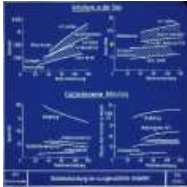
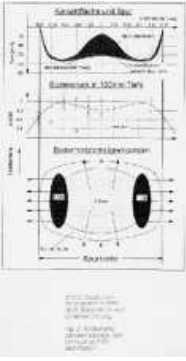
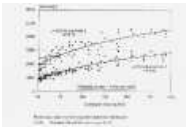
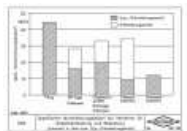

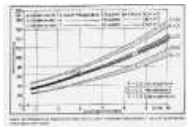
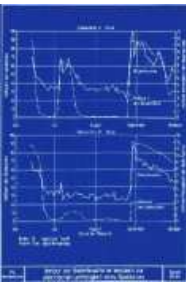

| | | | | | |
|---|---|---|--|---|---|
|  | AT-0181_1(2) id=14871 00023401.tif |  | AT-0182_1(2) id=642223 hub-00613.tif |  | AT-0183_1(2) id=690289 00000850.tif |
|  | AT-0184_1(2) id=700130 00013904.tif |  | AT-0185_1(2) id=700940 00015009.tif |  | AT-0186_1(2) id=701333 00015417.tif |
|  | AT-0187_1(2) id=701424 00015533.tif |  | AT-0188_1(2) id=701563 00015702.tif |  | AT-0189_1(2) id=702056 00016367.tif |
|  | AT-0190_1(2) id=702082 00016397.tif |  | AT-0191_1(2) id=704048 00019104.tif |  | AT-0192_1(2) id=704292 00019433.tif |
|  | AT-0193_1(2) id=704293 00019434.tif |  | AT-0194_1(2) id=704680 00019945.tif |  | AT-0195_1(2) id=704686 00019951.tif |
|  | AT-0196_1(2) id=704689 00019955.tif |  | AT-0197_1(2) id=705265 942004.png |  | AT-0198_1(2) id=705751 952065.png |
|  | AT-0199_1(2) id=706457 00022324.tif |  | AT-0200_1(2) id=706585 00022519.tif |  | AT-0201_1(2) id=715773 00035011.tif |
|  | AT-0202_1(2) id=719972 00039712.tif |  | AT-0203_1(2) id=720090 00039837.tif |  | AT-0204_1(2) id=720754 00040563.tif |





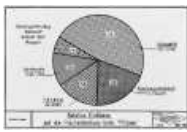

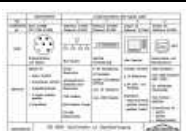

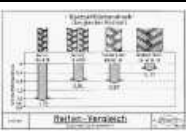

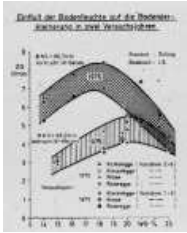
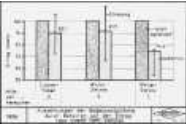
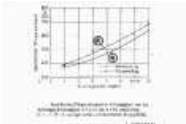
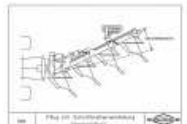
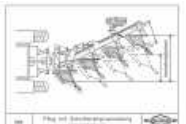



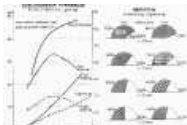



| | | | | | |
|---|--|---|---|---|---|
|  | AT-0205_1(2) id=721188 00041069.tif |  | AT-0206_1(2) id=721312 00041216.tif |  | AT-0207_1(2) id=721486 00041431.tif |
|  | AT-0208_1(2) id=721749 00041863.tif |  | AT-0209_1(2) id=722925 00043173.tif |  | AT-0210_1(2) id=728501 00049073.tif |
|  | AT-0211_1(2) id=728705 00049287.tif |  | AT-0212_1(2) id=729176 00049815.tif |  | AT-0213_1(2) id=730624 00051469.tif |
|  | AT-0214_1(2) id=730777 00051631.tif |  | AT-0215_1(2) id=730802 912094.png |  | AT-0216_1(2) id=731141 932013.png |
|  | AT-0217_1(2) id=732093 962206.png |  | AT-0218_1(2) id=733073 992146.png |  | AT-0219_1(2) id=733201 002067.png |
|  | AT-0220_1(2) id=733779 022216.png |  | AT-0221_1(3) id=712733 00031591.tif |  | AT-0222_1(3) id=729850 00050559.tif |
|  | AT-0223_1(3) id=732529 972395.png |  | AT-0224_1(2) id=13985 00015696.tif |  | AT-0225_1(2) id=14437 00019064.tif |
|  | AT-0226_1(2) id=640440 hub-04373.tif |  | AT-0227_1(2) id=705214 00020629.tif |  | AT-0228_1(2) id=707218 00023468.tif |

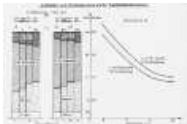
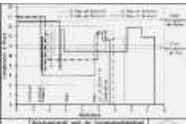

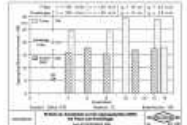
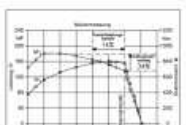
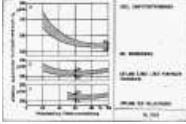



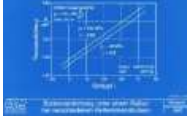





| | | |
|---|---|---|
|  <p>AT-0229_1(2) id=721927 00042072.tif</p> |  <p>AT-0230_1(2) id=729197 00049837.tif</p> |  <p>AT-0231_1(2) id=730466 00051277.tif</p> |
|  <p>AT-0232_1(2) id=730831 912162.png</p> |  <p>AT-0233_1(1) id=12160 00000936.tif</p> |  <p>AT-0234_1(1) id=12190 00001131.tif</p> |
|  <p>AT-0235_1(1) id=12341 00002558.tif</p> |  <p>AT-0236_1(1) id=12351 00002685.tif</p> |  <p>AT-0237_1(1) id=14107 00016141.tif</p> |
|  <p>AT-0238_1(1) id=14239 00017133.tif</p> |  <p>AT-0239_1(1) id=14240 00017155.tif</p> |  <p>AT-0240_1(1) id=14284 00017674.tif</p> |
|  <p>AT-0241_1(1) id=14285 00017676.tif</p> |  <p>AT-0242_1(1) id=14389 00018578.tif</p> |  <p>AT-0243_1(1) id=14438 00019067.tif</p> |
|  <p>AT-0244_1(1) id=14638 00021377.tif</p> |  <p>AT-0245_1(1) id=14640 00021392.tif</p> |  <p>AT-0246_1(1) id=14670 00021738.tif</p> |
|  <p>AT-0247_1(1) id=14770 00023092.tif</p> |  <p>AT-0248_1(1) id=14795 00023264.tif</p> |  <p>AT-0249_1(1) id=14839 00023322.tif</p> |











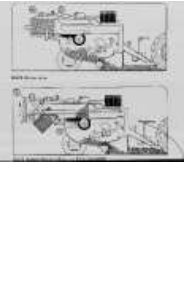

|  | AT-0250_1(1) id=15191 00025508.tif |  <table border="1"> <thead> <tr> <th>Motor Typ</th> <th>Leistung [kW]</th> <th>Umschalt- zeitpunkt [min]</th> <th>Umschalt- leistung [kW]</th> <th>Umschalt- zeitpunkt [min]</th> </tr> </thead> <tbody> <tr> <td>1 100</td> <td>12,0</td> <td>10/10</td> <td>0,15</td> <td>0,10</td> </tr> <tr> <td>1 100</td> <td>12,0</td> <td>10/10</td> <td>0,20</td> <td>0,10</td> </tr> <tr> <td>1 100</td> <td>12,0</td> <td>10/10</td> <td>0,25</td> <td>0,10</td> </tr> <tr> <td>1 100</td> <td>12,0</td> <td>10/10</td> <td>0,30</td> <td>0,10</td> </tr> <tr> <td>1 100</td> <td>12,0</td> <td>10/10</td> <td>0,35</td> <td>0,10</td> </tr> <tr> <td>1 100</td> <td>12,0</td> <td>10/10</td> <td>0,40</td> <td>0,10</td> </tr> <tr> <td>1 100</td> <td>12,0</td> <td>10/10</td> <td>0,45</td> <td>0,10</td> </tr> <tr> <td>1 100</td> <td>12,0</td> <td>10/10</td> <td>0,50</td> <td>0,10</td> </tr> </tbody> </table> | Motor Typ | Leistung [kW] | Umschalt- zeitpunkt [min] | Umschalt- leistung [kW] | Umschalt- zeitpunkt [min] | 1 100 | 12,0 | 10/10 | 0,15 | 0,10 | 1 100 | 12,0 | 10/10 | 0,20 | 0,10 | 1 100 | 12,0 | 10/10 | 0,25 | 0,10 | 1 100 | 12,0 | 10/10 | 0,30 | 0,10 | 1 100 | 12,0 | 10/10 | 0,35 | 0,10 | 1 100 | 12,0 | 10/10 | 0,40 | 0,10 | 1 100 | 12,0 | 10/10 | 0,45 | 0,10 | 1 100 | 12,0 | 10/10 | 0,50 | 0,10 | AT-0251_1(1) id=15865 00032306.tif |  | AT-0252_1(1) id=638174 hub-01883.tif |
|---|--|---|--|---|--|-------------------------------|---------------------------------|-------|------|-------|------|------|-------|------|-------|------|------|-------|------|-------|------|------|-------|------|-------|------|------|-------|------|-------|------|------|-------|------|-------|------|------|-------|------|-------|------|------|-------|------|-------|------|------|--|---|--|
| Motor Typ | Leistung [kW] | Umschalt- zeitpunkt [min] | Umschalt- leistung [kW] | Umschalt- zeitpunkt [min] | | | | | | | | | | | | | | | | | | | | | | | | | | | | | | | | | | | | | | | | | | | | | | |
| 1 100 | 12,0 | 10/10 | 0,15 | 0,10 | | | | | | | | | | | | | | | | | | | | | | | | | | | | | | | | | | | | | | | | | | | | | | |
| 1 100 | 12,0 | 10/10 | 0,20 | 0,10 | | | | | | | | | | | | | | | | | | | | | | | | | | | | | | | | | | | | | | | | | | | | | | |
| 1 100 | 12,0 | 10/10 | 0,25 | 0,10 | | | | | | | | | | | | | | | | | | | | | | | | | | | | | | | | | | | | | | | | | | | | | | |
| 1 100 | 12,0 | 10/10 | 0,30 | 0,10 | | | | | | | | | | | | | | | | | | | | | | | | | | | | | | | | | | | | | | | | | | | | | | |
| 1 100 | 12,0 | 10/10 | 0,35 | 0,10 | | | | | | | | | | | | | | | | | | | | | | | | | | | | | | | | | | | | | | | | | | | | | | |
| 1 100 | 12,0 | 10/10 | 0,40 | 0,10 | | | | | | | | | | | | | | | | | | | | | | | | | | | | | | | | | | | | | | | | | | | | | | |
| 1 100 | 12,0 | 10/10 | 0,45 | 0,10 | | | | | | | | | | | | | | | | | | | | | | | | | | | | | | | | | | | | | | | | | | | | | | |
| 1 100 | 12,0 | 10/10 | 0,50 | 0,10 | | | | | | | | | | | | | | | | | | | | | | | | | | | | | | | | | | | | | | | | | | | | | | |
|  | AT-0253_1(1) id=638207 hub-03221.tif |  | AT-0254_1(1) id=638462 hub-00833.tif |  | AT-0255_1(1) id=638904 hub-11549.tif | | | | | | | | | | | | | | | | | | | | | | | | | | | | | | | | | | | | | | | | | | | | | |
|  | AT-0256_1(1) id=639555 hub-10851.tif |  | AT-0257_1(1) id=639702 hub-01992.tif |  | AT-0258_1(1) id=640091 hub-04578.tif | | | | | | | | | | | | | | | | | | | | | | | | | | | | | | | | | | | | | | | | | | | | | |
|  | AT-0259_1(1) id=640092 hub-04577.tif |  | AT-0260_1(1) id=640349 hub-03355.tif |  | AT-0261_1(1) id=640937 hub-01155.tif | | | | | | | | | | | | | | | | | | | | | | | | | | | | | | | | | | | | | | | | | | | | | |
|  | AT-0262_1(1) id=641044 hub-03405.tif |  | AT-0263_1(1) id=641179 hub-02202.tif |  | AT-0264_1(1) id=641493 hub-05317.tif | | | | | | | | | | | | | | | | | | | | | | | | | | | | | | | | | | | | | | | | | | | | | |
|  | AT-0265_1(1) id=642624 hub-04016.tif |  | AT-0266_1(1) id=642632 hub-00794.tif |  | AT-0267_1(1) id=694844 00006500.tif | | | | | | | | | | | | | | | | | | | | | | | | | | | | | | | | | | | | | | | | | | | | | |
|  | AT-0268_1(1) id=695021 00006709.tif |  | AT-0269_1(1) id=695422 00007195.tif |  | AT-0270_1(1) id=696587 00008276.tif | | | | | | | | | | | | | | | | | | | | | | | | | | | | | | | | | | | | | | | | | | | | | |
|  | AT-0271_1(1) id=696702 00008411.tif |  | AT-0272_1(1) id=699967 00013505.tif |  | AT-0273_1(1) id=700758 00014804.tif | | | | | | | | | | | | | | | | | | | | | | | | | | | | | | | | | | | | | | | | | | | | | |
|  | AT-0274_1(1) id=700823 00014868.tif |  | AT-0275_1(1) id=701274 00015329.tif |  | AT-0276_1(1) id=702086 00016406.tif | | | | | | | | | | | | | | | | | | | | | | | | | | | | | | | | | | | | | | | | | | | | | |

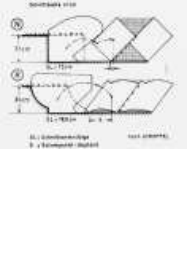

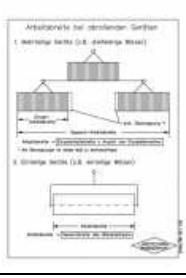
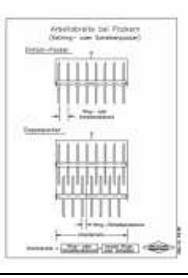
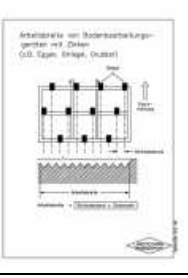
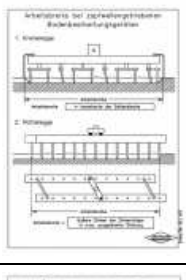
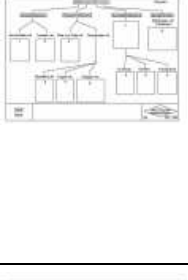
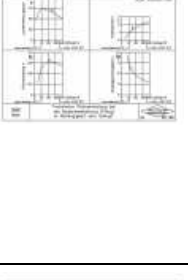
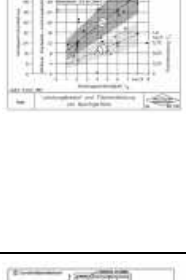
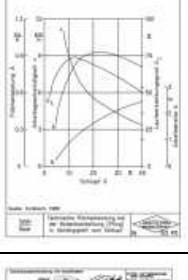
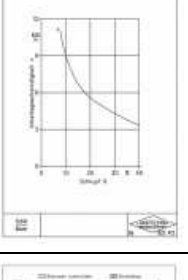
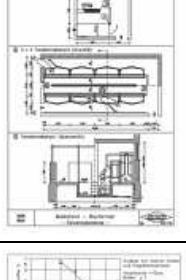



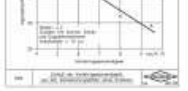



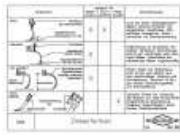
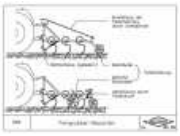
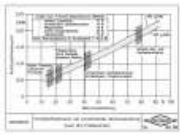

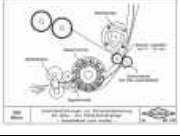
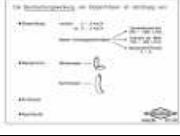
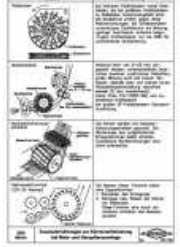



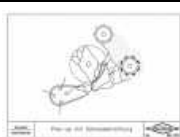
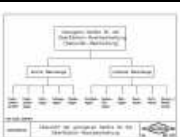

| | | | | | |
|---|---|---|---|---|---|
|  | AT-0277_1(1) id=702249 00016562.tif |  | AT-0278_1(1) id=702278 00016588.tif |  | AT-0279_1(1) id=702605 00016995.tif |
|  | AT-0280_1(1) id=702767 00017226.tif |  | AT-0281_1(1) id=702779 00017248.tif |  | AT-0282_1(1) id=702929 00017666.tif |
|  | AT-0283_1(1) id=702943 00017693.tif |  | AT-0284_1(1) id=703021 00017837.tif |  | AT-0285_1(1) id=703596 00018504.tif |
|  | AT-0286_1(1) id=703671 00018606.tif |  | AT-0287_1(1) id=703912 00018910.tif |  | AT-0288_1(1) id=703939 00018951.tif |
|  | AT-0289_1(1) id=704243 00019368.tif |  | AT-0290_1(1) id=704508 00019714.tif |  | AT-0291_1(1) id=704570 00019787.tif |
|  | AT-0292_1(1) id=704629 00019874.tif |  | AT-0293_1(1) id=704630 00019876.tif |  | AT-0294_1(1) id=704631 00019877.tif |
|  | AT-0295_1(1) id=704684 00019949.tif |  | AT-0296_1(1) id=704728 00020006.tif |  | AT-0297_1(1) id=705127 00020522.tif |

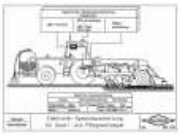
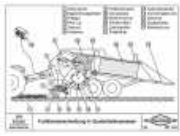

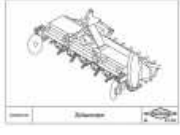

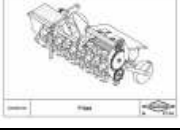
| | | | | | |
|---|---|---|---|---|---|
|  | AT-0298_1(1) id=705275 00020714.tif |  | AT-0299_1(1) id=705592 00021142.tif |  | AT-0300_1(1) id=705598 00021148.tif |
|  | AT-0301_1(1) id=705625 00021194.tif |  | AT-0302_1(1) id=705755 942195.png |  | AT-0303_1(1) id=705760 962187.png |
|  | AT-0304_1(1) id=705766 00021383.tif |  | AT-0305_1(1) id=705774 00021398.tif |  | AT-0306_1(1) id=705930 00021599.tif |
|  | AT-0307_1(1) id=706110 00021823.tif |  | AT-0308_1(1) id=706174 00021911.tif |  | AT-0309_1(1) id=706805 00022824.tif |
|  | AT-0310_1(1) id=706858 00022899.tif |  | AT-0311_1(1) id=706922 00022980.tif |  | AT-0312_1(1) id=706979 00023056.tif |
|  | AT-0313_1(1) id=707931 00024489.tif |  | AT-0314_1(1) id=708641 00025756.tif |  | AT-0315_1(1) id=709459 00027026.tif |
|  | AT-0316_1(1) id=709461 952428.png |  | AT-0317_1(1) id=711457 00030111.tif |  | AT-0318_1(1) id=711802 00030504.tif |

| | | | | | |
|---|---|---|---|---|---|
|  | AT-0319_1(1) id=711836 00030540.tif |  | AT-0320_1(1) id=712518 00031306.tif |  | AT-0321_1(1) id=712545 00031345.tif |
|  | AT-0322_1(1) id=712630 00031474.tif |  | AT-0323_1(1) id=712638 952070.png |  | AT-0324_1(1) id=712640 952071.png |
|  | AT-0325_1(1) id=712744 00031607.tif |  | AT-0326_1(1) id=712831 00031696.tif |  | AT-0327_1(1) id=712879 00031745.tif |
|  | AT-0328_1(1) id=713213 00032104.tif |  | AT-0329_1(1) id=713315 00032216.tif |  | AT-0330_1(1) id=713351 00032256.tif |
|  | AT-0331_1(1) id=714172 00033124.tif |  | AT-0332_1(1) id=714257 00033220.tif |  | AT-0333_1(1) id=714847 00033961.tif |
|  | AT-0334_1(1) id=714853 00033967.tif |  | AT-0335_1(1) id=715154 00034306.tif |  | AT-0336_1(1) id=715420 00034616.tif |
|  | AT-0337_1(1) id=715772 00035010.tif |  | AT-0338_1(1) id=716580 972095.png |  | AT-0339_1(1) id=716602 972082.png |
|  | AT-0340_1(1) id=716797 00036291.tif |  | AT-0341_1(1) id=717045 00036547.tif |  | AT-0342_1(1) id=718015 00037601.tif |
|  | AT-0343_1(1) id=718526 00038142.tif |  | AT-0344_1(1) id=718844 00038480.tif |  | AT-0345_1(1) id=718928 00038577.tif |

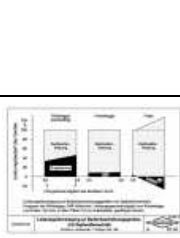
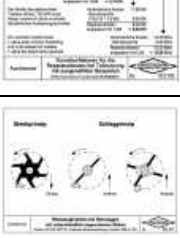
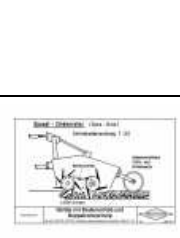
| | | | | | |
|---|---|---|---|--|---|
|  | AT-0346_1(1) id=719609 00039309.tif |  | AT-0347_1(1) id=720699 00040508.tif |  1950 Alfawerk Nr. 3 | AT-0348_1(1) id=721313 00041217.tif |
|  | AT-0349_1(1) id=721466 00041411.tif |  | AT-0350_1(1) id=721467 00041412.tif |  | AT-0351_1(1) id=721490 00041436.tif |
|  | AT-0352_1(1) id=721632 00041723.tif |  | AT-0353_1(1) id=721916 00042060.tif |  | AT-0354_1(1) id=722384 00042556.tif |
|  | AT-0355_1(1) id=722503 00042687.tif |  | AT-0356_1(1) id=722742 00042964.tif |  | AT-0357_1(1) id=722929 00043180.tif |
|  | AT-0358_1(1) id=723171 00043449.tif |  | AT-0359_1(1) id=724019 00044356.tif |  | AT-0360_1(1) id=724572 00044959.tif |
|  | AT-0361_1(1) id=725229 00045643.tif |  | AT-0362_1(1) id=725524 00045948.tif |  | AT-0363_1(1) id=726547 00047056.tif |
|  | AT-0364_1(1) id=727427 00047960.tif |  | AT-0365_1(1) id=728464 00049035.tif |  | AT-0366_1(1) id=728498 00049070.tif |
|  | AT-0367_1(1) id=728510 00049082.tif |  | AT-0368_1(1) id=728549 00049123.tif |  | AT-0369_1(1) id=728691 00049273.tif |
|  | AT-0370_1(1) id=728692 00049274.tif |  | AT-0371_1(1) id=728770 00049363.tif |  | AT-0372_1(1) id=728803 00049401.tif |

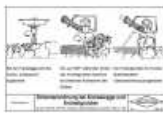
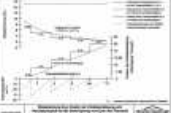
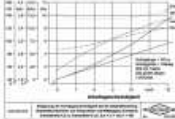
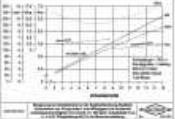
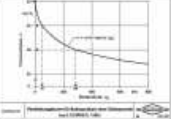
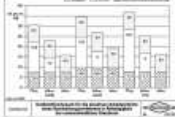
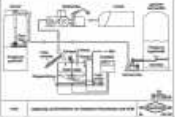
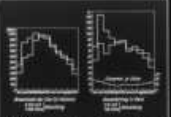
| | | | | | |
|---|--|---|--|---|--|
|  | <p>AT-0373_1(1) id=728811 00049407.tif</p> |  | <p>AT-0374_1(1) id=729272 00049923.tif</p> |  | <p>AT-0375_1(1) id=730329 00051086.tif</p> |
|  | <p>AT-0376_1(1) id=730516 00051325.tif</p> |  | <p>AT-0377_1(1) id=730650 00051500.tif</p> |  | <p>AT-0378_1(1) id=730739 00051593.tif</p> |
|  | <p>AT-0379_1(1) id=730828 912159.png</p> |  | <p>AT-0380_1(1) id=730829 912160.png</p> |  | <p>AT-0381_1(1) id=730830 912161.png</p> |
|  | <p>AT-0382_1(1) id=730832 912163.png</p> |  | <p>AT-0383_1(1) id=730843 912249.png</p> |  | <p>AT-0384_1(1) id=730966 922065.png</p> |
|  | <p>AT-0385_1(1) id=730971 922079.png</p> |  | <p>AT-0386_1(1) id=731132 922410.png</p> |  | <p>AT-0387_1(1) id=731135 922413.png</p> |
|  | <p>AT-0388_1(1) id=731218 932134.png</p> |  | <p>AT-0389_1(1) id=731332 932344.png</p> |  | <p>AT-0390_1(1) id=731488 942204.png</p> |
|  | <p>AT-0391_1(1) id=731662 952093.png</p> |  | <p>AT-0392_1(1) id=731768 952272.png</p> |  | <p>AT-0393_1(1) id=731819 952330.png</p> |

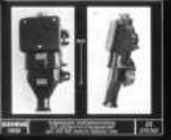





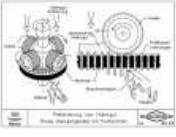
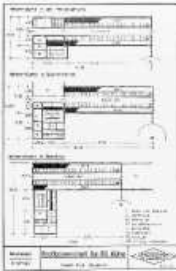





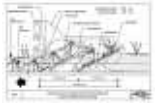
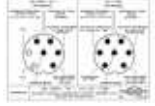
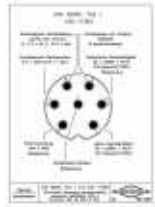



| | | | | | |
|---|---|---|---|---|---|
|  | AT-0394_1(1) id=732081 962186.png |  | AT-0395_1(1) id=732087 962199.png |  | AT-0396_1(1) id=732096 962209.png |
|  | AT-0397_1(1) id=732099 962213.png |  | AT-0398_1(1) id=732118 962240.png |  | AT-0399_1(1) id=732280 972016.png |
|  | AT-0400_1(1) id=732370 972168.png |  | AT-0401_1(1) id=732621 972520.png |  | AT-0402_1(1) id=732808 982214.png |
|  | AT-0403_1(1) id=732809 982215.png |  | AT-0404_1(1) id=732821 982236.png |  | AT-0405_1(1) id=732849 982266.png |
|  | AT-0406_1(1) id=732964 992025.png |  | AT-0407_1(1) id=732973 992035.png |  | AT-0408_1(1) id=732997 992063.png |
|  | AT-0409_1(1) id=733116 992193.png |  | AT-0410_1(1) id=733169 002034.png |  | AT-0411_1(1) id=733179 002044.png |
|  | AT-0412_1(1) id=733190 002055.png |  | AT-0413_1(1) id=733240 002106.png |  | AT-0414_1(1) id=733385 012049.png |
|  | AT-0415_1(1) id=733388 012052.png |  | AT-0416_1(1) id=733392 012056.png |  | AT-0417_1(1) id=733397 012061.png |
|  | AT-0418_1(1) id=733398 012062.png |  | AT-0419_1(1) id=733438 012103.png |  | AT-0420_1(1) id=733610 022031.png |
|  | AT-0421_1(1) id=733769 022206.png |  | AT-0422_1(1) id=733770 022207.png |  | AT-0423_1(1) id=733777 022214.png |

|  | <p>AT-0424_1(1) id=733778 022215.png</p> | <table border="1"> <thead> <tr> <th colspan="5">Mit Elektroheizung</th> </tr> <tr> <th>Abnehmer</th> <th>Verbrauch</th> <th>Strompreis</th> <th>Stromkosten</th> <th>Stromkosten pro kWh</th> </tr> </thead> <tbody> <tr> <td>Weg</td> <td>1000 kWh</td> <td>0,10 €</td> <td>100,00 €</td> <td>0,10 €</td> </tr> <tr> <td>Weg</td> <td>2000 kWh</td> <td>0,10 €</td> <td>200,00 €</td> <td>0,10 €</td> </tr> <tr> <td>Weg</td> <td>3000 kWh</td> <td>0,10 €</td> <td>300,00 €</td> <td>0,10 €</td> </tr> <tr> <td>Weg</td> <td>4000 kWh</td> <td>0,10 €</td> <td>400,00 €</td> <td>0,10 €</td> </tr> <tr> <td>Weg</td> <td>5000 kWh</td> <td>0,10 €</td> <td>500,00 €</td> <td>0,10 €</td> </tr> <tr> <td>Weg</td> <td>6000 kWh</td> <td>0,10 €</td> <td>600,00 €</td> <td>0,10 €</td> </tr> <tr> <td>Weg</td> <td>7000 kWh</td> <td>0,10 €</td> <td>700,00 €</td> <td>0,10 €</td> </tr> <tr> <td>Weg</td> <td>8000 kWh</td> <td>0,10 €</td> <td>800,00 €</td> <td>0,10 €</td> </tr> <tr> <td>Weg</td> <td>9000 kWh</td> <td>0,10 €</td> <td>900,00 €</td> <td>0,10 €</td> </tr> <tr> <td>Weg</td> <td>10000 kWh</td> <td>0,10 €</td> <td>1000,00 €</td> <td>0,10 €</td> </tr> </tbody> </table> | Mit Elektroheizung | | | | | Abnehmer | Verbrauch | Strompreis | Stromkosten | Stromkosten pro kWh | Weg | 1000 kWh | 0,10 € | 100,00 € | 0,10 € | Weg | 2000 kWh | 0,10 € | 200,00 € | 0,10 € | Weg | 3000 kWh | 0,10 € | 300,00 € | 0,10 € | Weg | 4000 kWh | 0,10 € | 400,00 € | 0,10 € | Weg | 5000 kWh | 0,10 € | 500,00 € | 0,10 € | Weg | 6000 kWh | 0,10 € | 600,00 € | 0,10 € | Weg | 7000 kWh | 0,10 € | 700,00 € | 0,10 € | Weg | 8000 kWh | 0,10 € | 800,00 € | 0,10 € | Weg | 9000 kWh | 0,10 € | 900,00 € | 0,10 € | Weg | 10000 kWh | 0,10 € | 1000,00 € | 0,10 € | <p>AT-0425_1(1) id=733833 022272.png</p> |  | <p>AT-0426_1(1) id=733898 032004.png</p> |
|--|---|--|---|---|---|--|--|----------|-----------|------------|-------------|---------------------|-----|----------|--------|----------|--------|-----|----------|--------|----------|--------|-----|----------|--------|----------|--------|-----|----------|--------|----------|--------|-----|----------|--------|----------|--------|-----|----------|--------|----------|--------|-----|----------|--------|----------|--------|-----|----------|--------|----------|--------|-----|----------|--------|----------|--------|-----|-----------|--------|-----------|--------|--|---|--|
| Mit Elektroheizung | | | | | | | | | | | | | | | | | | | | | | | | | | | | | | | | | | | | | | | | | | | | | | | | | | | | | | | | | | | | | | | | | |
| Abnehmer | Verbrauch | Strompreis | Stromkosten | Stromkosten pro kWh | | | | | | | | | | | | | | | | | | | | | | | | | | | | | | | | | | | | | | | | | | | | | | | | | | | | | | | | | | | | | |
| Weg | 1000 kWh | 0,10 € | 100,00 € | 0,10 € | | | | | | | | | | | | | | | | | | | | | | | | | | | | | | | | | | | | | | | | | | | | | | | | | | | | | | | | | | | | | |
| Weg | 2000 kWh | 0,10 € | 200,00 € | 0,10 € | | | | | | | | | | | | | | | | | | | | | | | | | | | | | | | | | | | | | | | | | | | | | | | | | | | | | | | | | | | | | |
| Weg | 3000 kWh | 0,10 € | 300,00 € | 0,10 € | | | | | | | | | | | | | | | | | | | | | | | | | | | | | | | | | | | | | | | | | | | | | | | | | | | | | | | | | | | | | |
| Weg | 4000 kWh | 0,10 € | 400,00 € | 0,10 € | | | | | | | | | | | | | | | | | | | | | | | | | | | | | | | | | | | | | | | | | | | | | | | | | | | | | | | | | | | | | |
| Weg | 5000 kWh | 0,10 € | 500,00 € | 0,10 € | | | | | | | | | | | | | | | | | | | | | | | | | | | | | | | | | | | | | | | | | | | | | | | | | | | | | | | | | | | | | |
| Weg | 6000 kWh | 0,10 € | 600,00 € | 0,10 € | | | | | | | | | | | | | | | | | | | | | | | | | | | | | | | | | | | | | | | | | | | | | | | | | | | | | | | | | | | | | |
| Weg | 7000 kWh | 0,10 € | 700,00 € | 0,10 € | | | | | | | | | | | | | | | | | | | | | | | | | | | | | | | | | | | | | | | | | | | | | | | | | | | | | | | | | | | | | |
| Weg | 8000 kWh | 0,10 € | 800,00 € | 0,10 € | | | | | | | | | | | | | | | | | | | | | | | | | | | | | | | | | | | | | | | | | | | | | | | | | | | | | | | | | | | | | |
| Weg | 9000 kWh | 0,10 € | 900,00 € | 0,10 € | | | | | | | | | | | | | | | | | | | | | | | | | | | | | | | | | | | | | | | | | | | | | | | | | | | | | | | | | | | | | |
| Weg | 10000 kWh | 0,10 € | 1000,00 € | 0,10 € | | | | | | | | | | | | | | | | | | | | | | | | | | | | | | | | | | | | | | | | | | | | | | | | | | | | | | | | | | | | | |
|  | <p>AT-0427_1(1) id=733951 032059.png</p> |  | <p>AT-0428_1(1) id=733953 032061.png</p> |  | <p>AT-0429_1(1) id=734081 032200.png</p> | | | | | | | | | | | | | | | | | | | | | | | | | | | | | | | | | | | | | | | | | | | | | | | | | | | | | | | | | | | | |
|  | <p>AT-0430_1(1) id=734083 032202.png</p> |  | <p>AT-0431_1(1) id=734353 062009.png</p> |  | <p>AT-0432_1(1) id=1208361 00052114.tif</p> | | | | | | | | | | | | | | | | | | | | | | | | | | | | | | | | | | | | | | | | | | | | | | | | | | | | | | | | | | | | |
|  | <p>AT-0433_1(1) id=1208373 00052073.tif</p> |  | <p>AT-0434_1(1) id=1208374 00052124.tif</p> |  | <p>AT-0435_1(1) id=1208375 00052105.tif</p> | | | | | | | | | | | | | | | | | | | | | | | | | | | | | | | | | | | | | | | | | | | | | | | | | | | | | | | | | | | | |
|  | <p>AT-0436_1(1) id=1208376 00052186.tif</p> | | | | | | | | | | | | | | | | | | | | | | | | | | | | | | | | | | | | | | | | | | | | | | | | | | | | | | | | | | | | | | | | |

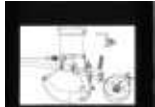

3.3 Bilder-Downloads 2014: BA (Bosnien-Herzegowina)

| <i>Bild</i> | <i>Kennwerte</i> | <i>Bild</i> | <i>Kennwerte</i> | <i>Bild</i> | <i>Kennwerte</i> |
|---|---|---|--|-------------|------------------|
|  | BA-0001_1(8) id=732174 962312.png |  | BA-0002_1(6) id=14419 00018898.tif | | |

3.4 Bilder-Downloads 2014: BE (Belgien)

| <i>Bild</i> | <i>Kennwerte</i> | <i>Bild</i> | <i>Kennwerte</i> | <i>Bild</i> | <i>Kennwerte</i> |
|---|---|---|--|---|--|
|  | BE-0001_22(51) id=717444 00036976.tif |  | BE-0002_3(3) id=643335 hub-10202.tif |  | BE-0003_2(7) id=717443 00036975.tif |
|  | BE-0004_2(3) id=732990 992054.png |  | BE-0005_1(121) id=716664 932287.png |  | BE-0006_1(83) id=731997 962086.png |
|  | BE-0007_1(32) id=710156 932387.png |  | BE-0008_1(21) id=732182 962321.png |  | BE-0009_1(13) id=732888 982307.png |
|  | BE-0010_1(11) id=709457 00027024.tif |  | BE-0011_1(9) id=709464 00027039.tif |  | BE-0012_1(6) id=721833 00041968.tif |
|  | BE-0013_1(5) id=710560 00028911.tif |  | BE-0014_1(5) id=711969 00030682.tif |  | BE-0015_1(4) id=716803 00036297.tif |
|  | BE-0016_1(4) id=713729 00032666.tif |  | BE-0017_1(3) id=717869 00037444.tif |  | BE-0018_1(2) id=643326 hub-01292.tif |
|  | BE-0019_1(1) id=699782 00013208.tif |  | BE-0020_1(1) id=720606 00040409.tif |  | BE-0021_1(1) id=722304 00042469.tif |

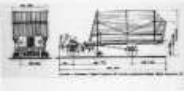
3.5 Bilder-Downloads 2014: BG (Bulgarien)







| <i>Bild</i> | <i>Kennwerte</i> | <i>Bild</i> | <i>Kennwerte</i> | <i>Bild</i> | <i>Kennwerte</i> |
|---|--|---|--|---|---|
|  | BG-0001_3(21) id=732182 962321.png |  | BG-0002_2(10) id=720972 00040829.tif |  | BG-0003_1(3) id=731557 942345.png |
|  | BG-0004_1(1) id=731278 932242.png | | | | |

3.6 Bilder-Downloads 2014: BR (Brasilien)











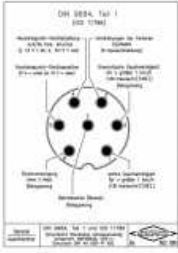
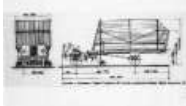



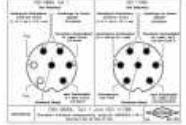

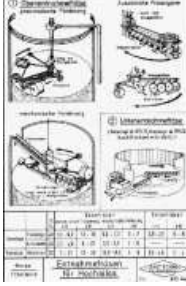
| <i>Bild</i> | <i>Kennwerte</i> | <i>Bild</i> | <i>Kennwerte</i> | <i>Bild</i> | <i>Kennwerte</i> |
|---|---|-------------|------------------|-------------|------------------|
|  | BR-0001_2(131) id=708251 00025123.tif | | | | |

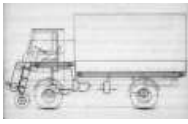





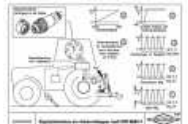





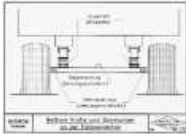



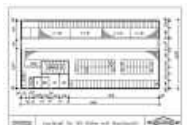

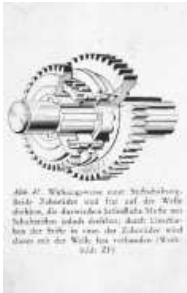
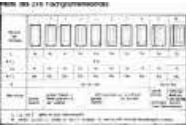
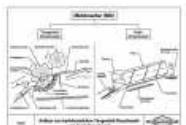
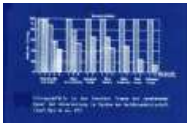
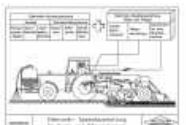
3.7 Bilder-Downloads 2014: CA (Kanada)



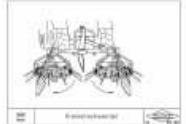

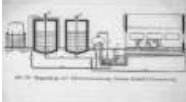
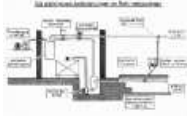



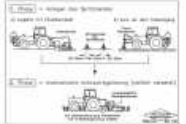









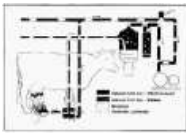

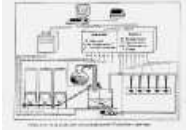
| Bild | Kennwerte | Bild | Kennwerte | Bild | Kennwerte |
|---|---|---|---|---|--|
|  | CA-0001_3(5) id=729490 00050225.tif |  | CA-0002_2(125) id=717109 00036613.tif |  | CA-0003_2(95) id=12277 00001971.tif |
|  | CA-0004_1(65) id=732055 962152.png |  | CA-0005_1(2) id=705283 00020723.tif |  | CA-0006_1(71) id=732043 962138.png |
|  | CA-0007_1(60) id=14044 00015810.tif |  | CA-0008_1(41) id=703578 00018485.tif |  | CA-0009_1(33) id=704610 00019845.tif |
|  | CA-0010_1(32) id=710156 932387.png |  | CA-0011_1(51) id=717444 00036976.tif |  | CA-0012_1(18) id=14052 00015822.tif |
|  | CA-0013_1(9) id=731939 962011.png |  | CA-0014_1(7) id=719070 00038734.tif |  | CA-0015_1(6) id=12395 00003222.tif |
|  | CA-0016_1(11) id=13986 00015701.tif |  | CA-0017_1(5) id=731775 952281.png |  | CA-0018_1(6) id=697598 00009608.tif |
|  | CA-0019_1(3) id=704971 00020313.tif |  | CA-0020_1(2) id=694792 00006438.tif |  | CA-0021_1(2) id=701199 00015249.tif |
|  | CA-0022_1(2) id=701600 00015788.tif |  | CA-0023_1(2) id=709039 00026376.tif |  | CA-0024_1(2) id=720964 00040817.tif |



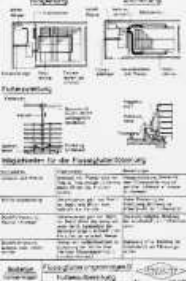
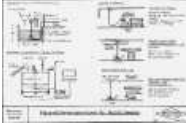
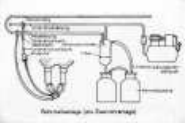

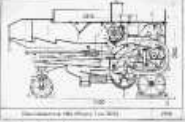







| | | | | | |
|---|---|---|--|---|---|
|  | <p>CA-0025_1(2) id=1198424 00051688.tif</p> |  | <p>CA-0026_1(1) id=14828 00023305.tif</p> |  | <p>CA-0027_1(1) id=642917 hub-01255.tif</p> |
|  | <p>CA-0028_1(1) id=643336 hub-03529.tif</p> |  | <p>CA-0029_1(1) id=704889 00020215.tif</p> |  | <p>CA-0030_1(1) id=719320 00039001.tif</p> |
|  | <p>CA-0031_1(1) id=730023 00050740.tif</p> | | | | |

3.8 Bilder-Downloads 2014: CH (Schweiz)

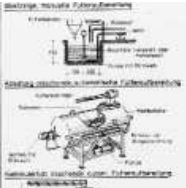
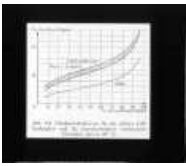
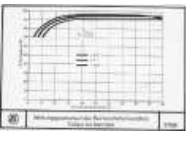



| Bild | Kennwerte | Bild | Kennwerte | Bild | Kennwerte |
|---|---|---|--|---|--|
|  | CH-0001_9(9) id=643007 hub-03401.tif |  | CH-0002_8(83) id=731997 962086.png |  | CH-0003_7(10) id=720972 00040829.tif |
|  | CH-0004_5(41) id=733193 002058.png |  | CH-0005_4(8) id=720690 00040498.tif |  | CH-0006_4(5) id=694756 00006396.tif |
|  | CH-0007_3(121) id=716664 932287.png |  | CH-0008_3(5) id=15822 00029717.tif |  | CH-0009_3(6) id=13077 00008535.tif |
|  | CH-0010_3(6) id=701166 00015210.tif |  | CH-0011_3(3) id=694938 00006602.tif |  | CH-0012_3(3) id=817170 DSC03737.JPG |
|  | CH-0013_2(125) id=717109 00036613.tif |  | CH-0014_2(14) id=724336 00044701.tif |  | CH-0015_2(6) id=720782 00040603.tif |
|  | CH-0016_2(5) id=701901 00016187.tif |  | CH-0017_2(5) id=732576 972471.png |  | CH-0018_2(4) id=641199 hub-00827.tif |

| | | | | | |
|---|--|---|--|---|--|
|  | CH-0019_2(3) id=699999 00013539.tif |  | CH-0020_2(3) id=700421 00014327.tif |  | CH-0021_2(2) id=708588 00025678.tif |
|  | CH-0022_2(2) id=708999 00026321.tif |  | CH-0023_2(2) id=729241 00049890.tif |  | CH-0024_1(58) id=729097 00049735.tif |
|  | CH-0025_1(43) id=12665 00004609.tif |  | CH-0026_1(37) id=731745 952239.png |  | CH-0027_1(27) id=730653 00051504.tif |
|  | CH-0028_1(37) id=14404 00018713.tif |  | CH-0029_1(32) id=12981 00007302.tif |  | CH-0030_1(33) id=704610 00019845.tif |
|  | CH-0031_1(15) id=733519 012184.png |  | CH-0032_1(13) id=702243 00016553.tif |  | CH-0033_1(11) id=708543 912119.png |
|  | CH-0034_1(8) id=12332 00002487.tif |  | CH-0035_1(7) id=702085 00016405.tif |  | CH-0036_1(10) id=720987 00040846.tif |
|  | CH-0037_1(6) id=731173 932062.png |  | CH-0038_1(9) id=12090 00000563.tif |  | CH-0039_1(6) id=15297 00026743.tif |
|  | CH-0040_1(6) id=695408 00007177.tif |  | CH-0041_1(5) id=728392 00048955.tif |  | CH-0042_1(4) id=642021 hub-00094.tif |
|  | CH-0043_1(4) id=642901 hub-03325.tif |  | CH-0044_1(4) id=643216 hub-02592.tif |  | CH-0045_1(4) id=700673 922276.png |

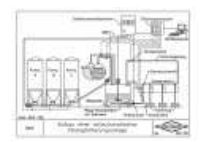
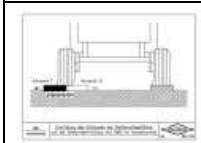
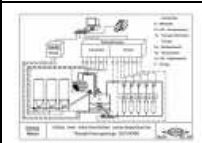
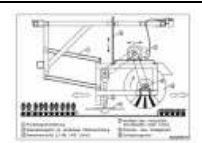

| | | | | | |
|---|--|---|--|---|--|
|  | CH-0046_1(4) id=713573 00032506.tif |  | CH-0047_1(4) id=720632 00040437.tif |  | CH-0048_1(3) id=12756 00005190.tif |
|  | CH-0049_1(3) id=638456 hub-02891.tif |  | CH-0050_1(3) id=638953 hub-00992.tif |  | CH-0051_1(3) id=701230 00015282.tif |
|  | CH-0052_1(3) id=706444 00022308.tif |  | CH-0053_1(3) id=721547 00041496.tif |  | CH-0054_1(3) id=728591 00049167.tif |
|  | CH-0055_1(3) id=728728 00049314.tif |  | CH-0056_1(3) id=732577 972472.png |  | CH-0057_1(4) id=641177 hub-00154.tif |
|  | CH-0058_1(2) id=14126 00016228.tif |  | CH-0059_1(2) id=14514 00019863.tif |  | CH-0060_1(2) id=699721 00013137.tif |
|  | CH-0061_1(2) id=699998 00013538.tif |  | CH-0062_1(2) id=700500 00014511.tif |  | CH-0063_1(2) id=701904 00016191.tif |
|  | CH-0064_1(2) id=701916 00016192.tif |  | CH-0065_1(2) id=704622 00019860.tif |  | CH-0066_1(2) id=713267 00032164.tif |
|  | CH-0067_1(2) id=719583 00039282.tif |  | CH-0068_1(2) id=720319 00040111.tif |  | CH-0069_1(2) id=720643 00040448.tif |
|  | CH-0070_1(2) id=720974 00040831.tif |  | CH-0071_1(2) id=720983 00040842.tif |  | CH-0072_1(2) id=720984 00040843.tif |

| | | | | | |
|---|--|---|--|---|--|
|  | CH-0073_1(2) id=720985 00040844.tif |  | CH-0074_1(2) id=720994 00040853.tif |  | CH-0075_1(2) id=720995 00040854.tif |
|  | CH-0076_1(2) id=720998 00040857.tif |  | CH-0077_1(2) id=724317 00044682.tif |  | CH-0078_1(2) id=732504 972368.png |
|  | CH-0079_1(2) id=733860 022299.png |  | CH-0080_1(3) id=731194 932097.png |  | CH-0081_1(2) id=640440 hub-04373.tif |
|  | CH-0082_1(2) id=716052 00035376.tif |  | CH-0083_1(1) id=12929 00006658.tif |  | CH-0084_1(1) id=12983 00007315.tif |
|  | CH-0085_1(1) id=13276 00010359.tif |  | CH-0086_1(1) id=14032 00015781.tif |  | CH-0087_1(1) id=14119 00016194.tif |
|  | CH-0088_1(1) id=638388 hub-04855.tif |  | CH-0089_1(1) id=640607 hub-03560.tif |  | CH-0090_1(1) id=695055 00006746.tif |
|  | CH-0091_1(1) id=695605 00007449.tif |  | CH-0092_1(1) id=696803 00008584.tif |  | CH-0093_1(1) id=696806 00008587.tif |
|  | CH-0094_1(1) id=697068 00008913.tif |  | CH-0095_1(1) id=697539 00009529.tif |  | CH-0096_1(1) id=697721 00009764.tif |
|  | CH-0097_1(1) id=699572 00012971.tif |  | CH-0098_1(1) id=700387 00014293.tif |  | CH-0099_1(1) id=700401 00014307.tif |

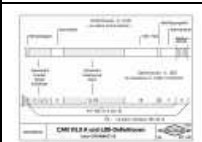
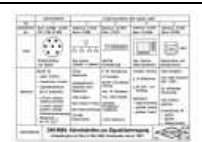
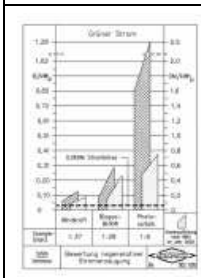
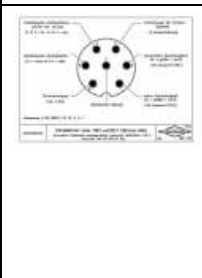
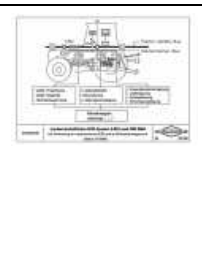



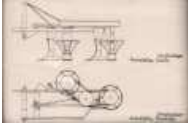

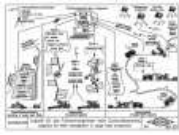

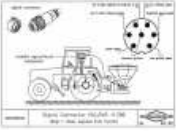
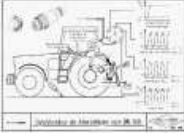
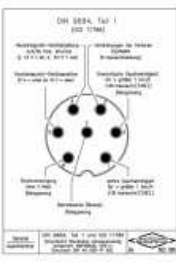
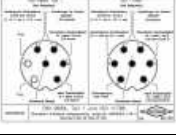

| | | | | | |
|---|---|---|---|---|---|
|  | CH-0100_1(1) id=700407 00014313.tif |  | CH-0101_1(1) id=700935 00015004.tif |  | CH-0102_1(1) id=701940 00016223.tif |
|  | CH-0103_1(1) id=702525 00016885.tif |  | CH-0104_1(1) id=703720 00018668.tif |  | CH-0105_1(1) id=703985 00019016.tif |
|  | CH-0106_1(1) id=704506 00019711.tif |  | CH-0107_1(1) id=706577 00022503.tif |  | CH-0108_1(1) id=706587 00022523.tif |
|  | CH-0109_1(1) id=706772 00022780.tif |  | CH-0110_1(1) id=708607 00025703.tif |  | CH-0111_1(1) id=708658 00025785.tif |
|  | CH-0112_1(1) id=709659 00027418.tif |  | CH-0113_1(1) id=711142 00029725.tif |  | CH-0114_1(1) id=712614 00031450.tif |
|  | CH-0115_1(1) id=713270 00032167.tif |  | CH-0116_1(1) id=715222 00034383.tif |  | CH-0117_1(1) id=717447 00036980.tif |
|  | CH-0118_1(1) id=718052 00037638.tif |  | CH-0119_1(1) id=718057 00037643.tif |  | CH-0120_1(1) id=718069 00037655.tif |
|  | CH-0121_1(1) id=718080 00037666.tif |  | CH-0122_1(1) id=719411 00039096.tif |  | CH-0123_1(1) id=719433 00039118.tif |
|  | CH-0124_1(1) id=720968 00040821.tif |  | CH-0125_1(1) id=720969 00040822.tif |  | CH-0126_1(1) id=721000 00040859.tif |
|  | CH-0127_1(1) id=721048 00040908.tif |  | CH-0128_1(1) id=721057 00040919.tif |  | CH-0129_1(1) id=721401 00041310.tif |

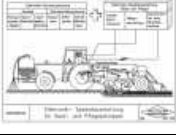
| | | | | | |
|---|--|---|--|---|--|
|  | <p>CH-0130_1(1) id=723714 00044037.tif</p> |  | <p>CH-0131_1(1) id=723773 00044099.tif</p> |  | <p>CH-0132_1(1) id=731432 942100.png</p> |
|  | <p>CH-0133_1(1) id=731635 952034.png</p> |  | <p>CH-0134_1(1) id=731793 952299.png</p> |  | <p>CH-0135_1(1) id=731897 952422.png</p> |
|  | <p>CH-0136_1(1) id=732498 972362.png</p> |  | <p>CH-0137_1(1) id=732562 972440.png</p> |  | <p>CH-0138_1(1) id=733091 992166.png</p> |
|  | <p>CH-0139_1(1) id=733161 002026.png</p> |  | <p>CH-0140_1(1) id=733267 002133.png</p> |  | <p>CH-0141_1(1) id=733798 022235.png</p> |

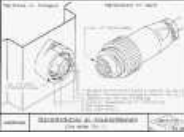



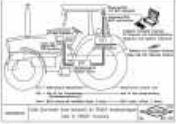

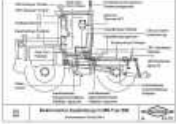



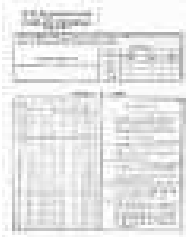

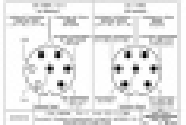









3.9 Bilder-Downloads 2014: CN (China)

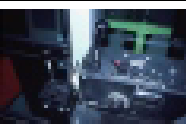





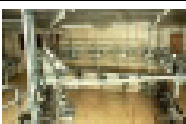



















| <i>Bild</i> | <i>Kennwerte</i> | <i>Bild</i> | <i>Kennwerte</i> | <i>Bild</i> | <i>Kennwerte</i> |
|---|--|---|--|---|---|
|  | CN-0001_3(4) id=13023 00007792.tif |  | CN-0002_1(1) id=640277 hub-01491.tif |  | CN-0003_1(1) id=732651 982037.png |









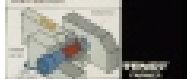





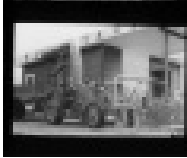













3.10 Bilder-Downloads 2014: CZ (Tschechische Republik)

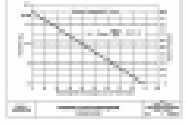

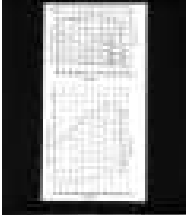















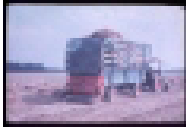

| Bild | Kennwerte | Bild | Kennwerte | Bild | Kennwerte |
|---|---|---|--|---|---|
|  | CZ-0001_5(32) id=710156 932387.png |  | CZ-0002_2(27) id=708542 00025604.tif |  | CZ-0003_1(83) id=731997 962086.png |
|  | CZ-0004_1(121) id=716664 932287.png |  | CZ-0005_1(15) id=720540 00040339.tif |  | CZ-0006_1(11) id=708543 912119.png |
|  | CZ-0007_1(9) id=709464 00027039.tif |  | CZ-0008_1(5) id=709460 00027027.tif |  | CZ-0009_1(6) id=709644 00027381.tif |
|  | CZ-0010_1(3) id=14704 00022010.tif |  | CZ-0011_1(3) id=717728 00037291.tif |  | CZ-0012_1(2) id=722079 00042233.tif |
|  | CZ-0013_1(4) id=732508 972372.png |  | CZ-0014_1(1) id=703045 00017878.tif |  | CZ-0015_1(1) id=733408 012072.png |







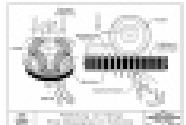
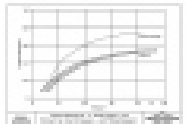













3.11 Bilder-Downloads 2014: DE (Deutschland)







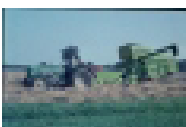





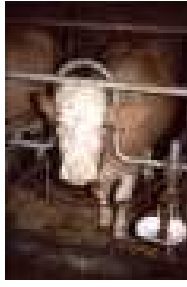













| Bild | Kennwerte | Bild | Kennwerte | Bild | Kennwerte |
|---|---|---|---|---|---|
|  | DE-0001_111(131) id=708251 00025123.tif |  | DE-0002_111(125) id=717109 00036613.tif |  | DE-0003_83(121) id=716664 932287.png |
|  | DE-0004_69(95) id=12277 00001971.tif |  | DE-0005_50(58) id=729097 00049735.tif |  | DE-0006_47(65) id=732055 962152.png |
|  | DE-0007_46(71) id=732043 962138.png |  | DE-0008_39(60) id=14044 00015810.tif |  | DE-0009_38(43) id=12665 00004609.tif |
|  | DE-0010_35(83) id=731997 962086.png |  | DE-0011_34(41) id=703578 00018485.tif |  | DE-0012_28(37) id=731745 952239.png |
|  | DE-0013_24(27) id=730653 00051504.tif |  | DE-0014_23(41) id=733193 002058.png |  | DE-0015_23(37) id=14404 00018713.tif |
|  | DE-0016_23(32) id=12981 00007302.tif |  | DE-0017_21(33) id=704610 00019845.tif |  | DE-0018_21(24) id=15581 00028309.tif |
|  | DE-0019_21(23) id=13353 00010659.tif |  | DE-0020_20(26) id=731940 962012.png |  | DE-0021_20(25) id=730456 00051267.tif |
|  | DE-0022_20(20) id=695190 00006900.tif |  | DE-0023_18(32) id=710156 932387.png |  | DE-0024_18(27) id=708542 00025604.tif |
|  | DE-0025_17(19) id=721500 00041446.tif |  | DE-0026_17(17) id=695088 00006788.tif |  | DE-0027_16(51) id=717444 00036976.tif |



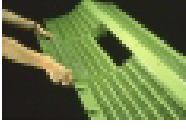



















| | | | | | |
|---|---|---|--|---|---|
|  | DE-0028_16(16) id=14639 00021385.tif |  | DE-0029_15(16) id=640899 hub-02721.tif |  | DE-0030_14(17) id=690286 00000847.tif |
|  | DE-0031_14(15) id=733519 012184.png |  | DE-0032_14(14) id=641727 hub-02351.tif |  | DE-0033_13(15) id=701490 00015619.tif |
|  | DE-0034_13(13) id=711677 00030365.tif |  | DE-0035_12(21) id=732182 962321.png |  | DE-0036_12(20) id=13987 00015704.tif |
|  | DE-0037_12(13) id=14420 00018902.tif |  | DE-0038_12(13) id=690278 00000834.tif |  | DE-0039_12(13) id=702243 00016553.tif |
|  | DE-0040_12(13) id=732888 982307.png |  | DE-0041_12(12) id=692058 00003339.tif |  | DE-0042_12(12) id=711771 00030471.tif |
|  | DE-0043_12(12) id=719618 00039318.tif |  | DE-0044_11(21) id=701340 00015426.tif |  | DE-0045_11(15) id=724349 00044715.tif |
|  | DE-0046_11(14) id=14423 00018932.tif |  | DE-0047_11(13) id=711737 00030433.tif |  | DE-0048_11(11) id=713255 00032152.tif |
|  | DE-0049_11(11) id=720631 00040436.tif |  | DE-0050_10(18) id=14052 00015822.tif |  | DE-0051_10(14) id=14050 00015820.tif |
|  | DE-0052_10(14) id=724336 00044701.tif |  | DE-0053_10(12) id=731942 962014.png |  | DE-0054_10(11) id=717426 00036957.tif |

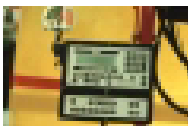

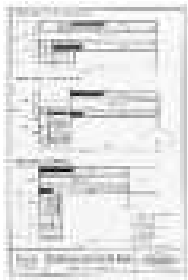





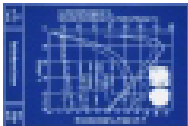

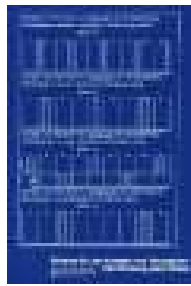



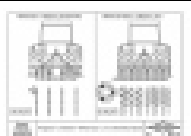
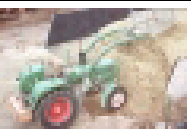

| | | | | | |
|---|---|---|---|---|---|
|  | DE-0055_10(11) id=719575 00039273.tif |  | DE-0056_10(10) id=698047 00010168.tif |  | DE-0057_10(10) id=701273 00015327.tif |
|  | DE-0058_10(10) id=716810 00036304.tif |  | DE-0059_9(11) id=639234 hub-02812.tif |  | DE-0060_9(11) id=695447 00007226.tif |
|  | DE-0061_9(10) id=708767 00025948.tif |  | DE-0062_9(10) id=717794 00037359.tif |  | DE-0063_9(10) id=731820 952331.png |
|  | DE-0064_9(10) id=1198409 00051673.tif |  | DE-0065_9(9) id=694659 00006278.tif |  | DE-0066_9(9) id=695061 00006754.tif |
|  | DE-0067_9(9) id=696114 00008067.tif |  | DE-0068_9(9) id=1198405 00051669.tif |  | DE-0069_8(15) id=725877 00046327.tif |
|  | DE-0070_8(11) id=704103 00019193.tif |  | DE-0071_8(11) id=709457 00027024.tif |  | DE-0072_8(10) id=13992 00015719.tif |
|  | DE-0073_8(10) id=15050 00024548.tif |  | DE-0074_8(10) id=705308 00020750.tif |  | DE-0075_8(9) id=14884 00023440.tif |
|  | DE-0076_8(9) id=734391 072014.png |  | DE-0077_8(8) id=12862 00005935.tif |  | DE-0078_8(8) id=14439 00019076.tif |
|  | DE-0079_8(8) id=642353 hub-02846.tif |  | DE-0080_8(8) id=689659 00000019.tif |  | DE-0081_8(8) id=694789 00006435.tif |
|  | DE-0082_8(8) id=694964 00006631.tif |  | DE-0083_8(8) id=695067 00006759.tif |  | DE-0084_8(8) id=695352 00007105.tif |



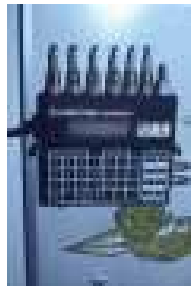

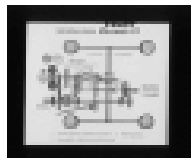
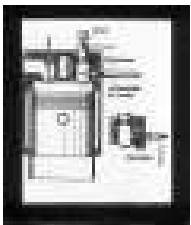
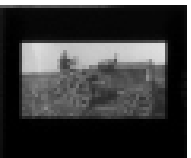











| | | | | | |
|---|---|---|--|---|--|
|  | DE-0085_8(8) id=695385 00007144.tif |  | DE-0086_8(8) id=695457 00007236.tif |  | DE-0087_8(8) id=702331 00016644.tif |
|  | DE-0088_8(8) id=703712 00018659.tif |  | DE-0089_8(8) id=705325 00020771.tif |  | DE-0090_8(8) id=730657 00051508.tif |
|  | DE-0091_7(56) id=638341 hub-04614.tif |  | DE-0092_7(15) id=720540 00040339.tif |  | DE-0093_7(12) id=718032 00037618.tif |
|  | DE-0094_7(11) id=701548 00015683.tif |  | DE-0095_7(10) id=13076 00008529.tif |  | DE-0096_7(8) id=12207 00001207.tif |
|  | DE-0097_7(9) id=690055 00000541.tif |  | DE-0098_7(9) id=712388 00031136.tif |  | DE-0099_7(9) id=717446 00036978.tif |
|  | DE-0100_7(9) id=721900 00042042.tif |  | DE-0101_7(8) id=12076 00000490.tif |  | DE-0102_7(8) id=14718 00022215.tif |
|  | DE-0103_7(8) id=689670 00000038.tif |  | DE-0104_7(8) id=721153 00041034.tif |  | DE-0105_7(8) id=732174 962312.png |
|  | DE-0106_7(8) id=732255 962445.png |  | DE-0107_7(7) id=12044 00000340.tif |  | DE-0108_7(7) id=13368 00010702.tif |







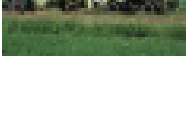













| | | | | | |
|---|--|---|---|---|--|
|  | DE-0109_7(7) id=640888 hub-03235.tif |  | DE-0110_7(7) id=690184 00000726.tif |  | DE-0111_7(7) id=690460 00001055.tif |
|  | DE-0112_7(7) id=695483 00007268.tif |  | DE-0113_7(7) id=695853 00007759.tif |  | DE-0114_7(7) id=696829 00008617.tif |
|  | DE-0115_7(7) id=702764 00017223.tif |  | DE-0116_7(7) id=706028 00021717.tif |  | DE-0117_7(7) id=710413 972155.png |
|  | DE-0118_7(7) id=711318 00029938.tif |  | DE-0119_7(7) id=711461 00030115.tif |  | DE-0120_7(7) id=721362 00041271.tif |
|  | DE-0121_7(7) id=733650 022073.png |  | DE-0122_7(7) id=734272 042085.png |  | DE-0123_6(23) id=731296 932272.png |
|  | DE-0124_6(11) id=15877 00035921.tif |  | DE-0125_6(10) id=14060 00015845.tif |  | DE-0126_6(9) id=731939 962011.png |
|  | DE-0127_6(8) id=14063 00015857.tif |  | DE-0128_6(7) id=711306 00029923.tif |  | DE-0129_6(7) id=715185 00034346.tif |
|  | DE-0130_6(6) id=12435 00003374.tif |  | DE-0131_6(6) id=15572 00028293.tif |  | DE-0132_6(6) id=640794 hub-02625.tif |





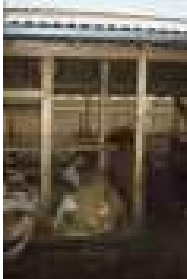







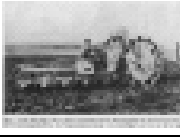

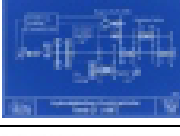



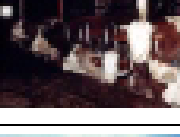







| | | | | | |
|---|--|---|--|---|---|
|  | DE-0133_6(6) id=642385 hub-00169.tif |  | DE-0134_6(6) id=689731 00000112.tif |  | DE-0135_6(6) id=690187 00000730.tif |
|  | DE-0136_6(6) id=690191 00000736.tif |  | DE-0137_6(6) id=694868 00006526.tif |  | DE-0138_6(6) id=695165 00006880.tif |
|  | DE-0139_6(6) id=695178 00006887.tif |  | DE-0140_6(6) id=695188 00006899.tif |  | DE-0141_6(6) id=696482 00008164.tif |
|  | DE-0142_6(6) id=696496 00008180.tif |  | DE-0143_6(6) id=698466 00011048.tif |  | DE-0144_6(6) id=700553 00014572.tif |
|  | DE-0145_6(6) id=700559 00014578.tif |  | DE-0146_6(6) id=706434 00022295.tif |  | DE-0147_6(6) id=715509 00034731.tif |
|  | DE-0148_6(6) id=715952 00035238.tif |  | DE-0149_6(6) id=716743 00036235.tif |  | DE-0150_6(6) id=717880 00037456.tif |
|  | DE-0151_6(6) id=718845 00038481.tif |  | DE-0152_6(6) id=721144 00041025.tif |  | DE-0153_6(6) id=722450 00042624.tif |
|  | DE-0154_6(6) id=723421 00043731.tif |  | DE-0155_6(6) id=731953 962029.png |  | DE-0156_6(6) id=732291 972032.png |
|  | DE-0157_6(6) id=733526 012192.png |  | DE-0158_5(12) id=712027 00030740.tif |  | DE-0159_5(11) id=708543 912119.png |

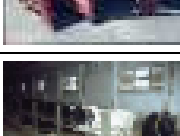

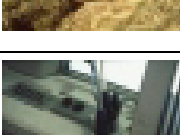

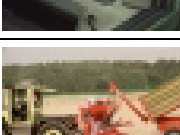
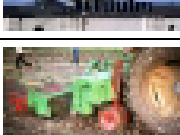





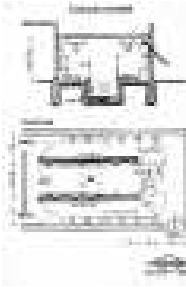
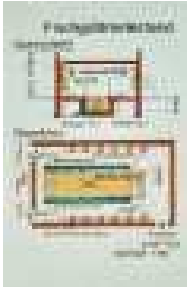









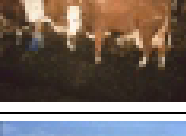

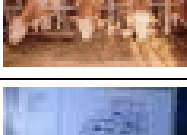

| | | | | | |
|---|--|---|--|---|--|
|  | DE-0160_5(11) id=732937 982365.png |  | DE-0161_5(9) id=14051 00015821.tif |  | DE-0162_5(9) id=709464 00027039.tif |
|  | DE-0163_5(9) id=712631 952069.png |  | DE-0164_5(8) id=12332 00002487.tif |  | DE-0165_5(8) id=705913 00021580.tif |
|  | DE-0166_5(7) id=638752 hub-05360.tif |  | DE-0167_5(7) id=643316 hub-02012.tif |  | DE-0168_5(7) id=702085 00016405.tif |
|  | DE-0169_5(7) id=715862 00035133.tif |  | DE-0170_5(7) id=717443 00036975.tif |  | DE-0171_5(7) id=719070 00038734.tif |
|  | DE-0172_5(6) id=12281 00002001.tif |  | DE-0173_5(6) id=12395 00003222.tif |  | DE-0174_5(6) id=14347 00017915.tif |
|  | DE-0175_5(6) id=14381 00018532.tif |  | DE-0176_5(6) id=14419 00018898.tif |  | DE-0177_5(6) id=638758 hub-03319.tif |
|  | DE-0178_5(6) id=690323 00000889.tif |  | DE-0179_5(6) id=695783 00007672.tif |  | DE-0180_5(6) id=701627 00015844.tif |
|  | DE-0181_5(6) id=703731 00018680.tif |  | DE-0182_5(6) id=704111 00019215.tif |  | DE-0183_5(6) id=705566 00021111.tif |

| | | | | | |
|---|--|---|--|---|--|
|  | DE-0184_5(6) id=705822 00021469.tif |  | DE-0185_5(6) id=712647 00031505.tif |  | DE-0186_5(6) id=715770 00035008.tif |
|  | DE-0187_5(6) id=719103 00038775.tif |  | DE-0188_5(6) id=721833 00041968.tif |  | DE-0189_5(6) id=722484 00042664.tif |
|  | DE-0190_5(6) id=730453 00051264.tif |  | DE-0191_5(6) id=733051 992123.png |  | DE-0192_5(5) id=12158 00000924.tif |
|  | DE-0193_5(5) id=12993 00007417.tif |  | DE-0194_5(5) id=13343 00010610.tif |  | DE-0195_5(5) id=14366 00018354.tif |
|  | DE-0196_5(5) id=14994 00024075.tif |  | DE-0197_5(5) id=15906 00041138.tif |  | DE-0198_5(5) id=638050 hub-00540.tif |
|  | DE-0199_5(5) id=638956 hub-05349.tif |  | DE-0200_5(5) id=639926 hub-00667.tif |  | DE-0201_5(5) id=642842 hub-04541.tif |
|  | DE-0202_5(5) id=689660 00000020.tif |  | DE-0203_5(5) id=689719 00000098.tif |  | DE-0204_5(5) id=690407 00000988.tif |



























| | | | | | |
|---|---|---|---|---|---|
|  | DE-0205_5(5) id=690644 00001288.tif |  | DE-0206_5(5) id=691482 00002508.tif |  | DE-0207_5(5) id=694719 00006343.tif |
|  | DE-0208_5(5) id=694759 00006401.tif |  | DE-0209_5(5) id=694825 00006472.tif |  | DE-0210_5(5) id=695060 00006753.tif |
|  | DE-0211_5(5) id=695090 00006790.tif |  | DE-0212_5(5) id=695220 00006936.tif |  | DE-0213_5(5) id=695451 00007230.tif |
|  | DE-0214_5(5) id=695482 00007266.tif |  | DE-0215_5(5) id=696462 00008141.tif |  | DE-0216_5(5) id=697033 00008867.tif |
|  | DE-0217_5(5) id=698319 00010664.tif |  | DE-0218_5(5) id=698820 00011702.tif |  | DE-0219_5(5) id=701572 002002.png |
|  | DE-0220_5(5) id=703479 00018365.tif |  | DE-0221_5(5) id=703498 00018386.tif |  | DE-0222_5(5) id=703682 00018624.tif |
|  | DE-0223_5(5) id=704033 00019084.tif |  | DE-0224_5(5) id=704483 00019678.tif |  | DE-0225_5(5) id=704700 00019969.tif |
|  | DE-0226_5(5) id=710157 00028193.tif |  | DE-0227_5(5) id=711302 00029919.tif |  | DE-0228_5(5) id=711827 00030530.tif |
|  | DE-0229_5(5) id=713743 00032680.tif |  | DE-0230_5(5) id=715792 00035030.tif |  | DE-0231_5(5) id=716826 00036320.tif |
|  | DE-0232_5(5) id=716827 00036321.tif |  | DE-0233_5(5) id=718033 00037619.tif |  | DE-0234_5(5) id=718862 00038498.tif |

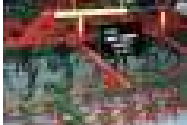





| | | |
|---|--|---|
|  <p>DE-0235_5(5) id=720016 00039757.tif</p> |  <p>DE-0236_5(5) id=720400 00040196.tif</p> |  <p>DE-0237_5(5) id=720599 00040402.tif</p> |
|  <p>DE-0238_5(5) id=720689 00040495.tif</p> |  <p>DE-0239_5(5) id=721066 00040928.tif</p> |  <p>DE-0240_5(5) id=723611 00043931.tif</p> |
|  <p>DE-0241_5(5) id=727583 00048128.tif</p> |  <p>DE-0242_5(5) id=728887 00049497.tif</p> |  <p>DE-0243_5(5) id=729226 00049869.tif</p> |
|  <p>DE-0244_5(5) id=729256 00049907.tif</p> |  <p>DE-0245_5(5) id=731331 932341.png</p> |  <p>DE-0246_5(5) id=731777 952283.png</p> |
|  <p>DE-0247_5(5) id=731950 962026.png</p> |  <p>DE-0248_5(5) id=733637 022060.png</p> |  <p>DE-0249_5(5) id=734146 032265.png</p> |
|  <p>DE-0250_5(5) id=1208362 00052176.tif</p> |  <p>DE-0251_4(11) id=13986 00015701.tif</p> |  <p>DE-0252_4(10) id=720987 00040846.tif</p> |
|  <p>DE-0253_4(10) id=731778 952284.png</p> |  <p>DE-0254_4(8) id=705169 00020571.tif</p> |  <p>DE-0255_4(8) id=720690 00040498.tif</p> |











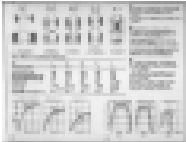



















| | | | | | |
|---|--|---|---|---|---|
|  | DE-0256_4(8) id=731808 952318.png |  | DE-0257_4(7) id=14452 00019176.tif |  | DE-0258_4(7) id=711308 00029926.tif |
|  | DE-0259_4(7) id=715504 00034726.tif |  | DE-0260_4(6) id=15109 00024668.tif |  | DE-0261_4(6) id=696779 00008550.tif |
|  | DE-0262_4(6) id=717951 00037534.tif |  | DE-0263_4(6) id=720782 00040603.tif |  | DE-0264_4(6) id=722921 00043169.tif |
|  | DE-0265_4(6) id=731173 932062.png |  | DE-0266_4(5) id=12082 00000525.tif |  | DE-0267_4(5) id=12134 00000738.tif |
|  | DE-0268_4(5) id=12419 00003318.tif |  | DE-0269_4(5) id=12947 00006868.tif |  | DE-0270_4(5) id=14034 00015784.tif |
|  | DE-0271_4(5) id=14454 00019194.tif |  | DE-0272_4(5) id=14989 00024034.tif |  | DE-0273_4(5) id=15845 00029925.tif |
|  | DE-0274_4(5) id=642228 hub-00614.tif |  | DE-0275_4(5) id=689671 00000039.tif |  | DE-0276_4(5) id=697271 00009157.tif |
|  | DE-0277_4(5) id=703495 00018383.tif |  | DE-0278_4(5) id=707013 00023104.tif |  | DE-0279_4(5) id=709460 00027027.tif |
|  | DE-0280_4(5) id=709664 00027427.tif |  | DE-0281_4(5) id=710560 00028911.tif |  | DE-0282_4(5) id=711303 00029920.tif |
|  | DE-0283_4(5) id=711900 00030605.tif |  | DE-0284_4(5) id=712968 00031845.tif |  | DE-0285_4(5) id=716968 00036468.tif |
|  | DE-0286_4(5) id=719516 00039208.tif |  | DE-0287_4(5) id=721216 00041098.tif |  | DE-0288_4(5) id=722448 00042622.tif |

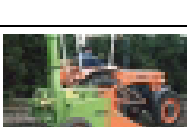

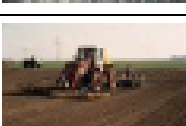
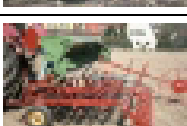
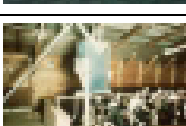













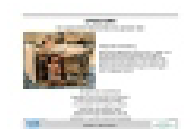
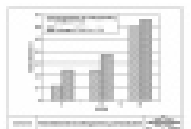















| | | | | | |
|---|--|---|--|---|--|
|  | DE-0289_4(5) id=728605 00049182.tif |  | DE-0290_4(5) id=728833 00049430.tif |  | DE-0291_4(5) id=731775 952281.png |
|  | DE-0292_4(5) id=732975 992037.png |  | DE-0293_4(4) id=12001 00000080.tif |  | DE-0294_4(4) id=12401 00003244.tif |
|  | DE-0295_4(4) id=12535 00003973.tif |  | DE-0296_4(4) id=12881 00006096.tif |  | DE-0297_4(4) id=12912 00006428.tif |
|  | DE-0298_4(4) id=13017 00007726.tif |  | DE-0299_4(4) id=13240 00010054.tif |  | DE-0300_4(4) id=13971 00015582.tif |
|  | DE-0301_4(4) id=14188 00016939.tif |  | DE-0302_4(4) id=14258 00017333.tif |  | DE-0303_4(4) id=14321 00017786.tif |
|  | DE-0304_4(4) id=14395 00018621.tif |  | DE-0305_4(4) id=14440 00019089.tif |  | DE-0306_4(4) id=14650 00021514.tif |
|  | DE-0307_4(4) id=14932 00023740.tif |  | DE-0308_4(4) id=15085 00024591.tif |  | DE-0309_4(4) id=15289 00026621.tif |
|  | DE-0310_4(4) id=638069 hub-03011.tif |  | DE-0311_4(4) id=640961 hub-00578.tif |  | DE-0312_4(4) id=642949 hub-10247.tif |
|  | DE-0313_4(4) id=689675 00000044.tif |  | DE-0314_4(4) id=689922 00000368.tif |  | DE-0315_4(4) id=689939 00000394.tif |

| | | |
|---|---|---|
|  DE-0316_4(4) id=690193 00000739.tif |  DE-0317_4(4) id=694665 00006285.tif |  DE-0318_4(4) id=694783 00006429.tif |
|  DE-0319_4(4) id=694827 00006474.tif |  DE-0320_4(4) id=694833 00006480.tif |  DE-0321_4(4) id=695070 00006764.tif |
|  DE-0322_4(4) id=695081 00006778.tif |  DE-0323_4(4) id=695107 00006809.tif |  DE-0324_4(4) id=695182 00006892.tif |
|  DE-0325_4(4) id=695277 00007001.tif |  DE-0326_4(4) id=695387 00007146.tif |  DE-0327_4(4) id=695450 00007229.tif |
|  DE-0328_4(4) id=695767 00007655.tif |  DE-0329_4(4) id=696130 00008095.tif |  DE-0330_4(4) id=696823 00008609.tif |
|  DE-0331_4(4) id=697193 00009057.tif |  DE-0332_4(4) id=697352 00009273.tif |  DE-0333_4(4) id=701154 00015194.tif |
|  DE-0334_4(4) id=701390 00015496.tif |  DE-0335_4(4) id=702217 00016522.tif |  DE-0336_4(4) id=703631 00018549.tif |
|  DE-0337_4(4) id=703690 00018633.tif |  DE-0338_4(4) id=703758 00018716.tif |  DE-0339_4(4) id=704100 00019184.tif |
|  DE-0340_4(4) id=704598 00019826.tif |  DE-0341_4(4) id=705432 00020933.tif |  DE-0342_4(4) id=705581 00021128.tif |
|  DE-0343_4(4) id=705951 00021621.tif |  DE-0344_4(4) id=707326 00023611.tif |  DE-0345_4(4) id=707866 00024400.tif |
|  DE-0346_4(4) id=708677 00025822.tif |  DE-0347_4(4) id=709065 00026406.tif |  DE-0348_4(4) id=710361 912357.png |
|  DE-0349_4(4) id=711294 00029910.tif |  DE-0350_4(4) id=711296 00029912.tif |  DE-0351_4(4) id=711297 00029913.tif |

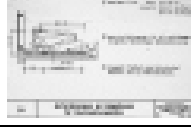







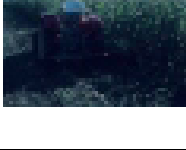





















| | | | | | |
|---|---|---|---|---|---|
|  | DE-0352_4(4) id=711321 00029942.tif |  | DE-0353_4(4) id=711324 00029947.tif |  | DE-0354_4(4) id=711904 00030609.tif |
|  | DE-0355_4(4) id=711907 00030612.tif |  | DE-0356_4(4) id=712302 00031034.tif |  | DE-0357_4(4) id=712768 00031632.tif |
|  | DE-0358_4(4) id=712965 00031842.tif |  | DE-0359_4(4) id=712967 00031844.tif |  | DE-0360_4(4) id=713120 00032009.tif |
|  | DE-0361_4(4) id=713283 00032180.tif |  | DE-0362_4(4) id=713676 00032612.tif |  | DE-0363_4(4) id=716081 00035412.tif |
|  | DE-0364_4(4) id=716437 00035811.tif |  | DE-0365_4(4) id=716829 00036323.tif |  | DE-0366_4(4) id=717441 00036972.tif |
|  | DE-0367_4(4) id=719105 00038777.tif |  | DE-0368_4(4) id=719429 00039114.tif |  | DE-0369_4(4) id=719596 00039296.tif |
|  | DE-0370_4(4) id=720642 00040447.tif |  | DE-0371_4(4) id=720671 00040476.tif |  | DE-0372_4(4) id=721224 00041111.tif |
|  | DE-0373_4(4) id=721225 00041112.tif |  | DE-0374_4(4) id=721644 00041736.tif |  | DE-0375_4(4) id=721983 00042132.tif |
|  | DE-0376_4(4) id=722970 00043226.tif |  | DE-0377_4(4) id=728586 00049161.tif |  | DE-0378_4(4) id=728864 00049467.tif |

| | | | | | |
|---|--|---|---|---|--|
|  | DE-0379_4(4) id=731867 952388.png |  | DE-0380_4(4) id=732034 962129.png |  | DE-0381_4(4) id=732201 962359.png |
|  | DE-0382_4(4) id=732896 982315.png |  | DE-0383_4(4) id=734051 032170.png |  | DE-0384_4(4) id=1198410 00051674.tif |
|  | DE-0385_4(4) id=1198427 00051691.tif |  | DE-0386_3(9) id=12090 00000563.tif |  | DE-0387_3(8) id=707893 00024431.tif |
|  | DE-0388_3(8) id=731299 932277.png |  | DE-0389_3(7) id=699990 00013529.tif |  | DE-0390_3(7) id=703820 00018787.tif |
|  | DE-0391_3(6) id=14919 00023658.tif |  | DE-0392_3(6) id=15297 00026743.tif |  | DE-0393_3(6) id=695408 00007177.tif |
|  | DE-0394_3(6) id=697598 00009608.tif |  | DE-0395_3(6) id=701480 00015604.tif |  | DE-0396_3(6) id=709644 00027381.tif |
|  | DE-0397_3(5) id=13223 00009952.tif |  | DE-0398_3(5) id=14513 00019856.tif |  | DE-0399_3(5) id=15430 00027617.tif |
|  | DE-0400_3(5) id=15482 00027743.tif |  | DE-0401_3(5) id=700483 00014492.tif |  | DE-0402_3(5) id=701901 00016187.tif |
|  | DE-0403_3(5) id=711969 00030682.tif |  | DE-0404_3(5) id=728392 00048955.tif |  | DE-0405_3(5) id=732576 972471.png |





















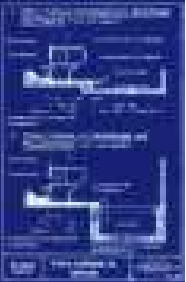



| | | | | | |
|---|--|---|--|---|--|
|  | DE-0406_3(4) id=12357 00002791.tif |  | DE-0407_3(4) id=12596 00004200.tif |  | DE-0408_3(4) id=13190 00009656.tif |
|  | DE-0409_3(4) id=13263 00010260.tif |  | DE-0410_3(4) id=13784 00012302.tif |  | DE-0411_3(4) id=13853 00013062.tif |
|  | DE-0412_3(4) id=13988 00015705.tif |  | DE-0413_3(4) id=14453 00019189.tif |  | DE-0414_3(4) id=14610 00021131.tif |
|  | DE-0415_3(4) id=15459 00027669.tif |  | DE-0416_3(4) id=638245 hub-12593.tif |  | DE-0417_3(4) id=638919 hub-01644.tif |
|  | DE-0418_3(4) id=642021 hub-00094.tif |  | DE-0419_3(4) id=642901 hub-03325.tif |  | DE-0420_3(4) id=643216 hub-02592.tif |
|  | DE-0421_3(4) id=690138 00000653.tif |  | DE-0422_3(4) id=700673 922276.png |  | DE-0423_3(4) id=701094 00015123.tif |
|  | DE-0424_3(4) id=701446 00015565.tif |  | DE-0425_3(4) id=702559 00016926.tif |  | DE-0426_3(4) id=706556 00022480.tif |
|  | DE-0427_3(4) id=711283 00029898.tif |  | DE-0428_3(4) id=711291 00029907.tif |  | DE-0429_3(4) id=711903 00030608.tif |
|  | DE-0430_3(4) id=712128 00030849.tif |  | DE-0431_3(4) id=713573 00032506.tif |  | DE-0432_3(4) id=714848 00033962.tif |
|  | DE-0433_3(4) id=716803 00036297.tif |  | DE-0434_3(4) id=717955 00037538.tif |  | DE-0435_3(4) id=718066 00037652.tif |
|  | DE-0436_3(4) id=719095 00038760.tif |  | DE-0437_3(4) id=720632 00040437.tif |  | DE-0438_3(4) id=722421 00042595.tif |

| | | | | | |
|---|---|---|---|---|---|
|  | DE-0439_3(4) id=722423 00042597.tif |  | DE-0440_3(4) id=724249 00044608.tif |  | DE-0441_3(4) id=724431 00044816.tif |
|  | DE-0442_3(4) id=729210 00049851.tif |  | DE-0443_3(4) id=729255 00049906.tif |  | DE-0444_3(4) id=731625 952004.png |
|  | DE-0445_3(4) id=733822 022261.png |  | DE-0446_3(4) id=734381 072004.png |  | DE-0447_3(3) id=12055 00000366.tif |
|  | DE-0448_3(3) id=12075 00000477.tif |  | DE-0449_3(3) id=12205 00001198.tif |  | DE-0450_3(3) id=12291 00002057.tif |
|  | DE-0451_3(3) id=12470 00003550.tif |  | DE-0452_3(3) id=12583 00004163.tif |  | DE-0453_3(3) id=12671 00004626.tif |
|  | DE-0454_3(3) id=12685 00004681.tif |  | DE-0455_3(3) id=12765 00005257.tif |  | DE-0456_3(3) id=12875 00006046.tif |
|  | DE-0457_3(3) id=12909 00006335.tif |  | DE-0458_3(3) id=12914 00006445.tif |  | DE-0459_3(3) id=13359 00010673.tif |
|  | DE-0460_3(3) id=13363 00010685.tif |  | DE-0461_3(3) id=13364 00010686.tif |  | DE-0462_3(3) id=13366 00010699.tif |
|  | DE-0463_3(3) id=13443 00010884.tif |  | DE-0464_3(3) id=13946 00015198.tif |  | DE-0465_3(3) id=13947 00015222.tif |
|  | DE-0466_3(3) id=13991 00015717.tif |  | DE-0467_3(3) id=14035 00015786.tif |  | DE-0468_3(3) id=14037 00015797.tif |
|  | DE-0469_3(3) id=14189 00016940.tif |  | DE-0470_3(3) id=14193 00016952.tif |  | DE-0471_3(3) id=14226 00017084.tif |























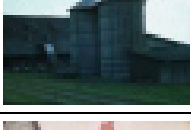

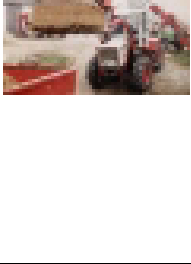



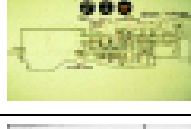

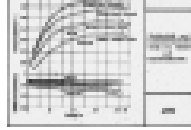

| | | | | | |
|---|--|---|--|---|--|
|  | DE-0472_3(3) id=14250 00017240.tif |  | DE-0473_3(3) id=14289 00017691.tif |  | DE-0474_3(3) id=14397 00018648.tif |
|  | DE-0475_3(3) id=14674 00021767.tif |  | DE-0476_3(3) id=14853 00023343.tif |  | DE-0477_3(3) id=14873 00023409.tif |
|  | DE-0478_3(3) id=14887 00023452.tif |  | DE-0479_3(3) id=14921 00023672.tif |  | DE-0480_3(3) id=15435 00027625.tif |
|  | DE-0481_3(3) id=15531 00028197.tif |  | DE-0482_3(3) id=15532 00028211.tif |  | DE-0483_3(3) id=15608 00028511.tif |
|  | DE-0484_3(3) id=15861 00031035.tif |  | DE-0485_3(3) id=15884 00036983.tif |  | DE-0486_3(3) id=637773 hub-10786.tif |
|  | DE-0487_3(3) id=637978 hub-02550.tif |  | DE-0488_3(3) id=637989 hub-02736.tif |  | DE-0489_3(3) id=638289 hub-03030.tif |
|  | DE-0490_3(3) id=638567 hub-04838.tif |  | DE-0491_3(3) id=639155 hub-03573.tif |  | DE-0492_3(3) id=640134 hub-00684.tif |
|  | DE-0493_3(3) id=640620 hub-04646.tif |  | DE-0494_3(3) id=640960 hub-00579.tif |  | DE-0495_3(3) id=642022 hub-00095.tif |
|  | DE-0496_3(3) id=642688 hub-03306.tif |  | DE-0497_3(3) id=689703 00000077.tif |  | DE-0498_3(3) id=689734 00000115.tif |
|  | DE-0499_3(3) id=689943 00000398.tif |  | DE-0500_3(3) id=690003 00000476.tif |  | DE-0501_3(3) id=690199 00000745.tif |























| | | | | | |
|---|---|---|---|---|---|
|  | DE-0502_3(3) id=690219 00000768.tif |  | DE-0503_3(3) id=690261 00000815.tif |  | DE-0504_3(3) id=690276 00000832.tif |
|  | DE-0505_3(3) id=690334 00000902.tif |  | DE-0506_3(3) id=690336 00000904.tif |  | DE-0507_3(3) id=690405 00000986.tif |
|  | DE-0508_3(3) id=690424 00001010.tif |  | DE-0509_3(3) id=690454 00001047.tif |  | DE-0510_3(3) id=690559 00001177.tif |
|  | DE-0511_3(3) id=691712 00002857.tif |  | DE-0512_3(3) id=691956 00003198.tif |  | DE-0513_3(3) id=691960 00003207.tif |
|  | DE-0514_3(3) id=694670 00006290.tif |  | DE-0515_3(3) id=694689 00006308.tif |  | DE-0516_3(3) id=694693 00006312.tif |
|  | DE-0517_3(3) id=694846 00006503.tif |  | DE-0518_3(3) id=694847 00006504.tif |  | DE-0519_3(3) id=695063 00006755.tif |
|  | DE-0520_3(3) id=695064 00006756.tif |  | DE-0521_3(3) id=695065 00006757.tif |  | DE-0522_3(3) id=695074 00006768.tif |
|  | DE-0523_3(3) id=695077 00006773.tif |  | DE-0524_3(3) id=695079 00006776.tif |  | DE-0525_3(3) id=695087 00006787.tif |
|  | DE-0526_3(3) id=695089 00006789.tif |  | DE-0527_3(3) id=695146 00006861.tif |  | DE-0528_3(3) id=695185 00006896.tif |
|  | DE-0529_3(3) id=695300 00007029.tif |  | DE-0530_3(3) id=695424 00007197.tif |  | DE-0531_3(3) id=695616 00007460.tif |







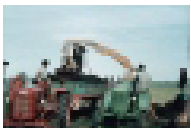





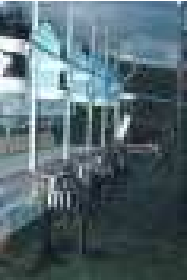







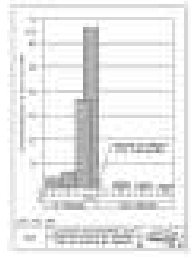

| | | | | | |
|---|---|---|---|---|---|
|  | DE-0532_3(3) id=695811 00007709.tif |  | DE-0533_3(3) id=695817 00007715.tif |  | DE-0534_3(3) id=695861 00007769.tif |
|  | DE-0535_3(3) id=695948 00007869.tif |  | DE-0536_3(3) id=695984 00007916.tif |  | DE-0537_3(3) id=696054 00007995.tif |
|  | DE-0538_3(3) id=696127 00008092.tif |  | DE-0539_3(3) id=696547 00008216.tif |  | DE-0540_3(3) id=696985 00008803.tif |
|  | DE-0541_3(3) id=697267 00009153.tif |  | DE-0542_3(3) id=697279 00009169.tif |  | DE-0543_3(3) id=698107 00010256.tif |
|  | DE-0544_3(3) id=698184 00010391.tif |  | DE-0545_3(3) id=698320 00010665.tif |  | DE-0546_3(3) id=698321 00010667.tif |
|  | DE-0547_3(3) id=698322 00010669.tif |  | DE-0548_3(3) id=698915 00011868.tif |  | DE-0549_3(3) id=699376 00012596.tif |
|  | DE-0550_3(3) id=699378 00012599.tif |  | DE-0551_3(3) id=699392 00012613.tif |  | DE-0552_3(3) id=699394 00012615.tif |
|  | DE-0553_3(3) id=699733 00013153.tif |  | DE-0554_3(3) id=700011 00013554.tif |  | DE-0555_3(3) id=700354 00014257.tif |
|  | DE-0556_3(3) id=700489 00014499.tif |  | DE-0557_3(3) id=700670 912102.png |  | DE-0558_3(3) id=701174 00015217.tif |
|  | DE-0559_3(3) id=701204 00015255.tif |  | DE-0560_3(3) id=701278 00015333.tif |  | DE-0561_3(3) id=701394 00015501.tif |
|  | DE-0562_3(3) id=701409 00015517.tif |  | DE-0563_3(3) id=701671 00015907.tif |  | DE-0564_3(3) id=701683 00015922.tif |



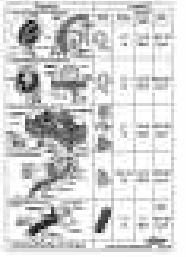



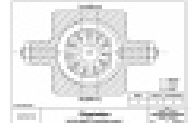











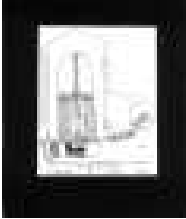

| | | | | | |
|---|---|---|---|---|---|
|  | DE-0565_3(3) id=702573 00016944.tif |  | DE-0566_3(3) id=702953 942218.png |  | DE-0567_3(3) id=703469 00018353.tif |
|  | DE-0568_3(3) id=703555 00018457.tif |  | DE-0569_3(3) id=703612 00018524.tif |  | DE-0570_3(3) id=703686 00018629.tif |
|  | DE-0571_3(3) id=703748 00018701.tif |  | DE-0572_3(3) id=703763 00018724.tif |  | DE-0573_3(3) id=703824 00018791.tif |
|  | DE-0574_3(3) id=703979 00019008.tif |  | DE-0575_3(3) id=704027 00019072.tif |  | DE-0576_3(3) id=704081 00019150.tif |
|  | DE-0577_3(3) id=704084 00019154.tif |  | DE-0578_3(3) id=704739 00020023.tif |  | DE-0579_3(3) id=705477 00020995.tif |
|  | DE-0580_3(3) id=705595 00021145.tif |  | DE-0581_3(3) id=706423 00022284.tif |  | DE-0582_3(3) id=706424 00022285.tif |
|  | DE-0583_3(3) id=706615 00022558.tif |  | DE-0584_3(3) id=706622 00022566.tif |  | DE-0585_3(3) id=706636 00022580.tif |
|  | DE-0586_3(3) id=707005 00023086.tif |  | DE-0587_3(3) id=707662 00024094.tif |  | DE-0588_3(3) id=707867 00024401.tif |

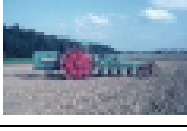
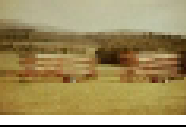



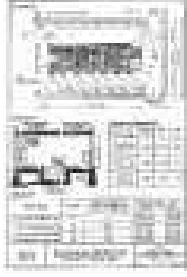

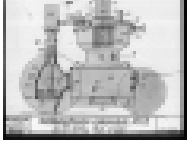













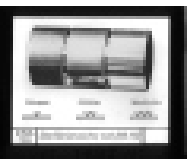







| | | | | | |
|---|---|---|---|---|---|
|  | DE-0589_3(3) id=708687 00025832.tif |  | DE-0590_3(3) id=709029 00026362.tif |  | DE-0591_3(3) id=709046 00026383.tif |
|  | DE-0592_3(3) id=709344 00026830.tif |  | DE-0593_3(3) id=709427 00026979.tif |  | DE-0594_3(3) id=710359 912361.png |
|  | DE-0595_3(3) id=710580 00028964.tif |  | DE-0596_3(3) id=710981 00029523.tif |  | DE-0597_3(3) id=711299 00029916.tif |
|  | DE-0598_3(3) id=711300 00029917.tif |  | DE-0599_3(3) id=711319 00029940.tif |  | DE-0600_3(3) id=711325 00029948.tif |
|  | DE-0601_3(3) id=711326 00029949.tif |  | DE-0602_3(3) id=711460 00030114.tif |  | DE-0603_3(3) id=711579 00030237.tif |
|  | DE-0604_3(3) id=711752 00030448.tif |  | DE-0605_3(3) id=711793 00030494.tif |  | DE-0606_3(3) id=711796 00030497.tif |
|  | DE-0607_3(3) id=711822 00030525.tif |  | DE-0608_3(3) id=711824 00030527.tif |  | DE-0609_3(3) id=711908 00030613.tif |
|  | DE-0610_3(3) id=711909 00030615.tif |  | DE-0611_3(3) id=711940 00030647.tif |  | DE-0612_3(3) id=711980 00030693.tif |
|  | DE-0613_3(3) id=711982 00030695.tif |  | DE-0614_3(3) id=712120 00030841.tif |  | DE-0615_3(3) id=712134 00030856.tif |
|  | DE-0616_3(3) id=712241 00030973.tif |  | DE-0617_3(3) id=712685 00031543.tif |  | DE-0618_3(3) id=712775 00031639.tif |
|  | DE-0619_3(3) id=712846 00031711.tif |  | DE-0620_3(3) id=712979 00031856.tif |  | DE-0621_3(3) id=713064 00031951.tif |

| | | | | | |
|---|---|---|---|---|---|
|  | DE-0622_3(3) id=713145 00032034.tif |  | DE-0623_3(3) id=713181 00032072.tif |  | DE-0624_3(3) id=713257 00032154.tif |
|  | DE-0625_3(3) id=713693 00032629.tif |  | DE-0626_3(3) id=713704 00032641.tif |  | DE-0627_3(3) id=713828 00032771.tif |
|  | DE-0628_3(3) id=713914 00032858.tif |  | DE-0629_3(3) id=714041 00032989.tif |  | DE-0630_3(3) id=714076 00033025.tif |
|  | DE-0631_3(3) id=714107 00033057.tif |  | DE-0632_3(3) id=714728 00033785.tif |  | DE-0633_3(3) id=715143 00034295.tif |
|  | DE-0634_3(3) id=715145 00034297.tif |  | DE-0635_3(3) id=715218 00034379.tif |  | DE-0636_3(3) id=715754 00034990.tif |
|  | DE-0637_3(3) id=715787 00035025.tif |  | DE-0638_3(3) id=716056 00035380.tif |  | DE-0639_3(3) id=716059 00035383.tif |
|  | DE-0640_3(3) id=716333 00035701.tif |  | DE-0641_3(3) id=716420 00035794.tif |  | DE-0642_3(3) id=716814 00036308.tif |
|  | DE-0643_3(3) id=717946 00037528.tif |  | DE-0644_3(3) id=717960 00037543.tif |  | DE-0645_3(3) id=717993 00037579.tif |
|  | DE-0646_3(3) id=718936 00038585.tif |  | DE-0647_3(3) id=719002 00038658.tif |  | DE-0648_3(3) id=719011 00038672.tif |
|  | DE-0649_3(3) id=719142 00038814.tif |  | DE-0650_3(3) id=719153 00038825.tif |  | DE-0651_3(3) id=719341 00039023.tif |
|  | DE-0652_3(3) id=719475 00039166.tif |  | DE-0653_3(3) id=719767 00039479.tif |  | DE-0654_3(3) id=719838 00039560.tif |
|  | DE-0655_3(3) id=719870 00039599.tif |  | DE-0656_3(3) id=720399 00040195.tif |  | DE-0657_3(3) id=720673 00040478.tif |











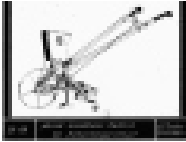









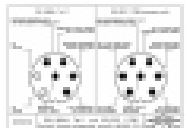

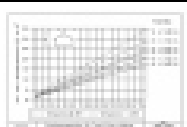



| | | | | | |
|---|---|---|---|---|---|
|  | DE-0658_3(3) id=720674 00040479.tif |  | DE-0659_3(3) id=720688 00040494.tif |  | DE-0660_3(3) id=720790 00040614.tif |
|  | DE-0661_3(3) id=720940 00040792.tif |  | DE-0662_3(3) id=721005 00040864.tif |  | DE-0663_3(3) id=721027 00040886.tif |
|  | DE-0664_3(3) id=721058 00040920.tif |  | DE-0665_3(3) id=721060 00040922.tif |  | DE-0666_3(3) id=721140 00041021.tif |
|  | DE-0667_3(3) id=721174 00041055.tif |  | DE-0668_3(3) id=721200 00041082.tif |  | DE-0669_3(3) id=721227 00041114.tif |
|  | DE-0670_3(3) id=721252 00041146.tif |  | DE-0671_3(3) id=721282 00041181.tif |  | DE-0672_3(3) id=721938 00042083.tif |
|  | DE-0673_3(3) id=721951 00042096.tif |  | DE-0674_3(3) id=722412 00042586.tif |  | DE-0675_3(3) id=722417 00042591.tif |
|  | DE-0676_3(3) id=722422 00042596.tif |  | DE-0677_3(3) id=722426 00042600.tif |  | DE-0678_3(3) id=722430 00042604.tif |
|  | DE-0679_3(3) id=722942 00043195.tif |  | DE-0680_3(3) id=722973 00043229.tif |  | DE-0681_3(3) id=724325 00044690.tif |





| | | | | | |
|---|---|---|---|---|---|
|  | DE-0682_3(3) id=726487 00046990.tif |  | DE-0683_3(3) id=727895 00048443.tif |  | DE-0684_3(3) id=728618 00049197.tif |
|  | DE-0685_3(3) id=728626 00049205.tif |  | DE-0686_3(3) id=729133 00049772.tif |  | DE-0687_3(3) id=729853 00050562.tif |
|  | DE-0688_3(3) id=729888 00050597.tif |  | DE-0689_3(3) id=730481 00051291.tif |  | DE-0690_3(3) id=730542 00051355.tif |
|  | DE-0691_3(3) id=730654 00051505.tif |  | DE-0692_3(3) id=730655 00051506.tif |  | DE-0693_3(3) id=730924 912470.png |
|  | DE-0694_3(3) id=731140 932012.png |  | DE-0695_3(3) id=731399 942035.png |  | DE-0696_3(3) id=731740 952232.png |
|  | DE-0697_3(3) id=731766 952269.png |  | DE-0698_3(3) id=732010 962101.png |  | DE-0699_3(3) id=732203 962361.png |
|  | DE-0700_3(3) id=732871 982290.png |  | DE-0701_3(3) id=733305 002174.png |  | DE-0702_3(3) id=733535 012203.png |
|  | DE-0703_3(3) id=733921 032027.png |  | DE-0704_3(3) id=734249 042061.png |  | DE-0705_3(3) id=734250 042062.png |

| | | | | | |
|---|--|---|--|---|--|
|  | DE-0707_3(3) id=1063345 Dreschmaschine.tif |  | DE-0708_3(3) id=1198382 00051646.tif |  | DE-0709_2(12) id=721254 00041148.tif |
|  | DE-0710_2(5) id=15822 00029717.tif |  | DE-0711_2(5) id=712632 00031481.tif |  | DE-0712_2(4) id=12073 00000473.tif |
|  | DE-0713_2(4) id=12609 00004286.tif |  | DE-0714_2(4) id=14331 00017810.tif |  | DE-0715_2(4) id=14771 00023101.tif |
|  | DE-0716_2(4) id=641199 hub-00827.tif |  | DE-0717_2(4) id=689720 00000099.tif |  | DE-0718_2(4) id=690009 00000483.tif |
|  | DE-0719_2(4) id=697817 00009881.tif |  | DE-0720_2(4) id=698252 00010512.tif |  | DE-0721_2(4) id=703648 00018568.tif |
|  | DE-0722_2(4) id=711906 00030611.tif |  | DE-0723_2(4) id=716467 00035858.tif |  | DE-0724_2(4) id=716915 00036412.tif |
|  | DE-0725_2(4) id=717320 00036836.tif |  | DE-0726_2(4) id=728863 00049465.tif |  | DE-0727_2(4) id=734002 032117.png |
|  | DE-0728_2(4) id=1208363 00052100.tif |  | DE-0729_2(4) id=1208369 00052068.tif |  | DE-0730_2(3) id=12154 00000906.tif |

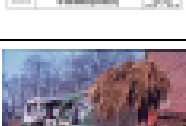
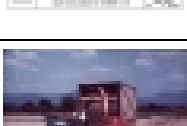
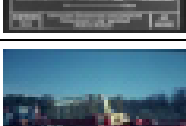





| | | | | | |
|---|--|---|--|---|--|
|  | DE-0731_2(3) id=12756 00005190.tif |  | DE-0732_2(3) id=12869 00006022.tif |  | DE-0733_2(3) id=13239 00010047.tif |
|  | DE-0734_2(3) id=13793 00012349.tif |  | DE-0735_2(3) id=14033 00015783.tif |  | DE-0736_2(3) id=14223 00017072.tif |
|  | DE-0737_2(3) id=14704 00022010.tif |  | DE-0738_2(3) id=14750 00022785.tif |  | DE-0739_2(3) id=14830 00023309.tif |
|  | DE-0740_2(3) id=14845 00023330.tif |  | DE-0741_2(3) id=15440 00027636.tif |  | DE-0742_2(3) id=638456 hub-02891.tif |
|  | DE-0743_2(3) id=638953 hub-00992.tif |  | DE-0744_2(3) id=639286 hub-01950.tif |  | DE-0745_2(3) id=639432 hub-02836.tif |
|  | DE-0746_2(3) id=640934 hub-01156.tif |  | DE-0747_2(3) id=640936 hub-01154.tif |  | DE-0748_2(3) id=690322 00000888.tif |
|  | DE-0749_2(3) id=695115 00006818.tif |  | DE-0750_2(3) id=695117 00006822.tif |  | DE-0751_2(3) id=695238 00006953.tif |
|  | DE-0752_2(3) id=695643 00007495.tif |  | DE-0753_2(3) id=697265 00009151.tif |  | DE-0754_2(3) id=697599 00009609.tif |
|  | DE-0755_2(3) id=697781 00009840.tif |  | DE-0756_2(3) id=697905 00009999.tif |  | DE-0757_2(3) id=698106 00010255.tif |
|  | DE-0758_2(3) id=700351 00014254.tif |  | DE-0759_2(3) id=700357 00014260.tif |  | DE-0760_2(3) id=701230 00015282.tif |



























| | | | | | |
|---|---|---|---|---|---|
|  | DE-0761_2(3) id=701609 00015802.tif |  | DE-0762_2(3) id=701638 00015864.tif |  | DE-0763_2(3) id=701767 00016020.tif |
|  | DE-0764_2(3) id=703940 00018952.tif |  | DE-0765_2(3) id=704971 00020313.tif |  | DE-0766_2(3) id=706444 00022308.tif |
|  | DE-0767_2(3) id=707495 00023839.tif |  | DE-0768_2(3) id=707510 00023866.tif |  | DE-0769_2(3) id=708935 00026201.tif |
|  | DE-0770_2(3) id=710121 932388.png |  | DE-0771_2(3) id=711322 00029943.tif |  | DE-0772_2(3) id=711337 00029962.tif |
|  | DE-0773_2(3) id=711465 00030119.tif |  | DE-0774_2(3) id=711764 00030464.tif |  | DE-0775_2(3) id=711905 00030610.tif |
|  | DE-0776_2(3) id=712127 00030848.tif |  | DE-0777_2(3) id=712281 00031013.tif |  | DE-0778_2(3) id=712634 00031483.tif |
|  | DE-0779_2(3) id=715478 00034678.tif |  | DE-0780_2(3) id=716739 00036230.tif |  | DE-0781_2(3) id=716966 00036466.tif |
|  | DE-0782_2(3) id=717070 00036574.tif |  | DE-0783_2(3) id=717428 00036959.tif |  | DE-0784_2(3) id=717728 00037291.tif |
|  | DE-0785_2(3) id=717869 00037444.tif |  | DE-0786_2(3) id=719868 00039596.tif |  | DE-0787_2(3) id=719880 00039611.tif |
|  | DE-0788_2(3) id=721106 00040986.tif |  | DE-0789_2(3) id=721171 00041052.tif |  | DE-0790_2(3) id=721178 00041059.tif |
|  | DE-0791_2(3) id=721212 00041094.tif |  | DE-0792_2(3) id=721213 00041095.tif |  | DE-0793_2(3) id=721547 00041496.tif |











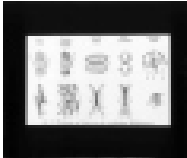
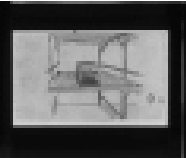
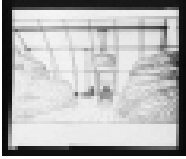



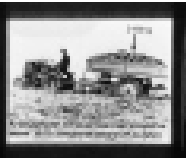

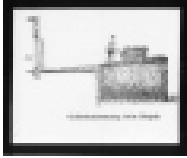
| | | | | | |
|---|---|---|---|---|--|
|  | DE-0794_2(3) id=722074 00042228.tif |  | DE-0795_2(3) id=722194 00042357.tif |  | DE-0796_2(3) id=722444 00042618.tif |
|  | DE-0797_2(3) id=722928 00043179.tif |  | DE-0798_2(3) id=723710 00044033.tif |  | DE-0799_2(3) id=724160 00044503.tif |
|  | DE-0800_2(3) id=728591 00049167.tif |  | DE-0801_2(3) id=728728 00049314.tif |  | DE-0802_2(3) id=729751 00050455.tif |
|  | DE-0803_2(3) id=730652 00051502.tif |  | DE-0804_2(3) id=731211 932124.png |  | DE-0805_2(3) id=731284 932255.png |
|  | DE-0806_2(3) id=731557 942345.png |  | DE-0807_2(3) id=731735 952227.png |  | DE-0808_2(3) id=731771 952276.png |
|  | DE-0809_2(3) id=731785 952291.png |  | DE-0810_2(3) id=732160 962297.png |  | DE-0811_2(3) id=732421 972235.png |
|  | DE-0812_2(3) id=732548 972417.png |  | DE-0813_2(3) id=732577 972472.png |  | DE-0814_2(3) id=732958 992019.png |
|  | DE-0815_2(3) id=733057 992129.png |  | DE-0816_2(3) id=733969 032077.png |  | DE-0817_2(3) id=1208367 00052138.tif |
|  | DE-0818_2(2) id=11993 00000028.tif |  | DE-0819_2(2) id=12002 00000082.tif |  | DE-0820_2(2) id=12004 00000097.tif |
|  | DE-0821_2(2) id=12007 00000117.tif |  | DE-0822_2(2) id=12017 00000201.tif |  | DE-0823_2(2) id=12027 00000274.tif |





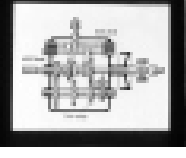
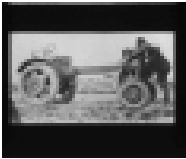
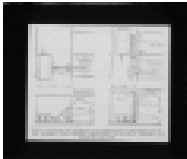
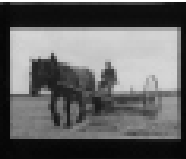

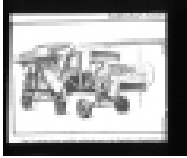
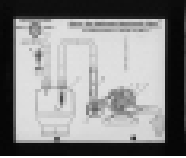
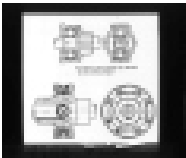

















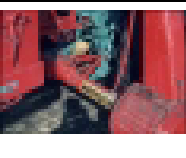
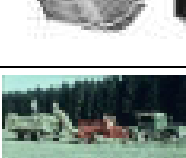
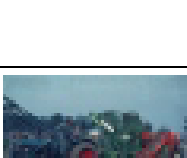
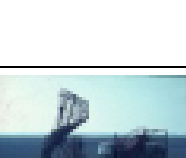



| | | | | | |
|---|--|---|--|---|--|
|  | DE-0824_2(2) id=12050 00000352.tif |  | DE-0825_2(2) id=12052 00000357.tif |  | DE-0826_2(2) id=12081 00000523.tif |
|  | DE-0827_2(2) id=12191 00001132.tif |  | DE-0828_2(2) id=12197 00001167.tif |  | DE-0829_2(2) id=12203 00001193.tif |
|  | DE-0830_2(2) id=12213 00001221.tif |  | DE-0831_2(2) id=12220 00001264.tif |  | DE-0832_2(2) id=12290 00002056.tif |
|  | DE-0833_2(2) id=12340 00002557.tif |  | DE-0834_2(2) id=12386 00003140.tif |  | DE-0835_2(2) id=12408 00003260.tif |
|  | DE-0836_2(2) id=12449 00003459.tif |  | DE-0837_2(2) id=12456 00003486.tif |  | DE-0838_2(2) id=12464 00003503.tif |
|  | DE-0839_2(2) id=12494 00003703.tif |  | DE-0840_2(2) id=12523 00003909.tif |  | DE-0841_2(2) id=12545 00004037.tif |
|  | DE-0842_2(2) id=12551 00004054.tif |  | DE-0843_2(2) id=12566 00004108.tif |  | DE-0844_2(2) id=12618 00004339.tif |
|  | DE-0845_2(2) id=12664 00004608.tif |  | DE-0846_2(2) id=12676 00004639.tif |  | DE-0847_2(2) id=12703 00004780.tif |
|  | DE-0848_2(2) id=12706 00004787.tif |  | DE-0849_2(2) id=12738 00005002.tif |  | DE-0850_2(2) id=12767 00005273.tif |
|  | DE-0851_2(2) id=12833 00005759.tif |  | DE-0852_2(2) id=12839 00005770.tif |  | DE-0853_2(2) id=12841 00005789.tif |
|  | DE-0854_2(2) id=12847 00005825.tif |  | DE-0855_2(2) id=12873 00006039.tif |  | DE-0856_2(2) id=12879 00006081.tif |









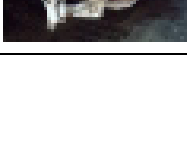
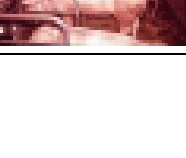









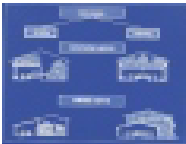

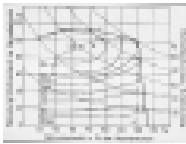
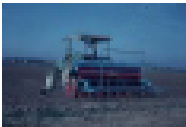







| | | | | | |
|---|--|---|--|---|--|
|  | DE-0857_2(2) id=12880 00006093.tif |  | DE-0858_2(2) id=12921 00006514.tif |  | DE-0859_2(2) id=12925 00006581.tif |
|  | DE-0860_2(2) id=12941 00006815.tif |  | DE-0861_2(2) id=13015 00007685.tif |  | DE-0862_2(2) id=13020 00007765.tif |
|  | DE-0863_2(2) id=13148 00009230.tif |  | DE-0864_2(2) id=13191 00009662.tif |  | DE-0865_2(2) id=13357 00010666.tif |
|  | DE-0866_2(2) id=13361 00010679.tif |  | DE-0867_2(2) id=13367 00010701.tif |  | DE-0868_2(2) id=13814 00012494.tif |
|  | DE-0869_2(2) id=13816 00012514.tif |  | DE-0870_2(2) id=13859 00013144.tif |  | DE-0871_2(2) id=13873 00013525.tif |
|  | DE-0872_2(2) id=13886 00013591.tif |  | DE-0873_2(2) id=13915 00014466.tif |  | DE-0874_2(2) id=13918 00014508.tif |
|  | DE-0875_2(2) id=13932 00014882.tif |  | DE-0876_2(2) id=13944 00015176.tif |  | DE-0877_2(2) id=13951 00015281.tif |













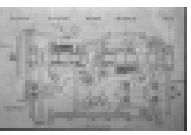













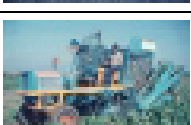
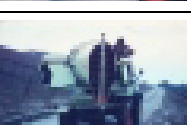

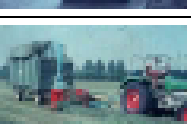
| | | |
|---|---|---|
|  <p>DE-0878_2(2) id=14021 00015765.tif</p> |  <p>DE-0879_2(2) id=14045 00015814.tif</p> |  <p>DE-0880_2(2) id=14121 00016199.tif</p> |
|  <p>DE-0881_2(2) id=14143 00016386.tif</p> |  <p>DE-0882_2(2) id=14198 00016972.tif</p> |  <p>DE-0883_2(2) id=14199 00016974.tif</p> |
|  <p>DE-0884_2(2) id=14200 00016976.tif</p> |  <p>DE-0885_2(2) id=14217 00017046.tif</p> |  <p>DE-0886_2(2) id=14225 00017083.tif</p> |
|  <p>DE-0887_2(2) id=14227 00017089.tif</p> |  <p>DE-0888_2(2) id=14246 00017231.tif</p> |  <p>DE-0889_2(2) id=14269 00017585.tif</p> |
|  <p>DE-0890_2(2) id=14282 00017669.tif</p> |  <p>DE-0891_2(2) id=14294 00017712.tif</p> |  <p>DE-0892_2(2) id=14296 00017720.tif</p> |
|  <p>DE-0893_2(2) id=14352 00017927.tif</p> |  <p>DE-0894_2(2) id=14403 00018712.tif</p> |  <p>DE-0895_2(2) id=14469 00019428.tif</p> |



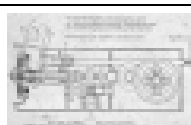



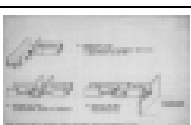





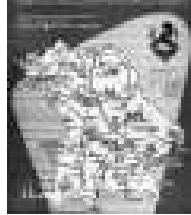







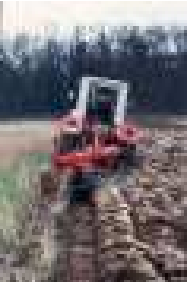







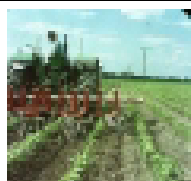

| | | | | | |
|---|--|---|--|---|--|
|  | DE-0896_2(2) id=14471 00019431.tif |  | DE-0897_2(2) id=14482 00019522.tif |  | DE-0898_2(2) id=14484 00019539.tif |
|  | DE-0899_2(2) id=14529 00019995.tif |  | DE-0900_2(2) id=14556 00020354.tif |  | DE-0901_2(2) id=14571 00020703.tif |
|  | DE-0902_2(2) id=14603 00021086.tif |  | DE-0903_2(2) id=14642 00021402.tif |  | DE-0904_2(2) id=14748 00022747.tif |
|  | DE-0905_2(2) id=14885 00023447.tif |  | DE-0906_2(2) id=15056 00024558.tif |  | DE-0907_2(2) id=15167 00025194.tif |
|  | DE-0908_2(2) id=15189 00025499.tif |  | DE-0909_2(2) id=15232 00026004.tif |  | DE-0910_2(2) id=15293 00026644.tif |
|  | DE-0911_2(2) id=15425 00027611.tif |  | DE-0912_2(2) id=15431 00027618.tif |  | DE-0913_2(2) id=15460 00027670.tif |
|  | DE-0914_2(2) id=15490 00027896.tif |  | DE-0915_2(2) id=15540 00028228.tif |  | DE-0916_2(2) id=15748 00029173.tif |
|  | DE-0917_2(2) id=15756 00029267.tif |  | DE-0918_2(2) id=15847 00029939.tif |  | DE-0919_2(2) id=15851 00029966.tif |
|  | DE-0920_2(2) id=15893 00039597.tif |  | DE-0921_2(2) id=15900 00040607.tif |  | DE-0922_2(2) id=638034 hub-13225.tif |







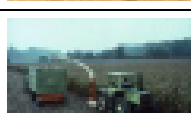



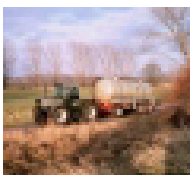

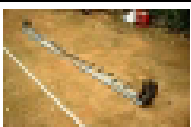
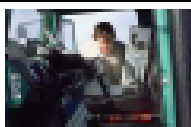



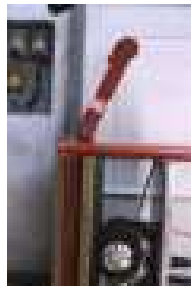
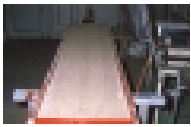









| | | | | | |
|---|--|---|--|---|--|
|  | DE-0923_2(2) id=638196 hub-05503.tif |  | DE-0924_2(2) id=638228 hub-04877.tif |  | DE-0925_2(2) id=638243 hub-11326.tif |
|  | DE-0926_2(2) id=638516 hub-00245.tif |  | DE-0927_2(2) id=638519 hub-00246.tif |  | DE-0928_2(2) id=638651 hub-00818.tif |
|  | DE-0929_2(2) id=638694 hub-03792.tif |  | DE-0930_2(2) id=638695 hub-03793.tif |  | DE-0931_2(2) id=638818 hub-01479.tif |
|  | DE-0932_2(2) id=638995 hub-10366.tif |  | DE-0933_2(2) id=639077 hub-00221.tif |  | DE-0934_2(2) id=639270 hub-10319.tif |
|  | DE-0935_2(2) id=639359 hub-12779.tif |  | DE-0936_2(2) id=639574 hub-02196.tif |  | DE-0937_2(2) id=639710 hub-00644.tif |
|  | DE-0938_2(2) id=639796 hub-10270.tif |  | DE-0939_2(2) id=639913 hub-02401.tif |  | DE-0940_2(2) id=639924 hub-00661.tif |
|  | DE-0941_2(2) id=640293 hub-02746.tif |  | DE-0942_2(2) id=640911 hub-04869.tif |  | DE-0943_2(2) id=640930 hub-12585.tif |
|  | DE-0944_2(2) id=640932 hub-01158.tif |  | DE-0945_2(2) id=641197 hub-00825.tif |  | DE-0946_2(2) id=641222 hub-05425.tif |
|  | DE-0947_2(2) id=641260 hub-04613.tif |  | DE-0948_2(2) id=641601 hub-01903.tif |  | DE-0949_2(2) id=641609 hub-10732.tif |





















| | | | | | |
|---|--|---|--|---|--|
|  | DE-0950_2(2) id=641632 hub-04194.tif |  | DE-0951_2(2) id=641720 hub-02741.tif |  | DE-0952_2(2) id=641776 hub-01075.tif |
|  | DE-0953_2(2) id=641779 hub-01076.tif |  | DE-0954_2(2) id=641780 hub-01071.tif |  | DE-0955_2(2) id=641878 hub-01585.tif |
|  | DE-0956_2(2) id=641906 hub-05353.tif |  | DE-0957_2(2) id=641937 hub-11891.tif |  | DE-0958_2(2) id=641939 hub-03173.tif |
|  | DE-0959_2(2) id=642229 hub-00615.tif |  | DE-0960_2(2) id=642246 hub-13517.tif |  | DE-0961_2(2) id=642657 hub-00657.tif |
|  | DE-0962_2(2) id=643138 hub-00199.tif |  | DE-0963_2(2) id=643311 hub-03366.tif |  | DE-0964_2(2) id=689663 00000027.tif |
|  | DE-0965_2(2) id=689690 00000060.tif |  | DE-0966_2(2) id=689723 00000103.tif |  | DE-0967_2(2) id=689729 00000110.tif |
|  | DE-0968_2(2) id=689732 00000113.tif |  | DE-0969_2(2) id=689736 00000118.tif |  | DE-0970_2(2) id=689895 00000324.tif |
|  | DE-0971_2(2) id=689904 00000336.tif |  | DE-0972_2(2) id=689933 00000385.tif |  | DE-0973_2(2) id=689935 00000387.tif |
|  | DE-0974_2(2) id=689986 00000452.tif |  | DE-0975_2(2) id=689990 00000457.tif |  | DE-0976_2(2) id=689999 00000468.tif |
|  | DE-0977_2(2) id=690012 00000486.tif |  | DE-0978_2(2) id=690019 00000496.tif |  | DE-0979_2(2) id=690026 00000505.tif |
|  | DE-0980_2(2) id=690171 00000707.tif |  | DE-0981_2(2) id=690189 00000732.tif |  | DE-0982_2(2) id=690236 00000786.tif |



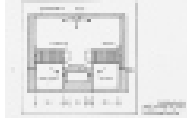











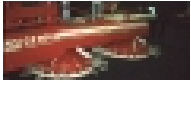











| | | | | | |
|---|---|---|---|---|---|
|  | DE-0983_2(2) id=690299 00000861.tif |  | DE-0984_2(2) id=690437 00001025.tif |  | DE-0985_2(2) id=690504 00001104.tif |
|  | DE-0986_2(2) id=690508 00001110.tif |  | DE-0987_2(2) id=690546 00001159.tif |  | DE-0988_2(2) id=690555 00001171.tif |
|  | DE-0989_2(2) id=691007 00001845.tif |  | DE-0990_2(2) id=691009 00001847.tif |  | DE-0991_2(2) id=691134 00002034.tif |
|  | DE-0992_2(2) id=691155 00002061.tif |  | DE-0993_2(2) id=691412 00002427.tif |  | DE-0994_2(2) id=691713 00002858.tif |
|  | DE-0995_2(2) id=694650 00006267.tif |  | DE-0996_2(2) id=694695 00006314.tif |  | DE-0997_2(2) id=694699 00006318.tif |
|  | DE-0998_2(2) id=694709 00006331.tif |  | DE-0999_2(2) id=694717 00006341.tif |  | DE-1000_2(2) id=694782 00006427.tif |
|  | DE-1001_2(2) id=694787 00006433.tif |  | DE-1002_2(2) id=694788 00006434.tif |  | DE-1003_2(2) id=694791 00006437.tif |
|  | DE-1004_2(2) id=694797 00006444.tif |  | DE-1005_2(2) id=694824 00006471.tif |  | DE-1006_2(2) id=694826 00006473.tif |
|  | DE-1007_2(2) id=694836 00006487.tif |  | DE-1008_2(2) id=694848 00006505.tif |  | DE-1009_2(2) id=694849 00006506.tif |
|  | DE-1010_2(2) id=694861 00006519.tif |  | DE-1011_2(2) id=694862 00006520.tif |  | DE-1012_2(2) id=694864 00006522.tif |





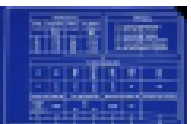







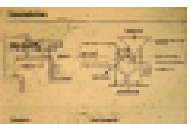



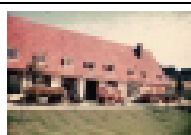









| | | | | | |
|---|---|---|---|---|---|
|  | DE-1013_2(2) id=694866 00006524.tif |  | DE-1014_2(2) id=694904 00006562.tif |  | DE-1015_2(2) id=694978 00006650.tif |
|  | DE-1016_2(2) id=694996 00006673.tif |  | DE-1017_2(2) id=695037 00006725.tif |  | DE-1018_2(2) id=695053 00006744.tif |
|  | DE-1019_2(2) id=695091 00006791.tif |  | DE-1020_2(2) id=695102 00006803.tif |  | DE-1021_2(2) id=695127 00006841.tif |
|  | DE-1022_2(2) id=695128 00006842.tif |  | DE-1023_2(2) id=695132 00006846.tif |  | DE-1024_2(2) id=695145 00006859.tif |
|  | DE-1025_2(2) id=695151 00006867.tif |  | DE-1026_2(2) id=695273 00006996.tif |  | DE-1027_2(2) id=695278 00007003.tif |
|  | DE-1028_2(2) id=695330 00007081.tif |  | DE-1029_2(2) id=695331 00007082.tif |  | DE-1030_2(2) id=695345 00007097.tif |
|  | DE-1031_2(2) id=695356 00007110.tif |  | DE-1032_2(2) id=695366 00007119.tif |  | DE-1033_2(2) id=695384 00007143.tif |
|  | DE-1034_2(2) id=695389 00007150.tif |  | DE-1035_2(2) id=695420 00007193.tif |  | DE-1036_2(2) id=695455 00007234.tif |
|  | DE-1037_2(2) id=695502 00007298.tif |  | DE-1038_2(2) id=695533 00007349.tif |  | DE-1039_2(2) id=695599 00007442.tif |
|  | DE-1040_2(2) id=695656 00007515.tif |  | DE-1041_2(2) id=695682 00007550.tif |  | DE-1042_2(2) id=695697 00007566.tif |















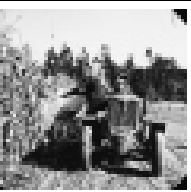



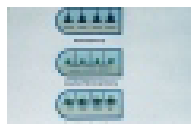



| | | | | | |
|---|---|---|---|---|---|
|  | DE-1043_2(2) id=695775 00007664.tif |  | DE-1044_2(2) id=695779 00007668.tif |  | DE-1045_2(2) id=695784 00007673.tif |
|  | DE-1046_2(2) id=695791 00007682.tif |  | DE-1047_2(2) id=695852 00007758.tif |  | DE-1048_2(2) id=695857 00007763.tif |
|  | DE-1049_2(2) id=696089 00008033.tif |  | DE-1050_2(2) id=696134 00008099.tif |  | DE-1051_2(2) id=696487 00008170.tif |
|  | DE-1052_2(2) id=696489 00008172.tif |  | DE-1053_2(2) id=696504 00008189.tif |  | DE-1054_2(2) id=696505 00008190.tif |
|  | DE-1055_2(2) id=696568 00008254.tif |  | DE-1056_2(2) id=696726 00008466.tif |  | DE-1057_2(2) id=696819 00008605.tif |
|  | DE-1058_2(2) id=696822 00008608.tif |  | DE-1059_2(2) id=696830 00008618.tif |  | DE-1060_2(2) id=696840 00008630.tif |
|  | DE-1061_2(2) id=696907 00008711.tif |  | DE-1062_2(2) id=696989 00008809.tif |  | DE-1063_2(2) id=697044 00008878.tif |
|  | DE-1064_2(2) id=697140 00008998.tif |  | DE-1065_2(2) id=697151 00009011.tif |  | DE-1066_2(2) id=697154 00009014.tif |
|  | DE-1067_2(2) id=697209 00009075.tif |  | DE-1068_2(2) id=697372 00009296.tif |  | DE-1069_2(2) id=697452 00009389.tif |
|  | DE-1070_2(2) id=697554 00009547.tif |  | DE-1071_2(2) id=697602 00009612.tif |  | DE-1072_2(2) id=698004 00010119.tif |
|  | DE-1073_2(2) id=698105 00010253.tif |  | DE-1074_2(2) id=698144 00010321.tif |  | DE-1075_2(2) id=698151 00010331.tif |













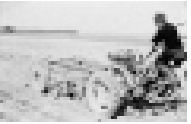



















| | | | | | |
|---|---|---|---|---|---|
|  | DE-1076_2(2) id=698201 00010417.tif |  | DE-1077_2(2) id=698327 00010676.tif |  | DE-1078_2(2) id=698334 00010690.tif |
|  | DE-1079_2(2) id=698472 00011058.tif |  | DE-1080_2(2) id=698778 00011576.tif |  | DE-1081_2(2) id=699285 00012486.tif |
|  | DE-1082_2(2) id=699297 00012501.tif |  | DE-1083_2(2) id=699299 00012503.tif |  | DE-1084_2(2) id=699375 00012595.tif |
|  | DE-1085_2(2) id=699379 00012600.tif |  | DE-1086_2(2) id=699386 00012607.tif |  | DE-1087_2(2) id=699590 00012989.tif |
|  | DE-1088_2(2) id=699713 00013127.tif |  | DE-1089_2(2) id=699969 00013507.tif |  | DE-1090_2(2) id=700136 00013913.tif |
|  | DE-1091_2(2) id=700171 00013954.tif |  | DE-1092_2(2) id=700245 00014033.tif |  | DE-1093_2(2) id=700361 00014264.tif |
|  | DE-1094_2(2) id=700363 00014266.tif |  | DE-1095_2(2) id=700490 00014500.tif |  | DE-1096_2(2) id=700496 00014506.tif |
|  | DE-1097_2(2) id=700675 00014713.tif |  | DE-1098_2(2) id=700809 00014855.tif |  | DE-1099_2(2) id=700938 00015007.tif |
|  | DE-1100_2(2) id=700949 00015017.tif |  | DE-1101_2(2) id=700965 00015031.tif |  | DE-1102_2(2) id=701016 00015068.tif |
|  | DE-1103_2(2) id=701041 00015095.tif |  | DE-1104_2(2) id=701060 00015106.tif |  | DE-1105_2(2) id=701090 00015118.tif |

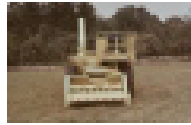



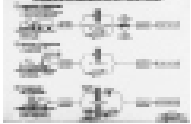

















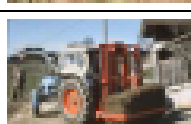

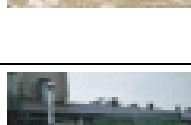
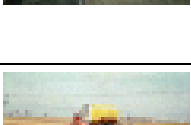

| | | | | | |
|---|---|---|---|---|---|
|  | DE-1106_2(2) id=701095 00015124.tif |  | DE-1107_2(2) id=701106 00015137.tif |  | DE-1108_2(2) id=701169 00015213.tif |
|  | DE-1109_2(2) id=701227 00015278.tif |  | DE-1110_2(2) id=701228 00015279.tif |  | DE-1111_2(2) id=701261 00015314.tif |
|  | DE-1112_2(2) id=701272 00015325.tif |  | DE-1113_2(2) id=701282 00015339.tif |  | DE-1114_2(2) id=701285 00015344.tif |
|  | DE-1115_2(2) id=701375 00015479.tif |  | DE-1116_2(2) id=701400 00015507.tif |  | DE-1117_2(2) id=701413 00015521.tif |
|  | DE-1118_2(2) id=701496 00015626.tif |  | DE-1119_2(2) id=701568 00015710.tif |  | DE-1120_2(2) id=701615 00015813.tif |
|  | DE-1121_2(2) id=701921 00016201.tif |  | DE-1122_2(2) id=701993 00016288.tif |  | DE-1123_2(2) id=702006 00016309.tif |
|  | DE-1124_2(2) id=702016 00016320.tif |  | DE-1125_2(2) id=702112 00016438.tif |  | DE-1126_2(2) id=702536 00016902.tif |
|  | DE-1127_2(2) id=702590 00016970.tif |  | DE-1128_2(2) id=702618 00017015.tif |  | DE-1129_2(2) id=702661 00017071.tif |

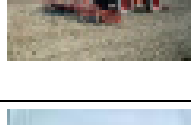













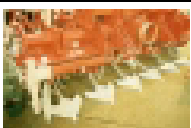

















| | | | | | |
|---|---|---|---|---|---|
|  | DE-1130_2(2) id=702879 00017587.tif |  | DE-1131_2(2) id=702901 00017620.tif |  | DE-1132_2(2) id=703447 00018329.tif |
|  | DE-1133_2(2) id=703486 00018372.tif |  | DE-1134_2(2) id=703489 00018375.tif |  | DE-1135_2(2) id=703499 00018387.tif |
|  | DE-1136_2(2) id=703558 00018463.tif |  | DE-1137_2(2) id=703630 00018548.tif |  | DE-1138_2(2) id=703697 00018641.tif |
|  | DE-1139_2(2) id=703702 00018647.tif |  | DE-1140_2(2) id=703707 00018654.tif |  | DE-1141_2(2) id=703711 00018658.tif |
|  | DE-1142_2(2) id=703719 00018667.tif |  | DE-1143_2(2) id=703768 00018729.tif |  | DE-1144_2(2) id=703823 00018790.tif |
|  | DE-1145_2(2) id=703827 00018794.tif |  | DE-1146_2(2) id=703928 00018936.tif |  | DE-1147_2(2) id=703983 00019014.tif |
|  | DE-1148_2(2) id=703992 00019030.tif |  | DE-1149_2(2) id=704004 00019045.tif |  | DE-1150_2(2) id=704005 00019046.tif |
|  | DE-1151_2(2) id=704008 00019050.tif |  | DE-1152_2(2) id=704022 00019066.tif |  | DE-1153_2(2) id=704025 00019070.tif |
|  | DE-1154_2(2) id=704042 00019095.tif |  | DE-1155_2(2) id=704201 00019318.tif |  | DE-1156_2(2) id=704262 00019394.tif |



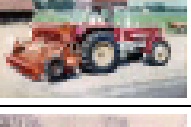
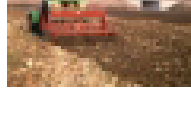







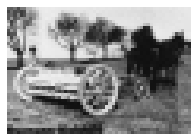
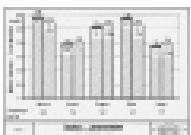

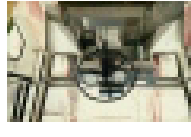

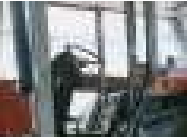

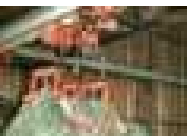

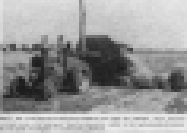

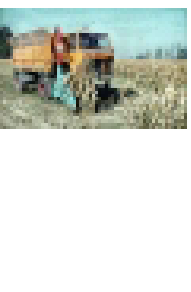
| | | | | | |
|---|---|---|---|---|---|
|  | DE-1157_2(2) id=704379 00019543.tif |  | DE-1158_2(2) id=704688 00019954.tif |  | DE-1159_2(2) id=704691 00019957.tif |
|  | DE-1160_2(2) id=704738 00020021.tif |  | DE-1161_2(2) id=704744 00020028.tif |  | DE-1162_2(2) id=704754 00020038.tif |
|  | DE-1163_2(2) id=704816 00020128.tif |  | DE-1164_2(2) id=705146 00020543.tif |  | DE-1165_2(2) id=705472 00020989.tif |
|  | DE-1166_2(2) id=705508 00021032.tif |  | DE-1167_2(2) id=705531 00021059.tif |  | DE-1168_2(2) id=705537 00021065.tif |
|  | DE-1169_2(2) id=705557 00021099.tif |  | DE-1170_2(2) id=705571 00021116.tif |  | DE-1171_2(2) id=706051 00021750.tif |
|  | DE-1172_2(2) id=706055 00021755.tif |  | DE-1173_2(2) id=706079 00021788.tif |  | DE-1174_2(2) id=706116 00021830.tif |
|  | DE-1175_2(2) id=706123 00021839.tif |  | DE-1176_2(2) id=706250 00022067.tif |  | DE-1177_2(2) id=706264 00022085.tif |
|  | DE-1178_2(2) id=706286 00022112.tif |  | DE-1179_2(2) id=706330 00022162.tif |  | DE-1180_2(2) id=706345 00022183.tif |
|  | DE-1181_2(2) id=706363 00022212.tif |  | DE-1182_2(2) id=706412 00022272.tif |  | DE-1183_2(2) id=706422 00022283.tif |

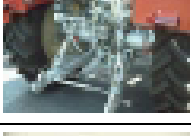
| | | | | | |
|---|---|---|---|---|---|
|  | DE-1184_2(2) id=706425 00022286.tif |  | DE-1185_2(2) id=706427 00022288.tif |  | DE-1186_2(2) id=706428 00022289.tif |
|  | DE-1187_2(2) id=706459 00022326.tif |  | DE-1188_2(2) id=706515 00022397.tif |  | DE-1189_2(2) id=706550 00022472.tif |
|  | DE-1190_2(2) id=706596 00022537.tif |  | DE-1191_2(2) id=706637 00022581.tif |  | DE-1192_2(2) id=706791 00022808.tif |
|  | DE-1193_2(2) id=706843 00022877.tif |  | DE-1194_2(2) id=706893 00022948.tif |  | DE-1195_2(2) id=706899 00022957.tif |
|  | DE-1196_2(2) id=706905 00022963.tif |  | DE-1197_2(2) id=706973 00023050.tif |  | DE-1198_2(2) id=707143 00023357.tif |
|  | DE-1199_2(2) id=707167 00023393.tif |  | DE-1200_2(2) id=707371 00023665.tif |  | DE-1201_2(2) id=707533 00023902.tif |
|  | DE-1202_2(2) id=707800 912500.png |  | DE-1203_2(2) id=708555 00025624.tif |  | DE-1204_2(2) id=708615 922348.png |
|  | DE-1205_2(2) id=708662 922150.png |  | DE-1206_2(2) id=708812 00026002.tif |  | DE-1207_2(2) id=708930 00026193.tif |



















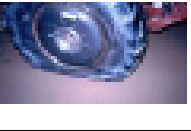



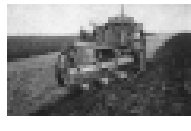
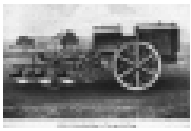









| | | | | | |
|---|---|---|---|---|---|
|  | DE-1208_2(2) id=709058 00026396.tif |  | DE-1209_2(2) id=709485 952124.png |  | DE-1210_2(2) id=709859 00027759.tif |
|  | DE-1211_2(2) id=710159 00028196.tif |  | DE-1212_2(2) id=710335 912356.png |  | DE-1213_2(2) id=710414 00028670.tif |
|  | DE-1214_2(2) id=710570 00028926.tif |  | DE-1215_2(2) id=710640 00029053.tif |  | DE-1216_2(2) id=710803 00029295.tif |
|  | DE-1217_2(2) id=710963 00029500.tif |  | DE-1218_2(2) id=710982 00029524.tif |  | DE-1219_2(2) id=711275 00029887.tif |
|  | DE-1220_2(2) id=711278 00029891.tif |  | DE-1221_2(2) id=711284 00029899.tif |  | DE-1222_2(2) id=711286 00029901.tif |
|  | DE-1223_2(2) id=711292 00029908.tif |  | DE-1224_2(2) id=711295 00029911.tif |  | DE-1225_2(2) id=711301 00029918.tif |
|  | DE-1226_2(2) id=711307 00029924.tif |  | DE-1227_2(2) id=711316 00029936.tif |  | DE-1228_2(2) id=711332 00029956.tif |
|  | DE-1229_2(2) id=711338 00029964.tif |  | DE-1230_2(2) id=711350 00029979.tif |  | DE-1231_2(2) id=711353 00029983.tif |
|  | DE-1232_2(2) id=711522 00030178.tif |  | DE-1233_2(2) id=711612 00030283.tif |  | DE-1234_2(2) id=711736 00030432.tif |
|  | DE-1235_2(2) id=711753 00030449.tif |  | DE-1236_2(2) id=711754 00030450.tif |  | DE-1237_2(2) id=711758 00030456.tif |
|  | DE-1238_2(2) id=711759 00030458.tif |  | DE-1239_2(2) id=711762 00030462.tif |  | DE-1240_2(2) id=711765 00030465.tif |

| | | | | | |
|---|---|---|---|---|---|
|  | DE-1241_2(2) id=711767 00030467.tif |  | DE-1242_2(2) id=711768 00030468.tif |  | DE-1243_2(2) id=711769 00030469.tif |
|  | DE-1244_2(2) id=711770 00030470.tif |  | DE-1245_2(2) id=711772 00030472.tif |  | DE-1246_2(2) id=711782 00030483.tif |
|  | DE-1247_2(2) id=711830 00030533.tif |  | DE-1248_2(2) id=711837 00030541.tif |  | DE-1249_2(2) id=711852 00030557.tif |
|  | DE-1250_2(2) id=711858 00030563.tif |  | DE-1251_2(2) id=711925 00030632.tif |  | DE-1252_2(2) id=711970 00030683.tif |
|  | DE-1253_2(2) id=711979 00030692.tif |  | DE-1254_2(2) id=711981 00030694.tif |  | DE-1255_2(2) id=711986 00030699.tif |
|  | DE-1256_2(2) id=712013 00030726.tif |  | DE-1257_2(2) id=712119 00030840.tif |  | DE-1258_2(2) id=712125 00030846.tif |
|  | DE-1259_2(2) id=712132 00030853.tif |  | DE-1260_2(2) id=712138 00030860.tif |  | DE-1261_2(2) id=712212 00030943.tif |
|  | DE-1262_2(2) id=712278 00031010.tif |  | DE-1263_2(2) id=712300 00031032.tif |  | DE-1264_2(2) id=712306 00031039.tif |
|  | DE-1265_2(2) id=712342 00031080.tif |  | DE-1266_2(2) id=712655 00031513.tif |  | DE-1267_2(2) id=712663 00031521.tif |
|  | DE-1268_2(2) id=712680 00031538.tif |  | DE-1269_2(2) id=712684 00031542.tif |  | DE-1270_2(2) id=712756 00031620.tif |

















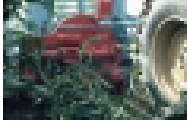









| | | |
|---|---|---|
|  DE-1271_2(2) id=712806 00031671.tif |  DE-1272_2(2) id=712810 00031675.tif |  DE-1273_2(2) id=712873 00031739.tif |
|  DE-1274_2(2) id=712931 00031808.tif |  DE-1275_2(2) id=712983 00031860.tif |  DE-1276_2(2) id=713006 00031883.tif |
|  DE-1277_2(2) id=713010 00031887.tif |  DE-1278_2(2) id=713012 00031890.tif |  DE-1279_2(2) id=713100 00031988.tif |
|  DE-1280_2(2) id=713126 00032015.tif |  DE-1281_2(2) id=713129 00032018.tif |  DE-1282_2(2) id=713132 00032021.tif |
|  DE-1283_2(2) id=713134 00032023.tif |  DE-1284_2(2) id=713208 00032099.tif |  DE-1285_2(2) id=713274 00032171.tif |
|  DE-1286_2(2) id=713309 00032206.tif |  DE-1287_2(2) id=713357 00032262.tif |  DE-1288_2(2) id=713432 00032345.tif |
|  DE-1289_2(2) id=713447 00032360.tif |  DE-1290_2(2) id=713483 00032398.tif |  DE-1291_2(2) id=713578 00032511.tif |
|  DE-1292_2(2) id=713591 00032524.tif |  DE-1293_2(2) id=713605 00032538.tif |  DE-1294_2(2) id=713640 00032576.tif |
|  DE-1295_2(2) id=713652 00032588.tif |  DE-1296_2(2) id=713660 00032596.tif |  DE-1297_2(2) id=713707 00032644.tif |
|  DE-1298_2(2) id=713747 00032684.tif |  DE-1299_2(2) id=713774 00032712.tif |  DE-1300_2(2) id=713837 00032780.tif |
|  DE-1301_2(2) id=713894 00032838.tif |  DE-1302_2(2) id=714028 00032976.tif |  DE-1303_2(2) id=714184 00033136.tif |

| | | | | | |
|---|---|---|---|---|---|
|  | DE-1304_2(2) id=714195 00033147.tif |  | DE-1305_2(2) id=714203 00033156.tif |  | DE-1306_2(2) id=714275 00033251.tif |
|  | DE-1307_2(2) id=714480 00033484.tif |  | DE-1308_2(2) id=714935 00034059.tif |  | DE-1309_2(2) id=714936 00034060.tif |
|  | DE-1310_2(2) id=715151 00034303.tif |  | DE-1311_2(2) id=715195 00034356.tif |  | DE-1312_2(2) id=715209 00034370.tif |
|  | DE-1313_2(2) id=715220 00034381.tif |  | DE-1314_2(2) id=715293 00034475.tif |  | DE-1315_2(2) id=715316 00034500.tif |
|  | DE-1316_2(2) id=715423 00034619.tif |  | DE-1317_2(2) id=715789 00035027.tif |  | DE-1318_2(2) id=715791 00035029.tif |
|  | DE-1319_2(2) id=715793 00035031.tif |  | DE-1320_2(2) id=715934 00035220.tif |  | DE-1321_2(2) id=716035 00035359.tif |
|  | DE-1322_2(2) id=716083 00035414.tif |  | DE-1323_2(2) id=716084 00035415.tif |  | DE-1324_2(2) id=716312 00035678.tif |
|  | DE-1325_2(2) id=716369 00035743.tif |  | DE-1326_2(2) id=716370 00035744.tif |  | DE-1327_2(2) id=716371 00035745.tif |

| | | | | | |
|---|---|---|---|---|---|
|  | DE-1328_2(2) id=716404 00035778.tif |  | DE-1329_2(2) id=716421 00035795.tif |  | DE-1330_2(2) id=716571 972052.png |
|  | DE-1331_2(2) id=716740 00036231.tif |  | DE-1332_2(2) id=716747 00036240.tif |  | DE-1333_2(2) id=716748 00036241.tif |
|  | DE-1334_2(2) id=716777 00036270.tif |  | DE-1335_2(2) id=716819 00036313.tif |  | DE-1336_2(2) id=716822 00036316.tif |
|  | DE-1337_2(2) id=716860 00036355.tif |  | DE-1338_2(2) id=716871 00036366.tif |  | DE-1339_2(2) id=716927 00036426.tif |
|  | DE-1340_2(2) id=716935 00036435.tif |  | DE-1341_2(2) id=716955 00036455.tif |  | DE-1342_2(2) id=716969 00036469.tif |
|  | DE-1343_2(2) id=716981 00036482.tif |  | DE-1344_2(2) id=717074 00036578.tif |  | DE-1345_2(2) id=717231 00036744.tif |
|  | DE-1346_2(2) id=717232 00036745.tif |  | DE-1347_2(2) id=717233 00036746.tif |  | DE-1348_2(2) id=717238 00036752.tif |
|  | DE-1349_2(2) id=717293 00036809.tif |  | DE-1350_2(2) id=717425 00036956.tif |  | DE-1351_2(2) id=717661 00037217.tif |
|  | DE-1352_2(2) id=717664 00037220.tif |  | DE-1353_2(2) id=717806 00037371.tif |  | DE-1354_2(2) id=717853 00037428.tif |
|  | DE-1355_2(2) id=717867 00037442.tif |  | DE-1356_2(2) id=717870 00037445.tif |  | DE-1357_2(2) id=717872 00037447.tif |
|  | DE-1358_2(2) id=717881 00037458.tif |  | DE-1359_2(2) id=717882 00037459.tif |  | DE-1360_2(2) id=717883 00037460.tif |
|  | DE-1361_2(2) id=717884 00037461.tif |  | DE-1362_2(2) id=717893 00037471.tif |  | DE-1363_2(2) id=717894 00037472.tif |











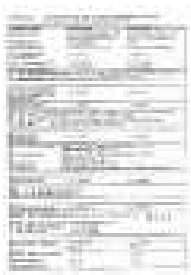









| | | | | | |
|---|---|---|---|---|---|
|  | DE-1364_2(2) id=717970 00037553.tif |  | DE-1365_2(2) id=717983 00037566.tif |  | DE-1366_2(2) id=718006 00037592.tif |
|  | DE-1367_2(2) id=718060 00037646.tif |  | DE-1368_2(2) id=718313 00037912.tif |  | DE-1369_2(2) id=718327 00037926.tif |
|  | DE-1370_2(2) id=718563 00038185.tif |  | DE-1371_2(2) id=718615 00038237.tif |  | DE-1372_2(2) id=718617 00038239.tif |
|  | DE-1373_2(2) id=718746 00038374.tif |  | DE-1374_2(2) id=718747 00038375.tif |  | DE-1375_2(2) id=718811 00038447.tif |
|  | DE-1376_2(2) id=719087 00038752.tif |  | DE-1377_2(2) id=719089 00038754.tif |  | DE-1378_2(2) id=719113 00038785.tif |
|  | DE-1379_2(2) id=719129 00038801.tif |  | DE-1380_2(2) id=719136 00038808.tif |  | DE-1381_2(2) id=719233 00038907.tif |
|  | DE-1382_2(2) id=719274 00038948.tif |  | DE-1383_2(2) id=719322 00039004.tif |  | DE-1384_2(2) id=719471 00039162.tif |
|  | DE-1385_2(2) id=719502 00039193.tif |  | DE-1386_2(2) id=719520 00039212.tif |  | DE-1387_2(2) id=719539 00039232.tif |
|  | DE-1388_2(2) id=719555 00039248.tif |  | DE-1389_2(2) id=719576 00039274.tif |  | DE-1390_2(2) id=719766 00039478.tif |
|  | DE-1391_2(2) id=719769 00039481.tif |  | DE-1392_2(2) id=719805 00039520.tif |  | DE-1393_2(2) id=719847 00039569.tif |
|  | DE-1394_2(2) id=719902 00039635.tif |  | DE-1395_2(2) id=719982 00039722.tif |  | DE-1396_2(2) id=719996 00039736.tif |



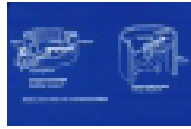
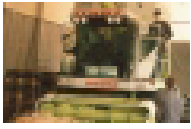
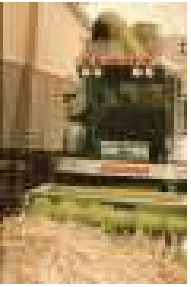



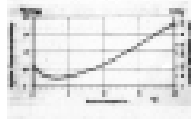











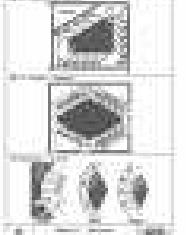





| | | | | | |
|---|---|---|---|---|---|
|  | DE-1397_2(2) id=719997 00039737.tif |  | DE-1398_2(2) id=720145 00039905.tif |  | DE-1399_2(2) id=720158 00039926.tif |
|  | DE-1400_2(2) id=720320 00040112.tif |  | DE-1401_2(2) id=720322 00040114.tif |  | DE-1402_2(2) id=720323 00040115.tif |
|  | DE-1403_2(2) id=720351 00040146.tif |  | DE-1404_2(2) id=720355 00040150.tif |  | DE-1405_2(2) id=720547 00040346.tif |
|  | DE-1406_2(2) id=720633 00040438.tif |  | DE-1407_2(2) id=720670 00040475.tif |  | DE-1408_2(2) id=720672 00040477.tif |
|  | DE-1409_2(2) id=720680 00040486.tif |  | DE-1410_2(2) id=720681 00040487.tif |  | DE-1411_2(2) id=720719 00040528.tif |
|  | DE-1412_2(2) id=720729 00040538.tif |  | DE-1413_2(2) id=720736 00040545.tif |  | DE-1414_2(2) id=720772 00040582.tif |
|  | DE-1415_2(2) id=720779 00040598.tif |  | DE-1416_2(2) id=720786 00040608.tif |  | DE-1417_2(2) id=720787 00040609.tif |
|  | DE-1418_2(2) id=720863 00040690.tif |  | DE-1419_2(2) id=720865 00040692.tif |  | DE-1420_2(2) id=720867 00040694.tif |
|  | DE-1421_2(2) id=720868 00040695.tif |  | DE-1422_2(2) id=720869 00040696.tif |  | DE-1423_2(2) id=720959 00040811.tif |
|  | DE-1424_2(2) id=721003 00040862.tif |  | DE-1425_2(2) id=721004 00040863.tif |  | DE-1426_2(2) id=721042 00040901.tif |
|  | DE-1427_2(2) id=721065 00040927.tif |  | DE-1428_2(2) id=721067 00040929.tif |  | DE-1429_2(2) id=721071 00040933.tif |





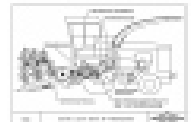
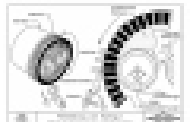
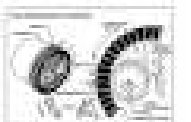





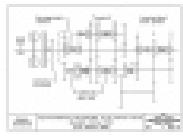







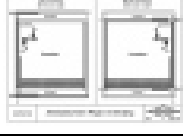









| | | | | | |
|---|---|---|---|---|---|
|  | DE-1430_2(2) id=721139 00041020.tif |  | DE-1431_2(2) id=721142 00041023.tif |  | DE-1432_2(2) id=721145 00041026.tif |
|  | DE-1433_2(2) id=721148 00041029.tif |  | DE-1434_2(2) id=721150 00041031.tif |  | DE-1435_2(2) id=721152 00041033.tif |
|  | DE-1436_2(2) id=721166 00041047.tif |  | DE-1437_2(2) id=721169 00041050.tif |  | DE-1438_2(2) id=721170 00041051.tif |
|  | DE-1439_2(2) id=721190 00041071.tif |  | DE-1440_2(2) id=721193 00041074.tif |  | DE-1441_2(2) id=721198 00041080.tif |
|  | DE-1442_2(2) id=721202 00041084.tif |  | DE-1443_2(2) id=721208 00041090.tif |  | DE-1444_2(2) id=721209 00041091.tif |
|  | DE-1445_2(2) id=721232 00041119.tif |  | DE-1446_2(2) id=721234 00041121.tif |  | DE-1447_2(2) id=721251 00041145.tif |
|  | DE-1448_2(2) id=721255 00041149.tif |  | DE-1449_2(2) id=721279 00041178.tif |  | DE-1450_2(2) id=721281 00041180.tif |
|  | DE-1451_2(2) id=721335 00041241.tif |  | DE-1452_2(2) id=721369 00041278.tif |  | DE-1453_2(2) id=721489 00041435.tif |
|  | DE-1454_2(2) id=721739 00041853.tif |  | DE-1455_2(2) id=721857 00041992.tif |  | DE-1456_2(2) id=721885 00042027.tif |















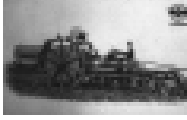

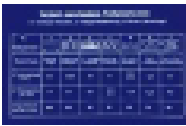
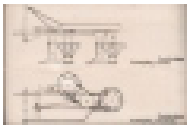
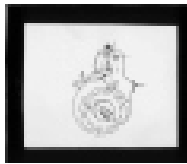
| | | |
|---|---|---|
|  DE-1457_2(2) id=721950 00042095.tif |  DE-1458_2(2) id=721953 00042098.tif |  DE-1459_2(2) id=721955 00042100.tif |
|  DE-1460_2(2) id=721964 00042109.tif |  DE-1461_2(2) id=722039 00042188.tif |  DE-1462_2(2) id=722062 00042213.tif |
|  DE-1463_2(2) id=722071 00042222.tif |  DE-1464_2(2) id=722101 00042259.tif |  DE-1465_2(2) id=722125 00042283.tif |
|  DE-1466_2(2) id=722296 00042461.tif |  DE-1467_2(2) id=722308 00042473.tif |  DE-1468_2(2) id=722341 00042507.tif |
|  DE-1469_2(2) id=722406 00042580.tif |  DE-1470_2(2) id=722407 00042581.tif |  DE-1471_2(2) id=722411 00042585.tif |
|  DE-1472_2(2) id=722425 00042599.tif |  DE-1473_2(2) id=722431 00042605.tif |  DE-1474_2(2) id=722433 00042607.tif |
|  DE-1475_2(2) id=722435 00042609.tif |  DE-1476_2(2) id=722437 00042611.tif |  DE-1477_2(2) id=722439 00042613.tif |
|  DE-1478_2(2) id=722446 00042620.tif |  DE-1479_2(2) id=722462 00042636.tif |  DE-1480_2(2) id=722469 00042643.tif |
|  DE-1481_2(2) id=722514 00042698.tif |  DE-1482_2(2) id=722515 00042699.tif |  DE-1483_2(2) id=722595 00042809.tif |
|  DE-1484_2(2) id=722803 00043032.tif |  DE-1485_2(2) id=722816 00043045.tif |  DE-1486_2(2) id=722822 00043051.tif |
|  DE-1487_2(2) id=722876 00043115.tif |  DE-1488_2(2) id=722900 00043143.tif |  DE-1489_2(2) id=722906 00043149.tif |

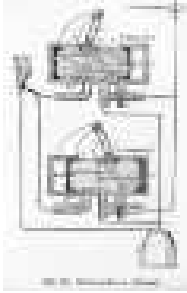

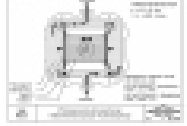



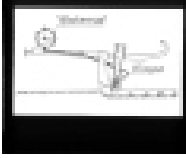





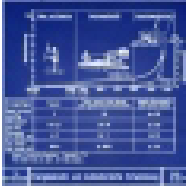







| | | |
|---|---|---|
|  DE-1490_2(2) id=722927 00043176.tif |  DE-1491_2(2) id=722948 00043202.tif |  DE-1492_2(2) id=722954 00043209.tif |
|  DE-1493_2(2) id=722965 00043220.tif |  DE-1494_2(2) id=722971 00043227.tif |  DE-1495_2(2) id=723170 00043448.tif |
|  DE-1496_2(2) id=723181 00043459.tif |  DE-1497_2(2) id=723198 00043476.tif |  DE-1498_2(2) id=723601 00043921.tif |
|  DE-1499_2(2) id=723727 00044050.tif |  DE-1500_2(2) id=723729 00044052.tif |  DE-1501_2(2) id=723751 00044074.tif |
|  DE-1502_2(2) id=723757 00044080.tif |  DE-1503_2(2) id=723758 00044081.tif |  DE-1504_2(2) id=723908 00044245.tif |
|  DE-1505_2(2) id=723925 00044262.tif |  DE-1506_2(2) id=723954 00044291.tif |  DE-1507_2(2) id=724038 00044375.tif |
|  DE-1508_2(2) id=724078 00044415.tif |  DE-1509_2(2) id=724089 00044426.tif |  DE-1510_2(2) id=724180 00044524.tif |
|  DE-1511_2(2) id=724270 00044631.tif |  DE-1512_2(2) id=724300 00044664.tif |  DE-1513_2(2) id=724390 00044775.tif |
|  DE-1514_2(2) id=724434 00044819.tif |  DE-1515_2(2) id=724451 00044836.tif |  DE-1516_2(2) id=725054 00045455.tif |
|  DE-1517_2(2) id=725191 00045602.tif |  DE-1518_2(2) id=725192 00045603.tif |  DE-1519_2(2) id=725325 00045739.tif |

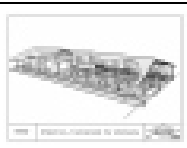







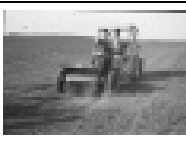

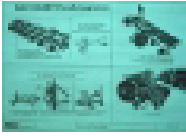

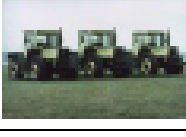





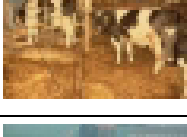

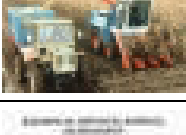





| | | | | | |
|---|---|---|---|---|---|
|  | DE-1520_2(2) id=725531 00045955.tif |  | DE-1521_2(2) id=726902 00047427.tif |  | DE-1522_2(2) id=726930 00047455.tif |
|  | DE-1523_2(2) id=727610 00048157.tif |  | DE-1524_2(2) id=727670 00048217.tif |  | DE-1525_2(2) id=728240 00048794.tif |
|  | DE-1526_2(2) id=728377 00048934.tif |  | DE-1527_2(2) id=728704 00049286.tif |  | DE-1528_2(2) id=728974 00049584.tif |
|  | DE-1529_2(2) id=729106 00049744.tif |  | DE-1530_2(2) id=729190 00049829.tif |  | DE-1531_2(2) id=729206 00049847.tif |
|  | DE-1532_2(2) id=729223 00049866.tif |  | DE-1533_2(2) id=729258 00049909.tif |  | DE-1534_2(2) id=729875 00050584.tif |
|  | DE-1535_2(2) id=729878 00050587.tif |  | DE-1536_2(2) id=729996 00050712.tif |  | DE-1537_2(2) id=730017 00050732.tif |
|  | DE-1538_2(2) id=730451 00051262.tif |  | DE-1539_2(2) id=730500 00051310.tif |  | DE-1540_2(2) id=730501 00051311.tif |
|  | DE-1541_2(2) id=730543 00051356.tif |  | DE-1542_2(2) id=730544 00051357.tif |  | DE-1543_2(2) id=730545 00051358.tif |







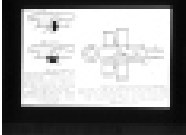



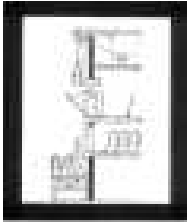

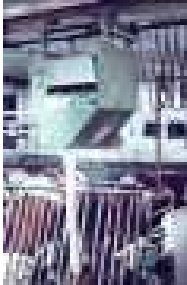











| | | | | | |
|---|---|---|---|---|---|
|  | DE-1544_2(2) id=730559 00051390.tif |  | DE-1545_2(2) id=730574 00051414.tif |  | DE-1546_2(2) id=730621 00051466.tif |
|  | DE-1547_2(2) id=730643 00051492.tif |  | DE-1548_2(2) id=730661 00051512.tif |  | DE-1549_2(2) id=730776 00051630.tif |
|  | DE-1550_2(2) id=730925 912474.png |  | DE-1551_2(2) id=731212 932125.png |  | DE-1552_2(2) id=731215 932131.png |
|  | DE-1553_2(2) id=731483 942196.png |  | DE-1554_2(2) id=731829 952342.png |  | DE-1555_2(2) id=731868 952389.png |
|  | DE-1556_2(2) id=731955 962031.png |  | DE-1557_2(2) id=731963 962040.png |  | DE-1558_2(2) id=732026 962121.png |
|  | DE-1559_2(2) id=732056 962153.png |  | DE-1560_2(2) id=732064 962162.png |  | DE-1561_2(2) id=732069 962168.png |
|  | DE-1562_2(2) id=732072 962173.png |  | DE-1563_2(2) id=732097 962211.png |  | DE-1564_2(2) id=732104 962222.png |
|  | DE-1565_2(2) id=732111 962230.png |  | DE-1566_2(2) id=732175 962313.png |  | DE-1567_2(2) id=732178 962316.png |
|  | DE-1568_2(2) id=732194 962344.png |  | DE-1569_2(2) id=732350 972132.png |  | DE-1570_2(2) id=732645 982031.png |

| | | | | | |
|---|--|---|---|---|--|
|  | DE-1571_2(2) id=732701 982096.png |  | DE-1572_2(2) id=732716 982114.png |  | DE-1573_2(2) id=732877 982296.png |
|  | DE-1574_2(2) id=732894 982313.png |  | DE-1575_2(2) id=732977 992039.png |  | DE-1576_2(2) id=733144 002005.png |
|  | DE-1577_2(2) id=733162 002027.png |  | DE-1578_2(2) id=733186 002051.png |  | DE-1579_2(2) id=733439 012104.png |
|  | DE-1580_2(2) id=733462 012127.png |  | DE-1581_2(2) id=733472 012137.png |  | DE-1582_2(2) id=733538 012206.png |
|  | DE-1583_2(2) id=733587 022008.png |  | DE-1584_2(2) id=733594 022015.png |  | DE-1585_2(2) id=733607 022028.png |
|  | DE-1586_2(2) id=733659 022082.png |  | DE-1587_2(2) id=733783 022220.png |  | DE-1588_2(2) id=734246 042058.png |
|  | DE-1589_2(2) id=734358 062015.png |  | DE-1590_2(2) id=811793 JLUG-00002.tif |  | DE-1591_2(2) id=1198415 00051679.tif |
|  | DE-1592_2(2) id=1198417 00051681.tif |  | DE-1593_2(2) id=1198420 00051684.tif |  | DE-1594_2(2) id=1208044 00051921.tif |
|  | DE-1595_2(2) id=1208259 00052088.tif |  | DE-1596_2(2) id=1208348 00052166.tif |  | DE-1597_2(2) id=1208353 00052077.tif |
|  | DE-1598_2(2) id=1208358 00052082.tif |  | DE-1599_2(2) id=1208359 00052133.tif |  | DE-1600_2(2) id=1208371 00052092.tif |







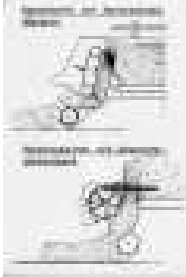





















| | | | | | |
|---|--|---|--|---|--|
|  | DE-1601_1(7) id=720020 00039761.tif |  | DE-1602_1(6) id=13077 00008535.tif |  | DE-1603_1(6) id=701166 00015210.tif |
|  | DE-1604_1(5) id=694756 00006396.tif |  | DE-1605_1(5) id=719088 00038753.tif |  | DE-1606_1(5) id=722920 00043168.tif |
|  | DE-1607_1(5) id=729490 00050225.tif |  | DE-1608_1(4) id=13023 00007792.tif |  | DE-1609_1(4) id=641177 hub-00154.tif |
|  | DE-1610_1(4) id=696609 00008301.tif |  | DE-1611_1(4) id=704581 00019804.tif |  | DE-1612_1(4) id=713729 00032666.tif |
|  | DE-1613_1(4) id=719090 00038755.tif |  | DE-1614_1(4) id=732574 972469.png |  | DE-1615_1(4) id=732963 992024.png |
|  | DE-1616_1(3) id=13989 00015711.tif |  | DE-1617_1(3) id=15907 00043477.tif |  | DE-1618_1(3) id=640939 hub-01153.tif |
|  | DE-1619_1(3) id=643312 hub-03365.tif |  | DE-1620_1(3) id=643313 hub-03364.tif |  | DE-1621_1(3) id=694907 00006565.tif |

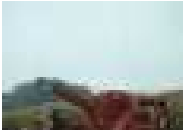









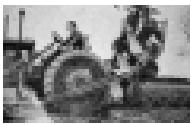
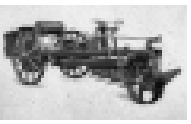
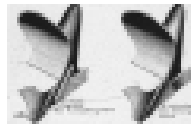

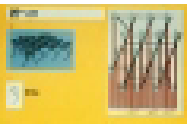









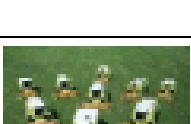
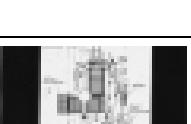
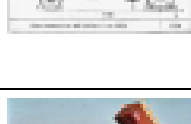
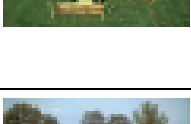
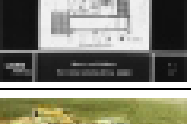





| | | | | | |
|---|---|---|---|---|---|
|  | DE-1622_1(3) id=696589 00008279.tif |  | DE-1623_1(3) id=699999 00013539.tif |  | DE-1624_1(3) id=700421 00014327.tif |
|  | DE-1625_1(3) id=702288 00016599.tif |  | DE-1626_1(3) id=703825 00018792.tif |  | DE-1627_1(3) id=704682 00019947.tif |
|  | DE-1628_1(3) id=706940 00023006.tif |  | DE-1629_1(3) id=713015 00031893.tif |  | DE-1630_1(3) id=716921 00036418.tif |
|  | DE-1631_1(3) id=716971 00036471.tif |  | DE-1632_1(3) id=719081 00038746.tif |  | DE-1633_1(3) id=721925 00042069.tif |
|  | DE-1634_1(3) id=722410 00042584.tif |  | DE-1635_1(3) id=730797 912086.png |  | DE-1636_1(3) id=732131 962262.png |
|  | DE-1637_1(3) id=732503 972367.png |  | DE-1638_1(3) id=732990 992054.png |  | DE-1639_1(3) id=733546 012214.png |
|  | DE-1640_1(3) id=811796 JLUG-00068.tif |  | DE-1641_1(2) id=12066 00000428.tif |  | DE-1642_1(2) id=12175 00001028.tif |
|  | DE-1643_1(2) id=12320 00002325.tif |  | DE-1644_1(2) id=12413 00003282.tif |  | DE-1645_1(2) id=12744 00005060.tif |







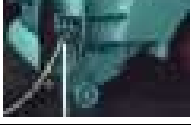



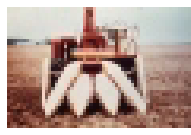







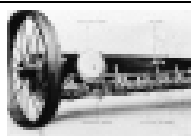









| | | | | | |
|---|--|---|--|---|--|
|  | DE-1646_1(2) id=12818 00005684.tif |  | DE-1647_1(2) id=12971 00007147.tif |  | DE-1648_1(2) id=13133 00009038.tif |
|  | DE-1649_1(2) id=13267 00010271.tif |  | DE-1650_1(2) id=13402 00010791.tif |  | DE-1651_1(2) id=13661 00011902.tif |
|  | DE-1652_1(2) id=13733 00012066.tif |  | DE-1653_1(2) id=13739 00012072.tif |  | DE-1654_1(2) id=13824 00012653.tif |
|  | DE-1655_1(2) id=13990 00015716.tif |  | DE-1656_1(2) id=14038 00015798.tif |  | DE-1657_1(2) id=14126 00016228.tif |
|  | DE-1658_1(2) id=14151 00016466.tif |  | DE-1659_1(2) id=14192 00016951.tif |  | DE-1660_1(2) id=14322 00017787.tif |
|  | DE-1661_1(2) id=14514 00019863.tif |  | DE-1662_1(2) id=14520 00019944.tif |  | DE-1663_1(2) id=14609 00021126.tif |
|  | DE-1664_1(2) id=14611 00021133.tif |  | DE-1665_1(2) id=14846 00023331.tif |  | DE-1666_1(2) id=14871 00023401.tif |
|  | DE-1667_1(2) id=14950 00023805.tif |  | DE-1668_1(2) id=14961 00023847.tif |  | DE-1669_1(2) id=15386 00027330.tif |
|  | DE-1670_1(2) id=15621 00028588.tif |  | DE-1671_1(2) id=15849 00029960.tif |  | DE-1672_1(2) id=15856 00030454.tif |
|  | DE-1673_1(2) id=640027 hub-03675.tif |  | DE-1674_1(2) id=641070 hub-05516.tif |  | DE-1675_1(2) id=641871 hub-02167.tif |











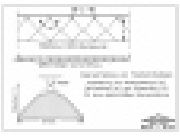

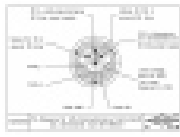

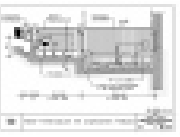

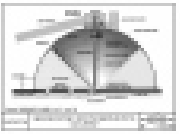
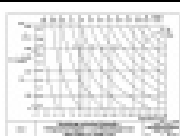











| | | | | | |
|---|--|---|--|---|--|
|  | DE-1676_1(2) id=642223 hub-00613.tif |  | DE-1677_1(2) id=642441 hub-00587.tif |  | DE-1678_1(2) id=643026 hub-02754.tif |
|  | DE-1679_1(2) id=643326 hub-01292.tif |  | DE-1680_1(2) id=690289 00000850.tif |  | DE-1681_1(2) id=690329 00000895.tif |
|  | DE-1682_1(2) id=691410 00002425.tif |  | DE-1683_1(2) id=694792 00006438.tif |  | DE-1684_1(2) id=695114 00006817.tif |
|  | DE-1685_1(2) id=695436 00007212.tif |  | DE-1686_1(2) id=696783 00008555.tif |  | DE-1687_1(2) id=696808 00008591.tif |
|  | DE-1688_1(2) id=696820 00008606.tif |  | DE-1689_1(2) id=696847 00008637.tif |  | DE-1690_1(2) id=696959 00008776.tif |
|  | DE-1691_1(2) id=697174 00009035.tif |  | DE-1692_1(2) id=697175 00009036.tif |  | DE-1693_1(2) id=697697 00009735.tif |
|  | DE-1694_1(2) id=697840 00009910.tif |  | DE-1695_1(2) id=698980 00011964.tif |  | DE-1696_1(2) id=699721 00013137.tif |
|  | DE-1697_1(2) id=699998 00013538.tif |  | DE-1698_1(2) id=700130 00013904.tif |  | DE-1699_1(2) id=700350 00014253.tif |
|  | DE-1700_1(2) id=700500 00014511.tif |  | DE-1701_1(2) id=700940 00015009.tif |  | DE-1702_1(2) id=701199 00015249.tif |















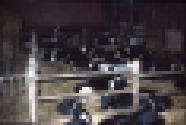

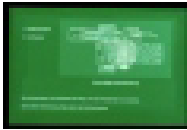



| | | | | | |
|---|---|---|---|---|---|
|  | DE-1703_1(2) id=701220 00015273.tif |  | DE-1704_1(2) id=701333 00015417.tif |  | DE-1705_1(2) id=701424 00015533.tif |
|  | DE-1706_1(2) id=701479 00015603.tif |  | DE-1707_1(2) id=701563 00015702.tif |  | DE-1708_1(2) id=701600 00015788.tif |
|  | DE-1709_1(2) id=701807 00016069.tif |  | DE-1710_1(2) id=701904 00016191.tif |  | DE-1711_1(2) id=701916 00016192.tif |
|  | DE-1712_1(2) id=702056 00016367.tif |  | DE-1713_1(2) id=702082 00016397.tif |  | DE-1714_1(2) id=703313 00018171.tif |
|  | DE-1715_1(2) id=703619 00018534.tif |  | DE-1716_1(2) id=703705 00018652.tif |  | DE-1717_1(2) id=703709 00018656.tif |
|  | DE-1718_1(2) id=704048 00019104.tif |  | DE-1719_1(2) id=704292 00019433.tif |  | DE-1720_1(2) id=704293 00019434.tif |
|  | DE-1721_1(2) id=704622 00019860.tif |  | DE-1722_1(2) id=704680 00019945.tif |  | DE-1723_1(2) id=704686 00019951.tif |
|  | DE-1724_1(2) id=704689 00019955.tif |  | DE-1725_1(2) id=705265 942004.png |  | DE-1726_1(2) id=705547 00021083.tif |

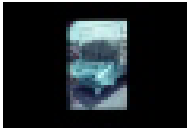
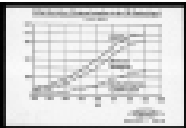

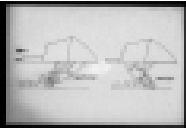
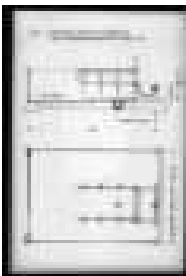







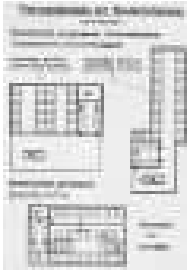









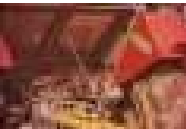





| | | | | | |
|---|---|---|---|---|---|
|  | DE-1727_1(2) id=705751 952065.png |  | DE-1728_1(2) id=705879 00021538.tif |  | DE-1729_1(2) id=706457 00022324.tif |
|  | DE-1730_1(2) id=706585 00022519.tif |  | DE-1731_1(2) id=707022 00023114.tif |  | DE-1732_1(2) id=707458 00023780.tif |
|  | DE-1733_1(2) id=709039 00026376.tif |  | DE-1734_1(2) id=709122 952252.png |  | DE-1735_1(2) id=711285 00029900.tif |
|  | DE-1736_1(2) id=711462 00030116.tif |  | DE-1737_1(2) id=711532 00030188.tif |  | DE-1738_1(2) id=712408 00031156.tif |
|  | DE-1739_1(2) id=712796 00031661.tif |  | DE-1740_1(2) id=712992 00031869.tif |  | DE-1741_1(2) id=713267 00032164.tif |
|  | DE-1742_1(2) id=713670 00032606.tif |  | DE-1743_1(2) id=713799 00032737.tif |  | DE-1744_1(2) id=714074 00033023.tif |
|  | DE-1745_1(2) id=714319 00033300.tif |  | DE-1746_1(2) id=715479 00034679.tif |  | DE-1747_1(2) id=715712 00034944.tif |
|  | DE-1748_1(2) id=715773 00035011.tif |  | DE-1749_1(2) id=716869 00036364.tif |  | DE-1750_1(2) id=716894 00036391.tif |
|  | DE-1751_1(2) id=716925 00036423.tif |  | DE-1752_1(2) id=716972 00036472.tif |  | DE-1753_1(2) id=717058 00036562.tif |
|  | DE-1754_1(2) id=717071 00036575.tif |  | DE-1755_1(2) id=717093 00036597.tif |  | DE-1756_1(2) id=717810 00037375.tif |





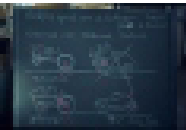









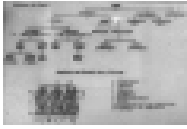
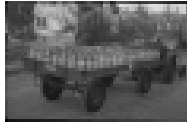



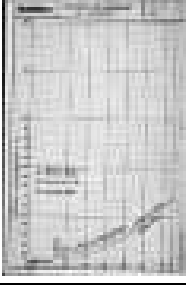







| | | | | | |
|---|---|---|---|---|---|
|  | DE-1757_1(2) id=718053 00037639.tif |  | DE-1758_1(2) id=719072 00038736.tif |  | DE-1759_1(2) id=719084 00038749.tif |
|  | DE-1760_1(2) id=719097 00038762.tif |  | DE-1761_1(2) id=719503 00039194.tif |  | DE-1762_1(2) id=719531 00039223.tif |
|  | DE-1763_1(2) id=719572 00039270.tif |  | DE-1764_1(2) id=719583 00039282.tif |  | DE-1765_1(2) id=719587 00039287.tif |
|  | DE-1766_1(2) id=719922 00039660.tif |  | DE-1767_1(2) id=719923 00039661.tif |  | DE-1768_1(2) id=719943 00039683.tif |
|  | DE-1769_1(2) id=719972 00039712.tif |  | DE-1770_1(2) id=720090 00039837.tif |  | DE-1771_1(2) id=720296 00040080.tif |
|  | DE-1772_1(2) id=720319 00040111.tif |  | DE-1773_1(2) id=720357 00040152.tif |  | DE-1774_1(2) id=720525 00040323.tif |
|  | DE-1775_1(2) id=720582 00040382.tif |  | DE-1776_1(2) id=720586 00040386.tif |  | DE-1777_1(2) id=720589 00040390.tif |
|  | DE-1778_1(2) id=720643 00040448.tif |  | DE-1779_1(2) id=720754 00040563.tif |  | DE-1780_1(2) id=720810 00040636.tif |
|  | DE-1781_1(2) id=720813 00040639.tif |  | DE-1782_1(2) id=720883 00040713.tif |  | DE-1783_1(2) id=720887 00040717.tif |
|  | DE-1784_1(2) id=720964 00040817.tif |  | DE-1785_1(2) id=720974 00040831.tif |  | DE-1786_1(2) id=720983 00040842.tif |
|  | DE-1787_1(2) id=720984 00040843.tif |  | DE-1788_1(2) id=720985 00040844.tif |  | DE-1789_1(2) id=720994 00040853.tif |
|  | DE-1790_1(2) id=720995 00040854.tif |  | DE-1791_1(2) id=720998 00040857.tif |  | DE-1792_1(2) id=721147 00041028.tif |

















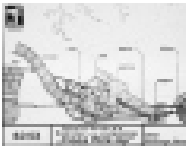
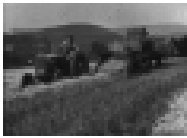





| | | | | | |
|---|---|---|---|---|---|
|  | DE-1793_1(2) id=721187 00041068.tif |  | DE-1794_1(2) id=721188 00041069.tif |  | DE-1795_1(2) id=721256 00041150.tif |
|  | DE-1796_1(2) id=721312 00041216.tif |  | DE-1797_1(2) id=721355 00041262.tif |  | DE-1798_1(2) id=721486 00041431.tif |
|  | DE-1799_1(2) id=721749 00041863.tif |  | DE-1800_1(2) id=722079 00042233.tif |  | DE-1801_1(2) id=722361 00042532.tif |
|  | DE-1802_1(2) id=722925 00043173.tif |  | DE-1803_1(2) id=723645 00043967.tif |  | DE-1804_1(2) id=723647 00043969.tif |
|  | DE-1805_1(2) id=723719 00044042.tif |  | DE-1806_1(2) id=723723 00044046.tif |  | DE-1807_1(2) id=723754 00044077.tif |
|  | DE-1808_1(2) id=723882 00044219.tif |  | DE-1809_1(2) id=723884 00044221.tif |  | DE-1810_1(2) id=724237 00044589.tif |
|  | DE-1811_1(2) id=724317 00044682.tif |  | DE-1812_1(2) id=728501 00049073.tif |  | DE-1813_1(2) id=728620 00049199.tif |
|  | DE-1814_1(2) id=728705 00049287.tif |  | DE-1815_1(2) id=729176 00049815.tif |  | DE-1816_1(2) id=729738 00050443.tif |
|  | DE-1817_1(2) id=730013 00050727.tif |  | DE-1818_1(2) id=730050 00050766.tif |  | DE-1819_1(2) id=730624 00051469.tif |
|  | DE-1820_1(2) id=730658 00051509.tif |  | DE-1821_1(2) id=730777 00051631.tif |  | DE-1822_1(2) id=730802 912094.png |

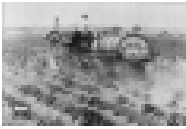
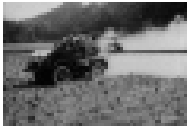
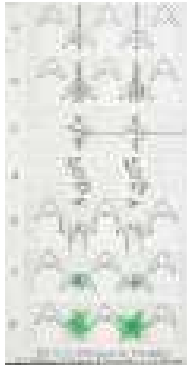

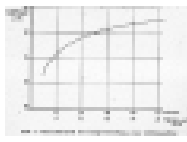











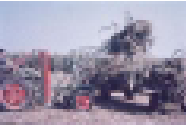



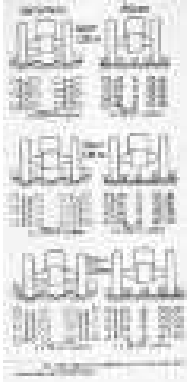

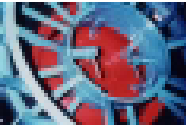
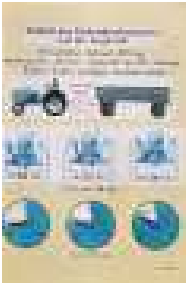
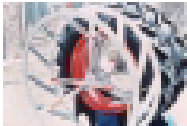

| | | | | | |
|---|--|---|--|---|--|
|  | DE-1823_1(2) id=731141 932013.png |  | DE-1824_1(2) id=731534 942293.png |  | DE-1825_1(2) id=732093 962206.png |
|  | DE-1826_1(2) id=732504 972368.png |  | DE-1827_1(2) id=732874 982293.png |  | DE-1828_1(2) id=732926 982354.png |
|  | DE-1829_1(2) id=733073 992146.png |  | DE-1830_1(2) id=733201 002067.png |  | DE-1831_1(2) id=733375 012038.png |
|  | DE-1832_1(2) id=733779 022216.png |  | DE-1833_1(2) id=733860 022299.png |  | DE-1834_1(2) id=1198424 00051688.tif |
|  | DE-1835_1(2) id=1208240 00051943.tif |  | DE-1836_1(2) id=1208365 00052181.tif |  | DE-1837_1(1) id=11995 00000036.tif |
|  | DE-1838_1(1) id=11996 00000043.tif |  | DE-1839_1(1) id=12005 00000101.tif |  | DE-1840_1(1) id=12010 00000137.tif |
|  | DE-1841_1(1) id=12015 00000188.tif |  | DE-1842_1(1) id=12020 00000231.tif |  | DE-1843_1(1) id=12026 00000272.tif |
|  | DE-1844_1(1) id=12028 00000279.tif |  | DE-1845_1(1) id=12029 00000280.tif |  | DE-1846_1(1) id=12031 00000299.tif |
|  | DE-1847_1(1) id=12042 00000337.tif |  | DE-1848_1(1) id=12056 00000373.tif |  | DE-1849_1(1) id=12059 00000388.tif |
|  | DE-1850_1(1) id=12062 00000399.tif |  | DE-1851_1(1) id=12064 00000405.tif |  | DE-1852_1(1) id=12068 00000436.tif |
|  | DE-1853_1(1) id=12077 00000493.tif |  | DE-1854_1(1) id=12080 00000511.tif |  | DE-1855_1(1) id=12125 00000710.tif |



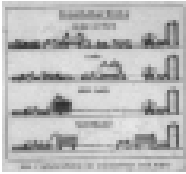







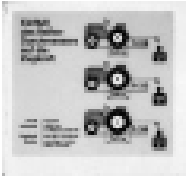













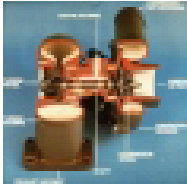

| | | | | | |
|---|--|---|--|---|--|
|  | DE-1856_1(1) id=12146 00000843.tif |  | DE-1857_1(1) id=12148 00000868.tif |  | DE-1858_1(1) id=12155 00000907.tif |
|  | DE-1859_1(1) id=12164 00000967.tif |  | DE-1860_1(1) id=12174 00001027.tif |  | DE-1861_1(1) id=12176 00001039.tif |
|  | DE-1862_1(1) id=12181 00001079.tif |  | DE-1863_1(1) id=12189 00001123.tif |  | DE-1864_1(1) id=12193 00001148.tif |
|  | DE-1865_1(1) id=12204 00001195.tif |  | DE-1866_1(1) id=12211 00001218.tif |  | DE-1867_1(1) id=12212 00001219.tif |
|  | DE-1868_1(1) id=12219 00001262.tif |  | DE-1869_1(1) id=12221 00001268.tif |  | DE-1870_1(1) id=12239 00001571.tif |
|  | DE-1871_1(1) id=12240 00001573.tif |  | DE-1872_1(1) id=12258 00001806.tif |  | DE-1873_1(1) id=12259 00001813.tif |
|  | DE-1874_1(1) id=12272 00001938.tif |  | DE-1875_1(1) id=12274 00001947.tif |  | DE-1876_1(1) id=12283 00002007.tif |
|  | DE-1877_1(1) id=12284 00002015.tif |  | DE-1878_1(1) id=12296 00002094.tif |  | DE-1879_1(1) id=12302 00002128.tif |

| | | | | | |
|---|--|---|--|---|--|
|  | DE-1880_1(1) id=12303 00002140.tif |  | DE-1881_1(1) id=12330 00002459.tif |  | DE-1882_1(1) id=12371 00002909.tif |
|  | DE-1883_1(1) id=12380 00003079.tif |  | DE-1884_1(1) id=12381 00003086.tif |  | DE-1885_1(1) id=12383 00003090.tif |
|  | DE-1886_1(1) id=12397 00003225.tif |  | DE-1887_1(1) id=12398 00003229.tif |  | DE-1888_1(1) id=12400 00003239.tif |
|  | DE-1889_1(1) id=12402 00003245.tif |  | DE-1890_1(1) id=12406 00003256.tif |  | DE-1891_1(1) id=12407 00003258.tif |
|  | DE-1892_1(1) id=12411 00003276.tif |  | DE-1893_1(1) id=12423 00003330.tif |  | DE-1894_1(1) id=12425 00003335.tif |
|  | DE-1895_1(1) id=12427 00003342.tif |  | DE-1896_1(1) id=12431 00003353.tif |  | DE-1897_1(1) id=12440 00003398.tif |
|  | DE-1898_1(1) id=12441 00003401.tif |  | DE-1899_1(1) id=12451 00003467.tif |  | DE-1900_1(1) id=12454 00003475.tif |
|  | DE-1901_1(1) id=12455 00003483.tif |  | DE-1902_1(1) id=12459 00003493.tif |  | DE-1903_1(1) id=12463 00003499.tif |
|  | DE-1904_1(1) id=12467 00003520.tif |  | DE-1905_1(1) id=12471 00003552.tif |  | DE-1906_1(1) id=12477 00003606.tif |





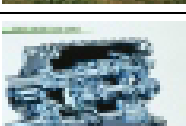
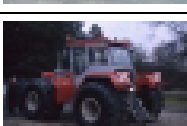







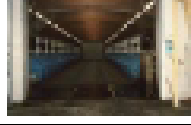

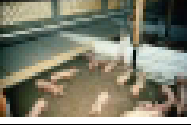







| | | | | | |
|---|--|---|--|---|--|
|  | DE-1907_1(1) id=12478 00003608.tif |  | DE-1908_1(1) id=12479 00003612.tif |  | DE-1909_1(1) id=12489 00003676.tif |
|  | DE-1910_1(1) id=12492 00003690.tif |  | DE-1911_1(1) id=12498 00003722.tif |  | DE-1912_1(1) id=12507 00003772.tif |
|  | DE-1913_1(1) id=12509 00003784.tif |  | DE-1914_1(1) id=12515 00003844.tif |  | DE-1915_1(1) id=12518 00003862.tif |
|  | DE-1916_1(1) id=12524 00003913.tif |  | DE-1917_1(1) id=12526 00003933.tif |  | DE-1918_1(1) id=12529 00003945.tif |
|  | DE-1919_1(1) id=12534 00003966.tif |  | DE-1920_1(1) id=12540 00003993.tif |  | DE-1921_1(1) id=12543 00004017.tif |
|  | DE-1922_1(1) id=12546 00004039.tif |  | DE-1923_1(1) id=12563 00004104.tif |  | DE-1924_1(1) id=12572 00004131.tif |
|  | DE-1925_1(1) id=12576 00004140.tif |  | DE-1926_1(1) id=12586 00004172.tif |  | DE-1927_1(1) id=12588 00004179.tif |
|  | DE-1928_1(1) id=12589 00004180.tif |  | DE-1929_1(1) id=12597 00004201.tif |  | DE-1930_1(1) id=12606 00004253.tif |
|  | DE-1931_1(1) id=12616 00004335.tif |  | DE-1932_1(1) id=12629 00004395.tif |  | DE-1933_1(1) id=12637 00004432.tif |





| | | | | | |
|---|--|---|--|---|--|
|  | DE-1934_1(1) id=12640 00004453.tif |  | DE-1935_1(1) id=12647 00004500.tif |  | DE-1936_1(1) id=12660 00004571.tif |
|  | DE-1937_1(1) id=12675 00004634.tif |  | DE-1938_1(1) id=12681 00004651.tif |  | DE-1939_1(1) id=12700 00004774.tif |
|  | DE-1940_1(1) id=12707 00004797.tif |  | DE-1941_1(1) id=12708 00004798.tif |  | DE-1942_1(1) id=12713 00004838.tif |
|  | DE-1943_1(1) id=12716 00004845.tif |  | DE-1944_1(1) id=12717 00004848.tif |  | DE-1945_1(1) id=12736 00004993.tif |
|  | DE-1946_1(1) id=12739 00005004.tif |  | DE-1947_1(1) id=12750 00005114.tif |  | DE-1948_1(1) id=12755 00005188.tif |
|  | DE-1949_1(1) id=12758 00005217.tif |  | DE-1950_1(1) id=12760 00005222.tif |  | DE-1951_1(1) id=12764 00005250.tif |
|  | DE-1952_1(1) id=12774 00005366.tif |  | DE-1953_1(1) id=12786 00005425.tif |  | DE-1954_1(1) id=12787 00005426.tif |
|  | DE-1955_1(1) id=12788 00005430.tif |  | DE-1956_1(1) id=12796 00005504.tif |  | DE-1957_1(1) id=12815 00005666.tif |
|  | DE-1958_1(1) id=12825 00005736.tif |  | DE-1959_1(1) id=12831 00005751.tif |  | DE-1960_1(1) id=12832 00005756.tif |

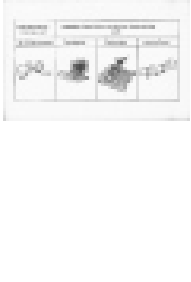





















| | | | | | |
|---|--|---|--|---|--|
|  | DE-1961_1(1) id=12837 00005763.tif |  | DE-1962_1(1) id=12838 00005768.tif |  | DE-1963_1(1) id=12844 00005807.tif |
|  | DE-1964_1(1) id=12846 00005814.tif |  | DE-1965_1(1) id=12853 00005850.tif |  | DE-1966_1(1) id=12856 00005871.tif |
|  | DE-1967_1(1) id=12861 00005926.tif |  | DE-1968_1(1) id=12868 00006020.tif |  | DE-1969_1(1) id=12870 00006023.tif |
|  | DE-1970_1(1) id=12878 00006059.tif |  | DE-1971_1(1) id=12886 00006132.tif |  | DE-1972_1(1) id=12899 00006254.tif |
|  | DE-1973_1(1) id=12902 00006277.tif |  | DE-1974_1(1) id=12905 00006319.tif |  | DE-1975_1(1) id=12915 00006447.tif |
|  | DE-1976_1(1) id=12919 00006507.tif |  | DE-1977_1(1) id=12920 00006508.tif |  | DE-1978_1(1) id=12930 00006661.tif |
|  | DE-1979_1(1) id=12944 00006852.tif |  | DE-1980_1(1) id=12959 00007000.tif |  | DE-1981_1(1) id=12963 00007019.tif |
|  | DE-1982_1(1) id=12976 00007248.tif |  | DE-1983_1(1) id=12987 00007341.tif |  | DE-1984_1(1) id=12989 00007350.tif |
|  | DE-1985_1(1) id=13022 00007772.tif |  | DE-1986_1(1) id=13026 00007821.tif |  | DE-1987_1(1) id=13043 00008123.tif |









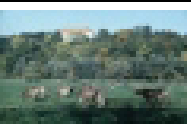



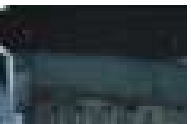





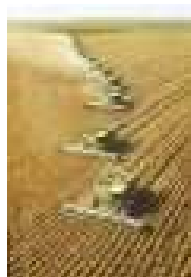



| | | | | | |
|---|--|---|--|---|--|
|  | DE-1988_1(1) id=13064 00008391.tif |  | DE-1989_1(1) id=13070 00008456.tif |  | DE-1990_1(1) id=13075 00008527.tif |
|  | DE-1991_1(1) id=13086 00008619.tif |  | DE-1992_1(1) id=13098 00008713.tif |  | DE-1993_1(1) id=13105 00008749.tif |
|  | DE-1994_1(1) id=13107 00008775.tif |  | DE-1995_1(1) id=13127 00008954.tif |  | DE-1996_1(1) id=13128 00008962.tif |
|  | DE-1997_1(1) id=13132 00009033.tif |  | DE-1998_1(1) id=13139 00009172.tif |  | DE-1999_1(1) id=13140 00009175.tif |
|  | DE-2000_1(1) id=13143 00009184.tif |  | DE-2001_1(1) id=13160 00009369.tif |  | DE-2002_1(1) id=13163 00009391.tif |
|  | DE-2003_1(1) id=13168 00009427.tif |  | DE-2004_1(1) id=13211 00009818.tif |  | DE-2005_1(1) id=13264 00010261.tif |
|  | DE-2006_1(1) id=13265 00010266.tif |  | DE-2007_1(1) id=13270 00010306.tif |  | DE-2008_1(1) id=13281 00010393.tif |
|  | DE-2009_1(1) id=13285 00010406.tif |  | DE-2010_1(1) id=13322 00010528.tif |  | DE-2011_1(1) id=13336 00010594.tif |
|  | DE-2012_1(1) id=13338 00010602.tif |  | DE-2013_1(1) id=13355 00010662.tif |  | DE-2014_1(1) id=13404 00010799.tif |

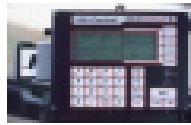



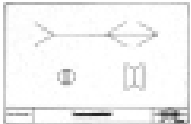







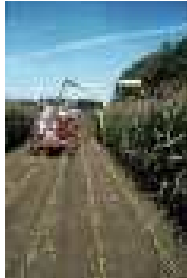









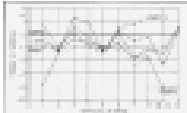



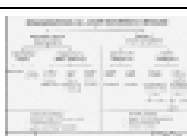
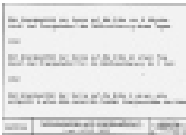
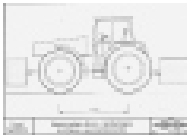

| | | | | | |
|---|--|---|--|---|--|
|  | DE-2015_1(1) id=13442 00010882.tif |  | DE-2016_1(1) id=13445 00010902.tif |  | DE-2017_1(1) id=13465 00010980.tif |
|  | DE-2018_1(1) id=13479 00011024.tif |  | DE-2019_1(1) id=13480 00011028.tif |  | DE-2020_1(1) id=13491 00011057.tif |
|  | DE-2021_1(1) id=13563 00011516.tif |  | DE-2022_1(1) id=13601 00011641.tif |  | DE-2023_1(1) id=13626 00011676.tif |
|  | DE-2024_1(1) id=13641 00011713.tif |  | DE-2025_1(1) id=13642 00011720.tif |  | DE-2026_1(1) id=13646 00011737.tif |
|  | DE-2027_1(1) id=13647 00011741.tif |  | DE-2028_1(1) id=13665 00011906.tif |  | DE-2029_1(1) id=13669 00011911.tif |
|  | DE-2030_1(1) id=13683 00011975.tif |  | DE-2031_1(1) id=13735 00012068.tif |  | DE-2032_1(1) id=13750 00012091.tif |
|  | DE-2033_1(1) id=13789 00012325.tif |  | DE-2034_1(1) id=13792 00012341.tif |  | DE-2035_1(1) id=13825 00012657.tif |
|  | DE-2036_1(1) id=13826 00012665.tif |  | DE-2037_1(1) id=13860 00013146.tif |  | DE-2038_1(1) id=13863 00013165.tif |
|  | DE-2039_1(1) id=13865 00013239.tif |  | DE-2040_1(1) id=13876 00013552.tif |  | DE-2041_1(1) id=13891 00013631.tif |
|  | DE-2042_1(1) id=13899 00013910.tif |  | DE-2043_1(1) id=13901 00013930.tif |  | DE-2044_1(1) id=13902 00013934.tif |
|  | DE-2045_1(1) id=13904 00013944.tif |  | DE-2046_1(1) id=13945 00015195.tif |  | DE-2047_1(1) id=13959 00015419.tif |
|  | DE-2048_1(1) id=13965 00015456.tif |  | DE-2049_1(1) id=13969 00015526.tif |  | DE-2050_1(1) id=13973 00015598.tif |





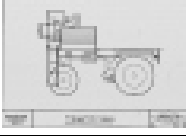
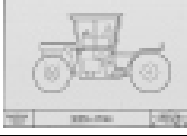





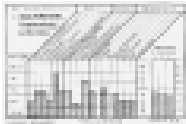
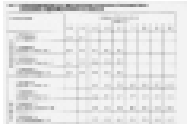















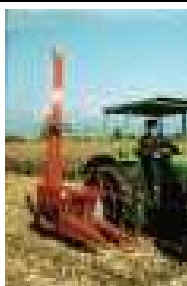

| | | | | | |
|---|--|---|--|---|--|
|  | DE-2051_1(1) id=13978 00015623.tif |  | DE-2052_1(1) id=13979 00015637.tif |  | DE-2053_1(1) id=14069 00015872.tif |
|  | DE-2054_1(1) id=14071 00015890.tif |  | DE-2055_1(1) id=14100 00016119.tif |  | DE-2056_1(1) id=14102 00016124.tif |
|  | DE-2057_1(1) id=14133 00016255.tif |  | DE-2058_1(1) id=14144 00016395.tif |  | DE-2059_1(1) id=14162 00016620.tif |
|  | DE-2060_1(1) id=14174 00016729.tif |  | DE-2061_1(1) id=14175 00016733.tif |  | DE-2062_1(1) id=14178 00016826.tif |
|  | DE-2063_1(1) id=14183 00016875.tif |  | DE-2064_1(1) id=14203 00016981.tif |  | DE-2065_1(1) id=14211 00017013.tif |
|  | DE-2066_1(1) id=14212 00017016.tif |  | DE-2067_1(1) id=14219 00017061.tif |  | DE-2068_1(1) id=14233 00017116.tif |
|  | DE-2069_1(1) id=14235 00017118.tif |  | DE-2070_1(1) id=14237 00017126.tif |  | DE-2071_1(1) id=14259 00017334.tif |
|  | DE-2072_1(1) id=14260 00017338.tif |  | DE-2073_1(1) id=14288 00017690.tif |  | DE-2074_1(1) id=14292 00017709.tif |











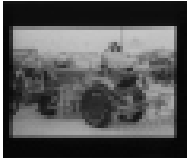
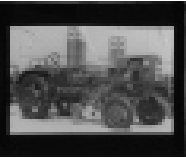
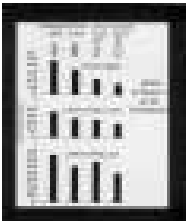



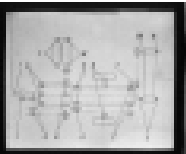



| | | | | | |
|---|--|---|--|---|--|
|  | DE-2075_1(1) id=14300 00017731.tif |  | DE-2076_1(1) id=14363 00018287.tif |  | DE-2077_1(1) id=14364 00018291.tif |
|  | DE-2078_1(1) id=14368 00018378.tif |  | DE-2079_1(1) id=14380 00018529.tif |  | DE-2080_1(1) id=14387 00018575.tif |
|  | DE-2081_1(1) id=14396 00018627.tif |  | DE-2082_1(1) id=14398 00018651.tif |  | DE-2083_1(1) id=14407 00018733.tif |
|  | DE-2084_1(1) id=14417 00018868.tif |  | DE-2085_1(1) id=14424 00018934.tif |  | DE-2086_1(1) id=14430 00019006.tif |
|  | DE-2087_1(1) id=14432 00019033.tif |  | DE-2088_1(1) id=14434 00019042.tif |  | DE-2089_1(1) id=14436 00019056.tif |
|  | DE-2090_1(1) id=14463 00019277.tif |  | DE-2091_1(1) id=14466 00019378.tif |  | DE-2092_1(1) id=14472 00019451.tif |
|  | DE-2093_1(1) id=14478 00019491.tif |  | DE-2094_1(1) id=14568 00020669.tif |  | DE-2095_1(1) id=14575 00020782.tif |
|  | DE-2096_1(1) id=14585 00020935.tif |  | DE-2097_1(1) id=14591 00020988.tif |  | DE-2098_1(1) id=14601 00021081.tif |
|  | DE-2099_1(1) id=14602 00021085.tif |  | DE-2100_1(1) id=14606 00021096.tif |  | DE-2101_1(1) id=14608 00021119.tif |

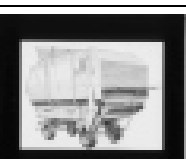



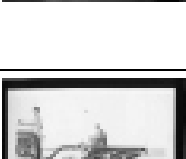
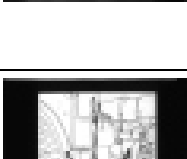

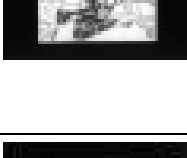



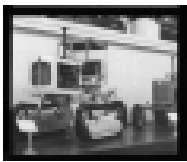





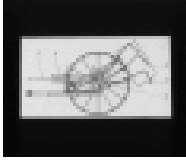
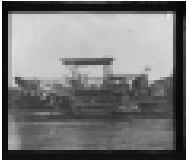

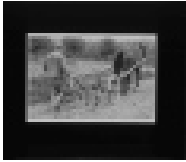
| | | | | | |
|---|--|---|--|---|--|
|  | DE-2102_1(1) id=14624 00021279.tif |  | DE-2103_1(1) id=14629 00021312.tif |  | DE-2104_1(1) id=14635 00021346.tif |
|  | DE-2105_1(1) id=14644 00021413.tif |  | DE-2106_1(1) id=14647 00021500.tif |  | DE-2107_1(1) id=14651 00021515.tif |
|  | DE-2108_1(1) id=14667 00021712.tif |  | DE-2109_1(1) id=14688 00021858.tif |  | DE-2110_1(1) id=14695 00021929.tif |
|  | DE-2111_1(1) id=14711 00022134.tif |  | DE-2112_1(1) id=14716 00022198.tif |  | DE-2113_1(1) id=14721 00022270.tif |
|  | DE-2114_1(1) id=14722 00022296.tif |  | DE-2115_1(1) id=14723 00022305.tif |  | DE-2116_1(1) id=14732 00022546.tif |
|  | DE-2117_1(1) id=14737 00022589.tif |  | DE-2118_1(1) id=14744 00022678.tif |  | DE-2119_1(1) id=14752 00022809.tif |
|  | DE-2120_1(1) id=14762 00022926.tif |  | DE-2121_1(1) id=14765 00023048.tif |  | DE-2122_1(1) id=14766 00023049.tif |
|  | DE-2123_1(1) id=14858 00023362.tif |  | DE-2124_1(1) id=14872 00023406.tif |  | DE-2125_1(1) id=14879 00023429.tif |



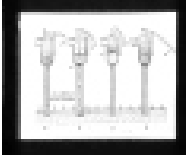

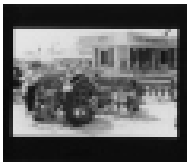
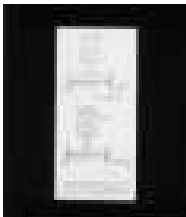



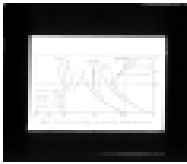

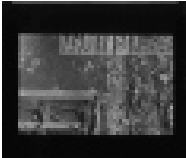

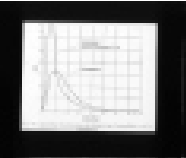



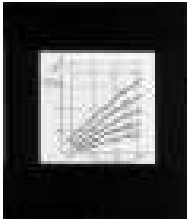





| | | |
|--|--|--|
|  DE-2126_1(1) id=14890 00023465.tif |  DE-2127_1(1) id=14893 00023492.tif |  DE-2128_1(1) id=14894 00023496.tif |
|  DE-2129_1(1) id=14895 00023505.tif |  DE-2130_1(1) id=14896 00023511.tif |  DE-2131_1(1) id=14914 00023570.tif |
|  DE-2132_1(1) id=14939 00023776.tif |  DE-2133_1(1) id=14943 00023795.tif |  DE-2134_1(1) id=14952 00023811.tif |
|  DE-2135_1(1) id=14977 00023888.tif |  DE-2136_1(1) id=14978 00023898.tif |  DE-2137_1(1) id=14993 00024070.tif |
|  DE-2138_1(1) id=15026 00024350.tif |  DE-2139_1(1) id=15034 00024388.tif |  DE-2140_1(1) id=15037 00024425.tif |
|  DE-2141_1(1) id=15055 00024557.tif |  DE-2142_1(1) id=15099 00024614.tif |  DE-2143_1(1) id=15110 00024669.tif |
|  DE-2144_1(1) id=15115 00024719.tif |  DE-2145_1(1) id=15127 00024798.tif |  DE-2146_1(1) id=15165 00025155.tif |
|  DE-2147_1(1) id=15217 00025788.tif |  DE-2148_1(1) id=15231 00026003.tif |  DE-2149_1(1) id=15253 00026221.tif |



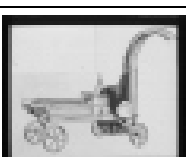

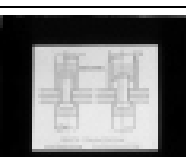





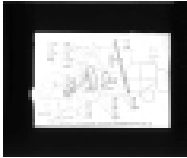
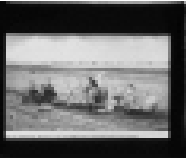





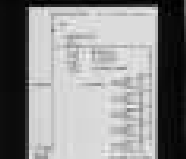
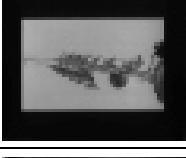

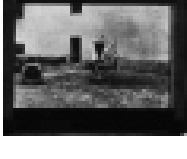

| | | | | | |
|---|--|---|--|---|--|
|  | DE-2150_1(1) id=15254 00026223.tif |  | DE-2151_1(1) id=15259 00026289.tif |  | DE-2152_1(1) id=15262 00026386.tif |
|  | DE-2153_1(1) id=15279 00026523.tif |  | DE-2154_1(1) id=15284 00026560.tif |  | DE-2155_1(1) id=15292 00026637.tif |
|  | DE-2156_1(1) id=15298 00026753.tif |  | DE-2157_1(1) id=15302 00026773.tif |  | DE-2158_1(1) id=15303 00026774.tif |
|  | DE-2159_1(1) id=15305 00026809.tif |  | DE-2160_1(1) id=15306 00026810.tif |  | DE-2161_1(1) id=15324 00026920.tif |
|  | DE-2162_1(1) id=15328 00026948.tif |  | DE-2163_1(1) id=15340 00027132.tif |  | DE-2164_1(1) id=15341 00027134.tif |
|  | DE-2165_1(1) id=15342 00027147.tif |  | DE-2166_1(1) id=15356 00027206.tif |  | DE-2167_1(1) id=15357 00027209.tif |
|  | DE-2168_1(1) id=15388 00027335.tif |  | DE-2169_1(1) id=15402 00027480.tif |  | DE-2170_1(1) id=15403 00027486.tif |
|  | DE-2171_1(1) id=15432 00027619.tif |  | DE-2172_1(1) id=15456 00027663.tif |  | DE-2173_1(1) id=15458 00027668.tif |
|  | DE-2174_1(1) id=15461 00027673.tif |  | DE-2175_1(1) id=15465 00027679.tif |  | DE-2176_1(1) id=15466 00027680.tif |
|  | DE-2177_1(1) id=15467 00027681.tif |  | DE-2178_1(1) id=15468 00027682.tif |  | DE-2179_1(1) id=15469 00027685.tif |
|  | DE-2180_1(1) id=15471 00027688.tif |  | DE-2181_1(1) id=15473 00027700.tif |  | DE-2182_1(1) id=15484 00027778.tif |



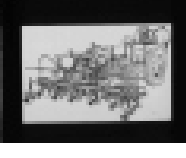



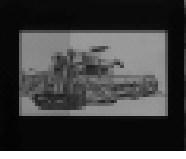

| | | | | | |
|---|--|---|--|---|--|
|  | DE-2183_1(1) id=15485 00027842.tif |  | DE-2184_1(1) id=15487 00027854.tif |  | DE-2185_1(1) id=15522 00028059.tif |
|  | DE-2186_1(1) id=15530 00028185.tif |  | DE-2187_1(1) id=15537 00028222.tif |  | DE-2188_1(1) id=15599 00028411.tif |
|  | DE-2189_1(1) id=15607 00028495.tif |  | DE-2190_1(1) id=15611 00028550.tif |  | DE-2191_1(1) id=15612 00028554.tif |
|  | DE-2192_1(1) id=15626 00028623.tif |  | DE-2193_1(1) id=15633 00028668.tif |  | DE-2194_1(1) id=15710 00028895.tif |
|  | DE-2195_1(1) id=15745 00029147.tif |  | DE-2196_1(1) id=15757 00029271.tif |  | DE-2197_1(1) id=15766 00029294.tif |
|  | DE-2198_1(1) id=15840 00029890.tif |  | DE-2199_1(1) id=15841 00029892.tif |  | DE-2200_1(1) id=15844 00029914.tif |
|  | DE-2201_1(1) id=15848 00029955.tif |  | DE-2202_1(1) id=15850 00029963.tif |  | DE-2203_1(1) id=15852 00029967.tif |
|  | DE-2204_1(1) id=15854 00029986.tif |  | DE-2205_1(1) id=15885 00037116.tif |  | DE-2206_1(1) id=15905 00040938.tif |
|  | DE-2207_1(1) id=637750 hub-00716.tif |  | DE-2208_1(1) id=637843 hub-04063.tif |  | DE-2209_1(1) id=637864 hub-01724.tif |
|  | DE-2210_1(1) id=637881 hub-02030.tif |  | DE-2211_1(1) id=637891 hub-12783.tif |  | DE-2212_1(1) id=637892 hub-12782.tif |











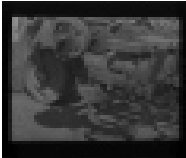
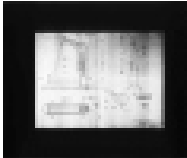
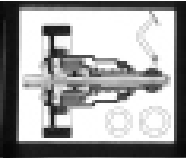

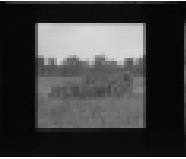
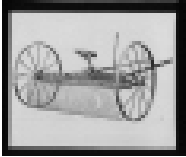
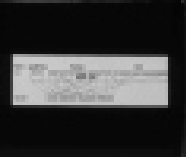

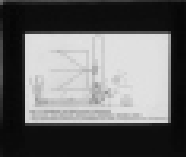
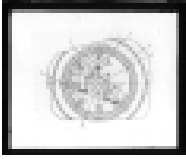

| | | | | | |
|---|--|---|--|---|--|
|  | DE-2213_1(1) id=637894 hub-12786.tif |  | DE-2214_1(1) id=637895 hub-12785.tif |  | DE-2215_1(1) id=637898 hub-12788.tif |
|  | DE-2216_1(1) id=637899 hub-00890.tif |  | DE-2217_1(1) id=637907 hub-00898.tif |  | DE-2218_1(1) id=637918 hub-03817.tif |
|  | DE-2219_1(1) id=637919 hub-03816.tif |  | DE-2220_1(1) id=637922 hub-12819.tif |  | DE-2221_1(1) id=637932 hub-03973.tif |
|  | DE-2222_1(1) id=637935 hub-03976.tif |  | DE-2223_1(1) id=637970 hub-05461.tif |  | DE-2224_1(1) id=637972 hub-02556.tif |
|  | DE-2225_1(1) id=637975 hub-02553.tif |  | DE-2226_1(1) id=637984 hub-02733.tif |  | DE-2227_1(1) id=637996 hub-04899.tif |
|  | DE-2228_1(1) id=638000 hub-04897.tif |  | DE-2229_1(1) id=638023 hub-01149.tif |  | DE-2230_1(1) id=638048 hub-00542.tif |
|  | DE-2231_1(1) id=638084 hub-01707.tif |  | DE-2232_1(1) id=638085 hub-12012.tif |  | DE-2233_1(1) id=638123 hub-00267.tif |
|  | DE-2234_1(1) id=638132 hub-03837.tif |  | DE-2235_1(1) id=638164 hub-04673.tif |  | DE-2236_1(1) id=638190 hub-05509.tif |

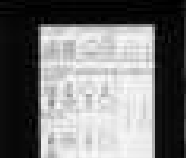



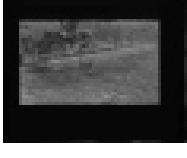





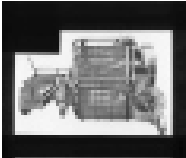
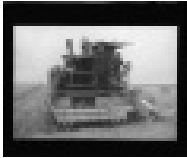
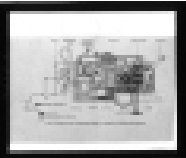

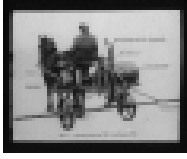

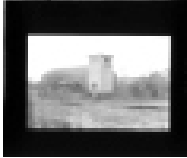
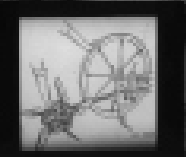
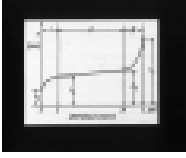
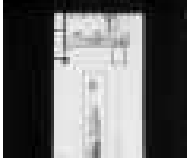
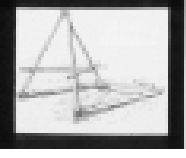



| | | | | | |
|---|--|---|--|---|--|
|  | DE-2237_1(1) id=638222 hub-03612.tif |  | DE-2238_1(1) id=638297 hub-13408.tif |  | DE-2239_1(1) id=638318 hub-03617.tif |
|  | DE-2240_1(1) id=638324 hub-03614.tif |  | DE-2241_1(1) id=638335 hub-04818.tif |  | DE-2242_1(1) id=638338 hub-03939.tif |
|  | DE-2243_1(1) id=638345 hub-03930.tif |  | DE-2244_1(1) id=638358 hub-05529.tif |  | DE-2245_1(1) id=638363 hub-05524.tif |
|  | DE-2246_1(1) id=638375 hub-03208.tif |  | DE-2247_1(1) id=638376 hub-03209.tif |  | DE-2248_1(1) id=638381 hub-11491.tif |
|  | DE-2249_1(1) id=638398 hub-12605.tif |  | DE-2250_1(1) id=638421 hub-10477.tif |  | DE-2251_1(1) id=638463 hub-00830.tif |
|  | DE-2252_1(1) id=638509 hub-00136.tif |  | DE-2253_1(1) id=638520 hub-00249.tif |  | DE-2254_1(1) id=638526 hub-00797.tif |
|  | DE-2255_1(1) id=638537 hub-00798.tif |  | DE-2256_1(1) id=638542 hub-02799.tif |  | DE-2257_1(1) id=638571 hub-04834.tif |
|  | DE-2258_1(1) id=638594 hub-05305.tif |  | DE-2259_1(1) id=638631 hub-03073.tif |  | DE-2260_1(1) id=638668 hub-03113.tif |
|  | DE-2261_1(1) id=638683 hub-12890.tif |  | DE-2262_1(1) id=638690 hub-03796.tif |  | DE-2263_1(1) id=638692 hub-03794.tif |





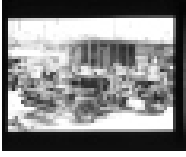



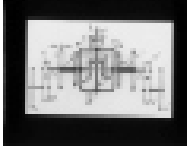
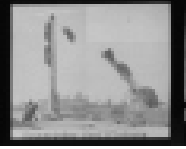

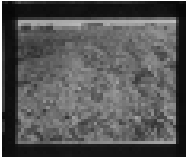
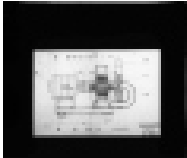







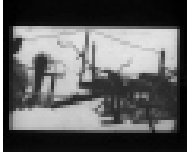

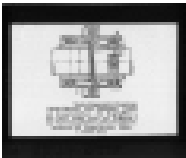
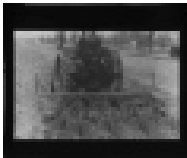

| | | | | | |
|---|--|---|--|---|--|
|  | DE-2264_1(1) id=638712 hub-12275.tif |  | DE-2265_1(1) id=638723 hub-04217.tif |  | DE-2266_1(1) id=638732 hub-04813.tif |
|  | DE-2267_1(1) id=638755 hub-05369.tif |  | DE-2268_1(1) id=638807 hub-00878.tif |  | DE-2269_1(1) id=638814 hub-00873.tif |
|  | DE-2270_1(1) id=638835 hub-04227.tif |  | DE-2271_1(1) id=638840 hub-03977.tif |  | DE-2272_1(1) id=638851 hub-01009.tif |
|  | DE-2273_1(1) id=638880 hub-01910.tif |  | DE-2274_1(1) id=638889 hub-05584.tif |  | DE-2275_1(1) id=638933 hub-02175.tif |
|  | DE-2276_1(1) id=638938 hub-02170.tif |  | DE-2277_1(1) id=638944 hub-12660.tif |  | DE-2278_1(1) id=639015 hub-02579.tif |
|  | DE-2279_1(1) id=639073 hub-05442.tif |  | DE-2280_1(1) id=639081 hub-00229.tif |  | DE-2281_1(1) id=639088 hub-01936.tif |
|  | DE-2282_1(1) id=639113 hub-12946.tif |  | DE-2283_1(1) id=639116 hub-03750.tif |  | DE-2284_1(1) id=639120 hub-03754.tif |
|  | DE-2285_1(1) id=639144 hub-03282.tif |  | DE-2286_1(1) id=639145 hub-03283.tif |  | DE-2287_1(1) id=639151 hub-03577.tif |



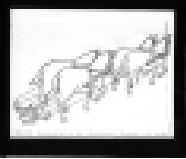

| | | | | | |
|---|--|---|--|---|--|
|  | DE-2288_1(1) id=639166 hub-01590.tif |  | DE-2289_1(1) id=639175 hub-02622.tif |  | DE-2290_1(1) id=639182 hub-13158.tif |
|  | DE-2291_1(1) id=639196 hub-11781.tif |  | DE-2292_1(1) id=639217 hub-00415.tif |  | DE-2293_1(1) id=639237 hub-02811.tif |
|  | DE-2294_1(1) id=639240 hub-02814.tif |  | DE-2295_1(1) id=639246 hub-12141.tif |  | DE-2296_1(1) id=639274 hub-05634.tif |
|  | DE-2297_1(1) id=639275 hub-05633.tif |  | DE-2298_1(1) id=639281 hub-01957.tif |  | DE-2299_1(1) id=639288 hub-01958.tif |
|  | DE-2300_1(1) id=639290 hub-11045.tif |  | DE-2301_1(1) id=639291 hub-11046.tif |  | DE-2302_1(1) id=639307 hub-00600.tif |
|  | DE-2303_1(1) id=639325 hub-03552.tif |  | DE-2304_1(1) id=639351 hub-05385.tif |  | DE-2305_1(1) id=639354 hub-05382.tif |
|  | DE-2306_1(1) id=639405 hub-00382.tif |  | DE-2307_1(1) id=639423 hub-03129.tif |  | DE-2308_1(1) id=639426 hub-02830.tif |
|  | DE-2309_1(1) id=639438 hub-01418.tif |  | DE-2310_1(1) id=639463 hub-01358.tif |  | DE-2311_1(1) id=639489 hub-05653.tif |

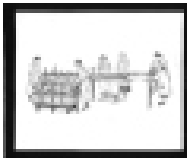
| | | | | | |
|---|--|---|--|---|--|
|  | DE-2312_1(1) id=639505 hub-03710.tif |  | DE-2313_1(1) id=639546 hub-13503.tif |  | DE-2314_1(1) id=639561 hub-02991.tif |
|  | DE-2315_1(1) id=639593 hub-12757.tif |  | DE-2316_1(1) id=639604 hub-04452.tif |  | DE-2317_1(1) id=639618 hub-00369.tif |
|  | DE-2318_1(1) id=639635 hub-02856.tif |  | DE-2319_1(1) id=639642 hub-02851.tif |  | DE-2320_1(1) id=639665 hub-02271.tif |
|  | DE-2321_1(1) id=639669 hub-02275.tif |  | DE-2322_1(1) id=639695 hub-04107.tif |  | DE-2323_1(1) id=639703 hub-01993.tif |
|  | DE-2324_1(1) id=639750 hub-00913.tif |  | DE-2325_1(1) id=639762 hub-01202.tif |  | DE-2326_1(1) id=639766 hub-01206.tif |
|  | DE-2327_1(1) id=639772 hub-12731.tif |  | DE-2328_1(1) id=639775 hub-11279.tif |  | DE-2329_1(1) id=639780 hub-04921.tif |
|  | DE-2330_1(1) id=639794 hub-01348.tif |  | DE-2331_1(1) id=639799 hub-00348.tif |  | DE-2332_1(1) id=639819 hub-05449.tif |
|  | DE-2333_1(1) id=639840 hub-03693.tif |  | DE-2334_1(1) id=639846 hub-03695.tif |  | DE-2335_1(1) id=639855 hub-04312.tif |



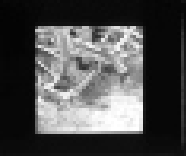

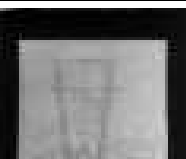







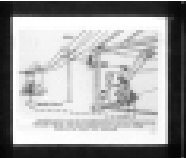
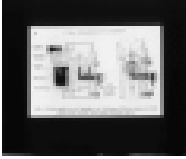
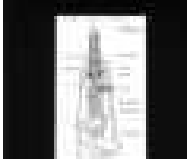
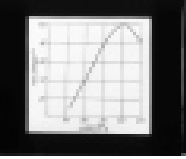
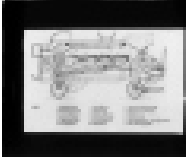
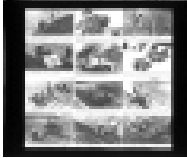





| | | | | | |
|---|--|---|--|---|--|
|  | DE-2336_1(1) id=639889 hub-04553.tif |  | DE-2337_1(1) id=639917 hub-00669.tif |  | DE-2338_1(1) id=639923 hub-00662.tif |
|  | DE-2339_1(1) id=639929 hub-00664.tif |  | DE-2340_1(1) id=639954 hub-01229.tif |  | DE-2341_1(1) id=639955 hub-12717.tif |
|  | DE-2342_1(1) id=639983 hub-10254.tif |  | DE-2343_1(1) id=640007 hub-01811.tif |  | DE-2344_1(1) id=640010 hub-10664.tif |
|  | DE-2345_1(1) id=640012 hub-00495.tif |  | DE-2346_1(1) id=640017 hub-00492.tif |  | DE-2347_1(1) id=640022 hub-05541.tif |
|  | DE-2348_1(1) id=640033 hub-03958.tif |  | DE-2349_1(1) id=640122 hub-02934.tif |  | DE-2350_1(1) id=640145 hub-03336.tif |
|  | DE-2351_1(1) id=640177 hub-01248.tif |  | DE-2352_1(1) id=640181 hub-04969.tif |  | DE-2353_1(1) id=640186 hub-04960.tif |
|  | DE-2354_1(1) id=640203 hub-13022.tif |  | DE-2355_1(1) id=640231 hub-00020.tif |  | DE-2356_1(1) id=640244 hub-00027.tif |
|  | DE-2357_1(1) id=640283 hub-01498.tif |  | DE-2358_1(1) id=640320 hub-04161.tif |  | DE-2359_1(1) id=640344 hub-02911.tif |
|  | DE-2360_1(1) id=640351 hub-03353.tif |  | DE-2361_1(1) id=640367 hub-02003.tif |  | DE-2362_1(1) id=640373 hub-01268.tif |



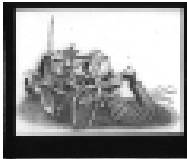

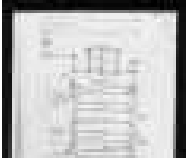







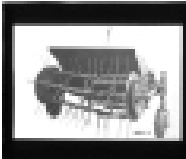
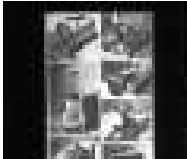





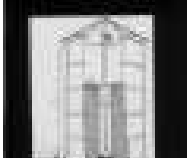





| | | | | | |
|---|--|---|--|---|--|
|  | DE-2363_1(1) id=640374 hub-01269.tif |  | DE-2364_1(1) id=640384 hub-03410.tif |  | DE-2365_1(1) id=640414 hub-04375.tif |
|  | DE-2366_1(1) id=640423 hub-03980.tif |  | DE-2367_1(1) id=640438 hub-00728.tif |  | DE-2368_1(1) id=640439 hub-00729.tif |
|  | DE-2369_1(1) id=640441 hub-00722.tif |  | DE-2370_1(1) id=640444 hub-04372.tif |  | DE-2371_1(1) id=640445 hub-00726.tif |
|  | DE-2372_1(1) id=640452 hub-03187.tif |  | DE-2373_1(1) id=640461 hub-00923.tif |  | DE-2374_1(1) id=640521 hub-00534.tif |
|  | DE-2375_1(1) id=640605 hub-02485.tif |  | DE-2376_1(1) id=640612 hub-12820.tif |  | DE-2377_1(1) id=640619 hub-03615.tif |
|  | DE-2378_1(1) id=640625 hub-00700.tif |  | DE-2379_1(1) id=640626 hub-02373.tif |  | DE-2380_1(1) id=640630 hub-00705.tif |
|  | DE-2381_1(1) id=640745 hub-10895.tif |  | DE-2382_1(1) id=640782 hub-02040.tif |  | DE-2383_1(1) id=640787 hub-12794.tif |
|  | DE-2384_1(1) id=640788 hub-12795.tif |  | DE-2385_1(1) id=640795 hub-02624.tif |  | DE-2386_1(1) id=640803 hub-03033.tif |
|  | DE-2387_1(1) id=640807 hub-05512.tif |  | DE-2388_1(1) id=640858 hub-00766.tif |  | DE-2389_1(1) id=640946 hub-10525.tif |

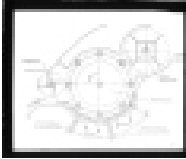



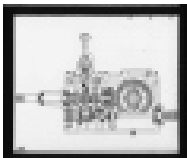





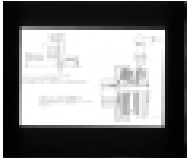



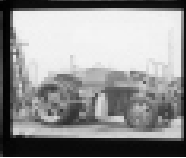







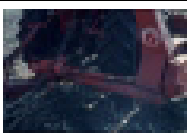

| | | | | | |
|---|--|---|--|---|--|
|  | DE-2390_1(1) id=640947 hub-10527.tif |  | DE-2391_1(1) id=640969 hub-04056.tif |  | DE-2392_1(1) id=640985 hub-12004.tif |
|  | DE-2393_1(1) id=640988 hub-12000.tif |  | DE-2394_1(1) id=641063 hub-05519.tif |  | DE-2395_1(1) id=641091 hub-02292.tif |
|  | DE-2396_1(1) id=641107 hub-01507.tif |  | DE-2397_1(1) id=641131 hub-01173.tif |  | DE-2398_1(1) id=641135 hub-10195.tif |
|  | DE-2399_1(1) id=641166 hub-04039.tif |  | DE-2400_1(1) id=641208 hub-02084.tif |  | DE-2401_1(1) id=641219 hub-05426.tif |
|  | DE-2402_1(1) id=641223 hub-01619.tif |  | DE-2403_1(1) id=641226 hub-01613.tif |  | DE-2404_1(1) id=641227 hub-02499.tif |
|  | DE-2405_1(1) id=641230 hub-04622.tif |  | DE-2406_1(1) id=641239 hub-02364.tif |  | DE-2407_1(1) id=641302 hub-01526.tif |
|  | DE-2408_1(1) id=641305 hub-03454.tif |  | DE-2409_1(1) id=641309 hub-05333.tif |  | DE-2410_1(1) id=641325 hub-00465.tif |
|  | DE-2411_1(1) id=641348 hub-01755.tif |  | DE-2412_1(1) id=641367 hub-10920.tif |  | DE-2413_1(1) id=641373 hub-00802.tif |
|  | DE-2414_1(1) id=641387 hub-00008.tif |  | DE-2415_1(1) id=641409 hub-00256.tif |  | DE-2416_1(1) id=641414 hub-00259.tif |























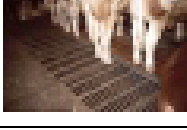

| | | | | | |
|---|--|---|--|---|--|
|  | DE-2417_1(1) id=641432 hub-00782.tif |  | DE-2418_1(1) id=641445 hub-00071.tif |  | DE-2419_1(1) id=641446 hub-00078.tif |
|  | DE-2420_1(1) id=641457 hub-02780.tif |  | DE-2421_1(1) id=641482 hub-02125.tif |  | DE-2422_1(1) id=641483 hub-12655.tif |
|  | DE-2423_1(1) id=641504 hub-00741.tif |  | DE-2424_1(1) id=641507 hub-04789.tif |  | DE-2425_1(1) id=641536 hub-02337.tif |
|  | DE-2426_1(1) id=641542 hub-02331.tif |  | DE-2427_1(1) id=641560 hub-01511.tif |  | DE-2428_1(1) id=641573 hub-01012.tif |
|  | DE-2429_1(1) id=641587 hub-00270.tif |  | DE-2430_1(1) id=641610 hub-10733.tif |  | DE-2431_1(1) id=641653 hub-04222.tif |
|  | DE-2432_1(1) id=641667 hub-03815.tif |  | DE-2433_1(1) id=641670 hub-04645.tif |  | DE-2434_1(1) id=641684 hub-04423.tif |
|  | DE-2435_1(1) id=641685 hub-04422.tif |  | DE-2436_1(1) id=641700 hub-00424.tif |  | DE-2437_1(1) id=641721 hub-02359.tif |
|  | DE-2438_1(1) id=641722 hub-02358.tif |  | DE-2439_1(1) id=641748 hub-05414.tif |  | DE-2440_1(1) id=641774 hub-01079.tif |

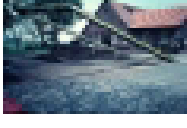

| | | | | | |
|---|--|---|--|---|--|
|  | DE-2441_1(1) id=641783 hub-01072.tif |  | DE-2442_1(1) id=641814 hub-01921.tif |  | DE-2443_1(1) id=641834 hub-12202.tif |
|  | DE-2444_1(1) id=641839 hub-03743.tif |  | DE-2445_1(1) id=641846 hub-01677.tif |  | DE-2446_1(1) id=641847 hub-01676.tif |
|  | DE-2447_1(1) id=641850 hub-01673.tif |  | DE-2448_1(1) id=641866 hub-03569.tif |  | DE-2449_1(1) id=641868 hub-03299.tif |
|  | DE-2450_1(1) id=641877 hub-02161.tif |  | DE-2451_1(1) id=641881 hub-01586.tif |  | DE-2452_1(1) id=641883 hub-01583.tif |
|  | DE-2453_1(1) id=641896 hub-00989.tif |  | DE-2454_1(1) id=641925 hub-00409.tif |  | DE-2455_1(1) id=642002 hub-00238.tif |
|  | DE-2456_1(1) id=642027 hub-03767.tif |  | DE-2457_1(1) id=642036 hub-02496.tif |  | DE-2458_1(1) id=642081 hub-20009.tif |
|  | DE-2459_1(1) id=642090 hub-04465.tif |  | DE-2460_1(1) id=642099 hub-04468.tif |  | DE-2461_1(1) id=642106 hub-04097.tif |
|  | DE-2462_1(1) id=642154 hub-02828.tif |  | DE-2463_1(1) id=642190 hub-11055.tif |  | DE-2464_1(1) id=642225 hub-00611.tif |

















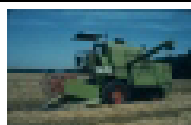

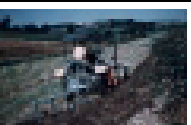

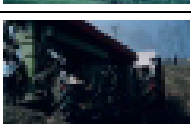

| | | | | | |
|---|--|---|--|---|--|
|  | DE-2465_1(1) id=642226 hub-00616.tif |  | DE-2466_1(1) id=642235 hub-04280.tif |  | DE-2467_1(1) id=642262 hub-00949.tif |
|  | DE-2468_1(1) id=642313 hub-04703.tif |  | DE-2469_1(1) id=642314 hub-04708.tif |  | DE-2470_1(1) id=642318 hub-00373.tif |
|  | DE-2471_1(1) id=642319 hub-00372.tif |  | DE-2472_1(1) id=642356 hub-02842.tif |  | DE-2473_1(1) id=642373 hub-00166.tif |
|  | DE-2474_1(1) id=642416 hub-04630.tif |  | DE-2475_1(1) id=642433 hub-01186.tif |  | DE-2476_1(1) id=642445 hub-03722.tif |
|  | DE-2477_1(1) id=642450 hub-03725.tif |  | DE-2478_1(1) id=642452 hub-04119.tif |  | DE-2479_1(1) id=642454 hub-03729.tif |
|  | DE-2480_1(1) id=642459 hub-01982.tif |  | DE-2481_1(1) id=642487 hub-03588.tif |  | DE-2482_1(1) id=642514 hub-02181.tif |
|  | DE-2483_1(1) id=642523 hub-02672.tif |  | DE-2484_1(1) id=642562 hub-00356.tif |  | DE-2485_1(1) id=642620 hub-12112.tif |
|  | DE-2486_1(1) id=642625 hub-04010.tif |  | DE-2487_1(1) id=642646 hub-12284.tif |  | DE-2488_1(1) id=642671 hub-02473.tif |
|  | DE-2489_1(1) id=642683 hub-03303.tif |  | DE-2490_1(1) id=642687 hub-00900.tif |  | DE-2491_1(1) id=642703 hub-01236.tif |

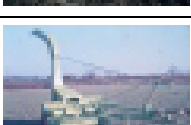



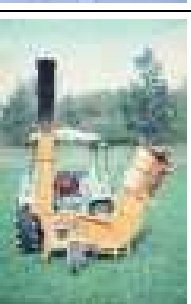















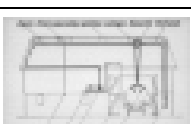
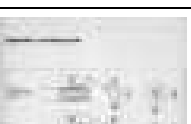





| | | | | | |
|---|--|---|--|---|--|
|  | DE-2492_1(1) id=642708 hub-01231.tif |  | DE-2493_1(1) id=642776 hub-04446.tif |  | DE-2494_1(1) id=642788 hub-00509.tif |
|  | DE-2495_1(1) id=642799 hub-11817.tif |  | DE-2496_1(1) id=642800 hub-11814.tif |  | DE-2497_1(1) id=642827 hub-10077.tif |
|  | DE-2498_1(1) id=642828 hub-10075.tif |  | DE-2499_1(1) id=642837 hub-10383.tif |  | DE-2500_1(1) id=642839 hub-04542.tif |
|  | DE-2501_1(1) id=642840 hub-04543.tif |  | DE-2502_1(1) id=642856 hub-04155.tif |  | DE-2503_1(1) id=642883 hub-00674.tif |
|  | DE-2504_1(1) id=642897 hub-03329.tif |  | DE-2505_1(1) id=642902 hub-03324.tif |  | DE-2506_1(1) id=642916 hub-01780.tif |
|  | DE-2507_1(1) id=642924 hub-01252.tif |  | DE-2508_1(1) id=642931 hub-04973.tif |  | DE-2509_1(1) id=642935 hub-04976.tif |
|  | DE-2510_1(1) id=642951 hub-14004.tif |  | DE-2511_1(1) id=643002 hub-04364.tif |  | DE-2512_1(1) id=643019 hub-02758.tif |
|  | DE-2513_1(1) id=643039 hub-04568.tif |  | DE-2514_1(1) id=643062 hub-02928.tif |  | DE-2515_1(1) id=643114 hub-02997.tif |
|  | DE-2516_1(1) id=643118 hub-01311.tif |  | DE-2517_1(1) id=643121 hub-01319.tif |  | DE-2518_1(1) id=643123 hub-10228.tif |

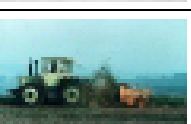
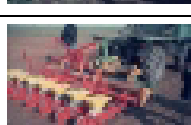
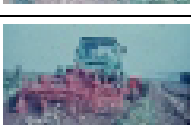
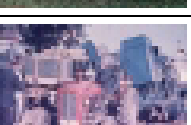

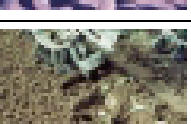



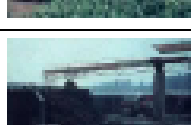

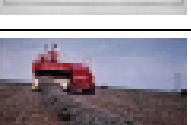





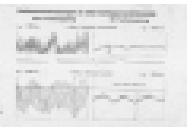









| | | | | | |
|---|--|---|--|---|--|
|  | DE-2519_1(1) id=643137 hub-01869.tif |  | DE-2520_1(1) id=643187 hub-02197.tif |  | DE-2521_1(1) id=643199 hub-02666.tif |
|  | DE-2522_1(1) id=643206 hub-01480.tif |  | DE-2523_1(1) id=643221 hub-02595.tif |  | DE-2524_1(1) id=643228 hub-02778.tif |
|  | DE-2525_1(1) id=643239 hub-12688.tif |  | DE-2526_1(1) id=643261 hub-01107.tif |  | DE-2527_1(1) id=643271 hub-10597.tif |
|  | DE-2528_1(1) id=643292 hub-02905.tif |  | DE-2529_1(1) id=643321 hub-02017.tif |  | DE-2530_1(1) id=643355 hub-03622.tif |
|  | DE-2531_1(1) id=643356 hub-03623.tif |  | DE-2532_1(1) id=643370 hub-03628.tif |  | DE-2533_1(1) id=643381 hub-01849.tif |
|  | DE-2534_1(1) id=689649 00000008.tif |  | DE-2535_1(1) id=689650 00000009.tif |  | DE-2536_1(1) id=689652 00000011.tif |
|  | DE-2537_1(1) id=689654 00000013.tif |  | DE-2538_1(1) id=689662 00000025.tif |  | DE-2539_1(1) id=689664 00000029.tif |
|  | DE-2540_1(1) id=689667 00000032.tif |  | DE-2541_1(1) id=689681 00000050.tif |  | DE-2542_1(1) id=689686 00000055.tif |
|  | DE-2543_1(1) id=689691 00000061.tif |  | DE-2544_1(1) id=689702 00000075.tif |  | DE-2545_1(1) id=689704 00000079.tif |









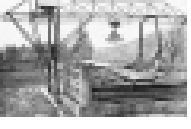

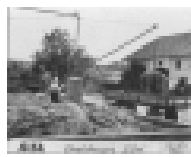











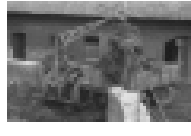

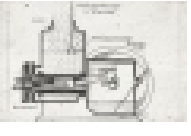

| | | | | | |
|---|---|---|---|---|---|
|  | DE-2546_1(1) id=689717 00000095.tif |  | DE-2547_1(1) id=689726 00000106.tif |  | DE-2548_1(1) id=689727 00000107.tif |
|  | DE-2549_1(1) id=689733 00000114.tif |  | DE-2550_1(1) id=689741 00000124.tif |  | DE-2551_1(1) id=689742 00000125.tif |
|  | DE-2552_1(1) id=689746 00000131.tif |  | DE-2553_1(1) id=689747 00000132.tif |  | DE-2554_1(1) id=689808 00000210.tif |
|  | DE-2555_1(1) id=689901 00000332.tif |  | DE-2556_1(1) id=689934 00000386.tif |  | DE-2557_1(1) id=689963 00000423.tif |
|  | DE-2558_1(1) id=689980 00000445.tif |  | DE-2559_1(1) id=689989 00000456.tif |  | DE-2560_1(1) id=689992 00000459.tif |
|  | DE-2561_1(1) id=690002 00000475.tif |  | DE-2562_1(1) id=690008 00000482.tif |  | DE-2563_1(1) id=690023 00000501.tif |
|  | DE-2564_1(1) id=690025 00000504.tif |  | DE-2565_1(1) id=690041 00000522.tif |  | DE-2566_1(1) id=690044 00000528.tif |
|  | DE-2567_1(1) id=690051 00000536.tif |  | DE-2568_1(1) id=690097 00000597.tif |  | DE-2569_1(1) id=690108 00000615.tif |
|  | DE-2570_1(1) id=690141 00000656.tif |  | DE-2571_1(1) id=690182 00000724.tif |  | DE-2572_1(1) id=690227 00000777.tif |
|  | DE-2573_1(1) id=690285 00000846.tif |  | DE-2574_1(1) id=690305 00000869.tif |  | DE-2575_1(1) id=690325 00000891.tif |







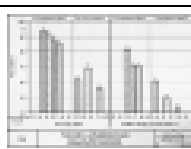

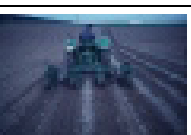





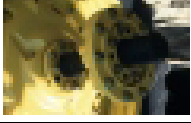

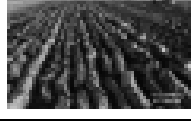







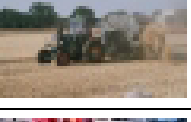

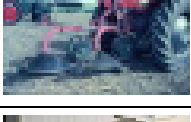





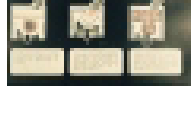

| | | | | | |
|---|---|---|---|---|---|
|  | DE-2576_1(1) id=690335 00000903.tif |  | DE-2577_1(1) id=690337 00000908.tif |  | DE-2578_1(1) id=690338 00000909.tif |
|  | DE-2579_1(1) id=690346 00000919.tif |  | DE-2580_1(1) id=690355 00000929.tif |  | DE-2581_1(1) id=690395 00000975.tif |
|  | DE-2582_1(1) id=690397 00000977.tif |  | DE-2583_1(1) id=690406 00000987.tif |  | DE-2584_1(1) id=690429 00001017.tif |
|  | DE-2585_1(1) id=690436 00001024.tif |  | DE-2586_1(1) id=690438 00001029.tif |  | DE-2587_1(1) id=690456 00001050.tif |
|  | DE-2588_1(1) id=690465 00001061.tif |  | DE-2589_1(1) id=690492 00001090.tif |  | DE-2590_1(1) id=690500 00001099.tif |
|  | DE-2591_1(1) id=690501 00001100.tif |  | DE-2592_1(1) id=690503 00001103.tif |  | DE-2593_1(1) id=690551 00001165.tif |
|  | DE-2594_1(1) id=690563 00001182.tif |  | DE-2595_1(1) id=690564 00001183.tif |  | DE-2596_1(1) id=690610 00001248.tif |
|  | DE-2597_1(1) id=691114 00002008.tif |  | DE-2598_1(1) id=691129 00002028.tif |  | DE-2599_1(1) id=691392 00002403.tif |
|  | DE-2600_1(1) id=691424 00002440.tif |  | DE-2601_1(1) id=691913 00003142.tif |  | DE-2602_1(1) id=691967 00003215.tif |



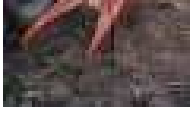
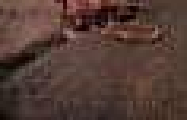









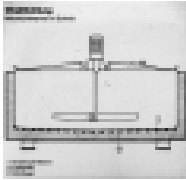









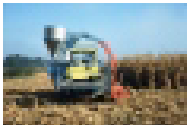

| | | | | | |
|---|---|---|---|---|---|
|  | DE-2603_1(1) id=692002 00003264.tif |  | DE-2604_1(1) id=692056 00003333.tif |  | DE-2605_1(1) id=692065 00003350.tif |
|  | DE-2606_1(1) id=692098 00003394.tif |  | DE-2607_1(1) id=692155 00003466.tif |  | DE-2608_1(1) id=692322 00003663.tif |
|  | DE-2609_1(1) id=692924 00004589.tif |  | DE-2610_1(1) id=693358 00005147.tif |  | DE-2611_1(1) id=694638 00006255.tif |
|  | DE-2612_1(1) id=694641 00006258.tif |  | DE-2613_1(1) id=694649 00006266.tif |  | DE-2614_1(1) id=694671 00006291.tif |
|  | DE-2615_1(1) id=694673 00006293.tif |  | DE-2616_1(1) id=694676 00006296.tif |  | DE-2617_1(1) id=694684 00006303.tif |
|  | DE-2618_1(1) id=694701 00006323.tif |  | DE-2619_1(1) id=694780 00006425.tif |  | DE-2620_1(1) id=694781 00006426.tif |
|  | DE-2621_1(1) id=694784 00006430.tif |  | DE-2622_1(1) id=694786 00006432.tif |  | DE-2623_1(1) id=694795 00006442.tif |
|  | DE-2624_1(1) id=694796 00006443.tif |  | DE-2625_1(1) id=694804 00006452.tif |  | DE-2626_1(1) id=694805 00006453.tif |

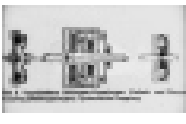

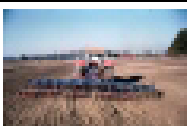

| | | | | | |
|---|---|---|---|---|---|
|  | DE-2627_1(1) id=694806 00006455.tif |  | DE-2628_1(1) id=694815 00006464.tif |  | DE-2629_1(1) id=694831 00006478.tif |
|  | DE-2630_1(1) id=694852 00006511.tif |  | DE-2631_1(1) id=694867 00006525.tif |  | DE-2632_1(1) id=694870 00006528.tif |
|  | DE-2633_1(1) id=694871 00006529.tif |  | DE-2634_1(1) id=694872 00006530.tif |  | DE-2635_1(1) id=694885 00006540.tif |
|  | DE-2636_1(1) id=694892 00006547.tif |  | DE-2637_1(1) id=694937 00006601.tif |  | DE-2638_1(1) id=694945 00006610.tif |
|  | DE-2639_1(1) id=694955 00006623.tif |  | DE-2640_1(1) id=695082 00006780.tif |  | DE-2641_1(1) id=695105 00006806.tif |
|  | DE-2642_1(1) id=695109 00006811.tif |  | DE-2643_1(1) id=695111 00006813.tif |  | DE-2644_1(1) id=695116 00006821.tif |
|  | DE-2645_1(1) id=695144 00006858.tif |  | DE-2646_1(1) id=695160 00006878.tif |  | DE-2647_1(1) id=695214 00006930.tif |
|  | DE-2648_1(1) id=695243 00006959.tif |  | DE-2649_1(1) id=695282 00007006.tif |  | DE-2650_1(1) id=695294 00007021.tif |
|  | DE-2651_1(1) id=695304 00007036.tif |  | DE-2652_1(1) id=695337 00007089.tif |  | DE-2653_1(1) id=695364 00007117.tif |
|  | DE-2654_1(1) id=695367 00007120.tif |  | DE-2655_1(1) id=695382 00007141.tif |  | DE-2656_1(1) id=695405 00007169.tif |
|  | DE-2657_1(1) id=695414 00007187.tif |  | DE-2658_1(1) id=695430 00007206.tif |  | DE-2659_1(1) id=695444 00007223.tif |





















| | | | | | |
|---|---|---|---|---|---|
|  | DE-2660_1(1) id=695452 00007231.tif |  | DE-2661_1(1) id=695453 00007232.tif |  | DE-2662_1(1) id=695454 00007233.tif |
|  | DE-2663_1(1) id=695460 00007239.tif |  | DE-2664_1(1) id=695467 00007246.tif |  | DE-2665_1(1) id=695504 00007301.tif |
|  | DE-2666_1(1) id=695507 00007305.tif |  | DE-2667_1(1) id=695529 00007344.tif |  | DE-2668_1(1) id=695536 00007354.tif |
|  | DE-2669_1(1) id=695539 00007358.tif |  | DE-2670_1(1) id=695548 00007369.tif |  | DE-2671_1(1) id=695550 00007373.tif |
|  | DE-2672_1(1) id=695563 00007402.tif |  | DE-2673_1(1) id=695575 00007415.tif |  | DE-2674_1(1) id=695577 00007418.tif |
|  | DE-2675_1(1) id=695582 00007423.tif |  | DE-2676_1(1) id=695594 00007436.tif |  | DE-2677_1(1) id=695601 00007444.tif |
|  | DE-2678_1(1) id=695615 00007459.tif |  | DE-2679_1(1) id=695621 00007468.tif |  | DE-2680_1(1) id=695640 00007492.tif |
|  | DE-2681_1(1) id=695646 00007498.tif |  | DE-2682_1(1) id=695660 00007523.tif |  | DE-2683_1(1) id=695671 00007536.tif |
|  | DE-2684_1(1) id=695673 00007538.tif |  | DE-2685_1(1) id=695674 00007540.tif |  | DE-2686_1(1) id=695683 00007551.tif |











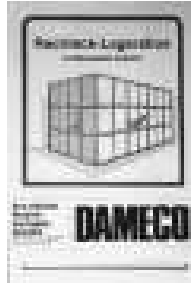

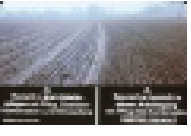













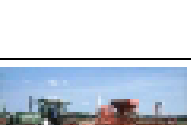



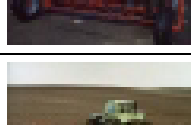

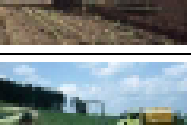

| | | | | | |
|---|---|---|---|---|---|
|  | DE-2687_1(1) id=695686 00007554.tif |  | DE-2688_1(1) id=695693 00007561.tif |  | DE-2689_1(1) id=695702 00007571.tif |
|  | DE-2690_1(1) id=695711 00007580.tif |  | DE-2691_1(1) id=695713 00007582.tif |  | DE-2692_1(1) id=695721 00007592.tif |
|  | DE-2693_1(1) id=695722 00007594.tif |  | DE-2694_1(1) id=695756 00007642.tif |  | DE-2695_1(1) id=695766 00007654.tif |
|  | DE-2696_1(1) id=695772 00007661.tif |  | DE-2697_1(1) id=695776 00007665.tif |  | DE-2698_1(1) id=695780 00007669.tif |
|  | DE-2699_1(1) id=695789 00007680.tif |  | DE-2700_1(1) id=695806 00007701.tif |  | DE-2701_1(1) id=695815 00007713.tif |
|  | DE-2702_1(1) id=695818 00007717.tif |  | DE-2703_1(1) id=695840 00007743.tif |  | DE-2704_1(1) id=695841 00007744.tif |
|  | DE-2705_1(1) id=695854 00007760.tif |  | DE-2706_1(1) id=695855 00007761.tif |  | DE-2707_1(1) id=695884 00007797.tif |
|  | DE-2708_1(1) id=695895 00007808.tif |  | DE-2709_1(1) id=695903 00007819.tif |  | DE-2710_1(1) id=696015 00007953.tif |
|  | DE-2711_1(1) id=696020 00007958.tif |  | DE-2712_1(1) id=696046 00007986.tif |  | DE-2713_1(1) id=696059 00008001.tif |

| | | | | | |
|---|---|---|---|---|---|
|  | DE-2714_1(1) id=696088 00008032.tif |  | DE-2715_1(1) id=696113 00008066.tif |  | DE-2716_1(1) id=696133 00008098.tif |
|  | DE-2717_1(1) id=696451 00008130.tif |  | DE-2718_1(1) id=696453 00008132.tif |  | DE-2719_1(1) id=696468 00008149.tif |
|  | DE-2720_1(1) id=696499 00008184.tif |  | DE-2721_1(1) id=696506 00008191.tif |  | DE-2722_1(1) id=696513 00008200.tif |
|  | DE-2723_1(1) id=696578 00008267.tif |  | DE-2724_1(1) id=696622 00008314.tif |  | DE-2725_1(1) id=696629 00008322.tif |
|  | DE-2726_1(1) id=696630 00008323.tif |  | DE-2727_1(1) id=696637 00008330.tif |  | DE-2728_1(1) id=696644 00008337.tif |
|  | DE-2729_1(1) id=696648 00008341.tif |  | DE-2730_1(1) id=696730 00008471.tif |  | DE-2731_1(1) id=696731 00008472.tif |
|  | DE-2732_1(1) id=696732 00008474.tif |  | DE-2733_1(1) id=696780 00008551.tif |  | DE-2734_1(1) id=696818 00008604.tif |
|  | DE-2735_1(1) id=696821 00008607.tif |  | DE-2736_1(1) id=696836 00008626.tif |  | DE-2737_1(1) id=696854 00008644.tif |
|  | DE-2738_1(1) id=696906 00008709.tif |  | DE-2739_1(1) id=696914 00008721.tif |  | DE-2740_1(1) id=696919 00008725.tif |
|  | DE-2741_1(1) id=696925 00008733.tif |  | DE-2742_1(1) id=696945 00008757.tif |  | DE-2743_1(1) id=696978 00008795.tif |
|  | DE-2744_1(1) id=696982 00008800.tif |  | DE-2745_1(1) id=696983 00008801.tif |  | DE-2746_1(1) id=696984 00008802.tif |
|  | DE-2747_1(1) id=696988 00008808.tif |  | DE-2748_1(1) id=697010 00008841.tif |  | DE-2749_1(1) id=697026 00008858.tif |

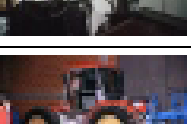
| | | | | | |
|---|---|---|---|---|---|
|  | DE-2750_1(1) id=697059 00008900.tif |  | DE-2751_1(1) id=697060 00008901.tif |  | DE-2752_1(1) id=697065 00008909.tif |
|  | DE-2753_1(1) id=697105 00008953.tif |  | DE-2754_1(1) id=697114 00008967.tif |  | DE-2755_1(1) id=697126 00008982.tif |
|  | DE-2756_1(1) id=697128 00008985.tif |  | DE-2757_1(1) id=697131 00008988.tif |  | DE-2758_1(1) id=697172 00009032.tif |
|  | DE-2759_1(1) id=697176 00009037.tif |  | DE-2760_1(1) id=697184 00009048.tif |  | DE-2761_1(1) id=697189 00009053.tif |
|  | DE-2762_1(1) id=697190 00009054.tif |  | DE-2763_1(1) id=697191 00009055.tif |  | DE-2764_1(1) id=697192 00009056.tif |
|  | DE-2765_1(1) id=697194 00009058.tif |  | DE-2766_1(1) id=697261 00009147.tif |  | DE-2767_1(1) id=697320 00009233.tif |
|  | DE-2768_1(1) id=697321 00009234.tif |  | DE-2769_1(1) id=697337 00009257.tif |  | DE-2770_1(1) id=697342 00009262.tif |
|  | DE-2771_1(1) id=697343 00009264.tif |  | DE-2772_1(1) id=697359 00009282.tif |  | DE-2773_1(1) id=697363 00009287.tif |
|  | DE-2774_1(1) id=697367 00009291.tif |  | DE-2775_1(1) id=697369 00009293.tif |  | DE-2776_1(1) id=697384 00009309.tif |

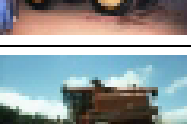





















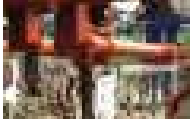







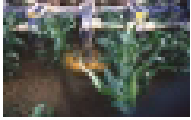

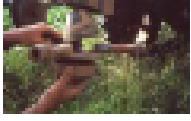
| | | | | | |
|---|---|---|---|---|---|
|  | DE-2777_1(1) id=697420 00009353.tif |  | DE-2778_1(1) id=697421 00009354.tif |  | DE-2779_1(1) id=697425 00009358.tif |
|  | DE-2780_1(1) id=697431 00009366.tif |  | DE-2781_1(1) id=697432 00009367.tif |  | DE-2782_1(1) id=697443 00009380.tif |
|  | DE-2783_1(1) id=697464 00009409.tif |  | DE-2784_1(1) id=697497 00009461.tif |  | DE-2785_1(1) id=697519 00009498.tif |
|  | DE-2786_1(1) id=697530 00009516.tif |  | DE-2787_1(1) id=697544 00009535.tif |  | DE-2788_1(1) id=697545 00009536.tif |
|  | DE-2789_1(1) id=697547 00009538.tif |  | DE-2790_1(1) id=697549 00009540.tif |  | DE-2791_1(1) id=697553 00009546.tif |
|  | DE-2792_1(1) id=697601 00009611.tif |  | DE-2793_1(1) id=697604 00009616.tif |  | DE-2794_1(1) id=697606 00009618.tif |
|  | DE-2795_1(1) id=697631 00009643.tif |  | DE-2796_1(1) id=697634 00009647.tif |  | DE-2797_1(1) id=697650 00009670.tif |
|  | DE-2798_1(1) id=697706 00009743.tif |  | DE-2799_1(1) id=697747 00009808.tif |  | DE-2800_1(1) id=697748 00009809.tif |
|  | DE-2801_1(1) id=697755 00009816.tif |  | DE-2802_1(1) id=697756 00009817.tif |  | DE-2803_1(1) id=697761 00009825.tif |

| | | | | | |
|---|---|---|---|---|---|
|  | DE-2804_1(1) id=697763 00009826.tif |  | DE-2805_1(1) id=697783 00009841.tif |  | DE-2806_1(1) id=697792 00009851.tif |
|  | DE-2807_1(1) id=697794 00009855.tif |  | DE-2808_1(1) id=697819 00009886.tif |  | DE-2809_1(1) id=697827 00009896.tif |
|  | DE-2810_1(1) id=697833 00009902.tif |  | DE-2811_1(1) id=697834 00009903.tif |  | DE-2812_1(1) id=697838 00009907.tif |
|  | DE-2813_1(1) id=697845 00009924.tif |  | DE-2814_1(1) id=697968 00010077.tif |  | DE-2815_1(1) id=697971 00010081.tif |
|  | DE-2816_1(1) id=697976 00010086.tif |  | DE-2817_1(1) id=697985 00010095.tif |  | DE-2818_1(1) id=698008 00010122.tif |
|  | DE-2819_1(1) id=698014 00010129.tif |  | DE-2820_1(1) id=698045 00010166.tif |  | DE-2821_1(1) id=698046 00010167.tif |
|  | DE-2822_1(1) id=698049 00010170.tif |  | DE-2823_1(1) id=698050 00010171.tif |  | DE-2824_1(1) id=698051 00010172.tif |
|  | DE-2825_1(1) id=698060 00010182.tif |  | DE-2826_1(1) id=698065 00010187.tif |  | DE-2827_1(1) id=698067 00010189.tif |
|  | DE-2828_1(1) id=698109 00010258.tif |  | DE-2829_1(1) id=698123 00010289.tif |  | DE-2830_1(1) id=698127 00010293.tif |
|  | DE-2831_1(1) id=698140 00010314.tif |  | DE-2832_1(1) id=698142 00010318.tif |  | DE-2833_1(1) id=698145 00010322.tif |
|  | DE-2834_1(1) id=698150 00010329.tif |  | DE-2835_1(1) id=698152 00010332.tif |  | DE-2836_1(1) id=698153 00010335.tif |

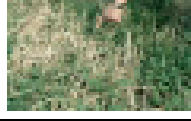





| | | | | | |
|---|---|---|---|---|---|
|  | DE-2837_1(1) id=698172 00010364.tif |  | DE-2838_1(1) id=698173 00010366.tif |  | DE-2839_1(1) id=698182 00010388.tif |
|  | DE-2840_1(1) id=698183 00010389.tif |  | DE-2841_1(1) id=698185 00010392.tif |  | DE-2842_1(1) id=698186 00010394.tif |
|  | DE-2843_1(1) id=698202 00010419.tif |  | DE-2844_1(1) id=698220 00010454.tif |  | DE-2845_1(1) id=698255 00010518.tif |
|  | DE-2846_1(1) id=698290 00010582.tif |  | DE-2847_1(1) id=698295 00010595.tif |  | DE-2848_1(1) id=698318 00010658.tif |
|  | DE-2849_1(1) id=698323 00010670.tif |  | DE-2850_1(1) id=698326 00010675.tif |  | DE-2851_1(1) id=698333 00010688.tif |
|  | DE-2852_1(1) id=698339 00010696.tif |  | DE-2853_1(1) id=698349 00010790.tif |  | DE-2854_1(1) id=698351 00010795.tif |
|  | DE-2855_1(1) id=698359 00010819.tif |  | DE-2856_1(1) id=698384 00010883.tif |  | DE-2857_1(1) id=698387 00010887.tif |
|  | DE-2858_1(1) id=698394 00010896.tif |  | DE-2859_1(1) id=698397 00010899.tif |  | DE-2860_1(1) id=698469 00011051.tif |
|  | DE-2861_1(1) id=698471 00011056.tif |  | DE-2862_1(1) id=698532 00011139.tif |  | DE-2863_1(1) id=698535 00011143.tif |
|  | DE-2864_1(1) id=698550 00011164.tif |  | DE-2865_1(1) id=698599 00011252.tif |  | DE-2866_1(1) id=698600 00011253.tif |
|  | DE-2867_1(1) id=698610 00011265.tif |  | DE-2868_1(1) id=698617 00011272.tif |  | DE-2869_1(1) id=698631 00011290.tif |
|  | DE-2870_1(1) id=698645 00011308.tif |  | DE-2871_1(1) id=698677 00011354.tif |  | DE-2872_1(1) id=698756 00011527.tif |







| | | | | | |
|---|---|---|---|---|---|
|  | DE-2873_1(1) id=698768 00011553.tif |  | DE-2874_1(1) id=698774 00011568.tif |  | DE-2875_1(1) id=698796 00011595.tif |
|  | DE-2876_1(1) id=698858 00011787.tif |  | DE-2877_1(1) id=698874 00011818.tif |  | DE-2878_1(1) id=698877 00011821.tif |
|  | DE-2879_1(1) id=698878 00011822.tif |  | DE-2880_1(1) id=698891 00011841.tif |  | DE-2881_1(1) id=698952 00011926.tif |
|  | DE-2882_1(1) id=698960 00011936.tif |  | DE-2883_1(1) id=698966 00011943.tif |  | DE-2884_1(1) id=698967 00011944.tif |
|  | DE-2885_1(1) id=698969 00011949.tif |  | DE-2886_1(1) id=698982 00011966.tif |  | DE-2887_1(1) id=698986 00011970.tif |
|  | DE-2888_1(1) id=699003 00011993.tif |  | DE-2889_1(1) id=699029 00012114.tif |  | DE-2890_1(1) id=699037 00012124.tif |
|  | DE-2891_1(1) id=699058 00012153.tif |  | DE-2892_1(1) id=699062 00012158.tif |  | DE-2893_1(1) id=699095 00012210.tif |
|  | DE-2894_1(1) id=699103 00012218.tif |  | DE-2895_1(1) id=699131 00012256.tif |  | DE-2896_1(1) id=699146 00012273.tif |
|  | DE-2897_1(1) id=699193 00012345.tif |  | DE-2898_1(1) id=699233 00012412.tif |  | DE-2899_1(1) id=699257 00012449.tif |
|  | DE-2900_1(1) id=699275 00012474.tif |  | DE-2901_1(1) id=699349 00012567.tif |  | DE-2902_1(1) id=699352 00012570.tif |
|  | DE-2903_1(1) id=699367 00012587.tif |  | DE-2904_1(1) id=699377 00012597.tif |  | DE-2905_1(1) id=699385 00012606.tif |
|  | DE-2906_1(1) id=699388 00012609.tif |  | DE-2907_1(1) id=699396 00012617.tif |  | DE-2908_1(1) id=699505 00012794.tif |





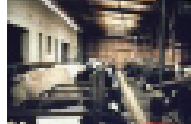

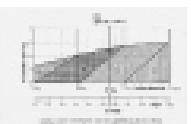









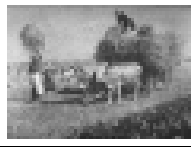
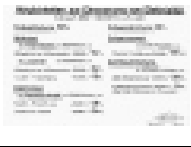
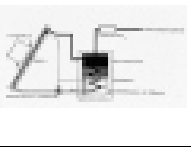

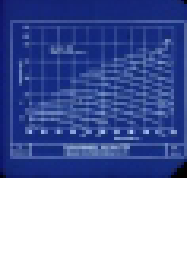
| | | | | | |
|---|---|---|---|---|---|
|  | DE-2909_1(1) id=699510 00012799.tif |  | DE-2910_1(1) id=699543 00012835.tif |  | DE-2911_1(1) id=699561 00012864.tif |
|  | DE-2912_1(1) id=699568 00012967.tif |  | DE-2913_1(1) id=699573 00012972.tif |  | DE-2914_1(1) id=699578 00012977.tif |
|  | DE-2915_1(1) id=699581 00012980.tif |  | DE-2916_1(1) id=699585 00012984.tif |  | DE-2917_1(1) id=699704 00013117.tif |
|  | DE-2918_1(1) id=699705 00013118.tif |  | DE-2919_1(1) id=699706 00013119.tif |  | DE-2920_1(1) id=699727 00013147.tif |
|  | DE-2921_1(1) id=699730 00013150.tif |  | DE-2922_1(1) id=699731 00013151.tif |  | DE-2923_1(1) id=699759 00013185.tif |
|  | DE-2924_1(1) id=699831 00013262.tif |  | DE-2925_1(1) id=699947 00013480.tif |  | DE-2926_1(1) id=699954 00013489.tif |
|  | DE-2927_1(1) id=699956 00013492.tif |  | DE-2928_1(1) id=699968 00013506.tif |  | DE-2929_1(1) id=699970 00013508.tif |
|  | DE-2930_1(1) id=700008 00013550.tif |  | DE-2931_1(1) id=700031 00013586.tif |  | DE-2932_1(1) id=700036 00013599.tif |
|  | DE-2933_1(1) id=700078 00013656.tif |  | DE-2934_1(1) id=700092 00013754.tif |  | DE-2935_1(1) id=700116 00013889.tif |
|  | DE-2936_1(1) id=700131 00013905.tif |  | DE-2937_1(1) id=700132 00013906.tif |  | DE-2938_1(1) id=700133 00013907.tif |
|  | DE-2939_1(1) id=700147 00013926.tif |  | DE-2940_1(1) id=700148 00013927.tif |  | DE-2941_1(1) id=700159 00013941.tif |

| | | |
|---|---|---|
|  DE-2942_1(1) id=700172 00013955.tif |  DE-2943_1(1) id=700210 00013998.tif |  DE-2944_1(1) id=700230 00014018.tif |
|  DE-2945_1(1) id=700232 00014020.tif |  DE-2946_1(1) id=700240 00014028.tif |  DE-2947_1(1) id=700243 00014031.tif |
|  DE-2948_1(1) id=700244 00014032.tif |  DE-2949_1(1) id=700246 00014034.tif |  DE-2950_1(1) id=700307 00014106.tif |
|  DE-2951_1(1) id=700308 00014107.tif |  DE-2952_1(1) id=700328 00014130.tif |  DE-2953_1(1) id=700352 00014255.tif |
|  DE-2954_1(1) id=700353 00014256.tif |  DE-2955_1(1) id=700356 00014259.tif |  DE-2956_1(1) id=700358 00014261.tif |
|  DE-2957_1(1) id=700365 00014268.tif |  DE-2958_1(1) id=700366 00014269.tif |  DE-2959_1(1) id=700368 00014271.tif |
|  DE-2960_1(1) id=700373 00014276.tif |  DE-2961_1(1) id=700378 00014282.tif |  DE-2962_1(1) id=700404 00014310.tif |
|  DE-2963_1(1) id=700405 00014311.tif |  DE-2964_1(1) id=700408 00014314.tif |  DE-2965_1(1) id=700409 00014315.tif |
|  DE-2966_1(1) id=700415 00014321.tif |  DE-2967_1(1) id=700422 00014328.tif |  DE-2968_1(1) id=700424 00014330.tif |
|  DE-2969_1(1) id=700425 00014331.tif |  DE-2970_1(1) id=700438 00014347.tif |  DE-2971_1(1) id=700453 00014452.tif |
|  DE-2972_1(1) id=700469 00014476.tif |  DE-2973_1(1) id=700475 00014482.tif |  DE-2974_1(1) id=700485 00014494.tif |
|  DE-2975_1(1) id=700497 00014507.tif |  DE-2976_1(1) id=700525 00014542.tif |  DE-2977_1(1) id=700538 00014557.tif |

| | | | | | |
|---|---|---|---|---|---|
|  | DE-2978_1(1) id=700549 00014568.tif |  | DE-2979_1(1) id=700554 00014573.tif |  | DE-2980_1(1) id=700555 00014574.tif |
|  | DE-2981_1(1) id=700560 00014579.tif |  | DE-2982_1(1) id=700587 00014611.tif |  | DE-2983_1(1) id=700612 00014639.tif |
|  | DE-2984_1(1) id=700672 932005.png |  | DE-2985_1(1) id=700674 00014712.tif |  | DE-2986_1(1) id=700704 00014747.tif |
|  | DE-2987_1(1) id=700774 00014819.tif |  | DE-2988_1(1) id=700807 00014853.tif |  | DE-2989_1(1) id=700808 00014854.tif |
|  | DE-2990_1(1) id=700818 00014864.tif |  | DE-2991_1(1) id=700849 00014895.tif |  | DE-2992_1(1) id=700911 00014970.tif |
|  | DE-2993_1(1) id=700913 00014972.tif |  | DE-2994_1(1) id=700956 00015023.tif |  | DE-2995_1(1) id=700982 00015036.tif |
|  | DE-2996_1(1) id=700990 00015045.tif |  | DE-2997_1(1) id=700996 00015051.tif |  | DE-2998_1(1) id=700998 00015053.tif |
|  | DE-2999_1(1) id=701008 00015063.tif |  | DE-3000_1(1) id=701044 00015099.tif |  | DE-3001_1(1) id=701061 00015108.tif |
|  | DE-3002_1(1) id=701091 00015119.tif |  | DE-3003_1(1) id=701112 00015144.tif |  | DE-3004_1(1) id=701124 00015157.tif |
|  | DE-3005_1(1) id=701144 00015183.tif |  | DE-3006_1(1) id=701160 00015203.tif |  | DE-3007_1(1) id=701171 00015214.tif |

| | | | | | |
|---|---|---|---|---|---|
|  | DE-3008_1(1) id=701173 00015216.tif |  | DE-3009_1(1) id=701177 00015220.tif |  | DE-3010_1(1) id=701185 00015231.tif |
|  | DE-3011_1(1) id=701187 00015233.tif |  | DE-3012_1(1) id=701193 00015241.tif |  | DE-3013_1(1) id=701218 00015269.tif |
|  | DE-3014_1(1) id=701237 00015287.tif |  | DE-3015_1(1) id=701238 00015289.tif |  | DE-3016_1(1) id=701240 00015292.tif |
|  | DE-3017_1(1) id=701263 00015316.tif |  | DE-3018_1(1) id=701270 00015323.tif |  | DE-3019_1(1) id=701271 00015324.tif |
|  | DE-3020_1(1) id=701277 00015332.tif |  | DE-3021_1(1) id=701331 00015415.tif |  | DE-3022_1(1) id=701372 962094.png |
|  | DE-3023_1(1) id=701384 00015490.tif |  | DE-3024_1(1) id=701398 00015505.tif |  | DE-3025_1(1) id=701411 00015519.tif |
|  | DE-3026_1(1) id=701420 00015529.tif |  | DE-3027_1(1) id=701430 00015540.tif |  | DE-3028_1(1) id=701454 00015575.tif |
|  | DE-3029_1(1) id=701459 00015580.tif |  | DE-3030_1(1) id=701461 00015583.tif |  | DE-3031_1(1) id=701482 00015608.tif |
|  | DE-3032_1(1) id=701489 00015618.tif |  | DE-3033_1(1) id=701491 00015620.tif |  | DE-3034_1(1) id=701502 00015632.tif |

| | | | | | |
|---|---|---|---|---|---|
|  | DE-3035_1(1) id=701510 00015641.tif |  | DE-3036_1(1) id=701514 00015645.tif |  | DE-3037_1(1) id=701555 00015691.tif |
|  | DE-3038_1(1) id=701564 00015703.tif |  | DE-3039_1(1) id=701566 00015707.tif |  | DE-3040_1(1) id=701582 00015729.tif |
|  | DE-3041_1(1) id=701599 00015787.tif |  | DE-3042_1(1) id=701601 00015789.tif |  | DE-3043_1(1) id=701628 00015849.tif |
|  | DE-3044_1(1) id=701656 00015889.tif |  | DE-3045_1(1) id=701668 00015904.tif |  | DE-3046_1(1) id=701681 00015920.tif |
|  | DE-3047_1(1) id=701766 00016019.tif |  | DE-3048_1(1) id=701771 00016025.tif |  | DE-3049_1(1) id=701823 00016088.tif |
|  | DE-3050_1(1) id=701888 00016168.tif |  | DE-3051_1(1) id=701889 00016169.tif |  | DE-3052_1(1) id=701902 00016188.tif |
|  | DE-3053_1(1) id=701942 00016225.tif |  | DE-3054_1(1) id=702039 00016347.tif |  | DE-3055_1(1) id=702063 00016374.tif |
|  | DE-3056_1(1) id=702077 00016391.tif |  | DE-3057_1(1) id=702102 00016423.tif |  | DE-3058_1(1) id=702119 00016443.tif |

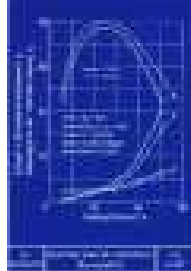
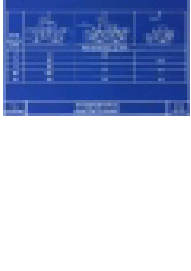
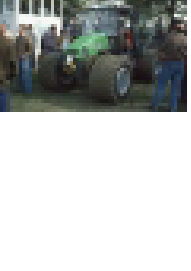















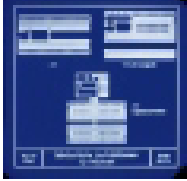





| | | | | | |
|---|---|---|---|---|---|
|  | DE-3059_1(1) id=702122 00016444.tif |  | DE-3060_1(1) id=702134 00016458.tif |  | DE-3061_1(1) id=702189 00016509.tif |
|  | DE-3062_1(1) id=702215 00016520.tif |  | DE-3063_1(1) id=702237 00016545.tif |  | DE-3064_1(1) id=702337 942005.png |
|  | DE-3065_1(1) id=702361 00016692.tif |  | DE-3066_1(1) id=702394 00016728.tif |  | DE-3067_1(1) id=702419 00016749.tif |
|  | DE-3068_1(1) id=702453 00016792.tif |  | DE-3069_1(1) id=702541 00016907.tif |  | DE-3070_1(1) id=702544 00016910.tif |
|  | DE-3071_1(1) id=702548 00016914.tif |  | DE-3072_1(1) id=702570 00016941.tif |  | DE-3073_1(1) id=702574 00016946.tif |
|  | DE-3074_1(1) id=702598 00016988.tif |  | DE-3075_1(1) id=702599 00016989.tif |  | DE-3076_1(1) id=702606 00016996.tif |
|  | DE-3077_1(1) id=702607 00016997.tif |  | DE-3078_1(1) id=702610 00017005.tif |  | DE-3079_1(1) id=702614 00017010.tif |
|  | DE-3080_1(1) id=702619 00017019.tif |  | DE-3081_1(1) id=702627 00017027.tif |  | DE-3082_1(1) id=702644 00017048.tif |



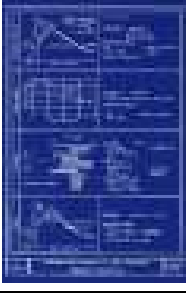













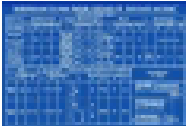



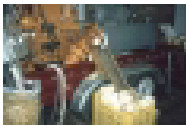

| | | | | | |
|---|---|---|---|---|---|
|  | DE-3083_1(1) id=702649 00017053.tif |  | DE-3084_1(1) id=702656 00017063.tif |  | DE-3085_1(1) id=702666 00017077.tif |
|  | DE-3086_1(1) id=702680 00017097.tif |  | DE-3087_1(1) id=702684 00017101.tif |  | DE-3088_1(1) id=702727 962376.png |
|  | DE-3089_1(1) id=702768 00017228.tif |  | DE-3090_1(1) id=702770 00017232.tif |  | DE-3091_1(1) id=702776 952275.png |
|  | DE-3092_1(1) id=702783 00017253.tif |  | DE-3093_1(1) id=702814 00017303.tif |  | DE-3094_1(1) id=702838 00017331.tif |
|  | DE-3095_1(1) id=702878 00017586.tif |  | DE-3096_1(1) id=702880 00017588.tif |  | DE-3097_1(1) id=702896 00017613.tif |
|  | DE-3098_1(1) id=702897 00017614.tif |  | DE-3099_1(1) id=702905 00017624.tif |  | DE-3100_1(1) id=702922 00017649.tif |
|  | DE-3101_1(1) id=702955 942215.png |  | DE-3102_1(1) id=702961 00017727.tif |  | DE-3103_1(1) id=702970 00017744.tif |
|  | DE-3104_1(1) id=702982 00017768.tif |  | DE-3105_1(1) id=702988 00017777.tif |  | DE-3106_1(1) id=702990 00017779.tif |

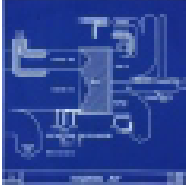
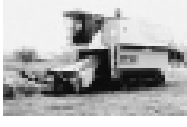











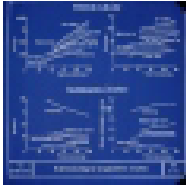

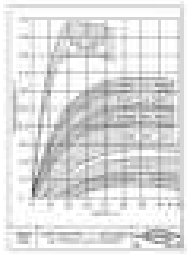

















| | | | | | |
|---|---|---|---|---|---|
|  | DE-3107_1(1) id=702991 00017782.tif |  | DE-3108_1(1) id=702997 00017799.tif |  | DE-3109_1(1) id=703004 00017807.tif |
|  | DE-3110_1(1) id=703069 00017910.tif |  | DE-3111_1(1) id=703253 00018111.tif |  | DE-3112_1(1) id=703290 00018148.tif |
|  | DE-3113_1(1) id=703295 00018153.tif |  | DE-3114_1(1) id=703324 00018182.tif |  | DE-3115_1(1) id=703400 00018269.tif |
|  | DE-3116_1(1) id=703446 00018328.tif |  | DE-3117_1(1) id=703448 00018330.tif |  | DE-3118_1(1) id=703464 00018348.tif |
|  | DE-3119_1(1) id=703476 00018361.tif |  | DE-3120_1(1) id=703491 00018377.tif |  | DE-3121_1(1) id=703503 00018391.tif |
|  | DE-3122_1(1) id=703553 00018454.tif |  | DE-3123_1(1) id=703557 00018460.tif |  | DE-3124_1(1) id=703559 00018465.tif |
|  | DE-3125_1(1) id=703589 00018496.tif |  | DE-3126_1(1) id=703617 00018530.tif |  | DE-3127_1(1) id=703624 00018542.tif |
|  | DE-3128_1(1) id=703626 00018544.tif |  | DE-3129_1(1) id=703633 00018551.tif |  | DE-3130_1(1) id=703642 00018561.tif |
|  | DE-3131_1(1) id=703645 00018564.tif |  | DE-3132_1(1) id=703666 00018600.tif |  | DE-3133_1(1) id=703667 00018601.tif |

| | | | | | |
|---|---|---|---|---|---|
|  | DE-3134_1(1) id=703668 00018603.tif |  | DE-3135_1(1) id=703678 00018619.tif |  | DE-3136_1(1) id=703679 00018620.tif |
|  | DE-3137_1(1) id=703680 00018622.tif |  | DE-3138_1(1) id=703685 00018628.tif |  | DE-3139_1(1) id=703688 00018631.tif |
|  | DE-3140_1(1) id=703691 00018634.tif |  | DE-3141_1(1) id=703692 00018635.tif |  | DE-3142_1(1) id=703703 00018649.tif |
|  | DE-3143_1(1) id=703704 00018650.tif |  | DE-3144_1(1) id=703723 00018672.tif |  | DE-3145_1(1) id=703729 00018678.tif |
|  | DE-3146_1(1) id=703730 00018679.tif |  | DE-3147_1(1) id=703739 00018690.tif |  | DE-3148_1(1) id=703743 00018694.tif |
|  | DE-3149_1(1) id=703750 00018704.tif |  | DE-3150_1(1) id=703755 00018709.tif |  | DE-3151_1(1) id=703762 00018723.tif |
|  | DE-3152_1(1) id=703766 00018727.tif |  | DE-3153_1(1) id=703767 00018728.tif |  | DE-3154_1(1) id=703771 00018732.tif |













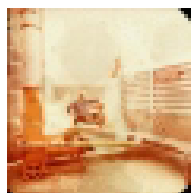
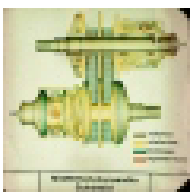





| | | | | | |
|---|---|---|---|---|---|
|  | DE-3155_1(1) id=703772 00018734.tif |  | DE-3156_1(1) id=703790 00018754.tif |  | DE-3157_1(1) id=703795 00018759.tif |
|  | DE-3158_1(1) id=703808 00018773.tif |  | DE-3159_1(1) id=703822 00018789.tif |  | DE-3160_1(1) id=703831 00018801.tif |
|  | DE-3161_1(1) id=703846 00018823.tif |  | DE-3162_1(1) id=703847 00018824.tif |  | DE-3163_1(1) id=703877 00018870.tif |
|  | DE-3164_1(1) id=703910 00018908.tif |  | DE-3165_1(1) id=703911 00018909.tif |  | DE-3166_1(1) id=703915 00018913.tif |
|  | DE-3167_1(1) id=703918 00018919.tif |  | DE-3168_1(1) id=703932 00018941.tif |  | DE-3169_1(1) id=703933 00018943.tif |
|  | DE-3170_1(1) id=703984 00019015.tif |  | DE-3171_1(1) id=703997 00019036.tif |  | DE-3172_1(1) id=704023 00019068.tif |
|  | DE-3173_1(1) id=704059 00019118.tif |  | DE-3174_1(1) id=704126 00019237.tif |  | DE-3175_1(1) id=704127 00019238.tif |
|  | DE-3176_1(1) id=704136 00019248.tif |  | DE-3177_1(1) id=704141 00019253.tif |  | DE-3178_1(1) id=704148 00019260.tif |
|  | DE-3179_1(1) id=704203 00019320.tif |  | DE-3180_1(1) id=704222 00019343.tif |  | DE-3181_1(1) id=704277 00019413.tif |
|  | DE-3182_1(1) id=704279 00019415.tif |  | DE-3183_1(1) id=704281 00019418.tif |  | DE-3184_1(1) id=704294 00019435.tif |



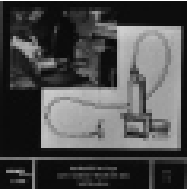















| | | | | | |
|---|---|---|---|---|---|
|  | DE-3185_1(1) id=704325 00019473.tif |  | DE-3186_1(1) id=704328 00019476.tif |  | DE-3187_1(1) id=704370 00019533.tif |
|  | DE-3188_1(1) id=704371 00019534.tif |  | DE-3189_1(1) id=704387 00019553.tif |  | DE-3190_1(1) id=704397 00019568.tif |
|  | DE-3191_1(1) id=704428 00019609.tif |  | DE-3192_1(1) id=704476 00019669.tif |  | DE-3193_1(1) id=704496 00019696.tif |
|  | DE-3194_1(1) id=704502 00019705.tif |  | DE-3195_1(1) id=704535 00019746.tif |  | DE-3196_1(1) id=704611 00019846.tif |
|  | DE-3197_1(1) id=704643 00019890.tif |  | DE-3198_1(1) id=704654 00019903.tif |  | DE-3199_1(1) id=704801 00020099.tif |
|  | DE-3200_1(1) id=704807 982156.png |  | DE-3201_1(1) id=704852 00020171.tif |  | DE-3202_1(1) id=704868 00020190.tif |
|  | DE-3203_1(1) id=704888 00020214.tif |  | DE-3204_1(1) id=704895 00020224.tif |  | DE-3205_1(1) id=705021 00020382.tif |
|  | DE-3206_1(1) id=705043 00020414.tif |  | DE-3207_1(1) id=705102 932395.png |  | DE-3208_1(1) id=705141 00020538.tif |

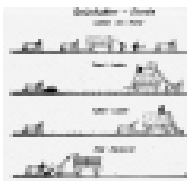









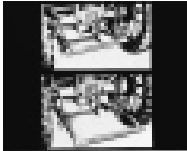















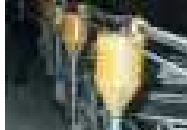

| | | | | | |
|---|---|---|---|---|---|
|  | DE-3209_1(1) id=705147 00020544.tif |  | DE-3210_1(1) id=705156 00020556.tif |  | DE-3211_1(1) id=705180 00020586.tif |
|  | DE-3212_1(1) id=705185 00020595.tif |  | DE-3213_1(1) id=705192 00020603.tif |  | DE-3214_1(1) id=705195 00020607.tif |
|  | DE-3215_1(1) id=705209 00020624.tif |  | DE-3216_1(1) id=705210 00020625.tif |  | DE-3217_1(1) id=705271 00020709.tif |
|  | DE-3218_1(1) id=705323 00020766.tif |  | DE-3219_1(1) id=705342 00020791.tif |  | DE-3220_1(1) id=705407 00020906.tif |
|  | DE-3221_1(1) id=705411 00020909.tif |  | DE-3222_1(1) id=705416 00020914.tif |  | DE-3223_1(1) id=705422 00020922.tif |
|  | DE-3224_1(1) id=705423 00020923.tif |  | DE-3225_1(1) id=705424 00020924.tif |  | DE-3226_1(1) id=705425 00020925.tif |
|  | DE-3227_1(1) id=705438 00020942.tif |  | DE-3228_1(1) id=705444 00020948.tif |  | DE-3229_1(1) id=705480 942397.png |
|  | DE-3230_1(1) id=705503 00021027.tif |  | DE-3231_1(1) id=705523 00021048.tif |  | DE-3232_1(1) id=705524 00021049.tif |
|  | DE-3233_1(1) id=705540 00021073.tif |  | DE-3234_1(1) id=705541 00021074.tif |  | DE-3235_1(1) id=705551 00021091.tif |
|  | DE-3236_1(1) id=705553 00021094.tif |  | DE-3237_1(1) id=705573 00021118.tif |  | DE-3238_1(1) id=705578 00021124.tif |

| | | | | | |
|---|---|---|---|---|---|
|  | DE-3239_1(1) id=705584 00021135.tif |  | DE-3240_1(1) id=705585 00021136.tif |  | DE-3241_1(1) id=705586 00021137.tif |
|  | DE-3242_1(1) id=705612 00021166.tif |  | DE-3243_1(1) id=705620 962045.png |  | DE-3244_1(1) id=705621 00021182.tif |
|  | DE-3245_1(1) id=705633 00021205.tif |  | DE-3246_1(1) id=705635 00021207.tif |  | DE-3247_1(1) id=705649 00021226.tif |
|  | DE-3248_1(1) id=705670 00021256.tif |  | DE-3249_1(1) id=705685 00021275.tif |  | DE-3250_1(1) id=705688 00021278.tif |
|  | DE-3251_1(1) id=705694 00021288.tif |  | DE-3252_1(1) id=705732 00021340.tif |  | DE-3253_1(1) id=705746 00021359.tif |
|  | DE-3254_1(1) id=705748 00021361.tif |  | DE-3255_1(1) id=705758 00021373.tif |  | DE-3256_1(1) id=705772 932003.png |
|  | DE-3257_1(1) id=705848 00021499.tif |  | DE-3258_1(1) id=705862 00021518.tif |  | DE-3259_1(1) id=705868 00021525.tif |
|  | DE-3260_1(1) id=705880 00021539.tif |  | DE-3261_1(1) id=705916 00021583.tif |  | DE-3262_1(1) id=706000 00021680.tif |
|  | DE-3263_1(1) id=706076 00021784.tif |  | DE-3264_1(1) id=706088 00021797.tif |  | DE-3265_1(1) id=706089 00021798.tif |
|  | DE-3266_1(1) id=706108 00021820.tif |  | DE-3267_1(1) id=706122 00021838.tif |  | DE-3268_1(1) id=706134 00021856.tif |
|  | DE-3269_1(1) id=706137 00021860.tif |  | DE-3270_1(1) id=706142 00021867.tif |  | DE-3271_1(1) id=706143 00021869.tif |







| | | | | | |
|---|---|---|---|---|---|
|  | DE-3272_1(1) id=706148 00021875.tif |  | DE-3273_1(1) id=706163 00021897.tif |  | DE-3274_1(1) id=706180 00021917.tif |
|  | DE-3275_1(1) id=706182 00021920.tif |  | DE-3276_1(1) id=706218 00022013.tif |  | DE-3277_1(1) id=706247 00022064.tif |
|  | DE-3278_1(1) id=706249 00022066.tif |  | DE-3279_1(1) id=706251 00022068.tif |  | DE-3280_1(1) id=706254 00022072.tif |
|  | DE-3281_1(1) id=706255 00022073.tif |  | DE-3282_1(1) id=706262 00022083.tif |  | DE-3283_1(1) id=706266 00022087.tif |
|  | DE-3284_1(1) id=706274 00022095.tif |  | DE-3285_1(1) id=706285 00022111.tif |  | DE-3286_1(1) id=706306 00022133.tif |
|  | DE-3287_1(1) id=706311 00022139.tif |  | DE-3288_1(1) id=706328 00022160.tif |  | DE-3289_1(1) id=706339 00022175.tif |
|  | DE-3290_1(1) id=706340 00022177.tif |  | DE-3291_1(1) id=706387 00022241.tif |  | DE-3292_1(1) id=706393 00022248.tif |





















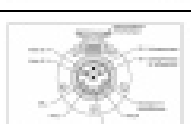

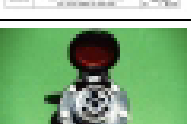

| | | |
|---|---|---|
|  DE-3293_1(1) id=706410 00022269.tif |  DE-3294_1(1) id=706420 00022281.tif |  DE-3295_1(1) id=706426 00022287.tif |
|  DE-3296_1(1) id=706435 00022297.tif |  DE-3297_1(1) id=706439 00022302.tif |  DE-3298_1(1) id=706460 00022328.tif |
|  DE-3299_1(1) id=706469 00022338.tif |  DE-3300_1(1) id=706503 00022382.tif |  DE-3301_1(1) id=706514 00022396.tif |
|  DE-3302_1(1) id=706546 00022468.tif |  DE-3303_1(1) id=706552 00022475.tif |  DE-3304_1(1) id=706555 00022479.tif |
|  DE-3305_1(1) id=706557 00022482.tif |  DE-3306_1(1) id=706558 00022483.tif |  DE-3307_1(1) id=706565 00022492.tif |
|  DE-3308_1(1) id=706604 00022545.tif |  DE-3309_1(1) id=706614 00022557.tif |  DE-3310_1(1) id=706616 00022559.tif |
|  DE-3311_1(1) id=706623 00022567.tif |  DE-3312_1(1) id=706627 00022572.tif |  DE-3313_1(1) id=706630 00022574.tif |

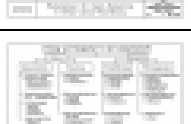



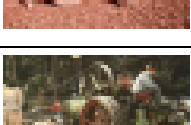









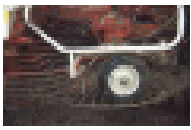









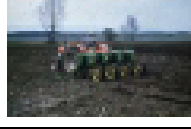

| | | | | | |
|---|---|---|---|---|---|
|  | DE-3314_1(1) id=706634 00022578.tif |  | DE-3315_1(1) id=706644 00022590.tif |  | DE-3316_1(1) id=706649 00022596.tif |
|  | DE-3317_1(1) id=706650 00022597.tif |  | DE-3318_1(1) id=706651 00022598.tif |  | DE-3319_1(1) id=706653 00022604.tif |
|  | DE-3320_1(1) id=706661 00022614.tif |  | DE-3321_1(1) id=706665 00022619.tif |  | DE-3322_1(1) id=706670 00022624.tif |
|  | DE-3323_1(1) id=706697 00022680.tif |  | DE-3324_1(1) id=706712 00022700.tif |  | DE-3325_1(1) id=706734 00022737.tif |
|  | DE-3326_1(1) id=706747 00022753.tif |  | DE-3327_1(1) id=706795 00022814.tif |  | DE-3328_1(1) id=706815 00022835.tif |
|  | DE-3329_1(1) id=706838 00022865.tif |  | DE-3330_1(1) id=706839 00022866.tif |  | DE-3331_1(1) id=706845 00022883.tif |
|  | DE-3332_1(1) id=706854 00022895.tif |  | DE-3333_1(1) id=706859 00022900.tif |  | DE-3334_1(1) id=706863 00022906.tif |

| | | | | | |
|---|---|---|---|---|---|
|  | DE-3335_1(1) id=706876 00022923.tif |  | DE-3336_1(1) id=706879 00022927.tif |  | DE-3337_1(1) id=706886 00022936.tif |
|  | DE-3338_1(1) id=706915 00022973.tif |  | DE-3339_1(1) id=706918 00022976.tif |  | DE-3340_1(1) id=706932 00022990.tif |
|  | DE-3341_1(1) id=706949 00023025.tif |  | DE-3342_1(1) id=706987 00023065.tif |  | DE-3343_1(1) id=707004 00023085.tif |
|  | DE-3344_1(1) id=707155 00023372.tif |  | DE-3345_1(1) id=707176 00023404.tif |  | DE-3346_1(1) id=707213 00023462.tif |
|  | DE-3347_1(1) id=707233 912431.png |  | DE-3348_1(1) id=707237 00023491.tif |  | DE-3349_1(1) id=707269 00023534.tif |
|  | DE-3350_1(1) id=707279 00023548.tif |  | DE-3351_1(1) id=707292 00023568.tif |  | DE-3352_1(1) id=707293 00023569.tif |
|  | DE-3353_1(1) id=707322 00023606.tif |  | DE-3354_1(1) id=707348 00023638.tif |  | DE-3355_1(1) id=707351 00023641.tif |
|  | DE-3356_1(1) id=707376 00023670.tif |  | DE-3357_1(1) id=707378 00023673.tif |  | DE-3358_1(1) id=707437 00023753.tif |
|  | DE-3359_1(1) id=707438 00023754.tif |  | DE-3360_1(1) id=707457 00023778.tif |  | DE-3361_1(1) id=707486 00023826.tif |
|  | DE-3362_1(1) id=707513 00023869.tif |  | DE-3363_1(1) id=707537 00023906.tif |  | DE-3364_1(1) id=707539 00023908.tif |



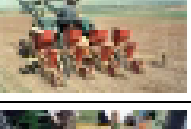

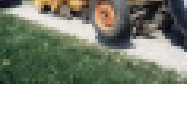

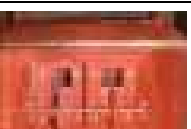























| | | | | | |
|---|---|---|---|---|---|
|  | DE-3365_1(1) id=707589 00023979.tif |  | DE-3366_1(1) id=707628 00024030.tif |  | DE-3367_1(1) id=707681 00024126.tif |
|  | DE-3368_1(1) id=707691 942425.png |  | DE-3369_1(1) id=707725 00024204.tif |  | DE-3370_1(1) id=707742 00024223.tif |
|  | DE-3371_1(1) id=707799 00024311.tif |  | DE-3372_1(1) id=707822 00024343.tif |  | DE-3373_1(1) id=707834 00024358.tif |
|  | DE-3374_1(1) id=707852 00024381.tif |  | DE-3375_1(1) id=707858 00024389.tif |  | DE-3376_1(1) id=707859 00024390.tif |
|  | DE-3377_1(1) id=707869 00024403.tif |  | DE-3378_1(1) id=707878 00024413.tif |  | DE-3379_1(1) id=707879 00024414.tif |
|  | DE-3380_1(1) id=707880 00024415.tif |  | DE-3381_1(1) id=707881 00024416.tif |  | DE-3382_1(1) id=707889 00024424.tif |
|  | DE-3383_1(1) id=707922 00024477.tif |  | DE-3384_1(1) id=707935 00024493.tif |  | DE-3385_1(1) id=707941 00024509.tif |
|  | DE-3386_1(1) id=707942 952472.png |  | DE-3387_1(1) id=707943 932355.png |  | DE-3388_1(1) id=707978 00024683.tif |
|  | DE-3389_1(1) id=707982 00024687.tif |  | DE-3390_1(1) id=708045 932140.png |  | DE-3391_1(1) id=708092 00024870.tif |
|  | DE-3392_1(1) id=708116 00024911.tif |  | DE-3393_1(1) id=708151 00024964.tif |  | DE-3394_1(1) id=708161 00024976.tif |













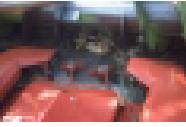

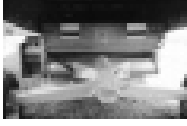
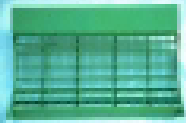











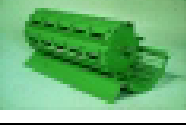





| | | | | | |
|---|---|---|---|---|---|
|  | DE-3395_1(1) id=708168 00024988.tif |  | DE-3396_1(1) id=708189 00025032.tif |  | DE-3397_1(1) id=708336 00025246.tif |
|  | DE-3398_1(1) id=708359 00025284.tif |  | DE-3399_1(1) id=708426 00025405.tif |  | DE-3400_1(1) id=708451 932354.png |
|  | DE-3401_1(1) id=708455 00025459.tif |  | DE-3402_1(1) id=708467 00025474.tif |  | DE-3403_1(1) id=708495 912091.png |
|  | DE-3404_1(1) id=708556 00025627.tif |  | DE-3405_1(1) id=708610 932369.png |  | DE-3406_1(1) id=708614 932338.png |
|  | DE-3407_1(1) id=708642 00025760.tif |  | DE-3408_1(1) id=708644 00025766.tif |  | DE-3409_1(1) id=708656 00025783.tif |
|  | DE-3410_1(1) id=708675 00025818.tif |  | DE-3411_1(1) id=708676 00025821.tif |  | DE-3412_1(1) id=708709 952086.png |
|  | DE-3413_1(1) id=708760 00025937.tif |  | DE-3414_1(1) id=708810 00026000.tif |  | DE-3415_1(1) id=708816 00026009.tif |
|  | DE-3416_1(1) id=708822 922377.png |  | DE-3417_1(1) id=708937 00026204.tif |  | DE-3418_1(1) id=708946 00026228.tif |
|  | DE-3419_1(1) id=708964 00026255.tif |  | DE-3420_1(1) id=708982 00026296.tif |  | DE-3421_1(1) id=708998 00026320.tif |













| | | | | | |
|---|---|---|---|---|---|
|  | DE-3422_1(1) id=709030 00026363.tif |  | DE-3423_1(1) id=709038 00026375.tif |  | DE-3424_1(1) id=709049 00026387.tif |
|  | DE-3425_1(1) id=709050 00026388.tif |  | DE-3426_1(1) id=709055 00026393.tif |  | DE-3427_1(1) id=709062 00026400.tif |
|  | DE-3428_1(1) id=709110 912419.png |  | DE-3429_1(1) id=709169 00026573.tif |  | DE-3430_1(1) id=709233 00026666.tif |
|  | DE-3431_1(1) id=709234 00026667.tif |  | DE-3432_1(1) id=709246 972380.png |  | DE-3433_1(1) id=709291 00026742.tif |
|  | DE-3434_1(1) id=709380 00026905.tif |  | DE-3435_1(1) id=709465 972145.png |  | DE-3436_1(1) id=709488 962184.png |
|  | DE-3437_1(1) id=709665 00027428.tif |  | DE-3438_1(1) id=709667 00027433.tif |  | DE-3439_1(1) id=709669 00027436.tif |
|  | DE-3440_1(1) id=709681 00027467.tif |  | DE-3441_1(1) id=709689 952280.png |  | DE-3442_1(1) id=709695 952177.png |
|  | DE-3443_1(1) id=709697 952153.png |  | DE-3444_1(1) id=709700 952430.png |  | DE-3445_1(1) id=709773 00027608.tif |
|  | DE-3446_1(1) id=709778 00027626.tif |  | DE-3447_1(1) id=709780 00027638.tif |  | DE-3448_1(1) id=709800 922066.png |
|  | DE-3449_1(1) id=709804 922107.png |  | DE-3450_1(1) id=709809 00027694.tif |  | DE-3451_1(1) id=709817 00027703.tif |
|  | DE-3452_1(1) id=709856 00027756.tif |  | DE-3453_1(1) id=710150 912227.png |  | DE-3454_1(1) id=710172 00028217.tif |

| | | | | | |
|---|---|---|---|---|---|
|  | DE-3455_1(1) id=710329 00028502.tif |  | DE-3456_1(1) id=710360 912355.png |  | DE-3457_1(1) id=710377 00028616.tif |
|  | DE-3458_1(1) id=710409 972271.png |  | DE-3459_1(1) id=710417 00028674.tif |  | DE-3460_1(1) id=710418 00028675.tif |
|  | DE-3461_1(1) id=710419 00028676.tif |  | DE-3462_1(1) id=710433 972338.png |  | DE-3463_1(1) id=710591 00028988.tif |
|  | DE-3464_1(1) id=710649 00029065.tif |  | DE-3465_1(1) id=710657 00029076.tif |  | DE-3466_1(1) id=710689 00029115.tif |
|  | DE-3467_1(1) id=710690 00029116.tif |  | DE-3468_1(1) id=710710 00029169.tif |  | DE-3469_1(1) id=710782 00029262.tif |
|  | DE-3470_1(1) id=710784 00029265.tif |  | DE-3471_1(1) id=710787 00029269.tif |  | DE-3472_1(1) id=710788 00029270.tif |
|  | DE-3473_1(1) id=710791 00029274.tif |  | DE-3474_1(1) id=710792 00029275.tif |  | DE-3475_1(1) id=710795 00029281.tif |
|  | DE-3476_1(1) id=710797 00029283.tif |  | DE-3477_1(1) id=710804 00029297.tif |  | DE-3478_1(1) id=710849 00029354.tif |
|  | DE-3479_1(1) id=710865 00029375.tif |  | DE-3480_1(1) id=710874 00029384.tif |  | DE-3481_1(1) id=710909 00029422.tif |
|  | DE-3482_1(1) id=710910 00029423.tif |  | DE-3483_1(1) id=710912 00029425.tif |  | DE-3484_1(1) id=710914 00029427.tif |











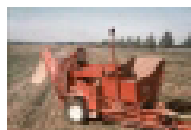









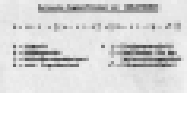







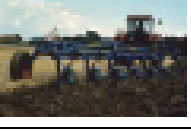

| | | | | | |
|---|---|---|---|---|---|
|  | DE-3485_1(1) id=710915 00029428.tif |  | DE-3486_1(1) id=710916 00029429.tif |  | DE-3487_1(1) id=710917 00029430.tif |
|  | DE-3488_1(1) id=710932 00029455.tif |  | DE-3489_1(1) id=710983 00029525.tif |  | DE-3490_1(1) id=711033 00029587.tif |
|  | DE-3491_1(1) id=711046 00029603.tif |  | DE-3492_1(1) id=711066 00029627.tif |  | DE-3493_1(1) id=711069 00029633.tif |
|  | DE-3494_1(1) id=711072 00029637.tif |  | DE-3495_1(1) id=711085 00029657.tif |  | DE-3496_1(1) id=711143 00029729.tif |
|  | DE-3497_1(1) id=711146 00029732.tif |  | DE-3498_1(1) id=711177 00029772.tif |  | DE-3499_1(1) id=711185 00029782.tif |
|  | DE-3500_1(1) id=711187 00029784.tif |  | DE-3501_1(1) id=711196 00029794.tif |  | DE-3502_1(1) id=711198 00029796.tif |
|  | DE-3503_1(1) id=711199 00029797.tif |  | DE-3504_1(1) id=711206 00029804.tif |  | DE-3505_1(1) id=711207 00029805.tif |
|  | DE-3506_1(1) id=711214 00029813.tif |  | DE-3507_1(1) id=711215 00029814.tif |  | DE-3508_1(1) id=711216 00029815.tif |
|  | DE-3509_1(1) id=711248 00029853.tif |  | DE-3510_1(1) id=711259 00029869.tif |  | DE-3511_1(1) id=711263 00029873.tif |
|  | DE-3512_1(1) id=711276 00029888.tif |  | DE-3513_1(1) id=711277 00029889.tif |  | DE-3514_1(1) id=711281 00029896.tif |

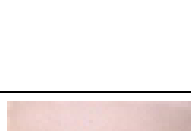
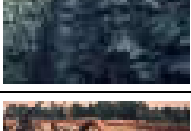



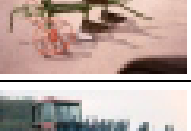

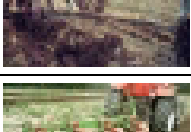















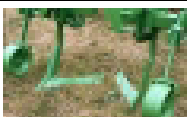

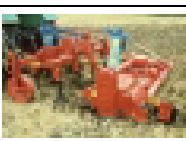

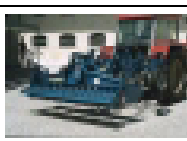
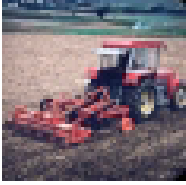







| | | | | | |
|---|---|---|---|---|---|
|  | DE-3515_1(1) id=711287 00029903.tif |  | DE-3516_1(1) id=711288 00029904.tif |  | DE-3517_1(1) id=711289 00029905.tif |
|  | DE-3518_1(1) id=711293 00029909.tif |  | DE-3519_1(1) id=711298 00029915.tif |  | DE-3520_1(1) id=711309 00029927.tif |
|  | DE-3521_1(1) id=711310 00029929.tif |  | DE-3522_1(1) id=711311 00029930.tif |  | DE-3523_1(1) id=711312 00029931.tif |
|  | DE-3524_1(1) id=711313 00029932.tif |  | DE-3525_1(1) id=711314 00029934.tif |  | DE-3526_1(1) id=711315 00029935.tif |
|  | DE-3527_1(1) id=711320 00029941.tif |  | DE-3528_1(1) id=711323 00029945.tif |  | DE-3529_1(1) id=711329 00029952.tif |
|  | DE-3530_1(1) id=711331 00029954.tif |  | DE-3531_1(1) id=711333 00029957.tif |  | DE-3532_1(1) id=711334 00029958.tif |
|  | DE-3533_1(1) id=711335 00029959.tif |  | DE-3534_1(1) id=711336 00029961.tif |  | DE-3535_1(1) id=711339 00029965.tif |
|  | DE-3536_1(1) id=711341 00029969.tif |  | DE-3537_1(1) id=711343 00029971.tif |  | DE-3538_1(1) id=711345 00029973.tif |
|  | DE-3539_1(1) id=711346 00029974.tif |  | DE-3540_1(1) id=711348 00029976.tif |  | DE-3541_1(1) id=711349 00029978.tif |
|  | DE-3542_1(1) id=711352 00029982.tif |  | DE-3543_1(1) id=711354 00029984.tif |  | DE-3544_1(1) id=711356 00029987.tif |





















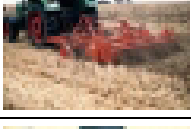









| | | | | | |
|---|---|---|---|---|---|
|  | DE-3545_1(1) id=711357 00029988.tif |  | DE-3546_1(1) id=711359 00029990.tif |  | DE-3547_1(1) id=711361 00029992.tif |
|  | DE-3548_1(1) id=711417 00030070.tif |  | DE-3549_1(1) id=711422 00030075.tif |  | DE-3550_1(1) id=711444 00030097.tif |
|  | DE-3551_1(1) id=711451 00030105.tif |  | DE-3552_1(1) id=711452 00030106.tif |  | DE-3553_1(1) id=711456 00030110.tif |
|  | DE-3554_1(1) id=711464 00030118.tif |  | DE-3555_1(1) id=711467 00030121.tif |  | DE-3556_1(1) id=711476 00030131.tif |
|  | DE-3557_1(1) id=711501 00030157.tif |  | DE-3558_1(1) id=711502 00030158.tif |  | DE-3559_1(1) id=711521 00030177.tif |
|  | DE-3560_1(1) id=711535 00030191.tif |  | DE-3561_1(1) id=711549 00030207.tif |  | DE-3562_1(1) id=711557 00030215.tif |
|  | DE-3563_1(1) id=711574 00030232.tif |  | DE-3564_1(1) id=711627 00030307.tif |  | DE-3565_1(1) id=711668 00030354.tif |
|  | DE-3566_1(1) id=711675 00030363.tif |  | DE-3567_1(1) id=711676 00030364.tif |  | DE-3568_1(1) id=711690 00030380.tif |
|  | DE-3569_1(1) id=711734 00030430.tif |  | DE-3570_1(1) id=711735 00030431.tif |  | DE-3571_1(1) id=711741 00030437.tif |
|  | DE-3572_1(1) id=711747 00030443.tif |  | DE-3573_1(1) id=711748 00030444.tif |  | DE-3574_1(1) id=711766 00030466.tif |
|  | DE-3575_1(1) id=711777 00030477.tif |  | DE-3576_1(1) id=711779 00030480.tif |  | DE-3577_1(1) id=711787 00030488.tif |











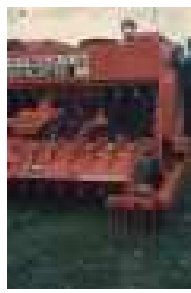

















| | | | | | |
|---|---|---|---|---|---|
|  | DE-3578_1(1) id=711791 00030492.tif |  | DE-3579_1(1) id=711794 00030495.tif |  | DE-3580_1(1) id=711799 00030500.tif |
|  | DE-3581_1(1) id=711823 00030526.tif |  | DE-3582_1(1) id=711825 00030528.tif |  | DE-3583_1(1) id=711826 00030529.tif |
|  | DE-3584_1(1) id=711835 00030539.tif |  | DE-3585_1(1) id=711838 00030542.tif |  | DE-3586_1(1) id=711846 00030551.tif |
|  | DE-3587_1(1) id=711847 00030552.tif |  | DE-3588_1(1) id=711850 00030555.tif |  | DE-3589_1(1) id=711879 00030584.tif |
|  | DE-3590_1(1) id=711882 00030587.tif |  | DE-3591_1(1) id=711887 00030592.tif |  | DE-3592_1(1) id=711888 00030593.tif |
|  | DE-3593_1(1) id=711889 00030594.tif |  | DE-3594_1(1) id=711890 00030595.tif |  | DE-3595_1(1) id=711895 00030600.tif |
|  | DE-3596_1(1) id=711899 00030604.tif |  | DE-3597_1(1) id=711912 00030619.tif |  | DE-3598_1(1) id=711914 00030621.tif |
|  | DE-3599_1(1) id=711916 00030623.tif |  | DE-3600_1(1) id=711917 00030624.tif |  | DE-3601_1(1) id=711921 00030628.tif |
|  | DE-3602_1(1) id=711924 00030631.tif |  | DE-3603_1(1) id=711926 00030633.tif |  | DE-3604_1(1) id=711929 00030636.tif |





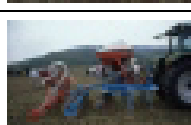
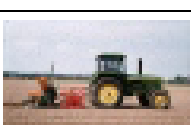













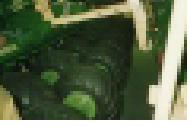













| | | | | | |
|---|---|---|---|---|---|
|  | DE-3605_1(1) id=711987 00030700.tif |  | DE-3606_1(1) id=712004 00030717.tif |  | DE-3607_1(1) id=712007 00030720.tif |
|  | DE-3608_1(1) id=712041 00030754.tif |  | DE-3609_1(1) id=712123 00030844.tif |  | DE-3610_1(1) id=712142 00030864.tif |
|  | DE-3611_1(1) id=712148 00030870.tif |  | DE-3612_1(1) id=712155 00030880.tif |  | DE-3613_1(1) id=712159 00030885.tif |
|  | DE-3614_1(1) id=712179 00030905.tif |  | DE-3615_1(1) id=712198 00030929.tif |  | DE-3616_1(1) id=712205 00030935.tif |
|  | DE-3617_1(1) id=712208 00030938.tif |  | DE-3618_1(1) id=712217 00030948.tif |  | DE-3619_1(1) id=712220 00030951.tif |
|  | DE-3620_1(1) id=712227 00030959.tif |  | DE-3621_1(1) id=712231 00030963.tif |  | DE-3622_1(1) id=712233 00030965.tif |
|  | DE-3623_1(1) id=712239 00030971.tif |  | DE-3624_1(1) id=712252 00030984.tif |  | DE-3625_1(1) id=712253 00030985.tif |
|  | DE-3626_1(1) id=712256 00030988.tif |  | DE-3627_1(1) id=712264 00030996.tif |  | DE-3628_1(1) id=712266 00030998.tif |
|  | DE-3629_1(1) id=712280 00031012.tif |  | DE-3630_1(1) id=712295 00031027.tif |  | DE-3631_1(1) id=712296 00031028.tif |
|  | DE-3632_1(1) id=712297 00031029.tif |  | DE-3633_1(1) id=712308 00031041.tif |  | DE-3634_1(1) id=712315 00031048.tif |
|  | DE-3635_1(1) id=712319 00031052.tif |  | DE-3636_1(1) id=712321 00031054.tif |  | DE-3637_1(1) id=712372 00031120.tif |

| | | |
|---|---|---|
|  DE-3638_1(1) id=712380 00031128.tif |  DE-3639_1(1) id=712384 00031132.tif |  DE-3640_1(1) id=712391 00031139.tif |
|  DE-3641_1(1) id=712397 00031145.tif |  DE-3642_1(1) id=712423 00031171.tif |  DE-3643_1(1) id=712425 00031173.tif |
|  DE-3644_1(1) id=712440 00031189.tif |  DE-3645_1(1) id=712461 00031214.tif |  DE-3646_1(1) id=712505 00031274.tif |
|  DE-3647_1(1) id=712571 00031379.tif |  DE-3648_1(1) id=712585 00031407.tif |  DE-3649_1(1) id=712587 00031410.tif |
|  DE-3650_1(1) id=712616 00031452.tif |  DE-3651_1(1) id=712635 942040.png |  DE-3652_1(1) id=712639 952072.png |
|  DE-3653_1(1) id=712641 00031498.tif |  DE-3654_1(1) id=712652 00031510.tif |  DE-3655_1(1) id=712654 00031512.tif |
|  DE-3656_1(1) id=712656 00031514.tif |  DE-3657_1(1) id=712662 00031520.tif |  DE-3658_1(1) id=712666 00031524.tif |
|  DE-3659_1(1) id=712671 00031529.tif |  DE-3660_1(1) id=712674 00031532.tif |  DE-3661_1(1) id=712678 00031536.tif |
|  DE-3662_1(1) id=712682 00031540.tif |  DE-3663_1(1) id=712683 00031541.tif |  DE-3664_1(1) id=712687 00031545.tif |
|  DE-3665_1(1) id=712697 00031555.tif |  DE-3666_1(1) id=712698 00031556.tif |  DE-3667_1(1) id=712709 00031567.tif |
|  DE-3668_1(1) id=712717 00031575.tif |  DE-3669_1(1) id=712760 00031624.tif |  DE-3670_1(1) id=712761 00031625.tif |





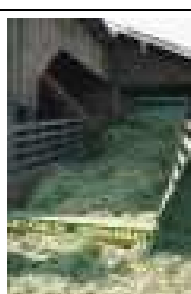





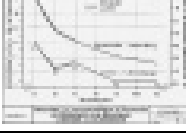

| | | |
|---|---|---|
|  DE-3671_1(1) id=712765 00031629.tif |  DE-3672_1(1) id=712789 00031654.tif |  DE-3673_1(1) id=712793 00031658.tif |
|  DE-3674_1(1) id=712794 00031659.tif |  DE-3675_1(1) id=712795 00031660.tif |  DE-3676_1(1) id=712798 00031663.tif |
|  DE-3677_1(1) id=712808 00031673.tif |  DE-3678_1(1) id=712900 00031777.tif |  DE-3679_1(1) id=712901 00031778.tif |
|  DE-3680_1(1) id=712905 00031782.tif |  DE-3681_1(1) id=712910 00031787.tif |  DE-3682_1(1) id=712941 00031818.tif |
|  DE-3683_1(1) id=712973 00031850.tif |  DE-3684_1(1) id=712991 00031868.tif |  DE-3685_1(1) id=712995 00031872.tif |
|  DE-3686_1(1) id=713001 00031878.tif |  DE-3687_1(1) id=713003 00031880.tif |  DE-3688_1(1) id=713005 00031882.tif |
|  DE-3689_1(1) id=713009 00031886.tif |  DE-3690_1(1) id=713013 00031891.tif |  DE-3691_1(1) id=713018 00031896.tif |
|  DE-3692_1(1) id=713039 00031925.tif |  DE-3693_1(1) id=713063 00031950.tif |  DE-3694_1(1) id=713070 00031957.tif |
|  DE-3695_1(1) id=713080 00031967.tif |  DE-3696_1(1) id=713088 00031975.tif |  DE-3697_1(1) id=713096 00031984.tif |
|  DE-3698_1(1) id=713097 00031985.tif |  DE-3699_1(1) id=713116 00032005.tif |  DE-3700_1(1) id=713128 00032017.tif |
|  DE-3701_1(1) id=713160 00032050.tif |  DE-3702_1(1) id=713164 00032054.tif |  DE-3703_1(1) id=713177 00032068.tif |
|  DE-3704_1(1) id=713186 00032077.tif |  DE-3705_1(1) id=713187 00032078.tif |  DE-3706_1(1) id=713200 00032091.tif |

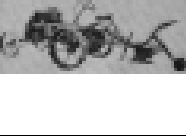
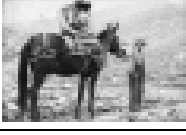















| | | | | | |
|---|---|---|---|---|---|
|  | DE-3707_1(1) id=713245 00032142.tif |  | DE-3708_1(1) id=713279 00032176.tif |  | DE-3709_1(1) id=713295 00032192.tif |
|  | DE-3710_1(1) id=713334 00032239.tif |  | DE-3711_1(1) id=713348 00032253.tif |  | DE-3712_1(1) id=713364 00032269.tif |
|  | DE-3713_1(1) id=713380 00032285.tif |  | DE-3714_1(1) id=713407 00032314.tif |  | DE-3715_1(1) id=713426 00032339.tif |
|  | DE-3716_1(1) id=713436 00032349.tif |  | DE-3717_1(1) id=713441 00032354.tif |  | DE-3718_1(1) id=713443 00032356.tif |
|  | DE-3719_1(1) id=713463 00032376.tif |  | DE-3720_1(1) id=713466 00032379.tif |  | DE-3721_1(1) id=713481 00032396.tif |
|  | DE-3722_1(1) id=713482 00032397.tif |  | DE-3723_1(1) id=713506 00032427.tif |  | DE-3724_1(1) id=713527 00032452.tif |
|  | DE-3725_1(1) id=713532 00032458.tif |  | DE-3726_1(1) id=713599 00032532.tif |  | DE-3727_1(1) id=713600 00032533.tif |
|  | DE-3728_1(1) id=713606 00032539.tif |  | DE-3729_1(1) id=713636 00032571.tif |  | DE-3730_1(1) id=713642 00032578.tif |
|  | DE-3731_1(1) id=713651 00032587.tif |  | DE-3732_1(1) id=713654 00032590.tif |  | DE-3733_1(1) id=713672 00032608.tif |
|  | DE-3734_1(1) id=713674 00032610.tif |  | DE-3735_1(1) id=713702 00032639.tif |  | DE-3736_1(1) id=713705 00032642.tif |

| | | | | | |
|---|---|---|---|---|---|
|  | DE-3737_1(1) id=713706 00032643.tif |  | DE-3738_1(1) id=713727 00032664.tif |  | DE-3739_1(1) id=713730 00032667.tif |
|  | DE-3740_1(1) id=713732 00032669.tif |  | DE-3741_1(1) id=713735 00032672.tif |  | DE-3742_1(1) id=713742 00032679.tif |
|  | DE-3743_1(1) id=713745 00032682.tif |  | DE-3744_1(1) id=713755 00032692.tif |  | DE-3745_1(1) id=713775 00032713.tif |
|  | DE-3746_1(1) id=713777 00032715.tif |  | DE-3747_1(1) id=713778 00032716.tif |  | DE-3748_1(1) id=713779 00032717.tif |
|  | DE-3749_1(1) id=713790 00032728.tif |  | DE-3750_1(1) id=713797 00032735.tif |  | DE-3751_1(1) id=713810 00032749.tif |
|  | DE-3752_1(1) id=713814 00032753.tif |  | DE-3753_1(1) id=713821 00032761.tif |  | DE-3754_1(1) id=713824 00032765.tif |
|  | DE-3755_1(1) id=713832 00032775.tif |  | DE-3756_1(1) id=713835 00032778.tif |  | DE-3757_1(1) id=713856 00032799.tif |
|  | DE-3758_1(1) id=713861 00032805.tif |  | DE-3759_1(1) id=713862 00032806.tif |  | DE-3760_1(1) id=713872 00032816.tif |
|  | DE-3761_1(1) id=713883 00032827.tif |  | DE-3762_1(1) id=713896 00032840.tif |  | DE-3763_1(1) id=713899 00032843.tif |
|  | DE-3764_1(1) id=713904 00032848.tif |  | DE-3765_1(1) id=713909 00032853.tif |  | DE-3766_1(1) id=713911 00032855.tif |



















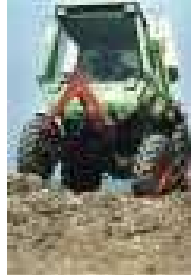



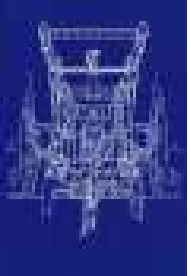







| | | |
|---|---|---|
|  DE-3767_1(1) id=713918 00032863.tif |  DE-3768_1(1) id=713921 00032866.tif |  DE-3769_1(1) id=713925 00032870.tif |
|  DE-3770_1(1) id=714016 00032964.tif |  DE-3771_1(1) id=714018 00032966.tif |  DE-3772_1(1) id=714021 00032969.tif |
|  DE-3773_1(1) id=714029 00032977.tif |  DE-3774_1(1) id=714036 00032984.tif |  DE-3775_1(1) id=714061 00033010.tif |
|  DE-3776_1(1) id=714091 00033040.tif |  DE-3777_1(1) id=714096 00033045.tif |  DE-3778_1(1) id=714103 00033053.tif |
|  DE-3779_1(1) id=714106 00033056.tif |  DE-3780_1(1) id=714126 00033077.tif |  DE-3781_1(1) id=714129 00033080.tif |
|  DE-3782_1(1) id=714130 00033081.tif |  DE-3783_1(1) id=714134 00033086.tif |  DE-3784_1(1) id=714149 00033101.tif |
|  DE-3785_1(1) id=714224 00033182.tif |  DE-3786_1(1) id=714226 00033184.tif |  DE-3787_1(1) id=714271 00033245.tif |
|  DE-3788_1(1) id=714293 00033272.tif |  DE-3789_1(1) id=714307 00033286.tif |  DE-3790_1(1) id=714320 00033301.tif |
|  DE-3791_1(1) id=714324 00033305.tif |  DE-3792_1(1) id=714325 00033306.tif |  DE-3793_1(1) id=714344 00033327.tif |
|  DE-3794_1(1) id=714345 00033328.tif |  DE-3795_1(1) id=714346 00033329.tif |  DE-3796_1(1) id=714362 00033347.tif |
|  DE-3797_1(1) id=714366 00033351.tif |  DE-3798_1(1) id=714367 00033352.tif |  DE-3799_1(1) id=714368 00033353.tif |

| | | | | | |
|---|---|---|---|---|---|
|  | DE-3800_1(1) id=714375 00033360.tif |  | DE-3801_1(1) id=714376 00033361.tif |  | DE-3802_1(1) id=714439 00033425.tif |
|  | DE-3803_1(1) id=714444 00033430.tif |  | DE-3804_1(1) id=714445 00033431.tif |  | DE-3805_1(1) id=714469 00033467.tif |
|  | DE-3806_1(1) id=714494 00033508.tif |  | DE-3807_1(1) id=714509 00033542.tif |  | DE-3808_1(1) id=714599 00033696.tif |
|  | DE-3809_1(1) id=714729 00033786.tif |  | DE-3810_1(1) id=714780 00033863.tif |  | DE-3811_1(1) id=714837 00033948.tif |
|  | DE-3812_1(1) id=714926 00034050.tif |  | DE-3813_1(1) id=714933 00034057.tif |  | DE-3814_1(1) id=714937 00034061.tif |
|  | DE-3815_1(1) id=714959 00034083.tif |  | DE-3816_1(1) id=715041 00034180.tif |  | DE-3817_1(1) id=715069 00034209.tif |
|  | DE-3818_1(1) id=715140 00034292.tif |  | DE-3819_1(1) id=715144 00034296.tif |  | DE-3820_1(1) id=715190 00034351.tif |
|  | DE-3821_1(1) id=715193 00034354.tif |  | DE-3822_1(1) id=715198 00034359.tif |  | DE-3823_1(1) id=715216 00034377.tif |
|  | DE-3824_1(1) id=715254 00034419.tif |  | DE-3825_1(1) id=715263 00034428.tif |  | DE-3826_1(1) id=715281 00034463.tif |

































| | | | | | |
|---|---|---|---|---|---|
|  | DE-3827_1(1) id=715290 00034472.tif |  | DE-3828_1(1) id=715301 00034483.tif |  | DE-3829_1(1) id=715307 00034491.tif |
|  | DE-3830_1(1) id=715317 00034501.tif |  | DE-3831_1(1) id=715335 00034520.tif |  | DE-3832_1(1) id=715350 00034538.tif |
|  | DE-3833_1(1) id=715371 00034561.tif |  | DE-3834_1(1) id=715376 00034567.tif |  | DE-3835_1(1) id=715395 00034589.tif |
|  | DE-3836_1(1) id=715457 00034654.tif |  | DE-3837_1(1) id=715468 00034668.tif |  | DE-3838_1(1) id=715469 00034669.tif |
|  | DE-3839_1(1) id=715470 00034670.tif |  | DE-3840_1(1) id=715481 00034681.tif |  | DE-3841_1(1) id=715500 00034719.tif |
|  | DE-3842_1(1) id=715506 00034728.tif |  | DE-3843_1(1) id=715507 00034729.tif |  | DE-3844_1(1) id=715528 00034753.tif |
|  | DE-3845_1(1) id=715551 00034776.tif |  | DE-3846_1(1) id=715554 00034779.tif |  | DE-3847_1(1) id=715579 00034804.tif |
|  | DE-3848_1(1) id=715598 00034823.tif |  | DE-3849_1(1) id=715742 00034974.tif |  | DE-3850_1(1) id=715747 00034983.tif |
|  | DE-3851_1(1) id=715755 00034991.tif |  | DE-3852_1(1) id=715757 00034993.tif |  | DE-3853_1(1) id=715759 00034995.tif |
|  | DE-3854_1(1) id=715763 00035001.tif |  | DE-3855_1(1) id=715764 00035002.tif |  | DE-3856_1(1) id=715768 00035006.tif |
|  | DE-3857_1(1) id=715775 00035013.tif |  | DE-3858_1(1) id=715777 00035015.tif |  | DE-3859_1(1) id=715779 00035017.tif |

| | | |
|---|---|---|
|  DE-3860_1(1) id=715781 00035019.tif |  DE-3861_1(1) id=715782 00035020.tif |  DE-3862_1(1) id=715790 00035028.tif |
|  DE-3863_1(1) id=715794 00035032.tif |  DE-3864_1(1) id=715795 00035033.tif |  DE-3865_1(1) id=715812 00035050.tif |
|  DE-3866_1(1) id=715817 00035055.tif |  DE-3867_1(1) id=715871 00035144.tif |  DE-3868_1(1) id=715888 00035161.tif |
|  DE-3869_1(1) id=716045 00035369.tif |  DE-3870_1(1) id=716080 00035411.tif |  DE-3871_1(1) id=716082 00035413.tif |
|  DE-3872_1(1) id=716269 00035627.tif |  DE-3873_1(1) id=716375 00035749.tif |  DE-3874_1(1) id=716377 00035751.tif |
|  DE-3875_1(1) id=716378 00035752.tif |  DE-3876_1(1) id=716379 00035753.tif |  DE-3877_1(1) id=716381 00035755.tif |
|  DE-3878_1(1) id=716382 00035756.tif |  DE-3879_1(1) id=716392 00035766.tif |  DE-3880_1(1) id=716394 00035768.tif |





| | | | | | |
|---|---|---|---|---|---|
|  | DE-3881_1(1) id=716419 00035793.tif |  | DE-3882_1(1) id=716422 00035796.tif |  | DE-3883_1(1) id=716423 00035797.tif |
|  | DE-3884_1(1) id=716426 00035800.tif |  | DE-3885_1(1) id=716428 00035802.tif |  | DE-3886_1(1) id=716439 00035813.tif |
|  | DE-3887_1(1) id=716453 00035839.tif |  | DE-3888_1(1) id=716480 00035877.tif |  | DE-3889_1(1) id=716565 00036006.tif |
|  | DE-3890_1(1) id=716567 00036008.tif |  | DE-3891_1(1) id=716568 00036009.tif |  | DE-3892_1(1) id=716569 00036010.tif |
|  | DE-3893_1(1) id=716570 00036011.tif |  | DE-3894_1(1) id=716579 00036021.tif |  | DE-3895_1(1) id=716585 972237.png |
|  | DE-3896_1(1) id=716590 972238.png |  | DE-3897_1(1) id=716612 912332.png |  | DE-3898_1(1) id=716617 912280.png |
|  | DE-3899_1(1) id=716641 00036090.tif |  | DE-3900_1(1) id=716648 932305.png |  | DE-3901_1(1) id=716685 00036158.tif |
|  | DE-3902_1(1) id=716700 00036180.tif |  | DE-3903_1(1) id=716721 00036208.tif |  | DE-3904_1(1) id=716734 00036223.tif |





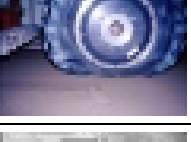

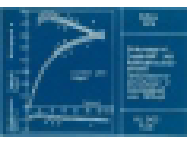





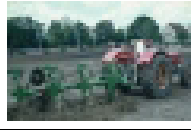





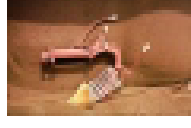

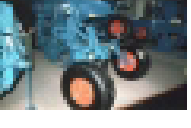
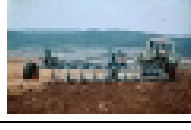



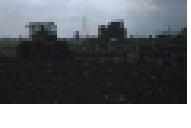

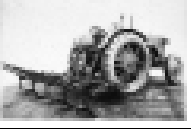

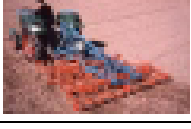

| | | | | | |
|---|---|---|---|---|---|
|  | DE-3905_1(1) id=716745 00036237.tif |  | DE-3906_1(1) id=716757 00036250.tif |  | DE-3907_1(1) id=716801 00036295.tif |
|  | DE-3908_1(1) id=716805 00036299.tif |  | DE-3909_1(1) id=716811 00036305.tif |  | DE-3910_1(1) id=716812 00036306.tif |
|  | DE-3911_1(1) id=716818 00036312.tif |  | DE-3912_1(1) id=716820 00036314.tif |  | DE-3913_1(1) id=716821 00036315.tif |
|  | DE-3914_1(1) id=716824 00036318.tif |  | DE-3915_1(1) id=716825 00036319.tif |  | DE-3916_1(1) id=716850 00036345.tif |
|  | DE-3917_1(1) id=716852 00036347.tif |  | DE-3918_1(1) id=716853 00036348.tif |  | DE-3919_1(1) id=716862 00036357.tif |
|  | DE-3920_1(1) id=716885 00036382.tif |  | DE-3921_1(1) id=716888 00036385.tif |  | DE-3922_1(1) id=716918 00036415.tif |
|  | DE-3923_1(1) id=716922 00036419.tif |  | DE-3924_1(1) id=716928 00036428.tif |  | DE-3925_1(1) id=716967 00036467.tif |
|  | DE-3926_1(1) id=716980 00036481.tif |  | DE-3927_1(1) id=717032 00036534.tif |  | DE-3928_1(1) id=717049 00036552.tif |
|  | DE-3929_1(1) id=717052 00036555.tif |  | DE-3930_1(1) id=717054 00036557.tif |  | DE-3931_1(1) id=717055 00036558.tif |
|  | DE-3932_1(1) id=717056 00036559.tif |  | DE-3933_1(1) id=717057 00036560.tif |  | DE-3934_1(1) id=717059 00036563.tif |
|  | DE-3935_1(1) id=717094 00036598.tif |  | DE-3936_1(1) id=717095 00036599.tif |  | DE-3937_1(1) id=717096 00036600.tif |





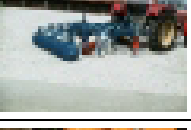















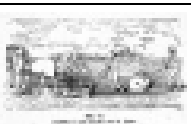









| | | | | | |
|---|---|---|---|---|---|
|  | DE-3938_1(1) id=717098 00036602.tif |  | DE-3939_1(1) id=717099 00036603.tif |  | DE-3940_1(1) id=717111 00036615.tif |
|  | DE-3941_1(1) id=717127 00036632.tif |  | DE-3942_1(1) id=717144 00036651.tif |  | DE-3943_1(1) id=717162 00036669.tif |
|  | DE-3944_1(1) id=717164 00036671.tif |  | DE-3945_1(1) id=717172 00036679.tif |  | DE-3946_1(1) id=717207 00036715.tif |
|  | DE-3947_1(1) id=717212 00036725.tif |  | DE-3948_1(1) id=717216 00036729.tif |  | DE-3949_1(1) id=717221 00036734.tif |
|  | DE-3950_1(1) id=717225 00036738.tif |  | DE-3951_1(1) id=717226 00036739.tif |  | DE-3952_1(1) id=717228 00036741.tif |
|  | DE-3953_1(1) id=717234 00036747.tif |  | DE-3954_1(1) id=717236 00036750.tif |  | DE-3955_1(1) id=717246 00036760.tif |
|  | DE-3956_1(1) id=717248 00036762.tif |  | DE-3957_1(1) id=717275 00036791.tif |  | DE-3958_1(1) id=717276 00036792.tif |
|  | DE-3959_1(1) id=717277 00036793.tif |  | DE-3960_1(1) id=717279 00036795.tif |  | DE-3961_1(1) id=717324 00036840.tif |
|  | DE-3962_1(1) id=717325 00036841.tif |  | DE-3963_1(1) id=717326 00036842.tif |  | DE-3964_1(1) id=717328 00036844.tif |
|  | DE-3965_1(1) id=717329 00036845.tif |  | DE-3966_1(1) id=717340 00036856.tif |  | DE-3967_1(1) id=717356 00036882.tif |





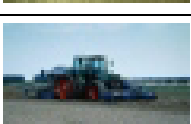











| | | | | | |
|---|---|---|---|---|---|
|  | DE-3968_1(1) id=717429 00036960.tif |  | DE-3969_1(1) id=717450 00036985.tif |  | DE-3970_1(1) id=717471 00037009.tif |
|  | DE-3971_1(1) id=717514 00037053.tif |  | DE-3972_1(1) id=717528 00037068.tif |  | DE-3973_1(1) id=717545 00037086.tif |
|  | DE-3974_1(1) id=717551 00037094.tif |  | DE-3975_1(1) id=717580 00037128.tif |  | DE-3976_1(1) id=717587 00037135.tif |
|  | DE-3977_1(1) id=717589 00037137.tif |  | DE-3978_1(1) id=717608 00037162.tif |  | DE-3979_1(1) id=717613 00037167.tif |
|  | DE-3980_1(1) id=717621 00037176.tif |  | DE-3981_1(1) id=717631 00037186.tif |  | DE-3982_1(1) id=717657 00037213.tif |
|  | DE-3983_1(1) id=717663 00037219.tif |  | DE-3984_1(1) id=717686 00037245.tif |  | DE-3985_1(1) id=717745 00037308.tif |
|  | DE-3986_1(1) id=717805 00037370.tif |  | DE-3987_1(1) id=717807 00037372.tif |  | DE-3988_1(1) id=717811 00037376.tif |
|  | DE-3989_1(1) id=717817 00037384.tif |  | DE-3990_1(1) id=717818 00037385.tif |  | DE-3991_1(1) id=717833 00037402.tif |
|  | DE-3992_1(1) id=717864 00037439.tif |  | DE-3993_1(1) id=717868 00037443.tif |  | DE-3994_1(1) id=717871 00037446.tif |
|  | DE-3995_1(1) id=717879 00037454.tif |  | DE-3996_1(1) id=717897 00037476.tif |  | DE-3997_1(1) id=717899 00037478.tif |
|  | DE-3998_1(1) id=717903 00037485.tif |  | DE-3999_1(1) id=717913 00037495.tif |  | DE-4000_1(1) id=717918 00037500.tif |



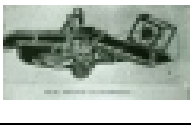
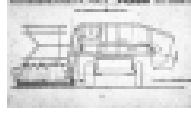





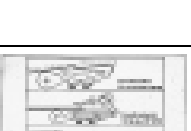

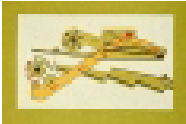

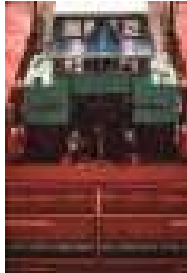

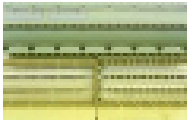



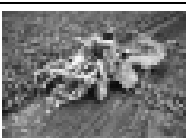

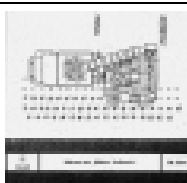
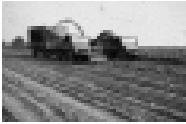







| | | | | | |
|---|---|---|---|---|---|
|  | DE-4001_1(1) id=717932 00037514.tif |  | DE-4002_1(1) id=717934 00037516.tif |  | DE-4003_1(1) id=717935 00037517.tif |
|  | DE-4004_1(1) id=717937 00037519.tif |  | DE-4005_1(1) id=717938 00037520.tif |  | DE-4006_1(1) id=717939 00037521.tif |
|  | DE-4007_1(1) id=717940 00037522.tif |  | DE-4008_1(1) id=717943 00037525.tif |  | DE-4009_1(1) id=717947 00037529.tif |
|  | DE-4010_1(1) id=717948 00037530.tif |  | DE-4011_1(1) id=717964 00037547.tif |  | DE-4012_1(1) id=717967 00037550.tif |
|  | DE-4013_1(1) id=717979 00037562.tif |  | DE-4014_1(1) id=718008 00037594.tif |  | DE-4015_1(1) id=718021 00037607.tif |
|  | DE-4016_1(1) id=718026 00037612.tif |  | DE-4017_1(1) id=718030 00037616.tif |  | DE-4018_1(1) id=718031 00037617.tif |
|  | DE-4019_1(1) id=718037 00037623.tif |  | DE-4020_1(1) id=718043 00037629.tif |  | DE-4021_1(1) id=718050 00037636.tif |
|  | DE-4022_1(1) id=718058 00037644.tif |  | DE-4023_1(1) id=718062 00037648.tif |  | DE-4024_1(1) id=718067 00037653.tif |
|  | DE-4025_1(1) id=718074 00037660.tif |  | DE-4026_1(1) id=718076 00037662.tif |  | DE-4027_1(1) id=718104 00037690.tif |
|  | DE-4028_1(1) id=718106 00037692.tif |  | DE-4029_1(1) id=718130 00037717.tif |  | DE-4030_1(1) id=718173 00037762.tif |
|  | DE-4031_1(1) id=718175 00037764.tif |  | DE-4032_1(1) id=718291 00037890.tif |  | DE-4033_1(1) id=718314 00037913.tif |





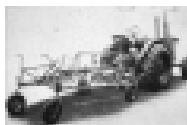

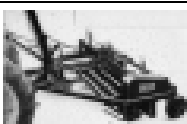
| | | | | | |
|---|---|---|---|---|---|
|  | DE-4034_1(1) id=718315 00037914.tif |  | DE-4035_1(1) id=718358 00037960.tif |  | DE-4036_1(1) id=718453 00038062.tif |
|  | DE-4037_1(1) id=718518 00038133.tif |  | DE-4038_1(1) id=718521 00038136.tif |  | DE-4039_1(1) id=718530 00038146.tif |
|  | DE-4040_1(1) id=718566 00038188.tif |  | DE-4041_1(1) id=718594 00038216.tif |  | DE-4042_1(1) id=718616 00038238.tif |
|  | DE-4043_1(1) id=718633 00038255.tif |  | DE-4044_1(1) id=718636 00038258.tif |  | DE-4045_1(1) id=718663 00038287.tif |
|  | DE-4046_1(1) id=718688 00038313.tif |  | DE-4047_1(1) id=718749 00038377.tif |  | DE-4048_1(1) id=718824 00038460.tif |
|  | DE-4049_1(1) id=719012 00038673.tif |  | DE-4050_1(1) id=719023 00038684.tif |  | DE-4051_1(1) id=719050 00038712.tif |
|  | DE-4052_1(1) id=719076 00038741.tif |  | DE-4053_1(1) id=719085 00038750.tif |  | DE-4054_1(1) id=719086 00038751.tif |
|  | DE-4055_1(1) id=719099 00038767.tif |  | DE-4056_1(1) id=719110 00038782.tif |  | DE-4057_1(1) id=719111 00038783.tif |
|  | DE-4058_1(1) id=719128 00038800.tif |  | DE-4059_1(1) id=719132 00038804.tif |  | DE-4060_1(1) id=719140 00038812.tif |





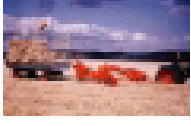





















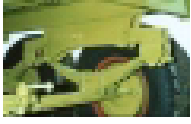

| | | |
|---|---|---|
|  DE-4061_1(1) id=719141 00038813.tif |  DE-4062_1(1) id=719146 00038818.tif |  DE-4063_1(1) id=719147 00038819.tif |
|  DE-4064_1(1) id=719149 00038821.tif |  DE-4065_1(1) id=719152 00038824.tif |  DE-4066_1(1) id=719159 00038831.tif |
|  DE-4067_1(1) id=719161 00038833.tif |  DE-4068_1(1) id=719162 00038834.tif |  DE-4069_1(1) id=719181 00038854.tif |
|  DE-4070_1(1) id=719185 00038858.tif |  DE-4071_1(1) id=719202 00038875.tif |  DE-4072_1(1) id=719231 00038905.tif |
|  DE-4073_1(1) id=719250 00038924.tif |  DE-4074_1(1) id=719259 00038933.tif |  DE-4075_1(1) id=719268 00038942.tif |
|  DE-4076_1(1) id=719271 00038945.tif |  DE-4077_1(1) id=719273 00038947.tif |  DE-4078_1(1) id=719290 00038964.tif |
|  DE-4079_1(1) id=719323 00039005.tif |  DE-4080_1(1) id=719354 00039038.tif |  DE-4081_1(1) id=719395 00039080.tif |
|  DE-4082_1(1) id=719397 00039082.tif |  DE-4083_1(1) id=719422 00039107.tif |  DE-4084_1(1) id=719430 00039115.tif |
|  DE-4085_1(1) id=719432 00039117.tif |  DE-4086_1(1) id=719436 00039121.tif |  DE-4087_1(1) id=719440 00039125.tif |
|  DE-4088_1(1) id=719444 00039129.tif |  DE-4089_1(1) id=719447 00039132.tif |  DE-4090_1(1) id=719452 00039138.tif |
|  DE-4091_1(1) id=719455 00039143.tif |  DE-4092_1(1) id=719482 00039173.tif |  DE-4093_1(1) id=719514 00039206.tif |
|  DE-4094_1(1) id=719543 00039236.tif |  DE-4095_1(1) id=719573 00039271.tif |  DE-4096_1(1) id=719586 00039286.tif |

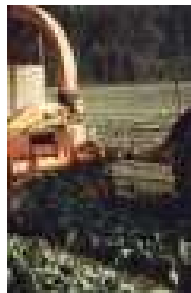
| | | | | | |
|---|---|---|---|---|---|
|  | DE-4097_1(1) id=719595 00039295.tif |  | DE-4098_1(1) id=719597 00039297.tif |  | DE-4099_1(1) id=719610 00039310.tif |
|  | DE-4100_1(1) id=719611 00039311.tif |  | DE-4101_1(1) id=719612 00039312.tif |  | DE-4102_1(1) id=719614 00039314.tif |
|  | DE-4103_1(1) id=719617 00039317.tif |  | DE-4104_1(1) id=719652 00039353.tif |  | DE-4105_1(1) id=719653 00039354.tif |
|  | DE-4106_1(1) id=719656 00039357.tif |  | DE-4107_1(1) id=719661 00039362.tif |  | DE-4108_1(1) id=719715 00039426.tif |
|  | DE-4109_1(1) id=719743 00039455.tif |  | DE-4110_1(1) id=719763 00039475.tif |  | DE-4111_1(1) id=719768 00039480.tif |
|  | DE-4112_1(1) id=719777 00039490.tif |  | DE-4113_1(1) id=719786 00039501.tif |  | DE-4114_1(1) id=719802 00039517.tif |
|  | DE-4115_1(1) id=719807 00039522.tif |  | DE-4116_1(1) id=719809 00039524.tif |  | DE-4117_1(1) id=719835 00039556.tif |
|  | DE-4118_1(1) id=719842 00039564.tif |  | DE-4119_1(1) id=719844 00039566.tif |  | DE-4120_1(1) id=719846 00039568.tif |
|  | DE-4121_1(1) id=719855 00039580.tif |  | DE-4122_1(1) id=719883 00039615.tif |  | DE-4123_1(1) id=719894 00039627.tif |
|  | DE-4124_1(1) id=719898 00039631.tif |  | DE-4125_1(1) id=719904 00039637.tif |  | DE-4126_1(1) id=719930 00039668.tif |
|  | DE-4127_1(1) id=719934 00039672.tif |  | DE-4128_1(1) id=719980 00039720.tif |  | DE-4129_1(1) id=719988 00039728.tif |

























| | | | | | |
|---|---|---|---|---|---|
|  | DE-4130_1(1) id=719998 00039738.tif |  | DE-4131_1(1) id=720000 00039740.tif |  | DE-4132_1(1) id=720001 00039741.tif |
|  | DE-4133_1(1) id=720007 00039747.tif |  | DE-4134_1(1) id=720026 00039767.tif |  | DE-4135_1(1) id=720064 00039808.tif |
|  | DE-4136_1(1) id=720077 00039823.tif |  | DE-4137_1(1) id=720080 00039827.tif |  | DE-4138_1(1) id=720089 00039836.tif |
|  | DE-4139_1(1) id=720092 00039840.tif |  | DE-4140_1(1) id=720096 00039845.tif |  | DE-4141_1(1) id=720135 00039892.tif |
|  | DE-4142_1(1) id=720148 00039909.tif |  | DE-4143_1(1) id=720162 00039930.tif |  | DE-4144_1(1) id=720168 00039937.tif |
|  | DE-4145_1(1) id=720172 00039941.tif |  | DE-4146_1(1) id=720176 00039946.tif |  | DE-4147_1(1) id=720177 00039947.tif |
|  | DE-4148_1(1) id=720227 00039999.tif |  | DE-4149_1(1) id=720232 00040008.tif |  | DE-4150_1(1) id=720239 00040015.tif |
|  | DE-4151_1(1) id=720254 00040037.tif |  | DE-4152_1(1) id=720261 00040044.tif |  | DE-4153_1(1) id=720262 00040045.tif |
|  | DE-4154_1(1) id=720293 00040077.tif |  | DE-4155_1(1) id=720295 00040079.tif |  | DE-4156_1(1) id=720304 00040088.tif |
|  | DE-4157_1(1) id=720306 00040090.tif |  | DE-4158_1(1) id=720310 00040101.tif |  | DE-4159_1(1) id=720326 00040118.tif |
|  | DE-4160_1(1) id=720341 00040134.tif |  | DE-4161_1(1) id=720343 00040138.tif |  | DE-4162_1(1) id=720346 00040141.tif |
|  | DE-4163_1(1) id=720352 00040147.tif |  | DE-4164_1(1) id=720353 00040148.tif |  | DE-4165_1(1) id=720370 00040165.tif |



| | | | | | |
|---|---|---|---|---|---|
|  | DE-4166_1(1) id=720371 00040166.tif |  | DE-4167_1(1) id=720384 00040179.tif |  | DE-4168_1(1) id=720397 00040193.tif |
|  | DE-4169_1(1) id=720398 00040194.tif |  | DE-4170_1(1) id=720421 00040218.tif |  | DE-4171_1(1) id=720433 00040231.tif |
|  | DE-4172_1(1) id=720456 00040254.tif |  | DE-4173_1(1) id=720459 00040257.tif |  | DE-4174_1(1) id=720470 00040268.tif |
|  | DE-4175_1(1) id=720512 00040310.tif |  | DE-4176_1(1) id=720515 00040313.tif |  | DE-4177_1(1) id=720527 00040325.tif |
|  | DE-4178_1(1) id=720529 00040327.tif |  | DE-4179_1(1) id=720548 00040347.tif |  | DE-4180_1(1) id=720551 00040350.tif |
|  | DE-4181_1(1) id=720552 00040351.tif |  | DE-4182_1(1) id=720563 00040363.tif |  | DE-4183_1(1) id=720565 00040365.tif |
|  | DE-4184_1(1) id=720566 00040366.tif |  | DE-4185_1(1) id=720569 00040369.tif |  | DE-4186_1(1) id=720571 00040371.tif |
|  | DE-4187_1(1) id=720574 00040374.tif |  | DE-4188_1(1) id=720575 00040375.tif |  | DE-4189_1(1) id=720590 00040393.tif |
|  | DE-4190_1(1) id=720594 00040397.tif |  | DE-4191_1(1) id=720615 00040418.tif |  | DE-4192_1(1) id=720624 00040427.tif |
|  | DE-4193_1(1) id=720626 00040429.tif |  | DE-4194_1(1) id=720638 00040443.tif |  | DE-4195_1(1) id=720648 00040453.tif |







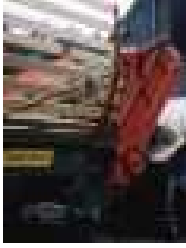



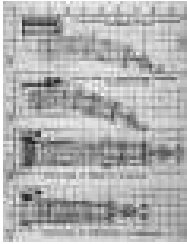









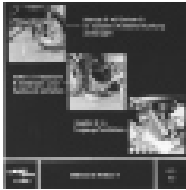





| | | |
|---|---|---|
|  DE-4196_1(1) id=720651 00040456.tif |  DE-4197_1(1) id=720657 00040462.tif |  DE-4198_1(1) id=720659 00040464.tif |
|  DE-4199_1(1) id=720660 00040465.tif |  DE-4200_1(1) id=720664 00040469.tif |  DE-4201_1(1) id=720666 00040471.tif |
|  DE-4202_1(1) id=720668 00040473.tif |  DE-4203_1(1) id=720682 00040488.tif |  DE-4204_1(1) id=720691 00040500.tif |
|  DE-4205_1(1) id=720711 00040520.tif |  DE-4206_1(1) id=720722 00040531.tif |  DE-4207_1(1) id=720752 00040561.tif |
|  DE-4208_1(1) id=720755 00040564.tif |  DE-4209_1(1) id=720756 00040565.tif |  DE-4210_1(1) id=720768 00040578.tif |
|  DE-4211_1(1) id=720771 00040581.tif |  DE-4212_1(1) id=720783 00040604.tif |  DE-4213_1(1) id=720784 00040605.tif |
|  DE-4214_1(1) id=720829 00040656.tif |  DE-4215_1(1) id=720850 00040677.tif |  DE-4216_1(1) id=720866 00040693.tif |
|  DE-4217_1(1) id=720870 00040697.tif |  DE-4218_1(1) id=720875 00040705.tif |  DE-4219_1(1) id=720881 00040711.tif |
|  DE-4220_1(1) id=720888 00040718.tif |  DE-4221_1(1) id=720890 00040721.tif |  DE-4222_1(1) id=720910 00040747.tif |
|  DE-4223_1(1) id=720932 00040771.tif |  DE-4224_1(1) id=720934 00040773.tif |  DE-4225_1(1) id=720936 00040788.tif |
|  DE-4226_1(1) id=720938 00040790.tif |  DE-4227_1(1) id=720951 00040803.tif |  DE-4228_1(1) id=720952 00040804.tif |
|  DE-4229_1(1) id=720955 00040807.tif |  DE-4230_1(1) id=720956 00040808.tif |  DE-4231_1(1) id=720971 00040827.tif |











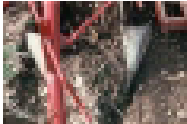



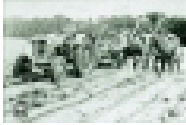

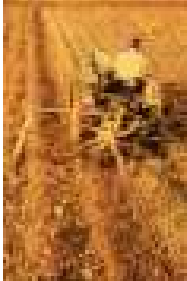









| | | | | | |
|---|---|---|---|---|---|
|  | DE-4232_1(1) id=720982 00040841.tif |  | DE-4233_1(1) id=720992 00040851.tif |  | DE-4234_1(1) id=720996 00040855.tif |
|  | DE-4235_1(1) id=720997 00040856.tif |  | DE-4236_1(1) id=720999 00040858.tif |  | DE-4237_1(1) id=721001 00040860.tif |
|  | DE-4238_1(1) id=721012 00040871.tif |  | DE-4239_1(1) id=721021 00040880.tif |  | DE-4240_1(1) id=721037 00040896.tif |
|  | DE-4241_1(1) id=721046 00040906.tif |  | DE-4242_1(1) id=721047 00040907.tif |  | DE-4243_1(1) id=721049 00040909.tif |
|  | DE-4244_1(1) id=721062 00040924.tif |  | DE-4245_1(1) id=721072 00040935.tif |  | DE-4246_1(1) id=721074 00040940.tif |
|  | DE-4247_1(1) id=721104 00040983.tif |  | DE-4248_1(1) id=721105 00040985.tif |  | DE-4249_1(1) id=721111 00040991.tif |
|  | DE-4250_1(1) id=721135 00041016.tif |  | DE-4251_1(1) id=721141 00041022.tif |  | DE-4252_1(1) id=721143 00041024.tif |
|  | DE-4253_1(1) id=721149 00041030.tif |  | DE-4254_1(1) id=721155 00041036.tif |  | DE-4255_1(1) id=721156 00041037.tif |
|  | DE-4256_1(1) id=721161 00041042.tif |  | DE-4257_1(1) id=721162 00041043.tif |  | DE-4258_1(1) id=721164 00041045.tif |
|  | DE-4259_1(1) id=721165 00041046.tif |  | DE-4260_1(1) id=721167 00041048.tif |  | DE-4261_1(1) id=721172 00041053.tif |











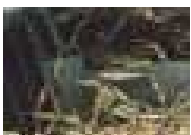









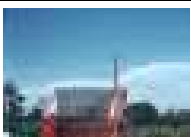

| | | | | | |
|---|---|---|---|---|---|
|  | DE-4262_1(1) id=721179 00041060.tif |  | DE-4263_1(1) id=721185 00041066.tif |  | DE-4264_1(1) id=721186 00041067.tif |
|  | DE-4265_1(1) id=721189 00041070.tif |  | DE-4266_1(1) id=721192 00041073.tif |  | DE-4267_1(1) id=721194 00041075.tif |
|  | DE-4268_1(1) id=721195 00041076.tif |  | DE-4269_1(1) id=721196 00041078.tif |  | DE-4270_1(1) id=721197 00041079.tif |
|  | DE-4271_1(1) id=721201 00041083.tif |  | DE-4272_1(1) id=721203 00041085.tif |  | DE-4273_1(1) id=721206 00041088.tif |
|  | DE-4274_1(1) id=721207 00041089.tif |  | DE-4275_1(1) id=721210 00041092.tif |  | DE-4276_1(1) id=721214 00041096.tif |
|  | DE-4277_1(1) id=721215 00041097.tif |  | DE-4278_1(1) id=721219 00041105.tif |  | DE-4279_1(1) id=721220 00041106.tif |
|  | DE-4280_1(1) id=721221 00041107.tif |  | DE-4281_1(1) id=721222 00041108.tif |  | DE-4282_1(1) id=721223 00041110.tif |
|  | DE-4283_1(1) id=721226 00041113.tif |  | DE-4284_1(1) id=721228 00041115.tif |  | DE-4285_1(1) id=721229 00041116.tif |
|  | DE-4286_1(1) id=721233 00041120.tif |  | DE-4287_1(1) id=721235 00041122.tif |  | DE-4288_1(1) id=721236 00041123.tif |

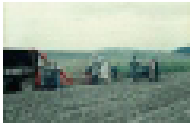









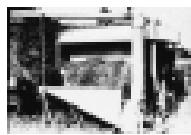











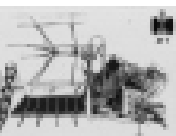



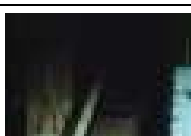

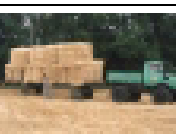
| | | | | | |
|---|---|---|---|---|---|
|  | DE-4289_1(1) id=721238 00041125.tif |  | DE-4290_1(1) id=721239 00041128.tif |  | DE-4291_1(1) id=721242 00041134.tif |
|  | DE-4292_1(1) id=721243 00041135.tif |  | DE-4293_1(1) id=721244 00041136.tif |  | DE-4294_1(1) id=721247 00041140.tif |
|  | DE-4295_1(1) id=721248 00041141.tif |  | DE-4296_1(1) id=721250 00041143.tif |  | DE-4297_1(1) id=721253 00041147.tif |
|  | DE-4298_1(1) id=721257 00041151.tif |  | DE-4299_1(1) id=721263 00041160.tif |  | DE-4300_1(1) id=721284 00041183.tif |
|  | DE-4301_1(1) id=721290 00041189.tif |  | DE-4302_1(1) id=721310 00041211.tif |  | DE-4303_1(1) id=721324 00041228.tif |
|  | DE-4304_1(1) id=721331 00041237.tif |  | DE-4305_1(1) id=721338 00041245.tif |  | DE-4306_1(1) id=721339 00041246.tif |
|  | DE-4307_1(1) id=721344 00041251.tif |  | DE-4308_1(1) id=721347 00041254.tif |  | DE-4309_1(1) id=721348 00041255.tif |
|  | DE-4310_1(1) id=721356 00041263.tif |  | DE-4311_1(1) id=721374 00041283.tif |  | DE-4312_1(1) id=721377 00041286.tif |

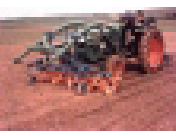
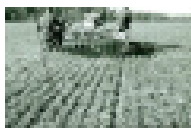
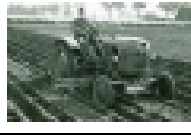



























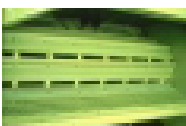
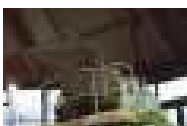



| | | | | | |
|---|---|---|---|---|---|
|  | DE-4313_1(1) id=721449 00041386.tif |  | DE-4314_1(1) id=721456 00041397.tif |  | DE-4315_1(1) id=721464 00041408.tif |
|  | DE-4316_1(1) id=721536 00041485.tif |  | DE-4317_1(1) id=721537 00041486.tif |  | DE-4318_1(1) id=721540 00041489.tif |
|  | DE-4319_1(1) id=721549 00041498.tif |  | DE-4320_1(1) id=721558 00041646.tif |  | DE-4321_1(1) id=721560 00041648.tif |
|  | DE-4322_1(1) id=721608 00041699.tif |  | DE-4323_1(1) id=721621 00041712.tif |  | DE-4324_1(1) id=721625 00041716.tif |
|  | DE-4325_1(1) id=721626 00041717.tif |  | DE-4326_1(1) id=721633 00041724.tif |  | DE-4327_1(1) id=721634 00041725.tif |
|  | DE-4328_1(1) id=721637 00041729.tif |  | DE-4329_1(1) id=721640 00041732.tif |  | DE-4330_1(1) id=721642 00041734.tif |
|  | DE-4331_1(1) id=721649 00041743.tif |  | DE-4332_1(1) id=721654 00041748.tif |  | DE-4333_1(1) id=721662 00041756.tif |
|  | DE-4334_1(1) id=721676 00041771.tif |  | DE-4335_1(1) id=721686 00041782.tif |  | DE-4336_1(1) id=721688 00041784.tif |

| | | | | | |
|---|---|---|---|---|---|
|  | DE-4337_1(1) id=721689 00041785.tif |  | DE-4338_1(1) id=721694 00041791.tif |  | DE-4339_1(1) id=721722 00041831.tif |
|  | DE-4340_1(1) id=721729 00041838.tif |  | DE-4341_1(1) id=721731 00041840.tif |  | DE-4342_1(1) id=721734 00041843.tif |
|  | DE-4343_1(1) id=721741 00041855.tif |  | DE-4344_1(1) id=721744 00041858.tif |  | DE-4345_1(1) id=721745 00041859.tif |
|  | DE-4346_1(1) id=721747 00041861.tif |  | DE-4347_1(1) id=721780 00041904.tif |  | DE-4348_1(1) id=721805 00041929.tif |
|  | DE-4349_1(1) id=721824 00041959.tif |  | DE-4350_1(1) id=721851 00041986.tif |  | DE-4351_1(1) id=721871 00042010.tif |
|  | DE-4352_1(1) id=721886 00042028.tif |  | DE-4353_1(1) id=721896 00042038.tif |  | DE-4354_1(1) id=721946 00042091.tif |
|  | DE-4355_1(1) id=721952 00042097.tif |  | DE-4356_1(1) id=722003 00042152.tif |  | DE-4357_1(1) id=722009 00042158.tif |
|  | DE-4358_1(1) id=722010 00042159.tif |  | DE-4359_1(1) id=722020 00042169.tif |  | DE-4360_1(1) id=722025 00042174.tif |
|  | DE-4361_1(1) id=722030 00042179.tif |  | DE-4362_1(1) id=722046 00042195.tif |  | DE-4363_1(1) id=722086 00042242.tif |



























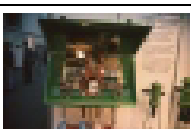

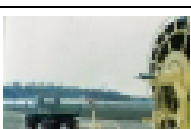

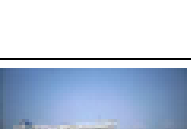

| | | | | | |
|---|---|---|---|---|---|
|  | DE-4364_1(1) id=722096 00042254.tif |  | DE-4365_1(1) id=722097 00042255.tif |  | DE-4366_1(1) id=722098 00042256.tif |
|  | DE-4367_1(1) id=722107 00042265.tif |  | DE-4368_1(1) id=722120 00042278.tif |  | DE-4369_1(1) id=722121 00042279.tif |
|  | DE-4370_1(1) id=722122 00042280.tif |  | DE-4371_1(1) id=722123 00042281.tif |  | DE-4372_1(1) id=722124 00042282.tif |
|  | DE-4373_1(1) id=722133 00042293.tif |  | DE-4374_1(1) id=722181 00042344.tif |  | DE-4375_1(1) id=722229 00042394.tif |
|  | DE-4376_1(1) id=722230 00042395.tif |  | DE-4377_1(1) id=722243 00042408.tif |  | DE-4378_1(1) id=722249 00042414.tif |
|  | DE-4379_1(1) id=722251 00042416.tif |  | DE-4380_1(1) id=722252 00042417.tif |  | DE-4381_1(1) id=722300 00042465.tif |
|  | DE-4382_1(1) id=722303 00042468.tif |  | DE-4383_1(1) id=722306 00042471.tif |  | DE-4384_1(1) id=722338 00042504.tif |
|  | DE-4385_1(1) id=722344 00042510.tif |  | DE-4386_1(1) id=722387 00042560.tif |  | DE-4387_1(1) id=722391 00042564.tif |
|  | DE-4388_1(1) id=722392 00042566.tif |  | DE-4389_1(1) id=722393 00042567.tif |  | DE-4390_1(1) id=722394 00042568.tif |





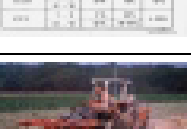

















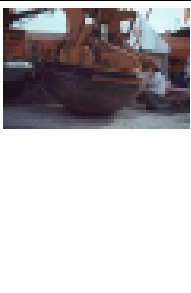
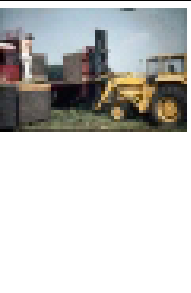

| | | | | | |
|---|---|---|---|---|---|
|  | DE-4391_1(1) id=722395 00042569.tif |  | DE-4392_1(1) id=722396 00042570.tif |  | DE-4393_1(1) id=722414 00042588.tif |
|  | DE-4394_1(1) id=722415 00042589.tif |  | DE-4395_1(1) id=722418 00042592.tif |  | DE-4396_1(1) id=722427 00042601.tif |
|  | DE-4397_1(1) id=722429 00042603.tif |  | DE-4398_1(1) id=722436 00042610.tif |  | DE-4399_1(1) id=722438 00042612.tif |
|  | DE-4400_1(1) id=722440 00042614.tif |  | DE-4401_1(1) id=722441 00042615.tif |  | DE-4402_1(1) id=722442 00042616.tif |
|  | DE-4403_1(1) id=722445 00042619.tif |  | DE-4404_1(1) id=722447 00042621.tif |  | DE-4405_1(1) id=722453 00042627.tif |
|  | DE-4406_1(1) id=722455 00042629.tif |  | DE-4407_1(1) id=722457 00042631.tif |  | DE-4408_1(1) id=722461 00042635.tif |
|  | DE-4409_1(1) id=722464 00042638.tif |  | DE-4410_1(1) id=722465 00042639.tif |  | DE-4411_1(1) id=722466 00042640.tif |
|  | DE-4412_1(1) id=722468 00042642.tif |  | DE-4413_1(1) id=722479 00042654.tif |  | DE-4414_1(1) id=722485 00042665.tif |

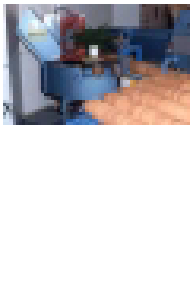





















| | | | | | |
|---|---|---|---|---|---|
|  | DE-4415_1(1) id=722486 00042666.tif |  | DE-4416_1(1) id=722491 00042673.tif |  | DE-4417_1(1) id=722493 00042677.tif |
|  | DE-4418_1(1) id=722495 00042679.tif |  | DE-4419_1(1) id=722496 00042680.tif |  | DE-4420_1(1) id=722504 00042688.tif |
|  | DE-4421_1(1) id=722511 00042695.tif |  | DE-4422_1(1) id=722512 00042696.tif |  | DE-4423_1(1) id=722530 00042714.tif |
|  | DE-4424_1(1) id=722531 00042715.tif |  | DE-4425_1(1) id=722540 00042726.tif |  | DE-4426_1(1) id=722544 00042730.tif |
|  | DE-4427_1(1) id=722550 00042736.tif |  | DE-4428_1(1) id=722580 00042789.tif |  | DE-4429_1(1) id=722596 00042810.tif |
|  | DE-4430_1(1) id=722619 00042834.tif |  | DE-4431_1(1) id=722622 00042838.tif |  | DE-4432_1(1) id=722628 00042845.tif |
|  | DE-4433_1(1) id=722632 00042849.tif |  | DE-4434_1(1) id=722645 00042863.tif |  | DE-4435_1(1) id=722649 00042867.tif |
|  | DE-4436_1(1) id=722696 00042915.tif |  | DE-4437_1(1) id=722814 00043043.tif |  | DE-4438_1(1) id=722820 00043049.tif |
|  | DE-4439_1(1) id=722821 00043050.tif |  | DE-4440_1(1) id=722828 00043057.tif |  | DE-4441_1(1) id=722830 00043059.tif |
|  | DE-4442_1(1) id=722831 00043060.tif |  | DE-4443_1(1) id=722838 00043068.tif |  | DE-4444_1(1) id=722851 00043082.tif |
|  | DE-4445_1(1) id=722874 00043113.tif |  | DE-4446_1(1) id=722898 00043141.tif |  | DE-4447_1(1) id=722922 00043170.tif |











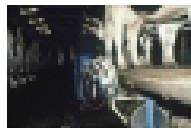



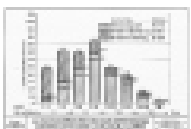



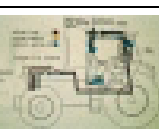





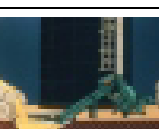
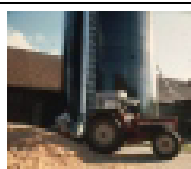



| | | | | | |
|---|---|---|---|---|---|
|  | DE-4448_1(1) id=722944 00043197.tif |  | DE-4449_1(1) id=722952 00043207.tif |  | DE-4450_1(1) id=722975 00043231.tif |
|  | DE-4451_1(1) id=722976 00043232.tif |  | DE-4452_1(1) id=722978 00043234.tif |  | DE-4453_1(1) id=722985 00043241.tif |
|  | DE-4454_1(1) id=723000 00043256.tif |  | DE-4455_1(1) id=723001 00043257.tif |  | DE-4456_1(1) id=723022 00043281.tif |
|  | DE-4457_1(1) id=723028 00043287.tif |  | DE-4458_1(1) id=723116 00043392.tif |  | DE-4459_1(1) id=723118 00043394.tif |
|  | DE-4460_1(1) id=723166 00043444.tif |  | DE-4461_1(1) id=723167 00043445.tif |  | DE-4462_1(1) id=723176 00043454.tif |
|  | DE-4463_1(1) id=723193 00043471.tif |  | DE-4464_1(1) id=723196 00043474.tif |  | DE-4465_1(1) id=723274 00043554.tif |
|  | DE-4466_1(1) id=723419 00043729.tif |  | DE-4467_1(1) id=723448 00043758.tif |  | DE-4468_1(1) id=723480 00043799.tif |
|  | DE-4469_1(1) id=723482 00043801.tif |  | DE-4470_1(1) id=723541 00043860.tif |  | DE-4471_1(1) id=723556 00043875.tif |
|  | DE-4472_1(1) id=723576 00043896.tif |  | DE-4473_1(1) id=723586 00043906.tif |  | DE-4474_1(1) id=723587 00043907.tif |
|  | DE-4475_1(1) id=723599 00043919.tif |  | DE-4476_1(1) id=723706 00044029.tif |  | DE-4477_1(1) id=723708 00044031.tif |
|  | DE-4478_1(1) id=723721 00044044.tif |  | DE-4479_1(1) id=723725 00044048.tif |  | DE-4480_1(1) id=723730 00044053.tif |

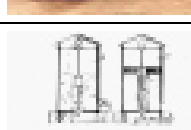











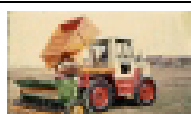













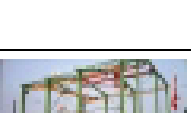

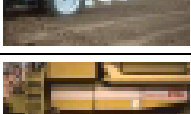
| | | | | | |
|---|---|---|---|---|---|
|  | DE-4481_1(1) id=723759 00044082.tif |  | DE-4482_1(1) id=723764 00044090.tif |  | DE-4483_1(1) id=723790 00044117.tif |
|  | DE-4484_1(1) id=723814 00044142.tif |  | DE-4485_1(1) id=723818 982090.png |  | DE-4486_1(1) id=723820 00044155.tif |
|  | DE-4487_1(1) id=723842 00044179.tif |  | DE-4488_1(1) id=723864 00044201.tif |  | DE-4489_1(1) id=723881 00044218.tif |
|  | DE-4490_1(1) id=723887 00044224.tif |  | DE-4491_1(1) id=723889 00044226.tif |  | DE-4492_1(1) id=723910 00044247.tif |
|  | DE-4493_1(1) id=723912 00044249.tif |  | DE-4494_1(1) id=723935 00044272.tif |  | DE-4495_1(1) id=723938 00044275.tif |
|  | DE-4496_1(1) id=723955 00044292.tif |  | DE-4497_1(1) id=723959 00044296.tif |  | DE-4498_1(1) id=723974 00044311.tif |
|  | DE-4499_1(1) id=723975 00044312.tif |  | DE-4500_1(1) id=723988 00044325.tif |  | DE-4501_1(1) id=723992 00044329.tif |
|  | DE-4502_1(1) id=723993 962288.png |  | DE-4503_1(1) id=724070 00044407.tif |  | DE-4504_1(1) id=724087 00044424.tif |
|  | DE-4505_1(1) id=724163 00044506.tif |  | DE-4506_1(1) id=724171 00044515.tif |  | DE-4507_1(1) id=724246 972445.png |
|  | DE-4508_1(1) id=724251 00044610.tif |  | DE-4509_1(1) id=724265 00044624.tif |  | DE-4510_1(1) id=724271 00044632.tif |



| | | | | | |
|---|---|---|---|---|---|
|  | DE-4511_1(1) id=724276 00044637.tif |  | DE-4512_1(1) id=724322 00044687.tif |  | DE-4513_1(1) id=724335 00044700.tif |
|  | DE-4514_1(1) id=724337 00044702.tif |  | DE-4515_1(1) id=724372 00044757.tif |  | DE-4516_1(1) id=724388 00044773.tif |
|  | DE-4517_1(1) id=724400 00044785.tif |  | DE-4518_1(1) id=724402 00044787.tif |  | DE-4519_1(1) id=724432 00044817.tif |
|  | DE-4520_1(1) id=724436 00044821.tif |  | DE-4521_1(1) id=724607 00044994.tif |  | DE-4522_1(1) id=724625 00045012.tif |
|  | DE-4523_1(1) id=724691 00045079.tif |  | DE-4524_1(1) id=724760 00045149.tif |  | DE-4525_1(1) id=724774 00045163.tif |
|  | DE-4526_1(1) id=724815 00045205.tif |  | DE-4527_1(1) id=724824 00045214.tif |  | DE-4528_1(1) id=724825 00045215.tif |
|  | DE-4529_1(1) id=724848 00045240.tif |  | DE-4530_1(1) id=724891 00045285.tif |  | DE-4531_1(1) id=725055 00045456.tif |
|  | DE-4532_1(1) id=725111 00045512.tif |  | DE-4533_1(1) id=725199 00045613.tif |  | DE-4534_1(1) id=725290 00045704.tif |
|  | DE-4535_1(1) id=725292 00045706.tif |  | DE-4536_1(1) id=725299 00045713.tif |  | DE-4537_1(1) id=725331 00045745.tif |
|  | DE-4538_1(1) id=725351 00045765.tif |  | DE-4539_1(1) id=725357 00045771.tif |  | DE-4540_1(1) id=725361 00045775.tif |
|  | DE-4541_1(1) id=725392 00045806.tif |  | DE-4542_1(1) id=725430 00045846.tif |  | DE-4543_1(1) id=725448 00045865.tif |











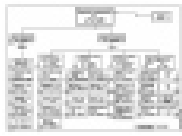



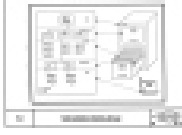
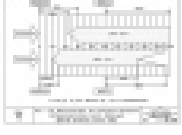







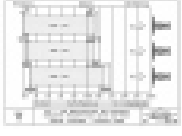

| | | | | | |
|---|---|---|---|---|---|
|  | DE-4544_1(1) id=725542 00045966.tif |  | DE-4545_1(1) id=725549 00045973.tif |  | DE-4546_1(1) id=725678 00046111.tif |
|  | DE-4547_1(1) id=725679 00046112.tif |  | DE-4548_1(1) id=725700 00046133.tif |  | DE-4549_1(1) id=725708 00046141.tif |
|  | DE-4550_1(1) id=725843 00046286.tif |  | DE-4551_1(1) id=725850 00046295.tif |  | DE-4552_1(1) id=725954 00046442.tif |
|  | DE-4553_1(1) id=725987 00046475.tif |  | DE-4554_1(1) id=726006 00046494.tif |  | DE-4555_1(1) id=726133 00046621.tif |
|  | DE-4556_1(1) id=726136 00046624.tif |  | DE-4557_1(1) id=726159 00046647.tif |  | DE-4558_1(1) id=726197 00046685.tif |
|  | DE-4559_1(1) id=726199 00046687.tif |  | DE-4560_1(1) id=726202 00046690.tif |  | DE-4561_1(1) id=726203 00046691.tif |
|  | DE-4562_1(1) id=726222 00046710.tif |  | DE-4563_1(1) id=726546 00047055.tif |  | DE-4564_1(1) id=726911 00047436.tif |
|  | DE-4565_1(1) id=726936 00047461.tif |  | DE-4566_1(1) id=727282 00047813.tif |  | DE-4567_1(1) id=727362 00047895.tif |
|  | DE-4568_1(1) id=727510 00048043.tif |  | DE-4569_1(1) id=727517 00048050.tif |  | DE-4570_1(1) id=727576 00048119.tif |

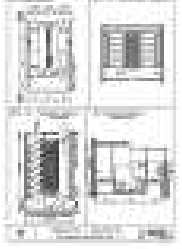











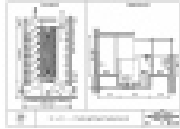







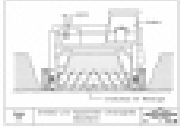





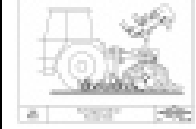

| | | | | | |
|---|---|---|---|---|---|
|  | DE-4571_1(1) id=727584 00048131.tif |  | DE-4572_1(1) id=727606 00048153.tif |  | DE-4573_1(1) id=727612 00048159.tif |
|  | DE-4574_1(1) id=727663 00048210.tif |  | DE-4575_1(1) id=727673 00048220.tif |  | DE-4576_1(1) id=727674 00048221.tif |
|  | DE-4577_1(1) id=727699 00048246.tif |  | DE-4578_1(1) id=727705 00048252.tif |  | DE-4579_1(1) id=727728 00048275.tif |
|  | DE-4580_1(1) id=727891 00048439.tif |  | DE-4581_1(1) id=727897 00048445.tif |  | DE-4582_1(1) id=727898 00048446.tif |
|  | DE-4583_1(1) id=727899 00048447.tif |  | DE-4584_1(1) id=727950 00048498.tif |  | DE-4585_1(1) id=727979 00048528.tif |
|  | DE-4586_1(1) id=727985 00048534.tif |  | DE-4587_1(1) id=728051 00048605.tif |  | DE-4588_1(1) id=728171 00048725.tif |
|  | DE-4589_1(1) id=728228 00048782.tif |  | DE-4590_1(1) id=728239 00048793.tif |  | DE-4591_1(1) id=728448 00049017.tif |
|  | DE-4592_1(1) id=728489 00049061.tif |  | DE-4593_1(1) id=728512 00049084.tif |  | DE-4594_1(1) id=728604 00049181.tif |



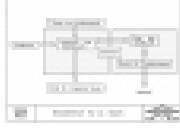















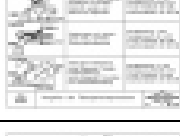

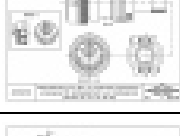





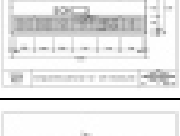

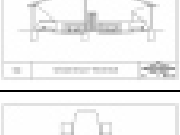



| | | | | | |
|---|---|---|---|---|---|
|  | DE-4595_1(1) id=728627 00049206.tif |  | DE-4596_1(1) id=728671 00049253.tif |  | DE-4597_1(1) id=728732 00049318.tif |
|  | DE-4598_1(1) id=728733 00049320.tif |  | DE-4599_1(1) id=728855 00049453.tif |  | DE-4600_1(1) id=728929 00049538.tif |
|  | DE-4601_1(1) id=729004 00049625.tif |  | DE-4602_1(1) id=729029 00049663.tif |  | DE-4603_1(1) id=729040 00049675.tif |
|  | DE-4604_1(1) id=729103 00049741.tif |  | DE-4605_1(1) id=729132 00049771.tif |  | DE-4606_1(1) id=729158 00049797.tif |
|  | DE-4607_1(1) id=729162 00049801.tif |  | DE-4608_1(1) id=729170 00049809.tif |  | DE-4609_1(1) id=729179 00049818.tif |
|  | DE-4610_1(1) id=729183 00049822.tif |  | DE-4611_1(1) id=729212 00049853.tif |  | DE-4612_1(1) id=729218 00049860.tif |
|  | DE-4613_1(1) id=729222 00049865.tif |  | DE-4614_1(1) id=729225 00049868.tif |  | DE-4615_1(1) id=729229 00049872.tif |
|  | DE-4616_1(1) id=729284 00049937.tif |  | DE-4617_1(1) id=729286 00049939.tif |  | DE-4618_1(1) id=729397 00050078.tif |
|  | DE-4619_1(1) id=729509 00050248.tif |  | DE-4620_1(1) id=729587 00050307.tif |  | DE-4621_1(1) id=729623 00050325.tif |
|  | DE-4622_1(1) id=729712 00050415.tif |  | DE-4623_1(1) id=729734 00050439.tif |  | DE-4624_1(1) id=729739 00050444.tif |











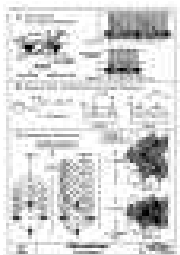



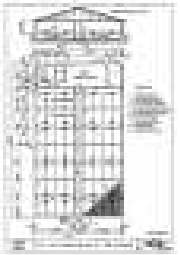

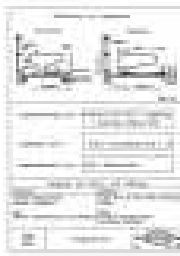
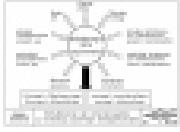

| | | | | | |
|---|---|---|---|---|---|
|  | DE-4625_1(1) id=729743 00050448.tif |  | DE-4626_1(1) id=729757 00050461.tif |  | DE-4627_1(1) id=729801 00050510.tif |
|  | DE-4628_1(1) id=729807 00050516.tif |  | DE-4629_1(1) id=729810 00050520.tif |  | DE-4630_1(1) id=729825 00050535.tif |
|  | DE-4631_1(1) id=729854 00050563.tif |  | DE-4632_1(1) id=729868 00050577.tif |  | DE-4633_1(1) id=729870 00050579.tif |
|  | DE-4634_1(1) id=729879 00050588.tif |  | DE-4635_1(1) id=729893 00050602.tif |  | DE-4636_1(1) id=729900 00050610.tif |
|  | DE-4637_1(1) id=729950 00050664.tif |  | DE-4638_1(1) id=729983 00050697.tif |  | DE-4639_1(1) id=729989 00050704.tif |
|  | DE-4640_1(1) id=729995 00050711.tif |  | DE-4641_1(1) id=730016 00050730.tif |  | DE-4642_1(1) id=730018 00050733.tif |
|  | DE-4643_1(1) id=730066 00050782.tif |  | DE-4644_1(1) id=730083 00050801.tif |  | DE-4645_1(1) id=730088 00050809.tif |
|  | DE-4646_1(1) id=730104 00050825.tif |  | DE-4647_1(1) id=730105 00050826.tif |  | DE-4648_1(1) id=730120 00050845.tif |
|  | DE-4649_1(1) id=730164 00050887.tif |  | DE-4650_1(1) id=730167 00050890.tif |  | DE-4651_1(1) id=730226 00050950.tif |
|  | DE-4652_1(1) id=730248 00050972.tif |  | DE-4653_1(1) id=730269 972062.png |  | DE-4654_1(1) id=730294 00051029.tif |









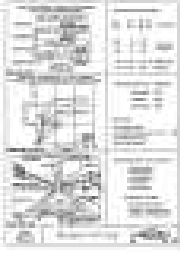





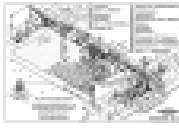



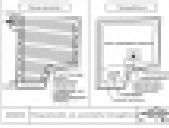

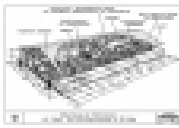

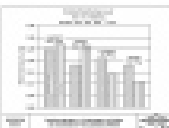

| | | | | | |
|---|---|---|---|---|---|
|  | DE-4655_1(1) id=730305 942005.png |  | DE-4656_1(1) id=730325 00051075.tif |  | DE-4657_1(1) id=730330 00051087.tif |
|  | DE-4658_1(1) id=730337 00051095.tif |  | DE-4659_1(1) id=730396 942387.png |  | DE-4660_1(1) id=730405 00051188.tif |
|  | DE-4661_1(1) id=730417 962022.png |  | DE-4662_1(1) id=730445 00051255.tif |  | DE-4663_1(1) id=730446 00051256.tif |
|  | DE-4664_1(1) id=730448 00051258.tif |  | DE-4665_1(1) id=730455 00051266.tif |  | DE-4666_1(1) id=730458 00051269.tif |
|  | DE-4667_1(1) id=730505 00051315.tif |  | DE-4668_1(1) id=730510 00051320.tif |  | DE-4669_1(1) id=730521 00051329.tif |
|  | DE-4670_1(1) id=730527 00051335.tif |  | DE-4671_1(1) id=730529 00051337.tif |  | DE-4672_1(1) id=730530 00051338.tif |
|  | DE-4673_1(1) id=730536 00051345.tif |  | DE-4674_1(1) id=730541 00051353.tif |  | DE-4675_1(1) id=730610 00051455.tif |
|  | DE-4676_1(1) id=730612 00051457.tif |  | DE-4677_1(1) id=730617 00051462.tif |  | DE-4678_1(1) id=730641 00051490.tif |
|  | DE-4679_1(1) id=730651 00051501.tif |  | DE-4680_1(1) id=730774 00051628.tif |  | DE-4681_1(1) id=730775 00051629.tif |







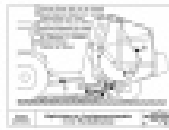





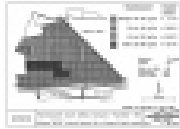
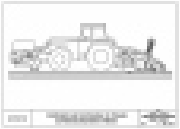



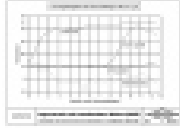



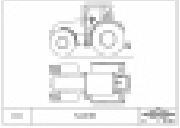
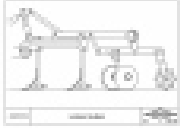

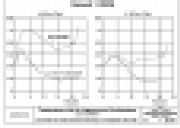
| | | | | | |
|---|---|---|---|---|---|
|  | DE-4682_1(1) id=730784 912046.png |  | DE-4683_1(1) id=730834 912192.png |  | DE-4684_1(1) id=730857 912348.png |
|  | DE-4685_1(1) id=730902 912441.png |  | DE-4686_1(1) id=730926 912480.png |  | DE-4687_1(1) id=730931 912489.png |
|  | DE-4688_1(1) id=730935 912498.png |  | DE-4689_1(1) id=730978 922089.png |  | DE-4690_1(1) id=730985 922099.png |
|  | DE-4691_1(1) id=730988 922104.png |  | DE-4692_1(1) id=730992 922109.png |  | DE-4693_1(1) id=731009 922161.png |
|  | DE-4694_1(1) id=731027 922200.png |  | DE-4695_1(1) id=731086 922334.png |  | DE-4696_1(1) id=731091 922343.png |
|  | DE-4697_1(1) id=731112 922385.png |  | DE-4698_1(1) id=731209 932121.png |  | DE-4699_1(1) id=731213 932126.png |
|  | DE-4700_1(1) id=731214 932130.png |  | DE-4701_1(1) id=731254 932195.png |  | DE-4702_1(1) id=731256 932197.png |
|  | DE-4703_1(1) id=731257 932198.png |  | DE-4704_1(1) id=731282 932249.png |  | DE-4705_1(1) id=731290 932265.png |
|  | DE-4706_1(1) id=731295 932271.png |  | DE-4707_1(1) id=731301 932282.png |  | DE-4708_1(1) id=731313 932301.png |





















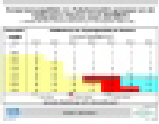



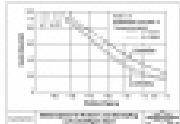

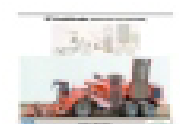
| | | | | | |
|---|---|---|---|---|---|
|  | DE-4709_1(1) id=731336 932351.png |  | DE-4710_1(1) id=731370 932415.png |  | DE-4711_1(1) id=731431 942099.png |
|  | DE-4712_1(1) id=731435 942104.png |  | DE-4713_1(1) id=731451 942127.png |  | DE-4714_1(1) id=731457 942142.png |
|  | DE-4715_1(1) id=731461 942149.png |  | DE-4716_1(1) id=731475 942176.png |  | DE-4717_1(1) id=731482 942194.png |
|  | DE-4718_1(1) id=731513 942253.png |  | DE-4719_1(1) id=731527 942278.png |  | DE-4720_1(1) id=731530 942286.png |
|  | DE-4721_1(1) id=731532 942291.png |  | DE-4722_1(1) id=731538 942297.png |  | DE-4723_1(1) id=731554 942337.png |
|  | DE-4724_1(1) id=731574 942366.png |  | DE-4725_1(1) id=731586 942380.png |  | DE-4726_1(1) id=731591 942388.png |
|  | DE-4727_1(1) id=731623 952002.png |  | DE-4728_1(1) id=731637 952036.png |  | DE-4729_1(1) id=731655 952067.png |
|  | DE-4730_1(1) id=731666 952120.png |  | DE-4731_1(1) id=731695 952172.png |  | DE-4732_1(1) id=731770 952274.png |
|  | DE-4733_1(1) id=731776 952282.png |  | DE-4734_1(1) id=731818 952329.png |  | DE-4735_1(1) id=731824 952336.png |
|  | DE-4736_1(1) id=731842 952356.png |  | DE-4737_1(1) id=731851 952369.png |  | DE-4738_1(1) id=731853 952371.png |







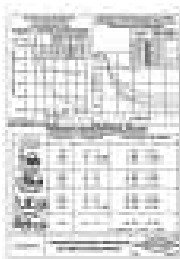





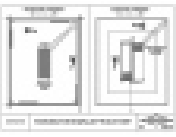



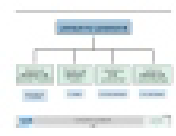
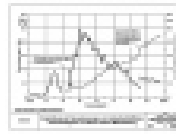



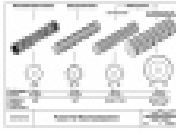

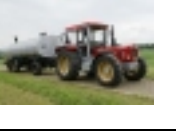

| | | | | | |
|---|---|---|---|---|---|
|  | DE-4739_1(1) id=731875 952398.png |  | DE-4740_1(1) id=731887 952410.png |  | DE-4741_1(1) id=731912 952449.png |
|  | DE-4742_1(1) id=731919 952461.png |  | DE-4743_1(1) id=731930 962002.png |  | DE-4744_1(1) id=731931 962003.png |
|  | DE-4745_1(1) id=731941 962013.png |  | DE-4746_1(1) id=731943 962015.png |  | DE-4747_1(1) id=731949 962025.png |
|  | DE-4748_1(1) id=731954 962030.png |  | DE-4749_1(1) id=731962 962039.png |  | DE-4750_1(1) id=731987 962073.png |
|  | DE-4751_1(1) id=732001 962091.png |  | DE-4752_1(1) id=732004 962095.png |  | DE-4753_1(1) id=732015 962108.png |
|  | DE-4754_1(1) id=732016 962110.png |  | DE-4755_1(1) id=732019 962113.png |  | DE-4756_1(1) id=732041 962136.png |
|  | DE-4757_1(1) id=732045 962140.png |  | DE-4758_1(1) id=732063 962161.png |  | DE-4759_1(1) id=732077 962179.png |
|  | DE-4760_1(1) id=732090 962202.png |  | DE-4761_1(1) id=732098 962212.png |  | DE-4762_1(1) id=732120 962242.png |
|  | DE-4763_1(1) id=732124 962249.png |  | DE-4764_1(1) id=732132 962264.png |  | DE-4765_1(1) id=732155 962292.png |
|  | DE-4766_1(1) id=732228 962401.png |  | DE-4767_1(1) id=732230 962403.png |  | DE-4768_1(1) id=732240 962413.png |
|  | DE-4769_1(1) id=732276 972011.png |  | DE-4770_1(1) id=732279 972015.png |  | DE-4771_1(1) id=732292 972033.png |
|  | DE-4772_1(1) id=732342 972119.png |  | DE-4773_1(1) id=732364 972159.png |  | DE-4774_1(1) id=732365 972160.png |

| | | | | | |
|---|---|---|---|---|---|
|  | DE-4775_1(1) id=732371 972169.png |  | DE-4776_1(1) id=732385 972185.png |  | DE-4777_1(1) id=732391 972192.png |
|  | DE-4778_1(1) id=732392 972193.png |  | DE-4779_1(1) id=732393 972194.png |  | DE-4780_1(1) id=732406 972209.png |
|  | DE-4781_1(1) id=732439 972274.png |  | DE-4782_1(1) id=732460 972299.png |  | DE-4783_1(1) id=732471 972322.png |
|  | DE-4784_1(1) id=732474 972331.png |  | DE-4785_1(1) id=732476 972333.png |  | DE-4786_1(1) id=732495 972358.png |
|  | DE-4787_1(1) id=732500 972364.png |  | DE-4788_1(1) id=732507 972371.png |  | DE-4789_1(1) id=732551 972423.png |
|  | DE-4790_1(1) id=732575 972470.png |  | DE-4791_1(1) id=732582 972477.png |  | DE-4792_1(1) id=732588 972483.png |
|  | DE-4793_1(1) id=732619 972517.png |  | DE-4794_1(1) id=732644 982030.png |  | DE-4795_1(1) id=732650 982036.png |

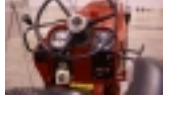
| | | | | | |
|---|---|---|---|---|---|
|  | DE-4796_1(1) id=732728 982126.png |  | DE-4797_1(1) id=732786 982191.png |  | DE-4798_1(1) id=732788 982193.png |
|  | DE-4799_1(1) id=732814 982221.png |  | DE-4800_1(1) id=732820 982235.png |  | DE-4801_1(1) id=732845 982262.png |
|  | DE-4802_1(1) id=732884 982303.png |  | DE-4803_1(1) id=732899 982318.png |  | DE-4804_1(1) id=732900 982319.png |
|  | DE-4805_1(1) id=732912 982332.png |  | DE-4806_1(1) id=732928 982356.png |  | DE-4807_1(1) id=732965 992026.png |
|  | DE-4808_1(1) id=732976 992038.png |  | DE-4809_1(1) id=732978 992040.png |  | DE-4810_1(1) id=732996 992062.png |
|  | DE-4811_1(1) id=733000 992066.png |  | DE-4812_1(1) id=733014 992082.png |  | DE-4813_1(1) id=733044 992116.png |
|  | DE-4814_1(1) id=733048 992120.png |  | DE-4815_1(1) id=733063 992136.png |  | DE-4816_1(1) id=733069 992142.png |
|  | DE-4817_1(1) id=733085 992158.png |  | DE-4818_1(1) id=733143 002001.png |  | DE-4819_1(1) id=733175 002040.png |
|  | DE-4820_1(1) id=733182 002047.png |  | DE-4821_1(1) id=733191 002056.png |  | DE-4822_1(1) id=733200 002066.png |







| | | | | | |
|---|---|---|---|---|---|
|  | DE-4823_1(1) id=733204 002070.png |  | DE-4824_1(1) id=733206 002072.png |  | DE-4825_1(1) id=733208 002074.png |
|  | DE-4826_1(1) id=733209 002075.png |  | DE-4827_1(1) id=733211 002077.png |  | DE-4828_1(1) id=733260 002126.png |
|  | DE-4829_1(1) id=733271 002137.png |  | DE-4830_1(1) id=733285 002153.png |  | DE-4831_1(1) id=733303 002172.png |
|  | DE-4832_1(1) id=733351 012012.png |  | DE-4833_1(1) id=733358 012019.png |  | DE-4834_1(1) id=733368 012029.png |
|  | DE-4835_1(1) id=733378 012042.png |  | DE-4836_1(1) id=733443 012108.png |  | DE-4837_1(1) id=733445 012110.png |
|  | DE-4838_1(1) id=733543 012211.png |  | DE-4839_1(1) id=733571 012244.png |  | DE-4840_1(1) id=733582 022003.png |
|  | DE-4841_1(1) id=733631 022054.png |  | DE-4842_1(1) id=733638 022061.png |  | DE-4843_1(1) id=733644 022067.png |
|  | DE-4844_1(1) id=733652 022075.png |  | DE-4845_1(1) id=733676 022105.png |  | DE-4846_1(1) id=733691 022120.png |
|  | DE-4847_1(1) id=733739 022176.png |  | DE-4848_1(1) id=733760 022197.png |  | DE-4849_1(1) id=733781 022218.png |

| | | | | | |
|---|---|---|---|---|---|
|  | DE-4850_1(1) id=733784 022221.png |  | DE-4851_1(1) id=733796 022233.png |  | DE-4852_1(1) id=733808 022247.png |
|  | DE-4853_1(1) id=733817 022256.png |  | DE-4854_1(1) id=733850 022289.png |  | DE-4855_1(1) id=733856 022295.png |
|  | DE-4856_1(1) id=733899 032005.png |  | DE-4857_1(1) id=733911 032017.png |  | DE-4858_1(1) id=733913 032019.png |
|  | DE-4859_1(1) id=733923 032029.png |  | DE-4860_1(1) id=733926 032032.png |  | DE-4861_1(1) id=733948 032054.png |
|  | DE-4862_1(1) id=733978 032093.png |  | DE-4863_1(1) id=733984 032099.png |  | DE-4864_1(1) id=733987 032102.png |
|  | DE-4865_1(1) id=734003 032118.png |  | DE-4866_1(1) id=734010 032127.png |  | DE-4867_1(1) id=734064 032183.png |
|  | DE-4868_1(1) id=734065 032184.png |  | DE-4869_1(1) id=734085 032204.png |  | DE-4870_1(1) id=734093 032212.png |
|  | DE-4871_1(1) id=734095 032214.png |  | DE-4872_1(1) id=734097 032216.png |  | DE-4873_1(1) id=734115 032234.png |
|  | DE-4874_1(1) id=734120 032239.png |  | DE-4875_1(1) id=734148 032267.png |  | DE-4876_1(1) id=734167 032286.png |
|  | DE-4877_1(1) id=734208 042017.png |  | DE-4878_1(1) id=734223 042033.png |  | DE-4879_1(1) id=734248 042060.png |

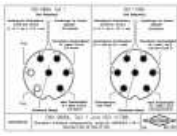
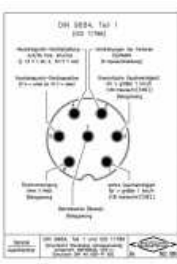

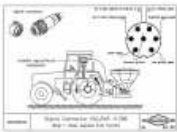
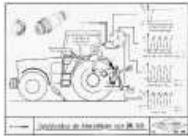
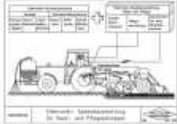

| | | | | | |
|---|--|---|--|---|---|
|  | DE-4880_1(1) id=734255 042067.png |  | DE-4881_1(1) id=734256 042068.png |  | DE-4882_1(1) id=734263 042076.png |
|  | DE-4883_1(1) id=734291 042105.png |  | DE-4884_1(1) id=734299 042113.png |  | DE-4885_1(1) id=734313 052015.png |
|  | DE-4886_1(1) id=734319 052021.png |  | DE-4887_1(1) id=734324 052026.png |  | DE-4888_1(1) id=734340 052042.png |
|  | DE-4889_1(1) id=734343 052045.png |  | DE-4890_1(1) id=734375 062035.png |  | DE-4891_1(1) id=734383 072006.png |
|  | DE-4892_1(1) id=734393 072016.png |  | DE-4893_1(1) id=734394 072017.png |  | DE-4894_1(1) id=734407 072030.png |
|  | DE-4895_1(1) id=734410 072033.png |  | DE-4896_1(1) id=734418 072041.png |  | DE-4897_1(1) id=806932 DSC03560.JPG |
|  | DE-4898_1(1) id=806934 DSC03562.JPG |  | DE-4899_1(1) id=806940 DSC03568.JPG |  | DE-4901_1(1) id=811794 JLUG-00003.tif |
|  | DE-4903_1(1) id=1001919 00035302.tif |  | DE-4904_1(1) id=1080010 DSC00049.tif |  | DE-4905_1(1) id=1080011 DSC00048.tif |
|  | DE-4907_1(1) id=1198378 00051642.tif |  | DE-4908_1(1) id=1198384 00051648.tif |  | DE-4909_1(1) id=1198386 00051650.tif |
|  | DE-4910_1(1) id=1198388 00051652.tif |  | DE-4911_1(1) id=1198394 00051658.tif |  | DE-4912_1(1) id=1198400 00051664.tif |

| | | | | | |
|---|--|---|--|---|--|
|  | DE-4913_1(1) id=1198408 00051672.tif |  | DE-4914_1(1) id=1198421 00051685.tif |  | DE-4915_1(1) id=1198425 00051689.tif |
|  | DE-4916_1(1) id=1207892 00051927.tif |  | DE-4917_1(1) id=1207914 00051799.tif |  | DE-4918_1(1) id=1208146 00051924.tif |
|  | DE-4919_1(1) id=1208165 00051874.tif |  | DE-4920_1(1) id=1208263 00052093.tif |  | DE-4921_1(1) id=1208271 00052111.tif |
|  | DE-4922_1(1) id=1208272 00052168.tif |  | DE-4923_1(1) id=1208274 00052149.tif |  | DE-4924_1(1) id=1208278 00052084.tif |
|  | DE-4925_1(1) id=1208284 00052070.tif |  | DE-4926_1(1) id=1208286 00052178.tif |  | DE-4927_1(1) id=1208287 00052102.tif |
|  | DE-4928_1(1) id=1208296 00052150.tif |  | DE-4929_1(1) id=1208325 00052170.tif |  | DE-4930_1(1) id=1208326 00052127.tif |
|  | DE-4931_1(1) id=1208344 00052072.tif |  | DE-4932_1(1) id=1208347 00052185.tif |  | DE-4933_1(1) id=1208352 00052171.tif |
|  | DE-4934_1(1) id=1208360 00052063.tif |  | DE-4935_1(1) id=1208364 00052157.tif |  | DE-4936_1(1) id=1208366 00052087.tif |
|  | DE-4937_1(1) id=1208368 00052162.tif |  | DE-4938_1(1) id=1208386 00052134.tif |  | DE-4939_1(1) id=1208387 00052064.tif |

3.12 Bilder-Downloads 2014: DK (Dänemark)

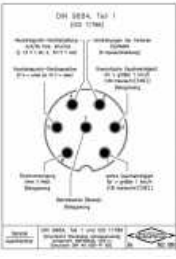
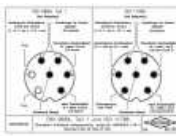
| Bild | Kennwerte | Bild | Kennwerte | Bild | Kennwerte |
|---|---|---|--|---|--|
|  | DK-0001_4(121) id=716664 932287.png |  | DK-0002_3(83) id=731997 962086.png |  | DK-0003_2(3) id=709430 00026983.tif |
|  | DK-0004_1(125) id=717109 00036613.tif |  | DK-0005_1(32) id=710156 932387.png |  | DK-0006_1(27) id=708542 00025604.tif |
|  | DK-0007_1(11) id=708543 912119.png |  | DK-0008_1(10) id=708767 00025948.tif |  | DK-0009_1(9) id=709464 00027039.tif |
|  | DK-0010_1(6) id=709644 00027381.tif |  | DK-0011_1(1) id=698249 00010507.tif | | |

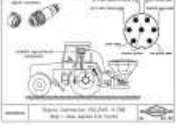

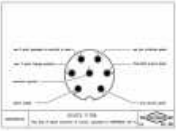
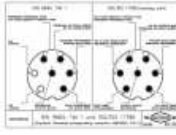

3.13 Bilder-Downloads 2014: EE (Estland)

| Bild | Kennwerte | Bild | Kennwerte | Bild | Kennwerte |
|---|--|---|---|---|--|
|  | EE-0001_3(83) id=731997 962086.png |  | EE-0002_3(121) id=716664 932287.png |  | EE-0003_1(65) id=732055 962152.png |
|  | EE-0004_1(32) id=710156 932387.png |  | EE-0005_1(9) id=709464 00027039.tif |  | EE-0006_1(5) id=732975 992037.png |
|  | EE-0007_1(3) id=710121 932388.png |  | EE-0008_1(3) id=731284 932255.png | | |



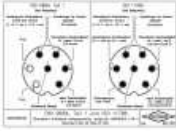
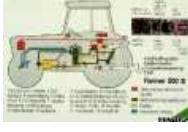

3.14 Bilder-Downloads 2014: EG (Ägypten)

| <i>Bild</i> | <i>Kennwerte</i> | <i>Bild</i> | <i>Kennwerte</i> | <i>Bild</i> | <i>Kennwerte</i> |
|---|--|-------------|------------------|-------------|------------------|
|  | EG-0001_1(5) id=642228 hub-00614.tif | | | | |



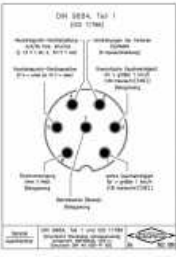
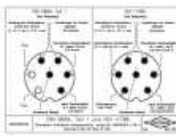
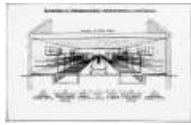
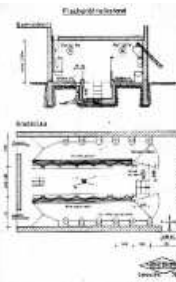



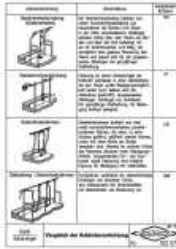

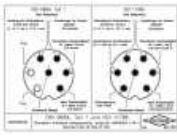

3.15 Bilder-Downloads 2014: ES (Spanien)

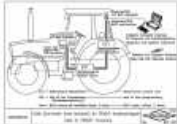
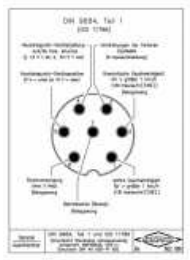
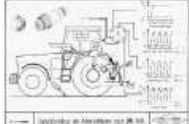
| <i>Bild</i> | <i>Kennwerte</i> | <i>Bild</i> | <i>Kennwerte</i> | <i>Bild</i> | <i>Kennwerte</i> |
|---|---|---|--|---|--|
|  | ES-0001_1(121) id=716664 932287.png |  | ES-0002_1(51) id=717444 00036976.tif |  | ES-0003_1(2) id=13733 00012066.tif |
|  | ES-0004_1(1) id=696904 00008705.tif |  | ES-0005_1(1) id=697133 00008991.tif | | |

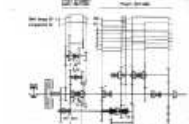



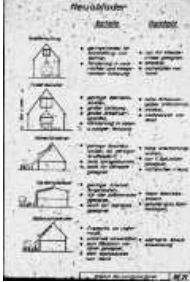

3.16 Bilder-Downloads 2014: FI (Finnland)

| Bild | Kennwerte | Bild | Kennwerte | Bild | Kennwerte |
|---|---|--|---|---|--|
|  | FI-0001_3(83) id=731997 962086.png |  | FI-0002_1(121) id=716664 932287.png |  | FI-0003_1(11) id=704103 00019193.tif |
|  | FI-0004_1(5) id=728605 00049182.tif |  | FI-0005_1(2) id=703619 00018534.tif |  | FI-0006_1(2) id=640778 hub-02044.tif |
|  | FI-0007_1(1) id=13966 00015461.tif |  | FI-0008_1(1) id=733656 022079.png | | |

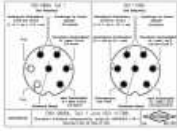

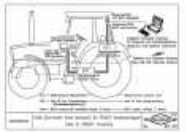
3.17 Bilder-Downloads 2014: FR (Frankreich)

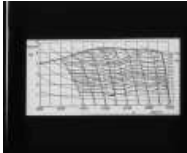
| Bild | Kennwerte | Bild | Kennwerte | Bild | Kennwerte |
|---|---|---|---|---|---|
|  | FR-0001_3(121) id=716664 932287.png |  | FR-0002_3(37) id=14404 00018713.tif |  | FR-0003_2(131) id=708251 00025123.tif |
|  | FR-0004_2(4) id=732508 972372.png |  | FR-0005_1(83) id=731997 962086.png |  | FR-0006_1(27) id=708542 00025604.tif |
|  | FR-0007_1(9) id=717446 00036978.tif |  | FR-0008_1(7) id=715862 00035133.tif |  | FR-0009_1(5) id=697271 00009157.tif |
|  | FR-0010_1(2) id=723884 00044221.tif |  | FR-0011_1(2) id=701558 00015695.tif |  | FR-0012_1(2) id=705214 00020629.tif |
|  | FR-0013_1(1) id=13605 00011646.tif |  | FR-0014_1(1) id=721311 00041215.tif |  | FR-0015_1(1) id=721513 00041461.tif |



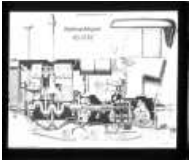

3.18 Bilder-Downloads 2014: GB (Großbritannien)

| Bild | Kennwerte | Bild | Kennwerte | Bild | Kennwerte |
|---|--|---|---|---|---|
|  | GB-0001_3(121) id=716664 932287.png |  | GB-0002_3(83) id=731997 962086.png |  | GB-0003_1(131) id=708251 00025123.tif |
|  | GB-0004_1(43) id=12665 00004609.tif |  | GB-0005_1(33) id=704610 00019845.tif |  | GB-0006_1(27) id=708542 00025604.tif |
|  | GB-0007_1(11) id=719575 00039273.tif |  | GB-0008_1(10) id=731293 932269.png |  | GB-0009_1(6) id=705822 00021469.tif |
|  | GB-0010_1(4) id=1208363 00052100.tif |  | GB-0011_1(4) id=696609 00008301.tif |  | GB-0012_1(4) id=732508 972372.png |
|  | GB-0013_1(3) id=731211 932124.png |  | GB-0014_1(3) id=811796 JLUG-00068.tif |  | GB-0015_1(2) id=1208365 00052181.tif |
|  | GB-0016_1(2) id=730531 00051340.tif |  | GB-0017_1(1) id=641744 hub-05417.tif |  | GB-0018_1(1) id=701929 00016209.tif |
|  | GB-0019_1(1) id=725829 00046265.tif |  | GB-0020_1(1) id=734009 032126.png | | |



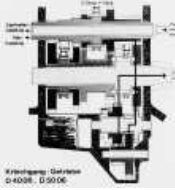
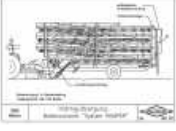

3.19 Bilder-Downloads 2014: GR (Griechenland)

| <i>Bild</i> | <i>Kennwerte</i> | <i>Bild</i> | <i>Kennwerte</i> | <i>Bild</i> | <i>Kennwerte</i> |
|---|--|---|--|---|---|
|  | GR-0001_1(15) id=720540 00040339.tif |  | GR-0002_1(6) id=638758 hub-03319.tif |  | GR-0003_1(1) id=734144 032263.png |

3.20 Bilder-Downloads 2014: HR (Kroatien)

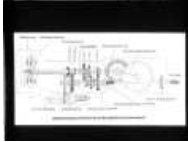
| <i>Bild</i> | <i>Kennwerte</i> | <i>Bild</i> | <i>Kennwerte</i> | <i>Bild</i> | <i>Kennwerte</i> |
|---|--|---|--|---|---|
|  | HR-0001_3(71) id=732043 962138.png |  | HR-0002_2(65) id=732055 962152.png |  | HR-0003_2(3) id=706940 00023006.tif |
|  | HR-0004_1(21) id=732182 962321.png |  | HR-0005_1(15) id=720540 00040339.tif |  | HR-0006_1(1) id=695835 00007737.tif |

3.21 Bilder-Downloads 2014: HU (Ungarn)

| Bild | Kennwerte | Bild | Kennwerte | Bild | Kennwerte |
|---|---|---|--|---|---|
|  | HU-0001_3(83) id=731997 962086.png |  | HU-0002_2(43) id=12665 00004609.tif |  | HU-0003_2(32) id=12981 00007302.tif |
|  | HU-0004_2(6) id=15297 00026743.tif |  | HU-0005_1(7) id=719070 00038734.tif |  | HU-0006_1(6) id=719103 00038775.tif |
|  | HU-0007_1(4) id=731625 952004.png |  | HU-0008_1(3) id=639432 hub-02836.tif |  | HU-0009_1(2) id=716894 00036391.tif |
|  | HU-0010_1(1) id=12468 00003524.tif |  | HU-0011_1(1) id=12539 00003991.tif |  | HU-0012_1(1) id=12559 00004096.tif |
|  | HU-0013_1(1) id=12590 00004184.tif |  | HU-0014_1(1) id=12778 00005377.tif |  | HU-0015_1(1) id=12866 00006009.tif |
|  | HU-0016_1(1) id=14301 00017737.tif |  | HU-0017_1(1) id=642792 hub-03685.tif |  | HU-0018_1(1) id=690130 00000641.tif |
|  | HU-0019_1(1) id=694984 00006659.tif |  | HU-0020_1(1) id=705622 00021186.tif |  | HU-0021_1(1) id=707494 00023836.tif |
|  | HU-0022_1(1) id=708493 00025506.tif |  | HU-0023_1(1) id=713662 00032598.tif |  | HU-0024_1(1) id=714922 00034046.tif |
|  | HU-0025_1(1) id=716738 00036229.tif |  | HU-0026_1(1) id=719187 00038860.tif |  | HU-0027_1(1) id=719248 00038922.tif |
|  | HU-0028_1(1) id=720665 00040470.tif |  | HU-0029_1(1) id=1207928 00052002.tif | | |

3.22 Bilder-Downloads 2014: IE (Irland)

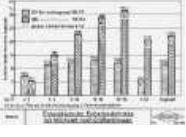
| <i>Bild</i> | <i>Kennwerte</i> | <i>Bild</i> | <i>Kennwerte</i> | <i>Bild</i> | <i>Kennwerte</i> |
|---|---|---|--|-------------|------------------|
|  | IE-0001_1(131) id=708251 00025123.tif |  | IE-0002_1(1) id=14161 00016607.tif | | |







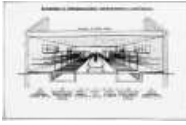



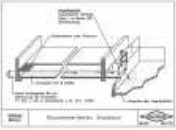
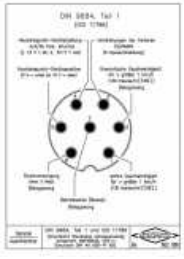

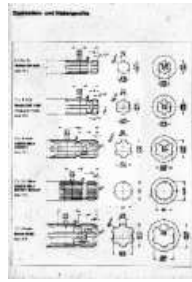
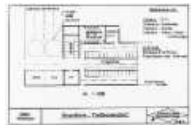
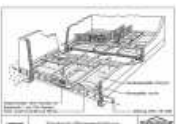
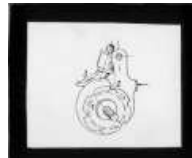

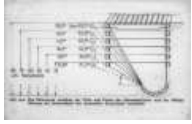
3.23 Bilder-Downloads 2014: IN (Indien)

| Bild | Kennwerte | Bild | Kennwerte | Bild | Kennwerte |
|---|---|---|---|---|---|
|  | IN-0001_1(125) id=717109 00036613.tif |  | IN-0002_1(1) id=698026 00010145.tif |  | IN-0003_1(1) id=731825 952338.png |

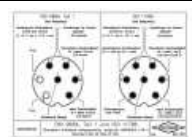
3.24 Bilder-Downloads 2014: IS (Island)

| <i>Bild</i> | <i>Kennwerte</i> | <i>Bild</i> | <i>Kennwerte</i> | <i>Bild</i> | <i>Kennwerte</i> |
|---|--|-------------|------------------|-------------|------------------|
|  | IS-0001_1(11) id=704103 00019193.tif | | | | |

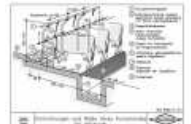
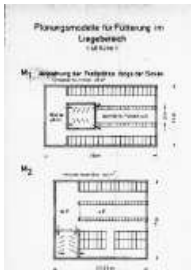
3.25 Bilder-Downloads 2014: IT (Italien)

| Bild | Kennwerte | Bild | Kennwerte | Bild | Kennwerte |
|---|--|---|--|---|---|
|  | IT-0001_5(26) id=731940 962012.png |  | IT-0002_3(83) id=731997 962086.png |  | IT-0003_3(5) id=695423 00007196.tif |
|  | IT-0004_2(17) id=690286 00000847.tif |  | IT-0005_2(15) id=725877 00046327.tif |  | IT-0006_2(14) id=14423 00018932.tif |
|  | IT-0007_2(12) id=731942 962014.png |  | IT-0008_2(4) id=641177 hub-00154.tif |  | IT-0009_2(2) id=690288 00000849.tif |
|  | IT-0010_2(2) id=695680 00007548.tif |  | IT-0011_2(2) id=704316 00019462.tif |  | IT-0012_2(2) id=728814 00049410.tif |
|  | IT-0013_2(2) id=730099 00050820.tif |  | IT-0014_1(121) id=716664 932287.png |  | IT-0015_1(65) id=732055 962152.png |
|  | IT-0016_1(23) id=13353 00010659.tif |  | IT-0017_1(23) id=731296 932272.png |  | IT-0018_1(11) id=732937 982365.png |
|  | IT-0019_1(9) id=721900 00042042.tif |  | IT-0020_1(8) id=12332 00002487.tif |  | IT-0021_1(8) id=705913 00021580.tif |

| | | | | | |
|---|---|---|---|---|---|
|  | IT-0022_1(6) id=701166 00015210.tif |  | IT-0023_1(3) id=14830 00023309.tif |  | IT-0024_1(3) id=731735 952227.png |
|  | IT-0025_1(2) id=691410 00002425.tif |  | IT-0026_1(2) id=705879 00021538.tif |  | IT-0027_1(2) id=705283 00020723.tif |
|  | IT-0028_1(2) id=707218 00023468.tif |  | IT-0029_1(1) id=14833 00023314.tif |  | IT-0030_1(1) id=690287 00000848.tif |
|  | IT-0031_1(1) id=691411 00002426.tif |  | IT-0032_1(1) id=702028 00016333.tif |  | IT-0033_1(1) id=702067 00016380.tif |
|  | IT-0034_1(1) id=702083 00016398.tif |  | IT-0035_1(1) id=702098 00016419.tif |  | IT-0036_1(1) id=711876 00030581.tif |
|  | IT-0037_1(1) id=728634 00049213.tif |  | IT-0038_1(1) id=728708 00049290.tif |  | IT-0039_1(1) id=730031 00050747.tif |
|  | IT-0040_1(1) id=731017 922179.png |  | IT-0041_1(1) id=731391 942016.png | | |

3.26 Bilder-Downloads 2014: JP (Japan)

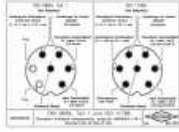
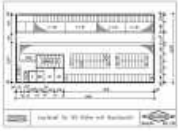
| <i>Bild</i> | <i>Kennwerte</i> | <i>Bild</i> | <i>Kennwerte</i> | <i>Bild</i> | <i>Kennwerte</i> |
|---|---|---|--|-------------|------------------|
|  | JP-0001_1(121) id=716664 932287.png |  | JP-0002_1(37) id=731745 952239.png | | |







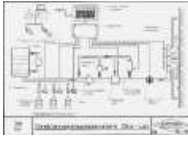



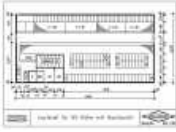
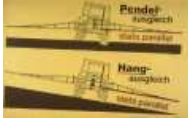
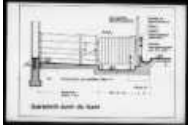



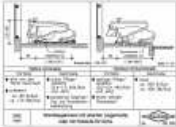

3.27 Bilder-Downloads 2014: KW (Kuwait)







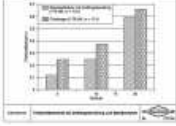
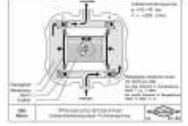
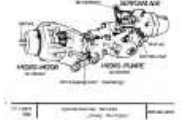

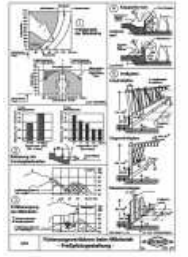

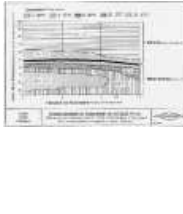
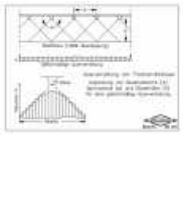



| <i>Bild</i> | <i>Kennwerte</i> | <i>Bild</i> | <i>Kennwerte</i> | <i>Bild</i> | <i>Kennwerte</i> |
|---|--|-------------|------------------|-------------|------------------|
|  | KW-0001_1(25) id=730456 00051267.tif | | | | |

3.28 Bilder-Downloads 2014: LT (Litauen)



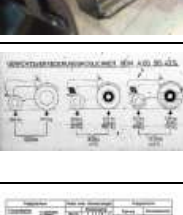

| <i>Bild</i> | <i>Kennwerte</i> | <i>Bild</i> | <i>Kennwerte</i> | <i>Bild</i> | <i>Kennwerte</i> |
|---|--|---|--|-------------|------------------|
|  | LT-0001_1(6) id=14347 00017915.tif |  | LT-0002_1(2) id=15621 00028588.tif | | |

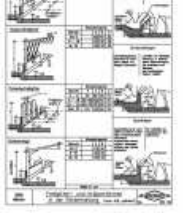
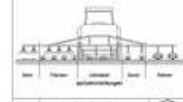
3.29 Bilder-Downloads 2014: LU (Luxemburg)



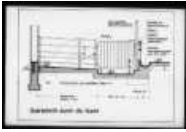







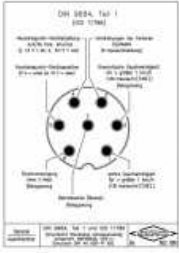

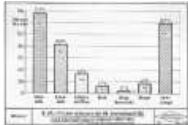
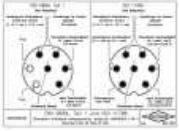





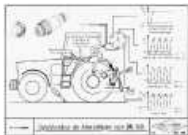







| Bild | Kennwerte | Bild | Kennwerte | Bild | Kennwerte |
|---|---|---|---|---|---|
|  | LU-0001_3(37) id=731745 952239.png |  | LU-0002_3(7) id=699990 00013529.tif |  | LU-0003_2(95) id=12277 00001971.tif |
|  | LU-0004_2(60) id=14044 00015810.tif |  | LU-0005_2(21) id=701340 00015426.tif |  | LU-0006_2(9) id=731939 962011.png |
|  | LU-0007_2(8) id=731299 932277.png |  | LU-0008_1(125) id=717109 00036613.tif |  | LU-0009_1(71) id=732043 962138.png |
|  | LU-0010_1(41) id=733193 002058.png |  | LU-0011_1(23) id=731296 932272.png |  | LU-0012_1(20) id=13987 00015704.tif |
|  | LU-0013_1(18) id=14052 00015822.tif |  | LU-0014_1(11) id=701548 00015683.tif |  | LU-0015_1(11) id=13986 00015701.tif |
|  | LU-0016_1(8) id=705169 00020571.tif |  | LU-0017_1(6) id=14919 00023658.tif |  | LU-0018_1(5) id=707013 00023104.tif |
|  | LU-0019_1(4) id=734381 072004.png |  | LU-0020_1(4) id=732574 972469.png |  | LU-0021_1(3) id=697265 00009151.tif |
|  | LU-0022_1(3) id=708935 00026201.tif |  | LU-0023_1(3) id=731785 952291.png |  | LU-0024_1(3) id=732548 972417.png |



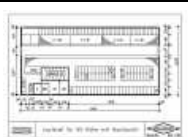



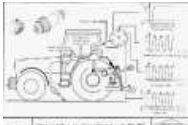
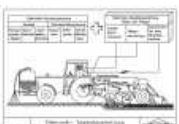

























| | | | | | |
|---|---|---|---|---|---|
|  | <p>LU-0025_1(2) id=642441 hub-00587.tif</p> |  | <p>LU-0026_1(2) id=724237 00044589.tif</p> |  | <p>LU-0027_1(2) id=731534 942293.png</p> |
|  | <p>LU-0028_1(2) id=13985 00015696.tif</p> |  | <p>LU-0029_1(2) id=640778 hub-02044.tif</p> |  | <p>LU-0030_1(2) id=701558 00015695.tif</p> |
|  | <p>LU-0031_1(1) id=15833 00029771.tif</p> |  | <p>LU-0032_1(1) id=638183 hub-02534.tif</p> |  | <p>LU-0033_1(1) id=639798 hub-10272.tif</p> |
|  | <p>LU-0034_1(1) id=701520 00015653.tif</p> |  | <p>LU-0035_1(1) id=707366 00023660.tif</p> |  | <p>LU-0036_1(1) id=708934 00026200.tif</p> |
|  | <p>LU-0037_1(1) id=708936 00026203.tif</p> |  | <p>LU-0038_1(1) id=708938 00026205.tif</p> |  | <p>LU-0039_1(1) id=717229 00036742.tif</p> |
|  | <p>LU-0040_1(1) id=724188 00044532.tif</p> |  | <p>LU-0041_1(1) id=728712 00049295.tif</p> |  | <p>LU-0042_1(1) id=732340 972116.png</p> |
|  | <p>LU-0043_1(1) id=734397 072020.png</p> | | | | |

















3.30 Bilder-Downloads 2014: LV (Lettland)



























| <i>Bild</i> | <i>Kennwerte</i> | <i>Bild</i> | <i>Kennwerte</i> | <i>Bild</i> | <i>Kennwerte</i> |
|---|---|---|---|---|--|
|  | LV-0001_1(95) id=12277 00001971.tif |  | LV-0002_1(4) id=724431 00044816.tif |  | LV-0003_1(3) id=14033 00015783.tif |
|  | LV-0004_1(1) id=715613 00034838.tif | | | | |

3.31 Bilder-Downloads 2014: NL (Niederlande)

| Bild | Kennwerte | Bild | Kennwerte | Bild | Kennwerte |
|---|--|---|--|---|--|
|  | NL-0001_7(83) id=731997 962086.png |  | NL-0002_7(12) id=721254 00041148.tif |  | NL-0003_6(6) id=691474 00002498.tif |
|  | NL-0004_4(121) id=716664 932287.png |  | NL-0005_4(5) id=719088 00038753.tif |  | NL-0006_3(32) id=710156 932387.png |
|  | NL-0007_3(7) id=711308 00029926.tif |  | NL-0008_3(7) id=715504 00034726.tif |  | NL-0009_3(4) id=719090 00038755.tif |
|  | NL-0010_3(3) id=1063343 Motorpflug.tif |  | NL-0011_2(27) id=708542 00025604.tif |  | NL-0012_2(24) id=15581 00028309.tif |
|  | NL-0013_2(5) id=15430 00027617.tif |  | NL-0014_2(4) id=698252 00010512.tif |  | NL-0015_2(3) id=15907 00043477.tif |
|  | NL-0016_2(3) id=716921 00036418.tif |  | NL-0017_2(3) id=719081 00038746.tif |  | NL-0018_2(2) id=698914 00011867.tif |
|  | NL-0019_2(2) id=712723 00031581.tif |  | NL-0020_2(2) id=716919 00036416.tif |  | NL-0021_2(2) id=719082 00038747.tif |
|  | NL-0022_1(125) id=717109 00036613.tif |  | NL-0023_1(37) id=731745 952239.png |  | NL-0024_1(32) id=12981 00007302.tif |
|  | NL-0025_1(21) id=732182 962321.png |  | NL-0026_1(13) id=711737 00030433.tif |  | NL-0027_1(11) id=709457 00027024.tif |
|  | NL-0028_1(11) id=708543 912119.png |  | NL-0029_1(8) id=689670 00000038.tif |  | NL-0030_1(7) id=711306 00029923.tif |

| | | | | | |
|---|---|---|--|---|---|
|  | NL-0031_1(7) id=715185 00034346.tif |  | NL-0032_1(7) id=638752 hub-05360.tif |  | NL-0033_1(6) id=14381 00018532.tif |
|  | NL-0034_1(6) id=695783 00007672.tif |  | NL-0035_1(6) id=715770 00035008.tif |  | NL-0036_1(6) id=696779 00008550.tif |
|  | NL-0037_1(6) id=717951 00037534.tif |  | NL-0038_1(5) id=12419 00003318.tif |  | NL-0039_1(5) id=689671 00000039.tif |
|  | NL-0040_1(5) id=711303 00029920.tif |  | NL-0041_1(5) id=722448 00042622.tif |  | NL-0042_1(4) id=711283 00029898.tif |
|  | NL-0043_1(4) id=711291 00029907.tif |  | NL-0044_1(4) id=722421 00042595.tif |  | NL-0045_1(4) id=722423 00042597.tif |
|  | NL-0046_1(4) id=703648 00018568.tif |  | NL-0047_1(4) id=711906 00030611.tif |  | NL-0048_1(4) id=716467 00035858.tif |
|  | NL-0049_1(4) id=716915 00036412.tif |  | NL-0050_1(4) id=717320 00036836.tif |  | NL-0051_1(3) id=697599 00009609.tif |
|  | NL-0052_1(3) id=701638 00015864.tif |  | NL-0053_1(3) id=711322 00029943.tif |  | NL-0054_1(3) id=711337 00029962.tif |
|  | NL-0055_1(3) id=711465 00030119.tif |  | NL-0056_1(3) id=711764 00030464.tif |  | NL-0057_1(3) id=716739 00036230.tif |
|  | NL-0058_1(3) id=721106 00040986.tif |  | NL-0059_1(3) id=721171 00041052.tif |  | NL-0060_1(3) id=721178 00041059.tif |
|  | NL-0061_1(3) id=721212 00041094.tif |  | NL-0062_1(3) id=722194 00042357.tif |  | NL-0063_1(3) id=722444 00042618.tif |

| | | | | | |
|---|---|---|--|---|--|
|  | NL-0064_1(3) id=713015 00031893.tif |  | NL-0065_1(3) id=722410 00042584.tif |  | NL-0066_1(2) id=12066 00000428.tif |
|  | NL-0067_1(2) id=14950 00023805.tif |  | NL-0068_1(2) id=15849 00029960.tif |  | NL-0069_1(2) id=641070 hub-05516.tif |
|  | NL-0070_1(2) id=697174 00009035.tif |  | NL-0071_1(2) id=697697 00009735.tif |  | NL-0072_1(2) id=697840 00009910.tif |
|  | NL-0073_1(2) id=703705 00018652.tif |  | NL-0074_1(2) id=707022 00023114.tif |  | NL-0075_1(2) id=711285 00029900.tif |
|  | NL-0076_1(2) id=711462 00030116.tif |  | NL-0077_1(2) id=711532 00030188.tif |  | NL-0078_1(2) id=716925 00036423.tif |
|  | NL-0079_1(2) id=717058 00036562.tif |  | NL-0080_1(2) id=719072 00038736.tif |  | NL-0081_1(2) id=719084 00038749.tif |
|  | NL-0082_1(2) id=719097 00038762.tif |  | NL-0083_1(2) id=719503 00039194.tif |  | NL-0084_1(2) id=720887 00040717.tif |
|  | NL-0085_1(2) id=721147 00041028.tif |  | NL-0086_1(2) id=721187 00041068.tif |  | NL-0087_1(2) id=722361 00042532.tif |
|  | NL-0088_1(2) id=728620 00049199.tif |  | NL-0089_1(2) id=1208240 00051943.tif |  | NL-0090_1(2) id=698266 00010540.tif |
|  | NL-0091_1(2) id=716910 00036407.tif |  | NL-0092_1(2) id=716973 00036474.tif |  | NL-0093_1(1) id=12084 00000538.tif |
|  | NL-0094_1(1) id=12493 00003693.tif |  | NL-0095_1(1) id=13271 00010311.tif |  | NL-0096_1(1) id=14204 00016984.tif |

| | | | | | |
|---|--|---|---|---|--|
|  | NL-0097_1(1) id=14220 00017064.tif |  | NL-0098_1(1) id=14866 00023383.tif |  | NL-0099_1(1) id=638827 hub-01477.tif |
|  | NL-0100_1(1) id=642272 hub-02619.tif |  | NL-0101_1(1) id=689700 00000073.tif |  | NL-0102_1(1) id=689772 00000166.tif |
|  | NL-0103_1(1) id=695578 00007419.tif |  | NL-0104_1(1) id=697423 00009356.tif |  | NL-0105_1(1) id=697585 00009592.tif |
|  | NL-0106_1(1) id=698143 00010320.tif |  | NL-0107_1(1) id=702075 00016389.tif |  | NL-0108_1(1) id=705545 00021078.tif |
|  | NL-0109_1(1) id=708162 00024978.tif |  | NL-0110_1(1) id=711489 00030144.tif |  | NL-0111_1(1) id=711548 00030206.tif |
|  | NL-0112_1(1) id=712432 00031180.tif |  | NL-0113_1(1) id=715501 00034721.tif |  | NL-0114_1(1) id=715771 00035009.tif |
|  | NL-0115_1(1) id=716923 00036420.tif |  | NL-0116_1(1) id=716926 00036425.tif |  | NL-0117_1(1) id=716960 00036460.tif |
|  | NL-0118_1(1) id=717022 00036524.tif |  | NL-0119_1(1) id=717027 00036529.tif |  | NL-0120_1(1) id=718168 00037757.tif |
|  | NL-0121_1(1) id=720438 00040236.tif |  | NL-0122_1(1) id=720439 00040237.tif |  | NL-0123_1(1) id=721146 00041027.tif |

| | | | | | |
|---|--|---|--|---|--|
|  | <p>NL-0124_1(1) id=721795 00041919.tif</p> |  | <p>NL-0125_1(1) id=722974 00043230.tif</p> |  | <p>NL-0126_1(1) id=724006 00044343.tif</p> |
|  | <p>NL-0127_1(1) id=727671 00048218.tif</p> |  | <p>NL-0128_1(1) id=728455 00049025.tif</p> |  | <p>NL-0129_1(1) id=728619 00049198.tif</p> |
|  | <p>NL-0130_1(1) id=728621 00049200.tif</p> |  | <p>NL-0131_1(1) id=728918 00049527.tif</p> |  | <p>NL-0132_1(1) id=734106 032225.png</p> |







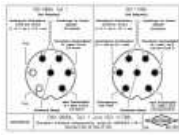
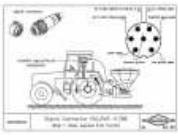





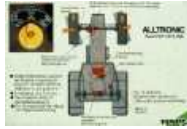
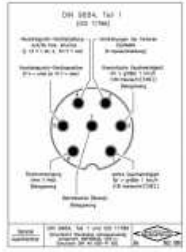

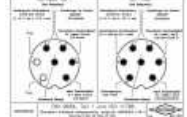







3.32 Bilder-Downloads 2014: NO (Norwegen)



| <i>Bild</i> | <i>Kennwerte</i> | <i>Bild</i> | <i>Kennwerte</i> | <i>Bild</i> | <i>Kennwerte</i> |
|---|--|---|---|-------------|------------------|
|  | NO-0001_1(83) id=731997 962086.png |  | NO-0002_1(125) id=717109 00036613.tif | | |

3.33 Bilder-Downloads 2014: NZ (Neuseeland)

| <i>Bild</i> | <i>Kennwerte</i> | <i>Bild</i> | <i>Kennwerte</i> | <i>Bild</i> | <i>Kennwerte</i> |
|---|---|---|--|-------------|------------------|
|  | NZ-0001_1(121) id=716664 932287.png |  | NZ-0002_1(32) id=710156 932387.png | | |



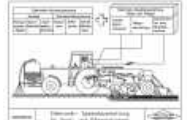















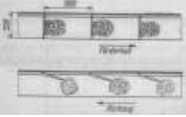













3.34 Bilder-Downloads 2014: PL (Polen)

| Bild | Kennwerte | Bild | Kennwerte | Bild | Kennwerte |
|---|---|---|---|---|--|
|  | PL-0001_8(8) id=718258 00037856.tif |  | PL-0002_6(7) id=720020 00039761.tif |  | PL-0003_5(8) id=707893 00024431.tif |
|  | PL-0004_4(83) id=731997 962086.png |  | PL-0005_3(3) id=704741 00020025.tif |  | PL-0006_2(121) id=716664 932287.png |
|  | PL-0007_2(21) id=732182 962321.png |  | PL-0008_2(10) id=15050 00024548.tif |  | PL-0009_2(15) id=720540 00040339.tif |
|  | PL-0010_2(9) id=690055 00000541.tif |  | PL-0011_2(23) id=731296 932272.png |  | PL-0012_2(9) id=12090 00000563.tif |
|  | PL-0013_2(5) id=13223 00009952.tif |  | PL-0014_2(4) id=14331 00017810.tif |  | PL-0015_2(4) id=713729 00032666.tif |
|  | PL-0016_2(3) id=716971 00036471.tif |  | PL-0017_2(2) id=13228 00009993.tif |  | PL-0018_2(2) id=14330 00017809.tif |
|  | PL-0019_2(2) id=695437 00007213.tif |  | PL-0020_2(2) id=697741 00009796.tif |  | PL-0021_2(2) id=697742 00009797.tif |
|  | PL-0022_2(2) id=701396 00015503.tif |  | PL-0023_2(2) id=704013 00019055.tif |  | PL-0024_2(2) id=718126 00037713.tif |

| | | | | | |
|---|---|---|--|---|--|
|  | PL-0025_2(2) id=720067 00039811.tif |  | PL-0026_2(2) id=721459 00041402.tif |  | PL-0027_2(2) id=723467 00043781.tif |
|  | PL-0028_2(2) id=730039 00050755.tif |  | PL-0029_2(2) id=734067 032186.png |  | PL-0030_1(71) id=732043 962138.png |
|  | PL-0031_1(60) id=14044 00015810.tif |  | PL-0032_1(27) id=730653 00051504.tif |  | PL-0033_1(27) id=708542 00025604.tif |
|  | PL-0034_1(9) id=717446 00036978.tif |  | PL-0035_1(11) id=708543 912119.png |  | PL-0036_1(6) id=690323 00000889.tif |
|  | PL-0037_1(6) id=712647 00031505.tif |  | PL-0038_1(6) id=730453 00051264.tif |  | PL-0039_1(6) id=15109 00024668.tif |
|  | PL-0040_1(6) id=696779 00008550.tif |  | PL-0041_1(5) id=709664 00027427.tif |  | PL-0042_1(5) id=711900 00030605.tif |
|  | PL-0043_1(5) id=716968 00036468.tif |  | PL-0044_1(5) id=721216 00041098.tif |  | PL-0045_1(8) id=731299 932277.png |
|  | PL-0046_1(5) id=711969 00030682.tif |  | PL-0047_1(4) id=12596 00004200.tif |  | PL-0048_1(4) id=13263 00010260.tif |
|  | PL-0049_1(4) id=13784 00012302.tif |  | PL-0050_1(4) id=13853 00013062.tif |  | PL-0051_1(4) id=14610 00021131.tif |
|  | PL-0052_1(4) id=724249 00044608.tif |  | PL-0053_1(4) id=697817 00009881.tif |  | PL-0054_1(4) id=716915 00036412.tif |
|  | PL-0055_1(3) id=12154 00000906.tif |  | PL-0056_1(3) id=14223 00017072.tif |  | PL-0057_1(3) id=15440 00027636.tif |

| | | | | | |
|---|---|---|---|---|---|
|  | PL-0058_1(3) id=697781 00009840.tif |  | PL-0059_1(3) id=697905 00009999.tif |  | PL-0060_1(3) id=698106 00010255.tif |
|  | PL-0061_1(3) id=707495 00023839.tif |  | PL-0062_1(3) id=707510 00023866.tif |  | PL-0063_1(3) id=711905 00030610.tif |
|  | PL-0064_1(3) id=712127 00030848.tif |  | PL-0065_1(3) id=712281 00031013.tif |  | PL-0066_1(3) id=716966 00036466.tif |
|  | PL-0067_1(3) id=717070 00036574.tif |  | PL-0068_1(3) id=717428 00036959.tif |  | PL-0069_1(3) id=719868 00039596.tif |
|  | PL-0070_1(3) id=719880 00039611.tif |  | PL-0071_1(3) id=721213 00041095.tif |  | PL-0072_1(3) id=723710 00044033.tif |
|  | PL-0073_1(3) id=724160 00044503.tif |  | PL-0074_1(3) id=696589 00008279.tif |  | PL-0075_1(3) id=713015 00031893.tif |
|  | PL-0076_1(2) id=13133 00009038.tif |  | PL-0077_1(2) id=13267 00010271.tif |  | PL-0078_1(2) id=13402 00010791.tif |
|  | PL-0079_1(2) id=13739 00012072.tif |  | PL-0080_1(2) id=13824 00012653.tif |  | PL-0081_1(2) id=14151 00016466.tif |
|  | PL-0082_1(2) id=14192 00016951.tif |  | PL-0083_1(2) id=14322 00017787.tif |  | PL-0084_1(2) id=14609 00021126.tif |
|  | PL-0085_1(2) id=14961 00023847.tif |  | PL-0086_1(2) id=15386 00027330.tif |  | PL-0087_1(2) id=15856 00030454.tif |
|  | PL-0088_1(2) id=695436 00007212.tif |  | PL-0089_1(2) id=696783 00008555.tif |  | PL-0090_1(2) id=696808 00008591.tif |
|  | PL-0091_1(2) id=696847 00008637.tif |  | PL-0092_1(2) id=696959 00008776.tif |  | PL-0093_1(2) id=697175 00009036.tif |
|  | PL-0094_1(2) id=698980 00011964.tif |  | PL-0095_1(2) id=700350 00014253.tif |  | PL-0096_1(2) id=701220 00015273.tif |

| | | |
|---|---|---|
|  PL-0097_1(2) id=703313 00018171.tif |  PL-0098_1(2) id=703709 00018656.tif |  PL-0099_1(2) id=705547 00021083.tif |
|  PL-0100_1(2) id=707458 00023780.tif |  PL-0101_1(2) id=712796 00031661.tif |  PL-0102_1(2) id=712992 00031869.tif |
|  PL-0103_1(2) id=713670 00032606.tif |  PL-0104_1(2) id=713799 00032737.tif |  PL-0105_1(2) id=714074 00033023.tif |
|  PL-0106_1(2) id=714319 00033300.tif |  PL-0107_1(2) id=716869 00036364.tif |  PL-0108_1(2) id=716972 00036472.tif |
|  PL-0109_1(2) id=717071 00036575.tif |  PL-0110_1(2) id=717093 00036597.tif |  PL-0111_1(2) id=719572 00039270.tif |
|  PL-0112_1(2) id=719587 00039287.tif |  PL-0113_1(2) id=719922 00039660.tif |  PL-0114_1(2) id=719923 00039661.tif |
|  PL-0115_1(2) id=719943 00039683.tif |  PL-0116_1(2) id=720296 00040080.tif |  PL-0117_1(2) id=720357 00040152.tif |
|  PL-0118_1(2) id=720586 00040386.tif |  PL-0119_1(2) id=720589 00040390.tif |  PL-0120_1(2) id=720810 00040636.tif |
|  PL-0121_1(2) id=720813 00040639.tif |  PL-0122_1(2) id=721256 00041150.tif |  PL-0123_1(2) id=723645 00043967.tif |
|  PL-0124_1(2) id=723647 00043969.tif |  PL-0125_1(2) id=723719 00044042.tif |  PL-0126_1(2) id=723723 00044046.tif |
|  PL-0127_1(2) id=723754 00044077.tif |  PL-0128_1(2) id=723882 00044219.tif |  PL-0129_1(2) id=730013 00050727.tif |

| | | | | | |
|---|---|---|---|---|---|
|  | PL-0130_1(3) id=709430 00026983.tif |  | PL-0131_1(2) id=14437 00019064.tif |  | PL-0132_1(2) id=698266 00010540.tif |
|  | PL-0133_1(2) id=716910 00036407.tif |  | PL-0134_1(2) id=716973 00036474.tif |  | PL-0135_1(2) id=721113 00040993.tif |
|  | PL-0136_1(2) id=721927 00042072.tif |  | PL-0137_1(1) id=12105 00000643.tif |  | PL-0138_1(1) id=12344 00002565.tif |
|  | PL-0139_1(1) id=12430 00003348.tif |  | PL-0140_1(1) id=12457 00003489.tif |  | PL-0141_1(1) id=12487 00003665.tif |
|  | PL-0142_1(1) id=12996 00007446.tif |  | PL-0143_1(1) id=13033 00007947.tif |  | PL-0144_1(1) id=13053 00008242.tif |
|  | PL-0145_1(1) id=13058 00008288.tif |  | PL-0146_1(1) id=13094 00008689.tif |  | PL-0147_1(1) id=13184 00009606.tif |
|  | PL-0148_1(1) id=13207 00009798.tif |  | PL-0149_1(1) id=13225 00009966.tif |  | PL-0150_1(1) id=13226 00009969.tif |
|  | PL-0151_1(1) id=13269 00010304.tif |  | PL-0152_1(1) id=13326 00010539.tif |  | PL-0153_1(1) id=13327 00010542.tif |
|  | PL-0154_1(1) id=13360 00010674.tif |  | PL-0155_1(1) id=13450 00010952.tif |  | PL-0156_1(1) id=13506 00011326.tif |
|  | PL-0157_1(1) id=13812 00012460.tif |  | PL-0158_1(1) id=13855 00013121.tif |  | PL-0159_1(1) id=14229 00017095.tif |
|  | PL-0160_1(1) id=14238 00017129.tif |  | PL-0161_1(1) id=14627 00021306.tif |  | PL-0162_1(1) id=14996 00024080.tif |

| | | | | | |
|---|---|---|---|---|---|
|  | PL-0163_1(1) id=15038 00024428.tif |  | PL-0164_1(1) id=15063 00024567.tif |  | PL-0165_1(1) id=15420 00027599.tif |
|  | PL-0166_1(1) id=15436 00027628.tif |  | PL-0167_1(1) id=15439 00027633.tif |  | PL-0168_1(1) id=15450 00027655.tif |
|  | PL-0169_1(1) id=15890 00039392.tif |  | PL-0170_1(1) id=689965 00000426.tif |  | PL-0171_1(1) id=696444 00008119.tif |
|  | PL-0172_1(1) id=696900 00008700.tif |  | PL-0173_1(1) id=697000 00008826.tif |  | PL-0174_1(1) id=697015 00008846.tif |
|  | PL-0175_1(1) id=697392 00009321.tif |  | PL-0176_1(1) id=697489 00009452.tif |  | PL-0177_1(1) id=697494 00009457.tif |
|  | PL-0178_1(1) id=697824 00009893.tif |  | PL-0179_1(1) id=697843 00009921.tif |  | PL-0180_1(1) id=697931 00010030.tif |
|  | PL-0181_1(1) id=697932 00010031.tif |  | PL-0182_1(1) id=697990 00010103.tif |  | PL-0183_1(1) id=698077 00010205.tif |
|  | PL-0184_1(1) id=698098 00010242.tif |  | PL-0185_1(1) id=698100 00010245.tif |  | PL-0186_1(1) id=698135 00010302.tif |
|  | PL-0187_1(1) id=698285 00010574.tif |  | PL-0188_1(1) id=698298 00010599.tif |  | PL-0189_1(1) id=698331 00010682.tif |
|  | PL-0190_1(1) id=698357 00010811.tif |  | PL-0191_1(1) id=698358 00010816.tif |  | PL-0192_1(1) id=698371 00010853.tif |
|  | PL-0193_1(1) id=698375 00010871.tif |  | PL-0194_1(1) id=698630 00011289.tif |  | PL-0195_1(1) id=698953 00011927.tif |
|  | PL-0196_1(1) id=698958 00011933.tif |  | PL-0197_1(1) id=699083 00012193.tif |  | PL-0198_1(1) id=699189 00012336.tif |
|  | PL-0199_1(1) id=699263 00012461.tif |  | PL-0200_1(1) id=699310 00012516.tif |  | PL-0201_1(1) id=699353 00012571.tif |

| | | | | | |
|---|---|---|---|---|---|
|  | PL-0202_1(1) id=699739 00013162.tif |  | PL-0203_1(1) id=699740 00013163.tif |  | PL-0204_1(1) id=700842 00014887.tif |
|  | PL-0205_1(1) id=700843 00014888.tif |  | PL-0206_1(1) id=703444 00018326.tif |  | PL-0207_1(1) id=703571 00018478.tif |
|  | PL-0208_1(1) id=703708 00018655.tif |  | PL-0209_1(1) id=703713 00018660.tif |  | PL-0210_1(1) id=704116 00019222.tif |
|  | PL-0211_1(1) id=704707 00019980.tif |  | PL-0212_1(1) id=705511 00021035.tif |  | PL-0213_1(1) id=705518 00021043.tif |
|  | PL-0214_1(1) id=705549 00021089.tif |  | PL-0215_1(1) id=705580 00021127.tif |  | PL-0216_1(1) id=705593 00021143.tif |
|  | PL-0217_1(1) id=705673 00021260.tif |  | PL-0218_1(1) id=705687 00021277.tif |  | PL-0219_1(1) id=705739 00021349.tif |
|  | PL-0220_1(1) id=705852 00021505.tif |  | PL-0221_1(1) id=705918 00021586.tif |  | PL-0222_1(1) id=706056 00021756.tif |
|  | PL-0223_1(1) id=706083 00021792.tif |  | PL-0224_1(1) id=706248 00022065.tif |  | PL-0225_1(1) id=706816 00022836.tif |
|  | PL-0226_1(1) id=707511 00023867.tif |  | PL-0227_1(1) id=707527 00023894.tif |  | PL-0228_1(1) id=708170 00024993.tif |







| | | | | | |
|---|---|---|---|---|---|
|  | PL-0229_1(1) id=708407 00025368.tif |  | PL-0230_1(1) id=708496 00025510.tif |  | PL-0231_1(1) id=709381 00026906.tif |
|  | PL-0232_1(1) id=709766 00027582.tif |  | PL-0233_1(1) id=710896 00029408.tif |  | PL-0234_1(1) id=711490 00030145.tif |
|  | PL-0235_1(1) id=711491 00030146.tif |  | PL-0236_1(1) id=711570 00030228.tif |  | PL-0237_1(1) id=711776 00030476.tif |
|  | PL-0238_1(1) id=711841 00030546.tif |  | PL-0239_1(1) id=712290 00031022.tif |  | PL-0240_1(1) id=712648 00031506.tif |
|  | PL-0241_1(1) id=712664 00031522.tif |  | PL-0242_1(1) id=712920 00031797.tif |  | PL-0243_1(1) id=712952 00031829.tif |
|  | PL-0244_1(1) id=713157 00032046.tif |  | PL-0245_1(1) id=713162 00032052.tif |  | PL-0246_1(1) id=713195 00032086.tif |
|  | PL-0247_1(1) id=713249 00032146.tif |  | PL-0248_1(1) id=713324 00032229.tif |  | PL-0249_1(1) id=713325 00032230.tif |
|  | PL-0250_1(1) id=713339 00032244.tif |  | PL-0251_1(1) id=713365 00032270.tif |  | PL-0252_1(1) id=713448 00032361.tif |
|  | PL-0253_1(1) id=713457 00032370.tif |  | PL-0254_1(1) id=713587 00032520.tif |  | PL-0255_1(1) id=713716 00032653.tif |
|  | PL-0256_1(1) id=713725 00032662.tif |  | PL-0257_1(1) id=713751 00032688.tif |  | PL-0258_1(1) id=713764 00032701.tif |
|  | PL-0259_1(1) id=713798 00032736.tif |  | PL-0260_1(1) id=713895 00032839.tif |  | PL-0261_1(1) id=713955 00032902.tif |

| | | | | | |
|---|---|---|---|---|---|
|  | PL-0262_1(1) id=713956 00032903.tif |  | PL-0263_1(1) id=713957 00032904.tif |  | PL-0264_1(1) id=714073 00033022.tif |
|  | PL-0265_1(1) id=714075 00033024.tif |  | PL-0266_1(1) id=714078 00033027.tif |  | PL-0267_1(1) id=714136 00033088.tif |
|  | PL-0268_1(1) id=714137 00033089.tif |  | PL-0269_1(1) id=714139 00033091.tif |  | PL-0270_1(1) id=714283 00033261.tif |
|  | PL-0271_1(1) id=714284 00033262.tif |  | PL-0272_1(1) id=714316 00033296.tif |  | PL-0273_1(1) id=714330 00033311.tif |
|  | PL-0274_1(1) id=714348 00033331.tif |  | PL-0275_1(1) id=715110 00034256.tif |  | PL-0276_1(1) id=715343 00034529.tif |
|  | PL-0277_1(1) id=716564 00036005.tif |  | PL-0278_1(1) id=716891 00036388.tif |  | PL-0279_1(1) id=716892 00036389.tif |
|  | PL-0280_1(1) id=716893 00036390.tif |  | PL-0281_1(1) id=716900 00036397.tif |  | PL-0282_1(1) id=716904 00036401.tif |
|  | PL-0283_1(1) id=716916 00036413.tif |  | PL-0284_1(1) id=716917 00036414.tif |  | PL-0285_1(1) id=716974 00036475.tif |
|  | PL-0286_1(1) id=716976 00036477.tif |  | PL-0287_1(1) id=717028 00036530.tif |  | PL-0288_1(1) id=717051 00036554.tif |
|  | PL-0289_1(1) id=717069 00036573.tif |  | PL-0290_1(1) id=717076 00036580.tif |  | PL-0291_1(1) id=717077 00036581.tif |
|  | PL-0292_1(1) id=717079 00036583.tif |  | PL-0293_1(1) id=717080 00036584.tif |  | PL-0294_1(1) id=717087 00036591.tif |
|  | PL-0295_1(1) id=717161 00036668.tif |  | PL-0296_1(1) id=717166 00036673.tif |  | PL-0297_1(1) id=717168 00036675.tif |

| | | | | | |
|---|---|---|---|---|---|
|  | PL-0298_1(1) id=717199 00036706.tif |  | PL-0299_1(1) id=717201 00036709.tif |  | PL-0300_1(1) id=717337 00036853.tif |
|  | PL-0301_1(1) id=718121 00037707.tif |  | PL-0302_1(1) id=718143 00037731.tif |  | PL-0303_1(1) id=718224 00037816.tif |
|  | PL-0304_1(1) id=718239 00037833.tif |  | PL-0305_1(1) id=718614 00038236.tif |  | PL-0306_1(1) id=718622 00038244.tif |
|  | PL-0307_1(1) id=718850 00038486.tif |  | PL-0308_1(1) id=719204 00038877.tif |  | PL-0309_1(1) id=719277 00038951.tif |
|  | PL-0310_1(1) id=719303 00038978.tif |  | PL-0311_1(1) id=719306 00038981.tif |  | PL-0312_1(1) id=719316 00038995.tif |
|  | PL-0313_1(1) id=719359 00039043.tif |  | PL-0314_1(1) id=719361 00039045.tif |  | PL-0315_1(1) id=719362 00039046.tif |
|  | PL-0316_1(1) id=719366 00039050.tif |  | PL-0317_1(1) id=719367 00039051.tif |  | PL-0318_1(1) id=719368 00039052.tif |
|  | PL-0319_1(1) id=719369 00039053.tif |  | PL-0320_1(1) id=719370 00039055.tif |  | PL-0321_1(1) id=719379 00039064.tif |
|  | PL-0322_1(1) id=719385 00039070.tif |  | PL-0323_1(1) id=719386 00039071.tif |  | PL-0324_1(1) id=719588 00039288.tif |
|  | PL-0325_1(1) id=719683 00039388.tif |  | PL-0326_1(1) id=719692 00039402.tif |  | PL-0327_1(1) id=719806 00039521.tif |
|  | PL-0328_1(1) id=719852 00039577.tif |  | PL-0329_1(1) id=719853 00039578.tif |  | PL-0330_1(1) id=719871 00039600.tif |
|  | PL-0331_1(1) id=719878 00039608.tif |  | PL-0332_1(1) id=719879 00039609.tif |  | PL-0333_1(1) id=719901 00039634.tif |

| | | | | | |
|---|---|---|---|---|---|
|  | PL-0334_1(1) id=719903 00039636.tif |  | PL-0335_1(1) id=719920 00039658.tif |  | PL-0336_1(1) id=719921 00039659.tif |
|  | PL-0337_1(1) id=719942 00039681.tif |  | PL-0338_1(1) id=719947 00039687.tif |  | PL-0339_1(1) id=719949 00039689.tif |
|  | PL-0340_1(1) id=720022 00039763.tif |  | PL-0341_1(1) id=720023 00039764.tif |  | PL-0342_1(1) id=720029 00039771.tif |
|  | PL-0343_1(1) id=720066 00039810.tif |  | PL-0344_1(1) id=720086 00039833.tif |  | PL-0345_1(1) id=720182 00039952.tif |
|  | PL-0346_1(1) id=720578 00040378.tif |  | PL-0347_1(1) id=720595 00040398.tif |  | PL-0348_1(1) id=720597 00040400.tif |
|  | PL-0349_1(1) id=720812 00040638.tif |  | PL-0350_1(1) id=721180 00041061.tif |  | PL-0351_1(1) id=721271 00041168.tif |
|  | PL-0352_1(1) id=721372 00041281.tif |  | PL-0353_1(1) id=721381 00041290.tif |  | PL-0354_1(1) id=721383 00041292.tif |
|  | PL-0355_1(1) id=723466 00043780.tif |  | PL-0356_1(1) id=723543 00043862.tif |  | PL-0357_1(1) id=723600 00043920.tif |
|  | PL-0358_1(1) id=723644 00043966.tif |  | PL-0359_1(1) id=723646 00043968.tif |  | PL-0360_1(1) id=723654 00043976.tif |
|  | PL-0361_1(1) id=723655 00043977.tif |  | PL-0362_1(1) id=723659 00043981.tif |  | PL-0363_1(1) id=723660 00043982.tif |
|  | PL-0364_1(1) id=723701 00044024.tif |  | PL-0365_1(1) id=723703 00044026.tif |  | PL-0366_1(1) id=723718 00044041.tif |
|  | PL-0367_1(1) id=723720 00044043.tif |  | PL-0368_1(1) id=723734 00044057.tif |  | PL-0369_1(1) id=723766 00044092.tif |



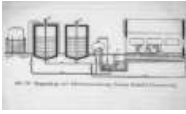

| | | | | | |
|---|---|---|---|---|---|
|  | PL-0370_1(1) id=723835 00044172.tif |  | PL-0371_1(1) id=723840 00044177.tif |  | PL-0372_1(1) id=723879 00044216.tif |
|  | PL-0373_1(1) id=723973 00044310.tif |  | PL-0374_1(1) id=724036 00044373.tif |  | PL-0375_1(1) id=724053 00044390.tif |
|  | PL-0376_1(1) id=724076 00044413.tif |  | PL-0377_1(1) id=724077 00044414.tif |  | PL-0378_1(1) id=724079 00044416.tif |
|  | PL-0379_1(1) id=724081 00044418.tif |  | PL-0380_1(1) id=724084 00044421.tif |  | PL-0381_1(1) id=724114 00044454.tif |
|  | PL-0382_1(1) id=724119 00044459.tif |  | PL-0383_1(1) id=724122 00044462.tif |  | PL-0384_1(1) id=724125 00044465.tif |
|  | PL-0385_1(1) id=724128 00044469.tif |  | PL-0386_1(1) id=724132 00044473.tif |  | PL-0387_1(1) id=724247 00044606.tif |
|  | PL-0388_1(1) id=724750 00045139.tif |  | PL-0389_1(1) id=724752 00045141.tif |  | PL-0390_1(1) id=724753 00045142.tif |
|  | PL-0391_1(1) id=727498 00048031.tif |  | PL-0392_1(1) id=727499 00048032.tif |  | PL-0393_1(1) id=729642 00050342.tif |
|  | PL-0394_1(1) id=729719 00050422.tif |  | PL-0395_1(1) id=729746 00050450.tif |  | PL-0396_1(1) id=729794 00050502.tif |
|  | PL-0397_1(1) id=729819 00050529.tif |  | PL-0398_1(1) id=730058 00050774.tif |  | PL-0399_1(1) id=730117 00050842.tif |
|  | PL-0400_1(1) id=730184 00050907.tif |  | PL-0401_1(1) id=730198 00050922.tif |  | PL-0402_1(1) id=730753 00051607.tif |
|  | PL-0403_1(1) id=730754 00051608.tif |  | PL-0404_1(1) id=730758 00051612.tif |  | PL-0405_1(1) id=730765 00051619.tif |

| | | | | | |
|---|---|---|---|---|---|
|  | <p>PL-0406_1(1) id=731311 932296.png</p> |  | <p>PL-0407_1(1) id=731314 932302.png</p> |  | <p>PL-0408_1(1) id=734074 032193.png</p> |
|  | <p>PL-0409_1(1) id=734137 032256.png</p> |  | <p>PL-0410_1(1) id=1207918 00051869.tif</p> |  | <p>PL-0411_1(1) id=1208119 00051915.tif</p> |
|  | <p>PL-0412_1(1) id=1208208 00051942.tif</p> | | | | |



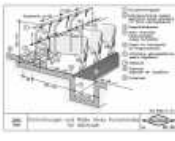
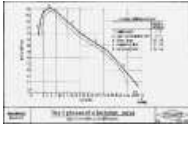

3.35 Bilder-Downloads 2014: PT (Portugal)

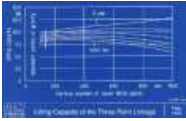
| <i>Bild</i> | <i>Kennwerte</i> | <i>Bild</i> | <i>Kennwerte</i> | <i>Bild</i> | <i>Kennwerte</i> |
|---|---|-------------|------------------|-------------|------------------|
|  | PT-0001_2(6) id=695408 00007177.tif | | | | |

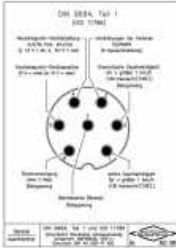

3.36 Bilder-Downloads 2014: RO (Rumänien)

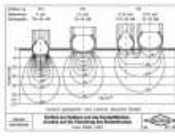
| <i>Bild</i> | <i>Kennwerte</i> | <i>Bild</i> | <i>Kennwerte</i> | <i>Bild</i> | <i>Kennwerte</i> |
|---|--|---|---|---|---|
|  | RO-0001_2(15) id=720540 00040339.tif |  | RO-0002_1(11) id=732937 982365.png |  | RO-0003_1(11) id=15877 00035921.tif |
|  | RO-0004_1(4) id=638245 hub-12593.tif |  | RO-0005_1(3) id=722074 00042228.tif |  | RO-0006_1(1) id=15280 00026527.tif |
|  | RO-0007_1(1) id=717645 00037200.tif | | | | |

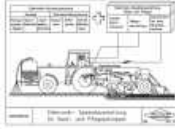
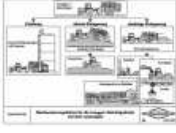



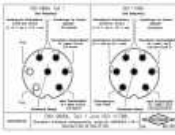

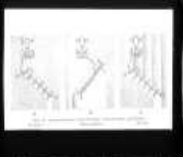

3.37 Bilder-Downloads 2014: RU (Russische Föderation)

| Bild | Kennwerte | Bild | Kennwerte | Bild | Kennwerte |
|---|--|---|---|---|--|
|  | RU-0001_3(83) id=731997 962086.png |  | RU-0002_2(3) id=712733 00031591.tif |  | RU-0003_2(3) id=732529 972395.png |
|  | RU-0004_1(23) id=731296 932272.png |  | RU-0005_1(131) id=708251 00025123.tif |  | RU-0006_1(11) id=708543 912119.png |
|  | RU-0007_1(1) id=734237 042049.png | | | | |

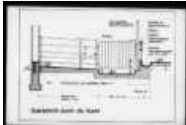

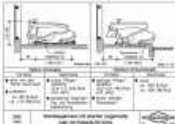
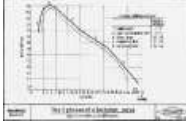
3.38 Bilder-Downloads 2014: SE (Schweden)

| Bild | Kennwerte | Bild | Kennwerte | Bild | Kennwerte |
|---|---|---|--|---|---|
|  | SE-0001_2(32) id=12981 00007302.tif |  | SE-0002_1(121) id=716664 932287.png |  | SE-0003_1(8) id=705913 00021580.tif |
|  | SE-0004_1(4) id=718066 00037652.tif |  | SE-0005_1(1) id=640821 hub-03807.tif | | |

3.39 Bilder-Downloads 2014: SI (Slowenien)

| <i>Bild</i> | <i>Kennwerte</i> | <i>Bild</i> | <i>Kennwerte</i> | <i>Bild</i> | <i>Kennwerte</i> |
|---|--|---|--|---|--|
|  | SI-0001_3(12) id=718032 00037618.tif |  | SI-0002_2(65) id=732055 962152.png |  | SI-0003_2(95) id=12277 00001971.tif |
|  | SI-0004_2(71) id=732043 962138.png |  | SI-0005_2(41) id=733193 002058.png |  | SI-0006_2(11) id=15877 00035921.tif |
|  | SI-0007_2(9) id=12090 00000563.tif |  | SI-0008_1(41) id=703578 00018485.tif |  | SI-0009_1(1) id=641296 hub-01528.tif |

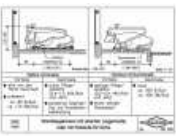
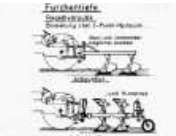

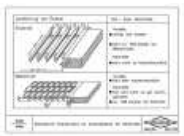
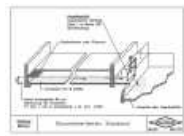

3.40 Bilder-Downloads 2014: SK (Slowakische Republik)

| <i>Bild</i> | <i>Kennwerte</i> | <i>Bild</i> | <i>Kennwerte</i> | <i>Bild</i> | <i>Kennwerte</i> |
|---|--|---|---|---|---|
|  | SK-0001_2(41) id=733193 002058.png |  | SK-0002_2(5) id=712632 00031481.tif |  | SK-0003_1(1) id=712637 952068.png |

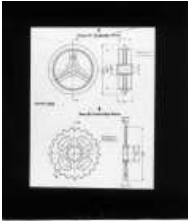
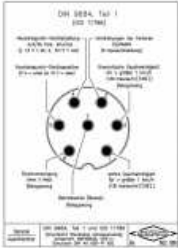
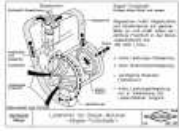

3.41 Bilder-Downloads 2014: TM (Turkmenistan)

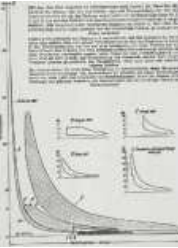
| Bild | Kennwerte | Bild | Kennwerte | Bild | Kennwerte |
|---|---|---|---|---|--|
|  | TM-0001_3(10) id=13076 00008529.tif |  | TM-0002_3(4) id=732963 992024.png |  | TM-0003_1(26) id=731940 962012.png |





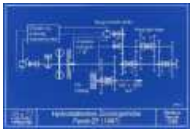

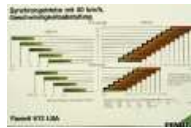





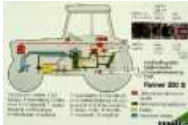





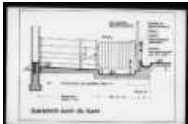

3.42 Bilder-Downloads 2014: TR (Türkei)

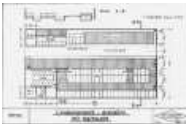
| Bild | Kennwerte | Bild | Kennwerte | Bild | Kennwerte |
|---|--|---|---|---|---|
|  | TR-0001_2(2) id=640495 hub-04537.tif |  | TR-0002_1(83) id=731997 962086.png |  | TR-0003_1(2) id=732874 982293.png |
|  | TR-0004_1(1) id=640490 hub-04538.tif |  | TR-0005_1(1) id=695832 00007734.tif |  | TR-0006_1(1) id=701764 00016017.tif |

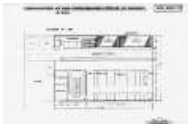
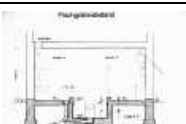

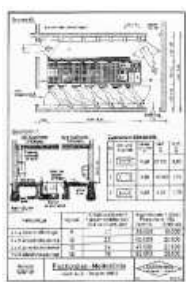
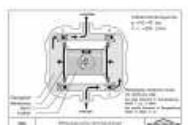











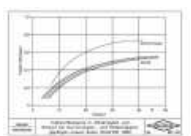

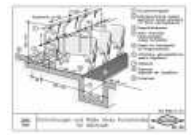



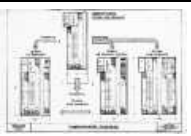



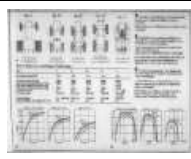

3.43 Bilder-Downloads 2014: UA (Ukraine)

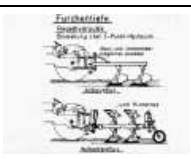







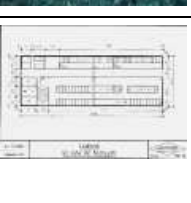

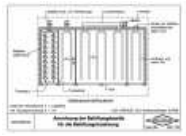
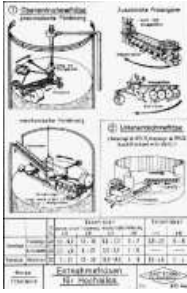

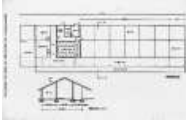



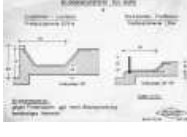

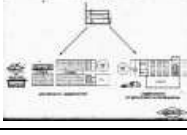
| <i>Bild</i> | <i>Kennwerte</i> | <i>Bild</i> | <i>Kennwerte</i> | <i>Bild</i> | <i>Kennwerte</i> |
|---|--|---|---|---|---|
|  | UA-0001_1(10) id=717794 00037359.tif |  | UA-0002_1(6) id=717951 00037534.tif |  | UA-0003_1(4) id=717955 00037538.tif |
|  | UA-0004_1(2) id=717810 00037375.tif | | | | |

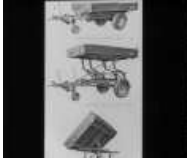



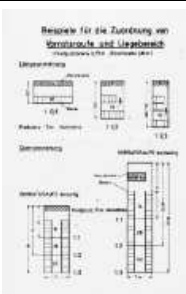
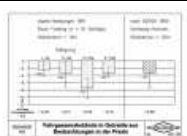





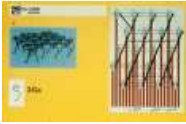
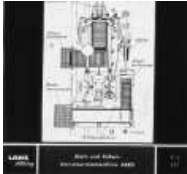





3.44 Bilder-Downloads 2014: US (USA)

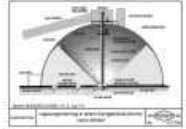
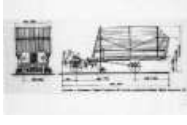
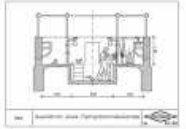





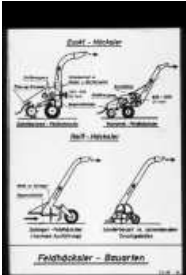



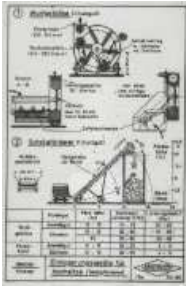

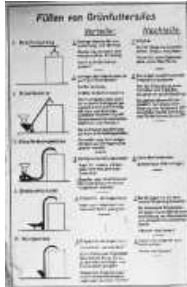

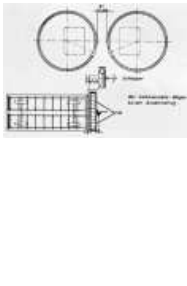
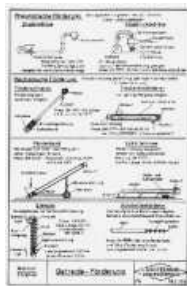
| Bild | Kennwerte | Bild | Kennwerte | Bild | Kennwerte |
|---|--|---|--|---|--|
|  | US-0001_10(131) id=708251 00025123.tif |  | US-0002_10(37) id=14404 00018713.tif |  | US-0003_8(51) id=717444 00036976.tif |
|  | US-0004_6(12) id=712027 00030740.tif |  | US-0005_5(10) id=720987 00040846.tif |  | US-0006_5(5) id=695790 00007681.tif |
|  | US-0007_4(125) id=717109 00036613.tif |  | US-0008_3(12) id=721254 00041148.tif |  | US-0009_2(95) id=12277 00001971.tif |
|  | US-0010_2(71) id=732043 962138.png |  | US-0011_2(15) id=701490 00015619.tif |  | US-0012_2(10) id=13992 00015719.tif |
|  | US-0013_2(10) id=14060 00015845.tif |  | US-0014_2(7) id=643316 hub-02012.tif |  | US-0015_2(7) id=14452 00019176.tif |
|  | US-0016_2(5) id=14513 00019856.tif |  | US-0017_2(5) id=700483 00014492.tif |  | US-0018_2(4) id=689720 00000099.tif |
|  | US-0019_2(4) id=728863 00049465.tif |  | US-0020_2(4) id=732574 972469.png |  | US-0021_2(3) id=643313 hub-03364.tif |
|  | US-0022_2(3) id=694907 00006565.tif |  | US-0023_2(3) id=729850 00050559.tif |  | US-0024_2(2) id=12516 00003852.tif |

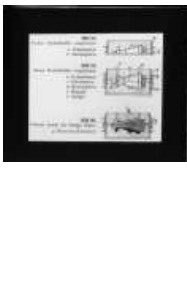

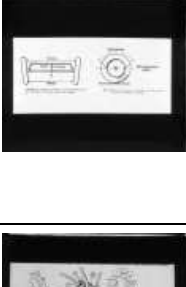
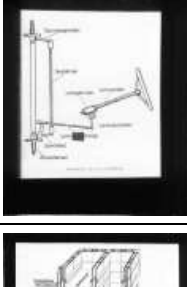
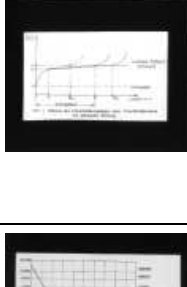
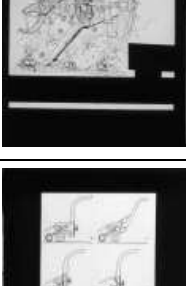
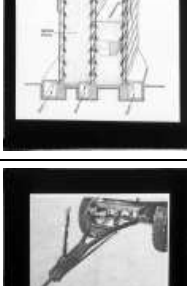
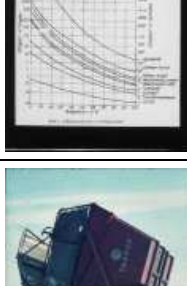















| | | | | | |
|--|--|--|--|--|---|
| | <p>US-0025_2(2) id=14362 00018273.tif</p> | | <p>US-0026_2(2) id=690480 00001077.tif</p> | | <p>US-0027_2(2) id=695287 00007013.tif</p> |
| | <p>US-0028_2(2) id=706811 00022830.tif</p> | | <p>US-0029_2(2) id=712021 00030734.tif</p> | | <p>US-0030_2(2) id=715474 00034674.tif</p> |
| | <p>US-0031_2(2) id=719926 00039664.tif</p> | | <p>US-0032_2(2) id=720270 00040053.tif</p> | | <p>US-0033_2(2) id=730499 00051309.tif</p> |
| | <p>US-0034_1(121) id=716664 932287.png</p> | | <p>US-0035_1(58) id=729097 00049735.tif</p> | | <p>US-0036_1(65) id=732055 962152.png</p> |
| | <p>US-0037_1(83) id=731997 962086.png</p> | | <p>US-0038_1(37) id=731745 952239.png</p> | | <p>US-0039_1(27) id=730653 00051504.tif</p> |
| | <p>US-0040_1(33) id=704610 00019845.tif</p> | | <p>US-0041_1(23) id=13353 00010659.tif</p> | | <p>US-0042_1(25) id=730456 00051267.tif</p> |
| | <p>US-0043_1(19) id=721500 00041446.tif</p> | | <p>US-0044_1(16) id=640899 hub-02721.tif</p> | | <p>US-0045_1(21) id=732182 962321.png</p> |
| | <p>US-0046_1(20) id=13987 00015704.tif</p> | | <p>US-0047_1(21) id=701340 00015426.tif</p> | | <p>US-0048_1(13) id=711737 00030433.tif</p> |
| | <p>US-0049_1(11) id=639234 hub-02812.tif</p> | | <p>US-0050_1(10) id=1198409 00051673.tif</p> | | <p>US-0051_1(11) id=704103 00019193.tif</p> |





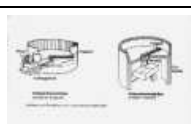



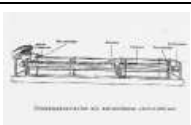
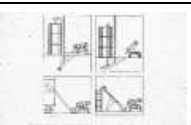







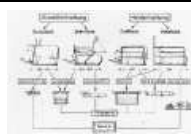
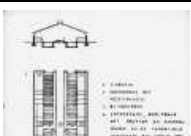

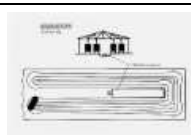
| | | | | | |
|---|--|---|--|---|---|
|  | US-0052_1(10) id=705308 00020750.tif |  | US-0053_1(15) id=720540 00040339.tif |  | US-0054_1(8) id=12076 00000490.tif |
|  | US-0055_1(8) id=721153 00041034.tif |  | US-0056_1(8) id=732255 962445.png |  | US-0057_1(8) id=14063 00015857.tif |
|  | US-0058_1(11) id=732937 982365.png |  | US-0059_1(7) id=638752 hub-05360.tif |  | US-0060_1(6) id=705566 00021111.tif |
|  | US-0061_1(5) id=12134 00000738.tif |  | US-0062_1(5) id=12947 00006868.tif |  | US-0063_1(5) id=14454 00019194.tif |
|  | US-0064_1(5) id=15845 00029925.tif |  | US-0065_1(5) id=712968 00031845.tif |  | US-0066_1(6) id=697598 00009608.tif |
|  | US-0067_1(4) id=12357 00002791.tif |  | US-0068_1(4) id=14453 00019189.tif |  | US-0069_1(4) id=690138 00000653.tif |
|  | US-0070_1(4) id=706556 00022480.tif |  | US-0071_1(4) id=711903 00030608.tif |  | US-0072_1(4) id=729255 00049906.tif |
|  | US-0073_1(4) id=733822 022261.png |  | US-0074_1(5) id=712632 00031481.tif |  | US-0075_1(4) id=12073 00000473.tif |
|  | US-0076_1(4) id=697817 00009881.tif |  | US-0077_1(4) id=711906 00030611.tif |  | US-0078_1(3) id=12869 00006022.tif |
|  | US-0079_1(3) id=695115 00006818.tif |  | US-0080_1(3) id=695117 00006822.tif |  | US-0081_1(3) id=695238 00006953.tif |
|  | US-0082_1(3) id=701767 00016020.tif |  | US-0083_1(3) id=703940 00018952.tif |  | US-0084_1(3) id=715478 00034678.tif |

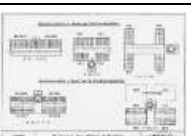

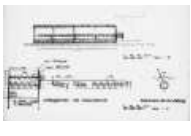
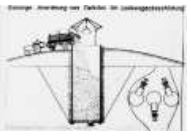

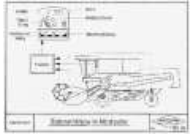

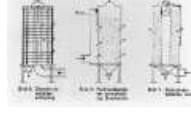
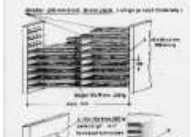







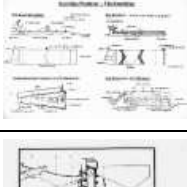
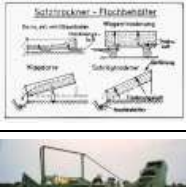

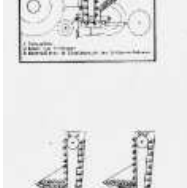

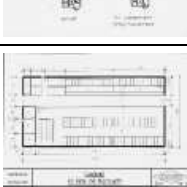
| | | | | | |
|---|--|---|--|---|---|
|  | US-0085_1(3) id=733057 992129.png |  | US-0086_1(6) id=13077 0008535.tif |  | US-0087_1(5) id=729490 00050225.tif |
|  | US-0088_1(3) id=13989 00015711.tif |  | US-0089_1(3) id=704682 00019947.tif |  | US-0090_1(3) id=730797 912086.png |
|  | US-0091_1(2) id=12175 00001028.tif |  | US-0092_1(2) id=12320 00002325.tif |  | US-0093_1(2) id=12413 00003282.tif |
|  | US-0094_1(2) id=12971 00007147.tif |  | US-0095_1(2) id=13990 00015716.tif |  | US-0096_1(2) id=14611 00021133.tif |
|  | US-0097_1(2) id=641871 hub-02167.tif |  | US-0098_1(2) id=643026 hub-02754.tif |  | US-0099_1(2) id=690329 00000895.tif |
|  | US-0100_1(2) id=695114 00006817.tif |  | US-0101_1(2) id=696820 00008606.tif |  | US-0102_1(2) id=701479 00015603.tif |
|  | US-0103_1(2) id=701807 00016069.tif |  | US-0104_1(2) id=709122 952252.png |  | US-0105_1(2) id=712408 00031156.tif |
|  | US-0106_1(2) id=715479 00034679.tif |  | US-0107_1(2) id=715712 00034944.tif |  | US-0108_1(2) id=718053 00037639.tif |







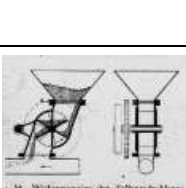
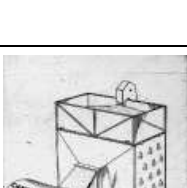
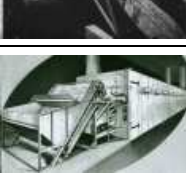
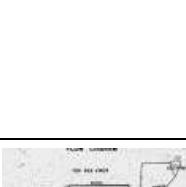
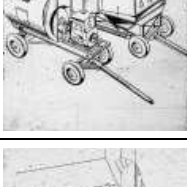



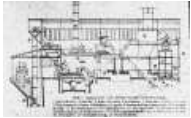
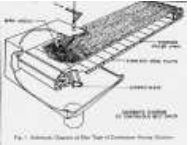





| | | |
|--|--|---|
|  <p>US-0109_1(2) id=719531 00039223.tif</p> |  <p>US-0110_1(2) id=720525 00040323.tif</p> |  <p>US-0111_1(2) id=720582 00040382.tif</p> |
|  <p>US-0112_1(2) id=720883 00040713.tif</p> |  <p>US-0113_1(2) id=721355 00041262.tif</p> |  <p>US-0114_1(2) id=729738 00050443.tif</p> |
|  <p>US-0115_1(2) id=730050 00050766.tif</p> |  <p>US-0116_1(2) id=730658 00051509.tif</p> |  <p>US-0117_1(2) id=732926 982354.png</p> |
|  <p>US-0118_1(2) id=733375 012038.png</p> |  <p>US-0119_1(10) id=720972 00040829.tif</p> |  <p>US-0120_1(10) id=731293 932269.png</p> |
|  <p>US-0121_1(2) id=716052 00035376.tif</p> |  <p>US-0122_1(2) id=721113 00040993.tif</p> |  <p>US-0123_1(2) id=729197 00049837.tif</p> |
|  <p>US-0124_1(2) id=730466 00051277.tif</p> |  <p>US-0125_1(2) id=730531 00051340.tif</p> |  <p>US-0126_1(2) id=730831 912162.png</p> |
|  <p>US-0127_1(1) id=12269 00001914.tif</p> |  <p>US-0128_1(1) id=12416 00003298.tif</p> |  <p>US-0129_1(1) id=12508 00003775.tif</p> |

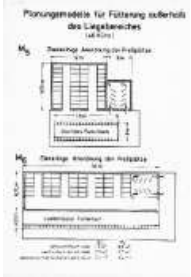



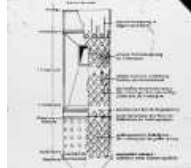
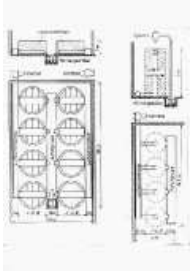
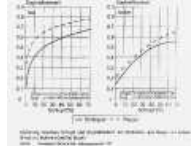

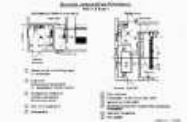

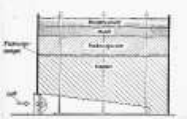



| | | | | | |
|---|--|---|--|---|--|
|  | US-0130_1(1) id=12527 00003938.tif |  | US-0131_1(1) id=12614 00004323.tif |  | US-0132_1(1) id=12792 00005483.tif |
|  | US-0133_1(1) id=12871 00006025.tif |  | US-0134_1(1) id=12895 00006216.tif |  | US-0135_1(1) id=13141 00009180.tif |
|  | US-0136_1(1) id=14756 00022844.tif |  | US-0137_1(1) id=637920 hub-01582.tif |  | US-0138_1(1) id=637931 hub-03972.tif |
|  | US-0139_1(1) id=638011 hub-01556.tif |  | US-0140_1(1) id=638012 hub-01557.tif |  | US-0141_1(1) id=638715 hub-03538.tif |
|  | US-0142_1(1) id=639066 hub-10378.tif |  | US-0143_1(1) id=640296 hub-02745.tif |  | US-0144_1(1) id=641279 hub-01694.tif |
|  | US-0145_1(1) id=641477 hub-04809.tif |  | US-0146_1(1) id=641603 hub-01905.tif |  | US-0147_1(1) id=689646 00000005.tif |
|  | US-0148_1(1) id=690001 00000471.tif |  | US-0149_1(1) id=690014 00000488.tif |  | US-0150_1(1) id=690324 00000890.tif |

| | | | | | |
|---|---|---|---|---|---|
|  | US-0151_1(1) id=690332 00000899.tif |  | US-0152_1(1) id=691147 00002049.tif |  | US-0153_1(1) id=695239 00006955.tif |
|  | US-0154_1(1) id=695349 00007102.tif |  | US-0155_1(1) id=695448 00007227.tif |  | US-0156_1(1) id=695606 00007450.tif |
|  | US-0157_1(1) id=695687 00007555.tif |  | US-0158_1(1) id=695787 00007677.tif |  | US-0159_1(1) id=695788 00007679.tif |
|  | US-0160_1(1) id=695793 00007686.tif |  | US-0161_1(1) id=697235 00009111.tif |  | US-0162_1(1) id=697596 00009605.tif |
|  | US-0163_1(1) id=697937 00010040.tif |  | US-0164_1(1) id=698042 00010163.tif |  | US-0165_1(1) id=698043 00010164.tif |
|  | US-0166_1(1) id=700925 00014991.tif |  | US-0167_1(1) id=701168 00015212.tif |  | US-0168_1(1) id=701469 00015593.tif |
|  | US-0169_1(1) id=701710 00015956.tif |  | US-0170_1(1) id=701796 00016055.tif |  | US-0171_1(1) id=702949 00017703.tif |

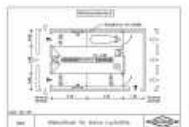
| | | | | | |
|---|---|---|---|---|---|
|  | US-0172_1(1) id=702992 00017783.tif |  | US-0173_1(1) id=703700 00018645.tif |  | US-0174_1(1) id=703746 00018699.tif |
|  | US-0175_1(1) id=703752 00018706.tif |  | US-0176_1(1) id=703764 00018725.tif |  | US-0177_1(1) id=703816 00018782.tif |
|  | US-0178_1(1) id=703926 00018931.tif |  | US-0179_1(1) id=704089 00019163.tif |  | US-0180_1(1) id=704092 00019167.tif |
|  | US-0181_1(1) id=704098 00019181.tif |  | US-0182_1(1) id=704343 00019497.tif |  | US-0183_1(1) id=705254 00020673.tif |
|  | US-0184_1(1) id=706549 00022471.tif |  | US-0185_1(1) id=706688 00022662.tif |  | US-0186_1(1) id=706689 00022663.tif |
|  | US-0187_1(1) id=709040 00026377.tif |  | US-0188_1(1) id=710608 00029012.tif |  | US-0189_1(1) id=711950 00030660.tif |
|  | US-0190_1(1) id=711955 00030666.tif |  | US-0191_1(1) id=711962 00030674.tif |  | US-0192_1(1) id=711973 00030686.tif |

| | | | | | |
|---|---|---|---|---|---|
|  | US-0193_1(1) id=711989 00030702.tif |  | US-0194_1(1) id=712009 00030722.tif |  | US-0195_1(1) id=712015 00030728.tif |
|  | US-0196_1(1) id=712016 00030729.tif |  | US-0197_1(1) id=712065 00030782.tif |  | US-0198_1(1) id=712066 00030783.tif |
|  | US-0199_1(1) id=712240 00030972.tif |  | US-0200_1(1) id=712358 00031100.tif |  | US-0201_1(1) id=712433 00031181.tif |
|  | US-0202_1(1) id=715240 00034405.tif |  | US-0203_1(1) id=715477 00034677.tif |  | US-0204_1(1) id=715765 00035003.tif |
|  | US-0205_1(1) id=716057 00035381.tif |  | US-0206_1(1) id=716427 00035801.tif |  | US-0207_1(1) id=720573 00040373.tif |
|  | US-0208_1(1) id=720579 00040379.tif |  | US-0209_1(1) id=721297 00041196.tif |  | US-0210_1(1) id=721300 00041199.tif |
|  | US-0211_1(1) id=721309 00041210.tif |  | US-0212_1(1) id=721405 00041321.tif |  | US-0213_1(1) id=721412 00041328.tif |
|  | US-0214_1(1) id=721414 00041330.tif |  | US-0215_1(1) id=721415 00041331.tif |  | US-0216_1(1) id=721420 00041340.tif |

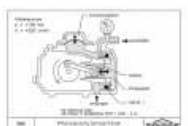
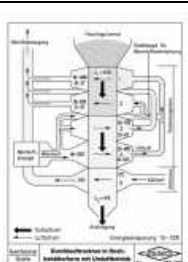
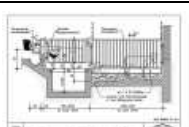
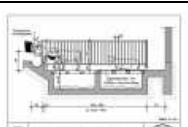
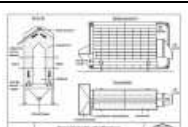
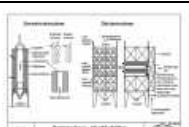
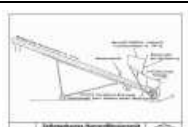
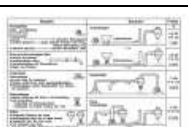
| | | | | | |
|---|---|---|---|---|---|
|  <p>SPIRAL FLOTATION MACHINE BARRIS LIMITED LONDON</p> | US-0217_1(1) id=721422 00041343.tif |  | US-0218_1(1) id=721424 00041346.tif |  <p>Fig. 1. Sectional View of the Type of Combined Flotation Machine</p> | US-0219_1(1) id=721425 00041351.tif |
|  | US-0220_1(1) id=721428 00041354.tif |  | US-0221_1(1) id=721639 00041731.tif |  | US-0222_1(1) id=721680 00041776.tif |
|  | US-0223_1(1) id=721683 00041779.tif |  | US-0224_1(1) id=721684 00041780.tif |  | US-0225_1(1) id=721889 00042031.tif |
|  | US-0226_1(1) id=721893 00042035.tif |  <p>Planungsmittel für Filterung außerhalb des Lagerbereiches M₁ ... M₂ ...</p> | US-0227_1(1) id=721901 00042043.tif |  | US-0228_1(1) id=721904 00042046.tif |
|  | US-0229_1(1) id=722248 00042413.tif |  | US-0230_1(1) id=722334 00042500.tif |  | US-0231_1(1) id=722767 00042989.tif |
|  | US-0232_1(1) id=722772 00042998.tif |  | US-0233_1(1) id=722778 00043005.tif |  | US-0234_1(1) id=723615 00043936.tif |
|  | US-0235_1(1) id=723777 00044104.tif |  | US-0236_1(1) id=724292 00044655.tif |  | US-0237_1(1) id=728862 00049464.tif |
|  | US-0238_1(1) id=729186 00049825.tif |  | US-0239_1(1) id=729196 00049836.tif |  | US-0240_1(1) id=729292 00049945.tif |

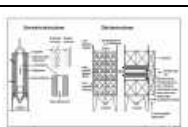
| | | |
|--|--|--|
|  <p>US-0241_1(1) id=730045 00050760.tif</p> |  <p>US-0242_1(1) id=730121 00050846.tif</p> |  <p>US-0243_1(1) id=730320 00051070.tif</p> |
|  <p>US-0244_1(1) id=730465 00051276.tif</p> |  <p>US-0245_1(1) id=730497 00051307.tif</p> |  <p>US-0246_1(1) id=730498 00051308.tif</p> |
|  <p>US-0247_1(1) id=731273 932227.png</p> |  <p>US-0248_1(1) id=731298 932274.png</p> |  <p>US-0249_1(1) id=731319 932313.png</p> |
|  <p>US-0250_1(1) id=731499 942223.png</p> |  <p>US-0251_1(1) id=732339 972115.png</p> |  <p>US-0252_1(1) id=732573 972468.png</p> |
|  <p>US-0253_1(1) id=732713 982108.png</p> |  <p>US-0254_1(1) id=732922 982350.png</p> |  <p>US-0255_1(1) id=732927 982355.png</p> |
|  <p>US-0256_1(1) id=733371 012034.png</p> |  <p>US-0257_1(1) id=733372 012035.png</p> |  <p>US-0258_1(1) id=733584 022005.png</p> |
|  <p>US-0259_1(1) id=733834 022273.png</p> |  <p>US-0260_1(1) id=733835 022274.png</p> |  <p>US-0261_1(1) id=733889 022330.png</p> |

3.45 Bilder-Downloads 2014: ZA (Südafrika)

| <i>Bild</i> | <i>Kennwerte</i> | <i>Bild</i> | <i>Kennwerte</i> | <i>Bild</i> | <i>Kennwerte</i> |
|---|--|---|---|---|--|
|  | ZA-0001_3(121) id=716664 932287.png |  | ZA-0002_1(6) id=709644 00027381.tif |  | ZA-0003_1(3) id=643312 hub-03365.tif |
|  | ZA-0004_1(2) id=640027 hub-03675.tif | | | | |