

# Simulation Based Testing of Charging Infrastructure and Power Management Algorithms with ICIRP

René Unger,  
Torsten Schwan,  
EA Systems Dresden GmbH  
Dresden, Germany  
rene.unger@ea-energie.de

Ronny Petersohn  
Department of Vehicle Mechatronics  
Dresden University of Technology  
Dresden, Germany  
ronny.petersohn@tu-dresden.de

**Abstract** — Infrastructure impact of electric vehicle charging on the distribution grid is a major cost issue for local energy suppliers. High power peaks correspond to small overall energy consumption. This situation requires sophisticated charging and power management algorithms.

The paper shows the concept and essential features of a test concept for such power controllers based on modular, easy to extend charging hardware, web-platform and connected infrastructure simulation in modelica.

This research platform for intelligent vehicle charging and management (ICIRP) was developed and is currently extended in cooperation with IAD TU Dresden and IAM GmbH and EA Systems Dresden GmbH.

## I. INTRODUCTION

Getting a substantial number of electrified vehicles to the road is a major issue for future mobility concepts. While all major car manufacturers have hybrid or battery electric vehicles in their product lineup, the required support infrastructure in Germany still consists of prototypes and flagship projects.

With the growing number of vehicles, the power rating of the charging infrastructure and the supporting distribution grid is a major issue. For the grid the required peak load is much more of a challenge than the needed amount of energy. A comparison illustrates this.

A typical multi storey car park has 63A lateral line. One additional 32 A Type 2 Outlet supports up to 22 kW charging power. Often, this cannot be realized without additional investments into the lateral connection. Additionally a vehicle charging with maximum power compares to 300 to 400 bulbs for street lighting. This is enough to illuminate a city district. The infrastructure requirements rise linear to the number of charging outlets. This is not a problem yet but for the near future.

Providing this power requires new investments in the building grid (medium-voltage-transformers, main distribution board, etc.). Such investments are often much higher than the cost of charging stations or even vehicles and therefore are in

no economic relation to the actual proved electrical energy (20 to 50 kWh for a full charge).

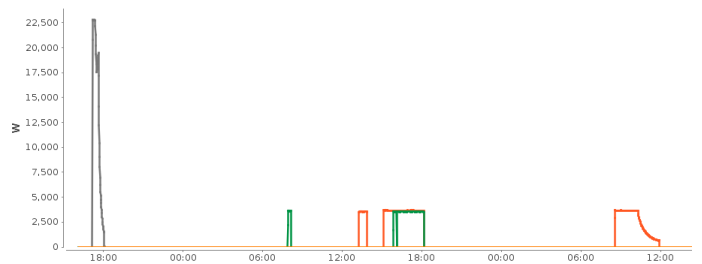

Fig. 1. Typical Load Profile for charging station with 4 Outlets (2x 32A, 2x 16A)

Yet, a wide-scale electric mobility is not possible without enough charging points available. Therefore a sophisticated power management is essential in future applications.

The management algorithm needs to distribute the available power between the connected vehicles as well as other consumer like park deck lighting or heating, cooling and ventilation systems. This gets more complicated if local (CHP) or renewable (photovoltaics) energy is available.

Development and testing of these algorithms and their real world implementations needs specialized tools. Two of these tools, a modular extensible charging station software as well as a building and smart grid simulation library are shown in this paper.

## II. BASIC CHARGING STRATEGIES

The main challenge for electrical vehicle usage is range. This can be compensated with a good usage strategy (know when to go where) and a reliable charging infrastructure (easy to find, cable compatibility, not occupied). Today this is more a future vision with the cable drum in the trunk (CDT-Solution) being the reality.

There are two main strategies for charging applications. One strategy is to charge with the maximum possible power. The charging time is seen as an interruption to the mobility demand of the user. This strategy is similar to the classic refueling scenario of the conventional gas- or diesel driven car.

This fast-charging is complicated by the immense hardware as shown before.

The other strategy is to charge for a longer time with less power. To make this suitable for the user, low power charging must correspond to planned duration of parking and the planned route. This has to be synchronized with the daily schedule. For long distances a better suited vehicle (i.e. diesel driven) needs to be ordered. It is easy to see, that the demand on charging infrastructure is much lower, but a lot of extra planning and informational infrastructure is needed.

To approach these challenges, the Institute of Automotive Technologies of Dresden Technical University, EA Systems Dresden GmbH and IAM GmbH work together in developing an intelligent charging infrastructure. The new charging station is a capable platform to research usage scenarios, fleet management, grid interaction and renewable power charging strategies in current research projects like EnMover, ECityRouting and EMiD.

### III. REQUIREMENTS

Previous projects like “Residence and Mobility” showed the demands for such an intelligent charging solution in research & development projects. The main objective is to provide an easy to use and well instrumented interface to vehicle charging. That way the engineer or scientist can concentrate on the research topic, for example the fleet management algorithm.

An important requirement is the capability for dynamic power switching based on external inputs. Typical inputs are available renewable power or the limit of the lateral connection line. This is especially important to research fleet charging strategies.

Additionally an instrumented charging station needs to support a complete set of measuring devices regarding power metering, environment sensors or grid frequency analysis. This allows evaluation of grid perturbations.

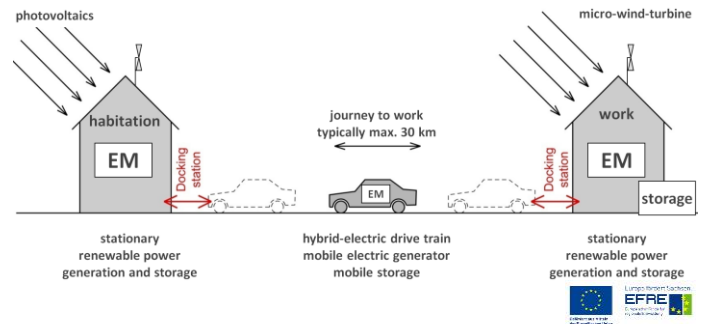

Fig. 2. Residence and Mobility - basic research to supply energy demands of home and commuting with local renewable energy [1]

The system needs to be extensible to integrate modules which are not standard. Therefore connectivity to other management systems (machine2machine) is as important as standard user interaction via web platform and mobile internet devices.

For advanced testing the platform needs to support real-time monitoring and remote control with quick reaction times for user interaction.

If something fails, most functionality should also be available even if the station is disconnected from its uplink. This is especially important in security enhanced research networks where connectivity is often a bureaucratic issue.

In fleet testing, the price per charging point is a major issue for feasibility. Since the instrumentation and internet connection to user require a lot of cost intensive hardware this conflict is alleviated with a master-slave concept, where a more expensive central station support a number of ‘dumb’ slave outlets.

### IV. EASYCHARGE2 - FLEXIBLE AND MODULAR PLATFORM

The new charging infrastructure implements the mentioned requirements to provide an out of the box solution, so

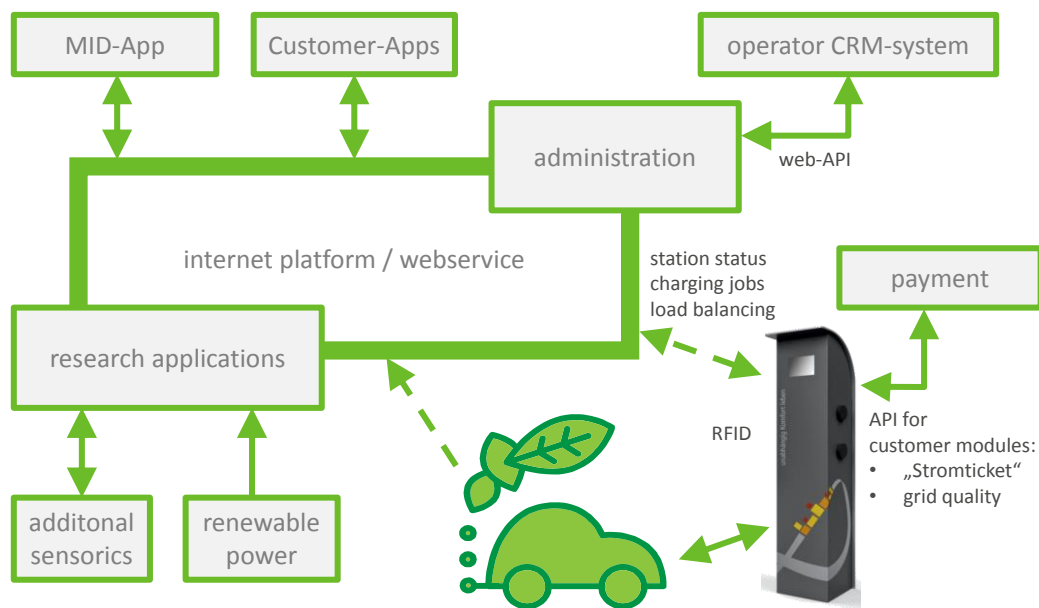

Fig. 3. easyCharge2 platform module

researchers can concentrate on their objectives. The system is made up out of four levels: internet platform, local management PC, PLC & communication devices and smart meters & scientific instrumentation.

The internet platform provides a monitoring and diagnostic interface. With this the users can view their present and historic charging jobs with detailed data like current and maximum power, charged energy and renewable share as well as status, i.e. 'finished'. Additionally they can change the current charging strategy.

The administration interface is designed to manage user clearance for stations with RFID, PIN or similar authentication. A Connection to the bigger electric mobility provider networks can be added on demand. The users and stations are managed in flexible groups, for example it is possible for User A to stop and unlock the charging of User B if they share the respective group. This is especially important for small vehicle fleets where employees of a certain department share a set of vehicles but should not 'play' with the vehicles of a different department.

The platform also runs regular housekeeping services like diagnostics and error reporting, email messaging the user on finished jobs or building statistics and forecast data, i.e. grid quality. Monitoring is set up to work for regular logging interval of one minute, faster is possible if performance and disk space are no issues.

For connectivity to external systems different Rest-Services are provided for user management and accounting, monitoring data acquisition as well as remote control and mobile device apps. Custom extensions can be plugged in either via Rest-Service or directly into the housekeeping sequence.

Within the charging station, the local controller software runs on an industrial PC platform with Linux Operating System. The software and graphical user interface can run fully offline. Synchronization of user management and historic data starts if connectivity to the server is established. Since remote access and updates of the software are of great importance in development projects, this can be easily done, without any

router configuration, by enabling the integrated tunneling option.

The local charging controller provides the customizable user interface (content and design) as well as authentication and management of the charging jobs. Depending on the strategy, the available renewable power, strength of grid connection and priority, the current for the different charging outlets is set.

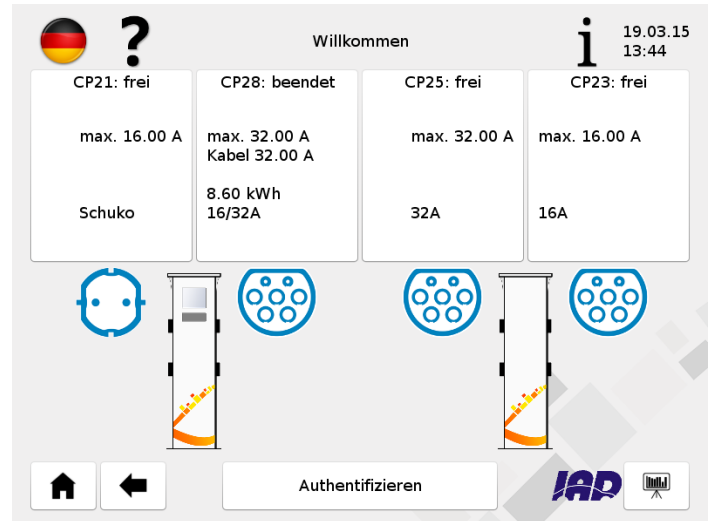

Fig. 4. Screenshot of the user interface (E-City-Routing charging station) as seen on the local touchscreen or in remote administration

Custom extensions can be installed either as standalone application in the Linux environment or as Java module directly within the charging controller. Additional options are the local webserver or enabling direct charging point control via Rest-Service. Since all controller and database (PostgreSQL) software is platform independent, the usage of Microsoft Windows as operating system is also possible.

The component level consists of the IEC vehicle communication devices (Phoenix Contact EV Charge Control), RFID module, motion sensor and smart meters measuring power, energy and phase currents. Optional PLC modules for

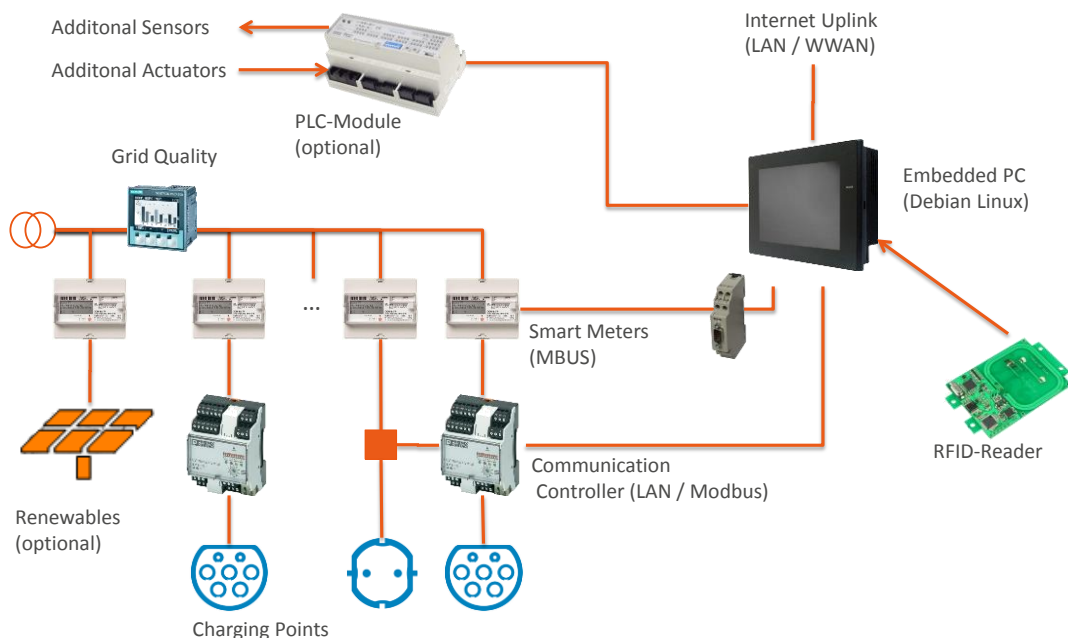

Fig. 5. System layout for a master-slave charging concept with a central control unit and several wallboxes [3]

additional digital and analog IOs as well as a grid quality monitor are available. The components communicate to the management pc via internal LAN or serial bus (MBUS).

The advantage of this modular structure is that the charging point configurations is flexible and can be configured to the project needs. Additionally it is possible to integrate custom modules at each level of the platform.

Currently outlets as earthed safety socket (DIN49440) or as EN 62196-2 (Mennekes) are supported. A special option is fuse switching, so 16 A cables as well as 32 A cables are safely supported at the same EN 62196-2 outlet.

### V. CHALLENGES TO CHARGING POWER MANAGEMENT

Distributing current available power to vehicles has several challenges with today's IEC 62196 outlets.

The actual task is easy: distributing available renewable power according to the user's wishes and their priority. Thus the allowed current for the vehicle is reduced so that PV power and grid renewable percentage together match the requested renewable share in the vehicle.

In a second step the limits for lateral line (there are other consumers in the building) and for the phase current (fuses) are evaluated. The resulting minimum phase current is communicated via PWM to the vehicle. With older vehicles this works as planned. Newer vehicles integrate more intelligence into their charger thus reacting unexpected.

Typical issues are:

- falling asleep after charging paused (open door or key-lock needed to awake)
- charging stop and restart needed to change allowed current

- large safety reserve between allowed and actual charging current, thus inhibiting an increase of the allowance by the power manager

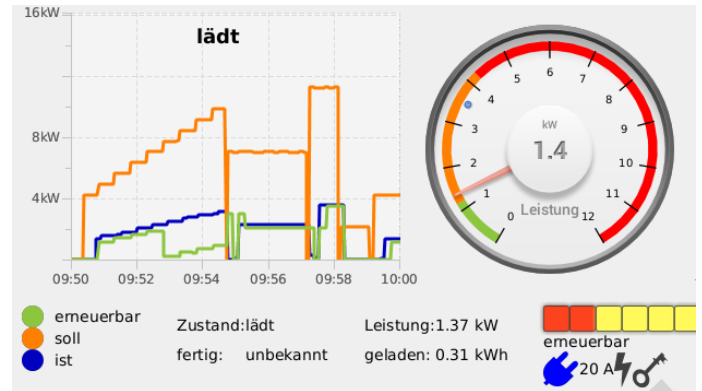

Fig. 6. Typical Test-Run of a on-phase Vehicle with the set current starting as a ramp and switching limits according to necessity

Another challenge is communication of one or three-phase charging. Without GreenPhy Communication only the actual measurement can tell the power controller. If a vehicle charges 32A one-phase it blocks full utilization of the line. Reason is here the potentially long reaction time of smart meters to detect a change.

Therefore we can only encourage manufactures to implement 15118 for AC charging as soon as possible.

### VI. MODELLING INFRASTRUCTURE INTERACTION

Modelling and simulation of the charging process as well as the surrounding power infrastructure is an important part of the research process. ICIRP connects to simulation models in different ways.

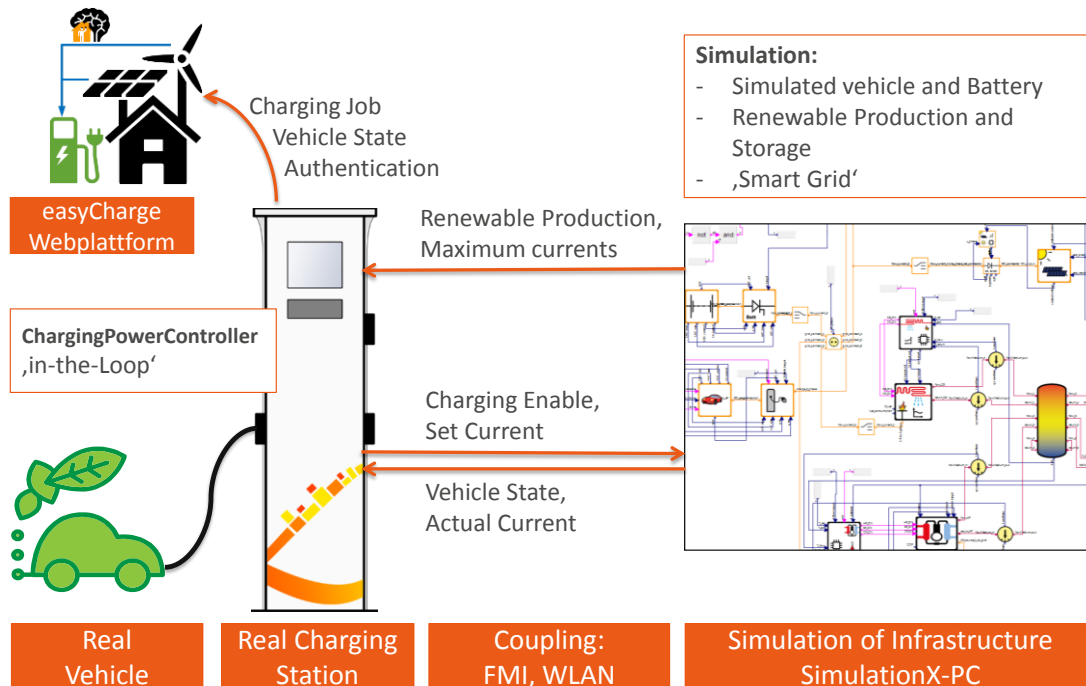

Fig. 7. FMI-connector overview: software under test and simulation model [2]

In the first step, charging algorithms were simulated using the SimulationX platform with Modelica models for vehicle and battery developed at the IAD Dresden as well as infrastructure and smart grid models taken from the Green Building Library developed by EA Systems.

In the simulation, the charging station control algorithm can be placed into a local grid, building energy system or an urban district. The setup is used for testing the interaction to other smart grid components like photovoltaic generators, combined heat and power units, heat pumps, battery storage or user behavior. This is especially interesting if the peak power from the grid is limited or if other controllers, like a central energy manager, interact with the charging station. A typical example is a situation where surplus power could be used either for faster charging or for the heat pump (Power2Heat storage).

In the second step the implemented controller hardware and software can be tested in the Loop (XiL) at the same infrastructure model. For this a connector library based on the FMI co-simulation standard was used. This tool generates a Java library for the software under test well as an FMU which is imported into the simulation environment. The two are connected by a transparent network interface, so controller and simulation can run on different platforms.

In the third step the acquired monitoring data from the charging processes can be used to improve the models.

## VII. CONCLUSION AND FUTURE WORK

Additional research and pilot projects considering infrastructure impact of electric mobility is important in for the future mass roll-out of vehicles.

The presented tools: charging station research platform and modelica infrastructure simulation help to assess possible solutions in current mobility research projects at Dresden Technical University as well as different pilot projects. The modular system can be extended for the individual project needs.

Current development addresses extensions of the Smart-Grid-Library and a simplified simulator interface to make modeling and test even easier.

On the platform side research focuses on new charging algorithms integrating model predictive control for higher renewable energy share and reduction of grid asymmetry. To address a wider variety of projects drivers for additional communication controllers / wallboxes are currently implemented.

## VIII. REFERENCES

- [1] Unger, R., et al. ., 2014, EA EnergieArchitektur GmbH, final project report „Wohnen und Mobilität“
- [2] EA Systems Dresden, ITI GmbH, information material FMI Manager
- [3] Trademarks according to manufacturers, Berg, Siemens, Phoenix Contact, SYS TEC electronic, Solvimus, hematec