

# Smart Modules for Lighting System Applications and Power Quality Measurements.

Milena F. Pinto, Guilherme M. Soares, Thiago R. F. Mendonça, Pedro S. Almeida, Henrique A. C. Braga

Electrical Engineering Department  
Federal University of Juiz de Fora, UFJF  
Juiz de Fora, Brazil.

milena.faria@engenharia.ufjf.br, henrique.braga@ufjf.edu.br

**Abstract**—Smart lighting applications are designed to provide management and control of the whole interconnected system, ensuring reliability, cost saving and high efficiency. In this work is proposed a simple intelligent module to be connected in the street lighting system in order to simultaneously control and measure the lamp's parameters. All the data transmission procedure was developed based on the mesh network topology. By taking advantage of the communication structure used for the smart lighting system and coupling sensors to the module, it's possible to gather data regarding the power grid as well. Moreover, for experiments purposes, it was also developed a specific driver capable to communicate by DALI protocol in order to receive and send information from the smart module to the lamp. The results have proven the efficiency, flexibility and interoperability of the proposed smart device.

**Keywords** – Intelligent lighting, Smart Module, Street Lighting System.

## I. INTRODUCTION

According to [1], almost all street lighting systems are designed using obsolete techniques and equipment, for instance, in Europe, they were approximately installed over 30 years ago [2]. However, due to the advent of new technologies, developed in recent years, the usage of certain devices that allow control, management and measurement by an intelligent service in order to provide reliability, cost saving and high efficiency of street lighting system are increasing. Furthermore, the street lighting system are the main assets to maintain the security in homes and road environments, people's wellbeing and cities appearance features, expressing the importance of their research [3].

Moreover, the intelligent street lighting equipment could provide others benefits, such as adaptive dimming, allowing to vary the light intensity of the lamp in accordance with time, weather or just by detection of pedestrians at night. Thereby, this system requires a luminaire that offers flexibility for dimming and high efficiency. Within this context, the LED technology is being presented as a better alternative in street light systems, because it also provides low power consumption, low environment impact and long life-span [4]. Additionally, LED technologies are growing continuously as can be seen in [18], which discusses a high-brightness LED module to meet street lighting applications requirements.

As can be seen in [7], most of street lighting systems do not contain a communication network. Thus, useful information, such as energy consumption, luminaire status (i.e. dimming and defective lamps), and others reports cannot be easily obtained, which causes a misconceived financial planning when the taxes are performed and maintenance problems.

When smart lighting systems are connected with smart features, it's possible to add communication abilities, enabling the on-time data transmission to provide information about fault tolerance, energy consumption and to send commands to accomplish dimming remotely [6].

In this way, in this paper is proposed a modular smart device to be connected in any lighting system, capable of controlling and managing the lamp's parameters. They can be also joined to the power grid to measure the power quality parameters, using the communication structure already built to maximize the relation of cost saving and quality management, offering a useful tool for electricity distribution companies. This smart module, referred in this paper as SM, is easily installed and able to determine if the problem is due to the power grid or the luminaire, turning the maintenance problem easy to be solved.

This paper is organized as follows. Section II presents the related works regarding smart lighting systems. It is shown

in Section III a detailed description of the proposed device. Finally, in Sections IV and V are given the results and conclusions of this work, respectively.

## II. RELATED WORKS

As stated in [9], an intelligent lighting system is a set of devices, such as sensors, controller computer, lighting fixtures, transceivers and energy meter connected along network and has automated capabilities beyond traditional lamps. For this reason, since the intelligent lighting system is installed all over a city, it is easy to measure and control the whole system using an autonomous algorithm.

Several smart technologies and methods were proposed with the aim to solve the inheriting issues of lighting systems. Moreover, these technologies comes to improve the usage of the available resources, i.e. dimming, consumption and status information [10-12].

Owing the fast development of devices that can be applied to the street lighting systems, several papers have been published regarding new techniques and devices to enhance the performance of lighting systems. For instance, to reduce the energy consumption of the public lighting and at the same time increase the power efficiency and lighting quality level, in [19] is presented an advanced control system. Whereas for the communication of the lighting modules, in [20] is explained the development of an electronic system using ZigBee module with DALI protocol to send and receive commands. As can be seen, there are many works that proposes equipment or even algorithms for street lighting applications. Although, they are separated works, all have the same purpose and could be integrated in one smart module to be coupled to the street lighting system.

The present paper has the intention to apply known approaches for street lighting system, once few works proposed devices that resort all the described features, i.e., devices that can supervise the street lighting system and gather information from the power grid. Within this context, in the following section is described the concept of the new proposed equipment to be connected between power line and luminaire, measuring and managing the issues related to the both power grid and lamp system.

## III. CONCEPT OF THE PROPOSED SYSTEM

The concept of the proposed system consists of a smart module (SM), a control module (CM) and a supervisory center. In Figure 1 is shown the SM integrated in a lamppost (numbers 2, 3 and 4) and CM (number 1) installed in the street. Each lamppost contains a SM that is responsible to gather the data concerning power grid and the luminaire parameters. There is one CM for a group of lamps, ensuring their management control. The spatial arrangement in a fictional neighborhood of the proposed concept can be seen in the Figure 2. The SM is represented

by a black dot and their information is sent to respective CM (yellow square) that process the received data and send it to the supervisory center, represented by red rhombus.

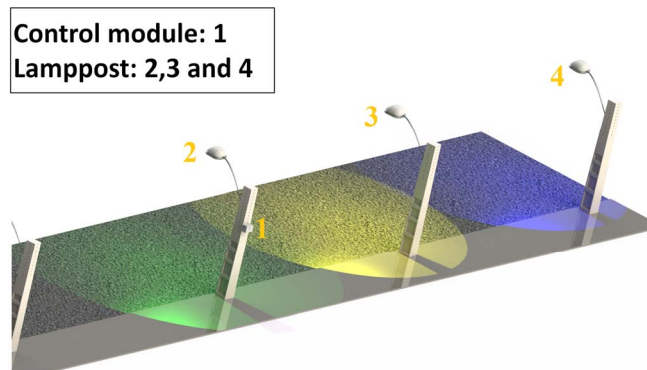

Figure 1. Concept of the proposed system installed in street.

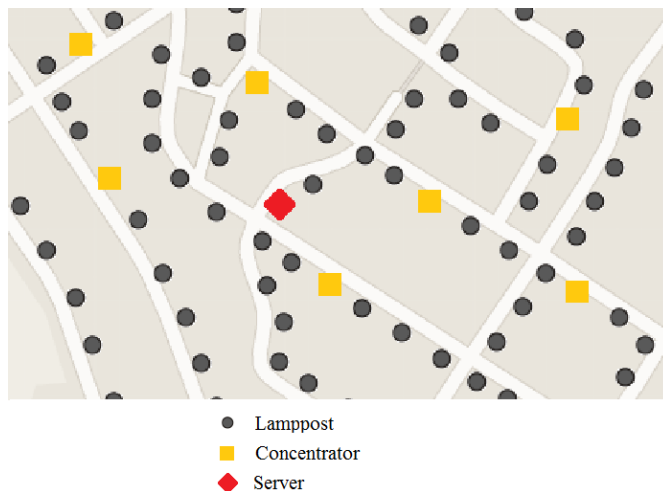

Figure 2. Spatial arrangement in a fictional neighborhood using the proposed concept.

### A. Smart Module (SM) and Luminaire

The schematic of the SM is presented in Figure 3. This equipment is able to manage and operate the luminaire as well as provide communication with the CM. Moreover, each SM contains a real time clock to provide time synchronization between sensors and network, an auxiliary power supply with backup battery in order to ensure an uninterrupted isolated power source, an USB programming and a control interface to offer control signal for the luminaire and gather the sensors data.

Besides the basic system, there are sensors coupled to the grid in order to measure the parameters of power line, providing useful information for electricity distribution companies. These data analysis are performed in the CM, which will store and upload to the supervisory system. Note that each module is connected to one phase of the power

grid, acquiring voltage information. The next luminaire is powered by another phase and so on, allowing monophasic power quality analysis. The representation of the equipment installed in the luminaire is shown in Figure 4. The number 1 is the battery and numbers 2 and 3 are the SM and the lamp driver, respectively.

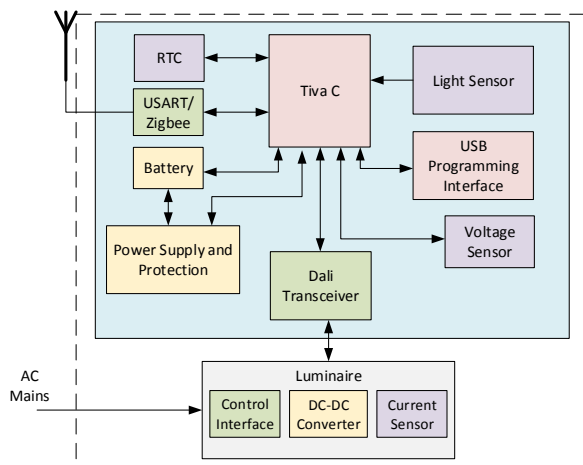

Figure 3. Schematic of the luminaire and smart module (SM).

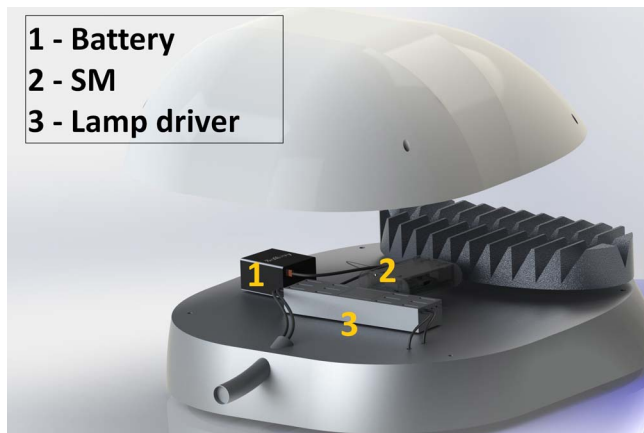

Figure 4. Schematic of the equipment connect into the luminaire system.

The acquisition device uses an Texas ARM microcontroller TM4C123GH6PM [21] operating at 80MHz, once this processor provide interfaces to most used communication protocols, such as I2C, UART, CAN and SP. In addition, several ADC Chanel's are available making possible to read and control most of sensors and others devices. The USB programming interface permits a fast and reliable diagnose and update the software. This allows, in case of equipment failure, easier maintenance of the system, once it is compatible with almost any modern computer.

Additionally, a battery was installed on the SM, permitting diagnostic and communication even when the power grid is down in some street, ensuring uninterrupted work and warn the supervisory system about the fault

locality. The system was designed to operate at least for two hours without the main power source.

The algorithm in the SM equipment is responsible to gather data from sensors and generate the control signals to the power converter. The algorithm can use several different parameters to determine the dimming level. The traditional system will just use information about the amount of light to define the instant to power on and off the lights. Whereas, using intelligent control, it is also possible to provide dimming when street stays empty through remotely operation or others strategies.

The communication between SM/SM and SM/CM is performed over ZigBee interface, which can connect over 65000 nodes. Another advantage is that has low data transmission rates, low power consumption and low cost [14]. It was used 802.15.4 ZigBee in P2P connection. This physical topology allows the construction of mesh topologies without hard configuration on each luminaire. This is an important requirement, because people without specific training should be able to install the system. It is desirable plug and play modules to ensure the installation and maintenance as simple as possible.

Moreover, the communication between the SM and luminaire is accomplished by DALI data frame, which is an acronym for Digital Addressable Lighting Interface. This standard was firstly introduced in the project NumeLite [13] for street lighting applications.

It is also presented in Figure 3 the schematic of the specific luminaire that will be used to perform the experiments using the proposed SM, which acquires data from the voltage and current sensors to produce the control signal for the luminaire driver. The DC-DC converter drives the LEDs, allowing dimming and intelligent control. It was used a single-stage Ćuk converter operating in discontinuous conduction mode for power factor correction and power control proposed in [15]. As shown in [15], even using a single-stage converter it was possible to avoid the undesirable electrolytic capacitors, which drawbacks are listed in [16].

### B. Control Module (CM)

In Figure 5 is shown the control module. This equipment contains an ethernet interface to allow data exchange with the supervisory system, several sensors to gather local information about the environment and the weather, a memory card to store data from the multiple luminaires, a ZigBee interface to communicate with multiples SM system and a battery to provide continuous service despite power grid failures.

The humidity and temperature sensors are useful for thermal mapping of the cities. In this way, measurements can be validated, once noise can be inserted with unusual weather conditions, e.g. if is raining, possible electric discharges may corrupted the data or even interfere in the communication process. Furthermore, it also be useful for geographic and weather aspects.

The GPS system is responsible to synchronize the programmed clock between the CMs devices, providing a reliable time reference. The control modules work as a time server for luminaires, once they use the same clock reference. The GPS also allows the CMs geographic localization, enabling the maintenance management of the system.

The Ethernet interface ensures the possibility of data synchronization between the control modules and supervisory system. This information includes luminaires control signal, i.e. dimming, power on and off and the system data measurement as well.

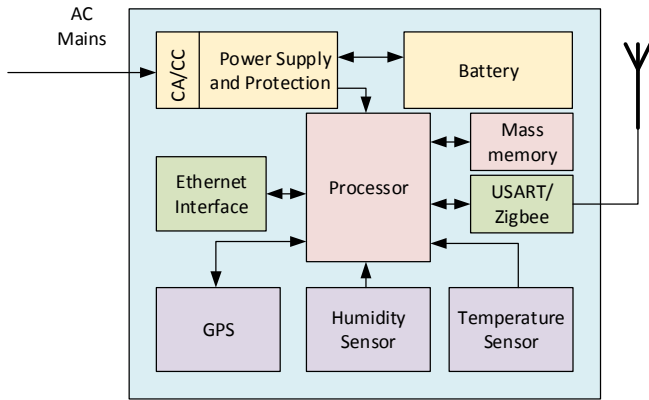

Figure 5. Schematic of the control module (CM).

C. Server

All the acquired information received from the previously discussed modules demands high computational effort as well as huge memory capacity for data storage. Since SM and CM do not have the requirements to accomplish this task, it was developed a software to manage and process the information.

The program was implemented in C sharp (C#) language [17] and it has three main tabs: start, luminaire control, energy quality parameters, as can be seen in Figure 6. Besides, there are buttons to connect and disconnect the respective system (CM and SM) and to synchronize them. Using this manager software, in Figure 8 is possible to analyze the events and disturbances information stemmed from the power quality monitoring system. The dimming functionality has the aim to afford an automatic control of the light intensity in relation to pre-programmed reference curve, as shown in Figure 7.

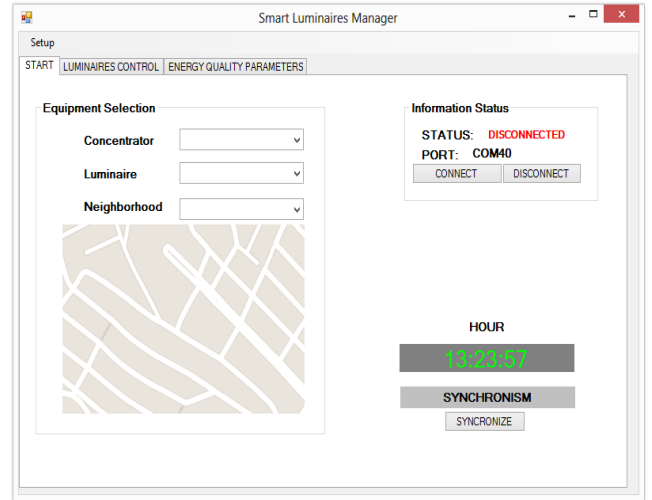

Figure 6. Main screen tab of the management software.

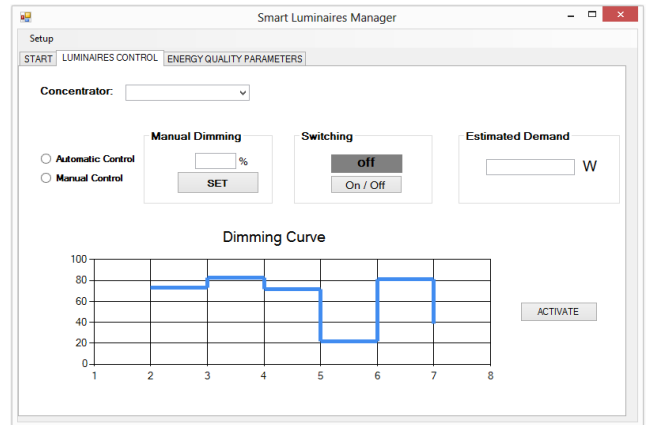

Figure 7. Luminaires control tab of the management software.

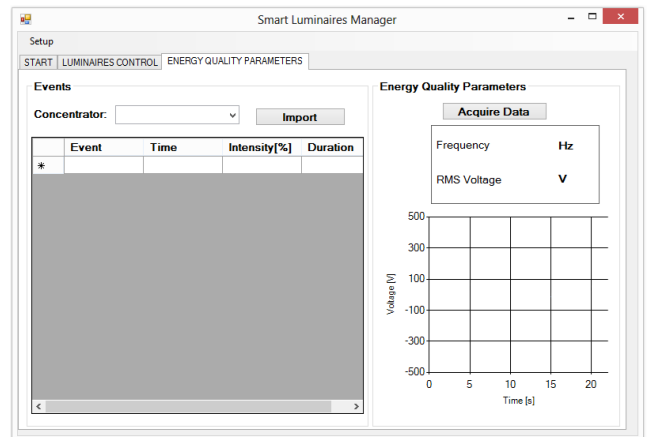

Figure 8. Energy quality tab of the management software.

#### IV. EXPERIMENTAL RESULTS

In this section is described the experiments concerning the development of the luminaire and the smart module. The control module and the supervisory system are under development. Thus, their experiments results will not be shown, leaving for future works. In this way, the first item consists of the driver analysis in relation to its electric parameters and luminaire characteristics. Whereas the second item provides the results regarding the power quality analysis and the dimming commands.

##### A. Luminaire

The LED module used in the experiments can be seen in the Figure 9, which has 56 LEDs developed by Epileds and it is arranged in two aluminum heatsinks with 28 LED in each. The parameters of the LED array unit are verified in Table I.

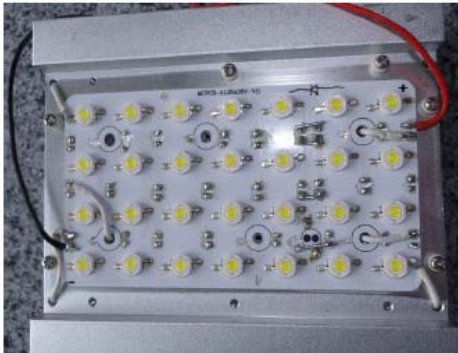

Figure 9. LED array unity.

TABLE I. LED ARRAY PARAMETERS.

Parameter	Value
Average current	349.2 mA
Average voltage	179.36 V
Luminous flux	3226 lm
Power	62.63 W
Efficiency	51.5 lm/W

Concerning the LED driver, it was developed the converter showed in Figure 10 and it was used the parameters described in the Table II.

TABLE II. LED DRIVER PARAMETERS.

Parameter	Value
Nominal input voltage	220 V
Dimming frequency	50 Hz
Line frequency	60 Hz
Switching frequency of the converter	50 Hz
Minimum average current	70 mA (20%)

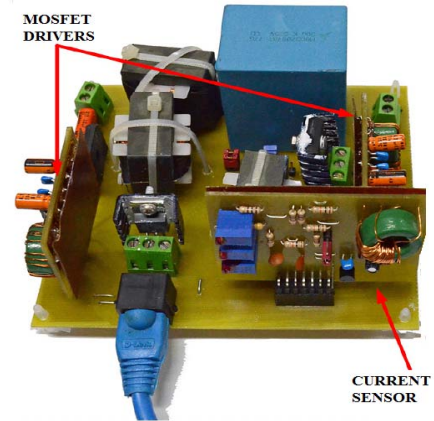

Figure 10. DC-DC converter.

Several luminaire operation parameters were analyzed, such as power factor, electrical efficiency and harmonic distortion, among others. The luminaire project was accomplished to comprise the IEC regulations as IEC 61000-3-2 [8]. The power factor (PF) represents an important aspect of the luminaire operation. In this way, Figure 11 presents the relation between the dimming process and power factor. Utilizing the luminaire in nominal load, it was observed a PF over 92% in all operation range, considering above 30% of dimming.

Since street luminaires are going to be used during 8 to 12 hours every day, the electrical efficiency represents an important aspect of the module, being important to the economic evaluation. Figure 12 shows the efficiency in relation of the dimming level. It is possible to observe that the efficiency overhauls 90% for all operation range, considering above 20% of dimming.

The harmonic analysis over the input current was also performed, as shown in Figure 13. It was verified a low harmonic content compatible with IEC regulations, which improves the life span of several equipment.

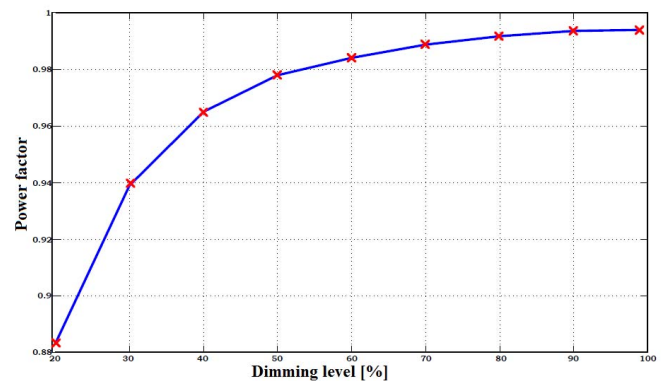

Figure 11. Relation between dimming and power factor.

In order to test the automatic dimming functionality, it was performed a comparison between the programmed curve and the output average current, as shown in Figure 16. The present results indicate the driver proper operation.



In Table presents the performance of sags and swells detector system. It is observed that the events of the energy quality monitoring system (EQMS) meets the requirements reviews for Class B equipment of IEC 61000-4-30 standard [5].

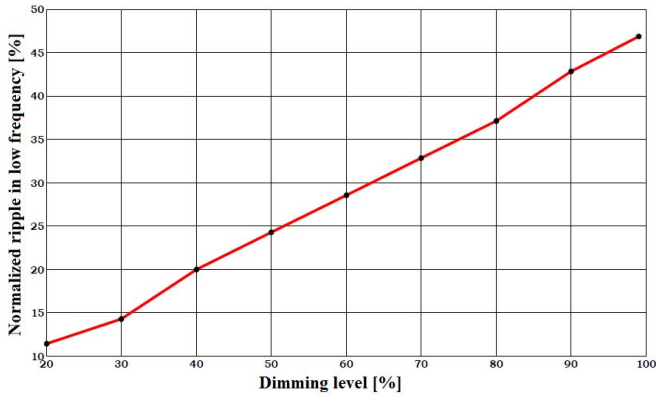

Figure 12. Efficiency vs. dimming level.

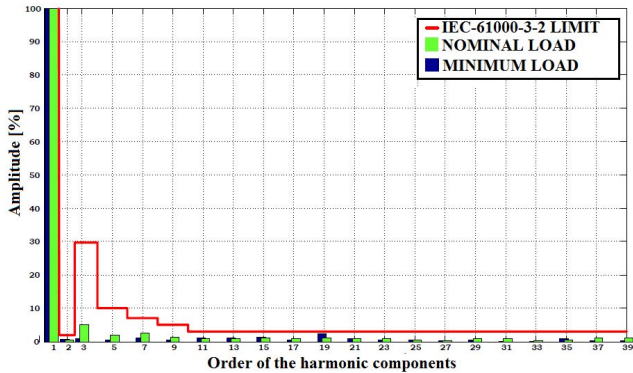

Figure 13. Total distortion harmonic.

**B. Smart module**

There are three main results in this item. The first one is the management software, presented in Figure 6 to 8, which provides a human interface to the operator. The second is the dimming command and control capability. And the last aspect is the electrical analysis application. The SM device is presented in Figure 14. As can be seen, the module has an interface to connect with the voltage sensor, Figure 15, as described in previously section.

In Figure 16(a) is shown the pre-programmed dimming curve stemming of the control software and, in the Figure 16(b), it is presented the output current. It is noticed that the output current follows the control reference, satisfactorily.



Figure 14. Smart module.

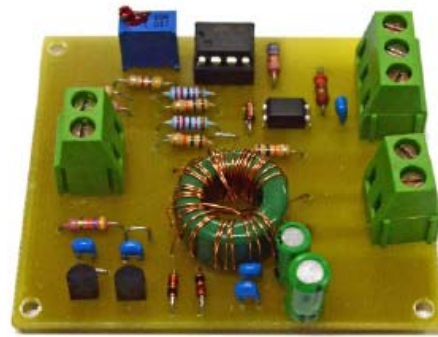

Figure 15. Voltage sensor.

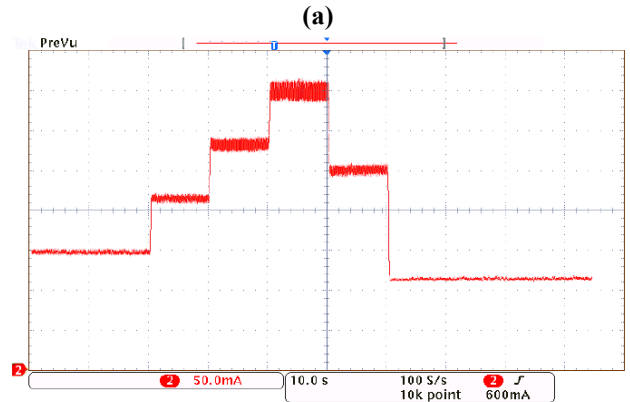
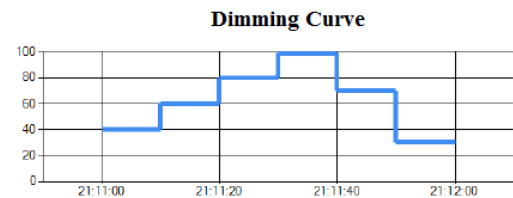

Figure 16. (a) Dimming curve programmed in software. (b) Average output current (CH2 - 50 mA / div) during the execution of the desired curve. Time scale: 10 s/div.

The system was able to detect the energy problems in the operator network successfully. In this way, it is required proper sampling, detection abilities and required processing to control the DC-DC converter. The Figure 17(a) and Figure 17(b) present a voltage SAG detection by the supervisory system as well as the input voltage and output current of the controller in the same event.

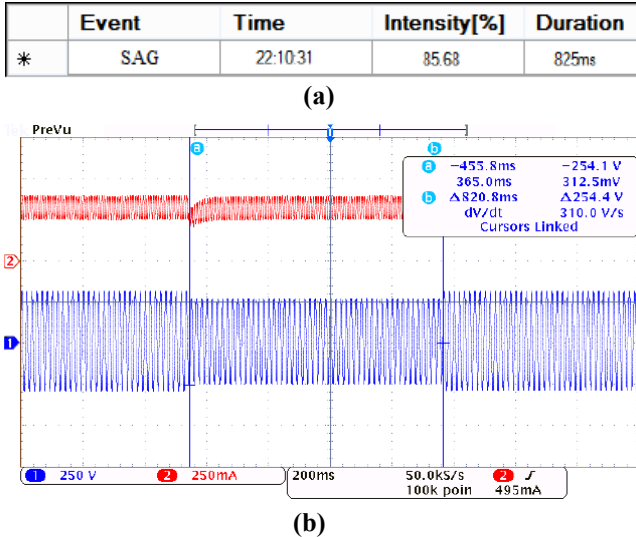

Figure 17. (a) Software screen indicating the characteristics about the respective event. (b) Input voltage (CH1 – 250 V/div) and output current (CH2 -250 mA/div) during a SAG event. Time scale: 200 ms/div.

The Figure 18(a) shows the event detection for overvoltage. The supervisory measures two compounds that provide quick analysis to the operator, the duration and intensity of the event. The Figure 18(b) shows the input voltage and the output current for this condition.

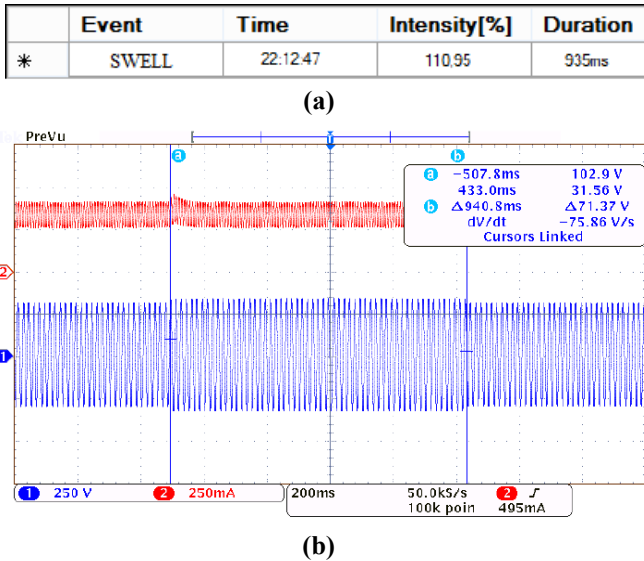

Figure 18. (a) Software screen indicating the characteristics about the respective event. (b) Input voltage (CH1 – 250 V/div) and output current (CH2 -250 mA/div) during a SWELL event. Time scale: 200 ms/div.

In order to measure the system accuracy during an event detection, it was computed the algorithm results over few detection conditions. The real values and the detected ones are presented in Table III. As can be seen, the events were measured with a good correlation, which proves the system efficiency.

TABLE III. COMPARISON BETWEEN THE EQMS ESTIMATED VALUES AND THE MEASURED ONES.

Event		SAG	SWEEL
Sinking/Rising	Measured Value	85.68 %	110.9 %
	Expected Value	86.36 %	109.1 %
	Difference	-0.68 %	1.8% %
Duration	Measured Value	825 ms	935 ms
	Expected Value	820.8 ms	940.ms
	Difference	0.51 %	-0.62 %

The Figure 19 allows comparing the input voltage waveform of the converter with signal captured by EQMS. It is observed that the spectrums of the two waves are very similar, showing that the data obtained by the energy quality monitoring system can be used to perform analyzes concerning the power grid harmonic content.

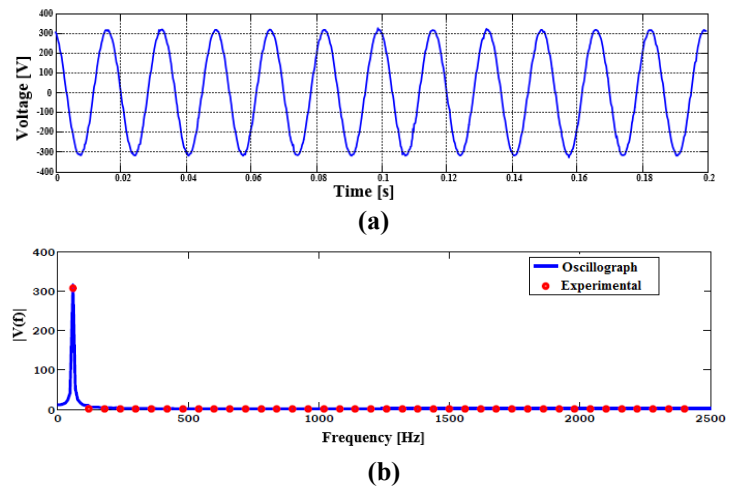

Figure 19. Comparison between the input voltage of the converter and the voltage measured by the oscillograph system module. (a) Input voltage. (b). Input voltage spectrum.

## V. CONCLUSION

This work has presented a brief review concerning the concept of the intelligent street lighting systems. Owing to the capabilities of control, measure and manage the lamps and the power quality parameters of the power grid, the

proposed system has shown as a powerful tool to be integrated in street lighting applications. Moreover, it is noticed that this prototype is technologically feasible and presents as a good alternative, due to the possibility to be connect with different devices, being susceptible to changes.

The DC-DC converter has performed properly the functions of rectification, presenting high power factor and accurate control of load power.

The energy quality monitoring system has shown a correctly detection of the sinking and rising voltage events at power grid. Furthermore, the waveform captured by the oscillograph module has presented suitable correspondence with the waveform of the DC-DC converter.

For future works, it is intended to integrate the whole proposed system, which includes the smart module, the control module and the supervisory system. Besides, it is also intended to validate their functionalities in streets.

#### ACKNOWLEDGMENT

Authors would like to thank the Federal University of Juiz de Fora, CAPES, FAPEMIG, INERGE, CNPq and the Brazilian Government for all financial, technical and scientific support on this work.

#### REFERENCES

- [1] F. Leccese, "Remote-Control System of High Efficiency and Intelligent Street Lighting Using a ZigBee Network of Devices and Sensors", IEEE TRANSACTIONS ON POWER DELIVERY, VOL. 28, NO. 1, JANUARY, 2013.
- [2] Intelligent Road and Street Lighting in Europe (E-Street), Grant Agreement: EIE/05/157/SI2.419662.
- [3] M. Castro, A. J. Jara and A. F. G. Skarmeta, "Smart Lighting solutions for Smart Cities", 27th International Conference on Advanced Information Networking and Applications Workshops, 2013.
- [4] F. Leccese and Z. Leonowicz, "Intelligent wireless street lighting system", 11th International Conference on Environment and Electrical Engineering, 2012.
- [5] IEC. IEC 61000-4-30: Electromagnetic compatibility (EMC) – Testing and measurement techniques – Power quality measurement methods. [S.l.]. 2003.
- [6] Smartgrid. Available at <http://www.smartgrids.eu/>, 2014 [7] G. W. Denardin, C.H. Barriquello, A. Campos, R. N. do Prado, "An intelligent system for street lighting monitoring and control", COBEP Power Electronics Conference, 2009.
- [8] IEC, "IEC 61000-3-2: Limits for harmonic current emissions (equipment input current < 16 A per phase)", 2005a.
- [9] Y. Kasahara, M. Miki and M. Yoshimi, "Preliminary Evaluation of the Intelligent Lighting System with Distributed Control Modules", 11th International Conference on Intelligent Systems Design and Applications, 2011.
- [10] M. A. G. de Brito, C. S. Ferreira, L. P. Sampaio and C. A. Canesin, "Automatic dimming multi-lamp fluorescent management system with active input power factor corrector stage." IET Power Electronics,
- [11] Y. K. Tan, T. P. Huynh, and Z. Wang, "Smart personal sensor in DC grid powered LED lighting system", IEEE Transactions on smart grid, vol. 4, no. 2, 2013.
- [12] Yun-gui Zhang, Li-na Zhao, Li-na Wang and Sheng-yong Zhang "A Web-based Management System for Urban Road Lighting", International conference on web informations systems and mining, 2010.
- [13] L. Guo, M. Eloholma, and L. Halonen, "Intelligent road lighting control systems – overview and case study", International Review of Electrical Engineering-IREE, vol. 2, pp. 14-20, 2007.
- [14] XBee™ ZNet 2.5 Datasheet. Available at <http://www.digi.com/products/wireless/zigbeemesh/xbee-zb-module.jsp>, 2013
- [15] G. M. SOARES, P.S. Almeida, D. P. Pinto, H.A.C. Braga, "A single-stage high efficiency long-life off-line LED driver based on the DCM Cuk converter. 38th Annual Conference on IEEE Industrial Electronics Society – IECON, 2012.
- [16] C. Rodriguez and G. A. J. Amaratunga, "Long-Lifetime Power Inverter for Photovoltaic." IEEE Transactions on Industrial Electronics, v. 55, 2008.
- [17] Microsoft, "C sharp language". Available at <http://msdn.microsoft.com/>, 2014.
- [18] X. Long, R. Liao and J. Zhou, "Development of street lighting system-based novel high-brightness LED modules", IET optoelectronics, vol.3, pp: 40-46, 2009.
- [19] H. Andrei, C. Cepisca, B. Dogaru-Ulieru, T. Ivanovici, L. Stancu and P. C. Andrei, "Measurement analysis of an advanced control system for reducing the energy consumption of public street lighting systems", IEEE Bucharest PowerTech, 2009.
- [20] S. C. Wang, Y. H. Liu, Y. L. Chen, and J. Y. Chen, "Development of DALI-based electronic ballast with energy saving control for ultraviolet lamps", 8th IEEE International Conference on Industrial Informatics, 2010.
- [21] Texas instruments incorporated. "ARM TM4C123GH6PM microcontroller", Available at <http://www.ti.com/lit/ds/symlink/tm4c123gh6pm.pdf>, 2014. .