

Probability-based durability design for the Western Scheldt Tunnel

Ch. Gehlen Technical University of Aachen, Germany

P. Schiessl Technical University of Munich, Germany

Developed in a European Brite-Euram research project, a new service life design concept for reinforced concrete structures has been established. This new concept allows the design of reinforced concrete structures for a defined lifetime related to limit state formulations. The result of the durability design is a limit state-based failure probability of the structure. This new design approach has been used for a bored tunnel construction in The Netherlands (the Westerschelde project). The whole construction consists of two different elements, the ramp and the bored tunnel itself (reinforced concrete and steel members). The tunnel has two tubes with an external diameter of 11.0 m and a length of 6.5 km. All elements have been designed according to the new performance-based durability design procedure.

Introduction

At present, design codes and guidelines include prescriptive requirements, to ensure sufficient durability of reinforced concrete structures. Prescriptive rules relating to environmental factors are given (maximum water/cement (w/c) ratio, minimum binder content, nominal concrete cover, etc.). Further rules (e.g. concerning curing, and air entrainment to avoid frost and freeze-deicing-salt deterioration) complete this type of durability design. An objective comparison between various options to improve durability as well as a limit state-related lifetime design is not possible.

As formulated by Bamforth,¹ a structural engineer would consider a code allowing only four loading regimes, each of which additionally being based on minimum dimensions, minimum concrete strength and minimum volume of steel, to be wholly inadequate.

Although the described prescriptive design approach would be unacceptable to a structural engineer, this type of approach is accepted for durability problems. Growing durability-related problems and damage to reinforced concrete structures in the past highlight the necessity of establishing not only a new performance-based durability design approach but also the need to integrate such a new approach into the standard procedures of structural design.

The following sections will clarify the new overall durability design concept for the quantitative determination of the lifetime of a structure. Based on this concept, a durability design example carried out within the Westerschelde project is presented.

Description of the new design concept

General

The general concept for durability design, which was introduced in its main features by an international expert group,² is sketched in Figure 1. Following the definition of the minimum required performance of the structure to be built, usually formulated by the investor, the supervising authority and the designer, the introduced concept allows various design strategies (basic defence strategies).

One option in the basic defence strategy is the total avoidance of the deterioration mechanism (strategy A). Strategy A can be subdivided into different possibilities. For example:

- A1 Change the environment (loading), e.g. by linings, membranes and coatings
- A2 Select non-reactive materials (infinite resistance), e.g. stainless steel or coated steel
- A3 Inhibit the reaction, e.g. cathodic protection or cathodic prevention.

Generally, a detailed design is necessary for the various options of strategy A. Strategy A can be successfully used to prevent frost attack (by providing an appropriate air void system) and sulfate attack (by using sulfate-resistant binders).

This paper will only deal with strategy B. Strategy B minimizes deterioration by optimal design and choice of materials. This strategy is used to prevent attack causing reinforcement corrosion. For structures or parts of a structure exposed to very aggressive

environmental conditions, multibarrier protection strategies are recommended. Such a strategy consists of:

- excellent concrete quality
- increased cover
- extra protection for the concrete or the reinforcement and/or
- provision for later extra protection should it become necessary.

These measures may be completed by monitoring of the structure, e.g. by installing sensors into the most sensitive parts of the structure.

The design of concrete quality and concrete cover may be done on different levels. For the majority of structures the 'macro-level' is sufficient. What is meant by 'macro-level' is the application of the prescriptive rules currently employed (specification of w/c ratio, cover thickness, etc.), though based on probabilistic models (refining these rules may be necessary).

For structures or parts of a structure exposed to aggressive environmental conditions and built for a long target service life (100 years or more), a 'meso-level' design is recommended. Based on simplified deterioration models, this level of design requires an adequate identification of the environmental loading, an adequate modelling of the prevailing transport mechanisms as well as performance tests, characterizing the material resistance to deterioration. In the following the durability design concept at the meso-level will be introduced. Finally, the basic information that has to be obtained in order to perform a complete probabilistic-based durability design will be listed.

Safety concept of a probabilistic design

Generally, design processes are based on the comparison of the resistance of the structure (the *R* variable) with the action or load (often called the *S* variable). Failure occurs when the resistance is lower than the load. Since the load on a construction as well as the resistance are sometimes highly variable, *S* and *R* cannot be compared in a deterministic way. The decision has to be based on maximum acceptable failure probabilities. The probability of failure, denoted p_f , describes the case when a variable resistance *R* is lower than a variable load *S*. This probability is required to be lower than the target probability of failure, p_{target} :

$$p\{failure\} = p_f = p\{R - S < 0\} < p_{target} \quad (1)$$

Fig. 2 Probabilistic performance based durability design, terms, safety concept

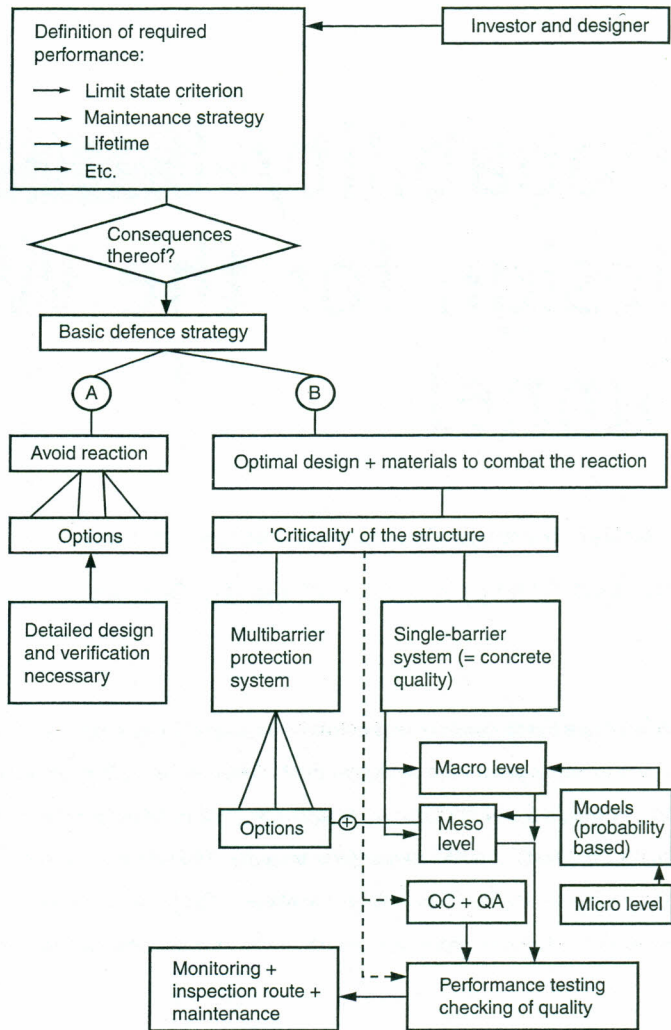
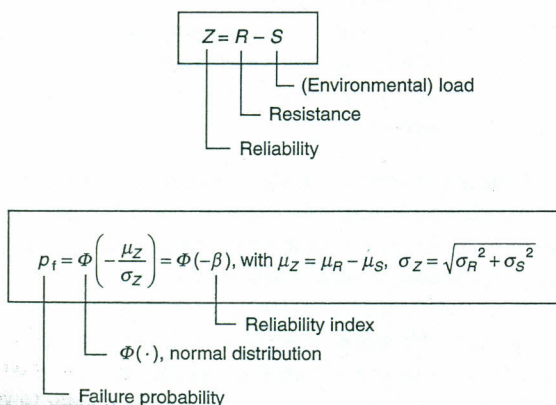

Fig. 1 Format of a model code for durability design²

For this kind of design problem, it is necessary to calculate the relevant probability of failure. Here the procedure of Basler³ using the notation of Cornell⁴ is advised. This procedure starts with the limit state function $Z = R - S$, and introduces the variables *R* and *S* to the equations including their averages and standard deviations. *Z* is the reliability of the construction. Assuming that the variables *S* and *R* are normally distributed, the reliability *Z*, the

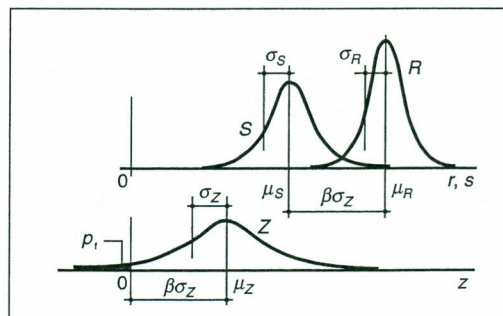

Table 1 Interrelation between failure probability and reliability index for a normally distributed reliability function

Reliability index β	Failure probability, p_f (%)
1.5	6.6807000
1.8	3.5930000
2.0	2.2750000
3.0	0.1349900
3.6	0.0159110
3.8	0.0072348

Table 2 Operational limit states

Limit state	Event	Reliability index, β_0
SLS	Onset of corrosion	1.5–1.8 (EC 1, NEN 6700, respectively)
SLS	Corrosion-induced spalling and corresponding failure in watertightness	2.0–3.0 (proposal)
ULS	Collapse of the structure	3.6–3.8 (NEN 6700, EC 1, respectively)

difference between the variables R and S , is a variable which itself is normally distributed. Averages and standard deviations of the parameters can be calculated according to the relationship given in Figure 2. The so-called reliability index β is also introduced in this figure. This index is often used for design purposes. The reliability index is calculated using the average and the standard deviation of Z : μ_z and σ_z , respectively. The reliability index is the difference between the mean values of R and S divided by the standard deviation of the variable Z or, alternatively, the mean value of Z divided by the standard deviation of Z .

For a normally distributed reliability function the relation between the failure probability p_f and the reliability index β is given in Table 1.

The procedure according to Basler³ can easily be transformed into a design equation. The design equation can be expressed as follows: $\beta \geq \beta_0$, where β_0 is the required safety level (reliability index).

Extension of the safety concept on a probabilistic basis

The general safety concept described here can rarely be applied in the aforementioned simple form. Extensions of the safety concept concern the transition from two variables to numerous variables, from linear functions to non-linear functions and from normal distributed variables to arbitrarily distributed variables. Extensions of these types do not allow manual calculations, so problems can only be solved by the use of computer programs (for example STRUREL,⁵ which was used for the design described in this paper).

Requirements for a lifetime design

To carry out a lifetime design the following information is required:

- (a) a global design model in combination with relevant deterioration models is necessary to describe the time-dependent development of the resistance R of the structure and the

environmental loading S

- (b) sensible and operational limit states have to be set up

- (c) the investor and the supervising authority have to define a maximum admissible failure probability (reliability index) related to the limit states formulated earlier

- (d) a target service life should be defined by the investor.

Design example: the Western Scheldt Tunnel

Construction and environmental loading

The cross-section and a longitudinal section of the bored tunnel are sketched in Figure 3. The bored tunnel, being located in chloride-contaminated soil, must be considered to be under chloride attack. The internal walls of the tunnel are subjected to the influence of carbonation and to chloride-contaminated salt fog and a splash environment (from road traffic). Leaking of joints will lead to chloride attack within the joints and, especially at points deep in the tunnel, at the internal surfaces of the lower half-circle elements. The service life design must be executed considering the environmental loading described above in order to prevent reinforcement corrosion.

Specification of performance and reliability levels

The service life of reinforced concrete structures depends on the length of two time periods:

- (a) the initiation period
(b) the propagation period.

The initiation period is defined as the time until the reinforcement is depassivated either by carbonation or by penetrating chlorides exceeding a critical chloride content. After depassivation, reinforcement corrosion becomes possible. Under certain circumstances (e.g. the availability of sufficient oxygen and moisture), reinforcement corrosion can take place, which will lead to a reduction of the reinforcement cross-section. Additionally, the formation of corrosion products may lead to a bursting pressure, causing visible cracks at the concrete surface and spalling of the concrete cover. This period is defined as the propagation period.

For each event, so-called limit states are applied (onset of corrosion, cracking, spalling, etc.). If a limit state-related failure leads only to economic consequences, serviceability limit states (SLSs) are applied (e.g. onset of corrosion). If failure leads to severe consequences (e.g. total loss of the structure or victims), ultimate limit states (ULSs) are applied (collapse due to overloading or due to excessive material degradation). Other intermediate stages may be defined by the investor mainly in order to reduce operating costs or repair (e.g. restricted leakage).

In Table 2 some values for the reliability index are given. As presented by Siemes and Rostam,⁶ these reliability indexes can also be used if lack of durability leads to an event resulting in an unacceptable loss of serviceability or loss of structural safety.

This paper will present only an SLS design. The design target is to restrict the probability of the event 'onset of corrosion'. In this paper only internal surfaces of the tunnel segments are considered, giving an answer to the following question: 'What is the required material resistance against chloride penetration in combination with which the concrete cover x_c will fulfil the investors' requirement: $t_{\text{service life}} = 100$ years with a minimum reliability index of $\beta_{0,\text{SLS}} \geq 1.50-1.80$ '?

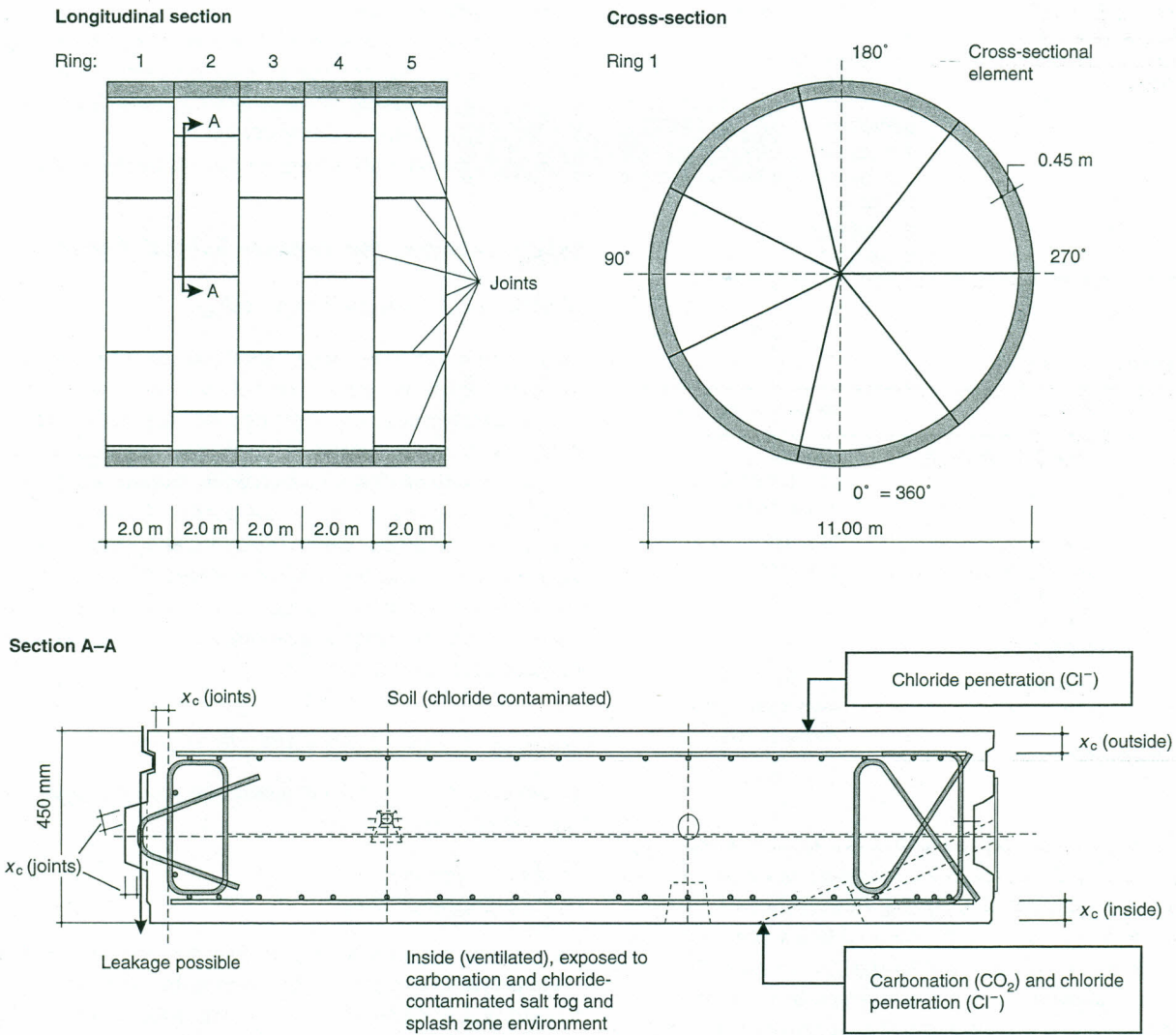

Fig. 3 Geometry of the bored tunnel under the Western Scheldt

Deterioration models

The internal surface of the lower half-circle elements at points deep in the tunnel is identified being the most critical detail. Internal surfaces are exposed to frequently changing chloride-contaminated solutions from various sources (leakage of joints, deicing salts). Due to the assumed high humidity, the rate of carbonation is assumed to be negligibly low. Consequently, chloride-induced corrosion is identified as the relevant deterioration mechanism. To describe the initiation period until the onset of corrosion, a deterioration model is required.

The following deterioration model describes the time-dependent diffusion-controlled penetration of chlorides, allowing the time to the onset of reinforcement corrosion to be calculated. The suggested model for predicting the initiation period in the case of chloride-induced reinforcement corrosion has been identified as an operational model by Alisa *et al.*⁷ from an intensive literature research carried out within the Brite-Euram project DuraCrete. This is defined by

$$x(t) = 2C_{(crit)} \sqrt{k_t D_{RCM,0} k_e k_c \left(\frac{t_0}{t}\right)^n t} \quad (2)$$

where

$$k_t D_{RCM,0} = D_0 \quad (3)$$

$$C_{(crit)} = \text{erf}^{-1} \left(1 - \frac{C_{crit}}{C_{SN}} \right) \quad (4)$$

where x_c is the concrete cover (mm); D_0 is the effective chloride diffusion coefficient under defined compaction, curing and environmental conditions, measured at time t_0 (m^2/s); $D_{RCM,0}$ is the chloride migration coefficient under defined compaction, curing and environmental conditions, measured at time t_0 in (m^2/s); C_{crit} is the chloride threshold level (wt% Cl⁻/binder); n is a factor which takes the influence of age on measured material property into account (dimensionless); k_t is a constant which transforms the measured chloride migration coefficient $D_{RCM,0}$ into a chloride diffusion coefficient D_0 (dimensionless); k_e is a constant which considers the influence of environment on D_0 (dimensionless); k_c is a constant which considers the influence of curing on D_0 (dimensionless); erf^{-1} is the inverse of the error function; C_{SN} is the surface chloride level (wt% Cl⁻/binder); t is the exposure period (years); and t_0 is the reference period (years), in this case 28 days.

Statistical quantities

As mentioned above, statistical information is required to perform the probabilistic-based service life design. The corresponding

Table 3 List of stochastic variables influencing the duration of the initiation period

Variable No.	Parameter	Units	μ	σ	Distribution type
1	x_c : concrete cover	mm	50	5	Beta distribution ^a
2	$D_{RCM,0}$: Cl ⁻ migration coefficient	10 ⁻¹² m ² /s	4.75	0.71	Normal distribution
3	C_{crit} : Critical Cl ⁻ content	wt%/binder	0.70	0.10	Normal distribution
4	n : age exponent	—	0.60	0.07	Normal distribution
5	k_t : factor test	—	0.85	0.20	Normal distribution
6	k_e : factor environment	—	1.00	0.10	Normal distribution
7	k_c : factor execution	—	1.00	0.10	Normal distribution
8	C_{SN} : Cl ⁻ concentration at concrete surface	wt%/binder	4.00	0.50	Normal distribution
9	t_0 : reference time	years	0.0767	—	Deterministic

^a $a = 0 \text{ mm} \leq x_c \leq 225 \text{ mm} = b$

statistical quantities of the variables are given in Table 3. The variables to be considered are obtained from Equation (2) and Equation (4).

In the following it will be shown how each distribution function was obtained for the first three listed stochastic variables (concrete cover, x_c ; chloride migration coefficient, $D_{RCM,0}$; critical chloride content, C_{crit}).

Concrete cover, x_c . During production of the circular tunnel segments (precast elements), precise installation of the concrete cover is possible. The reinforcement should be embedded with a nominal value of $x_c = 50 \text{ mm}$. The geometrical variable concrete cover is introduced as a beta distribution (in order to exclude negative covers and covers larger than the half of the elements thickness) with a relatively low standard deviation (precise production conditions).

Chloride migration coefficient, $D_{RCM,0}$. For design purposes an important starting measure is the material resistance, when focusing on the expected deterioration processes. Suitable results may be drawn from the literature for use as starting parameters in a service life design calculation. When working with special concrete mixes with very low water/binder ratios and high contents of plasticizer, quantitative results from the literature are not available. Therefore, it is essential to determine the efficiency of the materials to be used through basic tests, e.g. in order to identify the suitability of the designed concrete mix. In this context the decisive material resistance is the chloride diffusion coefficient.

The determination of chloride diffusion coefficients is a complex and time-consuming procedure. In practice, chloride penetration into concrete structures follows a non-steady state process. The conventional method of determination is to immerse concrete specimens in chloride-contaminated solutions at constant chloride con-

centrations. After immersion the chloride profile is determined by taking samples from the exposed surface and by analysing the total chloride content in each sample. The chloride diffusion coefficient can be found from Fick's second law by curve fitting. This procedure is very time-consuming. In order to prepare a meso-level durability design, the measured material performance should be known as soon as possible in the design phase. Among different rapid test methods, the rapid chloride migration (RCM) method was revealed to be theoretically the clearest, experimentally the most simple and with regard to precision (repeatability) the most promising tool.⁸ Diffusivity data measured with conventional immersion methods correlate well to data determined with the RCM method.^{8,9} The measurement procedure is described by Gehlen and Ludwig.⁸ For this project, different concrete mixes were tested under laboratory conditions at the reference time t_0 , and the determined properties of the chosen concrete are defined by the average and standard deviation in Table 3 (variable 2).

In addition to the measured performance at time t_0 , substantial differences in the time-dependent development of the resistance of the material have to be considered.^{10,11} The increase in the resistance of the material, expressed by the reduction of the chloride diffusion coefficient, is indicated by the age exponent n (variable 4 in Table 3). Typical values of n for different concretes are given by Siemes *et al.*¹⁰ and Bamforth.¹¹

Critical corrosion-inducing chloride content, C_{crit} . From the Design Guide of the Comité Euro-International du Béton (CEB) for durable reinforced concrete structures of 1989 the relationship between the critical chloride content depending on the moisture content of concrete and the quality of the concrete cover is as illustrated in Figure 4.¹²

Since for permanently dry or permanently water-saturated concrete practically no reinforcement corrosion is possible, higher values for the critical chloride content can be allowed under these conditions. The lowest value for the critical chloride content appears under permanently moist or alternating environmental conditions. In the case of large concrete cover and good concrete quality, which will be basically obtained by a low w/c ratio and

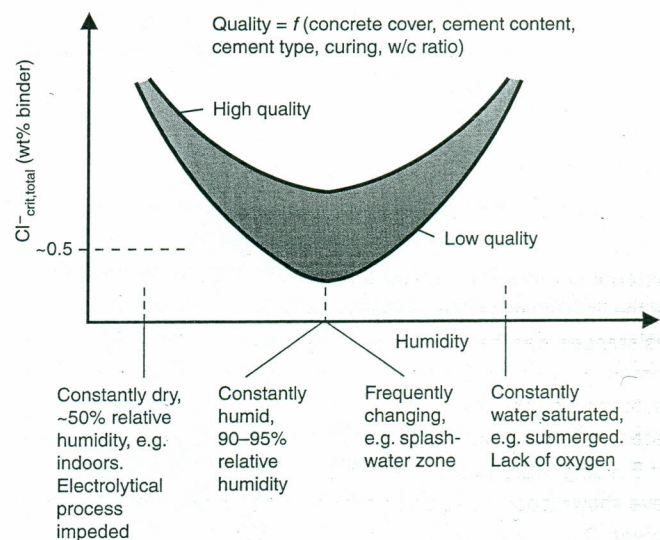
Fig. 4 Relationship between the critical chloride content in different environmental conditions and the quality of concrete cover¹²

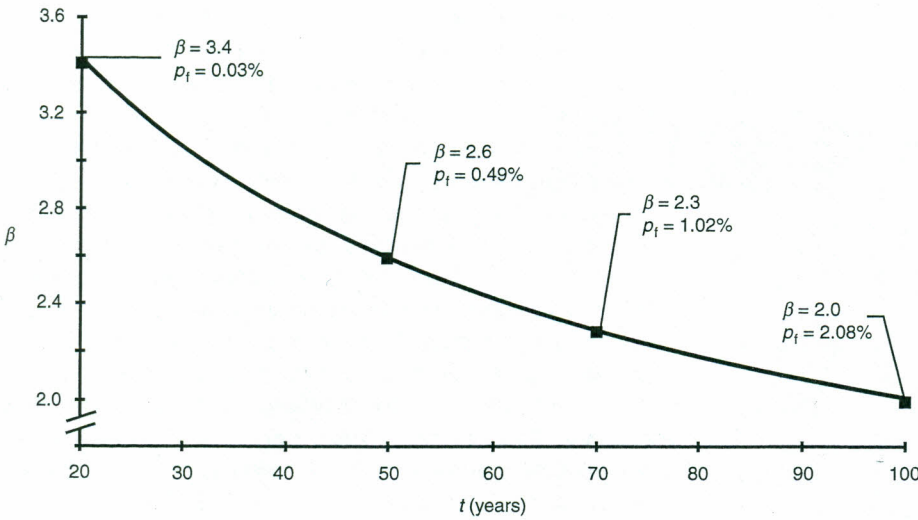

Fig. 5 Reliability index versus time of exposure (SLS: depassivation of the reinforcing steel)

suitable curing of the concrete, higher critical chloride contents can be permitted compared with low or insufficient quality of the concrete cover.

The required statistical values for C_{crit} can be taken from the results of the investigations of Breit.¹³ In this investigation, critical threshold values for the chloride content were determined for various mortar mixtures. Considering the results of the various mixes as a whole, the surveys by Breit suggest that the introduction of critical corrosion-inducing chloride content can be taken as a normally distributed stochastic variable ($\mu = 0.48$, $\sigma = 0.15$).

Making use of only one mixture, which will presumably cause a decrease in variation, and taking into account higher concrete covers, one can estimate higher averages, due to increased concrete cover, and lower standard deviations (Table 3, variable 3).

Results

With the evaluated data it is possible to calculate whether the stochastic variable x_c , which was applied in the design (Table 3, variable 1), is sufficient to ensure a serviceability limit state-related minimum life of $t_{service\ life} = 100$ years. The results of the evaluation are shown in Figure 5.

With increasing time the failure probability p_f increases, which corresponds with a decrease in β . Nevertheless, Figure 5 shows that the tested material in combination with the planned concrete cover is able to achieve a durable structure in relation to chloride-induced steel corrosion with the required safety according to the serviceability limit state fixed earlier. The obtained reliability index at $t_{service\ life} = 100$ years is $\beta_{SLS} = 2.0$, which is above the required range of $\beta_{0,SLS} = 1.5-1.8$.

Quality control

The quality level achieved in the laboratory must be reached on the construction site as well, since the quality of the built-in material determines the service life of the construction. Criteria for the final examination (acceptance criteria) of the tested material resistances can be determined following EC1, Appendix D. The continuous examination of the material variable $D_{RCM,0}$ cannot be performed on the construction site as this method is too complicated to perform in the field. Extensive surveys at the Institute for Building Materials at the Technical University of Aachen (ibac) have shown good correlation between the chloride migration coefficient $D_{RCM,0}$ and the electrolytic resistivity of concrete $\rho_{WER,0}$

determined with the so-called WENNER probe (Figure 6). Use of the WENNER method is described in detail by Gehlen and Ludwig.⁸ Considering this, the material resistance to chloride penetration was verified on concrete cubes stored at the construction site (immersed in tap water, $T = 20^\circ C$) by indirect examination of the electrolytic resistivity of the concrete.

In addition to the material control, a permanent measurement of the concrete cover is required to confirm that the measured performance with regard to x_c is equal to the required performance of the geometrical variable x_c . In the Figure 7 a distribution plot of measured concrete covers (internal surface) of one single concrete element is given.

The determined statistical quantities are as follows: normal distribution ($\mu; \sigma$) = ND (50.98; 4.23).

Taking this new information into account, the updated reliability index at time $t_{service\ life} = 100$ years is $\beta_{SLS} = 2.2$. This value is higher than the calculated one of the original design ($\beta_{SLS} = 2.0$) and is clearly above the required range of $\beta_{0,SLS} = 1.5-1.8$.

More detailed information about the applied quality control procedures and related measurements will be published in the near future.

Fig. 6 Relationship between $D_{RCM,0}$ and $\rho_{WER,0}$

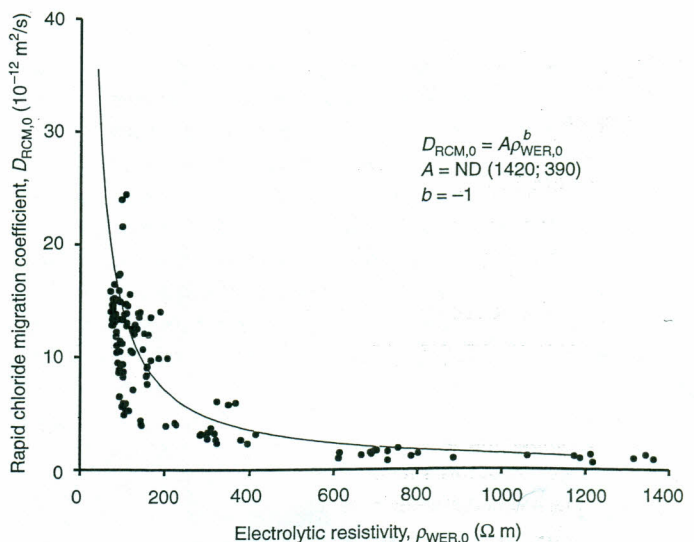
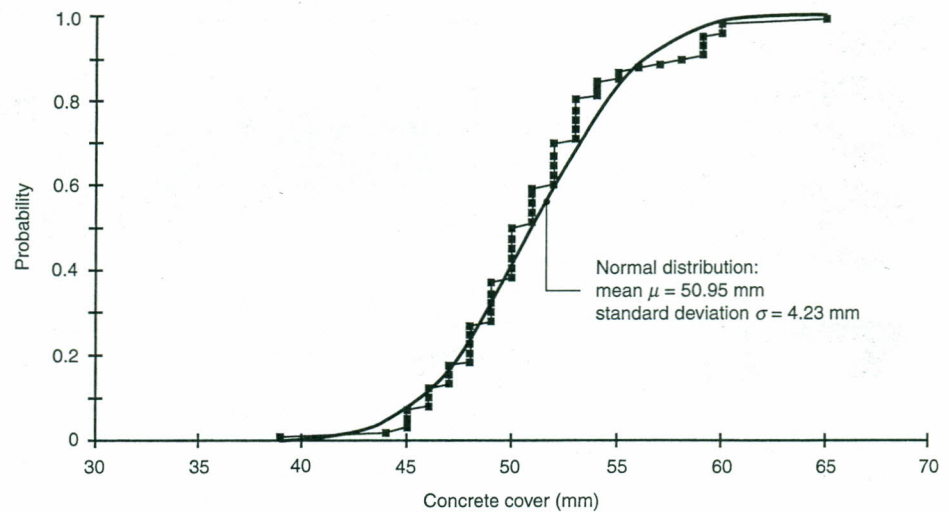

Fig. 7 Distribution plot of measured concrete cover



Summary

In the last decade much effort has been spent on the service life design of structures and especially of concrete structures. This has finally led to a situation where it is possible to achieve a fully performance- and reliability-based service life design for a real structure: the Western Scheldt Tunnel.

This paper has summarized the design framework and has identified the information which is required to perform a probability based service life design. One design example has been described in detail: the concrete mix in conjunction with the concrete cover of the tube was designed for the expected deterioration mechanism (environmental loading). Further measures to complete the durability design (quality control) were briefly presented.

The Western Scheldt Tunnel project has shown that the outlined performance-based design concept works not only within the design phase but also during construction. Within the design phase the ideal material resistance in conjunction with the corresponding ideal concrete cover can be identified to guarantee the required durability of the structure. During construction these two variables (x_c and $D_{RCM,0}$ measured indirectly by $\rho_{WER,0}$) at least can be checked continuously. The measured values can be taken to update the original service life design. If the original designed performances are not reached on the construction site (this can also be an output from the quality control procedure), additional measures can be taken and considered statistically to improve the structure (e.g. hydrophobation).

References

1. Bamforth, P. Double standards in design. *Concrete* (submitted).
2. *International Workshop on Service Life Design of Concrete Structures*. Copenhagen, 1994.
3. Basler, E. *Untersuchungen über den Sicherheitsbegriff von Bauwerken*. Schweizer Archiv für angewandte Wissenschaft und Technik, Heft 4, 1961.
4. Cornell, A. C. A probability based structural code. *ACI Journal*, 1969, 12, Proceedings V 66.
5. RCP Consulting: *STRUREL, A Structural Reliability Analysis Program System*. RCP Consulting, München, 1995.
6. Siemes, A. J. M. and Rostam, S. Durable safety and serviceability—a

performance based design format, IABSE report 74. In *Proceedings of the IABSE Colloquium 'Basis of Design and Actions on Structures—Background and Application of Eurocode 1'*. Delft, 1996, pp. 41–50.

7. Alisa, M., Andrade, C., Gehlen, C., Rodriguez, J. and Vogels, R. *Modelling of Degradation*. Brite-Euram, Brussels, 1998, project BE95-1347, draft R 4/5.
8. Gehlen, C. and Ludwig, H.-M. *Compliance Testing for Probabilistic Design Purposes*. Brite-Euram, Brussels, 1999, project BE95-1347, draft R 8.
9. Tang, L. *Chloride Transport in Concrete—Measurement and Prediction*. Chalmers University of Technology, Gothenburg, 1996.
10. Siemes, A. J. M., Gehlen, C., Lindvall, A., Arteaga, A. and Ludwig, H.-M. *Statistical Quantification of the Variables in the Limit State Functions. Summary*. Brite-Euram, Brussels, 1999, project BE95-1347, draft R 9.
11. Bamforth, P. Spreadsheet model for reinforcement corrosion in structures exposed to chlorides. In *Proceedings of the 2nd International Conference on Concrete Under Severe Conditions, Tromsø, Norway* (eds O. E. GjØrv, K. Sakai and N. Banthia). Spon, London, 1998, vol. 1, pp. 64–75.
12. CEB. *Durable Concrete Structures. CEB Design Guide Second Edition 1989*. Comité Euro-International du Béton, Lausanne, 1989, Bulletin No. 182.
13. Breit, W. Untersuchungen zum kritischen korrosionsauslösenden Chloridgehalt für Stahl in Beton. In: *Schriftenreihe Aachener Beiträge zur Bauforschung, Institut für Bauforschung der RWTH Aachen, Nr 8*. Technische Hochschule, Aachen, 1997.



Christoph Gehlen, Dipl.-Ing.

Head of Working Group 2, 'Reinforcement and Reinforced Concrete', Institute for Building Materials (ibac), Technical University of Aachen, Schinkelstrasse 3, D-52062 Aachen, Germany



Peter Schiessl, Prof. Dr.-Ing.

Director of the Institute for Building Material Research, Technical University of Munich, Baumbachstrasse 7, D-81245 München, Germany