

# 2014

---

**Munich School of Engineering**  
Annual Report

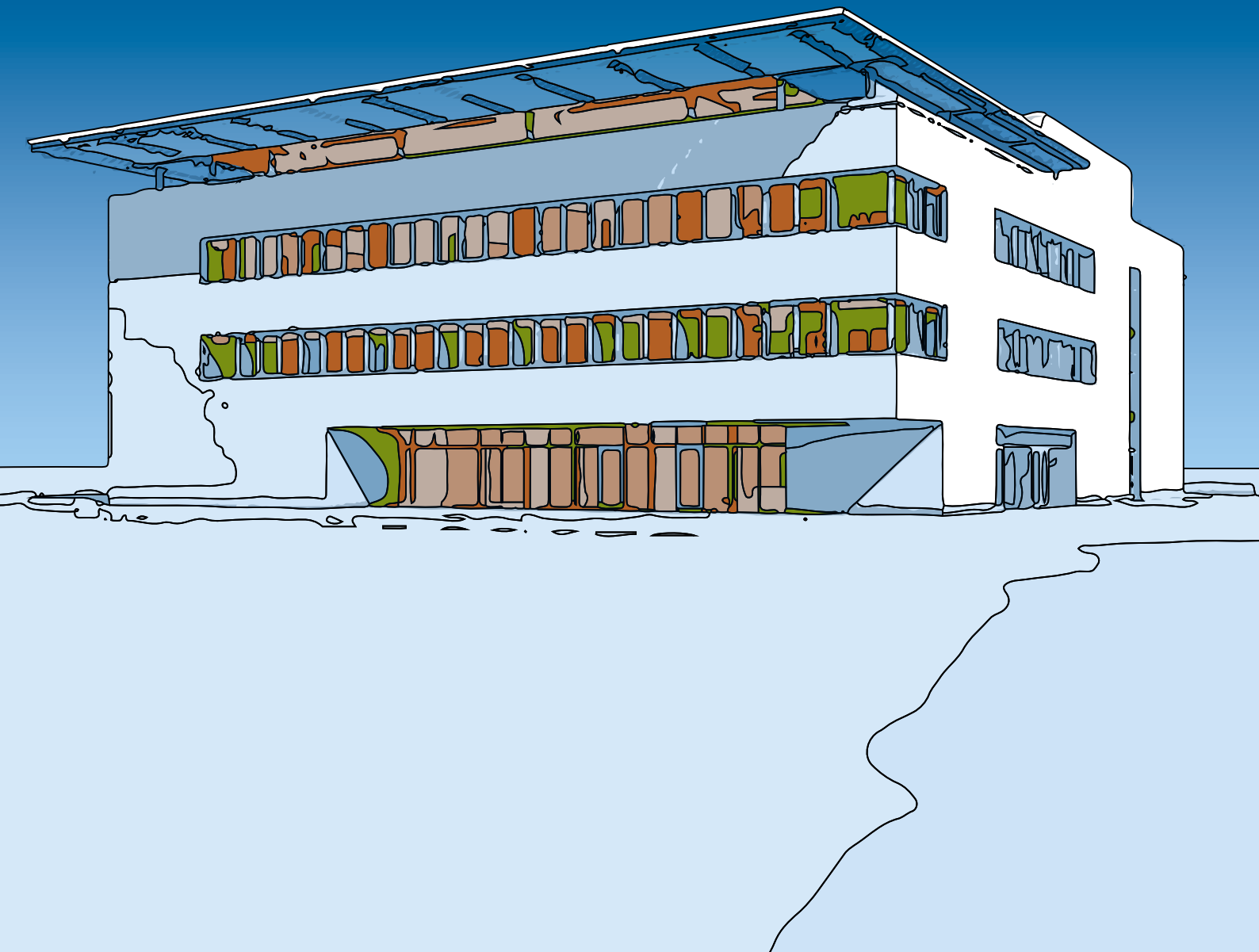



Munich School of Engineering



Technische Universität München

# 2014

---

**Munich School of Engineering**  
Annual Report

# 1

---

## Welcome

President's Preface	7
Director's Message	8
Preamble	
Dean of Studies	9

# 2

---

## Future Challenges

New materials give new possibilities in renewable energies	12
Reliable energy supply needs a stable framework	13
Electromobility requires a holistic approach	15
We need a fundamental shift in the building sector toward a sustainable use of resources	16
Watching polymers during film formation will lead to more control in plastic solar cell production	18
International education for global challenges	19
Energy storage – a multidisciplinary challenge	20
Academics as a catalyst to facilitate scientific reasoning in practice	21
Scientific and technological advances push the growth of wind in the energy mix	23

# 3

---

## MSE at a Glance

The MSE as an Integrative Research Center	26
Research	28
Teaching	30
MSE Teaching	32
Calendar of Events	36
Center for Energy and Information (ZEI)	38

# 4

## Teaching

Studying at MSE	43
Statement on BSc Engineering Science	44
Statement on studium MINT	45
Statement on MSc Human Factors Engineering	46
Statement on MSc Industrial Biotechnology	47
studium MINT	48
Bachelor's Program Engineering Science	50
Master's Program Industrial Biotechnology	56
Master's Program Human Factors Engineering	59
Future Master's Program Engineering Science	61
Future Master's Program Power Systems and Energy Management	62
MSE Student Council	64

# 5

## Research

General Overview	68
TUM.Energy Valley Bavaria (EVB)	69
Flexible Power Plants	70
Energy Efficient and Smart Cities	82
Organic Photovoltaics	87
Control of Renewable Energy Systems	92
Seed Funding Projects	99
EEBatt	110
Center for Power Generation (CPG)	118
Network for Renewable Energy (NRG)	130
Science Center for Electromobility (WZE)	142
Center for Sustainable Building (ZNB)	154
MSE Colloquium 2014 "Energy in motion"	168
TUM Applied Technology Forum	170
Energy in Context	172
Internationalization	173

# 6

## Appendix

MSE Management Office	175
Picture Credits	178
Imprint	179

---

Welcome

# President's Preface

## Progress and Innovation

For universities it becomes more and more important to think and act progressively. Today's challenges can no longer be addressed by single scientific disciplines but only through an interdisciplinary approach. Therefore TUM initiated a transformation process and generated a new type of university structure with a strong entrepreneurial spirit and cross-faculty thinking.

TUM has established a new type of integrative research centers, which involve different departments to focus on future and innovative technologies and to be prepared for key challenges facing society: Health & Nutrition, Energy & Natural Resources, Environment & Climate, Information & Communications, Mobility & Infrastructure. In 2010 the Munich School of Engineering was established to bundle all competences in the field of energy research and to tackle this big issue in a comprehensive and flexible way. Roughly 100 professors from ten departments joined forces to develop new research cooperations and innovative projects.

As a reaction to the Fukushima nuclear disaster in 2011, Germany and Bavaria have developed ambitious programs to restructure the energy system radically – to withdraw from nuclear energy and to focus on renewable energy sources. This requires enormous research efforts in the fields of energy production, energy distribution and energy storage.

In 2013 the State of Bavaria launched a €500 million package to promote research needed for the energy transition. TUM participates with its collaborative research project TUM.Energy Valley Bavaria as well as with EEBatt – a collaborative project with VARTA Storage AG. The considerable interim results of both projects can be read in this Annual Report. Also funded by the State of Bavaria is the Center for Energy and Information, a new research building which will be situated on the Garching Research Campus.

In 2014 the Energy Dialogue was initiated by the Bavarian State Minister of Economic Affairs and Media, Energy and Technology. Prof. Hamacher, the director of the MSE, participated in this committee – this again emphasizes that political decisions should be based on sound scientific foundations. A new focus of Bavarian policies will lie in the field of digitalization. Once again it has been decided that an important facility, the headquarters of the "Center Digital.Bavaria," will be hosted on the Garching campus, since the Munich area is considered Europe's IT-hub number 1 by the European Commission. This demonstrates that our integrative research concepts perfectly resonate within the scientific and political communities.

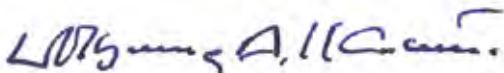

Prof. Dr. Dr. h.c. mult. Wolfgang A. Herrmann  
President



Wolfgang A. Herrmann  
President

# Director's Message



**Thomas Hamacher**  
Director

It seems that the energy debate, which long centered on the question, “Nuclear power – yes or no?” broke like a mirror into hundreds of pieces of new debates: Do we need new power lines? Do we need wind power in Bavaria? Do new hydropower plants harm fish? Do wind turbines kill birds? Etc. The initial enthusiasm that drove the “Energiewende” gave way to skepticism and even protest. Nevertheless, a consensus still sees the transformation of the energy system away from nuclear and fossil fuels and toward renewable power as one of the big challenges for the coming decades.

How can society react to such a challenge? How can the mistrust in technologies and institutions and experts be transformed into a new dialogue with society, driven by an optimistic vision of what our future lives should look like and how they should be organized?

One answer is that we reflect on how engineers are educated and trained in their research environment, and how research is done at the leading technical universities and universities of applied science. The Munich School of Engineering aims to become a breeding ground for a new kind of engineer. We need engineers who are capable of interdisciplinary work that takes many non-technical issues into consideration. The first lesson here is that a good understanding of the roots – mathematics, physics, chemistry and basic engineering knowledge – is necessary for any change to occur. As is well known from interreligious dialogues, only if I am strong and knowledgeable in my own beliefs can I discuss them with representatives from other religions. Only an engineer who is strong in his own field can work in an interdisciplinary team. This lesson is the basic design criteria of the Munich School of Engineering, and is reflected in the educational and research concept. This is the concept of the bachelor's program, and this is also the concept of the research. There are no plans to have a new “interdisciplinary” laboratory, only to rely on the strength of the strong faculties already present at our university.

And in those fields that are not yet covered, new expertise will be built up. The Munich Center for Technology in Society (MCTS) will open the world of social science to our work, and the new Munich School of Political Science (HfP) will open the dialogue with the political sphere.

Germany, and especially Bavaria, are experiencing extremely interesting times, particularly as regards the future of the energy system. The Technische Universität München has positioned its forces in such a way that we are well prepared for the challenges that lie ahead of us.

Prof. Dr. Thomas Hamacher  
Director

# Preamble Dean of Studies

The Munich School of Engineering (MSE) has been established in 2010 with two main objectives. One of these objectives is to reinforce and synergize energy research at TUM. The other objective is to enhance teaching programs offered through the faculties of TUM by specific programs, as response to current trends in technical education at the University level, and as anticipation of future developments.

Future technological development and innovation have increasing impact on nearly all areas of life. For a society that relies almost entirely on technological creation of value, it is a necessity to sustain the education of engineers that can prevail in international competition. Engineers that can cope with future challenges need to be exposed to interdisciplinary thinking and acting at the very roots of their education. On the other hand disciplinary barriers in applications also need to be overcome, which can only be addressed by education at the Universities. Current and future teaching programs at the undergraduate and at the graduate level at MSE have the purpose of meeting these needs.

In the near future we expect to establish an interdisciplinary and scientifically oriented master's program on engineering sciences. The program reflects the need of interdisciplinary and research-driven education in all areas of technology, in particular energy technology. Graduates of this program in particular will earn the competences to perform research at academia or research institutions.

Engineering education in the future will face the combined challenges of securing and further improving education quality, increasing the number of successful graduates, while competing with other education fields and alternative professional career paths for the brightest students. Outreach towards high-school graduates is a necessity, as there is no substitute to early familiarization and straightening preconceptions about engineering. MSE develops modern programs for aiding prospective students during their transition between school and University.

Engineering offers the unique possibility to combine scientific challenge with art, craft, and creativity. MSE heralds the motto of engineering, coined by the late Hans W. Liepmann, Emeritus Professor of the California Institute of Technology, and former Director of their Graduate Aeronautical Laboratories, during a commencement speech in 1982:

To Know. To Understand. To Do.

Prof. Dr.-Ing. Nikolaus A. Adams  
Dean of Studies



**Nikolaus A. Adams**  
Dean of Studies





# Future Challenges

---

<b>New materials give new possibilities in renewable energies</b>	12
<b>Reliable energy supply needs a stable framework</b>	13
<b>Electromobility requires a holistic approach</b>	15
<b>We need a fundamental shift in the building sector toward a sustainable use of resources</b>	16
<b>Watching polymers during film formation will lead to more control in plastic solar cell production</b>	18
<b>International education for global challenges</b>	19
<b>Energy storage – a multidisciplinary challenge</b>	20
<b>Academics as a catalyst to facilitate scientific reasoning in practice</b>	21
<b>Scientific and technological advances push the growth of wind in the energy mix</b>	23

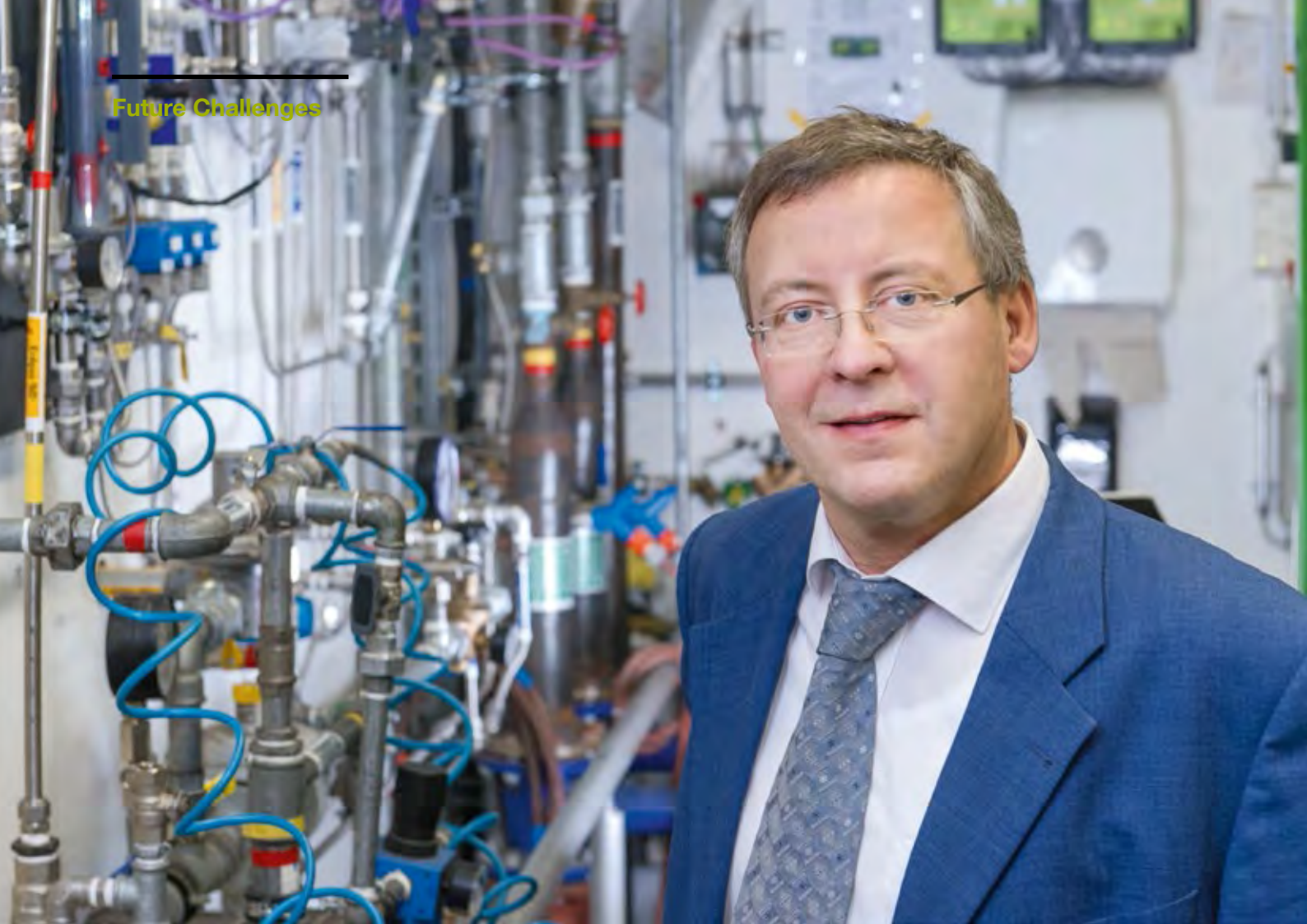

## New materials give new possibilities in renewable energies

**Prof. Dr. Peter Müller-Buschbaum**, Functional Materials, Department of Physics

Renewable energies combine a wide range of different energy sources and start to become strongly visible in every day life. However, concerning the potential of renewable energies we are today only at the beginning. New possibilities arise from an interdisciplinary interplay between the different disciplines and solutions are unlikely to be found with a limited view. Thus, the research within the Network for Renewable Energy (NRG) covers a wide range from nanoelectronics and material research, as well as microbiology and theoretical chemistry to biomass power stations, wave and solar energy systems, only to mention a few.

Fundamental research as well as applied investigations are needed to ensure steady progress. In particular new materials will enable new options and possibilities, such as for example wind turbines or solar cells, which cannot be realized with the presently available materials. A prominent example is the so-called perovskite solar cells, which after only few years of research have reached the efficiencies of the traditional silicon solar cells.

# Reliable energy supply needs a stable framework

**Prof. Dr.-Ing. Hartmut Spliethoff**, Energy Systems, Department of Mechanical Engineering

The efforts for the transition of the energy systems are particularly high in Bavaria. With the approaching phase-out of nuclear energy the foreseen situation might become critical due to a rising discrepancy between the need for new technologies (and infrastructure) and the profitability of investments.

In this context, research on new and innovative electricity generation as well as storage technologies (e.g. Power-to-Fuel) has to be intensified with the aim of fast integration within the existing capacities. Additionally, development plans for wind and geothermal energy are urgently required, the flexibilization of fossil power plants has to be increased and the market design should be adapted. Without new efforts, the accustomed security of supply might be endangered, since a capacity lack is foreseen to arise in the near future.

Another main challenge for the future is to regard the “Energiewende” as a project for the whole society. The discussion on opportunities and risks of a changing energy system has to include all participants from industry, politics and society. Reliable energy supply needs a stable framework.





# Electromobility requires a holistic approach

**Prof. Dr. Hubert Gasteiger**, Electrochemistry, Department of Chemistry

**Prof. Dr.-Ing. Thomas Herzog**, Energy Conversion Technology, Department of Electrical and Computer Engineering

**Prof. Dr.-Ing. Markus Lienkamp**, Automotive Technology, Department of Mechanical Engineering

The Science Centre for Electromobility (WZE) has taken on challenges arising in the wide field of electro mobility. These challenges cannot only be seen in the engineering of the vehicle itself, it is also the infrastructure and the user that have to be taken into account. Electric vehicles still stand behind internal combustion cars in terms of attractiveness due to the car's limited range and today's high battery prices. That is why the WZE especially carries out research on battery technology with the aim to simplify production techniques and increase the energy efficiency by comprehensive examination of all electric components. For introducing more electric cars into the market, a well-developed charging infrastructure in the public, half-public and private sector was found to be the key requirement. The WZE investigates how to realise a reliable infrastructure to guarantee an appropriate utilisation. However, the most decisive factor regarding a change in mobility behaviour are the users. In order to support the transition to electro mobility, the users' acceptance towards electric vehicles needs to be improved. The best suitable infrastructure and a reliable energy management could take away the users' doubts about an insufficient range. Users further need to be more aware that an electric car cannot cover any cases of a given mobility demand. An intelligent use of different mobility solutions can support both: reduce cost and compensate the restrictions of e-mobility – especially in the long term and with relation to environment and resource scarcity.





## We need a fundamental shift in the building sector toward a sustainable use of resources

**Prof. Dipl.-Ing. Thomas Auer**, Building Technology and Climate Responsive Design, Department of Architecture

**Prof. Dr. Thomas Hamacher**, Energy Economy and Application Technology, Department of Electrical and Computer Engineering

**Prof. Dr.-Ing. Werner Lang**, Energy Efficient and Sustainable Design and Building, Department of Civil, Geo and Environmental Engineering, Department of Architecture

**Prof. Dr. Klaus Sedlbauer**, Building Physics, Department of Civil, Geo and Environmental Engineering

In the context of global resource consumption the construction sector plays a major role. The energy supply of buildings accounts for about 1/3 of the global CO<sub>2</sub> emissions. 60% of the global electricity is consumed by the building sector. Additionally, this comes along with energy consumption, respectively CO<sub>2</sub> emissions, for construction, maintenance and demolition of buildings. According to the United Nations Environment Programme, the construction sector is responsible for about 1/3 of the global resource consumption. This includes about 12% of the world's freshwater consumption and 40% of the global waste accumulation.

To ensure the sustainable use of the resources available to secure our quality of life, a fundamental shift in the building sector is necessary with regard to the use of energy, materials, water, etc. For this purpose, a holistic, interdisciplinary and lifecycle based work approach, reaching beyond all scales, is essential.

In order to develop appropriate solutions to reach full sustainability of the built environment, the ZNB was established in spring 2010. Its twofold function is to contribute to the education of students in the field of sustainable building and to form a broad platform for energy-oriented research in construction. In this role the ZNB acts in cooperation with the participating TUM departments Energy Efficient and Sustainable Design and Building, Building Technology and Climate Responsive Design, Building Physics, and Energy Economy and Application Technology.







## Small things matter for big scales

**Dr. Eva M. Herzig**, Organic Photovoltaics, MSE

Photovoltaics (PV) is an intriguing process for energy conversion since it directly converts light into moving charges without the need of converting e.g. heat or movement into electricity. Organic photovoltaics (OPV) are made from organic molecules - consisting mainly of carbon, oxygen and hydrogen - instead of being fabricated from inorganic materials like silicon. Due to its light weight, flexible and solution processable properties OPV has been ascribed strong market potential. However, commercialization and therefore implementation into products like building integrated PV or consumer electronics is still hampered by scaling issues. For full commercialization to take place it is necessary to be able to produce defect free, reliably efficient devices with an appropriate lifetime. Many important production issues have been revealed via the study of small, laboratory scale samples produced with laboratory methods. However, changing the method of production alters the influence of the production parameters significantly. Experiments which reveal the structure on the nanoscale during formation and in the final film will provide the basis for understanding how such systems can be systematically influenced. This fundamental understanding is necessary to control defects, efficiency and stability from a morphological point of view. Hence, we can move away from trial and error approaches and open up potential opportunities for innovative solutions for the commercialization of OPV.

# International education for global challenges

**Prof. Dr. Thomas Hamacher**, Renewable and Sustainable Energy Systems, Department of Electrical and Computer Engineering

The last ten years have seen a steady increase in energy demand. A good fraction of this increase was supplied by coal. This is a huge threat for any climate policy, and also causes many local environmental problems. Many countries still see no other opportunity to drive their economic growth, which is primarily linked to an increase in energy – and especially power – demand. In Germany, policies promote a rapid changeover to renewable energies, but the process is currently stuck in many smaller problems, such as establishing the necessary infrastructure and designing the optimal power market. At the same time, other countries – mainly in Africa – still lack commercial energy supplies, and people spend many hours each day collecting fuelwood to prepare food. The challenge of good energy research is to see what these problems have in common, to supply affordable energy and power to expanding economies, to transform the energy systems in the industrialized countries, and to help the poorest countries take their first steps toward development. The vision for the Munich School of Engineering is not only to work on these technologies, but to become a major school that also educates the engineers who will help solve these problems, not only in Bavaria, but also in Singapore and Indonesia, as well as in poor regions like Ethiopia. So we aim to combine first-class research with first-class education that we want to make available to people from all over the world.



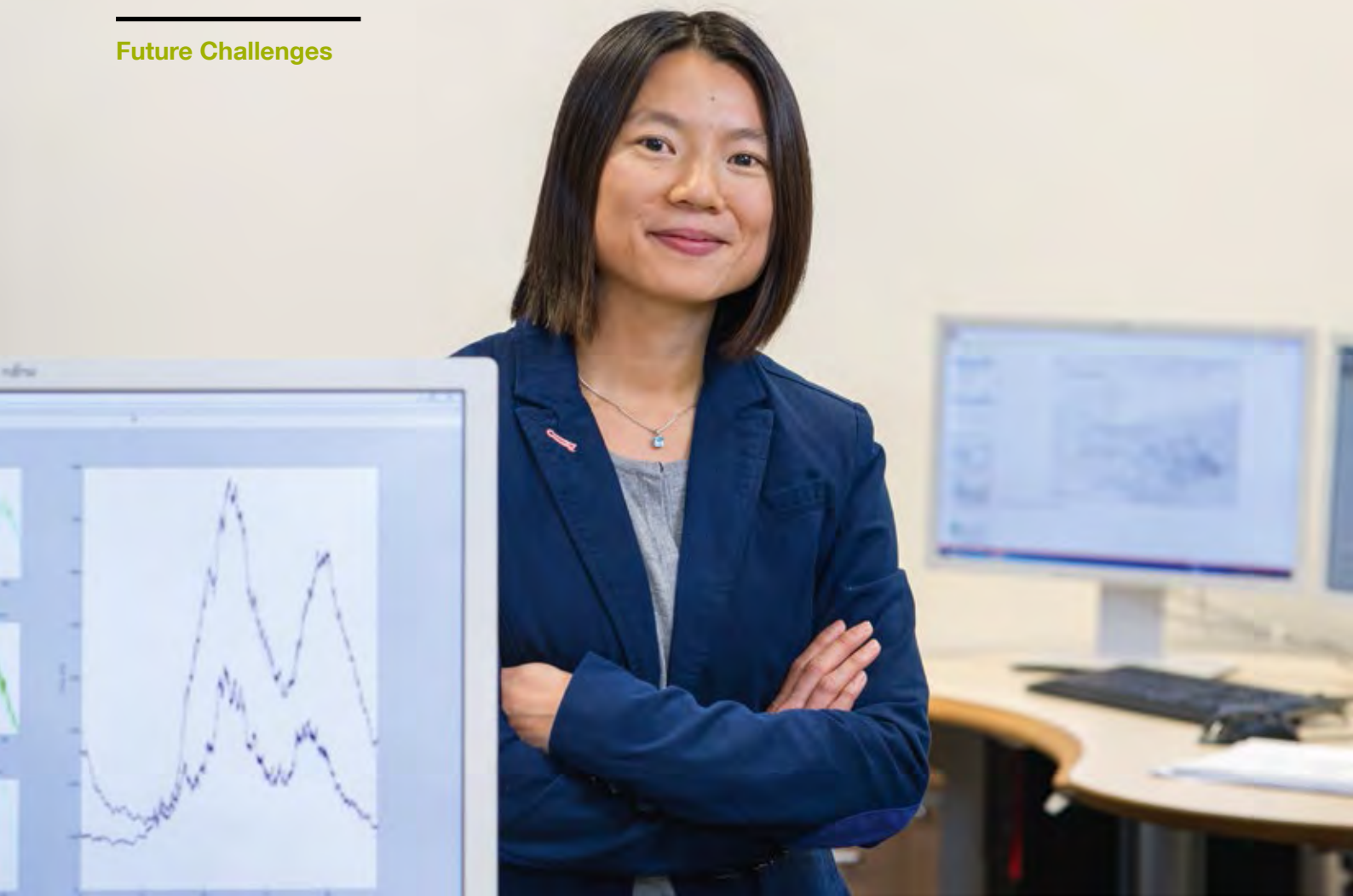

## Energy storage – a multidisciplinary challenge

**Prof. Dr.-Ing. Andreas Jossen**, Energy Storage Technology, Department of Electrical and Computer Engineering

Energy storage is required for mobile applications or if energy generation and consumption differ in time. The fast development of mobile applications, as cellular phones, laptop computers and cordless tools at the end of the last century initiated the development of batteries with high energy and high power density. The market introduction of NiMH batteries in 1990 and Li-ion batteries in 1991 pushed the further development of new applications with increasing energy and power requirements. First mass produced hybrid electric vehicles started in 1997 and the first battery electric vehicle (BEV) was introduced in the market in 2010. Since that time we see a strong development in stationary energy storage systems. Such systems can optimize the self-consumption of grid connected pv systems and can also support other services in the grid, as load leveling or power control. The key challenges of energy storage systems are the improvement of energy and power density, lifetime, safety and reliability and the cost reduction. Research on batteries is a multidisciplinary task between fundamental material science and engineering related to cell design, system design, power electronics and operation strategies. To reduce costs and increase the reliability of energy storage systems, further tasks as highly automated cell and system manufacturing are important, too. The cooperation between the different disciplines within the MSE enables us to improve energy storage systems by a holistic approach.

# Academics as a catalyst to facilitate scientific reasoning in practice

Dr. Vicky Cheng, Energy Efficient and Smart Cities, MSE

The continuous advancement in technology has made energy cleaner to produce, cheaper to store, easier to distribute and more efficient to use. While we have seen the emerge of an array of new technologies in recent years to help tackling the energy challenges, most efforts have been piecemeal. As a result, the synergy between technological advances has often been undermined. The whole is greater than the sum of its parts – a better coordination between different players in the energy field is key to meeting the energy challenge of our time. As academics, I think we can contribute by providing a sound scientific basis to support more efficient coordination and integration in the energy sector. For instance, my group is investigating the potential of applying various renewable technologies with thermal and electrical storage options in urban areas and the results can shed light on better coordination between heat and electricity supplies. Scientific evidence, however, is only one piece of the puzzle to realising the energy transition. In order to turn theory into action, it is important to engage different stakeholders and find ways to transform research knowledge into pragmatic solutions. I think the ability to bridge the gap between research and practice is one of the foremost challenges facing our work.



Future Challenges



# Scientific and technological advances push the growth of wind in the energy mix

**Prof. Dr. Carlo L. Bottasso**, Wind Energy, Department of Mechanical Engineering

**Dr.-Ing. Christoph M. Hackl**, Control of Renewable Energy Systems, MSE

Wind power technology has been experiencing tremendous advances in recent years, and in fact wind is now making a very significant contribution to the energy mix of many countries. There are great expectations from wind energy, which could play a crucial role in satisfying the demands of an energy-hungry world in a clean and renewable way.

Notwithstanding the late progress, there are however specific barriers that still should be removed and many areas where improvements can be made. In fact, scientific and technological advances may lead to significant effects on the cost of energy, on the social acceptability and on the environmental and human impacts of wind power.

The Wind Energy Institute at TUM is at work on multiple fronts to advance wind power technology. The Institute is particularly active in the optimization of the design of wind turbines, with focus on high efficiency and light weight enabled by smart controls and advanced aerodynamic, structural and material technologies. The Institute is also active in the optimization of wind power plants, where coordinated control strategies may lead to improved yield, extended life and reduced land occupation. Research on wind applications in complex terrains is particularly relevant to Bavaria and the south of Germany, where a hilly orography and proximity to people deserve specially developed technological solutions.

The MSE research group “Control of Renewable Energy Systems (CRES)”, hosted at WEI, is active on the electrical aspects of wind energy and focusses on the electrical sub-systems, such as generator, power converter and filter, and the low-level control strategies for current, torque and power control to achieve reliable grid integration and voltage/frequency support of wind turbine systems under symmetrical/asymmetrical grid faults. To implement, test and validate the developed control strategies, the CRES group is setting up a modular test bench to emulate wind turbine systems with all major generator topologies (i.e. electrically-excited, permanent-magnet and reluctance synchronous or doubly-fed induction generator) and two- or multi-level converter topologies.



# MSE at a Glance

---

<b>The MSE as an Integrative Research Center</b>	26
<b>Research</b>	28
<b>Teaching</b>	30
<b>MSE Teaching</b>	32
<b>Calendar of Events</b>	36
<b>Center for Energy and Information (ZEI)</b>	38



# The MSE as an Integrative Research Center

TUM developed the new format of Integrative Research Centers (IRCs) to answer the growing demand for interdisciplinary research and teaching. Today's societal challenges in the fields of energy, climate, natural resources, and health and nutrition can be tackled only if disciplines work together and grow beyond their traditional boundaries. Integrative Research Centers bring together scientists from different scientific cultures in themed education and research centers to focus on these societal challenges and to take advantage of TUM's unique range of subjects. Currently three IRCs complement the portfolio of TUM with its thirteen departments. They connect between the departments and offer interdisciplinary platforms.

■ Integrative Research Centers at TUM

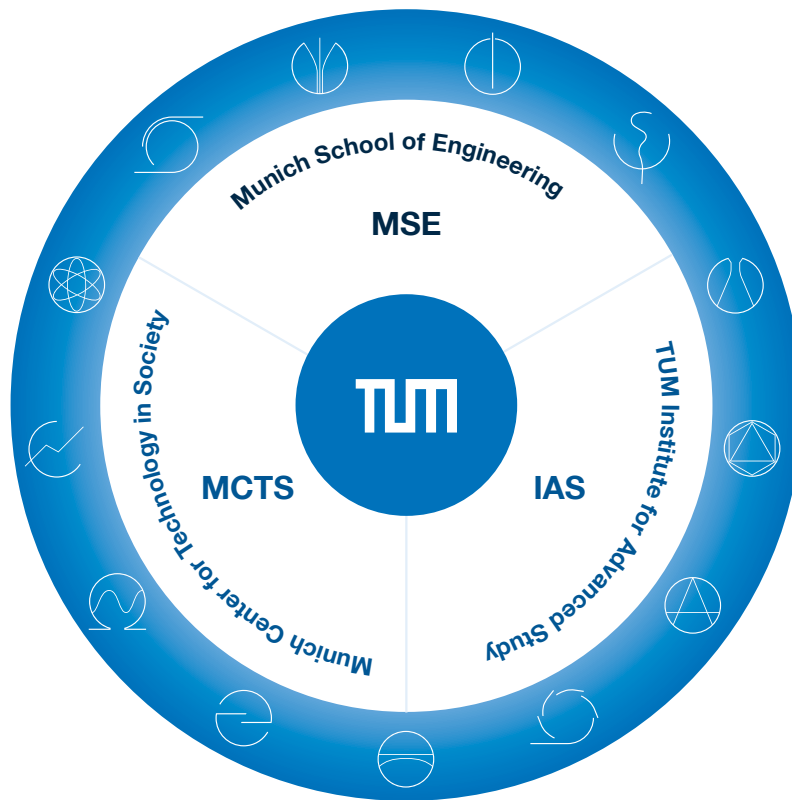

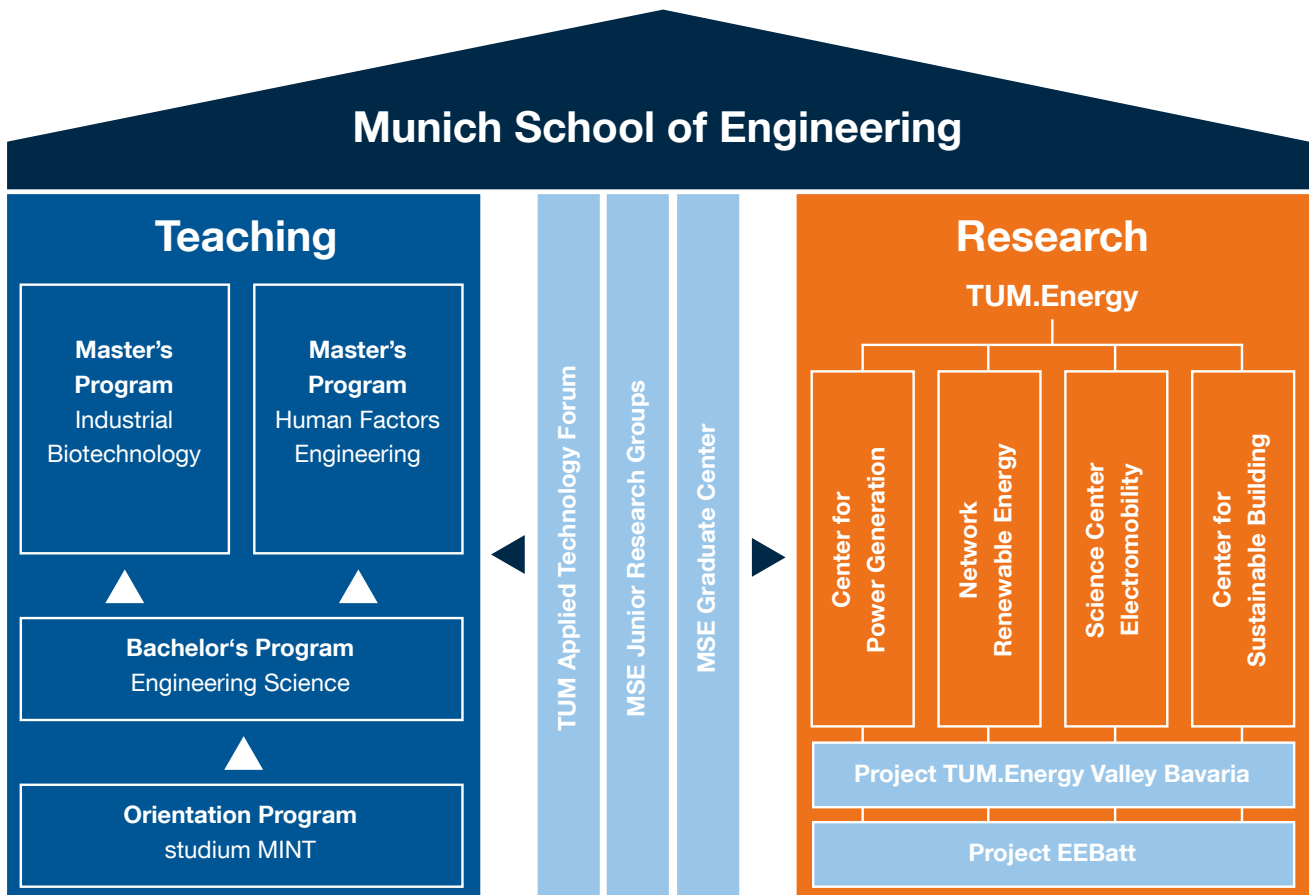

■ MSE Structure

Just like regular departments, IRCs consist of the two pillars research and teaching. But IRCs are not intended to be additional, pared-down versions of departments, or to be rivals to the existing departmental structures. Rather, IRCs offer a complementary, issue-focused and interdisciplinary approach, creating synergies and added value for all partners at TUM. Integrative Research Centers are flexible platforms and networking hubs for specific research and teaching issues. For example, MSE integrates roughly 100 professors from ten departments to work on energy-related topics. Therefore, IRCs must have flexible structures to be able to react quickly to changing challenges. All these points can hardly be solved, or even addressed, with traditional departmental structures. This integrative, result-oriented approach allows TUM to fully synergize its vast academic portfolio. TUM's portfolio stands out in the European academic arena, successfully combining the natural sciences and engineering with medicine, the life sciences and business studies.

The Munich School of Engineering combines interdisciplinary research with cross-faculty teaching for tomorrow's top engineers. The TUM.Energy research project bundles the various facets of energy research and "green" technologies with the aim of finding a sustainable energy supply for the future. In addition, MSE offers three completely newly established interdisciplinary engineering degree programs: the Engineering Science BSc and the two Master's Programs Industrial Biotechnology and Human Factors Engineering.

In order to attract young researchers and be able to conduct independent research, Integrative Research Centers have the right to award doctorates – on a par with the departments. The MSE Graduate Center was founded in 2014 and now hosts roughly 20 Ph.D. candidates.

To protect the unique structure of the MSE, "TUM Munich School of Engineering" is a registered trademark at the German Patent and Trademark Office (Nr. 302010041142) since November 3, 2010.

# Research

## Participating Professors

Name	Chair/Professorship/Institute/Group	Network for Renewable Energy (NRG)	Science Center for Electromobility (WZE)	Center for Power Generation (CPG)	Center for Sustainable Building (ZNB)	TUM Energy Valley Bavaria (EVV) Project	EEBatt Project	TUM Applied Technology Forum (ATF)	International Cooperations
<b>Department of Architecture</b>									
Prof. Auer	Building Technology and Climate Responsive Design	●							
Prof. Frenkler	Industrial Design	●							
<b>Department of Chemistry</b>									
Prof. Bach	Organic Chemistry I	●							
Prof. Fässler	Inorganic Chemistry with Focus on New Materials	●							
Prof. Gasteiger	Technical Electrochemistry	●	●	●		●	●		●
Prof. Heiz	Physical Chemistry	●							●
Prof. Hinrichsen	Chemical Technology I	●		●		●		●	
Prof. Köhler	Inorganic Chemistry	●							
Prof. Kühn	Molecular Catalysis	●				●			
Prof. Kunze-Liebhäuser			●						
Prof. Lercher	Macromolecular Chemistry	●							
Prof. Nießner	Analytical Chemistry	●							
Prof. Nilges	Synthesis and Characterization of Innovative Materials	●		●		●			●
Prof. Reuter	Theoretical Chemistry	●						●	
Prof. Rieger	Macromolecular Chemistry	●							
Prof. Rösch	Theoretical Chemistry	●							
Prof. Tromp	Inorganic Chemistry - Structural Analytics in Catalysis	●					●		
<b>Department of Civil, Geo and Environmental Engineering</b>									
Prof. Busch	Traffic Engineering and Control	●	●						
Prof. Lang	Energy Efficient and Sustainable Design and Building				●	●			
Prof. Sedlbauer	Building Physics				●			●	
Prof. Mensinger	Metal Structures							●	
<b>Department of Computer Science</b>									
Prof. Broy	Software and Systems Engineering		●						
Prof. Jacobsen	Application and Middleware Systems		●						
Prof. Knoll	Robotics and Embedded Systems	●							
<b>Department of Electrical and Computer Engineering</b>									
Prof. Chakraborty	Real-Time Computer Systems		●				●		
Prof. Hamacher	Renewable and Sustainable Energy Systems	●	●	●	●	●	●	●	●
Prof. Herkersdorf	Integrated Systems		●						
Prof. Herzog	Energy Conversion Technology	●	●				●		●
Prof. Hirche	Information Oriented Control					●			
Prof. Jossen	Electrical Energy Storage Technology	●	●	●			●		●
Prof. Kellerer	Communication Networks					●			
Prof. Kennel	Electrical Drive Systems and Power Electronics		●						
Prof. Kindersberger	High Voltage Technology and Power Transmission			●					
Prof. Lugli	Nanoelectronics		●						●
Prof. Scarpa	Nanoelectronics		●						
Prof. Utschick	Signal Processing Methods					●			
Prof. Witzmann	Power Transmission Systems	●		●		●	●		

Name	Chair/Professorship/Institute/Group	Network for Renewable Energy (NRE)	Science Center for Electromobility (WZE)	Center for Power Generation (CPG)	Center for Sustainable Building (ZNB)	TUM Energy Valley Bavaria (EVV) Project	EEBatt Project	TUM Applied Technology Forum (ATF)	International Cooperations
<b>Department of Mechanical Engineering</b>									
Prof. Adams	Aerodynamics and Fluid Mechanics	●			●				
Prof. Bengler	Ergonomics	●							
Prof. Bottasso	Wind Energy	●				●			
Prof. Drechsler	Carbon Composites							●	
Prof. Gee	Mechanics and High Performance Computing	●							
Prof. Haidn	Flight Propulsion, Flow Control and Aeroacoustics							●	
Prof. Hornung	Aircraft Design		●						
Prof. Klein	Plant and Process Technology	●		●		●			
Prof. Lienkamp	Automotive Technology		●			●		●	
Prof. Macian-Juan	Nuclear Technology			●					
Prof. Polifke	Fluid Dynamics	●	●	●		●			
Prof. Reinhart	Industrial Management and Assembly Technologies		●			●			
Prof. Sattelmayer	Thermodynamics	●	●	●		●			
Prof. Schilling	Fluid Mechanics and Hydraulic Fluid Machinery	●		●					
Prof. Spliethoff	Energy Systems	●		●		●			●
Prof. Stahl	Machine Elements		●						
Prof. Vogel-Heuser	Automation and Information Systems			●					
Prof. Wachtmeister	Internal Combustion Engines	●		●					
Prof. Wall	Computational Mechanics	●				●	●		
Prof. Werner	Materials Science and Mechanics of Materials								●
Prof. Zaeh	Machine Tools and Manufacturing Technology		●			●	●		
<b>Department of Physics</b>									
Prof. Brandt	Experimental Semiconductor Physics	●				●			
Prof. Krischer	Chemical Physics Beyond Equilibrium	●							
Prof. Müller-Buschbaum	Functional Materials	●		●		●			●
Prof. Petry	Functional Materials						●		
Prof. Stutzmann	Experimental Semiconductor Physics	●							
Prof. Zaccone	Soft Matter Theory	●							
<b>Science Center Life and Food Weihenstephan</b>									
Prof. Gaderer	Regenerative Energy Systems	●		●					
Prof. Liebl	Microbiology		●						
Prof. Mayer	Resource and Energy Technology	●					●		
Prof. Menapace	Governance in International Agribusiness						●		
Prof. Sauer	Agricultural Production and Resource Economics	●							
<b>TUM School of Management</b>									
Prof. Minner	Logistics and Supply Chain Management								●
Prof. Roosen	Marketing and Consumer Research					●	●		
Prof. Welp	Strategy and Organization					●			

# Teaching

## Participating Professors

Name	Chair/Professorship/Institute/Group	Bachelor's Program Engineering Science	Master's Program Industrial Biotechnology	Master's Program Human Factors Engineering
<b>Department of Architecture</b>				
Prof. Frenkler	Industrial Design			●
<b>Department of Chemistry</b>				
Prof. Brück	Industrial Biocatalysis		●	
Prof. Fässler	Inorganic Chemistry with Focus on Novel Materials	●		
Prof. Groll	Biochemistry		●	
Prof. Hinrichsen	Chemical Technology I		●	
Prof. Lercher	Macromolecular Chemistry		●	
Prof. Nilges	Synthesis and Characterization of Innovative Materials	●		
Prof. Reif	Solid-State NMR	●		
Prof. Tromp	Catalyst Characterisation	●		
<b>Department of Civil, Geo and Environmental Engineering</b>				
Prof. Borrmann	Computational Modeling and Simulation	●		
Prof. Duddeck	Computational Mechanics	●		
Prof. Große	Non-Destructive Testing	●		
Prof. Manhart	Hydromechanics	●		
Prof. Müller	Structural Mechanics	●		
Prof. Rank	Computation in Engineering	●		
<b>Department of Computer Science</b>				
Prof. Bungartz	Scientific Computing	●		
Prof. Broy	Software and Systems Engineering	●		
Prof. Brügge	Applied Software Engineering	●		
Prof. Eckert	IT Security	●		
Prof. Kemper	Database Systems	●		
Prof. Knoll	Robotics and Embedded Systems	●		
Prof. Navab	Computer Aided Medical Procedures & Augmented Reality			●
Prof. Schlichter	Applied Informatics - Cooperative Systems	●		
Prof. Seidl	Formal Languages, Compiler Construction, Software Construction	●		
Prof. Westermann	Computer Graphics and Visualization	●		
<b>Department of Electrical and Computer Engineering</b>				
Prof. Buss	Automatic Control Engineering	●		
Prof. Herkersdorf	Integrated Systems	●		
Prof. Rigoll	Human-Machine Communication	●		●
Prof. Schlichtmann	Electronic Design Automation	●		
Prof. Seeber	Audio Information Processing			●
Prof. Stechele	Integrated Systems	●		
<b>Department of Mathematics</b>				
Prof. Bornemann	Numerical Mathematics / Scientific Computing	●		
Prof. Cicalese	Mathematical Continuum Mechanics	●		
Prof. Dickopf	Numerical Mathematics	●		
Prof. Fornasier	Applied Numerical Analysis	●		
Prof. Wohlmuth	Numerical Mathematics	●		

Name	Chair/Professorship/Institute/Group	Bachelor's Program Engineering Science	Master's Program Industrial Biotechnology	Master's Program Human Factors Engineering
<b>Department of Mechanical Engineering</b>				
Prof. Adams	Aerodynamics and Fluid Mechanics	●		
Prof. Bengler	Ergonomics			●
Prof. Berensmeier	Bioseparation Engineering	●	●	
Prof. Bottasso	Wind Energy	●		
Prof. Drechsler	Carbon Composites			●
Prof. Gee	Mechanics & High Performance Computing	●		
Prof. Günthner	Materials Handling, Material Flow, Logistics	●		●
Prof. Haidn	Flight Propulsion, Flow Control and Aeroacustics	●		
Prof. Hornung	Aircraft Design			●
Prof. Kaltenbach	Aerodynamics and Fluid Mechanics	●		
Prof. Klein	Plant and Process Technology		●	
Prof. Koutsourelakis	Continuum Mechanics	●		
Prof. Kremling	Systems Biotechnology		●	
Prof. Lienkamp	Automotive Technology			●
Prof. Lindemann	Product Development	●		●
Prof. Polifke	Thermo-Fluid Dynamics	●		
Prof. Reinhart	Industrial Management and Assembly Technologies	●		●
Prof. Senner	Sport Equipment and Sport Materials			●
Prof. Vogel-Heuser	Automation and Information Systems			●
Prof. Wall	Computational Mechanics	●		
Prof. Weuster-Botz	Biochemical Engineering		●	
<b>Department of Physics</b>				
Prof. Dietz	Experimental Biophysics	●		
Prof. Finley	Semiconductor Quantum Nanosystems	●		
Prof. Holleitner	Nanotechnology and Nanomaterials	●		
Prof. Müller-Buschbaum	Functional Materials	●		
<b>Science Center Life and Food Weihenstephan</b>				
Prof. Frishman	Bio-Informatics		●	
Prof. Gierl	Genetics		●	
Prof. Liebl	Microbiology		●	
Prof. Luksch	Zoology	●		
Prof. Sieber	Chemistry of Biogenic Resources		●	
Prof. Skerra	Biological Chemistry		●	
<b>Department of Sport and Health Sciences</b>				
Prof. Hermsdörfer	Human Movement Science			●
Prof. Lames	Training Science and Computer Science in Sports			●
<b>TUM School of Education</b>				
Prof. Mainzer	Philosophy and Philosophy of Science	●		●
Prof. Wittmann	Vocational Education			●
<b>TUM School of Management</b>				
Prof. Fuchs	Marketing, Strategy & Leadership			●
Prof. Kehr	Psychology			●
Prof. Patzelt	Business Administration - Entrepreneurship	●		
Prof. Peus	Research and Science Management			●

# MSE Teaching

## Facts & Figures

### studium MINT

Summer Semester (SS) only

#### Students

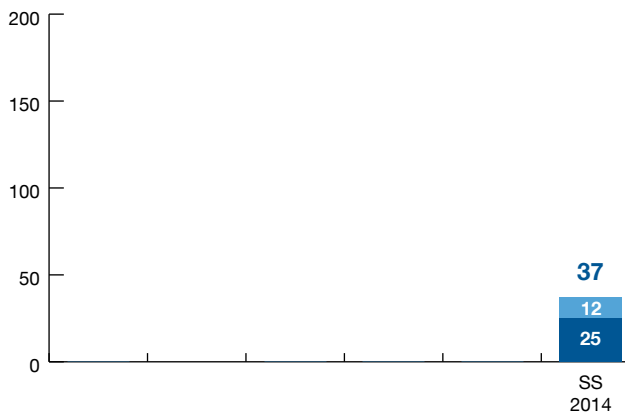

female students  
male students

#### International Students

freshmen WS 2014:



Overall in study program as on 01.10.2014:



### Bachelor Engineering Science

starting Winter Semester (WS)

#### Students

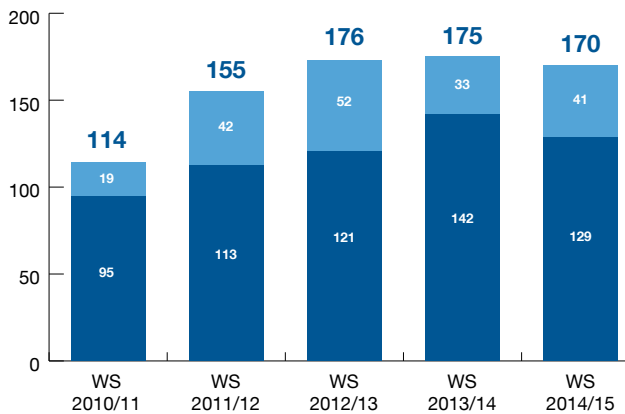

female students  
male students

#### International Students

freshmen WS 2014:



Overall in study program as on 01.10.2014:

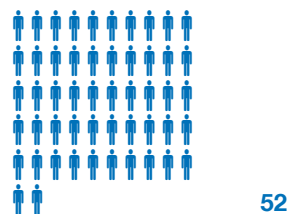

## Master Industrial Biotechnology

per academic year, starting Winter Semester (WS) and Summer Semester (SS)  
2015 including prospectice numbers for SS

### Students

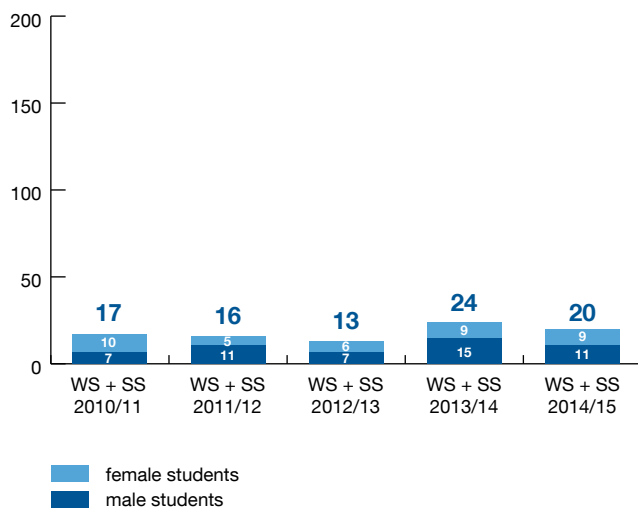

### International Students

freshmen WS 2014:



4

Overall in study program as on  
01.10.2014:



5

## Master Human Factors Engineering

per academic year, starting Winter Semester (WS) and Summer Semester (SS)  
2015 including prospectice numbers for SS

### Students

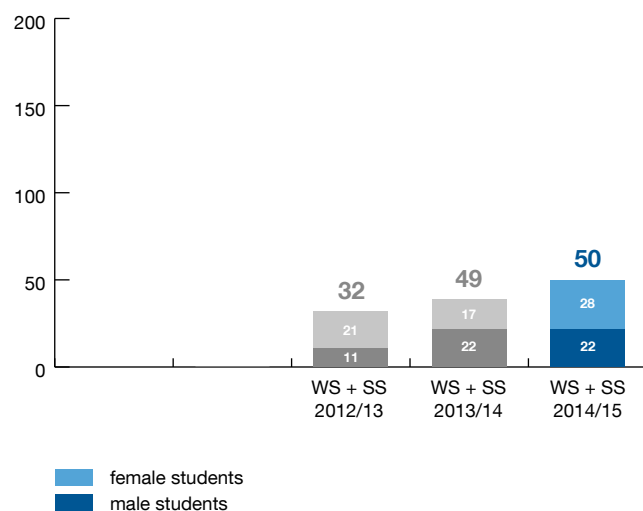

### International Students

freshmen WS 2014:



5

Overall in study program as on  
01.10.2014:



9



## Deutschlandstipendium

all study programs

2014  11



## Outgoing Students

all study programs

### Erasmus

2013/2014  11  
 2014/2015  12

### TUM Exchange

2013/2014  11  
 2014/2015  22

### Athens

2013/2014  0  
 2014/2015  0

### Other programs

2013/2014  0  
 2014/2015  3

## Incoming Students

all study programs

 3  
 3

 3  
 6

 0  
 2

 0  
 1

Outgoing Students 2014/15 by destination

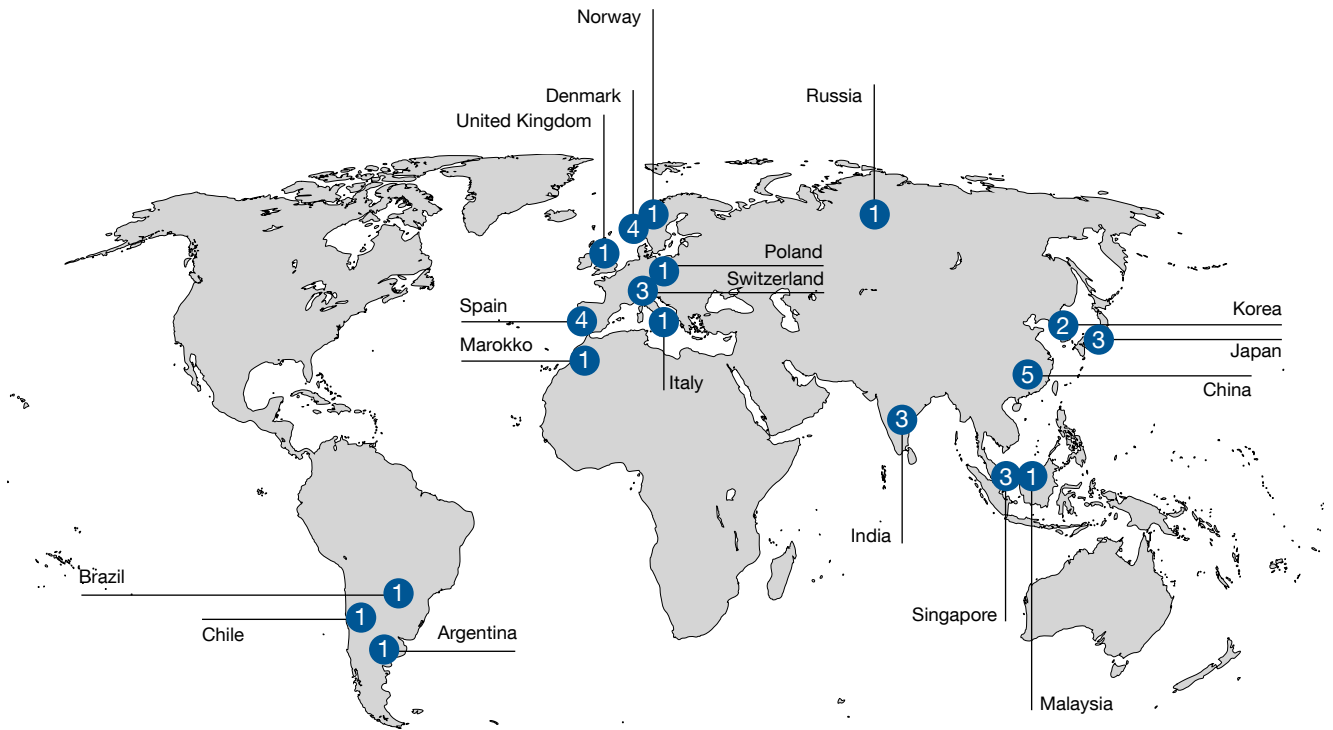

# Calendar of Events

## MSE Activities 2014

### January

23.-24.01. Eurotech photovoltaics workshop,  
Neuchatel, Switzerland (NRG)

---

31.01. MSE Graduate Center:  
1<sup>st</sup> meeting of all doctoral candidates

---

### February

25.02. Delegation visit University of Oslo

---

### March

12.03. MSE Graduate Center: official foundation

---

13.03. Research initiative „Zukunft Bau“:  
presentation on the subject “Energy  
Efficient Building”, Stuttgart (ZNB)

---

14.03. Building conference “Krieger&Schramm”:  
presentation on the subject “e-MOBILie –  
Energy Self Sufficient Electro Mobility in  
the Smart-Micro-Grid” (ZNB)

---

17.03. Delegation visit University of Cambridge

---

19.-20.03. EEBatt general meeting II, Nördlingen

---

25.03. EEBatt 1<sup>st</sup> status seminar

---

28.-30.03. Edgar-Lüscher-Seminar  
“Umwelt & Geophysik”, Zwiesel (NRG)

---

31.03. “studium MINT”: official start

---

31.03. Center for Energy and Information (ZEI):  
selection interviews of architect’s offices

---

31.03.-01.04. TUM Applied Technology Forum:  
1<sup>st</sup> symposium at Hochschule München

---

### April

31.03.-01.04. TUM Applied Technology Forum:  
1<sup>st</sup> symposium at Hochschule München

---

08.04. EuroTech Universities joint meeting

---

11.04. TUM and Nanyang Technological  
University (NTU), Singapore: Memorandum  
of Understanding on the International  
Center of Energy Research (ICER)

---

27.-30.04. 3<sup>rd</sup> SolTech International Conference,  
Wildbad Kreuth (NRG)

---

29.04. 10<sup>th</sup> WZE-Colloquium

---

### May

09.05. Power-to-Gas & Biomass-to-Gas  
Workshop (CPG)

---

30.05. Graduation Ceremony Master’s Program  
“Industrial Biotechnology“

---

### June

02.06. Electromobility Day

---

18.06. Press event “Efficiency Rating of Electric  
Vehicles”, Neubiberg (WZE)

---

27.06. Graduation Ceremony Bachelor’s Program  
“Engineering Science“

---

## July

- 03.07. 4<sup>th</sup> MSE-Colloquium
- 
- 12.07. “Energy Day”: presentation on the subjects “e-MOBILie” and “Fluidglass – Liquid Filled Glass Facades” (ZNB)
- 
- 18.07. Delegation visit Atomic Energy and Alternative Energies Commission (CEA), France
- 
- 18.07. MSE Day (get together for MSE alumni, students, professors and friends)
- 

## September

- 03./04.09. EEBatt general meeting III
- 
- 25.09. 12<sup>th</sup> monthly meeting of the EU-Project “Fluidglass”: presentation on the subject “Building Simulations and Life Cycle Assessment (LCA) of FLUIDGLASS-Buildings”, Stuttgart (ZNB)
- 
- 29.09. Delegation visit president of Danmarks Tekniske Universitet
- 
- 29.09.-01.10. Edgar-Lüscher-Seminar “Die Energiewende”, Dillingen (NRG)
- 

## October

- 29.09.-01.10. Edgar-Lüscher-Seminar “Die Energiewende”, Dillingen (NRG)
- 
- 02.10. Introductory day Master’s Program “Industrial Biotechnology”
- 
- 06./07.10. Introductory days Bachelor’s Program “Engineering Science”
- 
- 11.10. TUM Open House, Campus Garching (MSE information booth and lecture series on energy topics)
- 

- 14.-17.10. Fundação de Amparo à Pesquisa do Estado de São Paulo (FAPESP): FAPESP-Week 2014, Munich
- 

- 20.10. Visio.M project: final event with presentation of the newly developed car (WZE)
- 

## November

- 13.11. 4<sup>th</sup> ZNB symposium “How does energy transition work?”
- 
- 17.11. Kickoff meeting Energy Valley Bavaria Seed Funding Project “Dynamische Simulation von gefeuerten Kleinkraftwerken”
- 
- 21.11. „Ideenwerkstatt für die Energiezukunft“ as preparation for the Energy Congress Bavaria/Austria (CPG)
- 

## December

- 01.-02.12. TUM and Atomic Energy and Alternative Energies Commission (CEA), France: exploratory discussions on the initiation of cooperations in the field of energy research, Grenoble/Chambery, France
- 
- 01.12. Delegation visit Ecole Centrale Paris
- 
- 01.12. Energy Congress Bavaria/Austria 2014, Munich (CPG)
- 
- 10.12. TUM Master’s Fair 2014
- 

\* location: Garching, if not stated otherwise

# Center for Energy and Information (ZEI)

The Center for Energy and Information (ZEI) will be the new home for the Munich School of Engineering in both a practical and a symbolic sense. In a practical sense, it will host the MSE management office and the MSE research groups and other scientists involved in MSE energy research. In a symbolic sense, it will demonstrate the strength of interdisciplinary research in the field of energy. In this context, interdisciplinary means more than just the cooperation between the engineering faculties and the faculties for natural sciences, which is certainly important, but it also includes the cooperation with the social sciences. This is important, too, if the energy transformation is not to remain a mere plan, but is to actually be realized everywhere.

The new ZEI building will be based at the Garching Research Campus and will open in spring 2017. The building itself is equipped to be part of the research in flexible energy demand. Concrete core activation, PV modules and smart-grid systems will facilitate small-scale experiments in the area of energy supply and demand.

The building is designed around a forum and three labs. The labs will be used to develop the cutting-edge technologies needed for the energy transformation: future micro-grids, organic PV and advanced batteries. The forum will serve to attract citizens of the region to discuss Bavaria's future in a scientifically mediated environment.

## Construction Planning Schedule

The planning phase for the building continued in 2014, and the approval processes of the building authority and Bavarian Parliament were completed. The next step will be the start of the construction phase in April 2015. The building will be completed in January 2017 and inauguration is set for April 2017.



■ Architectural sketch of the building

## Occupancy

The Center will host both permanent staff and project-specific research groups. The building itself is divided into three sectors: lab space, which measures roughly 1,000 m<sup>2</sup>; office space, which covers 800 m<sup>2</sup>; and event space, which accounts for 300 m<sup>2</sup>.

### Lab Space:

The lab space comprises three different areas:

- The Simulation Hall offers space to conduct research in the field of smart grids. A microgrid will be designed that will be able to demonstrate the possibility of linking the heating and power sectors, and that will use advanced methods to connect the low and medium voltage segments.
- Research in the Lab for Battery Research will consist mainly in the analysis of lithium-ion batteries at the cell, module and system levels.
- The Lab for Organic Photovoltaics will offer space to examine organic semiconductors and their applications in organic photovoltaics to create possibilities for technological innovations.

### Office Space:

The flexible structure of the office space is designed to meet the demands of flexible project structures and allow for optimum capacity utilization.

The office space will be used by the following units:

- Center for Energy and Information – Head and project groups
- Munich School of Engineering – Managing Office
- Chair for Renewable and Sustainable Energy Systems (Prof. Hamacher)
- MSE tenure-track professors
- MSE Research Group Cheng
- MSE Research Group Hackl
- MSE Research Group Herzig
- Collaborative research projects – staff of the participating chairs

### Event Space:

One of the major tasks of the ZEI is to organize and host public participation processes. Public outreach and the integration of the different stakeholders play an important role in the ZEI concept.



# Teaching

---

<b>Studying at MSE</b>	43
<b>Statement on BSc Engineering Science</b>	44
<b>Statement on studium MINT</b>	45
<b>Statement on MSc Human Factors Engineering</b>	46
<b>Statement on MSc Industrial Biotechnology</b>	47
<b>studium MINT</b>	48
<b>Bachelor's Program Engineering Science</b>	50
<b>Master's Program Industrial Biotechnology</b>	56
<b>Master's Program Human Factors Engineering</b>	59
<b>Future Master's Program Engineering Science</b>	61
<b>Future Master's Program Power Systems and Energy Management</b>	62
<b>MSE Student Council</b>	64





# Studying at MSE

**The Munich School of Engineering (MSE) was founded in 2010 in order to pool activities and competencies in both research and teaching. It was established as an Integrative Research Center with doctorate-granting rights.**

In terms of teaching, MSE offers research-oriented study programs that focus on engineering sciences with a targeted interdisciplinary approach. Students with a talent for mathematics and science have the opportunity to examine the results of basic research in detail and assess the entrepreneurial viability of new technologies. This opens up exciting professional opportunities in the interdisciplinary fields of the future. Since winter semester 2010/11, the Munich School of Engineering offers the Bachelor's Program Engineering Science and the Master's Program Industrial Biotechnology. In summer semester 2014, the studium MINT orientation program was established. In winter semester 2014/15, the Master's Program Ergonomics – Human Factors Engineering was integrated into the study program division. Right from the start, all study programs attracted a high number of applicants, making it possible to reach the set matriculation goal at an early stage. In 2013, the first graduates from the Industrial Biotechnology Master's Program received their degrees and subsequently embarked on their scientific careers. In 2014, the first graduation ceremony of the Engineering Science Bachelor's Program was celebrated.

The studium MINT orientation program offers students the opportunity to gain insight into various programs of study at TUM and to discover more about their personal interests and strengths before enrolling in a bachelor's program.

The Bachelor's Program Engineering Science offers students broad method-based and basic scientific training in the first four semesters. The focus at this stage is on mathematics and science subjects. In the fifth and sixth semesters, the program concept allows students to individually create their personalized specialization within engineering, in line with the envisioned master's program.

The Master's Program Industrial Biotechnology qualifies graduates from different bachelor's programs in science and engineering for the interdisciplinary field of industrial biotechnology. The subjects covered over a four-semester period include biotechnology, food science, process engineering, chemistry, physics, agricultural science, robotics and information technology. This program is the answer to the increasing demand for engineers who are experts in this field of biotechnology.

The Master's Program Human Factors Engineering aims to train individuals with a bachelor's degree in the creation, implementation and evaluation of the interaction between humans and technology to meet future needs in various fields of application. Upon completion of the program, students will be able to design and evaluate human-machine interfaces in various technical domains, and thus to enhance the anthropometric design of workplaces ranging from industrial production to aircraft cockpits.

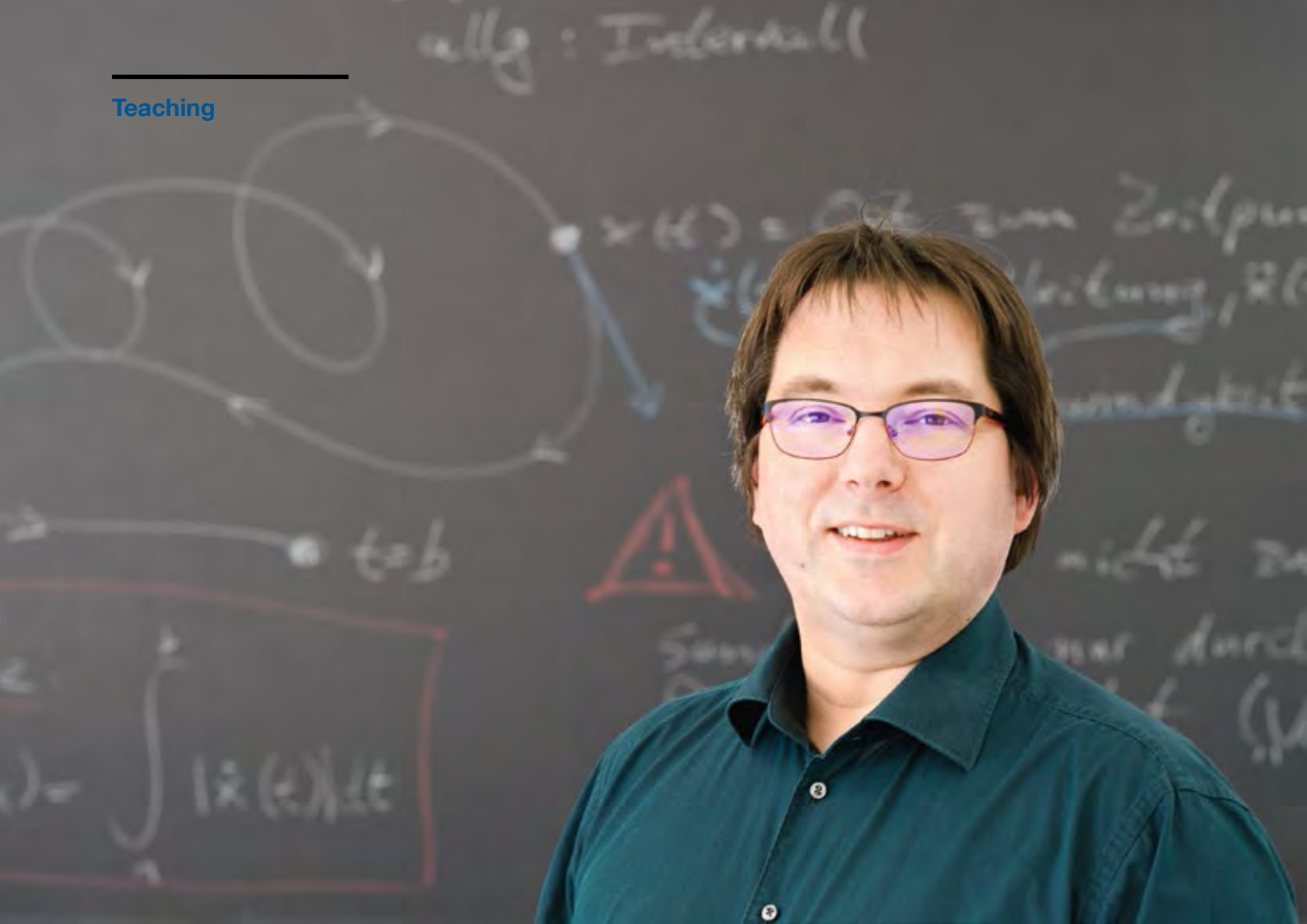

## BSc Engineering Science

**Prof. Dr.-Ing. Michael Gee**, Mechanics & High Performance Computing, Department of Mechanical Engineering

The Munich School of Engineering has welcomed its fifth class of students in winter term 2014/15 while the first graduates have already left and moved on. Many of the graduates of the Bachelor of Engineering Sciences program have continued their studies in one of the various master's programs at TU Munich, some left for other universities all over the world. It is a great pleasure to follow up on the graduates and see how well they have developed and still do, how many opportunities have opened up for them and how successful they are in these. It is especially the great diversity of consecutive programs chosen by the graduates that proves the success of the program design. Among current active students, there exists a spirit that I have never seen before in any other program or university: a general open mind towards the very broad spectrum of topics in the curriculum, an awareness for interdisciplinary approaches and thinking and last but not least the solidarity and social engagement among students; the latter probably also stimulated through rather small sized classes and the high qualitative and quantitative level of requirements of the study program. I am personally involved since the very beginning of the program and mainly teach in the first year. Synchronizing content across various courses in the program, further improving my own teaching every year and coming up with a sufficient number of research internship and bachelor theses topics to satisfy the demand continues to be challenging and very rewarding. Personally, I experience my involvement in this program as very fruitful, inspiring and enriching. I really enjoyed seeing this program originate, grow and become successful and enjoy teaching for the program every year.

# studium MINT

**Dr. Stephan Schmitz**, Advanced Mathematics and Analytical Mechanics, Department of Mathematics

During the last few years, I worked a lot with first-year students. What I found particularly interesting was the interface between school and university. Compared with this, studium MINT, a targeted one-semester orientation program for prospective students, was a very special experience for me. As university lecturers and teaching assistants are not usually involved in students' selection of a program of study, it was very impressive to experience this from a different perspective. Particularly advising young people who still have this decision ahead of them was very exciting.

Regarding the technical aspects, it was a challenge to teach mathematics, not in a specific discipline, but for all STEM disciplines at once, with all the associated questions and challenges. In doing so, I personally gained new and deep insights into the role of my own area of expertise.

I am greatly looking forward to the next year of studium MINT.





# MSc Human Factors Engineering

**Prof. Dr. Klaus Bengler**, Ergonomics, Department of Mechanical Engineering

The design of the interaction between humans and machines is gaining importance as a success factor for ambitious products. This is challenging due to the technical possibilities and the demographic development. Human factors, or ergonomics is the scientific discipline, the subject of research into the interaction of people and the design of technical systems and the development of the methods necessary for this research.

Modern embedded appliances, vehicles and diverse machines increasingly set the conditions for working and private living. Increasingly, the interaction performance of the user is the limiting factor. Therefore, machinery and technical equipment must be aligned to the expectations and requirements of their users. Objective of the Master's Program „Human Factors Engineering“ is to convey the relevant methods of the evaluation of human-machine systems and in the context of interdisciplinary training the bandwidth of the interaction technologies and interaction concepts. The subjects of anthropometry and biomechanics are raised against the background of increasing demographic shifts and change in leisure behavior and sports. Another central objective of the course is the acquisition of scientific knowledge and skills, which enable students to improve the interaction between human and machine. Graduates of the master's course human factors have their perspective in a variety of technology oriented positions.

# MSc Industrial Biotechnology

**Prof. Dr.-Ing. Dirk Weuster-Botz**, Biochemical Engineering, Department of Mechanical Engineering

Industrial Biotechnology uses biocatalysts – whole cells or parts thereof – in a wide range of industry sectors. The main driving forces for implementation of Industrial Biotechnology are cost savings and improved product quality. Studies clearly indicated that industrially realized production processes involving at least one step performed by Industrial Biotechnology showed better environmental performance than the conventional processes they replaced. Furthermore, Industrial Biotechnology will play a key-role within the bio-based economy, an economy in statu nascendi in which more and more fossil sources will be replaced by biomass resources within the next decades. In 2012 the world-wide sales of products made by Industrial Biotechnology were around 7.5 % of total chemical sales and these sales are estimated to achieve more than 15 % in 2017. For these reasons Industrial Biotechnology represent the largest business opportunity in biotechnology for the future. Industrial Biotechnology is the integrated application of biosciences together with all tools of modern process engineering to develop new industrial processes and products. Training of Industrial Biotechnology has to overcome the classical borders between natural sciences and engineering sciences. Consequently, the Master's Program Industrial Biotechnology at the Munich School of Engineering is open for graduates with distinguished bachelor degrees in biosciences as well as in material based engineering sciences. Major educational challenge is the training of engineers in biosciences and *vice versa* of bio-scientists in process engineering within the first semester of the master's study program. The further training focuses on the key competences of Industrial Biotechnology – Enzyme Engineering, Metabolic Engineering, Bioprocess Engineering and Bioseparation Engineering – in a multidisciplinary matter.



# studium MINT

## The TUM Orientation Program for Mathematics, Engineering and Natural Sciences

Due to the shortened period of schooling on the one hand, and the abolishment of mandatory military service on the other, the age at which students have to decide on a program of study for their professional careers has dropped in recent years. At the same time, the number of available study programs is constantly growing. For young people in this situation, it is a challenge to choose the most suitable and sustainable option from this wide range of offers. Unfortunately, as evidenced by the dropout rates of various study programs at different universities, they often fail in this decision. In addition, many graduates would like to complete voluntary social service or an internship abroad before starting university to gain new perspectives.

The interest in MINT or STEM disciplines (the acronym MINT = Mathematik, Informatik, Naturwissenschaft, Technik is commonly used in Germany, whereas STEM = science, technology, engineering, mathematics is used internationally with a similar meaning), as well as the demand for graduates in these fields, is still increasing. For these reasons, TUM launched an orientation program in summer semester 2014 for those interested in MINT/STEM disciplines.

### The Munich School of Engineering unites seven participating departments within this program:

- Civil, Geo and Environmental Engineering
- Chemistry
- Electrical and Computer Engineering
- Informatics
- Mechanical Engineering
- Mathematics
- Physics

The primary goal of studium MINT is to establish a reliable foundation of scientific and technical knowledge within the different STEM fields. By getting to know all important disciplines, students will be able to assess their individual interests and strengths before enrolling in a bachelor's program. The subsequent study programs will be facilitated by imparting key knowledge and learning skills. By offering the opportunity to get in touch with various scientific sectors, participants will be able to make a sustainable decision regarding their future study and career choices.

#### student's voice

**Isabel Wagner** (Mathematics):

*To conclude, I now have a more detailed vision of studying and the specific subjects. Although some of the first lectures have been quite shocking for me, I now know what I'll have to face. Especially because of these reasons I am glad I completed the orientation program studium MINT.*

**Andreas Brunnbauer** (Mechanical Engineering):









*For me in person, I can only say that I gained a lot of profit from studium MINT and I recommend it to everyone who still isn't sure about his or her favorite technical study program. studium MINT should be offered at all German Universities as it helps young people taking away the fear of their prospective life change between being a pupil and a student. Moreover, it also helps them to do further steps towards self-reliance.*

**The studium MINT courses are divided into five basic modules classified according to their purpose:**

- All MINT/STEM study programs require fundamental knowledge in mathematics and physics. These foundations can be gained, expanded and reiterated within the basic module.
- The second key pillar of this study program is the navigation module, where students have the opportunity to gain greater insight into the various undergraduate study programs. While attending different lectures from a variety of departments and chairs, the participants interact with regular bachelor students and can develop a feeling for the day-to-day academic routine and improve expertise in these areas.
- The perspective module helps students relate the theoretical and abstract knowledge acquired in the previous modules to a real working or scientific environment. Guest contributions from professionals and scientists offer an inside view into requirements, methods and opportunities within the STEM working field.
- To provide a broad foundation, studium MINT includes a soft-skills module where key competences are conveyed and improved. To apply the conceptual expertise and to practice the developing soft skills, MINT students are accompanied through an interdisciplinary project implemented in a do-it-yourself-workshop.
- Additional tutorials and individual counseling services are offered to provide an ideal study environment and to give MINT students all the support they need to complete the program successfully. Furthermore, participants receive assistance during the application process for the subsequent bachelor's programs.

Attendees are fully enrolled at TUM and can take advantage of the University's student benefits. Depending on the subsequent bachelor's program, it is possible to transfer a certain number of acquired credit points to the undergraduate studies.

**In 2014, 65% of the studium MINT participants commenced bachelor's programs at TUM.**

Department		Department	
Electrical & Computer Engineering	 4	Physics	 1
Informatics	 1	Sport & Health Sciences	 2
Mechanical Engineering	 3	TUM School of Management	 2
Mathematics	 1	TUM School of Life Sciences	
Munich School of Engineering (MSE)	 1	Weihenstephan	 4

Contact: [www.mse.tum.de/mse-lehre/studium-mint](http://www.mse.tum.de/mse-lehre/studium-mint)

**Nesrin Ahmed** (Electrical and Computer Engineering):

*All in all, studium MINT helped me a lot making a decision. Without this program, I wouldn't even have known some study programs. Regarding me, in some cases my opinion was confirmed, in some I had to reconsider it. Thus, attending studium MINT was the best decision I could have made for the summer term 2014.*



# Bachelor's Program Engineering Science

## A Program with many Possibilities

With the Bachelor's Program Engineering Science (B.Sc. ES), TUM is preparing junior engineers for the increasing diversity of career options. For most high school graduates, it is difficult to decide on one study program within the large range of specializations in the field of engineering, especially in the early stages of their academic career. For students with a strong affinity for mathematical and scientific thought, the B.Sc. ES provides excellent training based on broad basic qualifications and a differentiated, discipline-specific specialization. The program is truly interdisciplinary and research oriented with a strong focus on mathematics, natural sciences and life sciences. With a bilingual profile (German/English), this intensive study program comprises 210 ECTS points (instead of 180).

The individual focus and orientation toward a particular professional field takes place in the last year of the program and thus qualifies students for various master's programs in conventional engineering fields, but also in applied natural sciences. Most importantly, however, students who graduate with the B.Sc. ES degree have the option of continuing their studies at TUM and pursuing a master's program in various departments. Depending on their individual specialization, graduates have the possibility to continue in 31 different TUM master's programs. By the end of 2014, a total of 115 students graduated with a bachelor's degree, of which 84% continued in a TUM master's program.

Enrolment WS 13/14 percentage			Enrolment WS 13/14 percentage		
<b>Master's Program</b>			<b>Master's Program</b>		
Computational Science and Engineering, M.Sc.	3	2,6%	Mechatronics and Information Technology, M.Sc.	4	3,5%
Management (TUM-WIN), M.Sc.	8	7,0%	Energy and Process Technology, M.Sc.	5	4,3%
Management and Technology (TUM-BWL), M.Sc.	1	0,9%	Mechanical Engineering and Management, M.Sc.	8	7,0%
Civil Engineering, M.Sc.	1	0,9%	Electrical Engineering and Information Technology, M.Sc.	13	11,3%
Computational Mechanics, M.Sc.	3	2,6%	Medical Technology and Engineering, M.Sc.	2	1,7%
Mechanical Engineering, M.Sc.	29	25,2%	Computational Science and Engineering, M.Sc. Hon.	1	0,9%
Chemical Engineering, M.Sc.	1	0,9%	Computational Mechanics, M.Sc. Hon.	2	1,7%
Product Development and Design, M.Sc.	1	0,9%	Philosophy of Science and Technology, M.A.	1	0,9%
Production and Logistics, M.Sc.	1	0,9%	Not at TUM	18	15,7%
Automotive and Combustion Engine Technology, M.Sc.	2	1,7%	<b>Total</b>	<b>115</b>	<b>100,0%</b>
Aerospace Engineering, M.Sc.	11	9,6%			

■ Distribution of B.Sc. ES graduates in TUM master's programs (by department)

**Prof. Dr.-Ing. Walter Stechele**, Integrated Systems, Department of Electrical and Computer Engineering

*In my view, interdisciplinary knowledge is a strong point of the MSE curriculum. It is required in many fields, e.g. in medical robotics, with surgery on the beating heart. Compensation of heart beat movement on a visual display and in the precise guidance of surgery devices requires cooperation between control theory, mechanical modeling, and digital image processing. During many decades, engineers have contributed to improve people's lives. However, many achievements came with resource consumption and waste deposit, which might not be sustainable for future generations on our limited planet. I am convinced that engineers with interdisciplinary knowledge will play a relevant part in solving these problems. Therefore, I am glad to see highly motivated, open minded students in my course.*



**Prof. Luksch**, Zoology, Science Center Life and Food Weihenstephan  
**Dr. Kohl**, Zoology, Science Center Life and Food Weihenstephan

*From our (somewhat restricted) point of view the MSE bachelor program provides the students with the perfect possibility to get a broad interdisciplinary education. Students get a solid foundation in the classical engineering subjects and can continue their studies in a master program of their choice. Being biologists with a background in biomimetics, we are glad to contribute to this interdisciplinary orientation of the bachelor's program with our lecture on biomimetics.*



**Prof. Dr. Bernd Reif**, Solid-State NMR, Department of Chemistry

*I am teaching organic chemistry in the bachelor degree program engineering science. Even though engineering is not my primary discipline, teaching of these students is a lot of fun. The intellectual level and the background knowledge of the students is very high, and students are very motivated. Combining natural sciences and engineering seems natural. Myself, I am working as a structural biologist in the department of chemistry. Originally, I studied physics, received a PhD in chemistry, and among others I was appointed for several years at a hospital, the Charité in Berlin. Now being in chemistry, the integration of methodologies from different disciplines such as physics, chemistry, biology and medicine is essential to drive projects forward in life science. I guess, similar things apply to engineering where technological break-throughs can only be triggered by good knowledge of both natural sciences and engineering.*



**Prof. Dr. Christian Große**, Non-Destructive Testing,  
Department of Civil, Geo and Environmental Engineering

*As a "double appointment" the chair of non-destructive testing is affiliated to two faculties (Civil, Geo and Environmental as well as Mechanical Engineering) and working across the borders of faculties. This is the reason why we are so much attracted by the MSE bachelor program and the well-trained and motivated students. We believe that MSE engineers with a solid and broad knowledge of engineering principles will have many options in civil engineering and other disciplines in future because of the increasing complexity of these fields.*



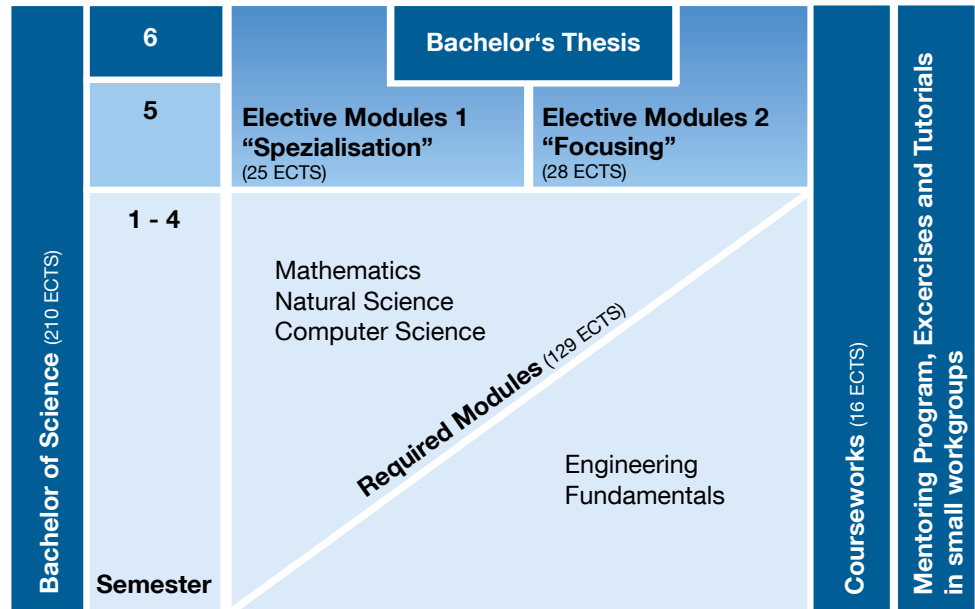

■ Structure B.Sc. Engineering Science

## Admission

The B.Sc. ES is aimed particularly at technically and scientifically gifted high school graduates and individuals who have the necessary qualifications for university admission.

The Munich School of Engineering offered the B.Sc. ES for the first time in winter semester 2010/11. The program enjoyed a very successful start, with 114 students in its first year. In its third year, there were already 176 students enrolled in the program. Since winter semester 2012/13, around 170 freshmen have started each year, so the planned capacity was reached at a very early stage.

Due to the specific concept, the B.Sc. ES attracts more female students compared with traditional bachelor's programs in e.g. mechanical engineering. The share of female first-semester students in winter semester 2014/15 was at 24%.

## TUM departments involved in B.Sc. ES teaching, by name:

- Chemistry
- Civil, Geo and Environmental Engineering
- Electrical and Computer Engineering
- Informatics
- Mathematics
- Mechanical Engineering
- Physics
- TUM School of Life Sciences Weihenstephan



**Prof. Dr. Dr. Holger Patzelt**, TUM Entrepreneurship Research Institute (ERI)

*Our entrepreneurship courses at the Munich School of Engineering are at the heart of TUM School of Management's mission to teach at the intersection of management and technology. I personally enjoy these courses very much because combining entrepreneurial skills with MSE students' passion for engineering is the optimal starting point for the development of innovative business ideas and entrepreneurial ventures in the 21st century.*

**Prof. Dr. Peter Müller-Buschbaum**, Functional Materials, Department of Physics

*In the MSE Teaching within the Bachelor Engineering Science the Physics lectures deliver basic knowledge in the first two years. The fundamental ideas in mechanics, dynamics, acoustics, optics, electrodynamics and thermodynamics are explained to the students. The idea is to get the basics in Physics, which will be needed later on in the engineering lectures, and to enable the student's first steps into a more abstract thinking towards solving problems.*



## Profile

- The first two years of the program focus on a challenging basic scientific curriculum, with exclusive and newly designed lectures and lab courses (e.g. material science jointly conducted by the Physics, Chemistry and Engineering Departments). Altogether, these fundamentals in engineering, mathematics, natural sciences and informatics account for 129 ECTS points.
- In their last year, the focus phase, participants can structure individual curricula together with a mentor, and thus prepare themselves for a broad range of potential master's programs at TUM and other universities. These electives involve "in depth" and "focus" modules that account for 53 ECTS points.
- The "in depth" electives provide advanced training in the general engineering profile. This area comprises ten pre-selected modules, mostly designed exclusively for the B.Sc. ES, five of which must be completed successfully.
- The "focus" electives offer much broader possibilities: Students can choose from a catalog of around 200 modules offered in various TUM departments. This makes it possible to create truly individually customized curricula for subject-specific education that facilitates a transition to different interdisciplinary or conventional master's programs.
- Besides the required fundamental and elective modules, coursework totaling 16 ECTS is required. In the B.Sc. ES program, this coursework includes the option to complete a four-month research internship within a TUM research group. The possibility to gain research experience at a very early stage is one of the distinctive features of the program. Students finish their internship by writing their first scientific paper or creating a poster. In the case of a poster, they can participate in a poster session and win an award at the "MSE Day" by presenting their research outcomes in front of a scientific committee.
- The final component of the degree program is usually the bachelor's thesis, the final paper submitted for the program. Again, students have boundless possibilities to choose their topic in all fields of engineering sciences as well as in various areas of applied natural sciences. By the end of 2014, a total of 145 students wrote their bachelor's thesis, conducting research at 63 different professorships in 8 TUM departments and, most recently, within MSE's own junior research groups.

**Prof. Dr. Barbara Wohlmuth**, Numerical Mathematics, Department of Mathematics

*Innovation and new technologies are increasingly driven by cross-disciplinary research. Mathematics plays a key role in the co-design of conceptual models as well as for large-scale computations. Simulation and data-based models can be found in many applications ranging from traditional engineering fields to newly emerging life sciences topics. To satisfy the growing demand for highly trained graduates and to master the challenges of the future, new educational programmes such as the ones offered by MSE are mandatory.*



### Highlights – 2014

The ultimate highlight in 2014 was definitely the graduation ceremony for the first graduates in the Engineering Science Bachelor's Program on June 27. Around forty graduates came together to celebrate their first academic degree with their families, friends, professors and the MSE staff.

The TUM location in Garching-Hochbrück was an appropriate setting for the ceremony, especially as this space was used for the first time ever by the students who graduated that day.

Each graduate received a first-issue "Bachelor Engineering Science" medal from Prof. Adams, MSE Dean of Studies. Jens Dodenhöft was awarded a special distinction: as the top graduate in the 2013/14 academic year, he received a check for 1,000 euros, donated by the company Bosch Rexroth AG in Lohr am Main, Germany.

The official part of the ceremony ended with a reception, followed by a graduation party hosted by the MSE student council.

But this was not the only highlight in 2014. At the "MSE Day" on July 18, another ceremony took place for the first time: The MSE student council awarded the "MSE Top Teaching Trophy T<sup>3</sup>" for the best lecture and assignment within the B.Sc. ES program. The T<sup>3</sup> Trophy for the best lecture by study year went to: Prof. Michael Gee, Department of Mechanical Engineering (first-year studies); Prof. Folkmar Bornemann, Department of Mathematics (second-year studies); and Prof. Phaedon-Stelios Koutsourelakis, Department of Mechanical Engineering (third-year studies). The award for the best B.Sc. ES assignment was given to Dr. Benedikt Rau, Department of Mechanical Engineering.

Contact: [www.engineering.mse.tum.de](http://www.engineering.mse.tum.de)



■ Best graduate 2013/14:  
Jens Dodenhöft



■ Winners Top Teaching  
Trophy T<sup>3</sup> 2014: Prof. Gee and  
Prof. Koutsourelakis

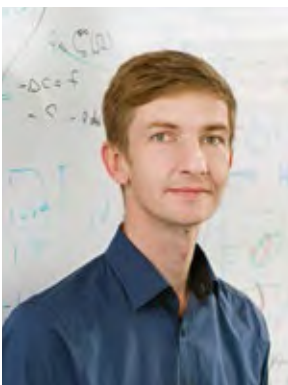

**Prof. Dr.-Ing. Michael Gee**, Mechanics & High Performance Computing,  
Department of Mechanical Engineering

*The meanwhile well-established program Bachelor of Engineering Sciences (B.E.S.), situated in the Munich School of Engineering, is a valuable enrichment to the collection of engineering study programs at TU Munich. Its interdisciplinary, science and engineering oriented approach offers a unique curriculum, which is a perfect supplement to the programs offered in the Department of Mechanical Engineering. B.E.S. graduates are educated very broadly without sacrifices to the depth of knowledge and therefore are very welcome to enter any of the master's programs offered in Mechanical Engineering. A high percentage of B.E.S. graduates do pursue a master's programs in Mechanical Engineering programs where they benefit from their broad and interdisciplinary perspective they have taken in the bachelor program.*

**Prof. Dr. Klaus Mainzer**, Philosophy and Philosophy of Science,  
TUM School of Education

*The MSE-Bachelor ES is a general introduction to modern engineering sciences. It consists of a variety of highly specialized disciplines like mathematics, computer science, natural and engineering sciences. Thus, students need a survey on the interdisciplinary connections of all these disciplines. Philosophy of engineering explains the historical development, methodological foundations and societal impact of technical systems and innovations. I appreciate the inspiring spirit of this ambitious course.*



**Prof. Dr. Alfons Kemper**, Database Systems, Department of Computer Science

*Within this degree program I teach the fundamentals of software engineering and database technology in the 4th semester. Compared to other study programs I am impressed by the commitment and determination of the students in this MSE program. Although I held the lecture on Monday in the morning, (almost) all students were in the lecture hall on time. In my view, the broad training in engineering, mathematics, natural science and computer science of this curriculum provides a very good basis for specialized Master's programs and subsequent interdisciplinary work in research or development.*



#### student's voice

**Samuel Pedziwiatr**, MSE graduate 2014, editor-in-chief of fatum,  
a biannual student magazine of philosophy of science, technology, and society ([www.fatum.techphil.de](http://www.fatum.techphil.de)).

*My Bachelor studies in Engineering Science at the MSE were an important step for me towards a career in philosophy of science and technology. When dealing with philosophical aspects of science and engineering, it is essential to have a strong technical background. The Engineering Science curriculum gives students an advantage by covering a wide variety of subjects during the first four semesters and allowing students to pursue personal interests by electing specialization modules in the fifth semester. This academic freedom was of great value to me and let me take courses in philosophy of science and technology alongside engineering classes. Most approaches in modern engineering require inter- and transdisciplinary solutions, yet at the same time there is a trend to strong specialization. Philosophers attempt to find holistic answers to fundamental questions relating to engineering such as: Which elements essentially constitute technology? What is the moral and social impact of certain technologies? What are the interconnections between different areas of research and development? The MSE was an exciting place for me to begin pursuing such questions. It attracts a community of motivated, committed, and gifted students and promotes interdisciplinary study and technological innovation.*

#### student's voice

**Jan Behrenbeck**, student, project leader at UnternehmerTUM,  
Center for Innovation and Business Creation

*In my fourth semester of Engineering Science I started the entrepreneurial qualification program Manage&More at UnternehmerTUM. My fundamental knowledge in science and engineering helped me to work in different innovation projects for big companies such as Siemens and BMW and to communicate effectively in interdisciplinary teams. After writing my Bachelor's thesis on hands-on learning at Stanford University I started to build a scholarship program at UnternehmerTUM which provides free access for students to the new high-tech workshop TechSpace at the TUM Entrepreneurship Center. Thereby students get the chance to apply their academic knowledge and literally build their dreams. I am sure that my degree in Engineering Science will help me to start a business in the future and realize my own dreams.*

# Master's Program Industrial Biotechnology

The demand for outstanding individuals who can work across a number of disciplines and have a broad range of expert knowledge in bioscience and process engineering is continually rising. The MSE is meeting this increased demand by offering an interdisciplinary Master's Program in Industrial Biotechnology (IBT). This program is unique in Germany and one of the first of its kind in Europe. It qualifies graduates for transition to a Ph.D., for example at the TUM Research Center for White Biotechnology, or, alternatively, for challenging careers in the area of IBT.

The Master's Program IBT first started in winter semester 2010-2011 and attracts an increasing number of students from TUM as well as from external universities, both domestic and foreign. There are currently 50 students registered in the program.

## Study Program Profile

The Master's Program Industrial Biotechnology is aimed at graduates with a bachelor's degree in science or engineering, as both bioscience and process engineering methods are equally important in exploiting the technological and industrial potential of new biocatalysts, and in implementing new biological production processes on an industrial scale. Therefore, interdisciplinary fundamentals, based on a specially tailored curriculum, are taught in the first two semesters to prepare students for their future work environment. Choosing from a list of required elective modules, students themselves, with the help of a mentor, put together an individual curriculum that has been adapted to the bachelor's degree:

- **Bioscience fundamentals:** Students with a bachelor's degree in engineering gain an understanding of bioscience fundamentals.
- **Process engineering fundamentals:** Students with a bachelor's degree in bioscience are taught the fundamentals of process engineering.

After learning the interdisciplinary fundamentals, students receive specialized training in the second and third semesters in the following four key areas:

- **Enzyme engineering:** Biocatalytic design for industrial biotechnology
- **Metabolic engineering:** Analysis and design of metabolic networks in microorganisms
- **Bioprocess engineering:** Biochemical engineering to make optimized biocatalysts technically usable and to make it possible to evaluate them from an industrial and economic perspective
- **Bioseparation engineering:** Reprocessing of bioproducts to cost-effectively provide the engineered products with the required purity on an industrial scale

Students can freely choose a fourth field of specialization, having the opportunity to select courses that are of interest to them from the program offered by TUM or another technical university.



### ■ Research Practice in the Pilot Plant

In the fourth semester, students complete a master's thesis, provided they have passed all module exams. This independent, academic work is based on a topic of relevance to industrial biotechnology and is supervised by a professor or any expert supervisor of Technische Universität München who is involved with the study program.

The standard duration of study is four semesters. The courses are offered by the mechanical engineering and chemistry academic departments and the Weihenstephan Science Center. The language of instruction is German, with a few select courses being conducted in English.

## Research Practice

With the TUM Research Center for White Biotechnology, TUM has established a strong, interdisciplinary research and training unit. For students in the Master's Program in Industrial Biotechnology a practical research component at this center is obligatory and is one of the highlights within the program.

The technical facilities for research, teaching and technology transfer at the TUM Research Center for White Biotechnology include a screening lab in Weihenstephan and a pilot plant for white biotechnology in Garching. The plant, unique in the international academic landscape, offers researchers access to new biocatalysts and bioproducts and provides students with practical training in the field. Fermenters with a capacity of up to 1,000 liters and the requisite facilities for the reprocessing of products allow researchers to examine how processes can be scaled up from laboratory to pilot scale.

Contact: [www.biotech.mse.tum.de](http://www.biotech.mse.tum.de)



## Fascinating research. A profession that creates knowledge.

**Benjamin Kick**, Graduate of the Master's Program in Industrial Biotechnology, MSE

Industrial biotechnology is concerned with the use of cells and organisms in technical applications – a link between natural science and engineering science, as it were. The possibility to deal with both of these aspects was the foundation for my current job as a research assistant at the Institute of Biochemical Engineering at Technische Universität München (TUM).

But let me start at the beginning. After high school I decided against taking over the family business and moved to Munich to study molecular biotechnology at TUM. After my bachelor's degree, which included six semesters and a broad-based study of plant biotechnology, medical biotechnology and industrial biotechnology, I decided to continue with a master's degree in industrial biotechnology, - providing the best interface between natural science and engineering science, in my opinion. I have always been very happy with my decision, and I was particularly convinced by the following aspects of my master's program:

- An individual and interdisciplinary curriculum chosen by me, in consultation with a mentor
- Extensive supervision and support, with small group sizes
- Promising career opportunities in the field of industrial biotechnology

A special highlight of my master's program was the internship in bioprocess engineering at the TUM Research Center for White Biotechnology. Here, starting from a two-liter bacterial culture in an Erlenmeyer flask, a process for the production of a green fluorescent protein was performed on a 1,000-liter scale. The product was then purified and we got an authentic feel for what it's like to work in a pharmaceutical company.

Another important aspect of my master's program was that the students always had the opportunity to gain experience in businesses or abroad, also outside of the university. During a several-month research internship at a company called Clariant, I was able to gain insight into the application of biotechnology in industry, and I also met a potential future employer there.

I am currently working for about two years as a research assistant in the Department of Biochemical Engineering at TUM on a research project of the International Graduate School of Science and Engineering. Here, in cooperation with the Institute of Biomolecular Nanotechnology of TUM, I am developing a production process for single-stranded DNA molecules that forms user-defined three-dimensional nanostructures. In addition to the scientific work, I also supervise students in internships and offer them insight into biochemical engineering, which is a lot of fun for me.

The combination of natural science and engineering science in my degree prepared me very well for familiarizing myself with such an interdisciplinary research project with partners from different fields.

Based on my own experience, I can highly recommend that those who are interested in science obtain a broad-based bachelor's degree and subsequently specialize within a master's program. And don't be deterred by the change in degree program and the related application formalities.

So now, after five years of study, I have found a job that challenges me every day. It never gets boring, and working together in a dedicated team is a lot of fun.

# Master's Program Human Factors Engineering

**Modern technical products and processes feature a number of desired attributes: they have to be easy and convenient to use, and they need to efficiently support their users while not causing any lasting detrimental effects for people. The trend toward even greater functionality and power density in technical products and processes makes this increasingly difficult to realize. Society and individuals today have ever-growing demands with respect to the comfort, safety and health aspects of the technology they use.**

Against this backdrop, it is clear that no scientific discipline can expect to be able to deal with this complex interplay of seemingly opposing requirements alone. Knowledge and insight from science, engineering and the humanities need to come together.

MSE is meeting this demand by offering the interdisciplinary Master's Program Ergonomics – Human Factors Engineering (HFE). This master's program qualifies students for a transition to a Ph.D., or for careers in the field of human factors and ergonomics.

The Master's Program HFE started in winter semester 2012/13 and is attracting an increasing number of students from TUM as well as from external universities both in Germany and abroad. There are currently 112 students registered in the program.

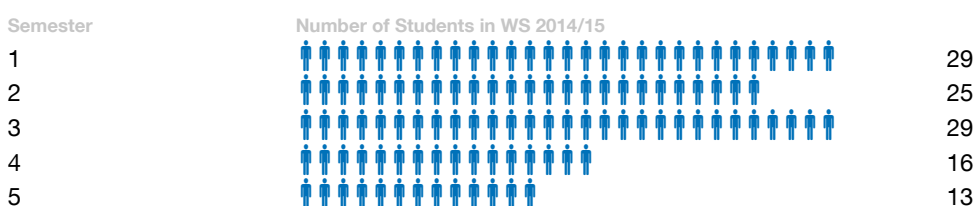

After graduation, our HFE graduates are specialists in the design, implementation and evaluation of future concepts for man-machine interaction in the automotive, aerospace, sports equipment, production and software industries. They have the ability to employ a range of interaction principles and technologies to achieve specific ends, to configure exactly the right automation levels, and to plan, execute and analyze the associated hypothesis-driven usability and controllability tests.

Our graduates are equipped to work with experts from other disciplines to plan and conduct needs assessments and to devise appropriate target processes.

In professional practice, they have the skills to lead a conceptual design or testing department.

---

## Teaching

In the research field, graduates of this program are in demand as experts who can take the above-mentioned development and testing methods to the next level and who possess the skills to address research topics on man-machine interaction across technical domains (e.g. cooperative adaptive systems in production mobility). Our training teaches them how to put together and coordinate interdisciplinary research teams to produce an efficient and productive working climate.

This includes activities in the following areas:

- Design and evaluation of technical products, consumer goods, software and websites
- Interaction design for mobile devices and information and communication media
- Security management in organizations that have the potential for high risk
- Research and development in the field of human-machine interaction and ergonomics

### Study Program Profile

The Master's Program HFE is taught predominantly in German and is aimed at graduates with a very good academic record from a bachelor's program in science or engineering, such as mechanical engineering, electrical engineering, computer science, sports science, psychology, architecture, design, etc.

It is a full-time program that comprises 120 ECTS points over 4 semesters.

In the first two semesters, lectures concentrate on topics related to human factors. The program continues with an interdisciplinary research project (third semester), such as: "Motion Recognition and Motion Categorization with Built-in Smartphone Sensors" or "Effects of Contrast on Human-Robot-Cooperation," and it ends with the master's thesis.

Contact: [www.hfe.mse.tum.de](http://www.hfe.mse.tum.de)

# Future Master's Program Engineering Science

Recent developments in the major societal challenges (“Grand Challenges”) show an increasing mutual perfusion of natural/life sciences and engineering. Thus, modern education in engineering is faced with the challenge of respecting classical disciplines while also including and representing interdisciplinary aspects. Such a development was anticipated, and was one of the reasons to establish MSE and its interdisciplinary Bachelor's Program “Engineering Science”. This program is successful in providing a broad and interdisciplinary basis for students, and enabling students to continue seamlessly with disciplinary master's programs at various STEM departments. In this way, MSE reinforces classical master's programs in STEM subjects at TUM. Aside of the disciplinary education at the master level, however, the need for scientifically oriented interdisciplinary education in engineering has emerged over the last decade in order to meet current and future needs in engineering science.

To address this need, a new interdisciplinary study program with a strong fundamental and scientific focus is being created. The Master's Program “Engineering Science”, with strict admission limitations, addresses an area of great significance for the economic and research environment in Germany, and particularly in Bavaria. It connects to the successful Bachelor's Program “Engineering Science”, but with an added focus on energy sciences and a strong research emphasis. Outstanding graduates from University education programs in STEM fields with a specific interest in a career in science and research will be given the opportunity to continue and extend their interdisciplinary, scientifically oriented engineering education. The primary emphasis will be on the physical and mathematical modeling of complex technical and physical systems. The term „modeling“ refers here to the penetration of systems by the basic engineering disciplines, and the ability to make predictions based on numerical calculations and simulation methods. Here, “prediction” is no longer restricted only to the purely deterministic description of the expected system state, but also includes uncertainty prediction (uncertainty quantification).

The shift of paradigm towards predictive simulations, i.e. prediction by simulation with a quantitative statement about prediction reliability (stochastic methods) that is currently taking place in engineering sciences, must be reflected in engineering education. With the new program we embrace this development and emphasize the teaching of basic probability theory, probabilistic considerations and methods in the various disciplines. Interdisciplinarity is essential in energy research, which reflects in tailored curricula and the opportunity to deepen education in energy research without neglecting the fundamental engineering sciences. Furthermore, an Advanced Research Internship, characterized by close mentoring and supervision in customized courses in which scientific reading and writing is fostered, will be an essential part of this program.

# Future Master's Program Power Systems and Energy Management

## Overview

The planned Master's Program in Power Systems and Energy Management will be a specialized course taking place at TUM Asia in Singapore, combining essential topics in power systems, renewable energy systems and technology-focused business with management courses. It aims to equip suitable candidates who have a physics, electrical or electronics background with energy-focused technology and managerial skills.

The Master's Program in Power Systems and Energy Management will provide opportunities for potential candidates to improve their knowledge in power systems and lay a solid foundation in the areas of economics, project management, environmental management and law that are essential for energy management. Applicants can also consider this program as a conversion program to change subjects from their undergraduate studies, or as an opportunity to conduct research for a career in academia.

This program will also contribute to furthering the mission to expand the international footprint of TUM. TUM is open to the world and stands for international academic exchange. Furthermore, the low accessibility of electricity in some areas, as well as the demand to convert from conventional to alternative energy resources, means there is a demand for engineers and managers in the energy management sector in many parts of the world. The high mobility of TUM graduates, and their international employment, will thus help raise TUM's international visibility.

This master's program will not only deliver researchers and engineers to the industry, but it will also benefit the relevant research at TUM. After completing their course work, some of the students may choose to write their master's thesis at TUM, and there is also a possibility for them to pursue a Ph.D. at TUM.

## Program Structure

The Master's Program in Power Systems and Energy Management will be a two-year, full-time program with a focus on research and management. Students will have to complete 120 ECTS (credit points) and 14 modules from the first to third semester, including 9 mandatory modules (6 core modules, 2 compulsory labs, and Business and Technical English) and 5 electives. Following the course work, students will have to complete a three-month research attachment and a six-month master's thesis in the fourth semester.

The internship and thesis project should address a topic related to power systems, and may be undertaken either at NTU or TUM or in the industry. The technical modules will be as follows:

### Mandatory Modules

- Introduction to the Power System
- Power Electronics
- Power Transmission and Distribution
- Electrical Energy Storage Systems
- Electromobility as a Component of Energy Efficiency
- Renewable Energy Systems & Grid Integration of Renewable Energies
- Business and Technical English
- Laboratory 1: Design of Energy Systems
- Laboratory 2: Energy Storage Systems

### Elective Modules

- Introduction to Business Logistics and Supply Chain Management
- Industrial Energy Economics
- Introduction to Law for Engineers
- Project Management
- Business Ethics
- Selected Chapters in Management

All modules and lectures offered will be organized in a block structure. The program can thus be completed in less than two years by increasing the semester workload. The curriculum is designed in such a way that students will be able to complete their research attachment and master's thesis overseas without having to prolong their studies. TUM Asia also encourages this in order to improve TUM Asia's reputation and to allow junior students to accumulate experience. To increase the number of students who go abroad, a voluntary German language course is offered.

The high mobility will be a distinguishing feature of this offshore master's program. Students will probably come from different parts of Asia, will be taught by lecturers from Germany and other parts of the world, and will work as engineers and researchers in power system business or management fields.

# MSE Student Council

The Student Council of the Munich School of Engineering (Fachschaft MSE) was founded in December 2010 and represents approximately 500 students. This includes the highly interdisciplinary B.Sc. “Engineering Science” and the two master’s degree courses “Industrial Biotechnology” and “Human Factors Engineering” (HFE). We organize various events, for instance the introduction to university life for freshmen, parties and several more. Furthermore, the Fachschaft MSE represents the students in political issues regarding the university, as well as providing scripts for all lectures. Another task is to take care of the TUM premises at the business campus in Garching-Hochbrück, including the student lounge Quantum.

All members work as volunteers being rewarded with the ability to enhance things concerning every aspect of studying. We all highly appreciate new members which are willing to contribute to the development of the MSE.

## Departments of the Fachschaft MSE

Each semester the new management and the leaders of the other departments get elected by all students of the MSE. Currently, we have eight departments: Freshmen, Evaluation, Finances, IT, PR, Events, Scripts and University Politics.





## Abstract of the biggest projects and achievements in 2014

- Symposium of general engineering science course of studies (AIS):**  
 In June 2014 the Fachschaft MSE had the opportunity to be the host of this symposium. Student representatives from the universities of Hamburg, Salzburg and Bayreuth came to Munich for three days to discuss and exchange views on the different general engineering science courses and related topics.
- T<sup>3</sup> – Top Teaching Trophy:**  
 For the first time there has been an award for the best lectures at MSE. The Evaluation-Department has conducted a survey among the MSE students and at the MSE summer party the winners received their prizes.
- Freshmen days:**  
 In October, 170 new students started their study of Engineering Science at MSE. The Freshmen-Department therefore organized two days for them to get to know the city and their new fellow students. Furthermore, a freshmen-brochure with numerous personal tips was created.
- Student-Council-Weekend:**  
 Once in a term the Events-Department organizes a weekend at a cottage in Austria for members of the Fachschaft MSE. Projects can be intensively worked on there and new members have the possibility to get to know each other and the work of the student council.
- Integration of the new Master's Degree Course HFE:**  
 The student representatives of HFE and Fachschaft MSE met in October 2014. Both parties agreed on a complete integration of the new study course into the student council. We are really grateful for their dedication and interest in our activity.
- Regular get-together events (Stammtisch):**  
 Every third week we arranged a regular's table for all MSE students. It turned out that this is especially helpful to strengthen the connections between the different courses and years.
- Fachschaft MSE-Cloud:**  
 The IT-Department created a self-hosted and self-managed cloud system for the interchange of lecture materials and study related data. Additionally, the digital files of the student council were migrated to the new system.





# Research

---

<b>General Overview</b>	68
<b>TUM.Energy Valley Bavaria (EVB)</b>	69
<b>Flexible Power Plants</b>	70
<b>Junior Research Groups</b>	
<b>Energy Efficient and Smart Cities</b>	82
<b>Organic Photovoltaics</b>	87
<b>Control of Renewable Energy Systems</b>	92
<b>Seed Funding Projects</b>	99
<b>EEBatt</b>	110
<b>Center for Power Generation (CPG)</b>	118
<b>Network for Renewable Energy (NRG)</b>	130
<b>Science Center for Electromobility (WZE)</b>	142
<b>Centre for Sustainable Building (ZNB)</b>	154
<b>MSE Colloquium 2014 “Energy in motion”</b>	168
<b>TUM Applied Technology Forum</b>	170
<b>Energy in Context</b>	172
<b>Internationalization</b>	173

# General Overview

The MSE is still working on research formats optimally suited to tackle the challenging task of transforming the energy system into a post-carbon age. In times when research was mainly focused on nuclear research, big research centers designed and operated large experimental facilities and helped industry to launch demonstrators. The new post-carbon age will be mainly based on renewable energies supported by fossil fired facilities which need to become more flexible and more efficient. This is true throughout all sectors including the power sector, the heating and process heat and the mobility sector. These new challenges require a new research organization which can best be described by two terms: more diverse and more flexible. Both can be best achieved in the environment of a leading technical university.

The formats of the MSE range from large projects like “Flexible power plants” and “EEBatt” to the young research groups to seed-funding projects.

The project on “Flexible power plants” combines state-of-the-art thermodynamics and process engineering with simulations from the power plants level to the European power grid. This will give a good basis to plan future power plant technologies which will certainly be necessary for a long time, even if renewables reach permeation rates of 80 % and more.

The “EEBatt” project spans the whole area from the chemical and physics fundamentals of stationary batteries to the application in a small Bavarian village to improve integration of photovoltaics (PV) into the power grid up to modern production technologies to manufacture batteries at competitive costs.

The young research groups are especially helpful to fill the gap between the faculties. The this year newly formed group “Control of Renewable Energy Systems” is a brilliant example which shows how the bridge between two engineering faculties can best be bridged by young research groups. This new group with a strong background in electrical engineering found a home in the newly formed chair on windenergy in the mechanical engineering department.

The seed-funding projects show how flexible the university can react to new challenges and form fast new working groups targeting various research fields.

The structure consisting of big projects between faculties, young research groups and seed-funding projects will be further elaborated to form a structure which is a convincing answer to the urgent challenges.

# Research Projects: TUM.Energy Valley Bavaria (EVB)

## **TUM.Energy Valley Bavaria**

Duration:  
01.06.2012 - 31.12.2016/18

**Project Coordination:**  
**Prof. Gasteiger,**  
**Prof. Hamacher,**  
**Prof. Wall**

Funding: 10 Mio. €

by Bavarian State Ministry of  
Education, Science and the Arts

Bavarian State Ministry of  
Education, Science and the Arts



# Flexible Power Plants

[www.evb.mse.tum.de](http://www.evb.mse.tum.de)

## Heads

**Prof. Dr. rer. nat.  
Thomas Hamacher**  
Renewable and Sustainable  
Energy Systems,  
Department of Electrical  
and Computer Engineering

**Prof. Dr.-Ing.  
Thomas Sattelmayer**  
Thermodynamics,  
Department of Mechanical  
Engineering

**Prof. Dr.-Ing. Hartmut Spliethoff**  
Energy Systems,  
Department of Mechanical  
Engineering

**Prof. Dr.-Ing. Rolf Witzmann**  
Power Transmission Systems,  
Department of Electrical  
and Computer Engineering



**Prof. Dr.  
Thomas Hamacher**



**Prof. Dr.-Ing.  
Thomas Sattelmayer**



**Prof. Dr.-Ing.  
Hartmut Spliethoff**



**Prof. Dr.-Ing.  
Rolf Witzmann**

The integration of a rising share of renewable energy poses a challenge for the conventional generators in the power system. In the past, thermal power plants were mostly operated statically. Because of former high capacity utilization and only a few load changes, the power plants were designed for maximum efficiency at nominal load. Today these power plants produce the energy that cannot be generated by renewable sources. In addition to high efficiency they have to provide short start up times, fast load-change gradients and low minimum loads. To ensure a cost-efficient and stable supply system, changes in the conventional power plant technology and network infrastructure are essential.

The interdisciplinary project „Flexible Power Plants“ aims to bridge the gap between power generation and the electrical network. Measures for flexibility improvements are analyzed both experimentally and through simulations. The experiments investigate the limitations of power plants’ flexibility and improvement potential. The results can be used in superordinate simulations. To investigate the effects on the stability of power grids and to optimize the interaction of generation and distribution of energy, models are developed that describe the Bavarian (and overall German) energy landscape. The goal is to define measures that will help to adapt today’s generation system to the needs of the future and to enable the transition to cleaner energy without risking the security of supply.

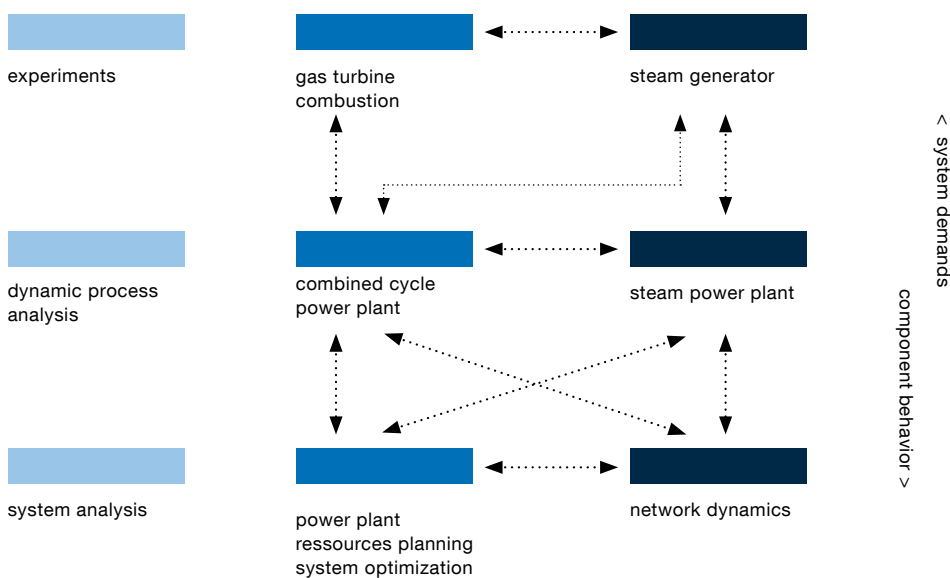

■ **Flexible power plants.** In the experimental works, gas turbine combustion and steam generation are analyzed in detail. The results are used as input data for dynamic process simulations of combined cycle and steam power plants, providing the required data for the simulation of the grid and of the overall energy system.

## Modelling of the European Power System

**Contact:**

**Matthias Huber**  
 Renewable and Sustainable  
 Energy Systems  
 Department of Electrical and  
 Computer Engineering

[matthias.huber@tum.de](mailto:matthias.huber@tum.de)

The objective of this subproject is to assess the flexibility requirements of the European electricity system for a range of potential renewable expansion scenarios. Further, the project aims to evaluate the performance of flexible power plants in the context of future transmission system scenarios. The combination of these investigations will ultimately provide an informed outlook on the optimal deployment of flexible power plants in the European system.

In order to facilitate the aforementioned research, a detailed load flow model of the European electrical transmission system has been constructed. The model includes all high-voltage lines, conventional generators, transformers, loads and renewable energy installations. The model is interfaced with time-series interpolated regional weather data (solar and wind) and time-series load data, allowing the calculation of residual load at the bus level throughout the system. The model is further interfaced with a unit commitment and dispatch algorithm, which provides an optimal dispatch of conventional generators for each time-instant.

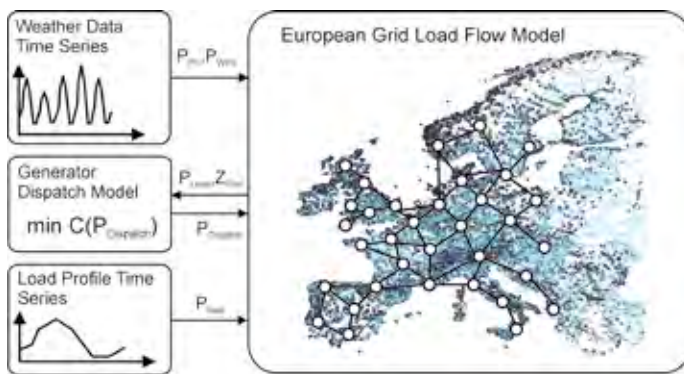

- **Unit commitment and dispatch modelling.** The combination of detailed time-series weather data and load data with a novel dispatch algorithm and hyper-detailed load flow model represents the state-of-the-art in power flow modelling.

The unit commitment model is based on an innovative approach that models power plants in more detail. A new variable, the plant temperature, is introduced and allows for a more efficient and more accurate calculation of start-up costs and start-up times. This novel approach outperforms the current state of the art and is therefore a first result of the research itself.

The model calculates the hourly cost optimal commitment and dispatch for each individual power plant in Europe. An entire year for different scenarios is calculated based on a rolling planning horizon. The scenarios can vary the installed renewable capacities and the grid extensions as well as the input for the conventional power plant fleet. Varying the flexibility parameters of power plants allows us to investigate their system value under different operational regimes.

Finally, the computed dispatch decisions can be fed into the dynamic grid modelling for research on grid stability and necessary grid extensions.

## Power Flow and Dynamic Modelling

Particularly in the context of integration of intermittent renewable energy sources, power system flexibility is heavily dependent upon generator ramping capability, transmission line capacity and the correlation between (weather dependent) generation and load. For example, the concurrence of high renewable generation, low load and lack of available export capacity in a region would result in the curtailment of the excess renewable generation in that region (i.e. loss of energy). In order to minimize the occurrence of such scenarios, areas in which generator ramping capabilities are insufficient and transmission lines are frequently overloaded must be identified.

Through time-series simulation of multiple generator deployment strategies, the effect of regional flexibility enhancements has been quantified. With the aim of maximizing the utilization of intermittent renewable generation sources, an optimal flexibility enhancement strategy is under development. Future work will assess the dynamic performance of such strategies through RMS (Root Mean Square) simulation.

### Contact:

**Steffen Kahlert**  
Energy Systems  
Department of Mechanical  
Engineering

[steffen.kahlert@tum.de](mailto:steffen.kahlert@tum.de)

**Julia Hentschel**  
Energy Systems  
Department of Mechanical  
Engineering

[julia.hentschel@tum.de](mailto:julia.hentschel@tum.de)

## Dynamic Power Plant Simulation

In the context of dynamic process simulation, the interactions of the power plant processes at flexible operation are investigated. Besides the efficiency of the overall process, the transient behavior plays an important role. The simulation software APROS is used which allows dynamic modeling of the power plant performance including automation. Thus, complex procedures such as start-up/shut-down and load cycles can be analyzed. An improved process understanding helps to develop better operating strategies and optimized power plant configurations. To identify the need for research and to create detailed process models, the simulations are done in close collaboration with our industry partners.

## Combined Cycle Power Plants

Due to changing conditions, the flexibility of the power plant is essential to support the grid stability and to assure an economical operation. This relates especially to the load flexibility whereas cogeneration plants see the need to decouple electricity and heat production to react to market signals. Regarding the combined cycle power plants, the cogeneration plant München Süd has been chosen as a reference plant. It is a unit with a capacity of 420 MW, which both produces electricity and provides district heating. Especially during summer, the power plant has a low utilization and a dynamic operation is required. It has been investigated if a quick start-up can be performed and which start conditions have to be ensured to avoid damages of the heat recovery steam generator. The interaction of the gas turbine, the supplementary firing and the steam turbine has been investigated. Thus the potential for load change gradients and the impact on the critical components could be determined.

Industry cogeneration plants are mainly operated in base-load and therefore have different requirements regarding flexibility. Short-term load changes are desirable to provide frequency response and the ratio of electricity to heat production should be adjustable. Most important, the flexible operation must not affect the process steam production.



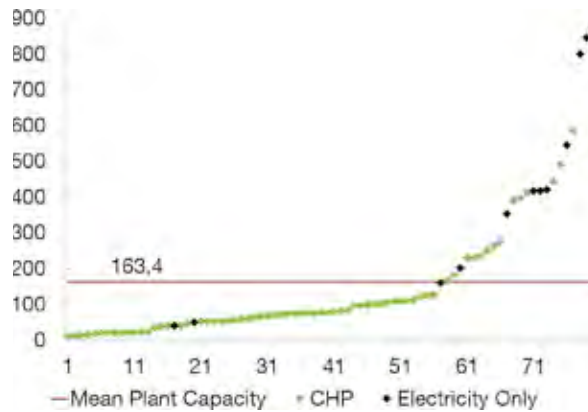

- **Combined cycle power plants in Germany:** The most important power plants are not those producing electricity only, but those producing combined heat and power.

In cooperation with Eon Energy Projects and Eon Asset Services, the Power Plant Planting, a cogeneration combined cycle unit, is simulated dynamically. The goal is determine the impact of secondary frequency response on the gas turbine and the heat recovery steam generator. Furthermore, the potential for additional system services and the room for improvement regarding the control system of the power

### Coal-fired Power Plants

With regard to a coal-fired power plant, the influence of a more flexible plant operation on the share of lifetime consumption by fatigue was investigated. To do so, the reduction of the share of fatigue in the thick-walled components of a forced circulation steam generator by an electrical surface heating system has been simulated. The necessary models for the steam drum, the high-pressure and the intermediate superheater headers were created using reference data of a power plant with appropriate materials and dimensions. In order to reduce the thermal stress contribution to the total stress range of a load cycle,

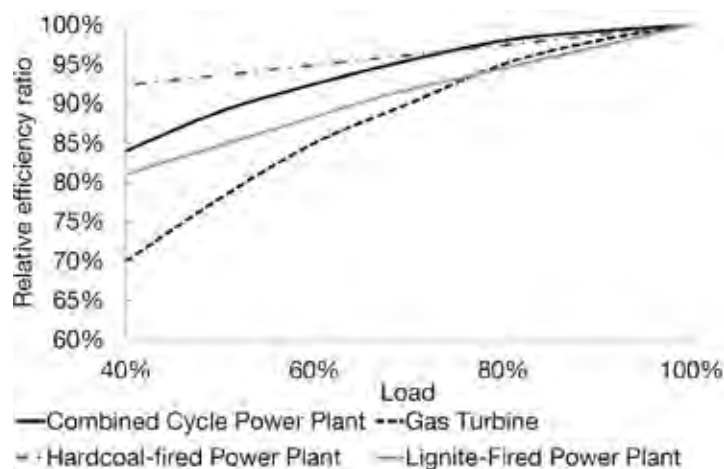

- **Part load behavior gains importance in power plant operation.** Decreasing efficiencies lead to higher emissions and lower profitability.

a heating strategy for the critical components has been developed. This is also useful to limit the thermal stress during accelerated cold start-ups. Due to a possible acceleration of start processes with respect to the thick-walled component, savings in fuel consumption lead to a significant reduction of start-up costs. To better address the need of controllability in power generation, the next step is to improve the control strategy of coal-fired boilers using dynamic simulation. Therefore, a holistic model of the water-steam cycle of a typical state-of-the-art hard coal fired power plant has been built up, considering an integrated firing system and air preheating systems. An important part of the model is the adequate mapping of the distinctive control systems. The aim is to increase the control performance in consideration of the lifetime consumption. Thus, the validated dynamic model is to be modified in specific control parameter settings and the implementation of observers in suitable control circuits. In terms of evaluation of the optimized control system, a software tool enabling the impartial comparison of changed properties in terms of stability and control precision.

## Gas Turbine Combustors

Due to the unsteady power output of energy systems based on renewable energies load fluctuations in the electrical grid arise. In order to ensure uninterrupted service of power the fluctuations in the electrical grid have to be compensated by fossil fuelled energy systems, e.g. gas turbines. With a rising share of renewable power systems in the energy mix the flexibility of gas turbines has to be increased in order to maintain this ability.

### Water Injection into Gas Turbine Combustors

Due to its positive influences water injection in gas turbine combustion chambers has found industrial application in various gas turbine cycles. Power augmentation as well as a significant reduction in NO<sub>x</sub> emission concentrations due to the water injection has been found for non-premixed combustion in gas turbines.

This project seeks to realize the benefits of water injection also for state-of-the-art combustors with premixed combustion. Furthermore for a given level of emission concentrations the power output is desired to be maximized. Key parameters of the premixed combustion with water injection as well as design rules for water-injected gas turbine combustors are to be found.

In the first stage of the project a single-burner test rig has been designed and put into operation. The feasibility of premixed combustion with water injection has been demonstrated and first investigations have been carried out. In the second stage a detailed characterization of the combustion with water injection will be carried out.

Lean premixed combustion provides high power densities and reduced flame temperatures. As a consequence less cooling air compared to conventional combustion techniques is required in the combustor, whereas reduced damping capabilities may decrease the combustion stability. These phenomena are well known as “thermoacoustic instabilities” and their occurrence is subject of current research. In this sub-project, the impact of water addition on the thermoacoustic stability of gas turbine combustion chambers is investigated.

#### Contact:

**Stephan Lellek**  
Thermodynamics  
Department of Mechanical  
Engineering  
[lellek@td.mw.tum.de](mailto:lellek@td.mw.tum.de)

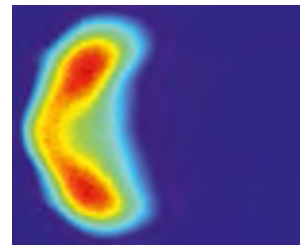

■ Natural gas flame with water injection



■ Lean-premixed flame with water-injection, visualized by Mie-Scattering

Recently, a single burner test rig has been designed to facilitate highly precise acoustic measurements being able to characterize effects of water injected flames on the thermoacoustics. Commissioning of this system went smoothly and first measurements could be carried out. Experimental approaches to determine the stability of gas turbine combustors have been developed and further enhanced during this project. Current investigations focus on verifying the applicability of these methods to water-injected, lean-premixed combustion. The next steps include further experimental work to finally derive accurate models predicting the stability of water injected gas turbine combustors.

### **Fuel Processing to Increase Stability in Part Load Regime of Gas Turbine Combustors**

Modern gas turbines are operated at a high air excess ratio for a very lean premixed combustion. This is advantageous for the emissions, but it does not hold much potential for a load reduction by means of a decrease of fuel injection due to stability problems and lean blow out (LBO).



■ Syngas reactor test rig

Syngas (blend of mainly carbon monoxide and hydrogen) has a higher LBO limit and could be used as fuel in the part load regime. The addition of even a small share of syngas to the main fuel thus enhances stability and holds the potential for a leaner combustion. Syngas needs to be produced within the gas turbine process by reforming natural gas to lower efficiency losses.

In the scope of the project a syngas reactor, suitable for the integration in a gas turbine process, is built and tested. First ignition tests show promising results. Further syngas production tests will be carried out to show the efficiency of the process.

By the integration of the syngas reactor in a combustion test rig premixing of syngas and air without prompt ignition or flashback and the potential for a higher lean blow limit by means of syngas injection in the combustion stage will be shown.

# High Pressure Evaporation Rig HIPER

The components of flexible power plants, especially the steam generator, are strongly affected by increased plant dynamics. It will be exposed to transient loads and more frequent operation at minimum and partial load. In a state of the art power plant operating in sliding pressure control mode, evaporation during stationary and transient partial load operation occurs at near-critical and subcritical pressures. Past experimental studies were not yet able to adequately describe and quantify the heat transfer phenomena at near-critical pressures, as the physical properties of the working fluid are subject to significant variations of temperature. Thus, the operation of current power plants is restricted to relatively low gradients in order to ensure the safety of the plant. In order to match the power plants to the demands of a highly fluctuating residual load, the possible gradients at part load operation have to be increased. The High Pressure Evaporation Rig HIPER is designed for transient experiments at part load conditions. This rig is currently under construction and in the past year significant progress has been made towards its commissioning.

HIPER essentially consists of a closed thermohydraulic cycle, in which heat transfer and pressure drop at high temperatures and pressures can be investigated. The process schematic is shown in figure X. The cycle is fed with deionized water by a high pressure piston pump. In order to adjust the thermal conditions for the entry of the test section a preheater is located before the evaporation tube. The preheater consists of a tube that is directly electrically heated with a relatively moderate heat flux density to prevent unstable conditions. Downstream from the preheater, the water flows through the experimental evaporation tube. This test section also is electrically heated. It is designed so that the heat flux density can be adjusted in a wide range to reach the same parameters as they occur in real power plants. The test section is equipped with multiple measurements for pressure, temperature and differential voltage. The pressure in the evaporation tube is regulated by two throttle valves.

To ensure the functionality of the principle of this setup, a small scale pilot rig, similar to HIPER, has been constructed and commissioned. It has shown that the principle of the cycle works in the desirable way. It has proved the function of the direct electrical heating and the backpressure regulation with a throttle valve. A thermographic recording of the pilot rig's evaporation tube are shown in figure Y. In the shown experiment, a dryout of the evaporation tube occurs, leading to rising wall temperatures. This phenomenon is also of interest for planned investigations with HIPER.

The pilot test rig also allowed the development of methods for the Design of Experiments (DOE) for later use with HIPER.

The detailed engineering for most components of HIPER has been completed in 2014. All the systems and components have been designed individually for the test rig to be able to withstand the real time parameters of a power plant, including a safety margin for the experiments. The major components, such as the feed water tank, the high pressure pump and the main power supplies were already delivered in the past year.

**Contact:**

**Andreas Kohlhepp**  
Energy Systems  
Department of Mechanical  
Engineering  
[andreas.kohlhepp@tum.de](mailto:andreas.kohlhepp@tum.de)

**Gerrit Schatte**  
Energy Systems  
Department of Mechanical  
Engineering  
[gerrit.schatte@tum.de](mailto:gerrit.schatte@tum.de)

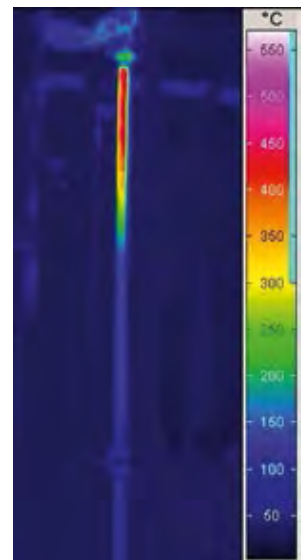

■ Thermographical recording of the pilot rig's evaporator tube at dryout conditions.

---

## Research Projects

### TUM.Energy Valley Bavaria (EVB)

The public buildings authority, responsible for the building's infrastructure, has been put in charge of providing the electrical connection to the plant in May 2014. The realization of the connection is still pending, but hopefully it will be done in 2015 to begin with the planned experimental investigations.

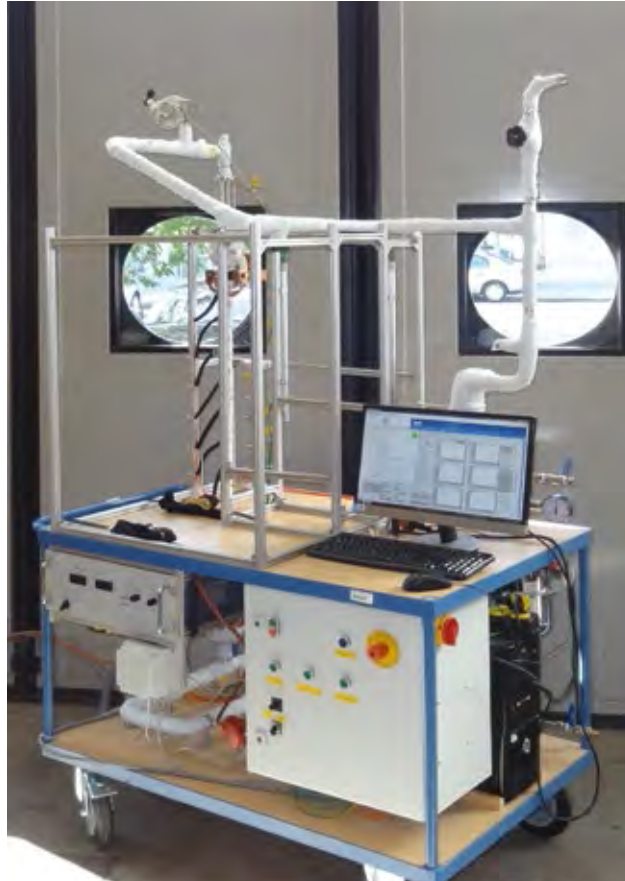

- **The pilot test rig proved the basic thermohydraulic layout and the strategy of regulating the system of HIPER.** It now is used for teaching purposes as well.

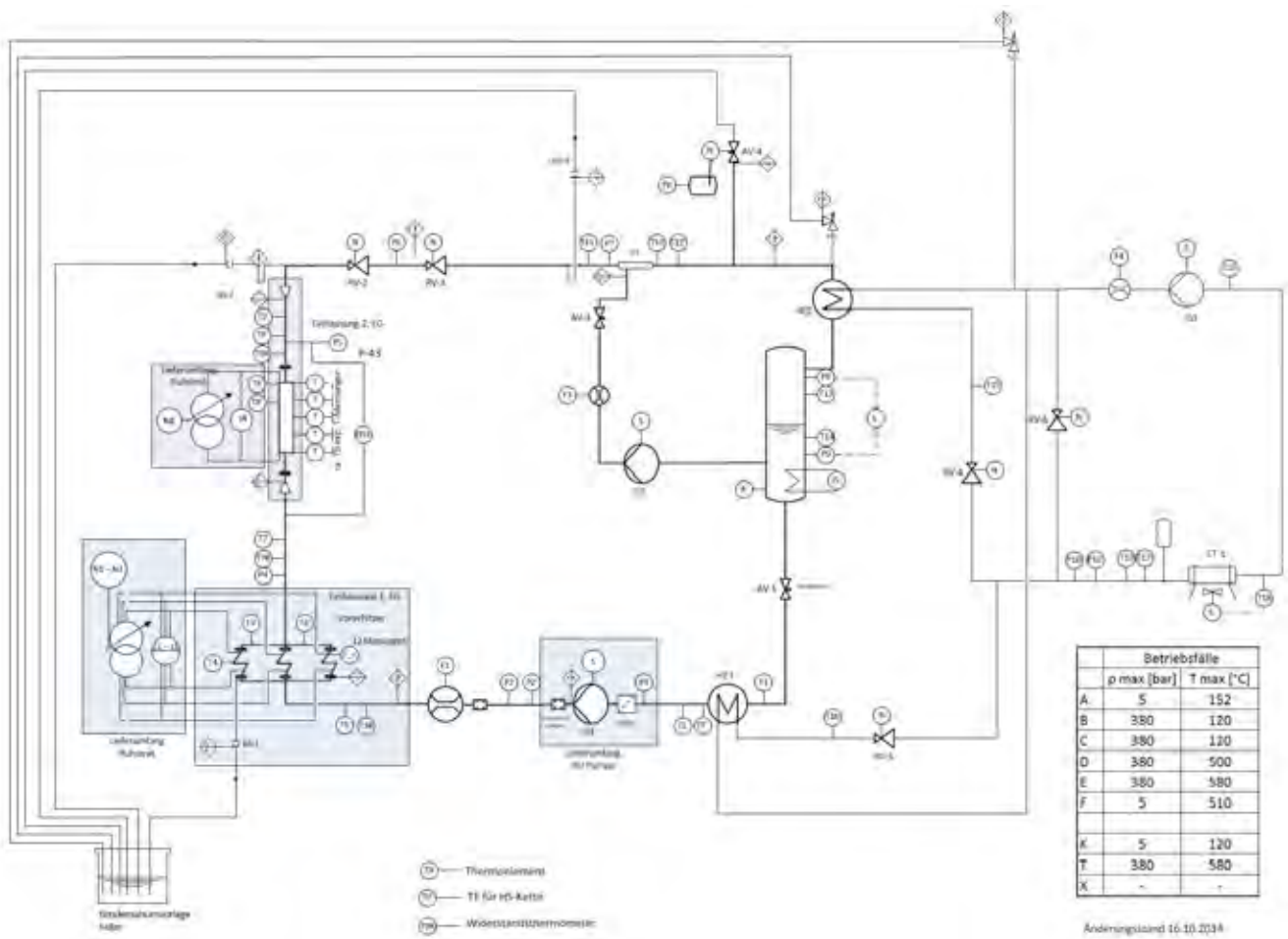

- The setup of HIPER consists of a high-pressure circuit, a feed water section and a cooling system.

## Flexible Power Plants Team

The Flexible Power Plants research group embodies the interdisciplinary orientation of the Munich School of Engineering. This group forms a bridge between the Faculty of Electronic Engineering and the Faculty of Mechanical Engineering. 4 chairs bring their specific expertise into innovative solutions. Including 9 young researchers, the research group is the largest in the project “Energy Valley Bavaria”.

- **Ms. Julia Hentschel** started her work at the Department of Energy System as a research assistant and is going to deal with the dynamic simulation of coal power plants. The goal is to achieve an optimization of the control system. Previously she did her master studies at TUM and finished with her thesis „Optimization of a conventional power plant startup process by heating of thickwalled components.“ During her previous studies of Mechanical Engineering she has been preoccupied with the thermal hydraulic simulation of nuclear power plants in terms of accidents.
- **Mr. Max Baumgärtner** obtained a diploma degree in Mechanical Engineering from the RWTH Aachen university in 2012. He joined the Flexible Power Plants team in January 2013. His research at the Chair of Thermodynamics focuses on the expansion of the part load regime of gas turbines by means of fuel reforming.
- **Mr. Nicolai Stadlmair** studied Mechanical Engineering with the focus on thermofluid-dynamics and renewable energy systems at TUM and graduated with a Diploma in 2012. He joined the Energy Valley Bavaria Team in 2013 and his research concentrates particularly on the flame dynamics in gas turbine combustors.
- **Mr. Stephan Lellek** studied Mechanical Engineering with the focus on thermofluid-dynamics, aero engines and gas turbines at TUM and graduated in 2013. He joined the Energy Valley Bavaria team in 2013 and his research concentrates particularly on the operational limits of gas turbine combustors.
- **Mr. Dominic Hewes** studied Electrical & Electronic Engineering at Imperial College London. As part of an RWE scholarship program, he gained experience in the field of wind power grid integration. Since October 2013, Mr. Hewes has worked as a doctoral researcher at the Institute of Power Transmission Systems with a research focus on the dynamic behavior of the European transmission system.
- **Mr. Matthias Huber** obtained a Master’s Degree (Dipl.-Ing.) in Mechanical Engineering from TUM and a B.Sc. in Economics from LMU, both in 2010. His research focuses on the modeling and valuation of flexible power plants within the European power system.
- **Mr. Gerrit A. Schatte** is involved in the project since April 2013. His previous studies at TUM focused on sustainable energy systems and fluid process engineering. For his diploma thesis, he investigated the catalytic conversion of syngas to liquid fuels in microreactors at the MIT chemical engineering department. His interest in energy conversion and future energy systems sparked his initiative to join the EVB team.
- **Mr. Andreas Kohlhepp** studied Mechanical Engineering at the UAS Würzburg-Schweinfurt and TU Dresden with the focus on product development and power engineering. Before he joined the EVB-Project he was working at E.On Kernkraft GmbH for nearly four years. In his Diploma thesis he developed the basic setup of the measurements for the evaporation test rig HIPER, now the setup of this test rig and later the realization of the evaporation experiments are his scientific tasks.
- **Mr. Steffen Kahlert** is responsible for dynamic simulation of combined cycle power plants. He obtained his diploma in Mechanical Engineering with a focus on waste heat recovery and turbo machinery from Leibniz Universität Hannover. Besides his research, he works as a coordinator of the Center for Power Generation.



**Julia Hentschel**



**Max Baumgärtner**



**Nicolai Stadlmair**



**Stephan Lellek**



**Dominic Hewes**



**Matthias Huber**



**Gerrit A. Schatte**



**Andreas Kohlhepp**



**Steffen Kahlert**



# Energy Efficient and Smart Cities

**Head:**

**Dr. Vicky Cheng**

[vicky.cheng@tum.de](mailto:vicky.cheng@tum.de)

Research Group  
„Energy Efficient and Smart Cities“  
Business Campus  
Parking 37  
85748 Garching-Hochbrück  
Tel: +49 (0)89 289 10642

[www.eesc.mse.tum.de](http://www.eesc.mse.tum.de)

**Cities as hotspots of activities and growths hold the key to an energy efficient and sustainable future. The highly concentrated but yet diverse energy use patterns in urban areas offer great opportunities for energy savings particularly through better coordination between the demands and different supply systems. The ‘Energy Efficient and Smart Cities’ research group seeks to explore ways to harness this potential and to help making our cities more energy-efficient and carbon neutral.**

The ‘Energy Efficient and Smart Cities’ (EESC) group was founded in 2013 as part of the Energy Valley Bavaria programme of the Munich School of Engineering. The research interests of the group are centred on integrated urban energy planning and their work covers a range of topics including the coordination of electricity and heat in urban areas, applications of renewable technologies and energy efficiency of the built environment.

With supports from the City’s Planning Department, EESC is undertaking a study to understand the energy use patterns in the metropolitan area of Munich. As the capital of Bavaria, Munich is one of the most vibrant and fastest growing cities in Germany. The prosperity of the city, however, relies heavily on the burning of fossil fuels. The main objective of this work is to investigate the demands and supplies of energy in the city and find ways to improve energy efficiency, to increase the use of renewable sources and to reduce greenhouse gas emissions.

In the past two years, a number of projects have been initiated to pursue the aims of the research group. The following section presents some of the ongoing work and past activities of EESC.

## Residential Electricity Modelling

**Contact:**

**Akhila Jambagi**

[akhila.jambagi@tum.de](mailto:akhila.jambagi@tum.de)

**Michael Kramer**

[michael.kramer@tum.de](mailto:michael.kramer@tum.de)

To develop strategies for improving the energy efficiency of cities it is important to understand the existing energy use patterns. The EESC group is therefore working on developing an accurate and realistic model of residential electricity demand using the city of Munich as a case study.

Different energy efficiency measures operate on different space and time scales, and so to be used for evaluation of these measures a necessary property for the model is a flexible time and space resolution. The model can simulate at a level of detail of single households with a time resolution of seconds. Furthermore to ensure a correct aggregate demand, the demand of the total population approaches the Standard Load Profile (SLP).

To accurately simulate household demand, individual appliance loads should be simulated for which there are two existing approaches. Firstly activity-based modeling, which uses Time Use Surveys to estimate probabilities of events. Secondly using aggregated data (SLP), and a breakdown of energy consumption per activity to generate events.

The novel approach of this work is to combine these two methods, using activity-based modelling for the more predictable loads, and then assigning the remainder using the standard load profile. This method will ensure that both the individual household loads are realistic, as well as the aggregated load for the total population.

The model will be integrated with a spatial database which contains information of existing buildings in the metropolitan area of Munich.

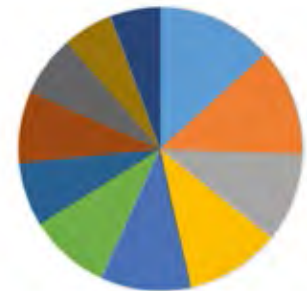

- Office
- TV/Audio
- Refrigeration
- Lighting
- Cooking
- Drying
- Miscellaneous
- Circulation pump
- Dishwashing
- Washing
- Freezing

■ 4 Person Household Activity Share  
(Energieagentur NRW 2011)

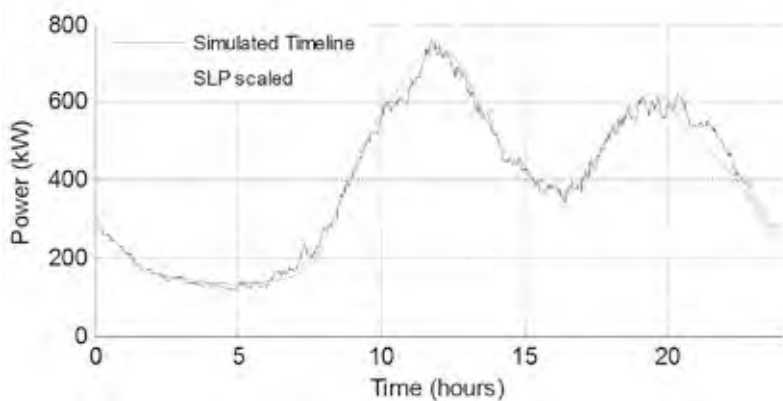

■ Simulation result for 1.000 households

## Network Design and Yield Optimisation of Solar District Heating Systems in Multi-Storey Residential Buildings

In the past, the use of solar thermal assisted district heating systems has been focused on centralised integration of solar components including large, seasonal storages. However, for energetic renovation of densely built-up areas, the feasibility is often limited by the spatial constraints related to the heat supply systems, heat storages and the distribution network. This impedes seasonal storage concepts in urban areas and hinders the applications of large solar-thermal systems.

To overcome this issue, this research aims to investigate the design of distributed solar collector arrays and thermal heat storages in buildings. The novelty of the project is a bi-directional heat distribution. This enables storages in buildings with a lower heat demand to supply buildings in the heating network of higher heat demand. On top of that, solar-thermal energy can be transferred from the collector arrays to storages and end-users anywhere in the heating network. The investigation will show whether the intelligent interaction of the system components can adequately compensate for the lack of storage

Contact:

Daniel Beckenbauer

[daniel.beckenbauer@thi.de](mailto:daniel.beckenbauer@thi.de)

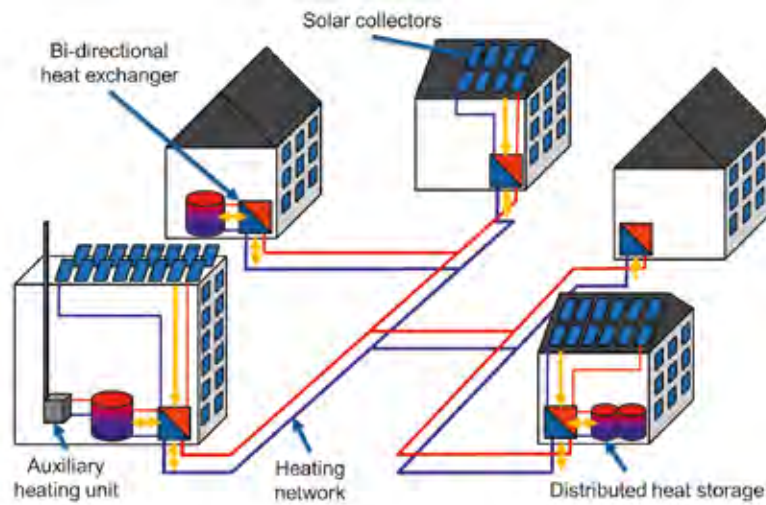

■ Intelligent solar district heating network

capacity as compared to the seasonal storage concept. The results will help to reduce the costs for solar heating and in turn, increase solar fraction in the heat supply mix.

## Theoretical and Experimental Analysis of Polymer-Based Solar Thermal Drain Back Systems

**Contact:**

Mathias Ehrenwirth

[mathias.ehrenwirth@thi.de](mailto:mathias.ehrenwirth@thi.de)

The application of solar thermal heating systems among single-family houses is currently restrained by high investment costs and long pay-back time. In order to compete with other renewable energy systems, further cost reduction is necessary. In this context, polymer-based solar collectors can provide a valuable contribution due to low raw material costs.

A well-known problem of solar thermal systems is stagnation, which leads to the evaporation of the heat transfer medium and poses a challenge both to plastic components and the heat transfer medium. The open, unpressurized architecture of a drain back system is able to overcome these problems. The aim of this project is to identify of an optimal drain back system with polymeric components, taking into account investment as well as running costs. Various advantages of polymers such as low material prices, light weight, flexibility in design and a wide possibility of manufacturing techniques can contribute to cost-effective solar thermal applications in the future.

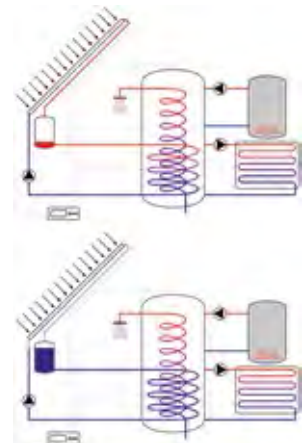

■ Drain back system in idle (top) and system in operation (bottom)

## Geothermal Energy for Heating and Cooling in Buildings

Germany has a substantial geothermal heat resource which is currently underutilised. The Federal Government has set out plans to significantly increase the contribution of geothermal in its overall energy mix. Munich situated within the Molasse Basin has great potential for harnessing geothermal heat.

In collaboration with the Geotechnical Engineering Laboratory at the Korea Advanced Institute of Science and Technology (KAIST), EESC initiated a study to investigate the technical and economic potential of geothermal applications for heating and cooling in the urban areas of Munich. This work will include the evaluation of thermal performance and initial costs of different types of ground heat exchangers taking into account the ground thermal conductivity and other local geological properties. The research exchange activities are funded by the Erasmus Mundus: Euro-Asian Sustainable Energy Development (EM-EASED) programme.

Contact:

Dr. Vicky Cheng

[vicky.cheng@tum.de](mailto:vicky.cheng@tum.de)



■ Potential geothermal applications in multi-family buildings

## Low Carbon Urban Design Studio in Beijing

China is undergoing an unprecedented urbanisation process as a large influx of rural population migrate to cities. This leads to intense pressure for urban expansion to meet the growing demand for housing and employment. Besides, a substantial proportion of the existing building stock in China was built before 1980 with a planned lifespan of 50 years or less. As a result, significant retrofitting or rebuilding is expected to take place in many Chinese cities in the coming decades.

The rapid urban growth and the short-term needs for urban renewal mean that Chinese cities have a high degree of plasticity in the development of land use, infrastructure and urban built form. This gives rise to great opportunities for reshaping the existing city regions to achieve a low-carbon pathway.

The Low Carbon Urban Design Studio aimed at developing new ways to improve the practice of clean energy design in Chinese cities. It was jointly organised by Tsinghua University, MIT, University of Cambridge, Chongqing University and TUM (EESC). The studio brought together some 15 faculty members and more than 35 students with a diversity of backgrounds (architecture, urban planning and building engineering) in Beijing for a month in June 2014 to work on an urban renewal case study. The activity was funded by the Energy Foundation (US) and Stiftung Mercator (Germany). It was a very rewarding and fruitful experience for all involved.

Contact:

Dr. Vicky Cheng

[vicky.cheng@tum.de](mailto:vicky.cheng@tum.de)



■ The EESC-Team

## The Team

The 'Energy Efficient and Smart Cities' research group consists of a young and international team led by Dr. Vicky Cheng. The team places strong emphasis on interdisciplinary research and it fosters an open culture for innovation.

### Group Leader: Dr. Vicky Cheng

Dr. Vicky Cheng obtained a BEng(Hons) in Building Services Engineering and an MPhil in Environmental Architecture in Hong Kong. She was awarded a Cambridge Overseas Trust scholarship to study at the University of Cambridge where she obtained a PhD. She has published, as well as served as a reviewer in major international journals. Besides academic research, Vicky has engaged in a number of government consultancy projects in the UK and Hong Kong, in which she applied her research findings into practice.

### Researchers

- **Daniel Beckenbauer**, Dipl.-Ing (FH) in Mechanical Engineering (Applied Technology Forum)
- **Cherifa Ben Ammar**, M.Sc. in Environmental Engineering
- **Mathias Ehrenwirth**, M.Eng in Applied Computational Mechanics (Applied Technology Forum)
- **Akhila Jambagi**, M.Eng in Electrical and Electronic Engineering with Management
- **Michael Kramer**, M.Sc. in Industrial Engineering specialised in Electrical Engineering

### Student Helpers

- **Anahi Molar Cruz**, B.Sc. in Mechanical Engineering
- **David Furtado**, B.Eng in Mechanical Engineering

### Publications

- [1] M. Hughes, J. Palmer, V. Cheng and D. Shipworth, "Global sensitivity analysis of England's housing energy model", *Journal of Building Performance Simulation*, available online.
- [2] A. Jambagi, M. Kramer and V. Cheng, "Modelling residential electricity demand at high temporal and spatial resolution", *MSE Colloquium 2014: Energy in Motion*, 3rd July 2014, Munich.
- [3] D. Beckenbauer, V. Cheng and W. Zörner, "Network Design and Yield Optimisation of Solar District Heating Systems for Urban Applications", *MSE Colloquium 2014: Energy in Motion*, 3rd July 2014, Munich.

# Organic Photovoltaics

**The Herzig Group is one of the three research groups established at the MSE within the framework of the Energy Valley Bavaria project. The research focus of the group is on organic photovoltaic systems, i.e. solar cells based on organic compounds like polymers or small molecules. These highly absorbing materials are promising candidates for a cheap and versatile technology to convert sun light into electricity. We are interested in examining processing techniques viable for large scale production and how to exploit these processes for morphology control. Morphology, i.e. the arrangement of the individual molecules, plays an essential role for important processes like charge transport and hence for the overall performance of organic photovoltaics (OPV).**

Organic solar cells are multilayer systems consisting of a lamellar arrangement of electrodes, blocking layers and – the heart of the solar cell – the active layer consisting of a mixture of a donor and acceptor material, where the sun light is converted into moving charges, i.e. electric current. The individual layers are very thin, in the range of ten to hundreds of nanometers. Consequently, OPV devices are thin systems that can be either applied on glass or – more attractively – on conventional foils, leading to light weight and flexible devices.

The performance of such devices depends strongly on the morphology of the active layer [1]. This is due to the fact that the arrangement of the molecules determines the conductive quality, but also because the created charges need to be separated and transported to the electrodes to be extracted. When light is absorbed, excitons are created in the organic active layer. These electron-hole-pairs need to be separated to harvest free charges from the device. This is only possible if the splitting of the electron-hole-pair is energetically favorable which is the case at donor-acceptor material interfaces. However, excitons have only a limited life time resulting in a finite length they can travel within the active layer. This of course sets requirements on the distance and therefore on the arrangement of the donor-acceptor material interfaces within the thin film to allow for sufficient charge separation. Once charges are separated, conducting percolating pathways are necessary for the separated charges to reach the respective electrodes and to be extracted.

This results in an interest in being able to access a broad range of length scales from subnanometer to hundreds of nanometers to analyze the arrangement of molecules within the active layer.

[1] V. S. Gevaerts, E. M. Herzig, M. Kirkus, K. H. Hendriks, M. M. Wienk, J. Perlich, P. Müller-Buschbaum, and R. A. J. Janssen, *Chem. Mater.*, 26, pp. 916-926, 2014

Head:

Dr. Eva M. Herzig

[eva.herzig@ph.tum.de](mailto:eva.herzig@ph.tum.de)

Herzig Group  
Munich School of Engineering  
Lichtenbergstr. 4  
85748 Garching  
Tel. 089.289.12455k

[www.opv.mse.tum.de](http://www.opv.mse.tum.de)

To gain fundamental understanding on the structure-function relationship it is necessary to be able to analyse the morphology of organic thin films on these nanometer scales. But to make this knowledge available to the benefit of solar cells it is further necessary to have control over the morphology on these scales, too, i.e. to be able to reproduce desirable molecular arrangements. The work of our group is addressing these points of analysis and production control in several projects.

A powerful method to examine the bulk of the active layer thin film is x-ray scattering in a grazing incidence geometry. This is a method allowing to probe relatively large volumes of thin films to obtain statistically highly reliable data on length scales present within the film. This method has been widely used to analyze photovoltaic devices.

In collaboration with the group of Prof. Müller-Buschbaum (TUM) who is a worldwide known expert in grazing incidence scattering, we have carried out novel experiments in Berlin with the Krumrey group (PTB) who have set-up a sophisticated x-ray scattering beamline that can be run with different x-ray energies.

In our experiments we probe ternary systems, consisting of two polymers and a fullerene. The second polymer is used to influence the morphology, allowing us to examine to which extent an additional component can alter the composition of the film and the distribution of the materials.

In the last few years the use of x-rays for the investigation of morphological structure of polymeric thin films in photovoltaic has strongly increased. So far mostly hard x-rays around 10 keV are used to probe the samples. While this method gives good contrast between standard donor and acceptor materials (polymer/fullerene), the contrast between two polymeric materials is very low for high energy x-rays therefore the different polymeric components are difficult to distinguish from each other.

The situation changes if it is possible to choose the x-ray energy to be close to the absorption edges of certain elements that are part of the investigated polymers. Using x-ray energies around the absorption edge excites electrons within the probed material from a ground state to a higher state. Incoming x-rays are more „sensitive” to the excited electrons, increasing the scattering contrast. Measuring the same sample at different energies allows us to investigate such three component systems more fully.

A key advantage of organic photoactive layers is the processing ability out of solution. Using this property opens the opportunity to produce the active layer of the solar cell via printing methods and allows up-scaling to industrially relevant scales which is not the case for laboratory techniques like spin coating. Thus, for many OPV applications roll-to-roll processing on flexible substrates is highly desirable since it will allow for low cost processing even in a high-wages country like Germany. A large variety of printing and coating techniques can be used to reach this goal, for example, knife coating, slot-die coating, screen printing or spray coating.

However, controlling the assembly of the materials in the organic thin film is still challenging since a large number of parameters determines the final structure. While there are investigations on the development of nanoscale morphology in polymer:fullerene photoactive layers during solvent casting [2] and the stacked assembling of inverted solar cells [3], not much is known about the equivalent development in industrially relevant, printed systems.

Together with Alex Hexemer and co-workers from the Advanced Light Source, California, we have carried out in-situ scattering experiments to track the film formation and crystallization kinetics in printed organic thin films. This is achieved by using a specialized printing system that can be used within the synchrotron beamline with a temporal resolution down to seconds. This way it is possible to follow the morphological development during the drying of the film. The next step is not just to track the film evolution but also to control the drying process in more detail. For the success of the latter project a close collaboration with the Hexemer group is important. To pursue this we were able to obtain funding for the necessary travels through the Bavaria California Technology Center (BaCaTec) for the next two years.

Another important aspect for the success of industrially producing organic solar cells, is the price of the involved materials. Conjugated semiconducting materials offer a wide range of applications in optoelectronic devices such as organic-light emitting diodes and organic solar cells. However, to date, the polymer materials are still expensive. To enable a large scale production of thin conductive polymer films, the applied materials need to meet two main demands. While on the one hand the polymers are supposed to enable high efficiencies of the electronic devices, the starting materials ought on the other hand to be easily processable, available and cheap.

Most conjugated polymers are insoluble and therefore do not allow a processing directly from solution. To enhance their solubility, the polymer backbones can be further equipped with side chains. The most popular example for such a soluble polymer is poly(3-hexylthiophene), P3HT, which consists of a polythiophene backbone with an alkylic side chain. While the solubility of the polymers can be strongly increased by these molecular modifications, the side chains lead to unwanted twists within the polymer chain. A twisted backbone generally leads to a decrease in conjugation length and a lower degree of crystallization. Moreover, it is well known that the conductivity and optoelectronic properties of polymers strongly depend on the molecular morphology and crystallization behavior. Therefore the attached side chains decrease the polymer conductivity and usually the performance of the electronic devices. [4]

[2] T. Wang, A. D. F. Dunbar, P. A. Staniec, A. J. Pearson, P. E. Hopkinson, J. E. MacDonald, S. Lilliu, C. Pizzey, N. J. Terrill, A. M. Donald, A. J. Ryan, R. A. L. Jones, and D. G. Lidzey, *Soft Matter*, 6, pp. 4128-4134, 2010

[3] W. Wang, S. Pröller, M. A. Niedermeier, V. Körstgens, M. Philipp, B. Su, D. Moseguí González, S. Yu, S. V. Roth, P. Müller-Buschbaum, *ACS Appl. Mat. and Interf.*, 7, pp. 602-610, 2015

[4] J. Roncali, *Chem. Rev.*, 92, 4, pp 711-738, 1992



A promising approach to avoid changing the molecular structure of the polymers is synthesizing them in situ. For the in situ polymerization the corresponding monomers are deposited onto the substrate and linked together afterwards. These monomers are usually soluble in many different solvents. The coupling reactions can be initialized in different ways.

First achievements were made by synthesizing conductive thin films of a common conjugated polymer. These films were electrically conducting and show visible light absorption.

## About the Team

The team members of the Herzig group carry out research on Organic Photovoltaics focusing on structure function relationships during solar cell processing. Working in an interdisciplinary team the group members aim to merge their different expertise to bring their innovative ideas to this exciting field of research and to gain fundamental understanding of the energy converting processes involved.

Group leader Eva M. Herzig has done her PhD in Soft Matter Physics at the University of Edinburgh, Scotland before working on the development of fuel cells and in organic photovoltaic research in Germany. The group currently consists of three doctoral candidates Stephan Pröller, Mihael Čorić and Jenny Lebert, scientific co-worker Patrick Schreiber, working student Mosleh Uddin and Master student Felipe Martinez. The Bachelor students, Leonhard Hofbauer and Manuela Heiß, have successfully completed their thesis work in 2014. The academic backgrounds of the students range from Engineering and Physics to Chemistry. The interdisciplinary nature of their research is also visible in the collaborations of the group. The Bachelor and Master theses were carried out in collaboration with different chairs at the TUM; with Prof. Müller-Buschbaum in Physics and Dr. Harald Oberhofer from the Reuter group in Chemistry as well as with the Technical University of Denmark. Furthermore collaborations with Alex Hexemer from the Advanced Light Source, California have started in 2014.



■ From left to right: Stephan Pröller, Mihael Čorić, Eva M. Herzig, Jenny Lebert, Felipe Martinez, Mosleh Uddin, Patrick Schreiber.

# Control of Renewable Energy Systems

**Head:**

Dr.-Ing. Christoph Hackl

[christoph.hackl@tum.de](mailto:christoph.hackl@tum.de)

Research Group  
„Control of Renewable Energy Systems“

Boltzmannstr. 15  
85748 Garching  
Tel. 089.289.16688

[www.cres.mse.tum.de](http://www.cres.mse.tum.de)

The research group “Control of Renewable Energy Systems” (CRES) started its work in January 2014 and currently focuses on the control of wind turbine systems where, in particular, the electrical sub-systems—like generator, converter, filter and grid connection—are investigated. In collaboration with Prof. Carlo Bottasso (Wind Energy Institute, TUM), a holistic approach for modeling and control of wind turbine systems is favored to combine expertise in aerodynamical, mechanical and electrical systems. The main goals are to improve reliability, efficiency and robustness of the wind turbine system under rapidly changing conditions (e.g., wind speeds or grid faults).

## Motivation: Reliability of wind turbine systems

Currently, wind turbine systems have an average lifetime of 20 years. Frequent maintenance assures an average availability of 98% per year with an average downtime of seven days per year (see [1]).

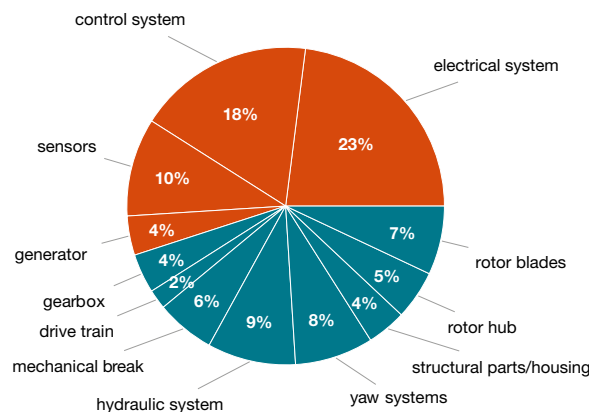

■ **Figure 1: Malfunction due to different kinds of failures in sub-assemblies of a wind turbine** (based on fig. 2 in [1])

Malfunctions of the overall system are mainly due to failures in the electrical system (23%), the control system (18%) and the sensors (10%), whereas the generator and the mechanical components—such as gearbox, rotor or housing—play a minor role (see Fig. 1).

During the lifetime of 20 years, the expected downtimes due to failures in the control system and the electrical system are 16.7 and 18.9 days, respectively. So both downtimes are higher than the downtime of 13.6 days due to failures in the gearbox (see Fig. 2).

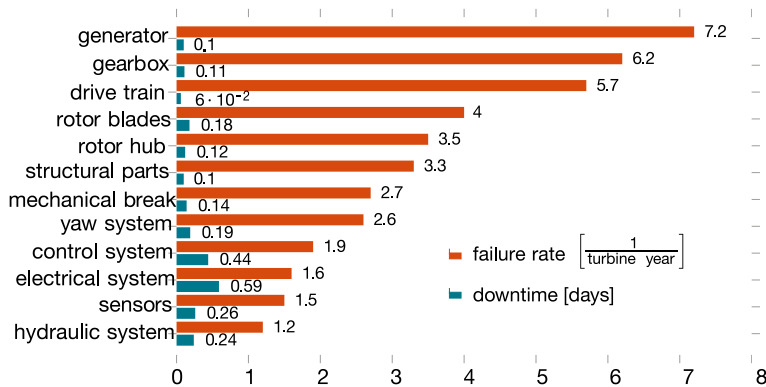

■ Fig. 2: Average failure rate and average down time per failure of sub-components (based on fig. 3 in [1])

Moreover, large-scale wind turbines with power ratings higher than 1 MW have high annual failure rates during their first seven years in operation (compared to small-scale wind turbines, see Fig. 1 in [1]). Therefore, in particular “[...] offshore wind turbines should be subject to more rigorous reliability improvement measures [such as tests, simulations and stability analysis...] to eliminate early failures. The focus should be on converters and generators” (see [2], a study based on data collected during 11 years in Denmark and Germany). More robust, reliable and fault-tolerant control systems are essential to overcome the “lack of quality control” (see Tab. 2 in [3]) and to improve the reliability, efficiency and robustness of wind turbine systems.

## Research foci

The activities of the research group “Control of Renewable Energy Systems” currently focus on the improvement of reliability, efficiency and robustness of wind turbine systems by

- Holistic system modeling (including aerodynamics, mechanics and electrical components),
- Holistic controller design combined with stability analysis and
- Fault detection and condition monitoring.

[1] B. Hahn, M. Durstewitz, and K. Rohrig, “Reliability of wind turbines, experiences of 15 years with 1500 WTs,” in *Wind Energy* (J. Peinke, P. Schaumann, and S. Barth, eds.), Proceedings of the Euromech Colloquium, pp. 329–332, Berlin: Springer-Verlag, 2007.

[2] F. Spinato, P. Tavner, G. van Bussel, and E. Koutoulakos, “Reliability of wind turbine subassemblies,” *IET Renewable Power Generation*, vol. 3, no. 4, pp. 1–15, 2009.

[3] Z. Hameed, Y. Hong, Y. Cho, S. Ahn, and C. Song, “Condition monitoring and fault detection of wind, turbines and related algorithms: A review,” *Renewable and Sustainable Energy Reviews*, vol. 13, pp. 1–39, 2009

## CRES Group

### Head of group

Christoph Hackl received the Dr.-Ing. (Ph.D.) from the Technische Universität München (TUM) in 2012. His interdisciplinary Ph.D. project “Non-identifier based adaptive control in mechatronics” was supervised by Prof. Dierk Schröder (Institute for Electrical Drive Systems, TUM) and Prof. Achim Ilchmann (Institute of Mathematics, TU Ilmenau). After a Post-Doc phase at the Institute for Electrical Drive Systems and Power Electronics, TUM (Prof. Ralph Kennel), he has been appointed Junior Research Fellow of the group “Control of Renewable Energy Systems” at the Munich School of Engineering, TUM in 2014. His main research interests are nonlinear, adaptive and optimal control of mechatronic and renewable energy systems.

### Ph.D. Candidates

Mr. Christian Dirscherl and Mr. Korbinian Schechner joined the research group „Control of Renewable Energy Systems“ as doctoral students in January 2014. Both hold a B.Sc. and a M.Sc. in Electrical Engineering and Information Technology from the Technische Universität München (TUM). With their specialization in power engineering and electrical drives they will contribute to the the progress of the research of the CRES group.



■ From left to right: Korbinian Schechner, M.Sc. EI, Dr.-Ing. Christoph Hackl, Christian Dirscherl, M.Sc. EI

# Achievements

## Publications

During 2014, the CRES group prepared, submitted and published seven peer-reviewed publications:

- two book chapters on wind turbine systems [2] and friction [3];
- one monograph on non-identifier based adaptive control for mechatronic systems (in preparation) [1];
- one journal article on virtual flux estimation for grid connected inverters [4];
- three conference papers on adaptive controllers for multi-body systems [6] (invited paper) and wind turbine systems [5] (session chair) and on advanced DC-link controllers for back-to-back converters [7].

Besides, the CRES group gave two poster presentations [8, 9] and seven scientific talks [10-16] at international conferences, colloquia and workshops.

- [1] C.M. Hackl, "Non-identifier based adaptive control in mechatronics" in Lecture Notes in Control and Information Sciences, Berlin: Springer-Verlag, 2014/2015 (in preparation).
- [2] C. Dirscherl, C. Hackl and K. Schechner, "Regelung von Windkraftanlagen: Eine Einführung", pp. 1505–1579 in D. Schröder "Elektrische Antriebe – Regelung von Antriebssystemen", Berlin: Springer-Verlag, 2015 (to be published in the 4th edition).
- [3] C.M. Hackl, "Dynamische Reibmodellierung: Das Lund-Grenoble Reibmodell", pp. 1580–1622 in D. Schröder "Elektrische Antriebe – Regelung von Antriebssystemen", Berlin: Springer-Verlag, 2015 (to be published in the 4th edition).
- [4] Z.-Zhang, H.-Xu, M.-Xue, Z.-Chen, T.-Sun, R.-Kennel, and C.M. Hackl, "Predictive control with novel virtual flux estimation for a back-to-back power converters," IEEE Transactions on Industrial Electronics, 2014 (early access article; DOI:~10.1109/TIE.2014.2361802).
- [5] C.M. Hackl, "Funnel control for wind turbine systems", in Proceedings of the IEEE Multi-Conference on Systems and Control (Antibes, France), pp. 1377–1382, 2014.
- [6] T. Faulwasser and C.M. Hackl, "Path-following funnel control for rigid-link revolute-joint robotic systems", in Proceedings of the 21st International Symposium on Mathematical Theory of Networks and Systems, (Groningen, Netherlands), pp. 1044–1051, 2014 (invited paper).
- [7] C. Dirscherl, C.M. Hackl, and K. Schecher, "Explicit model predictive control with disturbance observer for grid-connected voltage source power converters", to be published in Proceedings of the IEEE International Conference on Industrial Technology 2015, (Sevilla, Spain), 2015.
- [8] C.M. Hackl, "Klein-Windkraftanlagen mit effizienter und kostengünstiger Generatortopologie für Micro-Grids: Eine Voruntersuchung", Mitgliederversammlung des Bundes der Freunde der TUM e.V., München, 2014 (Poster).
- [9] C. Dirscherl, C.M. Hackl and K. Schechner, "Modeling and control of wind turbine systems with Permanent-Magnet Synchronous Generators (PMSG) and Doubly Fed Induction Generators (DFIG)", 4th Colloquium of the Munich School of Engineering, TUM, Germany, 2014 (Poster).
- [10] C.M. Hackl, "Funnel control for wind turbine systems", IEEE Multi-Conference on Systems and Control, Antibes, France, 10.10.2014 (chair of session "Wind energy").
- [11] C.M. Hackl, "Windenergie", Edgar-Lüscher Lectures 2014, Dillingen/Donau, Germany, 30.09.2014 (invited talk).
- [12] C.M. Hackl, "Path-following funnel control for rigid-link revolute-joint robotic systems", 21st International Symposium on Mathematical Theory of Networks and Systems, Groningen, Netherlands, 09.07.2014 (invited talk).
- [13] C.M. Hackl, "DC-link control: Understanding the nontrivial task", 6th workshop of the Renewable Energy Systems group of the Institute of Electrical Drive Systems and Power Electronics, Technische Universität München, Munich, Germany, 18.06.2014.
- [14] C.M. Hackl, "Non-identifier based adaptive control in mechatronics: An overview", IEEE Guest Lecture IAS/PELS South Africa Section, University of Cape Town, South Africa, 25.04.2014 (invited talk).
- [15] C.M. Hackl, "Modeling and control of wind turbine systems: An introduction", Three days block seminar, Stellenbosch University, South Africa, 23/24/29.04.2014 (invited talks).
- [16] C.M. Hackl, "Regelung der Zwischenkreisspannung: Ein Vergleich", Kolloquium zur nicht-linearen Regelung leistungselektronischer Systeme und elektrischer Antriebe, Universität des Saarlandes, Saarbrücken, Germany, 06.02.2014 (invited talk).

## Teaching

The CRES group is also active in teaching to promote the research topic and to educate interested students in this field.

The CRES group is giving lectures and tutorials for the course “Regelung von regenerativen Energiesystemen” (3 hours weekly during the winter semester 2014/2015) and supervised twelve student projects (master & bachelor theses, research internships and graduate seminars) in 2014. Besides, Dr.-Ing. C. Hackl participated in a lecture exchange program with the Wind Energy Institute (Prof. Carlo Bottasso) and offered the course “Projektbezogen Studieren – Aktives Lernen im Team: Projektstudium Antriebstechnik“ (3 hours weekly) which won the Ernst-Otto Fischer Teaching Award (10.000 EUR) in 2013.

Moreover, C. Hackl initiated and co-organized (with Dr. Christiane Hamacher of the MSE) the 1<sup>st</sup> MSE Winter School on “Holistic Modelling and Control of Energy Systems” in Ohlstadt, Bavaria from 2<sup>nd</sup> to 6<sup>th</sup> February 2015 with more than 40 international participants from academia and industry. He will give a one-day course on the topic “Renewable Energy Systems”.

## Third-party funds and grants

The CRES group was participating in preparing, writing and submitting three research project proposals. All three proposals have been accepted and granted:

- Research project “Small-scale wind turbine systems with efficient and inexpensive generator topology for micro-grids: A preliminary study” funded by the Bund der Freunde der TUM, principal investigator: C. Hackl (20.000 EUR)
- Horizon 2020 Innovative Training Networks research project “Airborne Wind Energy System Modelling, Control and Optimisation (AWESCO)”, principal investigators: C. Hackl and R. Kennel (Institute for Electrical Drive Systems and Power Electronics, TUM) for Work Package 4 “Robust and Fault-Tolerant Low-Level Control of the Electrical Drive System” (250.000 EUR, overall volume: 3.000.000 EUR)
- DFG research grant “Computationally-efficient direct model predictive control of three-level neutral-point clamped back-to-back converters for wind turbine systems with permanent-magnet synchronous generators”, principal investigators: C. Hackl and R. Kennel (172.000 EUR).

**Project funded by Bund der Freunde der TUM e.V.:  
Small-scale wind turbine systems with efficient and inexpensive generator topology for micro-grids: A preliminary study**

**Project description**

During this preliminary study the potential(s) of reluctance synchronous machines (RSM) used as generators for small-scale wind turbine systems ( $\leq 50\text{kW}$ ) shall be examined in cooperation with the Prof. Maarten Kamper (University of Stellenbosch, South Africa). Based on a RSM prototype of the University of Stellenbosch the research tasks are (i) the design of adequate control and operation management methods and (ii) the evaluation of these developed methods at a Hardware-in-the-Loop system (see figure below). The evaluation will focus on the comparison of the generator performances of RSM and permanent-magnet synchronous machine with respect to power density, efficiency, dynamics and torque ripple. In parallel these experimental results will be used for a further optimization of the machine design of the RSM prototype in Stellenbosch.



**CRES (Dr.-Ing. C. Hackl)**

- Modelling and control
- Hardware-in-the-Loop system

**EMLAB (Prof. M. Kamper)**

- Modelling (FEM)
- Machine design and construction

■ **International cooperation**

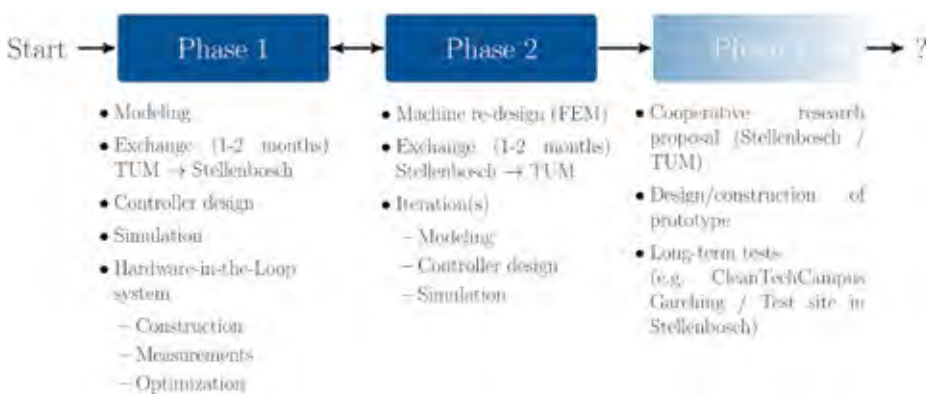

■ **Project phases**



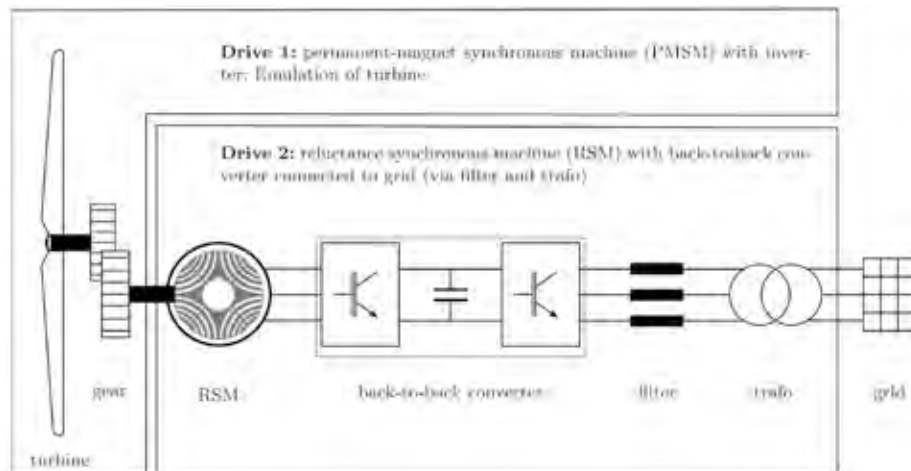

■ Hardware-in-the-Loop System

**Advantages of RSM**

RSMs are simple and cheap to produce. The rotor consists of glued and punched iron sheets, expensive permanent-magnets (“rare earth”) are not necessary and standard stator designs (windings) are admissible. Moreover, the RSM is a reliable, compact and efficient machine (IE4 feasible). Stator and rotor temperatures are low compared to induction machine, which yields increased reliability and resilience (e.g. of bearings). Slip rings are obsolete. Due to its compactness, identical stator designs may achieve an almost doubled power density and high “torque per volume” ratios up to almost 50kN/m<sup>3</sup> (in comparison: permanent-magnet synchronous machines achieve 20-45 kN/m<sup>3</sup>).

# Seed Funding Projects

## Passive Load Mitigation in Wind Turbines using a Sail-Wing Concept

The wind-energy sector has experienced for the last decades a remarkable increase as it enables the production of clean and renewable energy. This expansion in the sector will continue for the foreseeable future as the objectives of 2020 seek to obtain 20% of the total European energy consumption requirements using renewable resources. New technologies and ideas are therefore required to achieve those objectives. Maritime wind energy could be a relevant alternative in this respect, insofar as it offers others considerable advantages compared to its onshore counterpart. The wind power increases for example in maritime areas which implies more capacity and, with bigger turbines, more efficiency. Nevertheless, offshore turbines cost from 2.5 to 3 times more than their onshore counterparts.

To stay competitive, improvements need to be done concerning the development of the machines. One solution studied at the Institute of Aerodynamics and Fluid Mechanics of the TU München in Cooperation with the Institute of Wind Energy is based on a reduction of loads with a Sail-Wing concept. The mitigation of loads on wind turbines can have a major effect on the design of the whole machine which could offer a reduction of costs. The Sail-Wing concept consists in a new blade design made out of an elasto/flexible membrane wrapped around a rigid leading- and trailing-edge. This concept offers passive flow control which can be exploited to reduce the costs by changing the materials and/or designing a bigger rotor machine. The advantage of the Sail-Wing concept is the adaptivity of the airfoil geometry. As the membrane is flexible, the profile of the wing will adapt itself to the flow environment by changing its camber, which will result in an increase or decrease of the lift coefficient. Simulations modeling the behavior of such a concept were performed in order to understand the interaction between the fluid and the structure. It can be shown that for small and high Reynolds numbers, depending on the pre-stress of the membrane, the lift values for a Sail-Wing are higher than those of its rigid counterpart. Furthermore, the stall region appears later and smoother, which explains the load alleviation. The idea is to design a complete blade made of such a concept for a wind turbine, in order to understand whether it offers advantages compared to its rigid counterpart. The next steps will be to know how reliable the simulation results are by comparing simulations and experiments. Then a complete blade can be designed and tested.

**Prof. Dr.-Ing. Nikolaus A. Adams**

**Prof. Dr.-Ing. habil. Christian Breitsamter**

Aerodynamics and Fluid Mechanics, Department of Mechanical Engineering

**Prof. Dr. Carlo L. Bottasso**

Wind Energy, Department of Mechanical Engineering

## Scaled Wind Turbine and Wind Farm Testing

**Prof. Dr. Carlo L. Bottasso**

Wind Energy, Department of  
Mechanical Engineering

**Prof. Dr.-Ing. Nikolaus A. Adams**

Aerodynamics and Fluid  
Mechanics, Department of  
Mechanical Engineering

The Wind Energy Institute at TUM has developed a scaled experimental facility, for the simulation of wind turbines and wind farms in a boundary layer wind tunnel; partial support for this activity has been provided by MSE in the form of one staff position. This unique facility enables the conduction of experiments in aeroservoelasticity, the study of wakes, machine-to-machine interactions, and wind farm control for power maximization and load mitigation. The facility is highly instrumented, allowing for the collection of a wide range of high quality data, both regarding the flow conditions and the response of the machines. Such data can be used for the verification of performance of control strategies, as well as the validation of computational tools. The experimental setup is highly flexible, allowing for different machine configurations, operational scenarios, and the testing of different control algorithms used onboard the individual wind turbines or the whole wind farm. Under the support of industrial and governmental sponsors, an ambitious plan of extremely interesting new experiments is planned for 2015 and 2016, including the demonstration of wake deflection strategies that make use of the wind sensing technology developed by the Institute. The success of these experiments would open the way to the design of compact wind farms, featuring more closely spaced wind turbines than it is currently possible, with a reduced land occupation that minimizes the impact on the landscape, the environment and the population.

## Seed-Funding: Energy and Information

**Prof. Dr. Sandra Hirche**

Information-oriented Control,  
Department of Electrical and  
Computer Engineering

**Prof. Dr. Wolfgang Kellerer**

Communication Networks,  
Department of Electrical and  
Computer Engineering

**Prof. Dr. Wolfgang Utschick**

Methods for Signal Processing,  
Department of Electrical and  
Computer Engineering

The liaison of power engineering, control engineering and communications engineering is inevitable for creating the required progress for the realization of the world wide aggressive renewables program. A first initiative for bringing together these disciplines at TUM had been a Munich School of Engineering Workshop on Smart Grids held in Benediktbeuern. The participating researchers conducted a survey of ongoing and planned research efforts in order to identify overlap and potential cooperation. Amongst many others the "Development of a new information and communication infrastructure on top of the physical system" had been identified since. This seed-funding project has eventually provided the basis to start with this collaboration.

## Subproject: Distributed Control Design for Power Systems under Privacy Constraints

**Prof. Sandra Hirche and  
Frederik Deroo**

Information-oriented Control,  
Department of Electrical and  
Computer Engineering

The goal of this project was to develop an advanced distributed control design approach for the application in large-scale electrical power systems. Particular design objectives have been scalability and privacy for subsystems which involve generators and loads. A novel approach for the optimal distributed control design has been proposed. The unique feature of this method is that individual subsystems in a network need to exchange information only with neighbors and that no coordinating central entity is required. Hence, the method is scalable and no central model is required, thus ensuring privacy of the subsystems. Furthermore, a distributed technique for analyzing the stability of large-scale interconnected systems with local model knowledge has been developed. In parallel, two methods of evaluating the sensitivity to disturbances in interconnected systems such as power systems were developed. There are ongoing works in cooperation with PhD candidates from the research group Power Transmission Systems with the objective to develop realistic simulation models of power systems to evaluate the developed approaches.

## Subproject: Communication Networks for Smart Grid

In this seed-funding project the interdisciplinary research of ‘energy and information’ is addressing the support of emerging information exchange and control tasks with communication networks. In future, energy systems consist of highly distributed energy sources and energy consumers, which have to be jointly controlled via communication networks. Depending on the different control tasks, such as metering, demand side management, control of distributed energy resources or wide area monitoring, requirements include very low latencies as well as high reliability. In this project, a simulation environment has been developed based on the OMNET++ network simulator to analyze how wireless cellular networks such as LTE with its recent machine-type communication enhancements and wireless mesh networks can support smart grids for various network scenarios and cell loads. Performance metrics include throughput, latency as well as reliability. To support future smart grids, advanced communication mechanisms have to be developed for reliable transport of low latency event based traffic and control has to be tightly coupled with the communication network.

**Prof. Wolfgang Kellerer and Mikhail Vilgelm**

Communication Networks,  
Department of Electrical and  
Computer Engineering

## Subproject: Optimal Power Flow in Future Power Systems

Current state-of-the-art power systems are facing a historical transformation, which involves the shift from centralized to distributed generation and from smooth to increasingly fluctuating energy production. These changes necessitate an efficient method for the optimal control of power flows to avoid network congestion and ensure an efficient operation, which, however, is a long-standing and computationally challenging problem for meshed AC transmission grids. In this project, we proposed a hybrid mesh network (combination of AC and HVDC links) topology for transmission grids in power systems that enables an efficient optimal power flow control with polynomial time solution algorithms. Additionally, we introduced a significant extension of the OPF formulation by means of stability constraints and a practical link capacity constraint has been introduced, based on simple conditions for applicability that are usually fulfilled in transmission grids. The optimal power flow in the hybrid transmission grid is considered with respect to finding the most cost-/loss-minimizing allocation of generation facilities such that the resulting power flows respect the system constraints. The solution of the optimization problem determines the optimal power flow in the hybrid transmission grid and constitutes an efficient method for optimal power flow control.

**Prof. Wolfgang Utschick and Matthias Hotz**

Methods for Signal Processing  
Department of Electrical and  
Computer Engineering

## Tailored TCO Nanostructures for Photovoltaic Applications

Prof. Dr. Peter  
Müller-Buschbaum

Functional Materials,  
Department of Physics

In this project, the Müller-Buschbaum group aims to fabricate and investigate well organized and controlled morphologies eg. nanorods and network structures of transparent conducting oxides (TCOs) based on zinc oxide (ZnO) and titanium dioxide (TiO<sub>2</sub>). These tailored TCO nanostructures are used in combination with different n- and p-type organic materials (small molecules and polymers) towards achieving efficient and cheap tailored TCO nanostructure-based hybrid solar cells. Using low-temperature solution based methods allows for the preparation on flexible substrates and thus gives a significant contribution to flexible hybrid solar cells.

The joint project combines expertise in nanomorphology control, advanced structure characterization, electro-optical characterization and state-of-the-art device fabrication and characterization. Central part is the synthesis of tailored TCO nanostructures such as nanorods, inverted nanorods and network structures which allow for a high level of structural control and therefore device optimization beyond today's approaches. The importance of morphology to solar cell performance is well known, but to date, the lack of quantitative, nanoscale and statistical morphological information has hindered obtaining direct links to device function. Using X-ray and neutron scattering methods, both the surface topography and the inner film morphology will be simultaneously probed to give quantitative and statistical information on the lateral inorganic and organic structures. The feedback will be used to improve the synthesis and the device fabrication.

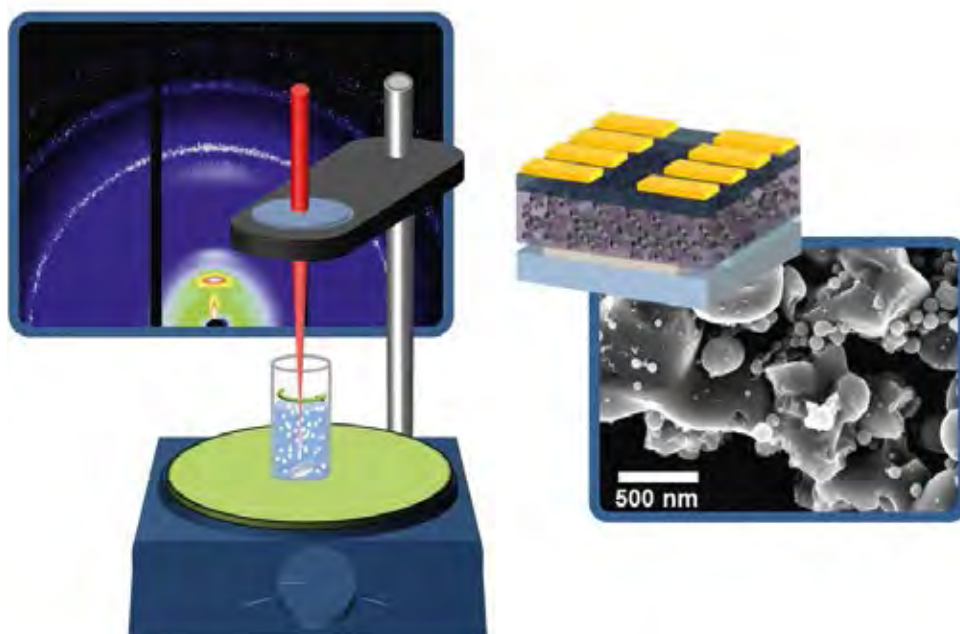

■ Fig. 1: Sketch of preparation of metal oxide nanoparticles via laser ablation in liquid from a suspensions of particles as seen by the SEM.

The Müller-Buschbaum group in cooperation with the chair of Laser and x-ray physics (Prof. Kienberger) of TUM developed the functionalization of titania nanoparticles with aqueous processable donor polymers. The nanoparticles are produced with laser ablation in liquid from solid metal targets or suspensions of particles. The developed techniques are now expanded to a microfluidic processing scheme allowing for the tailored fabrication of nanoparticles for TCOs and hybrid solar cells.

## Power-to-Fuel

The Power-to-Fuel (PtF) concept and chemical energy storage might play an important role in future renewable-based energy systems. The existing infrastructure and the persistent need for gaseous (H<sub>2</sub>, SNG) and liquid fuels (e.g. Methanol, DME, higher alcohols) are main advantages of the PtF-concept compared to electrical or mechanical energy storages.

**Prof. Dr.-Ing. Hartmut Spliethoff**

Energy Systems, Department of Mechanical Engineering

At the TUM, integrated research is conducted within several cooperating institutes and external partners (e.g. ZAE Bayern). A joint project focuses on three main areas of research: Electrolysis, Synthesis & System Analysis with the main goal to identify the most promising technologies and to decrease the storage costs.

Therefore, possible project partners from the industry and interested experts from other research institutes were invited to a workshop called “SNG as a key for future energy systems – power-to-gas and biomass-to-gas”. Despite the networking character of such an event, the 150 participants exchanged knowledge and opinions on the current status and about required future research in the field of chemical energy storage.

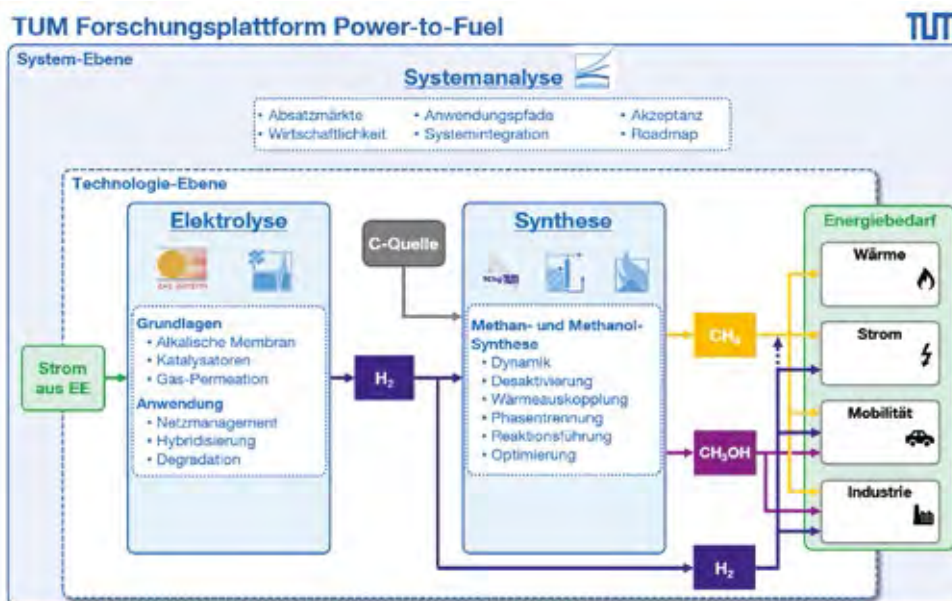

■ Power-to-Fuel research platform

## A Holistic Approach to Urban Energy Planning for Smart Cities

Dr. Vicky Cheng

Energy Efficient and Smart Cities  
Munich School of Engineering

Cities consume over two-thirds of the world's energy and account for more than 70% of global CO<sub>2</sub> emissions, it is evident that in order to mitigate climate change cities are the place to start.

Past research on urban energy systems was mostly dedicated to individual sectors (e.g. electricity grid, heating network, buildings, transport, etc.) and only few considered the interactions across multiple disciplines. As a result, the synergies and trade-offs between different energy sectors are often overlooked.

This seed funding project adopts an integrative approach that incorporates building energy research in the wider context of urban land use and transport planning. In collaboration with colleagues at the Department of Architecture, University of Cambridge, the project aims to develop an adaptive framework for modelling urban energy systems that can be coupled with transportation models for integrated analyses of city districts with diverse urban characteristics. This concept will be further developed during the course of the project and external funding opportunities will be sought to support future extension of the work.

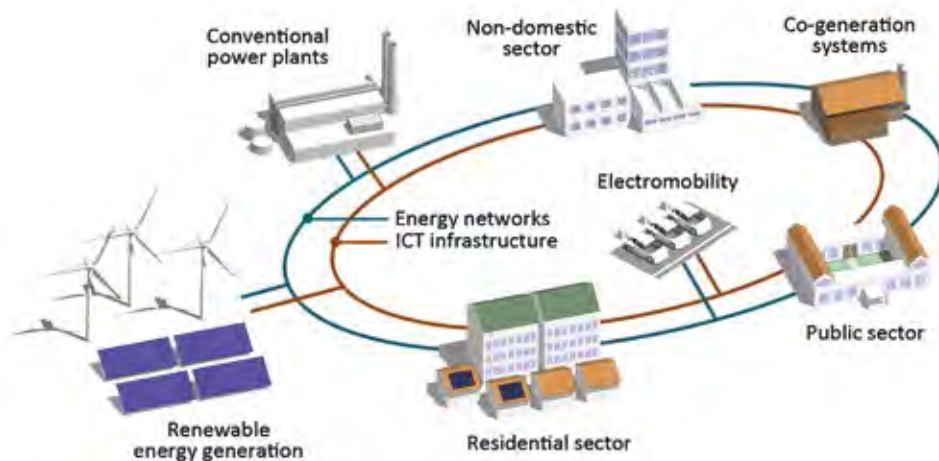

- Integrative energysystem analyses involving multiple sectors

# Novel Nanostructured Thermoelectric Hybrid Materials

In this project, we aim to fabricate and investigate novel organic-inorganic hybrid materials for thermoelectric applications. The goal is to realize efficient low temperature ( $T < 100^{\circ}\text{C}$ ) thermoelectric thin films and coatings which can contribute for example to energy efficient buildings. By combining nanostructured inorganic materials with conducting polymers a novel approach for this class of materials shall be realized. Possible inorganic nanomaterial components include Si, Ge, SiGe nanocrystals (either undoped, n-type or p-type doped) as well as  $\text{FeSi}_2$ ,  $\text{Cu}_2\text{S}$  or  $\text{FeS}_2$  nanoparticles. Different polymer materials such as the polymer blend poly(3,4-ethylenedioxythiophene): poly(styrenesulfonate) (PEDOT:PSS), which can be tuned in conductivity and in its nanostructure, shall be used as the organic partner in our hybrid approach.

We will combine expertise from chemical synthesis, morphology characterization, device fabrication and device characterization. The interdisciplinary research team comprises chemists, physicists and engineers. In the seed funding period the Brandt group (TUM Walter Schottky Institut), the Müller-Buschbaum group (TUM Physics) and the Nilges group (TUM Chemistry) are collaborating.

Multiscale disorder such as pores, grain boundaries and inclusions, is expected to drastically reduce the thermal conductivity, thereby enhancing the overall efficiency of thermoelectric materials. Using pulsed laser sintering (LS), we already gained thin films of Si or Ge nanoparticle with a mesoporous semiconducting network. Our aim is to apply this advanced LS technique to further inorganic thermoelectric materials. Due to their extraordinary thermoelectric properties like high Seebeck variation and high thermoelectric efficiency we focus on  $\text{AgBiSe}_2$  and  $\text{Ag}_{10}\text{Te}_4\text{Br}_3$ . As it is shown in figure 1 we already achieved the typical mesoporous network for  $\text{AgBiSe}_2$  (Fig. 1). XRD characterization showed no change of the crystal structure and electric as well as thermoelectric measurements are in progress.

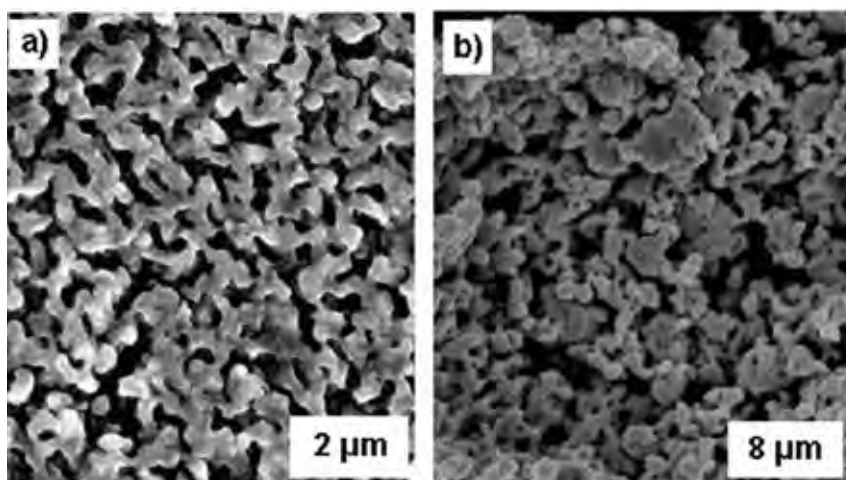

■ Fig. 1: SEM top view of LS thin films showing the porosity of the meander structure a) Si-Ge 91:09 b)  $\text{AgBiSe}_2$ .

**Prof. Dr. Martin Brandt**

Experimental Semiconductor Physics II  
Walter-Schottky-Institute

**Prof. Dr. Peter Müller-Buschbaum**

Functional Materials, Department of Physics

**Prof. Dr. Tom Nilges**

Synthesis and Characterization of Innovative Materials, Department of Chemistry



## Analysis of Quantity Structure and Energy Demand of Non-Residential Buildings - A Method for the Application of Long-Term Energy Development

Dr.-Ing. Isabell Nemeth

Laura Franke, M.Sc.

Center for Sustainable Building,  
MSE

[www.znb.mse.tum.de](http://www.znb.mse.tum.de)

The residential building sector of Germany is well researched regarding its energy saving potential and long-term development scenarios of its future energy demand. Although non-residential buildings, such as schools, supermarkets or offices, comprise a smaller share in overall area than the residential sector, they are equally important in terms of their energy saving potential. In contrast to the residential sector, these buildings have not been holistically examined yet on a detailed level due to a lack of data.

How does the non-residential building sector perform in terms of energy demand and energy saving potential? Which scales (regional, national) are reasonable to choose for the project? How will the trend to become more efficient develop, in light of the federal government's aim of climate-neutral buildings in 2050? The focus of our detailed research is to answer these questions.

The present project investigates the development of a method to estimate the long-term energy trend of non-residential buildings. This implies collecting data about quantity structure, specific energy demand and life cycle calculation of non-residential buildings. The acquirement of the data closes a significant gap that is presently impeding the development of energy saving strategies for the addressed building sector. On a broader scale, the model could contribute to the optimization of urban, regional and national energy supply scenarios.



■ Aerial view Campus Garching.

## CleanTechCampus – Garching

With 12,000 students and 6,000 employees, the campus of the TU in Garching is one of Germany's largest and most research-intensive university facilities. And the campus keeps growing! This continuous further development of the campus requires a continuous further development of its energy supply system. Objective of the current project is therefore the development of an innovative and economically viable concept for the energy supply of the campus Garching, building upon the strengths of the different research institutes.

The CleanTechCampus combines research, energy supply, novel technologies and visions.

1. Living Lab in Garching as research facility.
2. Innovative energy supply at the campus.

Economic and modern technologies shall cover the base load supply of heat, cooling and power, PV, etc. With market-ready early-stage technologies for power, heat and gas such as small wind turbines, and storages, this base load shall be extended. Furthermore flexible docking options within a new SmartEnergyGrid for power, heat and gas shall be realized to test new, innovative technologies within the overall system.

Through the use of innovative energy technologies and visionary concepts the Clean-TechCampus shall become a beacon in Europe's academic landscape, both for energy research and energy conversion technology.

**Dr. Annelies Vandersickel**

**Barbara Hetterich M.Sc.**

Energy Systems, Department of Mechanical Engineering

**Dipl.-Ing. Manuel de Borja Torrejón M.Sc.**

Renewable and Sustainable Energies, Department of Electrical and Computer Engineering

## A Coupled Electrochemical - Thermal Battery Model

**Prof. Dr.-Ing. Wolfgang A. Wall**

Computational Mechanics,  
Department of Mechanical  
Engineering

Batteries constitute core technologies for energy supply, for example as a storage medium for wind and solar energy, or as a power source for electric and hybrid vehicles. Our goal is to create a novel computational tool to better understand and reliably predict the potential of future battery concepts. With our tool, we seek to considerably enhance battery research and development by providing new and important insight within short time and at low cost. The wide range of parameters governing the functionality and performance of batteries significantly complicates experimental investigations during the development process, rendering them infeasible in terms of time and money. Unfortunately, many of the current computational approaches and tools for battery modeling are based on a variety of questionable simplifications fraught with uncertainties. Thus, accurate predictions as required in the early development process are very difficult to obtain.

# Research Projects: EEBatt

## **EEBatt**

**Duration:** 01.01.2013 - 31.12.2016

**Project Coordination:**

**Prof. Gasteiger, Prof. Jossen**

**Funding:** 28,8 Mio. €

by Bavarian Ministry of Economic  
Affairs and Media, Energy and  
Technology

Sponsored by  
Bavarian Ministry of  
Economic Affairs and Media, Energy and Technology



# EEBatt

## Distributed stationary battery storage systems for the efficient use of renewable energies and support of grid stability

### Overview of the research project EEBatt

[www.eebatt.tum.de](http://www.eebatt.tum.de)

#### Heads

**Prof. Dr. Hubert A. Gasteiger**  
Technical Electrochemistry,  
Department of Chemistry

**Prof. Dr.-Ing. Andreas Jossen**  
Electrical Energy Storage,  
Department of Electrical and  
Computer Engineering

#### Project Management

**Marcus Müller M.Sc.**  
Electrical Energy Storage,  
Department of Electrical and  
Computer Engineering

The Research Project EEBatt “Distributed stationary battery storage systems for the efficient use of renewable energies and support of grid stability” is a multidisciplinary project run by the TUM’s Munich School of Engineering (MSE).

Combining the strength of 13 chairs and departments of the Technische Universität München, the industry partner VARTA Storage GmbH and the Bavarian Center for Applied Energy Research (ZAE Bayern), a multidisciplinary team of researchers works together on a wide range of issues concerning stationary storage of electrical energy. Driven by the actual evolution in the energy market, the main goal of the project is to investigate, develop and produce a decentralized energy storage device, which ensures that locally generated electrical power can be consumed locally. Based on the actual and expected results for lithium-ion technologies, EEBatt uses Lithium Iron Phosphate (LFP) and Lithium Titanate Oxide (LTO) chemistry for the setup. Together with the KWH Netz GmbH, a regional power supplier company in Haag/Upper Bavaria, the obtained results of the research project will be evaluated and implemented.

The energy turnaround implicates not only a change in the technologies used for energy production, it also means a structural change towards a large number of decentralized time-dependent production facilities. The resulting fluctuations in the power production and imbalanced charging of the power grid make the use of storage technologies essential. The Bavarian Ministry of Economic Affairs and Media, Media and Technology initiated and finances the EEBatt research project to identify and explore possible storage solutions.

**The research project EEBatt pursues in the period from 01/01/2013 to 31/12/2016 the following objectives:**

- Development of an innovative decentralized stationary energy storage system
- Increase and secure the system security
- Optimization and advancement of the „Battery Management Systems“
- Increase battery lifetime and cycle stability
- Cost optimization, modular and scalable product design
- Reduction of the production costs
- Increase the overall efficiency
- Development of an optimally adapted energy management system
- Cost-effective and intelligent integration
- Field test ENERGY NEIGHBOR



One result of the research project EEBatt is the stationary battery storage system ENERGY NEIGHBOR, which is going to be tested in Moosham (corporation Kirchdorf/Oberbayern). ENERGY NEIGHBOR as a community energy storage system has a storage capacity of 200 kWh, which allows to consume local generated energy locally. Therefore ENERGY NEIGHBOR helps to integrate electricity produced from renewable energy sources better and to relieve the grid. This is a contribution to a sustainable and decentralized energy system.

The energy turnaround implicates not only a change in the technologies used for energy production, it also means a structural change towards a large number of decentralized time-dependent production facilities. The resulting fluctuations in the power production and imbalanced charging of the power grid make the use of storage technologies essential to identify and explore possible storage solutions.

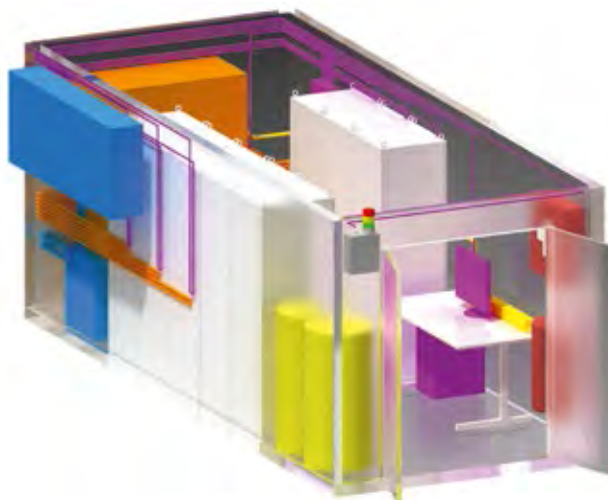

- Second-Life-Storage

### **Field test ENERGY NEIGHBOR**

One result of the research project EEBatt is the stationary battery storage system ENERGY NEIGHBOR, which is going to be tested in Moosham (corporation Kirchdorf/Oberbayern). ENERGY NEIGHBOR as a community energy storage system has a storage capacity of 200 kWh, which allows to consume local generated energy locally. Therefore ENERGY NEIGHBOR helps to integrate electricity produced from renewable energy sources better and to relieve the grid. This is a contribution to a sustainable and decentralized energy system.

The public relations task force was initiated to actively inform the public about the EEBatt project. In this process, the citizens of Moosham, part of Kirchdorf in Upper Bavaria, are the main audience, since the Energy Neighbor will be installed there in 2016. In order to carry out a successful field test the support of the citizens is needed, e.g. for the installation of smart meters. The task force designed information material like flyers and mailings with relevant information on the project. Furthermore, detailed information about EEBatt, the different sub-projects and the field test was made available on the project website: [eebatt.tum.de](http://eebatt.tum.de)

The team presented the project to the public in the summer of 2014 at the open house of the KWH Group in Haag (Upper Bavaria). Residents, citizens of the region and political representatives could inform themselves about the research project. Focus of the presentation was the planning and implementation of the field test. In December 2014, all residents of Moosham were invited to an information evening organized by TUM and KWH Group. The local residents were highly interested in the project and the team could get valuable feedback and answer questions regarding the installation of the Energy Neighbor storage system and the smart meters.

Besides getting in touch with the citizens, the scientific community, politicians and other actors engaged in energy topics on the regional level are part of the audience. Hence, the KWH Netz GmbH and TUM have joined forces and organized the first Energy Information Day. The team invited the mayors from the coverage area of the KWH Netz GmbH, in order to discuss the EEBatt project and the energy turnaround in Bavaria.

The next Energy Neighbor event will take place in spring 2015 in Moosham, while the EEBatt project will be presented at various fairs and conferences in 2015.

## Community Store Energy Neighbor in Moosham

In order to apply the research results under realistic conditions, to obtain new insights through the daily use of the community store Energy Neighbor and to advance the storage system, the Technical University of Munich (TUM) and its partners conduct a field test within the context of the research project EEBatt. The field test for renewable energy storage takes place in Moosham, a part of Kirchdorf in Upper Bavaria close to Munich. In the end of 2015 the lithium iron phosphate technology battery storage Energy Neighbor with a capacity of 200 kWh and a nominal output of 200 kW gets connected to the low voltage system. Afterwards the energy supply company power plants Haag will operate the Energy Neighbor.

## Energy - local generation, storage and use

The community has to fulfill special conditions for the implementation of the field test. Besides the perfect local size, Moosham has an optimal infrastructure for the field test. Compared to its population, Moosham has a high proportion of renewable energy and therefore it produces surpluses spread over the whole year, which gets feed back in the superordinate medium-voltage power grid. On the one hand, this puts pressure on the transformer and the line and so requires a close grid expansion. On the other hand, the local facility owners loose through the energetic recovery valuable solar power, which can be used for covering the own needs after the running out of the EEG for remuneration for feeding. The Energy Neighbor is able to release the transformer and the line and at the same time to store the surplus of solar energy, because of its intelligent control algorithm. This decreases on the one hand the disassembly costs for the network operators and on the other hand it offers interesting business models for the owners of PV facilities and electric supply companies. Furthermore, investigations take place about an additional participation on the control power market and the potentially resulting improvements of the business efficiency

## Smart Grid Moosham

In order to perform the above mentioned tasks, the Energy Neighbor needs online available solar performance predictions as well as different measured data from the net. For that reason, we build up in Moosham a wireless communication link between transformer station and Energy Neighbor with the help of modern transmission technology and furthermore one, on Ethernet based, data connection gets established to some of the storage close PV facilities. The gained measurement values and forecast data can be used by the intelligent control algorithm to fulfill the, for the task necessary injection or withdrawal capacity, to control the Energy Neighbor. In order to evaluate the benefit of the business models for the end customer, which was developed on the project, the analysis of the consumer behavior is of essential importance. That is the reason for the exchange of as much as possible analog smart meters through modern digital smart meters in Moosham



### Support of the energy turnaround

Through the Energy Neighbor it is possible to better integrate renewable energies in the distribution grid and to support the decentralized energy system. Thus, the local produced energy power can get stored locally and used locally. This means for the energy turnaround: improvement of grid congestions and therefore an unproblematic increase of further PV facilities, which is important for the energy policy objectives of the federal Government. In case of the application of appropriate business models, the Energy Neighbor can contribute to achieve a stable electricity rate for the end customer and considerably enhance the attractiveness of the energy turnaround.

### KWH

Kraftwerke Haag Gruppe (KWH) is a regional energy supplier, which provides electricity to the region around Haag for more than 90 years. Thereby, the Kraftwerke Haag Gruppe is characterized by the proximity to its customers and through their commitment to promote and develop the rural areas. The company assumes a pioneering role in the field of power generation through renewable energies and it aims to support this area. For these reasons, Kraftwerke Haag Gruppe represents an optimal practice partner for the EEBatt project. Kraftwerke Haag Gruppe supports the EEBatt project in the planning, implementation and evaluation of the field test and thus contributes greatly to the success of the research project.

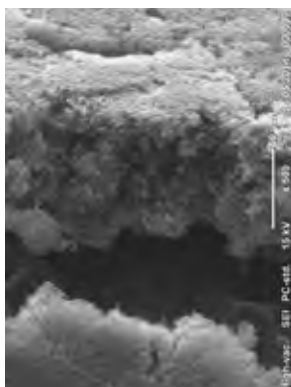

■ Figure 1: SEM cross section image of lithium dendrite layer formed on a lithium anode during cycling at high C-rates.

The development and application of novel spectroelectrochemical cells which can operate under operando conditions is part of the EEBatt project. The use of operando spectroscopy can give unique insights into the cell chemistry directly during battery operation which is very important for the chemical and morphological understanding of cell ageing.

One such research project focuses on the observation of lithium dendrite growth (Figure 1) during battery charge. Lithium dendrite formation has been studied for more than 20 years as it is the major obstacle prohibiting the use of lithium metal anodes in commercial batteries. Despite the intensive research of the past years, there is still a lack of analytical techniques which can give time-resolved quantitative or semi-quantitative information about the amount of dendrites formed on the lithium anode.

Within the EEBatt project a novel cell design for electrochemical electron paramagnetic resonance (EPR) spectroscopy was developed. Due to the limited penetration of metallic lithium by microwaves (“skin depth”) EPR spectroscopy can be used to quantify lithium dendrite formation. In a first case study Lithium/LFP cells were cycled in the EPR cell. After successfully benchmarking the electrochemistry in the novel cell design, the influence of electrolyte composition and C-rate on dendrite formation was studied. It was found, that lithium dendrite formation increases with charging rate but can be alleviated by partially fluorinated electrolyte additives. In future projects, operando EPR spectroscopy will be used for the study of lithium plating on several other anode materials.

## EEBatt TP4 – Module design and optimization

Within the subproject 4 highly self-contained battery modules for the EEBatt storage system are investigated, designed and optimized. The multidisciplinary approach includes a mechanical, thermal and electrical layout specifically adapted for a modular stationary storage but also takes manufacturing aspects into consideration. Single modules are composed out of eight cell boxes as shown in figure 1. Component pre-tests and numerical simulation result in a smart though simple design which can be manufactured to a large extent automatically. Relying on numerous common and standardized parts, module assembly is failsafe, reliable and guarantees that even a large number of individual modules can be produced economically. The research conducted also incorporates the planning of a semi-automated production line prototype as depicted in figure 2.



- Figure 2: EEBatt module subassembly
- Figure 3: Semi-automatic cell-box prototype assembly line

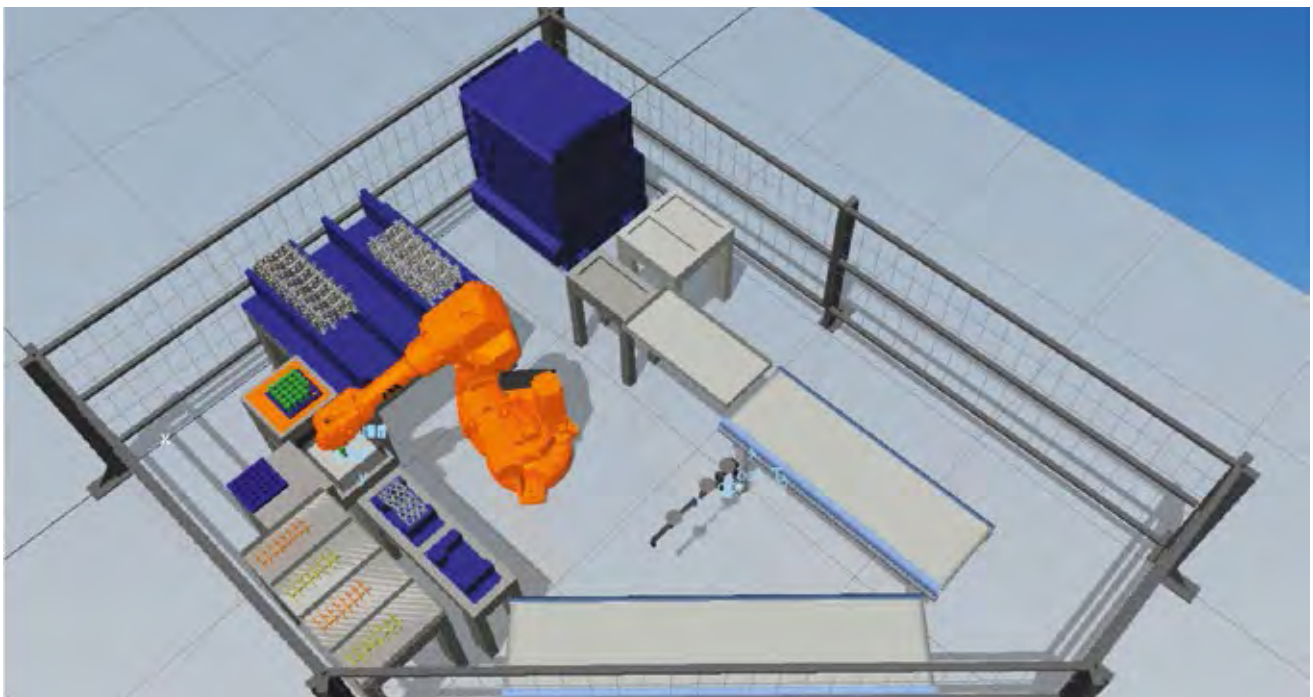

### Future perspectives for application of local battery storages

Growing shares of fluctuating renewable power sources like wind and sun increasingly cause imbalances and overloading in electric grids. To unload critical components and to optimize power supply on a local scale, the application of stationary battery storages is investigated. In subproject 10 of EEBatt, we mainly focus on the storage application for the following three cases:

- control strategies for multiple voltage levels
- multi-commodity energy systems
- off-grid energy systems

The reduction of MV/LV transformer loads is the main goal of most current control strategies for battery storages in low voltage grids. By implementing new intelligent control strategies, battery storages on low voltage level can be used for relieving loads of HV/ MV transformers, see Figures X.

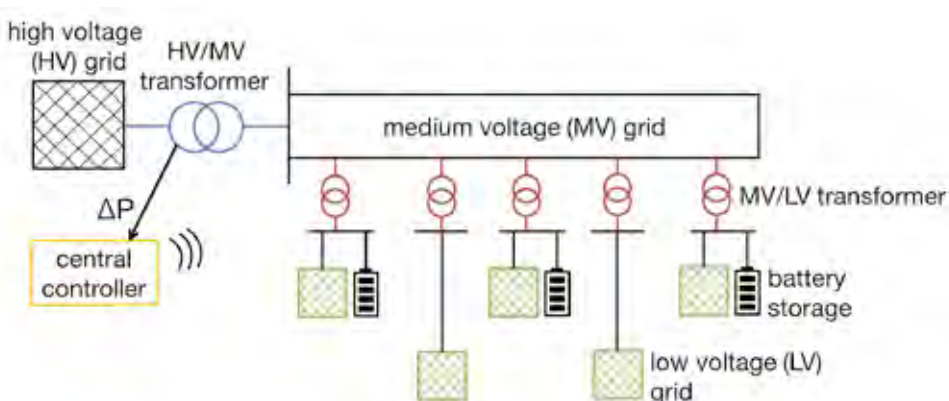

■ Figure 4: Multi voltage power grid with storages in low voltage level

Taking natural gas and thermal networks besides electricity grids into consideration, further optimization potentials for energy systems are revealed. A mixed-integer linear programming model was developed to determine optimal grid expansion and show economic feasibility of storages. Preliminary results show that battery storages are competitive especially in off-grid systems located in remote regions.

# Research Centers: Center for Power Generation

# Center for Power Generation (CPG)

## Head

### Center for Power Generation

Energy Systems  
Boltzmannstr. 15  
85748 Garching

[www.powergen.mse.tum.de](http://www.powergen.mse.tum.de)  
[cpg@mse.tum.de](mailto:cpg@mse.tum.de)

#### Head:

**Prof. Dr.-Ing. Hartmut Spliethoff**

The Center for Power Generation is led by Prof. Dr.-Ing. Hartmut Spliethoff. He also chairs the Institute for Energy Systems, which – in the context of TUM’s mechanical engineering faculty – scientifically focuses on efficiency improvement and emissions reduction from conventional power plants as well as the development of new technologies for power generation from solid fuels. In his function as director of the CPG, Professor Spliethoff sees himself as an initiator of and contact person for innovative projects among the partners of the CPG in close cooperation with external partners and governmental institutions.



**Prof. Dr.-Ing. Hartmut Spliethoff**

## Contact Persons



**Felix Fischer**



**Steffen Kahlert**

**The Center for Power Generation (CPG) is a research cooperation established within the MSE and involving multiple TUM institutes which deal with research on energy conversion. Apart from efficient and innovative power plant technologies, the research spectrum also includes innovative research on transportation and storage of electricity, control system, and new, optimized technologies to reduce greenhouse gas emissions. The CPG provides an innovative environment enabling efficient collaboration across faculty borders through the exchange of knowledge and resources from several institutes of the TUM. Furthermore, the CPG serves as a qualified contact for interested parties and potential partners, supporting the transfer and sharing of expert knowledge.**

## Need for research

Research in power generation has concentrated on a continuous efficiency improvement to decrease electricity production costs in the past decades. Due to the ‘Energiewende’ on one hand, and rocketing energy demand in developing countries on the other, the objective above has been replaced by the urgent need for highly flexible, fuel efficient, ideally near-zero emission power plants. New technologies and designs provide only half of the solution, though, as investment costs are high, payback periods of existing power plants are long and the basis of decision-making for such an investment nowadays is volatile. Therefore, upgrading existing power plants became vital for meeting the new demands for efficiency, emissions and flexibility.

## Power production in a changing market

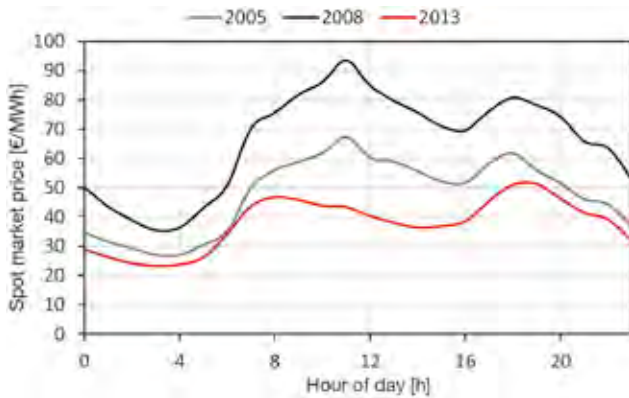

- Lower prices for electricity and lower day/night spreads at the day-ahead market make the economic operation of conventional power plants and storages more difficult.

Electricity prices at the spot market have fallen in Germany over the last years resulting from decreased costs for primary energy and from the rising production of renewable energy. The conventional power plants face economic difficulties which are caused by smaller spark spreads and lower utilization. Especially the solar power produced in the middle of the day is a cause for decreasing electricity prices. This leads to an unprofitable operation of pumped storage hydro power stations (the momentarily only available large-scale storage) because of small day/night spreads.

## Research scope of the CPG

Power generation refers to all methods and technologies for energy conversion and power supply. Thus, it covers all tasks and operations from fuel to socket. Furthermore, it includes all processes necessary to control power plants and grid operation as well as the storage of energy. Within the research efforts of the CPG, all aspects of power generation are considered with a special focus on new technology development, efficiency and flexibility increase, and emissions reduction of biomass, gas and coal fired power plants. Partner institutes contribute their expert knowledge to cooperative projects. In parallel, the acquired knowledge is shared between partners on a regular basis, building a strong common knowledge base.

### • Conventional Power Plant Technology

Conventional power plant technologies comprise all technologies producing electricity predominantly from fossil energy sources. The common ground of most of the technologies is the fact that they generate steam at high temperatures and pressures by combusting a carbon-based fuel. Steam is then expanded in a turbine. A generator is used to transform the mechanical energy into electricity. Research on this topic is primarily concerned with efficient combustion technologies, steam generation at high pressures and temperatures, power plant dynamics and control, efficient design of water/steam cycles and optimized steam turbine technologies.



■ upper images:  
power plant Irsching  
lower plant: steam turbine

- **Electrical Power Transmission**

Reliable grid design and development will become more and more important in the future, especially with further increasing of local electricity production from decentralized renewable energy sources.

- **Energy Storage**

Going along with grid improvements, storage technologies will gain more importance in the future. The power generation from renewable energies highly depends on weather conditions. Furthermore, the power of conventional backup power plants cannot be modulated as quickly as those changing conditions would require. This is where storage technologies come into play. By storing surplus energy when generation from renewables exceeds energy demand and supporting electricity supply the demand is high, energy storages help stabilizing the grid.

- **Flexibility increase by innovative plant control mechanisms and deeper understanding of material behavior**

To date, a characteristic feature of most of the existing steam power plants is their design for base load operation. Operational flexibility has often deliberately been limited to 200 cold start cycles throughout the plants life time. Driven by an increased share of green (and volatile) power generation especially in the German grid, previous base load plants now need the flexibility for frequent load changes as well as cold and warm start-ups. Power plant materials have not been designed for such requirements and hence, especially thermal stress becomes an issue. Therefore, exact knowledge of material properties and material lifetime when exposed to this new operation conditions becomes vital.

Although the fundamental working principles of conventional power plants are known for well over 100 years, a range of promising optimization measures exists. An initiative for system and technology development in close cooperation with industry will be required to achieve these measures.

Universities and research institutes have been working on new solutions and technologies, which now, considering a changed political and economic environment, provide power plant operators with multiple options for improving plant emission levels, cost effectiveness, and operation flexibility. In an increasingly fast changing setting, thorough research efforts are needed in order to provide a stable electricity supply in an economic and environmentally friendly way in accordance with political demands. Within the context of MSE, the Center for Power Generation therefore provides solutions and research on technologies and strategies which meet environmental, economic and flexibility needs as a partner of the public and the private sector.

### Systematic research at different scales

In the field of power production, the changing conditions in the market and the politics pose a challenge to the research. Innovative solutions are required to solve today's and upcoming problems.

At the Center for Power Generation, system studies are performed, which help to define the needed research and the requirements of the power system and technologies. The results are used to perform process simulations where the potential of different technologies can be analyzed.



■ In the power plant simulator

The basis of every simulation is reliable data, gathered in operating power plants or conducting experiments. At CPG, various test rigs allow detailed insight in processes. For example different gas turbine combustors are used to investigate the extension of the operation range of gas turbines and a high pressure evaporation test rig gives a closer look on modern steam generators (see chapter “Flexible Power Plants”).

#### Current activities

The Center for Power Generation coordinates several projects and activities within the MSE. Please see the respective project description for more information.

#### Energy Valley Bavaria

- **Flexible Power Plants**

Current activities of the CPG include the coordination and scientific work on the Bavarian state funded project “Energy Valley Bavaria”. The sub-project “Flexible Power Plants” is a collaboration of four CPG institutes and focuses on increasing the flexibility of current conventional power plants. The interdisciplinary team is researching on innovative technologies and their integration in the power system and their influence on the power grids.

- **Power-to-Fuel**

Within the seed-funding project Power-to-Fuel (PtF) several partners from CPG as well as industry are aiming to bundle their expertise on the field. The aim is to establish a research platform, which serves as a contact base for industry as well as a project initiator.

- **CleanTechCampus**

The objective of the seed-funding-project is the development of an innovative and economically viable concept for the energy supply of the campus Garching, building upon the strengths of the different research institutes.



■ Multidisciplinary collaborative project Energy Valley Bavaria (EVB): Research and industry partners working together under the coordination of the Munich School of Engineering





■ Working at the Biomass-to-SNG test-rig

### Bundling of Geothermal Expertise at the Munich School of Engineering

Contact:  
Christoph Wieland,  
Energy Systems  
[wieland@tum.de](mailto:wieland@tum.de)

The greater area of Munich has drawn a lot of attention due to its hydrothermal energy potential. This potential is easily accessible and can significantly contribute to reduce CO<sub>2</sub> emissions in heat and power production. During the last two years an increase of 165% of installed capacity compared to 2011 has been achieved and a lot of other plants are planned in the near future.

TUM/MSE/CPG was able to initiate the “Geothermie-Allianz Bayern” as an integrative approach to tackle deep geothermal energy and its interdisciplinary topics. Three of the major Bavarian universities will be involved covering Energy Technology, Hydrochemistry, Geology, Control and Mechanical Engineering in order to perform cutting edge research. Its main tasks are fundamental research as well as the provision of operational best practice solutions to the community. The “Geothermie-Allianz Bayern” will actively involve operators, industry and research institutes in Bavaria and Germany and will foster the exchange of research results. The project will increase and bundle the activities in geothermal energy for a sustainable and CO<sub>2</sub>-lean energy mix. Further information and details on the project will be provided during the upcoming year.



■ Geothermal Power Plant Sauerlach

# Events

## “Ideenwerkstatt für die Energiezukunft”

“How can the Bavarian and Austrian security of supply be guaranteed in the new energy age?” This question should be answered by 24 students and doctoral candidates of the team. The participants of the workshop had a different scientific background. Future architects, engineers and young scientist worked in teams to develop new ideas for key issues:



■ Finding innovative solutions in an interdisciplinary group with an intense, collaborative working process

- What is the right design for the futures electricity market?
- How can grid expansion and smart grids ensure the security of supply?
- What can hydropower contribute to gurantee the security of supply?
- What does the energy storage look like in futures energy system?

The participants were supported by experts from politics, business and science. Their valuable comments made it possible to develop innovative ideas.



■ Experts in the field of energy production, distribution and regulation



■ Questions of the „Ideenwerkstatt 2014“.

At the end of the workshop the ideas were presented by the students. A film crew accompanied the entire workshop. Short clips of the ideas and the process of idea generation were produced.

These clips were presented during the energy congress and the participants discussed their ideas with energy experts.

You find can more information and the full clips at our website:

[www.powergen.mse.tum.de](http://www.powergen.mse.tum.de)



- Presenting the ideas in front of the audience and the camera team

### Energy Congress Bavaria/Austria 2014

Apart from Germany, the neighboring countries face the impacts of the Energiewende as well. A common strategy helps to master futures challenges.



- MSE director Prof. Thomas Hamacher during a panel discussion with Bavarian Minister for Economic Affairs Ilse Aigner



■ Students and doctoral candidates at the Energy Congress (with Austrian Vice Chancellor Mitterlehner and Bavarian Minister for Economic Affairs Ilse Aigner)

At the “Energy Congress Bavaria/Austria 2014”, the Bavarian Ministry of Economic Affairs and Media, Energy and Technology invited energy policy makers, as well as experts from industry and science to discuss the energy future.

Students and doctoral candidates from TUM used the platform to present their ideas and MSE director Prof. Hamacher discussed current energy issues with leaders in politics and industry.

### **TUM-Workshop “SNG as key for future energy systems – power-to-gas and biomass-to-gas”**

On Friday 9th May 2014 a TUM-Workshop concerning research on Substitute Natural Gas (SNG) was held. It was organized by the Center for Power Generation and brought together 150 participants from several institutes as well as industry sectors.

In two sessions, 13 oral presentations were given under the topics of “thermo-chemical SNG production” and “power-to-gas” with contributions from Siemens AG, Linde AG, PSI, DBFZ, Fraunhofer IWES, FAU Erlangen-Nürnberg, several TUM institutes and others.

Additionally, 26 posters showing the current progress in research were presented in three blocks (system analysis, catalysis and reaction kinetics, simulations and experimental research) with contributions from several institutes. Last but not least, the future TUM platform “Power-to-Fuel” was presented during the workshop. Integrated research shall be conducted within a joint project from several TUM institutes and cooperating



■ Participants of the TUM-Workshop on SNG

partners from industry, aiming on cost degradation of gaseous ( $H_2$ , SNG) and liquid (e.g. methanol) fuels, produced via electrolysis and subsequent synthesis.

There was agreement throughout the workshop that chemical energy storages will be required in future renewable-based energy systems and that research on new technologies should not be hindered by currently too high system costs.

### Partner Institutes

Overall, 18 institutes of the TUM from 4 different faculties and departments participate in the network of the Center for Power Generation. In addition, several external research institutes and partners from industry are using the platform provided by the CPG. The goal is to encourage the exchange of information and to initiate close cooperation in pioneering research projects. If you are interested in the work of the CPG feel free to contact us.

**In the following, the institutes which are currently involved in research projects of the CPG are briefly introduced:**

- **Institute for Technical Electrochemistry - Prof. Dr Hubert Gasteiger**  
 The institute works on the synthesis of novel electrocatalysts and their incorporation into high-performance fuel cell, electrolyzer, and battery electrodes. The focus ranges from simple model systems to more complex high-surface area materials and electrode structures.
- **Chair of Chemical Engineering - Prof. Dr.-Ing. Kai-Olaf Hinrichsen**  
 The research work is oriented along the process chain, starting from particle design over reactor design to process design. Topics include particle design and technology, chemical reaction engineering aspects (i.e. reaction kinetics, multiphase systems), modeling of reactive flows and chemical reactors, the design of novel reactors (i.e. adsorptive reactors, multifunctional reactors, microreactors, fluidized-bed reactors) and the optimization of entire (integrated) chemical processes. Special focus is laid on methanol chemistry and hydrogen production.
- **Institute of Power Transmission Systems - Prof. Dr.-Ing. Rolf Witzmann**  
 The field electrical power supply grids is occupied with tasks of energy transmission and distribution and with the integration of local, renewable energy generation as well as with new stochastically distributed demands like electromobility in the future.
- **Institute for Systems Engineering and Process Technology - Prof. Dr.-Ing. Harald Klein**  
 Teaching and research by the institute concentrate on thermal separation techniques for fluid mixtures (f.e. distillation, rectification, absorption). Subtopics are the thermodynamic basics of thermal separation (f.e. phase equilibrium, mass transport), the synthesis and optimization of complete processes and the technical design of separation devices.
- **Chair for Thermodynamics - Prof. Dr.-Ing. Thomas Sattelmayer**  
 Research at the Chair for Thermodynamics is inspired by the needs of the power generation industry. Fuel flexibility, emission reduction, stability and reliability of combustion processes (predominantly gaseous fuels) are important research topics. In particular, a broad portfolio on combustion instabilities has been developed. Additional activities in the areas of mobility, aerospace and energy efficiency are continuously developed.
- **Institute for Energy Systems - Prof. Dr.-Ing. Hartmut Spliethoff**  
 The Institute of Energy Systems focusses on current challenges in energy technology. The research is divided into four areas: Power plants technologies, modeling & simulation, measurement techniques and renewable energies. Current research addresses challenges related to solid fuel combustion, including biomass, gas, coal and waste. Activities also include regenerative energy production and energy storage. The institute is participating in several national and international research projects, in cooperation with other research institutes as well as industrial partners.
- **Institute for Renewable and Sustainable Energy Systems - Prof. Dr. rer. nat. Thomas Hamacher**  
 At the Institute for Renewable and Sustainable Energy Systems, models for different scales of time and space are developed to describe and understand present and future processes of change. The institute's main focus is the development of advanced methods for modeling technical and economical interactions to find optimal solutions concerning economic benefits, external costs and environmental impacts.
- **Institute for Electrical Energy Storage Technology - Prof. Dr.-Ing. Andreas Jossen**  
 The institute is engaged in electrical energy storage, especially in rechargeable batteries. Aside from lithium batteries also conventional systems (for example plumb batteries and alkaline systems) play a role. Furthermore future systems like metal-air, redox flow and high temperature batteries are part of the research.



# Research Centers: Network for Renewable Energy





# Network for Renewable Energy (NRG)

## Network for Renewable Energy (NRG)

James-Franck-Str. 1  
85748 Garching

[www.nrg.mse.tum.de](http://www.nrg.mse.tum.de)

### Head:

Prof. Dr. Peter  
Müller-Buschbaum

Functional Materials,  
Department of Physics

The Network for Renewable Energy (NRG) is a network for inter-faculty research at the Technische Universität München consisting of a multitude of different chairs at the TUM which are focusing on the topic of renewable energy. The network is one of currently four research centers at the Munich School of Engineering. Together, these four centers follow the aim to achieve a sustainable energy supply of the future. NRG is headed by Professor Müller-Buschbaum, Chair for Functional Materials, and was founded to create the opportunity to stem interdisciplinary, large-scale Research. Additionally regular meetings within the network take place to foster an active communication between different research groups.

## TUM.solar

Prof. Dr. Peter  
Müller-Buschbaum

Functional Materials,  
Department of Physics

The Solar technologies go Hybrid Research Network SolTech is an interdisciplinary project initiated by the Free State of Bavaria to explore innovative concepts for converting solar energy into electricity and non-fossil fuels. It concentrates on two areas; firstly, photovoltaics (i.e. the conversion of solar energy into electric current) and secondly techniques with which solar energy can be stored as chemical energy. The network is formed by five universities in Bayreuth, Erlangen-Nuremberg, Würzburg and Munich. At each place well-equipped laboratories, the so-called key labs, integrated into existing internationally recognized research centers, have been set-up. TUM.solar is the key lab at Technische Universität München.

New concepts for the controlled structuring of material interfaces as well as the use of new materials for energy transformation and energy storage offer an enormous potential for pushing the utilization of regenerative energies into new areas in the future. The use of nanomaterials, organic-organic or organic-inorganic hybrid systems, enables completely new concepts and visions of energy transformation and energy storage.

TUM.solar is focusing on research in light-induced energy transformation and energy storage based on these nanomaterials and hybrid systems. There is a wide range of possibilities, from catalytic processes to low-cost photovoltaics. The respective basic questions refer to aspects of material preparation and charge transfer at interfaces.

For this purpose, TUM.solar combines complementary investigations by theoretical and experimental research groups in physics, chemistry, and electrical engineering.

Shape and mobility of future generations of solar cells could reach completely new dimensions by the use of new fluid-based production processes. These promise new possibilities of use, applicable in mobile entertainment electronics as well as in the power production of mega cities. Furthermore, new materials allow alternative production processes leading to considerably decreased production costs and thus promising future low-cost power production.

A completely different attempt to energy storage, far from nowadays' energy storage technologies, is offered by photocatalysis. Here the concepts are new catalysis materials and guided structuring of electrolyte interfaces which help to increase efficiency. Examples like photo-chemical reduction of carbon dioxide and water splitting are aspects which can direct to the so-called "green technologies".

Furthermore, the combination of photocatalysis and photovoltaics is expected to generate additional synergy effects. In integrated systems, the load transformation and the load storage can be directly connected on the nanoscale. The aimed optimization of symbiotical systems of photocatalysis and photovoltaics instead of individual optimization of independent singular systems is a new attempt and a central goal of TUM.solar.

Thus, research in TUM.solar covers the whole "chain of value creation" from energy transformation up to energy storage and hereby aspects of basic physical-chemical processes up to application-related questions such as the construction of prototypes. As a part of the "Network of Regenerative Energies" (NRG), TUM.solar is integrated in TUM.Energy, the faculty-general research project of Munich School of Engineering (MSE).

In 2014 the PIs working at TUM.solar were Prof. Thomas Fässler (CH), Prof. Katharina Krischer (PH), Prof. Paolo Lugli (EI), Prof. Peter Müller-Buschbaum (PH), Prof. Karsten Reuter (CH) and Prof. Martin Stutzmann (PH). In the following projects on wet chemical method for germanium/silicon networks, CO<sub>2</sub> conversion on silicon, nanoimprinting and coating techniques for hybrid solar cells, complex structured hybrid solar cells, theoretical investigation of solar-energy materials and photocatalysis with group III-nitrides are performed.

## A Wet Chemical Method for Germanium/Silicon Networks

Ordered porous inorganic semiconductor networks are proven to be valuable for the fabrication of efficient hybrid solar cells, as such materials provide high interface areas for efficient exciton dissociation and continuous pathways for the charge transport [1]. Silicon and germanium, instead of widely used metal oxides, are in particular interesting due to the broad adjustability of opto-electronic properties, e.g. by nanostructuring and/or preparation of solid solutions Si<sub>x</sub>Ge<sub>1-x</sub>, combined with high charge carrier mobility. Especially, doped Si<sub>x</sub>Ge<sub>1-x</sub> networks might be promising for the assembly of more efficient hybrid solar cells due to significantly more favorable electronic properties.

More about SolTech:

[www.soltech-go-hybrid.de/about-soltech/](http://www.soltech-go-hybrid.de/about-soltech/)

More about TUM.solar:

[www.tum-solar.mse.tum.de/](http://www.tum-solar.mse.tum.de/)

**Prof. Dr. Thomas Fässler**

Inorganic Chemistry with Focus  
on Novel Materials,  
Department of Chemistry

However, the majority of fabrication methods for such doped and undoped silicon/germanium morphologies are elaborating and based on complicated physicochemical techniques, owing to the lack of precursors suitable for wet chemical reactions [2].

In close interdisciplinary cooperation with working groups at TUM, LMU, WSI and ASCR the Fässler group in scope of the Bavarian research project “Solar Technologies go

Hybrid” developed a wet chemical method to utilize homo- and heteroatomic  $[E_9]^{4-}$  Zintl clusters (E = Si and/or Ge) as flexible precursors for the fabrication of germanium/silicon morphologies. Additionally, we succeeded in designing a route for wet chemical phosphorous-doping of those non-oxide semiconductor networks [3-5].

In cooperation with Prof. Dr. Paolo Lugli (TUM) we designed a procedure to apply our soluble precursors by spin coating on a PMMA opal template structure, leading to homogenous thin films of germanium/silicon with inverse opal structure. Moreover, we plan to apply spray coating techniques to fabricate larger areas of our thin films. With scanning- and transmission electron microscopy (Prof. Dr. Dina Fattakhova-Rohlfing LMU) we investigated the morphology of our films and found nanostructured pore walls. The volume morphology and nanostructure of our films were investigated in detail with grazing incidence small angle X-ray scattering (Prof. Dr. Müller-Buschbaum, TUM). Additionally, X-Ray photoelectron spectroscopy (XPS) (Prof. Dr. Wintterlin LMU) for the investigation of oxidation states as well as Raman- and photo thermal deflection spectroscopy (PDS) (Prof. Dr. Martin Brandt WSI) were used to prove doping of our films.

In cooperation with Prof. Dr. Müller-Buschbaum tests regarding the application of our thin films for photovoltaic applications are in progress.

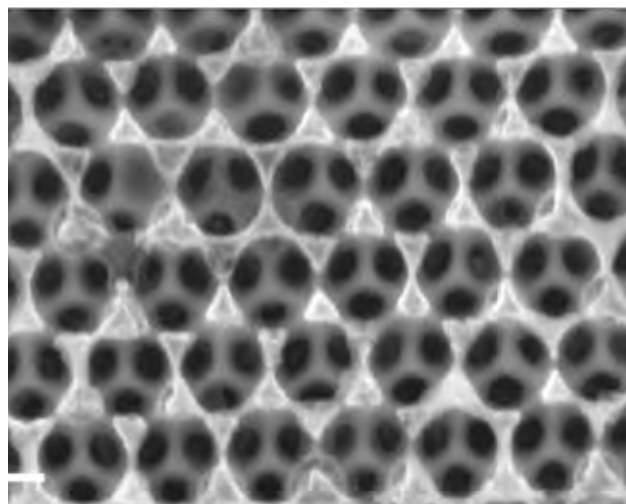

Fig. SEM micrograph of a amorphous germanium thin film with inverse opal structure.

[1] McGehee, M. D.: Nanostructured Organic-Inorganic Hybrid Solar Cells. MRS Bulletin 2009

[2] Stein, A.: Materials science: Germanium takes holey orders. Nature 2006

[3] Bentlohner, M. M., Geier, S.: unpublished results 2015

[4] Waibel, M.; Pecher, O.; Mausolf, B.; Haarmann, F.; Fässler, T. F.:  $NaRb_7(Si_{4-x}Ge_x)_2$  Soluble Zintl Phases Containing Hetero-atomic Tetrahedral  $[Si_{4-x}Ge_x]^{4-}$  Clusters. European Journal of Inorganic Chemistry 2013

[5] Waibel, M.; Fässler, T. F.: Mixed Si/Ge Nine-Atom Zintl Clusters: ESI Mass Spectrometric Investigations and Single-Crystal Structure Determination of Paramagnetic  $[Si_{3-x}Ge_x]^{3-}$ . Inorganic Chemistry 2013

## CO<sub>2</sub> Conversion on Silicon

Silicon is a material ideally suited for solar energy conversion and the necessary technologies are well established and applied on a global industrial level. It is abundant worldwide, non-toxic and cheap. The challenge in adapting the silicon technology to chemical processes lies in the relatively poor catalytic properties of this material. The solution to this can be found by identifying a catalyst that is both compatible with silicon and active regarding the CO<sub>2</sub> reduction reaction. Such a catalyst can then be attached to the silicon surface modifying its chemical properties. To have the potential for industrial upscaling the catalyst should additionally be easily accessible, non-toxic and cheap. Thus, the research of the Krischer group follows a twofold path: Firstly, the decoration of the silicon with metal nanostructures as catalytically active reaction centers, and secondly, the attachment of aromatic molecules known to catalyze the CO<sub>2</sub> reduction.

Prof. Dr. Katharina Krischer

Non-Equilibrium Chemical  
Physics, Department of Physics

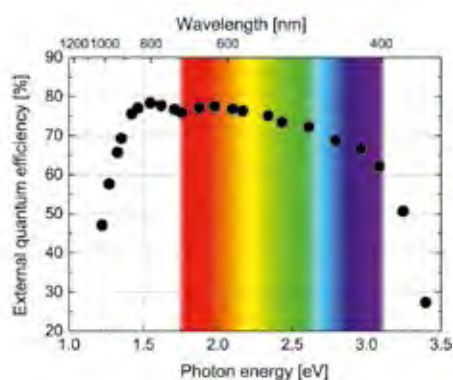

■ Fig. left: External quantum efficiency (percentage of incoming photons that are used) of a p-Si photoelectrode functionalized with gold structures depending on the photon energy of incoming radiation.

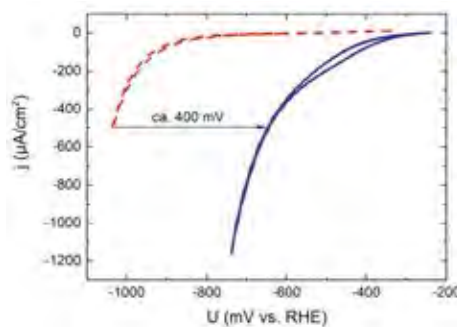

■ Fig. right: Decrease of the overvoltage necessary for electrochemical reactions due to a surface modification with aromatic molecules

For the first approach, a detailed understanding of the semiconductor/metal particle/electrolyte system is indispensable. To this end, metal arrays with different length scales and identical geometries are fabricated on silicon substrates using nanotransfer printing. These samples are then characterized regarding the size dependence of the photoelectrochemical properties and reaction product distribution. Furthermore, the composition of the metal structures themselves is varied and optimized. The second approach focuses on two main tasks, the production of monolayers of the aromatic molecules and the study of their catalytic properties. For this purpose, electrochemical methods like rotating ring-disk electrode measurements and surface characterization methods e.g. x-ray photoelectron spectroscopy are employed. We already observed an increase in the catalytic activity of silicon surfaces modified this way. We aim toward a deeper understanding of the catalytic mechanism and a further optimization of the parameters for the surface preparation. For all experiments a full quantitative analysis of the reaction products e.g. methane, methanol, formic acid and carbon monoxide on a reasonable timescale is crucial. Therefore an electrochemical flow cell setup equipped with a differential electrochemical mass spectrometer (DEMS), a high pressure liquid chromatograph (HPLC) and a gas chromatograph (GC) were built up in our research group.

## Nanoimprinting and Coating Techniques for Hybrid Solar Cells

**Prof. Dr. Paolo Lugli**  
 Nanoelectronics,  
 Department of Electrical and  
 Computer Engineering

Organic solar cells (OSC) are appealing compared to standard inorganic devices due to the large area processing possibility and the cost-effective solution processability at low temperature.

The Lugli group has studied various printed devices based on P3HT and low band gap materials as electron donors fabricated on flexible and rigid substrates using spin and spray coating techniques. The starting layout was that of the conventional bulk heterojunction with a [6,6]-phenyl-C61-butyric acid methyl ester (P3HT:PCBM) blend. We have studied the effect of a 1,8-diodooctane (DIO) processing additive, demonstrating efficiencies above 5% [1] for OSC on glass.

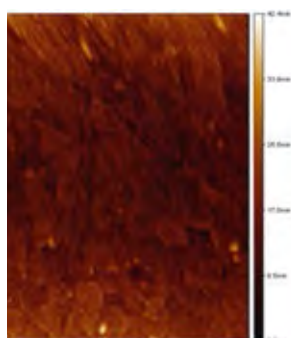

■ Fig. 1 AFM topography images of spray-coated PEI



■ Fig. 2: ITO-free flexible organic solar cell

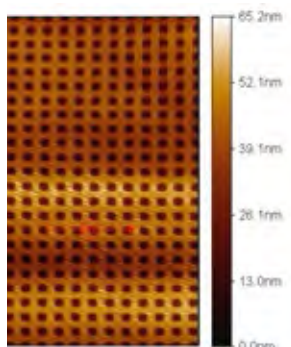

■ Fig. 3 Patterned P3HT:PCBM layer transferred onto glass substrates with existing ITO and PEDOT:PSS layer

In order to be able to fabricate a whole solar cell via printing techniques, we have started the realization and characterization of electrodes via solution based materials (e.g. carbon nanotube, silver nanowires and PEDOT films) which substitute the expensive and brittle indium thin oxide (ITO). The results are very promising and indicate a full compatibility of the different processes. In order to be able to tune the electrode work function (which would allow us to use the same material for both anode and cathode) we have used polyethylenimine (PEI) and polyethylenimine ethoxylated (PEIE) as universal work function modifiers. The morphology of a sprayed PEI layer is shown in Fig. 1. An example of an ITO-free semitransparent organic solar cell fabricated on PET is shown in Fig. 2. For such cells we have demonstrated efficiencies around 3.3%. A still open issue relates to the passivation of the cell, which degrades after a few days.

In addition we have used nanoimprinting techniques to realize patterns on the top surface of a solar cell (for instance in the form of electrode grating) or at any interface of a multilayer material system (for instance at the interface between bottom electrode and active layer). By tailoring the dimension and the pitch of the grid it is possible to enhance the transmission or the trapping of light into the cell for specific wavelengths. Fig. 3 shows the surface of a patterned P3HT/PCBM layer transferred on a glass which previously had been coated with ITO and PEDOT-PSS (electron and electron blocking layer). The holes are 40 nm in diameter. The patterned active layer is then covered with a Ca/Ag electrode. This solar cell has shown an increased efficiency (17%) with respect to a reference cell with a flat (non patterned) active layer.

From the simulation point of view, we have set up a simulation of organic solar cells using a kinetic Monte Carlo approach. The simulation results agree well with measurements for standard P3HT/PCBM solar cells.

[1] F. Arca, M. Loch, P. Lugli, IEEE J. Photovolt. 4, 1560 (2014)

## Complex Structured Hybrid Solar Cells

To realize next generation solar cells different competing concepts have emerged during the last years. Among these concepts the so-called dye sensitized solar cells (DSSC) and hybrid solar cells both combine organic and inorganic materials. Thus, the advantages of both types of materials can be combined in such next generation solar cells, which are promising, due to being potentially cheap, lightweight, easily manufactured and since they offer short energy pay-back times.

Based on block copolymer assisted sol-gel synthesis nanostructured zinc oxide (ZnO) films are prepared by the Müller-Buschbaum group. So far, mostly titanium dioxide has been used as inorganic material for DSSCs, but other inorganic semiconductors, such as ZnO, with optoelectronic properties similar to those of titanium dioxide, serve as suitable alternatives. DSSC or hybrid solar cells based on ZnO did not reach device efficiencies of titanium dioxide based photovoltaic cells until now. Thus, it appears interesting to improve ZnO nanostructures for solar cell applications and in particular to investigate large scale deposition methods.

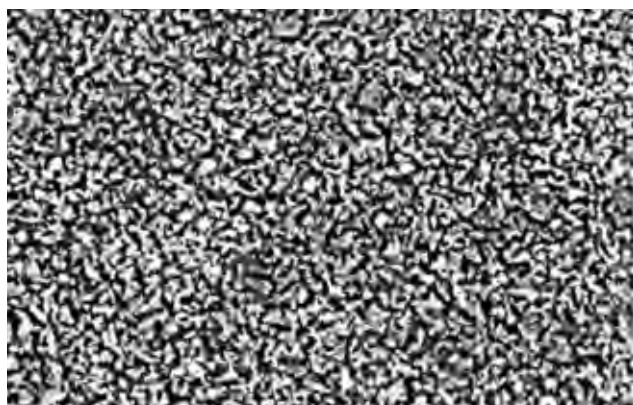

■ Fig.: ZnO nanostructure created with sol-gel chemistry as probed with SEM. An interconnected network of ZnO is created. Percolating paths are beneficial for solar cell applications.

Using an approach based on sol-gel chemistry together with a structure-directing amphiphilic diblock copolymer results in a high level of control of the nanostructure. Recently, we succeeded in synthesizing different ZnO nanostructures by a block copolymer assisted sol-gel chemistry approach [1]. A variety of ZnO nanoscale morphologies were realized

depending on the weight ratio of constituents [2]. For application in next generation solar cells porous nanostructures are of particular interest, if the pore sizes are on the order of several tens of nanometers (see figure). In this respect, tuning the pore size of ZnO nano-grids via time-dependent solvent annealing turned out to be a very powerful method [3].

Monitoring the structural dynamics of in-situ spray-deposited ZnO films with advanced X-ray scattering techniques was the key for gaining fundamental understanding about the morphology evolution and allowed realizing DSSCs with high short circuit currents [4]. Spray-deposited zinc titanate films were also obtained via sol-gel synthesis [5].

[1] K. Sarkar, M. Rawolle, E. M. Herzig, W. Wang, A. Buffet, S. V. Roth, P. Müller-Buschbaum, *ChemSusChem* 6, 1414-1424 (2013)

[2] K. Sarkar, M. Rawolle, M. A. Niedermeier, W. Wang, E. M. Herzig, V. Körstgens, A. Buffet, S. V. Roth, P. Müller-Buschbaum, *J. Appl. Cryst.* 47, 76-83 (2014)

[3] K. Sarkar, C. J. Schaffer, D. Moseguí González, A. Naumann, J. Perlich, P. Müller-Buschbaum, *J. Mater. Chem. A* 2, 6946-6951 (2014)

[4] K. Sarkar, E. V. Braden, S. Pogorzalek, S. Yu, S. V. Roth, P. Müller-Buschbaum, *ChemSusChem* 7, 2140-2147 (2014)

[5] K. Sarkar, E. V. Braden, T. Fröschl, N. Hüsing, P. Müller-Buschbaum, *J. Mater. Chem. A* 2, 15008-15014 (2014)

Prof. Dr. Peter  
Müller-Buschbaum

Functional Materials,  
Department of Physics

## Theoretical Investigation of Solar-Energy Materials

**Prof. Dr. Karsten Reuter**

Theoretical Chemistry,  
Department of Chemistry

In search of alternative energy solutions the role of theoretical investigations and especially of computational simulations more and more emphasized. The strengths of theory here are twofold. First, through the atomic insight yielded by theory, but often inaccessible to experiments, it becomes possible to explain mechanisms underlying the phenomena observed in experiment. Second, through more and more accurate computational methodologies it is now possible to search for optimal materials and structures by way of computational screening. The Reuter group developed methods enabling both tasks in the fields of organic solar cells and photocatalytic hydrogen production.

**Mobility:**  $\mu = \frac{\partial \langle \vec{v} \rangle}{\partial \vec{E}}$

Average charge carrier velocity in a field divided by the field strength

**Hopping Model:**

A theoretical approach based on the assumption that charges move through a material in a series of discrete jumps or "hops"

**FHI-AIMS:**

<https://aimsclub.fhi-berlin.mpg.de/>

One of the key parameters governing the efficiency of organic solar cells is the mobility of charge carriers within the cell. Yet, experimentally measured mobilities are often heavily affected by the device preparation, which masks the intrinsic material properties and thus hampers the decision whether further device preparation for a given organic molecule is worthwhile or not. Based on a hopping model we found a combination of easily computable parameters, called a descriptor, which yields very good correlation with the charge mobility. Thus, we can now determine the merits of a given material based on this descriptor instead of having to calculate the full mobility for each candidate molecule and structure. We implemented the determination of this descriptor into our ab-initio electronic structure code FHI-AIMS and fully automated the screening procedure to allow for high throughput search for optimal solar cell materials and structures.

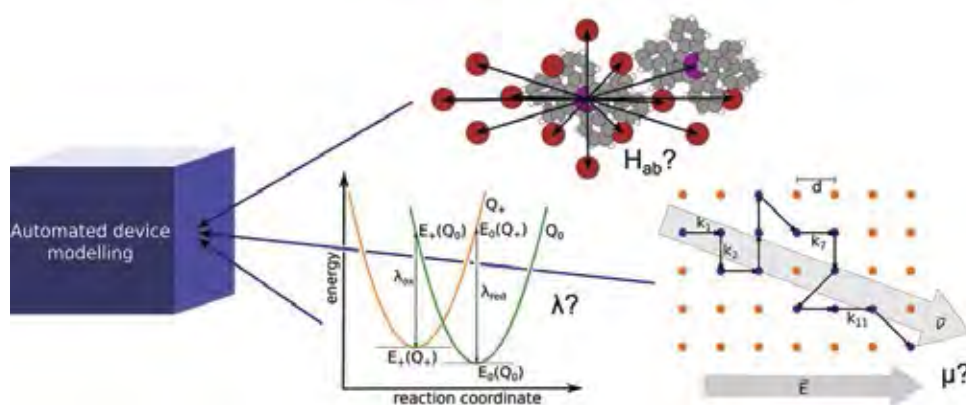

■ Fig1: Schematic of an automated device modeling approach based on a hopping model (bottom center and right). Top: possible charge transfer directions in an organic crystal

First applications of this new screening procedure already yield interesting results showing very large mobility variations between molecules and structures. This demonstrates the importance of inexpensive computational approaches as a guide to further in-depth experimental studies.

## Photocatalysis with Group III-Nitrides

The group III-nitrides GaN, InN, and AlN constitute a materials system which today is widely used and commercialized in solid state lighting as well as in high speed and high power electronics. In this project the Stutzmann group investigates possible applications of these semiconductors in electrochemistry and photocatalysis. In particular GaN and InGaN alloys have interesting properties in combination with silicon solar cells or as electronically active supports for catalytic nanoparticles.

**Prof. Dr. Martin Stutzmann**  
Experimental Semiconductor  
Physics II  
Walter-Schottky-Institute

In this context, we investigate the fundamental properties of the so-called group III-nitrides InN, GaN, and AlN. Of particular interest is GaN alloyed with InN (InGaN), because the optical absorption of this ternary alloy can be tuned continuously through the entire visible spectrum from the infrared (InN) to the ultraviolet radiation (GaN). This allows a good match to the solar spectrum. Samples are grown by molecular beam epitaxy either in the form of 2D thin films or as disordered and ordered arrays of nanowires, as shown below [1,2].

Thin films are used for the investigation of basic electronic and electrochemical properties, whereas nanowire arrays provide very large effective surfaces in a well controlled way. We combine the InGaN layers or nanowires in the form of heterojunctions with other materials such as silicon (for solar cells), diamond (for electrochemistry) or platinum (for catalysis).

Molecular beam epitaxy (MBE) is the deposition method of choice to produce tailor-made semiconductor heterostructures with well-defined properties. In MBE, the different chemical elements such as In, Ga, or N are provided by independent high purity atomic or molecular sources, enabling full control of chemical composition on the level of atomic monolayers. In addition, a controlled variation of the growth conditions is used to determine the morphology of the deposited samples (continuous 2D films, quantum dots, or nanowires – see figure).

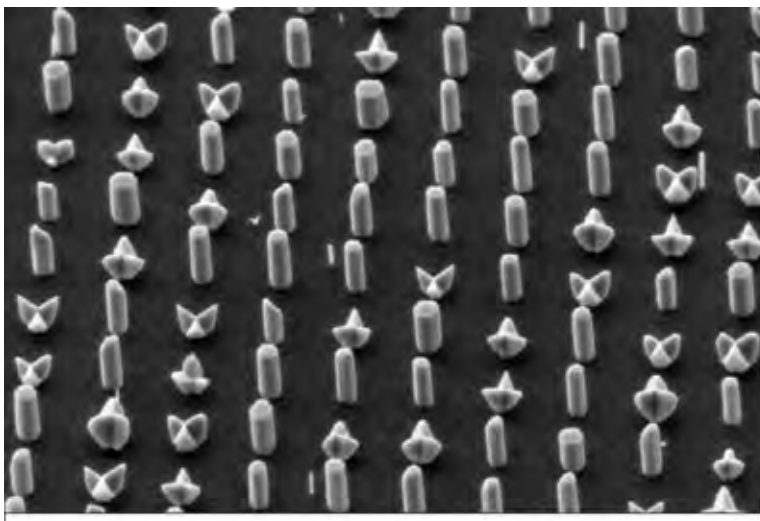

■ Fig.: Arrays of nanowires created with MBE as probed with SEM.

[1] F. Schuster, B. Laumer, R. R. Zamani, C. Magén, J. R. Morante, J. Arbiol, M. Stutzmann, ACSNano 8, 4376–4384 (2014)

[2] F. Schuster, S. Weiszer, M. Hetzl, A. Winnerl, J. A. Garrido, M. Stutzmann, J. Appl. Phys. 116, 054301 (2014)



## Interface Science for Photovoltaics - ISPV

More about EuroTech universities:  
[www.eurotech-universities.org/home.html](http://www.eurotech-universities.org/home.html)

More about ISPV:  
[www.eurotech-universities.org/research/greentech-initiative/ispv.html](http://www.eurotech-universities.org/research/greentech-initiative/ispv.html)

The project Interface Science for Photovoltaics (ISPV) is one of the network projects within the Green Tech Initiative. It brings together researchers from each of the four EuroTech universities DTU, EPFL, TU/e and TUM. The initiative will focus on the development of future photovoltaic technologies and combine the knowledge from the fields of thin film and organic photovoltaics. ISPV focuses on fundamental issues within solar cell research.

The Green Tech initiative intends to guide and stimulate joint Research under the strategic theme of Green Tech with the aim to foster research in environmentally friendly technologies and sustainable energy generation.

Thin film semiconductor solar cells, organic solar cells, and hybrids with organic and inorganic materials are among the technical options for photovoltaic technologies that will secure a continued lowering of solar cell prices, reduced materials use, and versatile design of photovoltaic systems.

Improvement of performance and lifetime are crucial issues for all the technologies when they are compared to crystalline solar cells that represent 90% of today's installations. The proposed initiative creates the basis for such improvements through understanding and characterizing the relation between structural morphology and performance and degradation in solar cells. Many important processes occur at interfaces in thin film and the even thinner organic solar cells. Transport of charge carriers, excitons, impurities, reactive gasses – water and oxygen – are particularly influenced by interfaces in the structure on both nano- and micro-scale. The photovoltaic effect itself relies on the existence of a junction between regions promoting transport of negative and positive charge carriers. Degradation mechanisms are often linked to interfacial properties. Both thin film photovoltaics and organic photovoltaics rely on materials with internal nano-scale morphology of the active materials – like nanotextured “black Silicon” and the bulk hetero junction of polymer solar cells. Likewise both technologies exploit interfacial layers for conduction and injection of charge carriers and transmission of light.

The team represents two disciplines – thin film solar cells and polymer solar cells – with competences within both physics and chemistry of materials. The team will unite the experience in both disciplines and utilize the techniques and theoretical understanding of both areas. Through Ph.D. and master level exchange, through common projects and through educational activities, the team will seek to establish a lasting collaboration in the area of photovoltaics.

In 2014 the PIs working at TUM.solar were Prof. Martin Brandt (WSI), Prof. Peter Müller-Buschbaum (PH) and Prof. Martin Stutzmann (WSI). The projects were focusing on advanced interface engineering for silicon heterojunction solar cells, silicon heterojunction devices, polycrystalline solar cells and stability and performance of polymer solar cells, which includes objectives like exploring new material & controlling material properties, extending thin film preparation techniques, advanced interface analysis, mobility and interfacial effects under degradation, interface states in solar cells and device physics & engineering. In the following selected examples are shown in detail. These examples focus on spin-dependent processes in organic solar cells and polymeric electrodes for all-printed organic electronics such as organic solar cells.

## Spin-Dependent Processes in Organic Solar Cells

The low fabrication costs of organic solar cells make them a competitive source of renewable energy. Further improvements of the efficiency of organic photovoltaics (OPV) are expected e.g. from advances in chemistry and the optimization of charge carrier transport. The latter could be achieved with the help of the natural magnetic moment possessed by electrons which are the charge carriers in organic or polymer thin films. This so-called spin has a decisive influence on the charge carrier dynamics, as for example observed in organic magnetoresistance (OMAR).



■ **Figure:** An organic solar cell used for the pEDMR experiments. The inset shows a schematic depiction of the generation of positive and negative polarons via a charge transfer process. The rate of recombination of the two polarons depends on the fraction of polarons with anti-parallel spin orientation and thus can be manipulated by magnetic resonance.

experimental method, the combination of the selectivity of traditional magnetic resonance techniques and the sensitivity of an all-electric readout provides a unique insight into charge transfer and carrier recombination on a molecular level. The time resolution of pulsed in contrast to continuous wave experiments enables an investigation also of the dynamics of these processes. It is thereby possible to measure the time constants relevant for the different specific spin-selective processes such as the lifetime of spin pairs and the decoherence of spins. Moreover, this technique has an enormous potential in the investigation of the hyperfine interaction between charge carriers and their surrounding nuclei, allowing to microscopically map the wavefunctions of spin states.

Beginning with the model system of a bulk heterojunction of P3HT and PCBM we have performed pEDMR experiments in a wide temperature range from 4 K to 300 K, thus enabling a measurement of the temperature dependence of the spin dynamics. At low temperatures, we can spectroscopically distinguish positive and negative polarons and can demonstrate with experiments employing two different microwave frequencies that a spin-dependent recombination involving pairs of these polarons is monitored, identifying one of the dominant loss processes limiting the efficiency of P3HT/PCBM solar cells. Further experiments will include fast laser-excitation of charge carriers in order to increase the time resolution of the pair generation process, electron nuclear double resonance (ENDOR) experiments for the investigation of hyperfine interactions, and experiments at low magnetic fields to gain a more detailed understanding of the coupling between the spin partners. Another aim of this research will be to correlate the results of the pEDMR experiments with the findings of the group of Peter Müller-Buschbaum regarding the microscopic structure of different functional polymers and organic semiconductors.

**Prof. Martin Stutzmann**

**Prof. Martin Brandt**

Experimental Semiconductor  
Physics II,  
Walter-Schottky-Institute

To understand the effect of magnetic fields in detail and to improve the efficiency of OPV, we study spin-dependent processes in organic solar cells using the method of pulsed electrically detected magnetic resonance (pEDMR), which has already proven to be a highly valuable tool to investigate charge transport processes in materials relevant for inorganic photovoltaics. In this

## Polymeric Electrodes for All-Printed Organic Electronics

Prof. Dr. Peter Müller-Buschbaum

Functional Materials, Department of Physics

The semi-transparency and potential to up-scale devices to large areas, makes organic electronics (OE) and organic photovoltaic devices (OPV) highly interesting for implementation e.g. into buildings. Further their adaptability due to their flexibility and light weight open up additional applications such as portable modules. One of the main advantages for all applications is the potential of easy up-scaling by printing technologies such as roll to roll (R2R) with slot die coating. However, most investigations of morphology, crystallinity and electronic properties of thin films for OPV are based on lab-scale techniques as spin coating. The growth of thin films, however, crucially depends on the conditions during film deposition and film treatment.

Going towards all printable electronics, there are still challenges for roll-to-roll processed flexible devices. Typically, oxide materials such as indium tin oxide (ITO) are used as TCO in the fabrication process for organic solar cells or light emitting diodes. ITO however has several drawbacks which become obvious if aiming for up-scaling of OEs. The high cost of ITO and the limited resources of indium are limiting factors, but also the brittleness of ITO under bending plays a crucial role. Thinking of flexible devices, this is one of the main advantages of OPV devices over conventional photovoltaics. Several attempts have been made to substitute ITO as an electrode. In this context, the polymer blend PEDOT:PSS has attracted high attention. This is mainly due to its advantageous properties such as transparency, easy processability, as dispersed in water and stability upon bending. Further, PEDOT:PSS is already implemented in organic electronic devices. To use PEDOT:PSS directly as an electrode, however, it is still lacking in conductivity. Blending with high boiling point co-solvents is known to increase the conductivity of PEDOT:PSS from 10 S/cm by three orders of magnitude. This makes it comparable to the conductivity of ITO and it can thereby replace ITO as a stand-alone electrode.

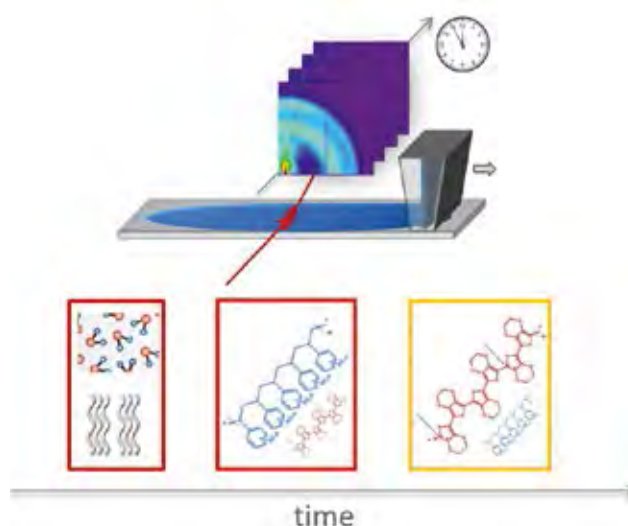

■ Figure: Sketch of in-situ GIWAXS investigations of PEDOT:PSS polymeric electrodes. The morphology of printed PEDOT:PSS films is probed.

of PEDOT:PSS from 10 S/cm by three orders of magnitude. This makes it comparable to the conductivity of ITO and it can thereby replace ITO as a stand-alone electrode.

The performance of optimized OE devices strongly depends on the optimum length scales of the nanomorphology. In this project, the underlying morphological changes in the film volume are probed with ex-situ and in-situ X-ray scattering techniques (see figure) [1].

[1] C. M. Palumbiny, C. Heller, C. J. Schaffer, V. Körstgens, G. Santoro, S. V. Roth, P. Müller-Buschbaum, J. Phys. Chem. C 118, 13589-13606 (2014)



# Research Centers: Science Center for Electromobility

# Science Center for Electromobility (WZE)

The Science Center for Electromobility is TUM's interdisciplinary research institution which addresses all relevant questions regarding electric and hybrid vehicles. Its activities cover various fields such as fundamental research on new battery chemistries, applied science including the implementation and testing of prototypes, and the development of holistic and intermodal mobility concepts.

## General information and focus areas of the Science Center for Electromobility

Cross-faculty research for interdisciplinary research challenges

As most research questions regarding electric or hybrid vehicles are interdisciplinary, the Technische Universität München founded the Science Center for Electromobility as early as in 2010. In this cluster, individual research groups are connected with each other which facilitates working successfully on projects with an integral scope.

### The main goals of the Science Center for Electromobility are:

- It concentrates research and development activities concerning electromobility
- It creates additional competence teams as well as education programs for electromobility at TUM
- It enables fundamental research for innovative long term developments (e.g. in the field of energy storage)



■ Figure 1: German logo of the Science Center for Electromobility

Furthermore, the Science Center for Electromobility offers a forum for the exchange of the latest research results and for general communication of all partners involved. Hence, the current complex challenges can be addressed quickly and efficiently and a common strategy can easily be coordinated.

In order to guarantee a large research scope and to effectively use possible synergies between electromobility and other relevant sectors, the Science Center for Electromobility is integrated within TUM.Energy, the research activities of the Munich School of Engineering.

The mentioned research questions comprise improvements of components for electric vehicles, their integration into suitable vehicle architectures, the assessment of modern mobility needs and the integration of electric vehicles into electricity systems such as the public grid or a private household system.

## Coordinators and involved chairs

The Science Center for Electromobility is headed by three professors from different departments:



Prof. Dr. Hubert A. Gasteiger



Prof. Dr.-Ing.  
Hans-Georg Herzog



Prof. Dr.-Ing. Markus Lienkamp

## The Science Center for Electromobility connects 18 institutes based in six departments

Department of Architecture:

- Chair of Industrial Design

Faculty of Civil, Geo and Environmental Engineering

- Chair of Traffic Engineering and Control

Department of Chemistry:

- Chair of Technical Electrochemistry

Department of Electrical Engineering and Information Technology

- Institute for Electrical Power Plants and Power Electronics
- Institute for Electrical Energy Storage Technology
- Institute of Energy Conversion Technology
- Institute for Energy Management and Application Engineering
- Institute for Integrated Systems
- Institute for Real-Time Computer Systems

### Heads

Three coordinators from different departments allow an integral view

#### Prof. Dr. Hubert A. Gasteiger

Technical Electrochemistry,  
Lichtenbergstrasse 4,  
85748 Garching

#### Prof. Dr.-Ing. Hans-Georg Herzog

Energy Conversion Technology,  
Theresienstrasse 90,  
80333 München

#### Prof. Dr.-Ing. Markus Lienkamp

Automotive Technology,  
Boltzmannstr. 15, 85748 Garching

[www.wze.mse.tum.de](http://www.wze.mse.tum.de)

[wze@mse.tum.de](mailto:wze@mse.tum.de)

### Department of Informatics

- Chair of Software and Systems Engineering
- Chair for Application and Middleware Systems

### Department of Mechanical Engineering

- Institute of Aerodynamics and Fluid Mechanics
- Institute of Ergonomics
- Institute of Automotive Technology
- Institute for Machine Tools and Industrial Management
- Institute for Machine Elements
- Institute of Aircraft Design
- Chair of Thermodynamics



■ Figure 2: Structure of the Science Center for Electromobility

Close partnerships to industries guarantee efficient and up-to-date research

Furthermore, vital communication exists with companies from the automotive and electronic industry sector as well as with energy suppliers. Some of these companies, namely Allianz, Audi, BMW, Bosch, Daimler, E.ON, Infineon, MAN and Siemens are very close partners as they are members of the Industry Advisory Board of the Science Center for Electromobility. With these partners, research activities are coordinated in periodic colloquia and information on research progress and results are exchanged. In 2014, the colloquia was held in April for internal coordination. The next colloquia in cooperation with the industrial partners will be in May 2015.

## Research projects: results and achievements

### Visio.M

In the Visio.M collaborative project researchers at TU München, together with experts from industry have been exploring what an all-round, sporty, low-price and safe electric car might look like. The result of the undertaking, which has been funded by the German Federal Ministry of Education and Research for two and a half years to the tune of 7.1 million euro is a very small vehicle that sets new standards regarding efficiency and safety. The researchers unveiled their car to the public at the eCarTec from 21st to 23rd October 2014.

#### Speedy lightweight

The Visio.M has a driving range of around 160 kilometers and space for two people and luggage. With only 15 kilowatts of engine power, the car can achieve a top speed of 120 km/h (75 mph). Its design is sporty and self-confident. The features fulfill all significant requirements of a normal car, from infotainment and navigation assistance to climatization.

The electric motor draws its energy from a 13.5 kWh lithium-ion battery comprising consumer cells and is mounted behind the seats. The battery weighs almost 85 kg and can be charged from a 230 V socket in only three to four hours. The total cost of ownership, including initial investment and operating costs, will be lower than that of a comparable combustion engine car.

Decisive for the great energy efficiency of the Visio.M is its light weight. The passenger compartment is made of carbon fiber reinforced plastic with aluminum in the front and rear sections, as well as the roof frame. All windows are made of polycarbonate. This material weighs only half as much as glass but, thanks to a special coating, is equally resistant to scratches and weathering. The researchers also saved weight in chassis, steering and transmission by using special light-weight constructions. Without the battery, the Visio.M weighs only 450 kilograms.



■ Figure 3: Visio.M: lightweight, highly efficient and safe



### Safety first

An all-round, mass market car must guarantee effective passenger safety. Especially in collisions with heavier vehicles, small cars must provide a safety zone in spite of their small dimensions. The passenger compartment of the Visio.M consists of an innovative, multi-section monocoque made of carbon fiber reinforced plastic combined with ultra light sandwich materials imparting it with exceptional rigidity.

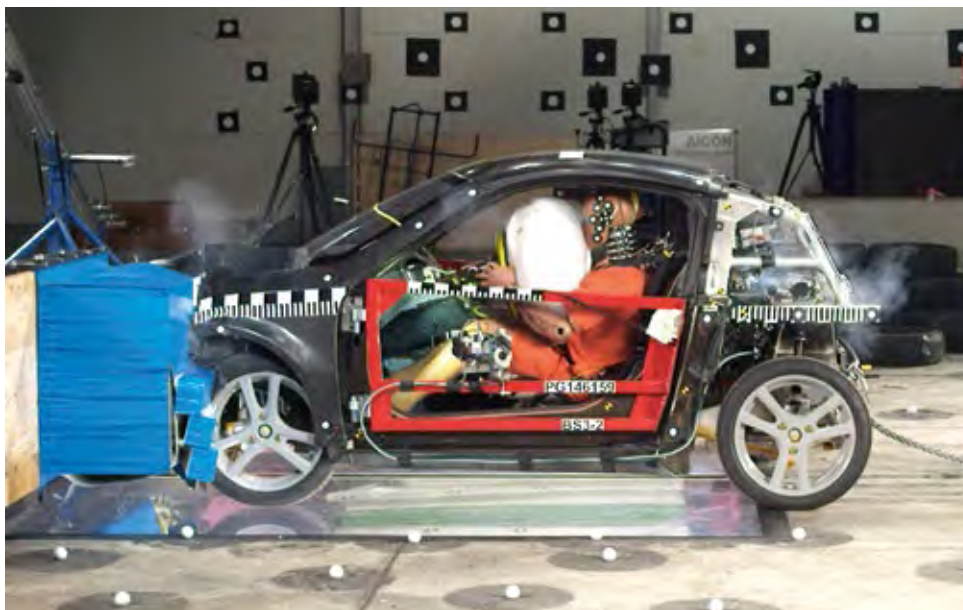

■ Figure 4 - Head-on collision with a deformable barrier (64 km/h, 40% off-set according to Euro-NCAP), 50 milliseconds after the beginning of the crash - Photo: IAV GmbH

In addition, the engineers have developed a safety concept that includes a systematic anticipatory analysis of the surrounding traffic. The 360° monitoring of the immediate vehicle vicinity via radar and camera sensors makes it possible to detect critical driving situations early on. This information is not used for driver assistance or warnings. When the car detects an imminent unavoidable collision it activates the integrated passenger protection systems just before the actual crash takes place.

Novel structural airbags are mounted in the bumpers and doors. Fractions of a second before a crash a gas generator fills these pressure tubes, which then act as additional absorption elements.

Adaptive seat-belt tensioners and force limiting systems reduce the forces acting on the passengers. A two-point belt combines with the normal safety belt holds the passengers firmly in their seats. When the system detects an imminent side collision, the passenger on the crash side is pulled toward the inside of the vehicle together with the seat just before the collision, thereby moving away from the immediate danger zone. The pre-acceleration of the passenger reduces the crash forces acting on the passenger and increases the effectivity of the side airbag. A potential collision between the driver and passenger is prevented by an interaction airbag mounted between the seats.

### **Ergonomic design**

In contrast to conventional cars in which the heel of the driver is defined as a fixed point for the adjustment functions, in the Visio.M the driver's eyes serve as a fixed point. This allowed the researchers to position the safety systems and the traffic perspective optimally. The driver's seat must only be adjusted vertically. In exchange the pedals are adjustable.

Control elements for the radio, air conditioning and navigation assistance are accessible via a central touch display, which is also adjustable. The human-machine interaction consists solely of swiping gestures that can be made on the entire display. The driver does not need to hit any buttons and a quick glance is sufficient for visual orientation.

At the core of the system is an open software architecture that can be extended at any time with additional elements. This opens the door to things like accessing home music collections via cloud applications or performing compute-intensive applications like energy-efficient route planning based on current weather and traffic conditions from a central server. All kinds of premium services can be implemented in this way. In the future, for example, a rental car might be delivered to a customer's door via remote control. This concept has already been implemented experimentally.

### **Large driving range**

Many aspects must be brought together before the vehicle can achieve a large driving range in spite of its relatively small battery. These include light weight, low aerodynamic drag, an efficient drive train, minimal rolling friction and energy-saving air conditioning.

The researchers have optimized these parameters in the context of the Visio.M project. Thus the 1.55 m wide and 1.31 m high two-seater now has excellent aerodynamics. In addition to low vehicle weight, the combination of low coefficient of drag of only 0.24, small frontal area of 1.69 square meters and tires optimized for low rolling resistance (115/70 R 16) further reduce the energy consumption.



■ Figure 5 - Visio.M: ergonomically and comfortable designed coupe

The active “torque vectoring” differential also contributes to overall efficiency: A small electric machine in the gearbox that can be operated as an electric motor or as an electric generator distributes the force optimally between the two back wheels. Because of the improved stability while braking in curves, significantly more energy can be recovered than without torque vectoring. At the same time the car becomes much more agile and safe, because of the optimal distribution of drive and braking forces.

### Energy-saving air conditioning

Special attention was paid in the Visio.M to the design of the air-conditioning and heating systems. Wherever warmth is generated, it is recovered for heating the car when required. So-called Peltier elements are integrated into both the cooling aggregate and seats. These electrothermal converters can heat as well as cool. This allows environmentally friendly operation without the use of coolant fluids.

During very cold weather an ethanol-based heater can be switched on for driving range independent heating. The aggregate with a thermal performance of approx. 4.5 kW is especially useful for deicing the windscreen. An intelligent controller finds the optimal solution for energy efficient and comfortable operation of the air-conditioning system.

Participants in the Visio.M consortium are, in addition to the automotive companies BMW AG (lead manager) and Daimler AG, the Technische Universität München as a scientific partner, and Autoliv BV & Co. KG, the Federal Highway Research Institute (BAST), Continental Automotive GmbH, Finpower GmbH, Hyve AG, IAV GmbH, InnoZ GmbH, Intermap Technologies GmbH, LION Smart GmbH, Amtek Tekfor Holding GmbH, Siemens AG, Texas Instruments Germany GmbH and TÜV SÜD AG as industrial partners. The project is funded under the priority program „Key Technologies for Electric Mobility - STROM“ of the Federal Ministry for Education and Research (BMBF).

## TUM CREATE: EVA

“Electromobility for tropical Megacities” in Singapore

In 2011, the cooperation between TUM and the Nanyang Technological University (NTU) in Singapore started under the name “TUM CREATE”. This research program is part of the CREATE Campus (Campus for Research Excellence and Technological Enterprise) and is funded by Singapore’s National Research Foundation (NRF). Beside top-class universities such as the Massachusetts Institute of Technology, the University of California, Berkeley, Cambridge University, and the ETH Zurich, TUM was selected as another top-class research partner.



■ Figure 6: Alain Prost on the JEC ASIA 2014 in EVA

The vision and mission of all research projects within TUM CREATE is titled “Electromobility for tropical Megacities” and addresses various relevant aspects on different levels of electromobility: the slogan “from the molecule to the megacity” represents the versatile



■ Figure 7: EVA during driving test at the TUM CREATE campus

challenges ranging from fundamental research on future battery chemistries, over approaches regarding urban planning and energy optimization, to the applied sciences which aim for solving the specific technological challenges involved with electric vehicles.

The structure of this programme does not only resemble that of TUM's Science Center for Electromobility. The existing network within the cluster significantly facilitated the acquisition of this project.

EVA, an electric vehicle concept especially developed for being used as a taxi in Singapore and considers all requirements of tropical megacities. The prototype was completed in 2013 and presented on the Tokyo Motor Show which was a big success.

After the show, further improvements on the battery pack, glazing and software were conducted. The first driving tests showed a stable and dynamic driving behavior, which will be continued to have a driving vehicle with all intended functions running for the official driving event in beginning of 2015.

Beside these developments, EVA won the eCarTec Award in the category "Product Concept / Vision". The eCarTec is the world's biggest B2B trade fair for electric & hybrid mobility. The EVA concept convinced the jury in a field of 70 competitors.



■ Figure 8: Award ceremony on the eCarTec 2015

Research on synergies between household and electric vehicle

Another highlight of 2014 was the participation at the JEC ASIA in Singapore. The JEC is the largest composites industry organization in the world with a network of 250.000 professionals. The Exhibition in Singapore promoted EVA and VOI (multipurpose scooter by TUM CREATE) and presented the carbon fiber structure of EVA to interested people and journalists. Four time formula one champion Alain Prost was a special guest to the TUM CREATE booth and enjoyed a tour about EVA.

Currently, the team around EVA explores the possibilities to further develop EVA for a potential mass production. Therefore, the team applied for the MIT Innovation Grant which will help to investigate market strategies and potential solutions for a series production.

TUM CREATE looks forward to the beginning of its second phase. A proposal will soon clarify targets and milestones for the next years.

### **Sun2Car@GAP**

Virtual fleet test delivers reliable data at a minimum cost

This research project is part of the activities in the pilot municipality (German: Modellkommune) for electromobility in Garmisch-Partenkirchen. The Institute of Automotive Technology (Faculty of Mechanical Engineering) and the Chair of Traffic Engineering and Control (Faculty of Civil, Geo and Environmental Engineering) address the overall system which comprises an electric vehicle and the electric system of a single family house which uses photovoltaic (PV) panels to produce electricity. This project aims at using synergies which arise from coupling the vehicle and the building and seeks to enable CO<sub>2</sub> neutral driving or maybe even a negligible CO<sub>2</sub> impact of the overall system. For this, the battery of the vehicle is a key element that can be used as storage whenever the PV system generates electricity.

The project was launched in 2013 and is scheduled for a period of two years. In a first step, the occurring emissions, both from driving and from the building are monitored and reduction potentials are analyzed. In order to record the driving and to estimate the related emissions, 50 test persons who are living in 20 households are equipped with a smart phone which tracks and records their mobility behavior. Later, the test persons receive suggestions of how to reduce their CO<sub>2</sub> emissions in the future and their willingness for behavioral adaptations is analyzed.

The project was made possible through the cooperation of both research disciplines: whereas the Institute of Automotive Technology is responsible for the modeling of the vehicle technologies and the prediction of the related emissions, the Chair of Traffic Engineering and Control has a sound experience in using empirical methods. Hence, linking both disciplines is a very fruitful combination that widens the possible scope of research.

Partners in this project are the Audi AG and the Forschungsstelle für Energiewirtschaft.

## Virtual Electromobility for Taxi and Trade Transportation in Munich

In another interesting research project electric vehicles and their properties are simulated on a smartphone which is installed in a conventional vehicle. The sensors of the smart phone record speed and acceleration, and the electricity consumption of a virtual electric vehicle is simulated. With this approach the usability of the simulated vehicle can be tested. The goal of the project is to develop electric vehicle concepts which are suitable for a taxi and for the trade transportation. Furthermore, the location of charging stations and charging technologies are tested and their influence on the infrastructure is assessed.

By using only a few real electric vehicles, the model and the simulation results can be evaluated and validated. As a large number of applications and test persons can be analyzed without requiring a high number of electric vehicles, the analysis becomes significantly cheaper than usual fleet tests with a large number of real electric vehicles.

Main results of this project are estimations regarding technical, ecological and economic aspects of electric vehicles in taxi and trade fleets.

External partners in this project are the Stadtwerke München, the Taxiverband München and the Handwerkskammer für München und Oberbayern. The project was launched in late 2012 and a great amount of data could already be collected throughout 2014.

## Publications, Awards and Patents

By a survey among the partners of the Science Center for Electromobility reliable figures regarding its activities and achievements could be collected. The results are given in Table 1.

Received delegations	16
Sent delegations	2
Publications and awards	39
Patents	10

■ Table 1 - Statistics about the activities of the Science Center for Electromobility in 2014

## **External Project Partners**

As indicated within the earlier descriptions of the projects of the Science Center for Electromobility, there are numerous industrial project partners. These do not only comprise vehicle manufacturers and their suppliers but also various other companies such as electronic and semiconductor manufacturers and large energy suppliers. Besides, companies dealing with the overall picture of mobility, its analysis and prediction are important partners. Obviously, other research institutions working on the subject of electromobility are also suitable partners for high quality research.

### **Selected publications:**

G. Walder, C. Campestrini, M. Lienkamp, and A. Jossen, "Functionality and behaviour of a dual Kalman Filter implemented on a modular battery-management-system," Conference on Future Automotive Technology: Focus Electromobility, March, 2013.

P. Keil, K. Rumpf, and A. Jossen, "Thermal Impedance Spectroscopy for Li-Ion Batteries with an IR Temperature System", The 27th International Electric Vehicle Symposium & Exhibition, Barcelona, November, 2013.

T. Hierlinger, C. Netzker, J. Unger, M. Lienkamp, „Aktive seitliche Insassen-verschiebung im Seitenaufprall“, VDI Tagung Fahrzeugsicherheit, November 2013.

B. Schonlau, K. Krumbiegel, L. Quedenbaum, A. Serka, „Auslegung eines integralen Sicherheitskonzepts für das Elektro-kleinstfahrzeug Visio.M“, VDI Tagung Fahrzeugsicherheit, November 2013.

K. Reisen, J. Greitemann, G. Reinhart, „Technologie-Screening am Beispiel der Elektromobilität“, WT-online, 2014.

C. Netzker, R. Lang, L. Quedenbaum, B. Schonlau, T. Hierlinger, „Elektrokleinstfahrzeuge - Eine Herausforderung für die Fahrzeugsicherheit“, ATZ extra, May, 2013.

# Research Centers: Center for Sustainable Building





# Center for Sustainable Building (ZNB)

## Center for Sustainable Building

Arcisstr. 21  
80333 Munich

[www.znb.mse.tum.de](http://www.znb.mse.tum.de)

### Heads

**Prof. Dipl.-Ing. Thomas Auer**  
Building Climatology and Building Services,  
Department of Architecture

**Prof. Dr. Thomas Hamacher**  
Renewable and Sustainable Energy Systems,  
Department of Electrical and Computer Engineering

**Prof. Dr.-Ing. Werner Lang**  
Energy Efficient Design and Building,  
Department of Civil, Geo and Environmental Engineering

**Prof. Dr.-Ing. Klaus Sedlbauer**  
Building Physics,  
Department of Civil, Geo and Environmental Engineering



■ from left to right: Dr.-Ing. Nemeth, Dipl.-Ing. Heißler, Prof. Dipl.-Ing. Auer, Dipl.-Ing. Stopper, Prof. Dr.-Ing. Sedlbauer, Prof. Dr.-Ing. Lang, Prof. Dr. Hamacher, Dipl.-Math. Lindauer

### Team

Dipl.-Ing. Jochen Stopper  
[stopper@tum.de](mailto:stopper@tum.de)

Dr.-Ing. Isabell Nemeth  
[inemeth@tum.de](mailto:inemeth@tum.de)

Dipl.-Math. Manuel Lindauer  
[manuel.lindauer@tum.de](mailto:manuel.lindauer@tum.de)

Dipl.-Ing. Karl Martin Heißler  
[martin.heissler@tum.de](mailto:martin.heissler@tum.de)

Dipl.-Ing. Michael Huit  
[michael.huit@tum.de](mailto:michael.huit@tum.de)

Haythem Chelly, M.Sc.  
[haythem.chelly@tum.de](mailto:haythem.chelly@tum.de)

Shan Hua, M.Sc.  
[shan.hua@tum.de](mailto:shan.hua@tum.de)

Dipl.-Ing. Benjamin Reuter  
[benjamin.reuter@tum.de](mailto:benjamin.reuter@tum.de)

Laura Franke, M.Sc.  
[laura.franke@tum.de](mailto:laura.franke@tum.de)

Sebastian Botzler, M.Sc.  
[botzler@tum.de](mailto:botzler@tum.de)

**Institute of Building Physics**



Prof. Dr.-Ing.  
Klaus Peter Sedlbauer

**Institute of Energy Efficient  
and Sustainable Design  
and Building**



Prof. Dr.-Ing.  
Werner Lang

**Center for Sustainable Building**

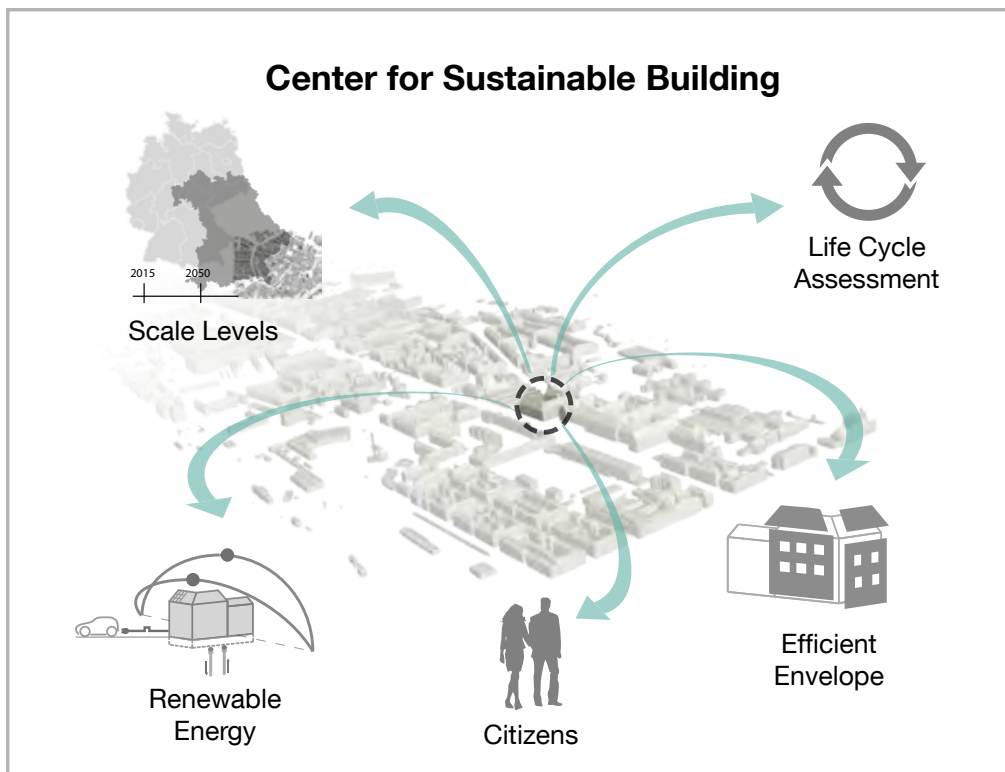

**Institute of Energy Economy  
and Application Technology**



Prof. Dr.rer.nat.  
Thomas Hamacher

Prof. Dr.-Ing.  
Ulrich Wagner

**Institute of Building  
Technology and Climate  
Responsive Design**



Prof. Dipl.-Ing.  
Thomas Auer

## **Presentation of Focus Areas**

**At the Centre for Sustainable Building (ZNB), research questions are addressed by an interdisciplinary team of engineers, architects, scientists and mathematicians. Knowledge transfer and collaboration happen between the different disciplines involved in the ZNB along with other chairs at the TUM and with international partners. The latter include, as part of the EuroTech, DTU Copenhagen, TU Eindhoven, EPF Lausanne and 21 other European universities, working together in the framework of the European COST Action Programme „Smart Energy Regions“.**

**Guided by the premise “Modelling the Future”, the ZNB develops future technology systems and building envelopes at the level of individual buildings. The investigations take into account the entire life cycle.**

## **Development of Sustainable, Future-Oriented Cities**

The research and design of sustainable, more livable and future-oriented cities is a major focus within the ZNB. In order to provide substantive contributions to the transformation to low-carbon and energy-efficient structures, the ZNB is working on multiple scales, from the building façade up to groups of millions of buildings. The examinations are not only taking into account technical, but also economical and sociological issues to develop applicable concepts. The necessity of low-carbon and energy-efficient structures offers an extensive transformation potential that can effectively contribute to the design of urban space.

People-focused concepts for future cities are designed by an interdisciplinary collaboration. The concepts are linked to the current stock situation, identifying possible targets and their implementation [1]. Energy demand and supply considerations are combined in order to recommend a coordinated development strategy for energy efficiency.

## **Scenario Studies on Energy Savings in Construction**

Local climate and energy use expand the typical architectural and engineering questions. In order to optimize the energy demand, refurbishment strategies of a building's thermal envelope are individually investigated and developed, using the ZNB's multi-scalar energy model [2]. Concerning the energy supply of a building, the strategies pursue to use renewable energy on-site. The examined scenarios take into account not only the energy, but also the cost of building refurbishments to develop applicable concepts. In addition to the technical and economic studies, sociological issues are integrated. The motivation of the diverse users and owners is investigated, in order to foster better understanding and increase the refurbishment rate in Germany.

## **Integration of Electro Mobility in the Building**

Mobility plays an important role in sustainable urban and building design. In this context, the ZNB investigates together with other research institutions and industry partners the optimization of energy utilization by connecting electric vehicles to buildings. Intelligent communication between the energy management system of a building and its vehicle(s)

can increase the utilization of on-site generated renewable electricity. For the investigation, the potential of Load and Demand Side Management is simulated and validated in a real building.

## Building and Façade

For energy generation on-site, the building envelope plays a crucial role. In addition to the roof, the façade of sustainable buildings can be used to generate energy. However, the façade still acts as the interface between natural exterior and artificial interior space, providing high level comfort and at the same time minimizing the energy consumption of the building. At the ZNB new façades are investigated and developed in cooperation with other European research institutions and industry partners [3]. Besides the investigation of the façade technology, the energy saving potential of the new building types in the urban context is analyzed, e.g. for local heating and cooling networks or seasonal storage. The investigations by the ZNB from façade up to city scale are not only conducted for the operational phase, but over the entire life cycle to ensure holistic optimization scenarios.

## Interdisciplinary Project and Laboratory

### The ZNB pursues the interdisciplinary approach via two projects:

In the Interdisciplinary Project (IDP) students gain an insight into the research of the ZNB. On the basis of an actual project (e.g. urban quarter development), the interdisciplinary groups develop a feasibility study. In this way, they see the process of learning and research as an open and continuous path and learn to critically question new findings [4].

The Life Cycle and Sustainability Laboratory (lab) has similar functions: knowledge transfer between different disciplines, learning platform for students, and orientation in scientific fields.

The lab conveys the general concept of life cycle thinking and creates a network of researchers from various faculties within TUM. Working on different subjects, the researchers use similar methods and profit from each other's approaches via the lab.

### Selected Publications

- [1] I. Nemeth, J. Schinabeck, W. Lang, J. Stopper et al., "Urban Laboratory Nuremberg West – an interdisciplinary research project of the TU Munich in collaboration with the City of Nuremberg", together with the TU Institutions Sustainable Architecture, Urban Development, Urban Structure and Transport Planning, Landscape Architecture and Public Space, Energy Economy and Application Technology, Munich, 2013.
- [2] I. Nemeth, M. Lindauer, "Adaptation of a stochastic simulation model for long-term investigation of the development of the energy demand in larger building stocks", Proceedings of the International Workshop: Intelligent Computing in Engineering 2012, TU Munich, 2012.
- [3] J. Stopper, V. Ritter, D. Gstoehl, "Verschattung und Raumtemperierung mit flüssigkeitsdurchströmten Glasfassaden", Detail Green, Institut für Internationale Architektur Dokumentation GmbH, Munich, 2014.
- [4] P. Geyer, J. Stopper, W. Lang, M. Thumfart, "A Systems Engineering Methodology for Designing and Planning the Built Environment – Results from the Urban Research Laboratory Nuremberg and their Integration in Education", Systems, Multidisciplinary Digital Publishing Institute, Basel, 2014.

## “e-MOBILie“

### Energy Self-Sufficient Electro Mobility in the Smart-Micro-Grid

**Project Manager**

Dipl.-Math. Manuel Lindauer  
[manuel.lindauer@tum.de](mailto:manuel.lindauer@tum.de)

Dipl.-Ing. Michael Huit  
[michael.huith@tum.de](mailto:michael.huith@tum.de)

**Project Partners**

**BMW AG**  
(project lead)

**SMA Solar Technology AG**  
Institute for Energy Economy  
and Application Technology,  
TUM

In the future, electro mobility will become more important for the whole energy system in Germany. The project “e-MOBILie” investigates the possibilities to create an integrated energy management system, which connects buildings with electro mobility and optimizes the energy utilization. The energy management system will be evaluated in a real building in 2015.

The project follows the integrative approach to combine energy transition and e-mobility for the user by optimally linking local regenerative energy generation and e-mobility. The target is to develop a decentralized “energy management system” (EMS) which controls the energy flow within an intelligent building. The EMS guarantees the best comfort for the user and additionally includes an electric vehicle (EV) in its energy management. The approach of this decentralized EMS is that devices of different manufacturers exchange information and interact in an energy market within a single building in order to achieve optimal utilization of energy. The research project already determined which information should be exchanged.

For the ZNB the main focus of the project is the application of the EMS in a single-family-home. For this investigation, an Energy-Storage-Plus building, provided by Dynahaus, generates more energy than used for heating and household applications. The building provides electrical and thermal storage systems and can therefore act as a service provider for the grid.



■ Dynahaus building finished in December 2014.

In 2014, this building was constructed in Hallbergmoos, Munich, and equipped with a heat pump, an air ventilation system, a photo voltaic plant, an electrical vehicle, measurement devices, and the energy management system connecting all devices. The potential of the energy management system is investigated using a simulation environment.



■ Heating system in the plant room of the Dynahaus consisting (from left to right) of the ventilation system, the air to water heat pump and the heat distribution system for the floor heating.

Early in 2015, the demonstration phase of the project will start. A family moved into the building at the end of December 2014. The inhabitants use all the systems included in the building, especially the energy management components and give feedback regarding the usability. In parallel, the measurement devices log the data regarding the energy demand and thermal behavior. This data will be used to validate the results of the simulations and to optimize the system.



■ Components of the energy management system consisting of SMA Homemanager, SMA Remote Control, Stiebel Eltron ISG Plus and SMA battery fuse.

## Fluidglass

### Team:

Dipl.-Ing. Jochen Stopper  
[stopper@tum.de](mailto:stopper@tum.de)  
(Project Manager)

Shan Hua, M.Sc.  
[shan.hua@tum.de](mailto:shan.hua@tum.de)

Dipl.-Ing. Karl Martin Heißler  
[martin.heissler@tum.de](mailto:martin.heissler@tum.de)

### Project Partners

University of Liechtenstein,  
Vaduz, Liechtenstein

University of Stuttgart,  
Institute for Lightweight  
Structures and Conceptual Design  
(LEK), Germany

Interstate University of Applied  
Sciences and Technology Buchs  
(NTB), Switzerland

Commissariat à l'énergie ato-  
mique et aux énergies  
alternatives (CEA-INES), France

Mayer Glastechnik GmbH,  
Austria

GlassX AG, Switzerland

Hoval Aktiengesellschaft,  
Liechtenstein

CNE Research and Innovation  
Center LTD (CyRIC), Cyprus

ALCOA Europe Commercial  
SAS (KAWNEER Innovation  
Centre), France

AMIRES s.r.o., Czech Republic

The FLUIDGLASS project is developing a new and innovative concept for multi-functional solar thermal glass façade systems. The Fluidglass approach turns passive glass façades into active transparent solar collectors which simultaneously are controlling the energy flow through the building envelope and providing the user with excellent comfort. It is perfectly suited for both, retrofitting of existing building stock and construction of new buildings for all climate zones.

Fluidglass unites four key functions in one integrated system:

- transparent solar thermal collector
- transparent insulation layer
- overheating protection system
- heating and cooling device

The thermal energy absorbed can be transferred to other parts of the building or, at district level, used within an energy network or collected in a seasonal storage system. Fluidglass increases the thermal performance of the whole building resulting in energy savings. At the same time, the glass system improves the comfort for the user significantly [1].

The basic concept of Fluidglass is the integration of liquids and insulating glass within the transparent façade. The liquids are used for controlling the energy flows between the natural environment and the artificial interior space. The selected design consists of two liquid layers which are thermally separated. The liquid layer that is oriented to the exterior is used as a shading element and as a solar collector. The inner layer serves also as a shading device and / or as a heating or cooling surface, depending on whether the circulating liquid is hot or cold [2]. To reduce the solar transmission the liquids can be colored in order to increase the absorption. For the heat transfer, the glass façade is connected to a liquid circuit which is in turn connected to the building service system via heat exchanger.

The ZNB is simulating buildings with Fluidglass facades with a Fluidglass model developed in-house, implemented in the building library in Modelica, named IBPS-Building-Package. The IBPS-Building-Package was developed at the ZNB in collaboration with students of the seminar "Building Performance Modeling and Simulation". Furthermore, the ZNB undertakes a life cycle assessment of the Fluidglass, accompanying the project. The results are considered directly in the development process of the product to optimize the performance over the whole life cycle.

The ZNB has been working within the EU research project FLUIDGLASS with several European partners since September 2013 [1]. The project is scheduled for four years.

The ZNB's focus in this project is on simulations in different scales and Life Cycle Analyses (LCA). A simulation model of the fluid glass was created and will be improved within the EU-project in cooperation with the University of Liechtenstein and the Interstate University of Applied Sciences and Technology Buchs (NTB). Simulations of buildings and district energy networks in different cities will be carried out.

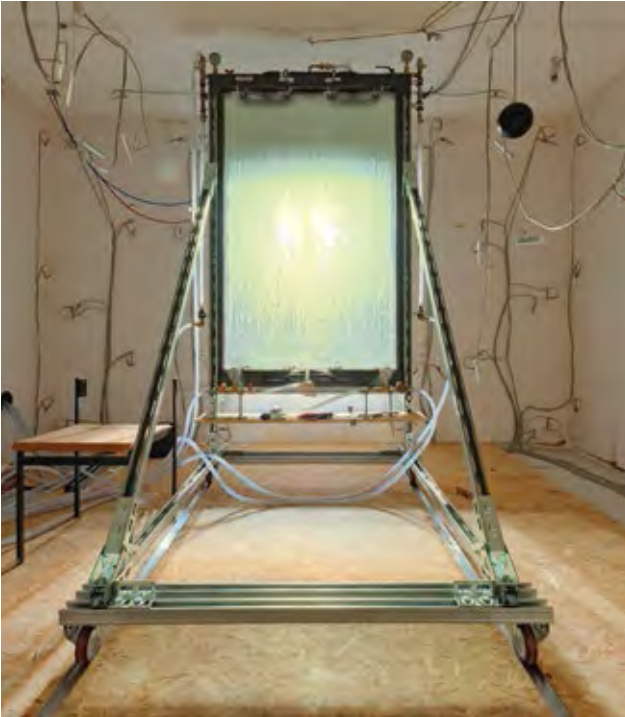

■ FLUIDGLASS prototype (Dyed) at test facilities

**The project is divided into eight work packages:**

- **WP 1: Requirements and specifications**  
Defined set of functionalities for the individual components and the whole system
- **WP 2/3: Collector and façade development**  
Simulation, design and manufacturing of the components
- **WP 4: System integration**  
Collector and façade components integrated and robustly connected to building automation
- **WP 5: Testing of components and assembly**  
System ready for demonstration
- **WP 6: Validation under real life conditions**  
Proof of applicability
- **WP 7: Public awareness and exploitation**  
For the entire project duration
- **WP 8: Management and coordination of the consortium**  
For the entire project duration

[1] EU research project „FLUIDGLASS“, financed by the European Commission under the seventh framework program, Grant Agreement No. 608509 ([www.fluidglass.eu](http://www.fluidglass.eu)).

[2] J. Stopper, D. Gstoehl, V. Ritter, “Fluidglas – Verschattung und Raumtemperierung mit flüssigkeitsdurchströmten Glasfassaden“, Detail Green, Munich, 2014.



## Life Cycle and Sustainability Lab

Project Manager

Dr.-Ing. Isabell Nemeth

[inemeth@tum.de](mailto:inemeth@tum.de)

Dipl.-Ing. Patricia Schneider

[schneider@tum.de](mailto:schneider@tum.de)

Dipl.-Ing. Jochen Stopper

[stopper@tum.de](mailto:stopper@tum.de)

Dipl.-Ing. Benjamin Reuter

[benjamin.reuter@tum.de](mailto:benjamin.reuter@tum.de)

The depletion of resources and the desire to maintain possibilities of development for future generations stipulate a conscious approach regarding emissions and the consumption of materials and energy. This poses serious challenges to building planners and product designers, since not only the operation of buildings and products, but also their manufacturing (construction), recycling or disposal can have significant influence on the total environmental balance.

Tackling this complex task requires a high degree of cross-linked thinking and interdisciplinary knowledge in various subject areas. This is why the life cycle and sustainability lab was created under the umbrella of the MSE.

The creation of the life cycle and sustainability lab has a twofold effect. On one hand, it creates a learning platform for students and provides orientation in this complex field. It also conveys the general concept of life cycle thinking. On the other hand, within the lab, a network of researchers from various faculties within TUM is created who are working on different research subjects but using similar methods.

The teaching section of the lab represents the variety of research topics at TUM. Several examples from different fields are used to illustrate the consequences which arise from decisions during planning and development, e.g. the energy demand of a building or the recycling of a vehicle. Besides these multi-disciplinary examples, knowledge on life cycle analyses, sustainability, energy simulation and calculation is provided and suitable calculation software, databases and other tools are introduced. This enables students from different disciplines and with different levels of knowledge to have an easy access to this topic. The lab is designed as an interactive learning, practicing and information environment and students play a key role for updating, extending and maintaining the platform content. TUM researchers give guidance and support the students, for example within student research projects or Bachelor's and Master's Theses.



■ Structure of the online platform life cycle and sustainability lab.

Within the related network, TUM researchers are able to discuss methodological concepts and new ideas. They can exchange experiences with tools and databases and increase the efficiency of their research. The cross-faculty atmosphere extends their scope and improves the understanding for problems in this inter-disciplinary field of research. In biannual meetings, latest research results can be shared and further research ideas can be initiated.

Further goals of the network are the coordination of the teaching portfolio at TUM in order to provide a wide variety of teaching offers to a large, inter-disciplinary group of students. Another aim is to create a knowledge center for the subject of life cycle and sustainability and to form cross-faculty research co-operations in the future.

**The implementation of the life cycle and sustainability lab is planned in various steps:**

- |  |                                |
|--|--------------------------------|
| <p><b>1. Conception</b><br/>The design, the layout, and the didactic concept of the platform are developed</p>   | <p>Until January 2015</p>      |
| <p><b>2. Creation of platform backbone</b><br/>Necessary technological preparations are implemented</p>  | <p>Until March 2015</p>        |
| <p><b>3. Kick-Off meeting for TUM researchers</b><br/>The concept of the lab and the related network are presented and next steps are coordinated</p>                      | <p>March 2015</p>              |
| <p><b>4. Initial content generation</b><br/>In the course of supervised student research projects, high priority content is generated and integrated into the platform</p> | <p>During Summer Term 2015</p> |
| <p><b>5. Launch of the platform</b><br/>Students and researchers can access the balance laboratory</p>   | <p>October 2015</p>            |
| <p><b>6. Periodic content extensions and updates</b><br/>New content will be generated and old content will be updated based on further student projects</p>               | <p>Future</p>                  |

Project Manager

Dr.-Ing. Isabell Nemeth

[inemeth@tum.de](mailto:inemeth@tum.de)

Dipl.-Ing. Jochen Stopper

[stopper@tum.de](mailto:stopper@tum.de)

## Research-Oriented Teaching: Interdisciplinary Project

**Following the approach of research-oriented teaching the ZNB holds once a year an interdisciplinary project for students of the Master's Program ENB. On the basis of the project work, students will gain an insight into the research of the ZNB. They learn to critically question new findings and experience the process of learning and research as an open and continuous path.**

The actual project for 48 students of the summer semester 2014 was the urban quarter development of a former military base in Bogenhausen, Munich. In interdisciplinary groups of architects, civil, environmental, and MEP engineers, they developed a feasibility study for an exemplary ecological settlement with a positive overall energy balance on the urban quarter level. Through optimal combination of sources and sinks the urban quarter functions independently of pipeline-supplied energy or fossil fuels for heat supply (e.g. district heating, oil or gas). In a simulation with an hourly resolution concepts are tested in order to show that energy supply and demand are balanced.

As customary in scientific research, the task requires literature research, evaluation in critical discussions, and scientific methods. The acquired knowledge is used to develop inventive solutions. Since the sustainability concept for buildings is closely interlinked with technological issues, the students have to resolve a complex research question which can only be addressed by collaboration between the approaches of different disciplines. At the same time, this offers a variety of insights into related and neighboring topics to the students.

The development of the feasibility study 2014 took place in two steps:

### 1. Building Level

Based on the winning urban design each group had to develop one building type of the area. This encompasses the design of the architecture, of the building construction, of a building physics and energy concept for the individual building, the energy needs assessment, the environmental assessment, and the monetary valuation of the investment process.

Particular emphasis was placed on the comparison of different construction variants and energy standards, in order to compare and assess the effects of design and material choice throughout the entire life cycle of the building.

## 2. District Level

After research, analysis and selection of the components of the energy supply concept, various topics were processed in different groups. These were among others:

- calculation of the district heating requirements
- power demand of the quarter
- development of load profiles of electricity and heat demand
- hourly presentation of the energy supply
- storage and distribution concept
- estimation of load management potential
- legal concepts for district-wide energy direct marketing
- special-purpose solutions for utilizing excess energy
- compilation of all results in an overall concept



■ **Master plan Prinz-Eugen-Park;** GSP Architects and Rainer Schmidt Landscape Architects, Munich

Particular relevance was given to the project through the participating Department of Urban Planning of the City of Munich. Due to the impending development of the quarter, the department had a special interest in the ideas of the students. Its employees strongly supported the project work by giving a variety of information and participating in presentation dates.





# Outreach

# MSE Colloquium 2014

## “Energy in motion”

### Annual presentation of current energy-related research at TUM

The MSE Colloquium is the annual meeting of MSE scientists to present their results of energy research. It offers a unique opportunity to learn about the diversity of energy research at TUM. Most of the presentations are delivered by young scientists doing their doctorate. The MSE Colloquium provides an excellent platform to network with colleagues and has become an annual highlight for young scientists as well as senior scientists.

On July 3<sup>rd</sup> 2014 the 4<sup>th</sup> MSE Colloquium “Energy in Motion” took place. 180 participants from TUM as well as from other universities and industry attended the presentations of our young researchers. Lively and fruitful discussions took place at the 48 posters. Key note speeches were given by Dr. Tobias Brunner (BMW Group) on Hydrogen Fuel Cells and by Dr. Alexander Hexemer (Lawrence Berkeley National Laboratory) on Energy Research at a Synchrotron. The three best presentations and posters were selected by a jury of MSE scientists. The best presentation and the best poster received a price, donated by the energy supplier Lechwerke AG.

#### Presentation Award Winners

- **Christoph Schaffer**, Dipl.-Phys.  
Institute for Functional Materials/PH  
*“Watching a Solar Cell Die – Structural Degradation in Polymer Solar Cells”*
- **Julien Durst**, PhD  
Chair of Technical Electrochemistry/CH  
*“Hydrogen Oxidation Reaction in Alkaline Electrolytes on Pt/C Electrocatalysts: Mechanic Aspects and Application in Fuel Cell Devices”*
- **Andreas Veit**, M. Sc.  
Chair for Application and Middleware Systems/IN  
*“Unified Device-Level Modeling Framework for Demand Scheduling”*

#### Poster Award Winners

- **Felix Örley**, Dipl.-Ing.  
Institute of Aerodynamics and Fluid Mechanics  
*“Cavitation Phenomena in Diesel Injection Systems”*
- **Christoph Mayr**, B.Sc.  
Institute for Functional Materials/PH  
*“Hybrid solar cells based on aqueous processed titania nanoparticles”*
- **Stephan Pröller**, M.Sc.  
Herzig Group/MSE  
*“Printing Active Layers for Application in Organic Solar Cells”*

#### Topics of previous colloquia

- 1<sup>st</sup> MSE Colloquium “Sustainable Energy Supply of the Future” (18.7.2011)
- 2<sup>nd</sup> MSE Colloquium “Energy Challenges – Germany 2050” (28.6.2012)
- 3<sup>rd</sup> MSE Colloquium “Research towards innovative energy systems and materials” (4.7.2013)



# “Energy in Motion”

03.07.2014 – 8.30 am to 9.00 pm

8.30 - 9.00 am  
**Registration**

9.00 - 9.15 am  
**Opening**

Hans Pongratz, TUM Senior Vice President  
Thomas Hamacher, Director Munich School of Engineering

9.15 - 9.45 am

**Keynote: Hydrogen Fuel Cell – Future-Oriented Technology for Long-Distance Electromobility**

Tobias Brunner, BMW Group

9.45 - 11.00 am

**Session Chair: Markus Lienkamp, WZE MSE**

**Incentives for Energy-Efficient Behavior of Professional Drivers – An Empirical Investigation Using a Natural Field Experiment**

Dominik Schall, Chair of Corporate Management, School of Management

**e-MOBILie – From Concept Development to HiL Test Bench**

Christian Kandler, Chair of Energy Economics and Application Technology

**Bringing Limited Energy Resources to Market**

Christoph Goebel, Chair for Application and Middleware Systems

11.00 - 11.45 am

**Poster Presentation, Coffee Break**

11.45 - 1.00 pm

**Session Chair: Werner Lang, ZNB MSE**

**Integrating Requirement Analysis and Multi-Objective Optimization for Office Building Energy Retrofit Strategies**

Yunming Shao, Institute for Energy Efficient Building and Design

**Unified Device-Level Modeling Framework for Demand Scheduling**

Andreas Veit, Chair for Application and Middleware Systems

**Analysis of Potential Biomimetic Applications of Skin Analogies on the Building Shell**

Leopoldo Saavedra, Institute for Energy Efficient Building and Design

1.00 - 2.30 pm

**Poster Presentation, Lunch Break**

2.30 - 3.45 pm

**Session Chair: Peter Müller-Buschbaum, NRG MSE**

**Watching a Solar Cell Die – Structural Degradation in Polymer Solar Cells**

Christoph Schaffer, Chair E13 for Experimental Physics

**Hydrogen Oxidation Reaction in Alkaline Electrolytes on Pt/C Electrocatalysts: Mechanistic Aspects and Application in Fuel Cell Devices**

Julien Durst, Chair of Technical Electrochemistry

**Improved Knowledge of Wind Conditions for Wind Turbine and Wind Farm Control**

Stefano Cacciola, Wind Energy Institute

3.45 - 4.30 pm

**Poster Presentation, Coffee Break**

4.30 - 5.45 pm

**Session Chair: Hartmut Spliethoff, CPG MSE**

**Chemical Storage of Excess Electricity - Interdisciplinary Collaboration at TUM**

Sebastian Fendt, Institute for Energy Systems

**Analysis of a Sailwing Concept for Wind Turbine**

Julie Piquee, Institute of Aerodynamics and Fluid Mechanics

**Combined Heat and Power – Utilization of Geothermal Heat in ORC Processes**

Dominik Meinel, Institute for Energy Systems

5.45 - 6.15 pm

**Keynote: Coming Full Circle: Energy Research at a Synchrotron and Beyond**

Alexander Hexemer, Lawrence Berkeley National Laboratory

6.15 - 6.30 pm

**Summary of the Day**

6.30 - 9.00 pm

**Poster and Presentation Award, Colloquium Dinner**

**Location:**

**TUM – Institute for Advanced Study, Garching**

**Registration:**

<http://www.mse.tum.de>



# TUM Applied Technology Forum

The TUM Applied Technology Forum is one module of TUM's institutional strategy within the Excellence Initiative. To stay competitive in the field of engineering research, competences must be bundled. Therefore the TUM Applied Technology Forum offers a new form of research cooperation with five universities of applied sciences within the Munich metropolitan area: Deggendorf Institute of Technology (DIT), Technische Hochschule Ingolstadt (THI), Munich University of Applied Sciences (MUAS), Weihenstephan-Triesdorf University of Applied Sciences (HSWT) and Rosenheim University of Applied Sciences (HSRO). MSE has developed the program to foster outstanding young research talent from universities of applied sciences in the field of energy research. Research Tandems consisting of professors from TUM and one university of applied sciences team up and work on a collaborative project, offering promising graduates from universities of applied sciences the possibility to earn a doctorate at TUM. To date, there have been three calls for proposals (ATF1 to ATF3) and 16 promising projects have been chosen. The results were presented and discussed at the annual TUM Applied Technology Forum Symposium. The 2014 Symposium took place at the Munich University of Applied Sciences in April 2014.

## Current Projects:

- **Biomassepellets aus Pferdemit**  
Prof. Dr. Dominikus Bücke (HSRO) / Prof. Dr. Wolfgang Alto Mayer (TUM), PhD candidate: Cornelius Uhl (ATF1)
- **Praxisorientierte Erarbeitung systemspezifischer Grundlagen für die Implementierung eines Smart-Grid fähigen On-Farm Energie Management Systems für Milchviehställe mit regenerativer Energieproduktion („On-Farm EMS“)**  
Prof. Dr. Jörn Stumpfenhausen (HSWT) / Prof. Dr. Heinz Bernhardt (TUM): Manfred Höld (ATF1)
- **Akzeptanz unterschiedlicher Windenergiekonzepte in Bayern unter Berücksichtigung von Bürgerbeteiligungsmodellen**  
Prof. Dr. Klaus Menrad (HSWT) / Prof. Dr. Jutta Roosen (TUM), PhD candidate: Katharina Langer (ATF1)
- **Einflussfaktoren für den Bezug, die Produktion und Speicherung von Ökostrom durch kleine und mittelständische Unternehmen (KMUs) angesichts einer sich schnell wandelnden Energiepolitik in Deutschland**  
Prof. Dr. Klaus Menrad (HSWT) / Prof. Dr. Luisa Menapace (TUM), PhD candidate: Sebastian Rahbauer (ATF3)
- **Betriebsfestigkeitsnachweis von Schweißverbindungen bei Windkraftanlagen**  
Prof. Dr.-Ing. Imke Engelhardt (MUAS) / Prof. Dr.-Ing. Martin Mensinger (TUM), PhD candidate: Richard Schiller (ATF1)
- **Analyse des Energieeinsatzes bei der Herstellung von hochpräzisen Optiken**  
Prof. Dr.-Ing. Rolf Rascher (DIT) / Prof. Dr.-Ing. Michael Zäh (TUM), PhD candidate: Christian Trum (ATF1)
- **Untersuchung über die aufzubringende Energie und deren Einsparpotentiale bei der Herstellung von Halbzeugen für die Präzisionsoptik**  
Prof. Dr.-Ing. Rolf Rascher (DIT) / Prof. Dr.-Ing. Michael Zäh (TUM), PhD candidate: Sebastian Sitzberger (ATF3)

- **Erforschung und Entwicklung von transparenten Elektroden aus Carbon Nanotubes Schichten und deren Laserstrukturierung für die organische Photovoltaik**  
Prof. Dr. Heinz Paul Huber (MUAS) / Prof. Paolo Lugli (TUM), PhD candidate: Jürgen Sotrop (ATF1)
- **Ressourceneffizienz von Stadtquartieren**  
Prof. Dr.-Ing. Nathalie Eßig (MUAS) / Prof. Dr.-Ing. Gerd Hauser (TUM), PhD candidate: Matthias Heinrich (ATF1)
- **Bedarfsgerechter und energieeffizienter Luftwechsel zur praxisnahen Wohnungslüftung mit Einzelraum-systemen**  
Prof. Dr. Harald Krause (HSRO) / Prof. Dr.-Ing Klaus Sedlbauer (TUM), PhD candidate: Thomas Strobl (ATF3)
- **Netzgestaltung und Ertragsoptimierung solarthermisch unterstützter Nahwärmenetze im Geschoss-wohnbau**  
Prof. Dr.-Ing. Wilfried Zörner (THI) / Dr. Vicky Cheng (MSE/TUM), PhD candidate: Daniel Beckenbauer (ATF1)
- **Theoretische und experimentelle Untersuchung kunststoffbasierter Drain-Back-Solaranlagen**  
Prof. Dr.-Ing. Wilfried Zörner (THI) / Dr. Vicky Cheng (MSE/TUM), PhD candidate: Mathias Ehrenwirth (ATF2)
- **Gestaltung und Analyse der kombinierten solaren Strom- und Wärmeerzeugung für Wohngebäude und -siedlungen**  
Prof. Dr.-Ing. Zörner (THI) / Prof. Dr. Thomas Hamacher (TUM), PhD candidate: Thomas Duschner (ATF3)
- **Biomassevergasung als regelbare Nährstoffquelle für den Prozess der mikrobiologischen Methanisierung im Rahmen der Power-to-Gas-Technologie**  
Prof. Dr. Raimund Brotsack (DIT) / Prof. Dr.-Ing. Wolfgang Mayer (TUM), PhD candidate: Matthias Kohlmayer (ATF3)
- **Entwicklung eines kompakten Ammoniak-Absorbers für Absorptionswärmepumpen mit physikalischer Modellierung und Simulation**  
Prof. Dr.-Ing Datong Wu (MUAS) / Prof. Dr Alfred Kersch (MUAS) / Prof. Dr.-Ing. Olaf Hinrichsen (TUM), PhD candi-date: Mustafa Yusufi (ATF3)
- **Optimierung neuartiger Ferroelektrika zur elektrokalendarischen Kühlung und pyroelektrischen Energieenernte mit Simulation**  
Prof. Dr. Alfred Kersch (MUAS) / Prof. Dr. Karsten Reuter (TUM), PhD candidate: Christopher Künneth (ATF3)

The PhD candidates are registered at the doctoral candidacy list of the MSE and are members of the MSE Graduate Center.

# Energy in Context

## Social and Legal Impact of Large-Scale Energy Projects

**The social and legal impacts and the security policy aspect of large-scale energy projects have yet to be investigated. Comparative energy research offers the opportunity to discuss energy issues in a global context.**

“Energy and Geopolitics” attempts to promote and strengthen dialogue in energy research across national borders, as well as construct a transfer system for technological cooperation. It seeks to provide a common basis for comparative energy research, particularly in the Caucasus and Central Asia. And finally, it offers researchers the opportunity to discuss their work in a broad and global context and develop an international profile.

In cooperation with Tbilisi State University, Yerevan State University, the Center for Strategic Studies under the President of the Republic of Azerbaijan, and the DAAD, the Munich School of Engineering (MSE) organized a workshop on the topic “Cooperation needs energy: Energy dialogue for a peaceful Caucasus.” From July 15 to 21, 2014, scientists from Germany and the Caucasus discussed the conditions, requirements and chances of a comprehensive regional energy policy that focuses on current and potential future developments in the Caucasus. The discussion therefore addressed the current situation and the perspectives of the energy dialogue, as well as the possibilities and limits of regional cooperation on energy issues in the Caucasus. Key aspects of the discourse included additional impulses for shaping the energy dialogue in the Caucasus and encouraging and strengthening a regional network of scientists. The workshop looked at the connection between science and experience with energy topics in the Caucasus. The integrative potential of energy projects in the Caucasus and the transferability of European experience in energy cooperation to the Caucasus were also analyzed. Overall, the workshop set a new emphasis by putting the regional energy policy into a broader context and opening up new perspectives for the scientific dialogue on regional cooperation in the Caucasus.

Following the invitation of the Association of Security Policy, a seminar on the topic “The Caucasus at the focus of geopolitics – Russia’s interests and Europe’s thirst for energy” was held on September 17, 2014 in Bad Kissingen. The event focused on new energy projects and on the current geopolitical context with respect to the diversification of Europe’s energy supply.

**Contact:**

**Prof. Dr. Giorgi Khubua**

[Giorgi.khubua@tum.de](mailto:Giorgi.khubua@tum.de)

# Internationalization

**Energy research is only reasonable if global issues are considered properly. Climate change, resource scarcity are all issues which can only be dealt with from a global view. Therefore we have a strong interest in forming networks with other universities and attracting students from all over the world.**

While these collaborations are in principle conceivable with many universities all over the world, MSE decided to focus on a few but strategically important partners.

First is Singapore. Singapore is one of the major trade, financial and also technology hubs for Asia and is seen as outstanding example in Asia which many countries do emulate. Therefore it is of prime importance to cooperate with and work in Singapore to use this as spearhead for Asia. TUM is well represented in Singapore first with the German Institute of Science and Technology (GIST) and the bachelor and master programs offered by GIST. In 2014, MSE developed a new Master of Science on “Power Systems and Energy Management” for GIST which will start in 2016. Concerning research, well-established cooperation between TUM and Singapore is already existing, first of all the collaborative research program TUM CREATE where many MSE researchers participate. In 2014, the NTU in Singapore and TUM agreed on a common research program in energy research, the “International Center for Energy Research (ICER)”, in which both universities will mutually finance ten tandems of Ph.D. students in a first step. In each of these projects, one student in Singapore and one student in Munich will work on the same subject. Regular exchanges will help to strengthen the cooperation. A first ICER-workshop was held at TUM in April 2014 to identify major fields of interest. The program itself will start in spring 2015.

The second focus is the University of Texas in Austin in the US. While here no formal agreement was reached yet we started cooperation with exchanges of Ph.D. students and plan to define a program next year.

Also discussions with France and Austria are under way which are especially important to strengthen the European efforts in energy research. In 2014, TU Graz and TUM signed a cooperation agreement on energy research after mutual visits in 2012 and 2013. Two major meetings with the Atomic and Renewable Energies Commission of France (CEA) were held. In July a group of CEA-representatives visited TUM and discussed possible fields of joint research. In December researchers from TUM visited CEA-facilities in Grenoble and Chambéry and pursued the cooperation with the formation of first research teams in the fields of biomass, batteries for e-mobility and the analysis of coupled energy systems in France and Germany.



# MSE Management Office



from left to right

**Olga Marini**, Course Coordination B.Sc. Engineering Science

**Petra Rau**, Approval and Exams

**Angela Brunnbauer**, Assistance and Financial Accounting

**Antje Asbach**, TUMonline & IT

**Dr. Cornelia Gotterbarm**, Managing Director

**Gunther Löffmann**, Scientific Associate & Coordination studium MINT

**Birgit Reinbold**, Head of Academic Programs Office

**Dr. Christiane Hamacher**, Course Coordination M.Sc. Industrial Biotechnology

**Martha Diglio Hupfer**, Course Coordination M.Sc. Human Factors Engineering







## Picture Credits

Cover Image: Britta Eriskat, based on Fritsch & Tschaidse  
Pages 7 (Hermann), 8 (Hamacher), 70 (Hamacher, Spliethoff, Sattelmayer, Witzmann), 143 (Gasteiger, Herzog, Lienkamp), 175: TUM, Eckert/Heddergott  
Pages 9 (Adams), 12 (Spliethoff), 13 (Müller-Buschbaum), 15 (Lienkamp), 19 (Herzig), 21 (Jossen), 22 (Bottasso, Hackl), 40, 42, 44 (Schmitz), 45 (Gee), 46 (Weuster-Botz), 51 (Reif), 52 (Patzelt), 53 (Müller-Buschbaum, Wohlmuth), 54 (Gee), 55 (Mainzer), 69, 78, 91, 94, 109, 117, 118 (Spliethoff), 121 (both), 122 (upper picture), 128/129, 141: TUM, Andreas Heddergott  
Pages 10, 14 (Gasteiger, Herzog), 16 (Auer), 17 (Hamacher, Lang, Sedlbauer), 18 (Hamacher), 20 (Cheng), 24, 47 (Bengler), 51 (Stechele, Luksch, Große), 86, 153, 154: TUM, Astrid Eckert  
Pages 26, 28, 29, 30, 31, 32, 33, 34, 35, 49, 50, 59: Britta Eriskat  
Pages 27, 52, 54 (both), 66, 168: Munich School of Engineering  
Page 38: Fritsch & Tschaidse  
Page 55 (Kemper): Kemper  
Page 58: Industrial Biotechnology  
Pages 64, 65: MSE Student Council  
Pages 71, 74 (both), 77, 79, 81: Flexible Power Plants Group  
Page 72: Flexible Power Plants Group, Dominic Hewes  
Page 75 (upper image): Flexible Power Plants Group, Stephan Lellek  
Page 75 (lower image): Flexible Power Plants Group, Nicolai Stadlmair  
Page 76: Flexible Power Plants Group, Max Baumgärtner  
Pages 83, 84, 85, 104: Energy Efficient and Smart Cities Group  
Pages 92, 93, 97, 98 (both): Control of Renewable Energy Systems Group  
Page 102, 105: Chair of Functional Materials  
Page 103: Institute for Energy Systems  
Page 107: Mayer + Stetka  
Pages 111, 114, 115 (upper graphic), 116: EEBatt-team  
Page 115: Christian Huber  
Page 118 (Fischer): Felix Fischer  
Pages 81,118 (Kahlert): Oliver Farys  
Pages 119, 120 (all), 122 (lower picture), 126: Center for Power Generation

Page 123 (all), 124 (upper picture), 158, 159 (both), 167: TUM, Uli Benz  
Page 124 (lower picture), 125: Chris Gebhardt  
Pages 132, 133, 134 (all), 135, 136, 137, 139, 140: Network for Renewable Energy  
Pages 142, 144, 145, 146, 147, 148, 149 (both): Science Center for Electromobility  
Pages 155, 161: Center for Sustainable Building  
Page 160: Chair of Energy Management and Application Technology  
Page 165: GSP Architects and Rainer Schmidt Landscape Architects

# Imprint

## **Publisher**

Technische Universität München  
Munich School of Engineering  
Boltzmannstraße 17  
85748 Garching

## **Editors**

Prof. Dr. Thomas Hamacher  
Dr. Cornelia Gotterbarm  
Gunther Löffmann

## **Layout**

Britta Eriskat Grafik  
[www.eriskat.de](http://www.eriskat.de)

## **Language editing**

Baker & Harrison  
Fachübersetzungen und Lektorat  
[www.bakerharrison.de](http://www.bakerharrison.de)

Patrick Regan

## **Printed by**

Druckerei Joh. Walch GmbH & Co KG  
Im Gries 6  
86179 Augsburg

print run 1000

June 2015



[www.mse.tum.de](http://www.mse.tum.de)