

Wissenschaftszentrum Weihenstephan
für Ernährung, Landnutzung und Umwelt
Lehrstuhl für Ökologische Chemie und Umweltanalytik
der Technischen Universität München

**Emissions Minimization of Chlorinated Micropollutants in
Coal Solid Waste Co- Combustion
by Primary Measures**

Marchela Edvart Pandelova

Vollständiger Abdruck der von der Fakultät Wissenschaftszentrum Weihenstephan für Ernährung, Landnutzung und Umwelt der Technischen Universität München zur Erlangung des akademischen Grades eines

Doktors der Naturwissenschaften

genehmigten Dissertation.

Vorsitzender: Univ.-Prof. Dr.-Ing. R. Meyer-Pittroff.

Prüfer der Dissertation:

1. Univ.-Prof. Dr. rer. nat., Dr. h. c. (RO) A. Kettrup
2. Univ.-Prof. Dr. rer. nat., Dr. agr. habil. H. Parlar
3. Priv.-Doz. Dr. rer. nat., Dr. agr. habil. K.-W. Schramm

Die Dissertation wurde am 06.07.2004 bei der Technischen Universität München eingereicht und durch die Fakultät Wissenschaftszentrum Weihenstephan für Ernährung, Landnutzung und Umwelt am 08.11.2004 angenommen.

The practical part of the proposed work is carried out from August 2001 till August 2004 in Institute for Ecological Chemistry of GSF-Research Centre for Environmental and Health GmbH (Neuherberg).

To all who have contributed to the successful completion of this work I would like to warmly thank.....

... Prof. Dr. A. Kettrup for the opportunity to be member of his excellent scientific team; for the perfect work possibility and his pleasure lead style.

... PD Dr. K.-W. Schramm for the great support and understanding during my PhD work; for his high motivation and efficiency; for his essential tutorial influence on my result representation skill; for the long and inspiring research discussion

... Prof. Dr. D. Lenoir for the brilliant ideas; for the great chance to be in touch with his versatile knowledge and respectable experience

... Prof. Dr. H. Parlar for the acceptance to be reviewer of this work

... Mr. B. Henkelmann for the carried out PCDD/F-, PCB and PCBz –measurements; for the many answers about analytical problems that he ever clear it and never complained

... Mrs. J. Kotalik for her friendly welcome in dioxin laboratory; for her help and kindly tutorial during the long clean-up procedure and the pleasure atmosphere around her; for her support in the beginning of my stay in Munich

... Mr. N. Fischer for his help during the sample preparation; for his responsiveness; for his friendly work atmosphere

... Mrs. V. Péronnet for the fruitful collaboration in the field of “sampling” accreditation; for her enthusiasm and motivation.

... Mrs. B. Danzer for her support and assistance during my PhD work

...my colleagues F. Jäkle, H. Hofbauer, M. Ciomasu, C. Rießbeck, N. Milanov, N. Chahbane, M. Blumenstock, K. Fried, L. Hollosi, A. Fekete and many other colleagues of IÖC for their friendly and helpful work atmosphere

... my parents Ani and Edi for their love, care and understanding during all my study

... my husband Stanislav for his great motivation to begin that PhD work; for his optimism and understanding during the work; for his nice character.

Publications connected to this work

1. M. Lebikyan; D. Lenoir; K.-W. Schramm and A. Kettrup (2002). *Pattern of regioisomers of chlorinated biphenyls in emission samples*, 22th International Symposium on Halogenated Environmental Organic Pollutants and POPs (Dioxin 2002). Barcelona, Spain
2. D. Lenoir; K.-W. Schramm and M. Lebikyan (2002). *Formation, mechanism, and minimization of chlorinated micropollutants (dioxins) formed in technical incineration processes*, International Workshop of Hazardous Halo-Aromatic Pollutants. Venice, Italy .
3. V. Peronnet; M. Pandelova; A. Kettrup and K.-W. Schramm (2003). *Implementation of a quality system in a research facility*, Presentation, International Conference QA/QC in the field of emission and air quality measurements. Praha, Czech Republic
4. M. Pandelova; K.-W. Schramm and D. Lenoir (2003). *Emission minimization in coal-solid waste co-combustion by primary measures*, Presentation, 8th international Congress of Combustion By-Product. Umea, Sweden.
5. M. Pandelova; D. Lenoir, A. Kettrup and K.-W. Schramm (2003). *Primary measures for reduction of PCDD/F in co-combustion of lignite coal and waste:effect of various inhibitors*, Presentation, 23th International Symposium on Halogenated Environmental Organic Pollutants and POPs (Dioxin 2003). Boston, USA
6. M. Pandelova; D. Lenoir, A. Kettrup and K.-W. Schramm (2004). *Primary measures for reduction of PCDD/F in co-combustion of lignite coal and waste:effect of various inhibitors*. Environmental Science and Technology: submitted.
7. M. Pandelova; D. Lenoir, A. Kettrup and K.-W. Schramm (2004). *Correlation between PCDD/F, PCB and PCBz in coal/waste combustion. Influence of various inhibitors*, 24th International Symposium on Halogenated Environmental Organic Pollutants and POPs (Dioxin 2004). Berlin, Germany

List of Abbreviations

η	energy efficiency	PCPh	Polychlorinated phenol
$[(\text{CH}_3)_2\text{N}]_3\text{P}(\text{O})$	hexamethylphosphoramide	Pdyn	dynamic pressure in the duct
ω_i	volume part of a gas componen	pg	picogram
ρ_n	density of dry flue gas under standard conditions	POP	Persistent organic pollutant
$\rho_{n,f}$	density of flue gas including water vapor under standard conditions	pst	static pressure in the duct
$\rho_{n,i}$	density of a gas component under standard condition	PVC	Polyvynil chloride
$\rho_{n,w}$	standard density of water	R^2	Coefficient of determination
$(\text{NH}_2)_2\text{CO}$	urea	S	sulfur
$(\text{NH}_4)_2\text{HPO}_4$	di-ammoniumhydrogenphosphate	t	ton
$(\text{NH}_4)_2\text{S}_2\text{O}_3$	ammoniumthiosulfate	T	Temperature
$(\text{NH}_4)_2\text{SO}_4$	ammoniumsulfate	Cu	copper
$\rho_{pt,f}$	density of flue gas	Td	temperature in the duct
$^\circ\text{C}$	Celsius degree	TEF	Toxicity Equivalent factor
μl	micro liter	TiO_2	titanium (IV) oxide
Al_2O_3	aluminium(III)oxide	V	velocity of the gas
CA	Correspondence Analysis	Vc	calculated standard sample gas flow rate
CaCl_2	calcium chloride	$V_{m;n,i}$	molar standard volume
Cr_2O_3	chromium (III) oxide	V_n	measured standard sample gas flow rate
CuSO_4	copper sulphate	Vol %	Volume percentage
d	diameter of the nozzle	WHO	World Health Organization
ESP	Electrostatic presipitator	XAD-2	Adsorbent
fn	humidity of the exhaust gas	ZrO_2	zirconium (IV) oxide
g	gram		
h	hour		
$\text{H}_2\text{NSO}_2\text{NH}_2$	sulfamide		
$\text{H}_2\text{NSO}_3\text{H}$	amidosulfonic acid		
$\text{H}_2\text{NSO}_4\text{H}$	hydroxylamine-O-sulfonic acid		
hPa	hydro pascal		
HRGC/HGMS	High Resolution Gas Chloromatography/High Resolutiuon mass spectroscopy		
HSW	hazardous solid waste		
ID	internal diameter		
I-TEQ	International Toxicity Equivalent		
w/w	weight per weight		
j	number of data		
kg/m^3	kilogram per cubic meter		
L	liter		
m/s	meter per second		
mbar	millibar		
Mg	Megagramm		
min	minute		
$M_{r,i}$	relative molecular weight of a gas component		
MSW	municipal solid waste		
$\text{N}(\text{CH}_2\text{CH}_2\text{OH})_3$	triethanolamine		
n.d.	not detected		
$\text{Na}_2\text{MoO}_4 \cdot 2\text{H}_2\text{O}$	sodium molybdate dihydrate		
$\text{Na}_2\text{S} \cdot \text{H}_2\text{O}$	sodium sulfide		
$\text{Na}_2\text{WO}_4 \cdot 2\text{H}_2\text{O}$	sodium tungstate dihydrate		
NaCl	sodium chloride		
NaVO_3	sodium (meta) vanadate		
ng	nanogram		
Nm^3	normal cubic meter		
P_2S_5	phosphorus (V) sulfide		
PAH	Polyaromaic hydrocarbon		
patm	pressure in the ambient air		
PCA	Principal Component Analysis		
PCB	Polychlorinated benzene		
PCBz	Polychlorinated benzene		
PCDD/F	Polychlorinated dibenzo-p-dioxin/furan		

Content

List of Abbreviations	IV
1 Introduction	1
2 Objectives	5
3 State of Knowledge	7
3.1 PCDD/F, PCB and PCBz	7
3.1.1. Dioxin nomenclature and properties	7
3.1.2. Dioxins and public health	11
3.1.3. Dioxin emission sources	11
3.2. Formation of Dioxins	12
3.2.1. De novo synthesis.....	13
3.2.2. Synthesis from precursors	15
3.2.3. Influence of the operation parameters and the fuel type on PCDD/F emissions	17
3.3. Correlation between PCDD/F , PCB and PCBz	19
3.4. Dioxin Minimization	20
3.4.1. Secondary Measures	21
3.4.2. Primary Measures	22
3.4.2.1. Minimization of dioxins formation by adjustment of the operation conditions.....	22
3.4.2.2. Use of additives inhibiting the PCDD/F formation	23
4. Materials and Methods	28
4.1. Pilot Scale Experiments	28
4.1.1. Sampling Equipment MRU 4000.....	29
4.1.2. Controlled parameters before sampling	32
4.1.3. Validation of the sampling measurements	34
4.1.4. Laboratory preparation prior the sampling	34
4.1.5. Laboratory work after the sampling.....	35
4.1.6. Sampling place.....	36
4.1.7. Sampling points.....	37
4.1.8. Sampling campaigns.....	38
4.2. Laboratory Scale Experiments	40
4.2.1 Laboratory apparatus	40
4.2.2. Experimental procedure	41
4.2.3. Fuel type and examined inhibitors	42
4.2.4. Laboratory work before clean-up	44
4.2. Clean-up Procedure	44
4.3.1. Sandwich column	47
Preparation of the sandwich column:	47
Elution of the sample.....	47

4.2.2. Alox column.....	48
Preparation of the alox column:	48
Elution of PCB and PCBz Fraction.....	48
Elution of the PCDD/F Fraction	49
4.3.3. Florisil column	49
Preparation of the florisil column:.....	49
Preparation of the Thielen and a Olsen column	50
Elution of the sample.....	50
4.3.5. GPC column for PCB analysis	50
Sample preparation.....	51
Operation with GPC column.....	51
Note.....	51
4.3.6. C18 column	51
Sample preparation.....	52
Preparation of the C18 column:	52
Elution of the sample.....	52
After C18 clean up column.....	52
4.3.7. Concentration.....	53
4.3. Detection & Quantification with HRGC/HRMS.....	53
4.4.1. Detection of PCDD/F.....	53
Evaluation of the measurement	54
4.4.2. Detection of PCB and PCBz	54
Evaluation of the measurement	55
4.4.4. Quantification of PCDD/F, PCB and PCBz	55
Response factor	55
Quantification process.....	55
Control of the final data	56
4.4. Statistical Analysis.....	56
5 Results and Discussion.....	59
5.1. Pilot Scale Sampling	59
5.1.1. Quality of the Data	59
Analytical data.....	59
Sampling data	60
Discussion.....	63
5.1.2. Influence of Combustion Parameters on the Formation of PCDD/F and PCB in a Pilot Incinerator	65
Combustion temperature.....	65
Chlorine in feed	67
O ₂ , CO ₂ and CO content	68
Discussion.....	69
5.3. PCDD, PCDF and PCB Homologues Profiles.....	71
Discussion.....	73
PCDD, PCDF and PCB Concentrations. Congeners profile	75
Discussion.....	78
5.2. Laboratory scale experiments.....	80
5.2.1. Optimization of the experiment	80
Homogenization of the combustion fuel	80
Combustion temperature.....	81
Fuel material	82
Duration of the experiment.....	83

Blank samples	83
Discussion	83
5.2.2. Effect of various inhibitors	84
PCDD/F concentration	84
PCB concentration	85
Principle Component Analysis	85
The 17 Toxic PCDD/F Isomers	88
The 12 Toxic PCB isomers	91
Discussion	92
5.2.3. Experiments with Varying Inhibitor Amount	93
PCDD/F concentration	93
PCB concentration	94
PCBz concentration	95
Discussion	96
5.2.4. PCDD/F and PCB Homologue Distribution for the 20 Different Inhibitors Present as 10% of the Fuel	97
Discussion	99
5.2.5. PCDD/F, PCB and PCBz Homologue Distribution for the (NH ₄) ₂ SO ₄ and (NH ₄) ₂ S ₂ O ₃ Present as 10%, 5%, 3% and 1% of the Fuel.....	100
Discussion	103
5.2.6. Inhibitory Effect of (NH ₄) ₂ SO ₄ at 1000°C	103
5.2.6.1. Combustion where the sample is introduced at preheated 1000°C furnace	104
PCDD/F concentration	104
PCB concentration	105
Discussion	105
5.2.6.2. Combustion where the sample is introduced at preheated 200°C programmed furnace	106
PCDD/F concentration	106
PCB concentration	107
PCBz concentration	108
Discussion	109
5.3. Correlation between PCDD, PCDF, PCB and PCBz in coal / solid waste and PVC combustion at the influence of various inhibitors.	110
5.3.1. Correlation between PCDD, PCDF, PCB and PCBz. Influence of Varying Inhibitors Amount	110
Discussion	116
5.3.2. Correlation between PCDD, PCDF and PCB. Influence of Various Inhibitors.	118
Discussion	121
6 Discussion	123
7 Outlook.....	127
8. Appendix	128
8.1. Dioxin Laboratory.....	128
8.1.1. Materials.....	128
8.1.2. Equipment and Program adjustment.....	129
8.1.3. Standard substances	131
8.2. Emission Sampling	132
8.2.1. Equipments	132

8.2.2. Combusted fuel	133
8.3. Laboratory Scale Experiments	134
8.3.2. Equipment	134
8.3.2. Reagents	134
9 References	135

Figures

Fig. 3.1: Polychlorinated di-p-benzo-dioxin (a); Polychlorinated di-p-benzo-furan (b); Polychlorinated benzene (c); Polychlorinated biphenyl (d)	8
Fig. 3.2: De novo synthesis of PCDD/F	14
Fig.3.4: Copper catalysed formation of PCDD/F from ortho- chlorophenol and chlorbenzene.....	16
Fig. 3.5: Formation of PCDFs via Pschorr-type ring closure	16
Fig. 4.1: Arrangement of the sampling equipment MRU 4000	29
Fig. 4.2: Installation of the sampling tube in the cooler	33
Fig. 4.3: Sampling background.	37
Fig. 4.4: Arrangement of the sampling points in the chimney.	38
Fig. 4.5:Scheme of the laboratory scale furnace.....	41
Fig. 4.6: Sample preparation flowchart for PCDD/F, PCB and PCBz analysis.....	45
Fig. 4.7: Continued preparation flowchart for PCB and PCBz analysis.....	46
Fig. 4.8. Schematic representation of PCA.....	57
Fig. 5.1: Measured and calculated standard sample gas flow rate after a wood incinerator	63
Fig. 5.2: PCDD/F I-TEQ value (pg/m ³) in poplar wood combustion at different temperatures.....	66
Fig. 5.3: PCDD/F I-TEQ value (pg/m ³) in poplar wood and 10% PVC combustion at different temperatures	66
Fig. 5.4: PCB I-TEQ value (pg/m ³) in poplar wood and 10% PVC combustion at different temperatures	67
Fig. 5.5: PCDD/F I-TEQ value (pg/m ³) in wood and wood/10% PVC combustion campaigns at similar temperatures	68
Fig. 5.6: Correlation between PCDD/F I-TEQ value and O ₂ ,CO ₂ and CO gas concentration in wood/10% PVC combustion campaigns	68
Fig. 5.7: Percentage of PCDD homologues mass distribution of the sampling campaign No.2-8.....	71
Fig. 5.8: Percentage of PCDF homologues mass distribution of the sampling campaign No.2-8.	72
Fig. 5.9: Percentage of PCB homologues mass distribution of the sampling campaign No.4,7 and 8.....	72
Fig. 5.10: Sum of tetra-octa PCDD (A) and sum of tetra-octa PCDF (B) for sampling campaign No. 2-8.....	75
Fig. 5.12: Mass concentration of the 12 toxic PCB congeners for samples No. 4,7 and 8.....	77
Fig. 5.13: Mass concentration of the 17 toxic PCDD/F congeners for sample No. 2-8.	78
Fig. 5.14: I-TEQ values (pg/sample) of the 17 toxic PCDD and PCDF congeners emitted during fuel combustion at 500°C in a laboratory scale furnace.	81
Fig. 5.16: PCB I-TEQ (pg/g) values of the flue gas after combustion of lignite coal, solid waste and PVC for the samples without inhibitor and 20 different compounds used at 10% inhibitor of the fuel.....	85
Fig. 5.17: Score plot of PCB (A), PCDD (B) and PCDF (C) of 5 replicates treated without any inhibitor (A) and 20 samples with 10% inhibitor.....	87
Fig. 5.18: PCDD/F I-TEQ pg/g fuel values in the flue gas for the samples without inhibitor and with (NH ₄) ₂ SO ₄ and (NH ₄) ₂ S ₂ O ₃ at 10%, 5%, 3% and 1% and (NH ₂) ₂ CO+S at 10%, 3% and 1% as inhibitor of the fuel.	94
Fig. 5.19: PCB I-TEQ pg/g fuel values in the flue gas for the samples without inhibitor and with (NH ₄) ₂ SO ₄ and (NH ₄) ₂ S ₂ O ₃ at 10%, 5%, 3% and 1% and (NH ₂) ₂ CO+S at 10%, 3% and 1% as inhibitor of the fuel.	95
Fig. 5.20: Sum PCBz pg/g fuel values in the flue gas for the samples without inhibitor and with (NH ₄) ₂ SO ₄ and (NH ₄) ₂ S ₂ O ₃ at 5%, 3% and 1% and (NH ₂) ₂ CO+S at 3% and 1% of the fuel.....	96
Fig. 5.21: Percentage of PCDD (A), PCDF (B) and PCB (C) homologues mass distribution of the samples with and without inhibitor during combustion of lignite coal, solid waste and PVC in lab scale experiments.	98
Fig. 5.22: Percentage of PCDD (A) and PCDF (B) homologues mass distribution of the samples without inhibitor and with 10%, 5%, 3% and 1% (NH ₄) ₂ SO ₄ and (NH ₄) ₂ S ₂ O ₃ during combustion of lignite coal, solid waste and PVC in lab scale experiments	100

Fig. 5.23: Percentage of PCB (A) and PCBz (B) homologues mass distribution of the samples without inhibitor and with 5%, 3% and 1% (NH ₄) ₂ SO ₄ and (NH ₄) ₂ S ₂ O ₃ during combustion of lignite coal, solid waste and PVC in lab scale experiments.....	102
Fig. 5.24: PCDD/F I-TEQ pg/g fuel values in the flue gas at 1000°C for the samples without inhibitor and with (NH ₄) ₂ SO ₄ at 10% and 5% introduced at preheated 1000°C furnace.....	104
Fig. 5.25: PCB I-TEQ pg/g fuel values in the flue gas at 1000°C for the samples without inhibitor and with (NH ₄) ₂ SO ₄ at 10% and 5% introduced at preheated 1000°C furnace.....	105
Fig. 5.26: PCDD/F I-TEQ pg/g fuel values in the flue gas at 1000°C for the samples without inhibitor and with (NH ₄) ₂ SO ₄ at 5% introduced at preheated 200°C programmed furnace.	107
Fig.5.27: PCA score plot of 21 cases (samples) and 36 variables (PCDD/F, PCB and PCBz homologues)	111
Fig. 5.28: CA score variables plots for the samples with lower TEQ (A) and higher TEQ (B).....	113
Fig. 5.29: Couple points of score variables plot (B) of CA in Fig. 22.	115
Fig.5.30: Couple points of score variables plot (A) of CA in Fig. 22.	116
Fig.5.31: PCA score plot of 49 cases (samples) and 26 variables (PCDD/F and PCB homologues).....	119
Fig. 5.32: CA score variables plots for the samples with higher TEQ (A) and lower TEQ (B).....	120
Fig.5.33: Couple points of score variables plot (A) of CA in Fig. 26.	121

Tables

Tab.1.1: Energy efficiency of power plant and waste incinerator [4]	2
Tab.1.2: Costs for reduction of dust emissions, CO/NO _x , and SO ₂ in co-combustion [4].....	3
Tab.1.3: Costs for reduction of dust emissions, CO/NO _x , and SO ₂ in coal / waste combustion [4].....	3
Tab. 3.1: Homologues and congeners of PCDD, PCD , PCB and PCBz	8
Tab.3.2:Toxic equivalent factor (I-TEFs).....	10
Fig.3.3: Deacon reaction	14
Tab. 4.1: Sampling campaigns.....	39
Tab. 4.2: Clean-up procedure for PCDD/F, PCB and PCBz analysis	47
Tab. 5.1:Recovery rate of the internal standard for the analyzed compounds.....	59
Tab. 5.2:Recovery rate of the sampling standard	60
Tab. 5.3: Blank samples during the sampling campaigns	60
Tab. 5.4: Comparison of the PCDD/F I-TEQ value of the back-up cartridge and the total emission sample	61
Tab. 5.5:Comparison of the PCDD/F I-TEQ value of the resin XAD-2 cartridge and the total emission sample	62
Tab. 5.6:Comparison of the PCB I-TEQ value of the resin XAD-2 cartridge and the total emission sample.....	62
Tab. 5.7: Calculated isokinetic ratio during the sampling campaigns.....	62
Fig. 5.11: Sum of mono-deca PCB for sampling campaign No. 4,7 and 8.	76
Tab. 5.8: PCDD/F I-TEQ value (pg/g) of homogenized and not homogenized combusted fuel samples.....	80
Tab. 5.9: PCDD/F and PCB I-TEQ values (pg/g) for samples combusted at 300°C, 400°C and 500°C.	82
Tab. 5.10: PCDD/F and PCB I-TEQ values (pg/sample) of the blank samples performed in a laboratory scale furnace	83
Fig. 5.15: PCDD/F I-TEQ (pg/g) values of the flue gas after combustion of lignite coal, solid waste and PVC for the samples without inhibitor and 20 different compounds used at 10% inhibitor of the fuel.....	84
Tab. 5.11: Values of the 17 toxic PCDD/F isomers pg/g fuel for the most effective inhibitors and the average value of the sample without inhibitor.....	90
Tab. 5.12: Values of the 12 toxic PCB isomers pg/g fuel for the most effective inhibitors and the average value of the sample without inhibitor.....	91
Tab. 5.13: 2,3,7,8-TCDD I-TEQ (pg/g) fuel values in the flue gas at 1000°C for the samples without inhibitor and with (NH ₄) ₂ SO ₄ at 10% and 5% introduced at preheated 1000°C furnace.	105

Fig. 5.27: PCB I-TEQ pg/g fuel values in the flue gas at 1000°C for the sample without inhibitor and with (NH ₄) ₂ SO ₄ at 5% introduced at preheated 200°C programmed furnace.	108
Fig. 5.28: PCBz pg/g fuel values in the flue gas at 1000°C for the sample without inhibitor and with (NH ₄) ₂ SO ₄ at 5% introduced at preheated 200°C programmed furnace.	108
Tab. 5.14: Number of the cases used for PCA and CA statistical analyses.....	110
Tab.5.15: Number of the variables used for PCA and CA statistical analyses. * - I-TEQ value	111
Tab. 5.16: Number of the cases used for PCA and CA statistical analyses.....	118
Tab. 5.17: Number of the variables used for PCA and CA statistical analyses. * - I-TEQ value	118
Tab. 8.1:Equipment and program adjustment for PCDD/F analysis.....	129
Tab. 8.2:Equipment and program adjustment for PCB analysis	130

SUMMARY

This study addresses co-combustion of coal-solid waste mixtures in pilot and laboratory-scale combustors, with emphasis on monitoring of toxic chlorinated hydrocarbon emissions like: polychlorinated dibenzo-p-dioxins (PCDD), polychlorinated dibenzofurans (PCDF), polychlorinated biphenyls (PCB) and polychlorinated benzenes (PCBz). The objectives of the work are stress on the so-called primary measures technique which cause reduction of the toxic emission prior formation the chlorinated micropollutants. This approach includes adjustment of operation condition such as temperature, turbulence, and residence time. Primary measures may include the addition of some selected compound in the post combustion zone aiming in reducing the formation of PCDD/F and their precursor; it is known as inhibition and differs the flue gas cleaning methods as it deals with the prevention of PCDD/F.

Emissions of polychlorinated dibenzo-p-dioxins (PCDD) and polychlorinated dibenzofurans (PCDF) are sampled isokinetically. According to VDI guidelines 3499 PCDD/F the used method of sampling is "cooled sucking tube probe method" where the automatic sampling system MRU 4000 is employed. The emission samples are prepared according standard clean-up procedure for PCDD/F and PCB and further analysed at HRGC/HRMS. Every cartridge is registered and extracted twice with Soxhlet apparatus clean-up, each of them 24h for glass wool and resin cartridges. Preparation and elution employs sandwich, alox, florisil, and Thilson-Olson columns. Poplar wood and different percent mixture of wood and PVC were studied. In order to find relevant conditions of formation for PCDD/F different temperatures in the stack (150 °C – 500 °C) were investigated during combustion. The result of PCDD/F relevant to the combustion at different temperature shows that the highest concentrations are detected for the sample at 500 °C. PCDF concentration is about three times higher than PCDD in every emission sample. The reason is attributed to the mechanisms of formation of the chlorinated hydrocarbons. These results led to the conclusion to study on PCDD/F formation at temperatures higher than 350 °C and less than 600°C as reaction optimum.

A series of experiments in laboratory scale condition for the prevention of PCDD/F formation by inhibitors were performed. Thermally resistant inorganic compounds were added directly to the fuel. Investigations about PCDD, PCDF, PCB and PCBz-pattern are developed, as well as about the corresponding treatment PCDD/F-results

by means of multivariate statistical methods. Principle Component Analysis and Correspondence Analysis are used to find the correlations between the PCDD/F and indicator parameters. The influence of varying inhibitors amount on these relationships was also investigated.

The fuel-types used in this study are lignite coal from Puertollano (CIEMAT, Spain), pre-treated municipal solid waste (Rethmann Plano GmbH) and PVC (waste from ground floor). The weight percentage content for the lignite coal is 80 % and for the chlorinated compounds is 20 % as 13.33:6.66 respectively for the solid waste and PVC. In case of inhibitor experiments, the inhibitor is present as 10 % of the fuel. Four different groups with 20 different compounds are used as inhibitors: metal oxides group; N-contents group; S-contents group; N- and S-contents group. A laboratory scale horizontal split-tube furnace (Carbolite, England) is used for the experiments. The flue gases occurring during the experiment are trapped into 3 impingers in series, each of them filled with toluene. The combustion experiments are performed according to the same procedure each time in order to achieve comparable results. The furnace temperature is 400 °C, the air flow is 2 L / min, the weight of the sample is 10 g and the duration of the experiment is 30 min.

The total amounts of PCDD/F, PCB and PCBz generated during experiments with lignite coal, solid waste and PVC are high enough to investigate substantial inhibition. The experimental results with inhibitors manifested very different values for PCDD/F and PCB. Metal oxides show no inhibitory effect while compounds containing N- and S show strong reduction of PCDD/F and PCB-values. Two inorganic compounds such as $(\text{NH}_4)_2\text{SO}_4$ and $(\text{NH}_4)_2\text{S}_2\text{O}_3$ were considered as the most effective inhibitors among the additives. Both substances were used at 10, 5, 3 and 1 % of the fuel. The results show that $(\text{NH}_4)_2\text{SO}_4$ and $(\text{NH}_4)_2\text{S}_2\text{O}_3$ are still effective inhibitors at 10% and 5% of the fuel for PCDD/F, PCB and PCBz. If the percentage of these substances is decreased further, the suppressing effect of dioxin formation also decreased. $(\text{NH}_4)_2\text{SO}_4$ might also reduce the PCDD/F flue gas emission up to 90% even at 3% of the fuel. In order to proof the stability and efficiency of the inhibitor, the proposed compound was also used at different combustion conditions. The final conclusions state that at temperature of 1000 °C, even of 5% of $(\text{NH}_4)_2\text{SO}_4$ the fuel is still effective inhibitor for PCDD/F, PCB and PCBz formation. The reduction by its use is estimated up to 90%. $(\text{NH}_4)_2\text{SO}_4$ is a low cost and non- toxic material. That makes it applicable for use in a full scale combustion unit.

1 Introduction

Incineration of solid waste has become an important method for processing of this material and for energy production [1]. Municipal waste incineration is widely used to dwindle the waste volume. Further it reduces the potential infection threat and the bulk of the medical waste, and for this reason incineration is a promising approach to handling hazardous chemical and biological waste. The increasing costs of the municipal waste management and disposal options in the recent years, and the desire of the most developed countries to utilise the organic waste material from landfill depots, increase the interest of some power plants to use coal together with the waste for energy production. The technology of co-firing of fossil fuel, biomass and waste has been a promising technique for many years. It could help the greenhouse gas emissions and waste quality to be reduced on one hand and on the other hand it will enable the utilization of the waste energy, thus preserving fossil fuel resources [2]. Coal-waste co-combustion can be also specially attractive for countries which do not waste incinerators.

The question arises as to what advantages, technical or economical, are offered by the co-utilization of waste material and coal [3]. The benefits and disadvantages of this technique must be considered.

The partial replacement of coal by waste material can be a way of introducing renewable energy. In a number of countries, this is regarded as being of significant environmental benefit, and the respective governments subsidize and provide inducements to encourage these activities.

The coal is considered beneficial because supply of some of the waste and biomass materials is unreliable, and the quality of the delivered fuel is subject to only limited control. There are risk of the most waste / biomass energy conversion projects, and the co-utilization of coal can be regarded as a means of reducing these risks, in as much as coal supply of a prescribed quality specification is assured in most industrial countries.

In Germany possible types of fuel for coal fired power plants are [4]:

- domestic coal
- imported coal
- equivalent fuels: Petcoke compatible materials (e.g. sludge)
- *substitute fuel*

There are even theories to justify the actual use of substitute fuels. One of the most important theories is based on the energetic efficiency of the waste utilization in power plants. So, if the efficiency of about 35 to 40 % for coal-fired power plants is compared with the situation of common waste incineration plants (10-25 %) (Tab.1.1.), it is even worth while to use smaller quantities of waste derived fuel in power plants.

Tab.1.1: Energy efficiency of power plant and waste incinerator [4]

fuel	coal	waste
Energy recovery		
Electric power	$\eta = 35-45\%$	$\eta = 10-25\%$
Coupling of heat and power	$\eta = \text{ca. } 85\%$	$\eta = \text{ca. } 80\%$
District heating	$\eta = 87\%$	$\eta = 80\%$

There is enough substitute fuel in every country and city. The European Union waste accumulations are 500 million tones per year (tpy) of which 30% is the deal of municipal solid waste. Only 7% of this is incinerated for power production. The potential of substitute fuel in Germany is 400 Mill. t waste per year (in total), as one part of this: 40 Mill. t domestic and similar waste (combustible). 12 Mill. t of this burnt in MSW plant; as another part of this: 90 Mill. t special waste; 10 Mill. t of this is hazardous waste; 3.5 Mio. t (dry matter) of this is sludge also part of this: 0.7 Mill. t meat and bone meal (MBM). Approximately 50 000 t per day domestic, paper and bio wastes are disposed in Munich city [5].

The major gas emissions from incineration of coal and waste are carbon dioxide and water vapor. Wood and municipal waste emit more carbon dioxide than coal during an electricity generation processes, whatever technologies are used. Sulfur removal from coal gas is a relatively a straightforward process. The presence of wood tar and hydrochloric acid from after the incineration further complicates the gas purifying process. Incinerators require high capital costs and trained operators thus making the waste incineration technology much more costly. The calculated investment and operational costs for reduction of dust emissions, CO/NOx, and SO₂ in power plants using coal / waste incineration (Tab.1.2.) are around threefold more expensive than coal power plants (Tab.1.3).

Tab.1.2: Costs for reduction of dust emissions, CO/NO_x, and SO₂ in co-combustion [4]

Novel LCP Order corresponding to workingdraft of June 2002				
Costs with capacity relation calculated from DATA for co-combustion	Invest costs Mio EUR	operation costs Mio EUR/a	impacted capacity, GWth	impacted No. of plants
costs dust emission reduction	204	6,5	92,73	152
costs CO/NO _x emission reduction	478	32,8	33,51	66
costs SO ₂ emission reduction	344	18,7	88,40	142
total costs (without gas turbines):	1026	58,1		
Participation: 45 German VGB members with 253 plants for coal, oil, gas combustion and gas turbines with about 85 % of reported capacity				

Tab.1.3: Costs for reduction of dust emissions, CO/NO_x, and SO₂ in coal / waste combustion [4]

Waste incineration and co-combustion order				
Costs with capacity relation calculated from DATA for co-combustion	Invest costs Mio EUR	operation costs Mio EUR/a	impacted capacity, GWth	impacted No. of plants
costs dust emission reduction	126	4,05	56,518	73
costs CO/NO _x emission reduction	63	4,32	4,196	19
costs SO ₂ emission reduction	82	4,46	20,118	23
total costs:	271	12,83		

However, the above mentioned application of co-combustion of coal with solid waste entails some environmental risk due to the chemical nature of the used fuel. The experience from the operation of such facilities has shown that these installation often do not comply with the emission control regulations. The exhaust gas may contain many potentially harmful substances, including particulate matter; oxides of nitrogen; oxides of sulfur; carbon monoxide; volatile organic compounds, polycyclic aromatic compounds. Some emissions are formed in part by incomplete combustion that may lead to the formation of PCBs and dioxin and furans. These compounds are known as persistent organic pollutants (POPs).

Over the last few years, the control on the release of dioxins in the atmosphere have become more widespread, with an increasing consensus in Europe for an emission limit for the flue gas of 0.1 ng / Nm³ based on the TEQ value (5). The experience shows that for instance the co-combustion of a mixture containing 75% w/w coal and 25% w/w even straw in a 0.5 MWt pilot scale results in dioxin-furan emissions more than 0.25 ng TEQ/Nm³ [6], while the co-combustion of 80% coal-20% sewage sludge in semi-industrial furnace results in dioxin emission level about 0.3ng TEQ/Nm³ [7]. Both values are above current regulation of 0.1 ng TEQ/Nm³.

This thesis is focused on the use of primary measures to minimize the toxic emissions such dioxins, furans, PCBs and PCBz in order to comply with the limit value of 0.1 ng TEQ/Nm³.

2 Objectives

Combustion of organic matter in the presence of chlorine and metals is widely recognized as a major source of PCDD/F in the environment [8]. Waste incineration is one of the main sources of PCDD/F. Hence, the formation of PCDD/F in a waste incinerator is an inevitable process unless chlorine and hydrogen chloride can be completely eliminated, which is impossible in practice [9]. Basic questions regarding PCDD/F formation can be formulated as follows: (i) what is the influence of process parameters such as reagents, surface, chlorine sources, temperature, catalysts, reaction time on their formation, (ii) what reaction mechanisms are involved, (iii) are the corresponding reaction mechanisms thermodynamically or kinetically controlled and (iv) can laboratory-scale experiments explain the formation mechanisms in full-scale incinerators?

As can be seen, PCDD/F formation is a difficult multivariate problem. The presence of PCDD/F in the flue gas of waste incineration were first observed in 1977 [10]. Since that time many researchers have provided a survey on the reaction mechanisms related to dioxin formation but still the relevant reaction pathways are unclear. The PCDD/F minimization during incineration arised other open questions. A comprehensive knowledge of the PCDD/F inhibition strategies is only possible if the the formation mechanisms are known. On the other hand the understanding the PCDD/F minimization provides significant information on the PCDD/F reaction mechanisms.

The motivation behind this work is based on the environmental and economical challenges posed by the combination of coal / waste combustion in power plants. This application entails high PCDD/F emissions due to the chemical nature of the solid waste. Over the last few years, the control over the release of dioxins into the atmosphere has become more widespread which has led to an increasing consensus in Europe for an emission limit in flue gas of 0.1 ng/Nm^3 based on the TEQ value [11]. PCDD/F emissions from flue gas can be controlled by the so called primary and /or secondary measures in order to comply with the limit value of 0.1 ng/Nm^3 TEQ. Secondary measures stress the use of flue gas purifying systems. During their use, toxicologically relevant residues are produced and collected and their disposal can cause further environmental risks. The installation and operating costs of secondary measures are much more expensive than primary measures, and cannot be considered for coal power plants. Primary measures include adjustment of operation

conditions and focus on the additives of selective compounds or inhibitors that can substantially inhibit the formation of PCDD/F. The aim of this work is to identify the most effective inhibitors for PCDD/F with low cost and low toxicity.

During this work the main questions are:

- How is it possible to produce dioxins during combustion in a pilot plant?
- Which operating parameters influence the dioxins formation?
- What type of laboratory scale furnace and incineration procedure is suitable for further inhibitory investigations?
- Which compounds can be used for PCDD/F minimization?
- Are they still effective at lower percentage of the fuel mixture?
- Do the used successful inhibitor survive and retain its dioxins suppression effect also at a higher temperature (1000°C)?

3 State of Knowledge

3.1 PCDD/F, PCB and PCBz

3.1.1. Dioxin nomenclature and properties

The compounds of main interest in this work are PCDD, PCDF, PCB and PCBz:

- Polychlorinated dibenzo-p- dioxins (PCDD)
- Polychlorinated dibenzo-p- furans (PCDF)
- Polychlorinated biphenyls (PCB)
- Polychlorinated benzenes (PCBz)

Polychlorinated dibenzo-p- dioxin (PCDD) and furans (PCDF) are compounds with similar chemical properties. Each compound consists of two benzene rings interconnected by oxygen atoms (Fig.3.1). Polychlorinated biphenyl (PCB) molecules are similar to PCDD and PCDF but the two benzene rings are connected by a direct carbon bond without oxygen atom. Polychlorinated benzene (PCBz) consists of only one benzene ring.

All PCDD and PCDF are organic solids with high melting point and low vapour pressure. They are characterized by extremely low water solubility, and have the ability for being strongly absorbed on the surface of the particulate matter. The water solubility of dioxin and furan decreases and the solubility in organic solvents and fats increases with increasing the chlorine content. Non- and mono-ortho-substituted PCB congeners have a high toxicity, similar to the polychlorinated dibenzo-p-dioxins and polychlorinated dibenzo-p-furans (PCDD/F). Therefore, these dioxins like PCBs are referred to as dioxin-related compounds (Fig. 3.1). These congeners are strongly hydrophobic and thus highly lipophilic.

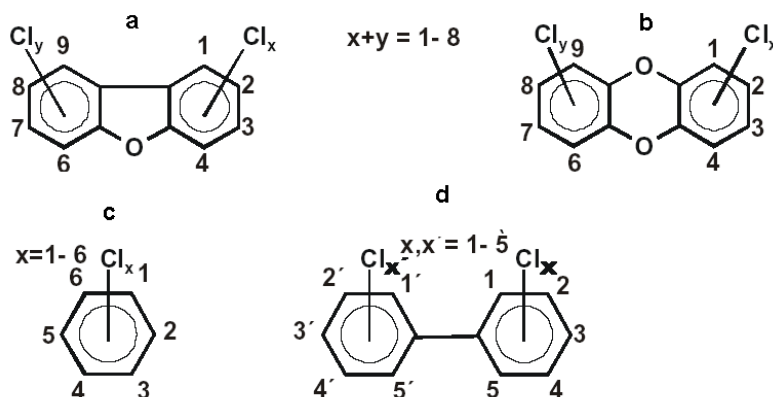

Fig. 3.1: Polychlorinated di-p-benzo-dioxin (a); Polychlorinated di-p-benzo-furan (b); Polychlorinated benzene (c); Polychlorinated biphenyl (d) .

Tab. 3.1: Homologues and congeners of PCDD, PCDF, PCB and PCBz

Homologue	Number of congeners			
	PCDD	PCDF	PCB	PCBz
Monochloro (M)	2	4	3	1
Dichloro (D)	10	16	12	3
Trichloro (Tr)	14	28	24	3
Tetrachloro (T)	22	38	42	3
Pentachloro (Pe)	14	28	46	1
Hexachloro (Hx)	10	16	42	1
Heptachloro (Hp)	2	4	24	-
Octachloro (O)	1	1	12	-
Nonachloro	-	-	3	-
Decachloro	-	-	1	-
Total	75	135	209	12

There are 75 PCDD, 135 PCDF, 209 PCB and 19 PCBz each differing in the number of the position of the chlorine atoms. Each individual PCDD or PCDF is referred to as a congener (giving 210 in total), while group of congeners with the same number of chlorine atoms are called homologues. The number of the congeners in each homologues group is shown in Tab. 3.1.

Often the term “dioxin” means PCDD and PCDF.

PCDD and PCDF congeners with chlorine atoms in position 2, 3, 7, and 8 are of particular concern, especially the tetrachloro-CDD congener 2,3,7,8-TCDD which is

the most toxic dioxin. The toxicity effect of the dioxins present in the emission gases by the so-called “toxic equivalent” or Toxicity Equivalent Factor (TEF) is estimated. It is generally assumed that only 17 of the 210 dioxin and furan congeners and 12 of the 209 PCB congeners are toxic. Since 2,3,7,8-TCDD is the most toxic, its TEF is 1.0. The most toxic PCB congener among the 209 isomers is 3,3',4,4',5-PeCB. If the assigned value of the isomers is converted by the TEF, the final sum is so-called Toxic Equivalent (TEQ). TEQ is individual for each congener. The international values of the TEFs are termed into international toxic equivalent factor, or I-TEFs. The I-TEFs of the seventeen 2,3,7,8-positioned congeners of PCDD and PCDF are present in Tab.3.3. The sum of the individual TEQs for a mixture of PCDD and PCDF is termed the international toxic equivalent or I-TEQ.

$$\sum_{i=1}^n c_i * I-TEF_i = I-TEQ.$$

The recent revision of the TEF scheme was undertaken by the World Health Organization (WHO). The proposed scheme includes coplanar congeners of PCBs by defining TEFs for 12 coplanar PCBs. They are also listed in Tab.3.3.

Tab.3.2: Toxic equivalent factor (I-TEFs)

Congener	I-TEFs	WHO TEF
2,3,7,8-TCDD	1	1
1,2,3,7,8-PeCDD	0.5	1
1,2,3,4,7,8-HxCDD	0.1	0.1
1,2,3,7,8,9-HxCDD	0.1	0.1
1,2,3,6,7,8-HxCDD	0.1	0.1
1,2,3,4,6,7,8-HpCDD	0.01	0.01
OCDD	0.001	0.0001
2,3,7,8-TCDF	0.1	0.1
2,3,4,7,8-PeCDF	0.5	0.5
1,2,3,7,8-PeCDF	0.05	0.05
1,2,3,4,7,8-HxCDF	0.1	0.1
1,2,3,7,8,9-HxCDF	0.1	0.1
1,2,3,6,7,8-HxCDF	0.1	0.1
2,3,4,6,7,8-HxCDF	0.1	0.1
1,2,3,6,7,8-HxCDF	0.1	0.1
2,3,4,6,7,8-HxCDF	0.1	0.1
1,2,3,4,6,7,8-HpCDF	0.01	0.01
1,2,3,4,7,8,9-HpCDF	0.01	0.01
OCDF	0.001	0.0001
3,4,4',5-TCB (#81)	-	0.0001
3,3',4,4'-TCB (#77)	-	0.0001
3,3',4,4',5-PeCB (#126)	-	0.1
3,3',4,4',5,5'-HxCB (#169)	-	0.01
2,3,3',4,4'-PeCB (#105)	-	0.0001
2,3,4,4',5-PeCB (#114)	-	0.0005
2,3',4,4',5-PeCB (#118)	-	0.0001
2',3,4,4',5-PeCB (#123)	-	0.0001
2,3,3',4,4',5-HxCB (#156)	-	0.0005
2,3,3',4,4',5'-HxCB (#157)	-	0.0005
2,3',4,4',5,5'-HxCB (#167)	-	0.00001
2,3,3',4,4',5,5'-HpCB (#189)	-	0.0001

3.1.2. Dioxins and public health

In 1968 it became clear that polychlorinated biphenyls posed serious health risks, when several thousand people in Japan were affected by a strange illness. Many of them exhibited a broad spectrum of symptoms, such as changes of the skin and mucous membranes, dizziness, coughing and damage of the central nervous system. It is known now that the presence of PCB products was the most probable main cause of illness caused by the rice oil disaster in Japan in 1968 (POP, Swedish Environmental Protection Agency).

High concentrations of polychlorinated dibenzo-p-dioxin and furans (PCDD/F) are produced during the waste incineration [1]. The emitted toxic gases disperse into the air and some people close to the facilities may be after either exposed directly through inhalation or indirectly through consumption of food and water contaminated by deposition of the pollutants from air in soil, vegetables and water. According to the report released for public comment in 1994 by United State Environmental Protection Agency (EPA) dioxin is a cancer hazard for the people and the exposure to dioxin can cause reproductive problems; dioxin can cause immune system damage and interfere with regulatory hormones as well [12] [13]. In humans, dioxins have a half-life of about 7 years.

3.1.3. Dioxin emission sources

Many natural sources can release dioxins. For instance, before the large-scale manufacturing and the use of chlorinated chemicals began, biological formation of PCDD and PCDF in sediments and solid, especially forest soils, had been observed. Öberg and co-workers [14] and [15] have been noted the potential of natural formation of PCDD/F in sewage sludge under normal environmental conditions. Anyway the man-made sources of PCDD/F are dominant and can be divided into a number of main categories: waste incineration, combustion of fuel in stationary sources, chemical waste, crematories, paper production, forest fires and agricultural burning.

Waste incinerators were the main sources of dioxin in emissions. These include waste incinerators such as MSW, sewage sludge, medical waste and hazardous waste burning of various fuels, such as coal, wood, and crude oil products. By the end of 1978, Dow Chemical scientists announced that chlorinated dibenzodioxins were found in all particulates collected inside and close to combustion facilities [16].

Dioxins were detected in fly ash from municipal and industrial incinerators [17] [18] [19] [20], city dust, in commercial sludge fertilizer, as well as in the cigarette smoke and soot from home fire places [21]. There are roughly 3 000 incinerators in Japan of which 960g-TEQ/year dioxins came from the industrial waste incinerators [22]. The substance flow of Co-PCBs show that the TEQ amount of Co-PCBs released from MSW incineration facilities is higher than the input amount. Some congeners such as No. 126 and No. 169 drastically increase the ratio of output to input amounts [23]. Due that fact the Japanese government established a Guideline for Controlling PCDD/PCDFs on MSW Management [24]. Approximately eight thousand tons of PCBs were produced in China during 1960's and 1970' due to municipal waste incinerators [25].

Over the last decade, the amount of waste generated by hospitals has increased. Around 465 000 tons of biohazardous waste such as “hospital wastes”, “medical wastes”, and “infection wastes” is generated in the United States each year by 377 000 healthcare facilities [26]. In the recent years, many hospitals stopped operating their incinerators because the units were old and had no emission control systems.

PCDD/F can be performed during various types of steel production and scrap metal recovery. The calculated WHO-PCBs amount in eight industrial plants and crematories have been measured by Luthardt et.al. [17]. In the secondary aluminium melting processes, aluminum scrap, to which organic materials are attached, is melted together with salt at temperature of approximately 700-800°C. These conditions are favorable for PCDD/F formation [27].

3.2. Formation of Dioxins

Incomplete combustion of organic matter in combustion chambers leads to the formation of organic fragments, commonly organic precursors to dioxin/dibenzofuran molecule. They are easily adsorbed onto the surface of the fly ash in the post combustion zone, and following a complex series of reactions which are catalysed by metals (mainly copper) in the fly ash, leading to the formation of PCDD/PCDF along the other chlorinated trace organics.

Chlorinated pollutants like chlorinated benzenes (PCBz), phenols (PCPh), biphenyls (PCB) and dibenzo-dioxins and -furans (PCDD/F) are formed in many incineration processes like municipal waste incinerators. As the flue gases leave the primary combustion chamber, these compounds are cooled down from 1000°C to 650-250°C and subsequently condense. As a result during different molecular rearrangements

the PCDD/F are formed. Many hypothesis and much data have been gathered about their formation in combustion processes. Theoretical calculations have shown that these compounds are formed through heterogeneous mechanisms by surface catalysed processes rather than via homogeneous gas phase reactions [28].

Two pathways have been proposed so far to explain the formation of PCDD/F during incinerations: (i) *de novo* synthesis where carbon, chlorine and hydrogen in fly ash somehow react in the presence of the gas-phase oxygen to form chlorinated aromatic compounds such as PCDD/F and (ii) through various precursors, such as chlorophenols which can be formed in the gas phase during incomplete combustion and further combined in a heterogeneous way and catalytic reactions with the fly ash surface [9].

3.2.1. *De novo synthesis*

The name of *de novo* theory of thermal dioxin formation is known as incineration process where the flue gases are quickly cooled down to 250-450°C and the carbon source form new organic chemical compounds including dioxins. The elemental carbon can have different modifications including different functional groups. The laboratory experiments show that coal, soot, graphite, active carbon and different PAHs under equal conditions (temperature, catalyst, atmosphere) enable PCDD/F formation [29].

The mechanism of the *de novo* reaction is widely discussed, especially by Stieglitz and coworkers [30] [31] [1] [32] [33] who proposed copper as a catalyst and also worked with a “model fly ash”. They postulated partly oxidation and chlorination of the carbon skeleton which results in dioxins formation by direct and indirect pathways.

The *de novo* synthesis of dioxins occurs essentially in a process of partial oxidation and partial chlorination of the carbon matrix. According to the second indirect pathway of *de novo* synthesis the major products are CO and CO₂ and some aliphatic compounds which via condensation processes form a variety of organic compounds including PCDD, PCDF, PCBz, PCPh and PCB.

Copper chlorides have been shown to play a predominant role in surface-catalysed chlorination reactions [34] [35] [36]. The main thermal pathway of chlorinated dibenzodioxins and furans have been discovered in laboratory studies. The experiments indicate that the common form of copper in a combustion system is cupric oxide which can catalyse acetylene in the presence of HCl. This reaction occur

In the further steps Cl_2 produced chlorinates aromatic ring structures through electrophilic substitution reactions. The carbon source is derived from unburnt particular matter reacting with O_2 and Cl_2 to form PCDD and PCDF. Many copper catalysts (Cu, CuCl, CuCl_2 , CuO, Cu_2O and CuSO_4) can promote this reaction, whereas Fe-based catalysts are found to be not active in the Deacon process [9].

Milligan and Altwicker observed the de novo synthesis at time scale of 5, 20 and 30 min [39]. They noticed that the amount of PCDD/F formed during the de novo synthesis is linear with respect to the reaction time. Blaha and Hagenmaier [40] tested a model fly ash and discovered that de novo synthesis can take place at a time scale as short as 1 min. Based on these investigations and the experience of the other researchers, Huang proposed a kinetic model of de novo synthesis [41]. When this model is applied to industrial incineration conditions, PCDD/F formation level in the gas phase and solid phase is in a good agreement with incinerator measurements.

The condition of *de novo* synthesis of dioxins to occur is the presence of carbon together with oxygen and minute quantities of chlorine and metal ions at 250-400°C.

3.2.2. Synthesis from precursors

The precursor theory is supported by the existence of a relationship between the concentration of chlorobenzenes and chlorophenols with the concentration of PCDD/F in the flue gas. Chlorophenol is converted to PCDD by the Ulmann type II reaction, via a double cyclization process [42]. This reaction occurs as a heterogeneous process on the surface of copper species which are present in nearly all kinds of fly ash. Various chlorophenols have been shown to be precursors of PCDD/F in laboratory experiments. Karasek and Dickson used 3,4,5-trichlorophenol and pentachlorophenol in their classical experiment using a fixed bed reactor [43]. Various chlorophenols show a similar reactivity but with some small differences e.g. tetrachlorophenol is more reactive than pentachlorophenol by a factor of 4 the same condition [36]. Altwicker in his study has shown that 2,3,4,6-tetrachlorophenol forms PCDD more rapidly than either penta- or tri-chlorophenol [44]. Hell has shown also that formation of PCDD is possible via condensation reactions of gaseous 2,4,6-trichlorophenol and 2,3,4,6-tetrachlorophenol [45]. Chlorobenzenes are the major products among the chlorinated organic compounds derived from 2,4,5-trichlorophenol with lesser quantities of PCDD and PCDF.

at temperatures between 300-500°C. Lenoir et. al. proposed a reaction mechanism for formation of the observed chloroaliphatic and chloroaromatic compounds involving metallacyclization reactions [37].

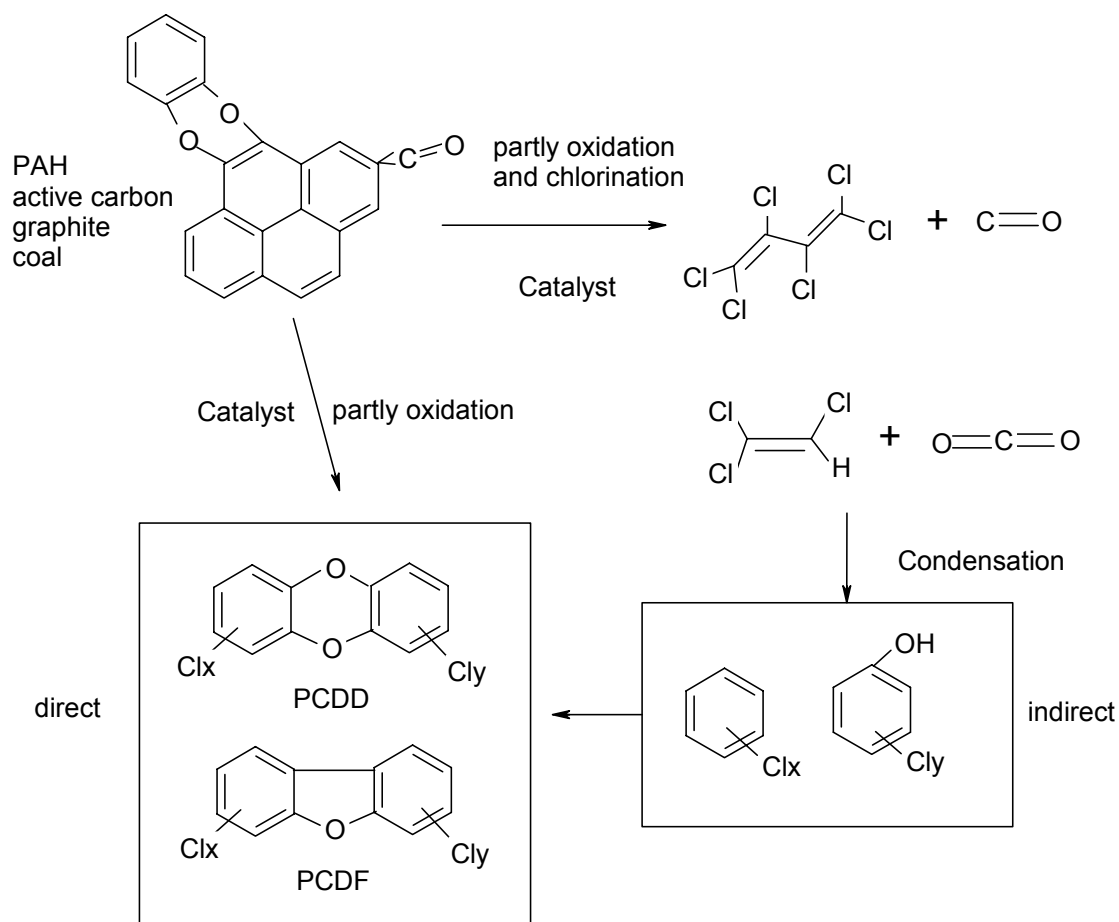

Fig. 3.2: De novo synthesis of PCDD/F

By this mechanism with the help of CuCl_2 acetylene is converted into dichloroacetylene. The experimental results also demonstrate that dichloroacetylene is an important precursor in surface-catalyzed chlorination and molecular growth of acetylenic compounds. This mechanism provides a tool toward the PCDD/F formation.

Laboratory experiments have successfully produced PCDD and PCDF through simulating postfurnace conditions of municipal waste combustors [38]. Theory shows that this PCDD/F formation occur due to *de novo* synthesis from compounds within the flue gas and fly ash. This synthesis involves the Deacon process reaction:

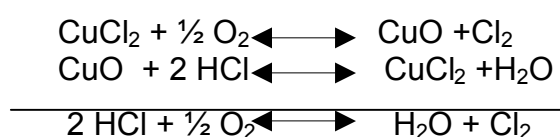

Fig.3.3: Deacon reaction

Ortho-chlorophenol and chlorobenzene by ethersynthesis and Ullmann reaction are involved in PCDF synthesis (Fig. 3.4.). The classical Ullmann reaction, the copper catalyst and the aryl radicals form the aryl-copper complex. In the subsequent steps this complex is converted into biaryl. The experiments with 1,2,4,5-tetrachlorobenzene (10% O₂, 300°C) and tetrachlorophenol yield PCDD/F with typical PCDD/PCDF ratio 20-40.

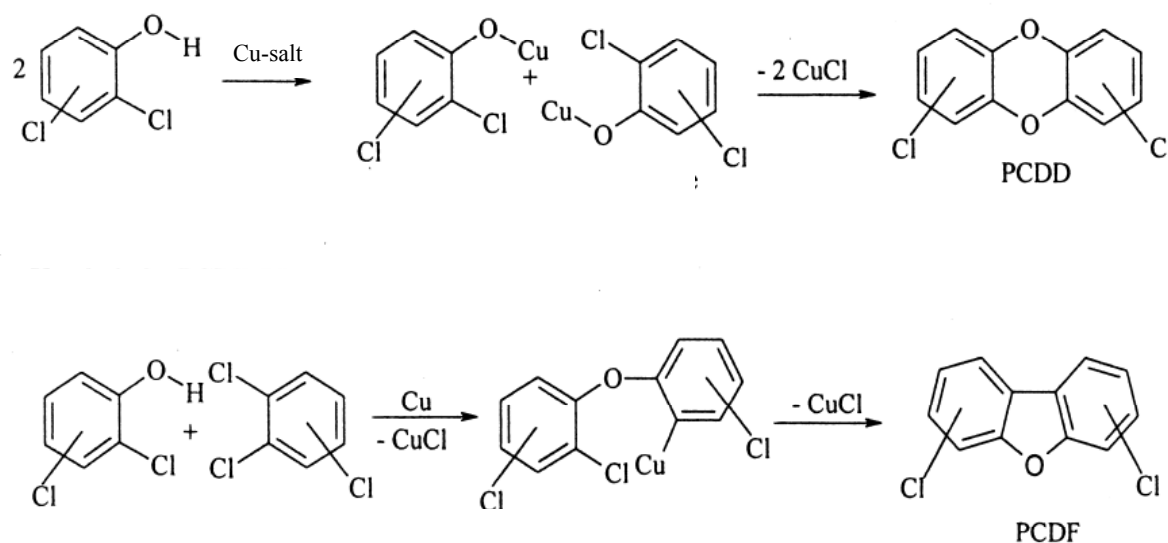

Fig.3.4: Copper catalysed formation of PCDD/F from ortho- chlorophenol and chlorobenzene

After considering the results obtained from the experiments it turns out that chlorobenzenes are far less reactive precursors [44]. Alternatively, Pschorr-type ring closure (Fig. 3.5.) of the 2-phenoxybenzene diazonium cation with various catalysts provides an effective method for the formation of dibenzofurans. That Pschorr-type mechanism could be also applied to PCDDs.

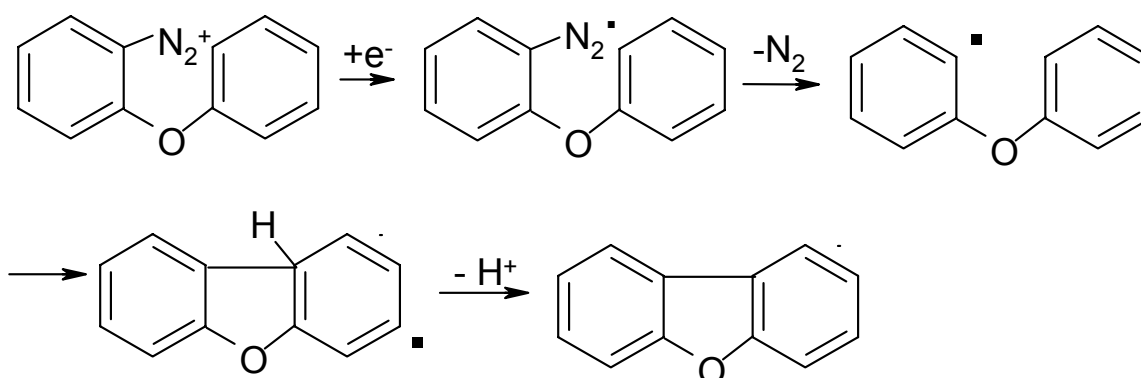

Fig. 3.5: Formation of PCDFs via Pschorr-type ring closure

Comparing de novo synthesis with precursor formation Huang has summarised [29] :

- The rate of dioxin formation in the precursor theory is several orders of magnitudes higher than that in *de novo* synthesis.
- The typical homologue profile during *de novo* synthesis can produce furan/dioxin ratio >1. But in precursor formation less furans are formed and the furan/dioxin ratio is much smaller than 1.
- From *de novo* synthesis the actual incineration data show typical decrease order of PCBz > PCPh > PCDF > PCDD > PCB.

The above mentioned evidence suggests that *de novo* synthesis is the dominant mechanism of dioxin formation in the real combustion processes. Taking into account the basic chemistry the precursor formation pathway is much easier than *de novo* synthesis. However in actual combustion systems dioxin formation from precursors is limited. On the other hand the starting material for *de novo* synthesis, O₂ and carbon in fly ash, is relatively abundant.

3.2.3. Influence of the operation parameters and the fuel type on PCDD/F emissions

The knowledge on the effect of the different experimental parameters is important for the understanding of the mechanisms of PCDD/F formation and for elaborating a method to control these parameters. Often statistical analysis is used in order to calculate the role and importance of some parameters for PCDD, PCDF, PCB and PCBz formation.

De novo formation of PCDD and PCDF has been investigated in an Entrained Flow Reactor (EFR) to simulate combustion conditions [46]. The comprehensive data is further evaluated with PCA. The amount of Cl₂ in the gas phase is considered as an important parameter for the PCDF formation; on the other hand the levels of O₂ are not found to be a significant PCDF rate controlling parameter. Overall the most significant parameter for the rate of both PCDD and PCDF formation has been revealed to be the reaction time. A maximum formation rate is observed between 300-400°C for PCDD and 400-500°C for the PCDF. The correlation between the CO and O₂ concentration and the PCDD/F emissions have been studied in a fluidised bed incinerator [47]. Under conditions of incomplete combustion, CO concentration is positively and O₂ is negatively correlated with the total PCDD/F emissions. Adding of only 3% PVC to the fuel results in an increase in PCDD/F concentrations. It was observed that dioxins amount did not depend of the HCl concentration and the high water content. However Takashita has reported in his work that HCl concentration

level in flue gas is very effective in the control of PCDD/F formation [48]. Gullett has proved statistically that both higher HCl and sulfur dioxide concentrations favor a higher relative formation of the lower chlorinated PCDF homologues [49]. Increased SO₂ resulted in significant larger fraction of MCDF due to a leftward shift in the homologue profile. The role of SO₂ is proposed to prevent the molecular chlorination or encourage dechlorination processes. Shifts in homologue profiles due to changes in HCl concentration demonstrated conditions in which the proportion of DiCDF and TrCDF is significantly increased.

A laboratory-scale-fluidised –bed incinerator has been used to study the influence of several combustion parameters [50]. The most important parameter has been reported to be the residence time in the post combustion zone. Blumenstock proposed that non-optimal combustion conditions resulted in increased concentrations of mono-to trichlorinated PCDD, PCDF and PAH, while PCBz and PCB and higher chlorinated PCDD/F are only weakly affected or even decreased [51]. Reaction time is positively correlated to concentration of precursors.

The function of chlorine in the formation of PCDD/F, PCB and PCBz has been widely investigated by many authors. Wikström et.al. [52] found a good correlation between the total chlorine content in the fuel and the formation of the hepta- and octa-chlorinated PCDD/F homologues. The effect of inorganic and organic chlorine in the fuel mixture has been also studied by Halonen [53], [54]. The laboratory plant experiments have shown that organic chlorine promote the particle-bound PCDD/F formation whereas inorganic chlorine has been observed to be more effective on PCDD/F formation in the gas–phase. Comparing the organic chlorine source such as tetrachloroethylene (C₂Cl₄) and inorganic chlorine such as sodium chloride (NaCl) it has found that more highly substituted PCDD/F congeners were detected when organic chlorine is the additive to the fuel.

Wang elaborated a organic chlorine content threshold value of 0.8-1.1% which can strongly relate to the mechanism of PCDD/F formation [55]. In the same study it was calculated that if chlorine level in the waste of the MSW incinerators exceeds this threshold, the rate of PCDDF formation is quickly increased. However if the chlorine level is below that threshold the PCDD are dominating.

The influence of metal oxides (CdO, CuO, Fe₂O₃, PbO, MoO₃, ZnO) on the formation and the distribution behaviour of PCDD/F during simulated fire was investigated in a laboratory scale incinerator [56]. It was found that adding a mixture of metal oxides

resulted in an increase of PCDD by factor 14 and PCDF by factor 7 whereas the PCDF amount was increased 17 times.

3.3. Correlation between PCDD/F , PCB and PCBz

The routine measurements of PCDD/Fs are difficult and expensive. As a consequence, there is a growing tendency to find surrogates of PCDD/Fs. Based on this knowledge the exact reaction mechanisms can be developed in order to characterize PCDD/F emissions from combustion processes and their effective inhibition techniques as a primary goal. In particular chlorobenzenes have attracted much attention because of their good correlation with PCDD/F I-TEQ value [57], [58], [59], [60], [61], [62], [63].

PCBz is present in incinerator emissions at much higher concentrations than PCDD/F [50]. Among the PCBz, either pentachlorobenzene or hexachlorobenzene [61], [63] are the dominating congeners. I-TE and PCDD/F concentrations are most accurately predicted from the concentrations of pentachlorobenzene [62]. However, Öberg proposed hexachlorobenzene as an indicator of dioxin production [61]. Some lower chlorinated PCDD, PCDF, PCPh and PCBz were identified as a surrogate for the toxicity carried by the PCDD/F in the flue gas at hazardous waste incinerator (HWI) plants [60]. The most promising candidates for an easily accessible compound group of I-TEQ surrogates at the HWI plant are the chlorinated benzenes. 2,3,7,8-tetrachlorodibenzodioxin was closely correlated with the concentrations of pentachlorophenol, pentachlorobenzene and hexachlorobenzene in the flue gas of three waste incinerators. The proposed correlation is valid for all sampling points of the waste incinerators including the dry EST and wet scrubber where the I-TE values are much lower. Furthermore Blumenstock found that all isomers of PCBz which are good surrogates for the emissions of the I-TEQ in the flue gas show similar correlation coefficient values also in the stack gas [57]. However, only few higher chlorinated phenols (trichlorophenols and higher) are found with a high I-TEQ correlation in the stack gas. Further, the flue gas purifying system of the plant influences the PCPh isomers pattern in the stack gas dramatically.

A recent study suggest that the measurement of PCPh in waste incineration flue gases, combined with multivariate statistics, could be used as a surrogate for assessment of PCDD/F emissions [64]. The partial least squares (PLS) results indicate that almost all of the PCPh isomers are correlated either fairly with PCDD or

closely with PCDF in the gas phase, but only certain isomers, particularly 2,3,4,6-, and penta – CPh, are of importance in the particle phase.

Concentrations of selected mono-to tri-CDD/CDF congeners show promising correlations with CDD/CDF TEQ values [65]. According to these results the monitoring of these congeners may be used to observe flue gas concentrations for calculation of TEQ emissions.

The correlation between PCDD/F and PCB is not so widely investigated as other indicator parameters such as PCBz and PCPh. On the other hand the correlation between the PCB and PCDD/F is important in order to understand the mechanisms of PCDD/F formation. It is already known that PCB molecules are also precursors of PCDD/F formation [36], [9]. Using Principal Component Analysis Fängmark et.al. reported a positive correlation among PCDD/F and the three planar PCB analysed [50]. Blumenstock has suggested that the formation of PCB seems to be different from the other chlorinated aromatics, which may be hind of different formation mechanisms of PCDD/F and PCB. Investigations at a hazardous waste incinerators by Kaune et. al. [62], for example, pointed out that some PCBs are good indicators for I-TEQ values.

The first relationship of PCDD/F on chlorobenzenes in emissions has reported by Oehme et. al. [63] using linear regression techniques. To improve the accuracy of the prediction, multiple regression [66] and PLS [67] were used. Multiple regression may improve the accuracy of estimating PCDD/F and I-TEQ values from indicator parameters but has the draw back that many parameters rather than a single one must be measured. That is why, these methods do not make use of the advantages of the indicator parameter concept. Statistical analysis of the results is useful, if performed in order to determine whether there exist a relationship between the investigated compounds [51], [65], [67]. The present study is based also on statistical analysis like Correspondent Analysis (CA) and is focused on linear regression equations with one independent variable to study the dependence of I-TE on the indicator parameters.

3.4. Dioxin Minimization

Technical incineration processes are the major a source of potential emissions of hazardous substances into the environment. Two approaches have been developed for the control of PCDD/F emissions to the environment. PCDD/F emissions from flue gas can be controlled by the so called secondary and /or primary measures in order

to comply with the limit value of 0.1 ng/m^3 TEQ. Secondary measures belong to the “end pipe” treatments of emissions. The so-called secondary measures is focused on the removal of PCDD/F from flue gas after their formation by means of gas cleaning devices. Upon their use, toxicologically relevant residues are produced and collected and their disposal can cause further environmental risks. The installation and operating costs of secondary measures are expensive and cannot easily and economically be considered for coal power plants. The second approach, the so-called primary measures, includes an adjustment of the operation conditions (temperature, turbulence, air flow, residence time) and focus on the additives of selective compounds or inhibitors that can inhibit the formation of PCDD/F substantially in the combustion process [47] [50]. The influence of parameters such as water, carbon monoxide, and carbon dioxide; amount of gas-phase chlorine; reaction temperature; and reaction time in the flue gas has been investigated [46].

3.4.1. Secondary Measures

The cleaning devices which are commonly equipped in MSW incinerators are [68]:
Electrostatic precipitator (ESP) – collect and control particulate matter that evolves during combustion, by introducing a strong electric field in the flue gas stream. This in turn charges the particles entrained in the combustion gases. Large collection plates receive an opposite charge to attract and collect the particles.

Selective catalytic reduction (SCR) – Catalysts employed for the SCR of NO_x emissions also demonstrate the ability to decompose organohalogenic compounds, including PCDD/Fs.

Fabric Filter (FF) – control device made from woven fibreglass material which remove dioxins associated with particles and any vapours that adsorb to the particles

Dry Scrubber (DS) – involved both the removal of acid gas and particulate matter from post-combustion gases

Wet scrubber (WS) – device designed for acid gas removal; consist of a two- stage scrubber, first removes HCl and afterwards removes SO₂. This technique is more common to MSWI in Europe than in the United States.

End-of-pipe treatment – An effective of end-of-pipe treatment is the combination of a scrubber, a bag filter coupled with an active carbon injection in the bag filter. The carbon can be burnt in the incinerator to destroy the PCDD/F and heavy volatilised metals will be removed in the scrubber.

The presented data of the thermal waste treatment plants of modern MSWI in Bavaria show very high removal efficiency for PCDD/F by active carbon sorption at fabric filter and less effective removal for PCB and PAH [69]. Fabric filter cleaning system is also successfully used by the Belgium IVRO MSWI [70]. Chlorobenzenes removal from fly ash of MSWI in Japan is effectively removed to 49% during surfactant-assisted column flotation process [71]. The data of other Japanese MSWIs proposed that wet scrubbers influence on minimizing the memory effect of chlorinated aromatic compounds due to the changed PCDD/F homologue profiles at outlet gas of WS [72].

3.4.2. Primary Measures

3.4.2.1. Minimization of dioxins formation by adjustment of the operation conditions.

The following conditions can be considered as guidelines for the best operating procedure [68]:

- Combustion temperature - The major source for PCDD/F formation is due to residues present from incomplete combustion. It is generally considered that at a temperature above 850°C any dioxins in the feed will be destroyed.
- Residence time – Sufficient residence time is recommendable in order to ensure complete combustion of the fuel. At 850°C, a gas residence time in the combustion zone should be greater than 2 s.
- Excess oxygen –To ensure further the complete destruction in the hot flue gas is a recommended at 3 - 6 % (v/v) excess oxygen level.
- Turbulence in the combustion chamber – A Reynolds number greater than 10,000 is recommended.
- Flue gas monitoring – Continuous analysis of oxygen, SO_x, NO_x, HCl, CO and CO₂ should be implemented. Deviations from the specific criteria levels will lead to an automatic shutdown of the MSW feedstock. In most countries, MSW incinerators are required to have on-line continuous analysis of the emission components.
- Optimum size of MSW incineration plant - Based on the data in literature MSW incinerator operate most effectively and with minimum PCDD/F formation in the range of through-puts from 350 to 400 Mg/h.

These approaches have been successfully applied to prevent emissions of PCDD/F and co-planar PCB in crematories in Japan [73]. The factors are listed below:

- The temperature at 800°C is kept in main/secondary chamber during the whole cremation;
- Connecting one secondary chamber to one main chamber;
- Installation of high efficiency dust collector.

3.4.2.2. Use of additives inhibiting the PCDD/F formation

- Alkaline and metal compounds

In recent years many additives for PCDD/F reduction have been investigated in emission gases during incinerations. Some of these compounds are NH_3 , CaO , KOH , Al_2O_3 , and Na_2CO_3 [74] [75]. These compounds are alkaline and their mechanism can be explained by a change in the acidity of the fly ash [76], which can lead to destruction of aromatic bound chlorine by elimination reactions. CaO mixed with the fuel material reduce the emissions of chlorinated hydrocarbons by a factor of > 200 compared to the experiments without any inhibitors. The results indicate that CaO acts preliminary as a HCl adsorber. Similar effects are also observed for KOH and Na_2CO_3 . However, the mixture of Al_2O_3 and the fuel material increases the amount of chlorinated hydrocarbons formed. The use of $\text{Ca}(\text{OH})_2$ spray in incinerators is suggested to result in dechlorination and destruction of PCDD, PCDF and PCB compounds [77]. The suppressing effect of CaCO_3 on the dioxin emissions from PVC laboratory incineration is additionally discussed [78]. The results obtained by the use of CaCO_3 indicate that approximately half of HCl gases are removed and the dioxin formation in exhaust gas is significantly suppressed. The waste material from the CaCl_2 manufacturing process, in which the oxides of Ca , Mg , Si and Fe are involved is tested for the fixation of HCl in it [79]. It has been found that the waste introduced in to the incinerator effectively decreases the amount of HCl by which the formation of dioxin is highly suppressed.

The metal oxide catalysts have commonly been loaded on various supports to increase the dispersion. Titanium is well-known for the strong metal-support interaction. Recently, vanadium-based commercial catalysts designed for the NO_x removal by SCR have been proposed as an active catalyst for the destruction of PCBz and PCDD/F emissions [80]. Thus, supported transition metal oxides and vanadium-containing multi-metallic oxides were investigated for catalytic destruction of PCDD/F. Among the test catalysts, $\text{V-Mo-Ox} / \text{TiO}_2$ catalyst have shown a good activity for oxidation of PCDD/F in flue gas emitted from municipal solid waste

incineration [80]. It has been shown that mixed oxide catalysts based on $\text{TiO}_2/\text{V}_2\text{O}_5/\text{WO}_3$ lead to the destruction of chlorinated aromatic compounds, such as monochloro-, 1,2-dichloro-, and 1,2,4-trichlorobenzene in a laboratory-scale fixed bed reactor and a waste incineration plant [81]. The catalytic oxidation of 1,2-dichlorobenzene has been investigated over a series of transition metal oxides (i.e. Cr_2O_3 , V_2O_5 , MoO_3 , Fe_2O_3 and Co_3O_4) supported on TiO_2 and Al_2O_3 [82]. Cr_2O_3 - and V_2O_5 -based catalysts are present as the most effective ones. Chromium oxide catalyst supported on TiO_2 and Al_2O_3 are also examined in a fixed-bed flow reactor system. In a pilot plant study, the catalysts revealed 93-95% decomposition of the total PCDD/F emission [83]. In addition it is found that $\text{Au-V}_2\text{O}_5/\text{TiO}_2$ and $\text{Au-V}_2\text{O}_5/\text{ZrO}_2$ catalysts are very active in the complete oxidation of benzene [84].

- Nitrogen compounds

Based on the idea to block the catalytic active sites of copper species many researcher have used nitrogen compounds like amines or alkanolamines as inhibitors in order to reduce the PCDD/F emissions [37], [85], [42], [86], [87]. A significant reduction of PCDD/F concentration is observed in the fly ash of the incinerator when 10% amine mixture is sprayed into the post-combustion zone at about 400°C [88]. It has been shown by spectroscopy that deactivation of copper species by amines is achieved by formation of nitrides on the surface of this metal. Further the active sites of the catalyst are blocked by the adsorbed ethanolamine, which is involved in dehydroamination reaction that are favored on the catalyst [42]. Organic amines like ethanolamine, triethanolamine and monoethanolamine are successfully used to prevent the formation of PCDD/F from pentachlorophenol on fly ash [85] [87]. Dickson commented that the inhibition of catalytic activity could be a result of several processes: formation of stable, inactive compounds with the surface active sites; formation of strong bonded organometallic complexes; physical adsorption on the active sites by the inhibitor. However, the laboratory experiments using triethanolamine indicated that the inhibitory effect on the fly ash samples varies from sample to sample. Ethylenediaminetetraacetic acid (EDTA) and nitrilotriacetic acid have been used as inhibitors in a laboratory scale furnace [76]. Both compounds show reduction of the degree of chlorination of PCDD and nitrilotriacetic acid has been proposed for use in the post-combustion zone of incinerators.

Urea and sodiumammoniumhydrogenphosphate dissolved in a water-methanol solvent have been also investigated as inhibitors for PCDD/F reduction. These

substances are injected into the flue gas stream and cause reductions of PCDD/F in the particle-phase of up to 90% with sodiumammoniumhydrogenphosphate and 70% with urea [89]. Among the nitrogen-containing compounds, urea has been examined by several research teams for its PCDD/F inhibiting ability [85], [90]. Ruokojärvi mentioned that the addition of small particles urea promoted greater inhibitory effect on PCDD/F concentrations due to their large surface area [91]. A possible explanation for the inhibitory effect of the nitrogen compounds according Ruokojärvi is based on the presence of a lone pair of electrons of these compounds which can form stable complexes with the catalysing transition metals [92], [89]. Based on laboratory scale experiments and statistical evaluation the use of urea is discussed as an innovative, effective and low cost prevention technique of PCDD/F formation [93].

In most of the studies presented above, the experiments are performed under laboratory scale conditions. However, in full-scale studies the PCDD/F inhibition will be affected by several operation factors such as location and temperature of the inhibitor injection. In addition, the unadsorbed / unreacted inhibitors present in flue gas could also cause problems [94]. Furthermore, the introduction of organic compounds in the post-combustion zone could result in high CO concentration in the stack gas. Preliminary studies on this inhibition technique showed the difficulties and the problems of this method [88].

- Sulfur compounds

Other inhibitors have the ability to complex with or bind to metal ions, which catalyses the PCDD/F formation. The experimental results suggest that the reaction of Cu (II) with SO₂ to form CuSO₄ in the presence of oxygen renders the catalyst less active and leads to decreasing PCDD formation. Inactivity is also due to the reduced ability of Cu (II) and Cu (I) species to promote a second catalytic step of biaryl synthesis [38].

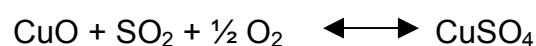

Since Cl₂ has higher reactivity the reaction with aromatic compounds results in dioxin formation. Thus, the most effective procedure is to control this reaction in order to reduce the dioxin formation. Therefore, sulfur containing substance is converted into SO₂ and reduces Cl₂ to HCl according to the following reaction:



Another possibility is, that the presence of SO_2 gas affect the PCDD and PCDF mechanisms by either sulfonating the phenolic precursors or replacing the oxygen link(s) with S and forming polychlorodibenzo-thiophene (PCDT) and polychlorothianthrenes (PCTA) which are the sulfur analogs of PCDD and PCDF.

The influence of different amount of sulfur on fly ash, added before thermal treatment is discussed [95]. It has been found that increasing amount of sulfur reduces the formation of PCBz, especially the Cl_2 - and Cl_3 -isomers. In contrast, the formation of PCDD is preferred compared to that of PCDF due to their formation via different precursors. The addition of sulfur to the fly ash leads to increasing the amount of chlorinated thiophene, benzothiophenes and dibenzothiophenes. This indicates that intermediate aromatic and aliphatic structures with carbon-chlorine bonds may react with sulfur under dimerization and cyclization. With increasing content of sulfur in fly ash, a shift on the formation of higher chlorinated de-novo products is observed.

Dioxin reduction tests by sulfur component addition were carried out using small scale fluidised bed combustor system [96]. Dioxin reduction occurred for each test where gaseous SO_2 was added. However, the effect of coal addition to the test fuel was observed greater than in case of gaseous SO_2 addition. Coal and pure sulfur added to the fuel showed the much greater effect on dioxin reduction. Ogawa found also a negative correlations of S/Cl ratio in coal to dioxin concentration. Gullett proposed that low PCDD and PCDF emission level in coal combustion is due to the relatively lower concentration of Cu found in coal compared to municipal waste [38].

- Nitrogen and Sulfur Compounds

Urea and some sulfur and nitrogen compounds such as hydroxylamine-O-sulfonic acid, amidosulfonic acid, sulfur and sulfamide have been successfully used as inhibitors in a laboratory-scale experiment with a refuse-derived fuel [97] [93]. In all cases where an inhibitor has been added to the fuel, relative increase of the octachlorinated homologues has been observed. Significant PCDD/F reduction about 96% has been reported during the combustion of mixtures containing 1% amidosulfonic acid used as additives. Inhibition of PCDD/F has been investigated under laboratory condition by addition of nitrogen and sulfur compounds such as ethylenediaminetetraacetic acid (EDTA), nitrilotriacetic acid (NTA) and Na_2S [76].

With these compounds, a reduction in PCDD/F formation of 80-90% has been achieved. EDTA and Na₂S reduce the degree of chlorination of PCDD; for PCDF, the same effect has been seen with Na₂S.

4. Materials and Methods

4.1. Pilot Scale Experiments

Emissions of polychlorinated dibenzo-p-dioxins (PCDD) and polychlorinated dibenzofurans (PCDF) are sampled isokinetically with automatic sampling system MRU 4000, according to VDI guidelines 4220 and ISO/IES 17025 [98], [99]. The sampling error can be reduced by using an automatic sampling system, especially for processes with fluctuations in the volumetric flow rate of exhaust gases and dust as well as soot gases.

Isokinetic condition means that the velocity of the sampled gas is equal to the velocity of the exhaust gas in the duct [100].

$$v_{duct} \approx v_{sample}$$

Symbols used:

A	=	area of effective nozzle diameter	(m ²)
ρ_n	=	density of dry flue gas under standard conditions	(kg/m ³)
$\rho_{n,i}$	=	density of a gas component under standard conditions	(kg/m ³)
ω_i	=	volume part of a gas component	(Vol %)
$M_{r,i}$	=	relative molecular weight of a gas component	(kmol/kg)
$V_{mn,i}$	=	molar standard volume	(m ³ /kmol)
$\rho_{n,f}$	=	density of flue gas including water vapor under standard conditions	(kg/m ³)
f_n	=	humidity of the exhaust gas	(kg/m ³)
$\rho_{n,w}$	=	standard density of water	(kg/m ³)
$\rho_{pt,f}$	=	density of flue gas	(kg/m ³)
p_{atm}	=	pressure in the ambient air	(hPa)
p_{st}	=	static pressure in the duct	(hPa)
T_d	=	temperature in the duct	(K)
v	=	velocity of the gas	(m/s)
p_{dyn}	=	dynamic pressure in the duct	(hPa)
V_c	=	calculated standard sample gas flow rate	(m ³ /h)
V_n	=	measured standard sample gas flow rate	(m ³ /h)

d = diameter of the nozzle (m)
 j = number of data

4.1.1. Sampling Equipment MRU 4000

PCDD/F isokinetic sampling is “the cooled suction tube probe method” according to DIN EN 1948-1. The used automatic sampling system is MRU 4000 of GSM, Neuss, Germany (formally Ströhlein company). The sucking device is connected to this arrangement (Fig. 4.1).

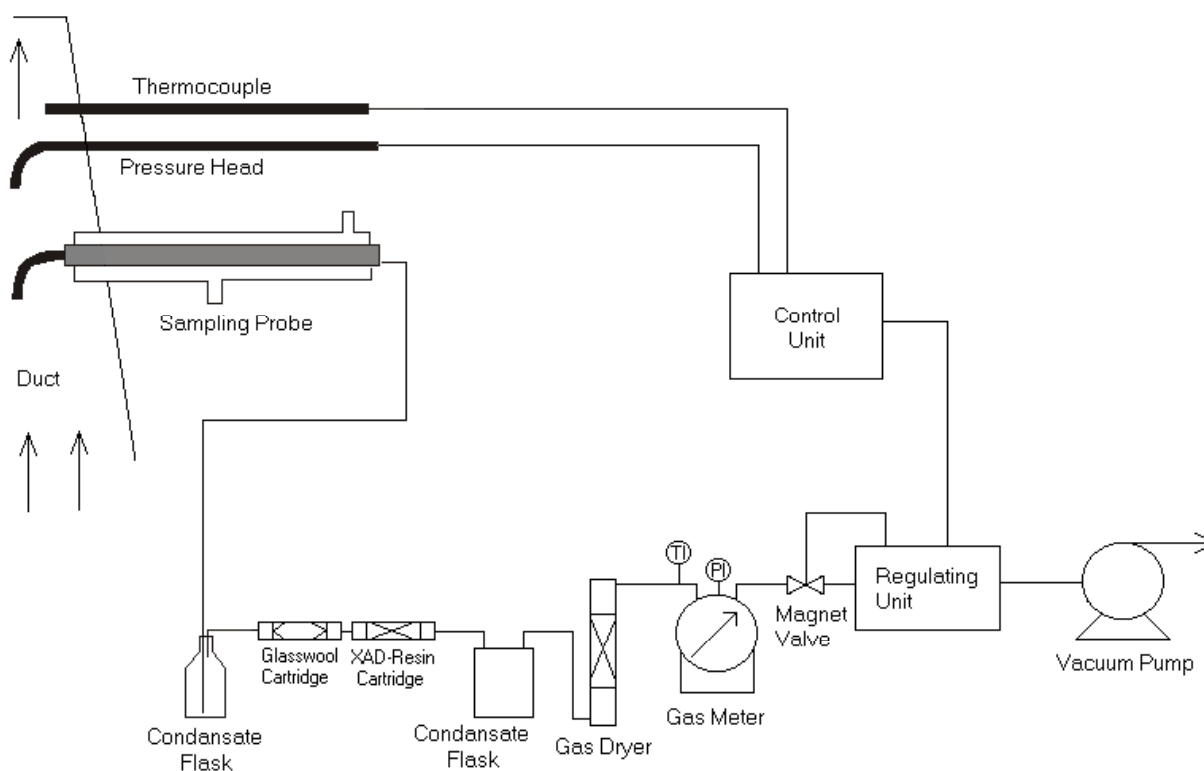

Fig. 4.1: Arrangement of the sampling equipment MRU 4000

Regulation unit is installed between the gas volume meter and vacuum pump. The sampled gas is sucked through one sampling train with a sample volume rate of about $1.5 \text{ m}^3/\text{h}$ (VDI 3499). It is the optimal gas flow rate for PCDD/F and PCB [59]. The automatic sampling is controlled from MRU control unit. The signals of the control unit are sent to a notebook where the MRU software is installed. It is also possible that data of the program are transferred to control unit MRU 4000 through the RS232 interface cable. The sucking process begins when pump is switched on by MRU software (in case of automatic sampling) or manual (in case of manual

sampling). The flow parameters can be followed on-line on the screen. The MRU 4000 operates independently.

Downstream, a battery of cartridges are connected to collect the soot particles and gaseous PCDD/F. If high dusty samples are expected ($> 5 \text{ mg/m}^3$) than the first cartridge is filled with pre-heated glass wool. It is used for trapping the PCDD/F which are adsorbed to the soot. On the bottom of the cartridge a glass fibre filter is fixed to retain fine particles. The second cartridge contains 50g XAD-2 resin for absorption of the gaseous PCDD/F. A second back-up XAD-2 cartridge is attached to control the breakthrough of PCDD/F. The tubes are embedded to the condensate flask of the gas volume meter. The condensate flask is a 1L brown flask. It plays the role of an impinger during the sampling process. The flask is in half full with a distillate water. The volume parts of the gas components are measured on-line with an gas analyzer TESTO 350, Lenzkirch, Germany. Second notebook is required for TESTO 350. The flue gas probe of the gas analyzer is positioned in the duct. The density of dry flue gas under standard conditions is determined from the volume parts of the gas components and the density of each gas component under standard conditions. The density of a gas component under standard conditions is the ratio of its relative molecular weight and its molar standard volume.

$$\rho_n = \sum \frac{\omega_i}{100\%} \cdot \rho_{n,i} \quad (2)$$

$$\rho_{n,i} = \frac{M_{r,i}}{V_{m,i}} \quad (3)$$

where i is $\text{CO}_2, \text{O}_2, \text{CO}, \text{N}_2$. The density of carbon monoxide and nitrogen is 1.250 kg/m^3 , of oxygen and carbon dioxide 1.429 kg/m^3 . The measured values are ste by introduced from the operator in MRU software before sampling. Both equipments operate independently.

A thermocouple is fitted in the orifice and delivers the temperature of the exhaust gas. The static and dynamic pressure in the duct is measured by a pressure head. These parameters are needed to determine the density of the flue gas and is then used to calculate the velocity of the gas.

The density of dry flue gas under standard conditions is converted into the density of flue gas including water vapour under standard conditions.

$$\rho_{n,f} = \frac{\rho_n + f_n}{1 + \frac{f_n}{\rho_{n,w}}} \quad (4)$$

With the density of humid flue gas under standard conditions the gas density of flue gas is calculated.

$$\rho_{pt,f} = \rho_{n,f} \cdot \frac{273.15}{1013} \cdot \frac{(p_{atm} + p_{st})}{T_d} \quad (5)$$

The velocity of the gas can be determined according to equation 7.

$$v = \sqrt{200 \cdot \frac{P_{dyn}}{\rho_{pt,f}}} \quad (7)$$

Then a nozzle diameter is chosen which corresponds to the velocity of the exhaust gas at a sample gas flow rate of about 1.5 m³/h. The calculations are done by the control unit.

$$V_n = v \cdot \frac{\pi}{4} d^2 \cdot 3600 \cdot \frac{(p_{atm} + p_{st})}{T_d} \cdot \frac{273.15}{1013} \cdot \frac{\rho_{n,w}}{\rho_{n,w} + f_n} \quad (8)$$

The automatic system continuously adapt to the velocity of the exhaust gas.

With the fixed nozzle diameter and the varying exhaust gas velocity, the flow rate is regulated by the evaluation and control unit by adding ambient air after the sampling train. The system is qualified for an isokinetic sampling according to the guideline VDI 4220. The final sampling values are saved in MRU software under *report*, *actual* and *info* files. Additional sampling reports are created for each sampling campaign. There, the hole information connected to the sampling such as fuel in use, duration of the sampling, sampling place and operator, MRU and TESTO data, isokinetic ratio, validation of the sampling are documented. That documents are attached to the PCDD/F and/or PCB test report, MRU and TESTO protocols.

The sampling can also be operated manually. That may happen if the dynamic pressure of the chimney is very low or very high. In such cases the regulation valve is positioned completely open or close during the automatic sampling. That normally terminates the automatic MRU 4000 work. The same problem can appear if the nozzle diameter chosen is not appropriate.

In case of manual sampling the steering of the system is controlled by the operator. The static and dynamic pressure in the duct is measured by a pressure head which is connected to the electronic-micro manometer Digima LPU, SI-Special instruments,

Nördlingen, Germany. The temperature and the volume parts of the gas components are measured with an gas analyzer TESTO 350. An adjustable valve is installed between the gas volume meter and the vacuum pump. The gas flow is obtained by calculation of all parameters during the sampling period into the excel sheet of the sampling report. The values on the gas meter are noted in the beginning and at the end of the sampling. The sampled gas volume is calculated.

4.1.2. Controlled parameters before sampling.

The parts of the sampling equipment are regularly maintained and calibrated according standard calibration procedures. An external calibration of devices measuring temperature, gas flow, dynamic and static pressure and velocity is performed by competent certified institutions which deliver a certificate. These calibrated devices are used for internal calibration of the sampling devices used for emission sampling of PCDD/F and PCB. The results of each calibration is documented in a protocol sheet.

Before sampling the following parameters are controlled:

Tightness of the sampling system.

All connections are checked and possible closed with a teflon tape. The flow rate at standard condition (m^3/h) is determined. The gas entrance is closed with a finger or stopper. The pump is started and runs for 30 seconds. The duration and the volume is noted. A leak is eventually found out. The flow rate for the tightness test (leak) has to be **lower than 2%** of the gas flow rate at standard sampling conditions.

Temperature in the condensate flask

The condensate flask is cooled with a cooling system (Cryostat Julabo FC600). The set temperature of Julabo is about 10°C , so that the temperature in the condensate flask is **less than 20°C** . At external sampling places, Julabo can be replaced by dried ice.

Humidity of the emission gases.

In MRU software, the barometric pressure (hPa) and the measured humidity (kg/m^3) have to be noted.

The humidity test is performed for each sampling place at the estimated temperature in the chimney just before the sampling.

CaCl_2 (granulated, 1-2 mm) has to be dried 1 hour in the oven at 120°C . An U-shaped glass tube is filled to its two thirds with dried CaCl_2 and weighed (about 60g).

Then a capillary glass tube is held into the flue gas channel and connected with the U-shaped glass tube. The other entrance is connected to a pump with a flow rate of 2 litres per minute (adjusted with the measuring scale of the pump). The test is carried out for 5 minutes. About 10 L (by higher quantities the capacity of the adsorbent would be exceeded) is passed through. Afterwards the glass tube is weighed again. The humidity will be calculated with:

$$\Delta m = m \text{ CaCl}_2 \text{ afterwards} - m \text{ CaCl}_2 \text{ before}$$

Δm corresponds to the quantity of water, which CaCl_2 absorbed (Kg/m^3).

Measurement of the temperature in the chimney, the velocity and the nozzle diameter

The thermocouple and the pressure head are moved from above to down or from the right to the left at 2 cm intervals in the cross section of the tube. After that the probe and the pressure head have the same velocity, but they have to be located with a minimum distance of 5 cm from the pipe wall in the flue gas channel.

The environmental parameters and the operation ability of the measuring devices.

- At the measuring site the good working conditions (electric power, water, light, ventilator and tools) before sampling have to be checked.
- The sampling tube in the metal cooler is installed (Fig.4.2). The cooling water of the glass probe for leaks is checked before each experiment in order to minimize damage of XAD-cartridge or contact with electricity. The water connections of Julabo equipment are also checked.

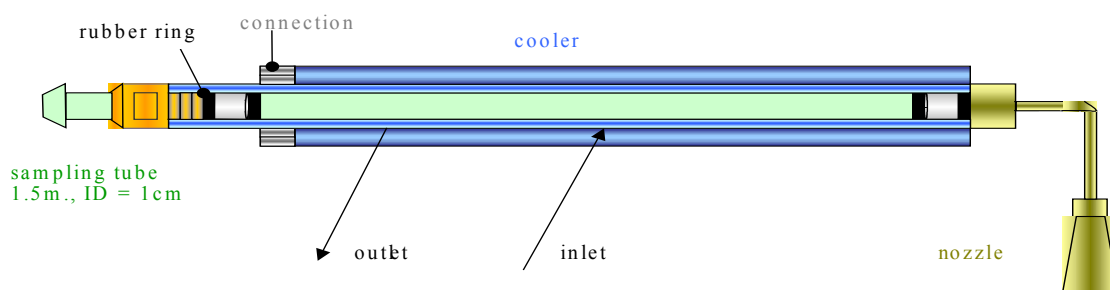

Fig. 4.2: Installation of the sampling tube in the cooler

- The operating ability of the portable flue gas analyser TESTO, MRU 4000 system and referred software are checked before sampling. The sensor of the Testo instrument is automatically cleaned with fresh air. If the sensors of MRU system are really dusty, they are blew out with stream of nitrogen.

4.1.3. Validation of the sampling measurements

In the sampling report validation of the sampling measurements with the following controls is noted:

- the blank value has to be **lower than 10%** of the limit value for PCDD/F for the flue gas (0.1 ng I-TEQ/Nm³ [100]),
- the calculated value of a sample has to be **higher** than the blank value,
- the value of the back-up cartridge has to be **lower than 10%** of the other cartridges (resin + glass wool).
- the recovery rate of sampling standards must be **more than 50% and less than 120%**
- the isokinetic ratio should be **about 1**.

According VDI 2066 the isokinetic ratio is:

$$\text{Isokinetic ratio} = \frac{\text{Theoretical volume flow}}{\text{Measured volume flow}} = \frac{A_{\text{nozzle, effective}} \cdot v}{V_n} \quad (9)$$

- the regulation difference between calculated and measured sampled gas flow rate for MRU 4000 sampling system is estimated as **less than 5%**

$$\Delta \bar{V} = \frac{\sum_1^j \frac{|V_c - V_n|}{V_n}}{j} \quad (10)$$

4.1.4. Laboratory preparation prior the sampling

All glass tubes and pieces, empty XAD-cartridges and condensate flask (=2 L brown glass bottle) are cleaned with toluene / n-hexane / acetone / methanol and washed in washing machine and dried in an oven at 450°C. The nozzles and the bends of the nozzles are placed in a beaker with toluene and treated for 1 h in an ultrasonic bath.

The cartridges are filled with ca. 50 g XAD-resin. The cartridge is tapped several times on the table to compress the XAD-2 package. Heated glass wool is placed in the cartridge and pressed on the XAD-2 resin. Afterwards 100 µl sampling standard is added on glass wool. If high dust concentrations are expected in the flue gases at the sampling point, a second cartridge, filled up only with compressed annealed glass wool, is prepared.

4.1.5. Laboratory work after the sampling

The condensate from the condensate flask is transferred on top of the XAD-cartridge, just after the sampling. The eluat is disposed. All glass parts (inclusive the condensate flask, also sucking tube) are first rinsed with 1.5 L dest. water, the rinsing water is also transferred to the XAD-cartridge. The eluat is disposed. The wet XAD-/glass wool- cartridges, the 1 L condensate flask, the other pre-cleaned glassware and also nozzle, manifold and bends are transferred to the laboratory.

The XAD cartridges from the sampling are dried for 1h by a light stream of nitrogen (1 bar), to remove the condensate water, which disturbs the Soxhlet extraction.

If the rinsing solvent contains a lot of soot, it is previously filtered over the dried XAD-cartridge. The eluat is collected into the same 1 L flask and used for the Soxhlet extraction. Afterwards the enriched soot on the XAD-cartridge is fixed with glass wool.

Prior extraction appropriate (depending on the class of analysed compound) internal labelled standard solution is added on the glass wool of the XAD cartridge: 100 µl PCDD/F solution, 20 µl PCB solution, 10 µl C₄-C₆ CBz labelled standard solution. Two Soxhlet extractions are carried up for PCDD/F, PCB and PCBz analysis. First the PCB and PCBz are extracted with n-hexane. Second the PCDD/F are extracted with toluene.

PCB extraction with n-hexane

The cartridge is placed in a 500 ml Soxhlet extractor. Some boiling stones as well as 700 ml n-hexane, consisting of rinsing n-hexane and additional pure n-hexane, are placed in a 1000 ml round bottom flask.

At these conditions the sample is extracted for 24 h. After cooling to room temperature the cooler and extractor is rinsed with n-hexane. All the rinsing solvents are combined with the extract.

PCDD/F extraction with toluene

Here, the 1000 ml round flask is filled with 700 ml toluene, consisting of rinsing toluene and additional pure toluene. The duration of the extraction is 24 h. After cooling to room temperature the cooler and extractor is rinsed with toluene. All the rinsing solvents are combined with the extract.

After the extractions 50% of each extract is stored in an extra flask for further analysis (reference sample). The remaining 50% of the extract is reduced to 1 ml by the vacuum evaporator. If the solvent contains water, it is dried over sodium sulphate through a funnel.

The reduced extracts of toluene and n-hexane are transferred one after the other to the first clean-up column.

4.1.6. Sampling place

The performed sampling campaigns are done at the Institute for Ecological Chemistry, GSF- National Research Centre for Environment and Health. The sampling place is a outhouse near the institute. It is equipped with a small domestic stove. The diameter of the its chimney is 12 cm and the length from the first curve after the stove to the second one is 123 cm. The sampling place is supplied with water and electricity.

Emission samples of the combustion of selected fuel mixture in pilot scale unit are sampled by MRU sampling system. A ventilator is used to maintain the gas flow. It is located in a second outhouse very close to the sampling place (Fig. 4.3.). The chimney of the domestic stove is connected by pipes to the ventilator. During the sampling the exhaust gases are introduced through the ventilator into the neighboured outhouse. The detected velocity at such conditions is around 1.3 -1.5 m / s (data correspondent to the more capacity ventilator). During combustion processes the velocity in the chimney can reach around 6 m / s. That lead to an increase of the dynamic pressure in the chimney.

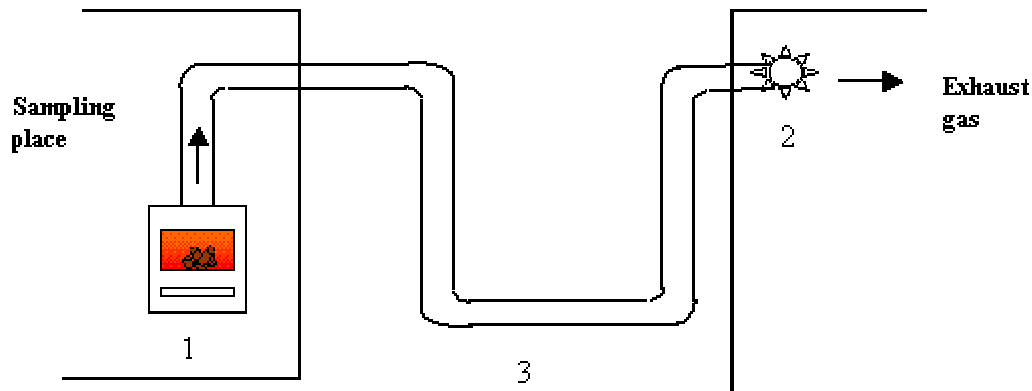

Fig. 4.3: Sampling background. (1-domestic stove, 2- ventilator, 3-pipes)

4.1.7. Sampling points

In order to select the location of the sampling equipment in the duct, the sampling points have to be defined. Measurement of the velocity in the sampling plane at different points in the duct with Prandl-tube is required. It is found that the velocity is constant between 2 and 8 cm of the internal diameter of the chimney.

The hole of the Prandl-tube has to be placed in distance more than 5 dh (standard), where

$$dh = \frac{4 * \text{area of sampling plane}}{\text{perimeter of sampling plane}} \quad \text{or} \quad dh = \frac{4 * \pi r^2}{2\pi r} \quad (11)$$

After calculation the estimated sampling point of the Prandl-tube is 65 cm after the last curve of the chimney. The sucking tube (cooler) with nozzle and the thermocouple are placed in 5 cm distance from each other, downstream the Prandl tube. The ends of the three sensors are arranged in the same line of the sampling plane (Fig. 4.4.). The Testo instrument is placed 15 cm upstream of the Prandl-tube.

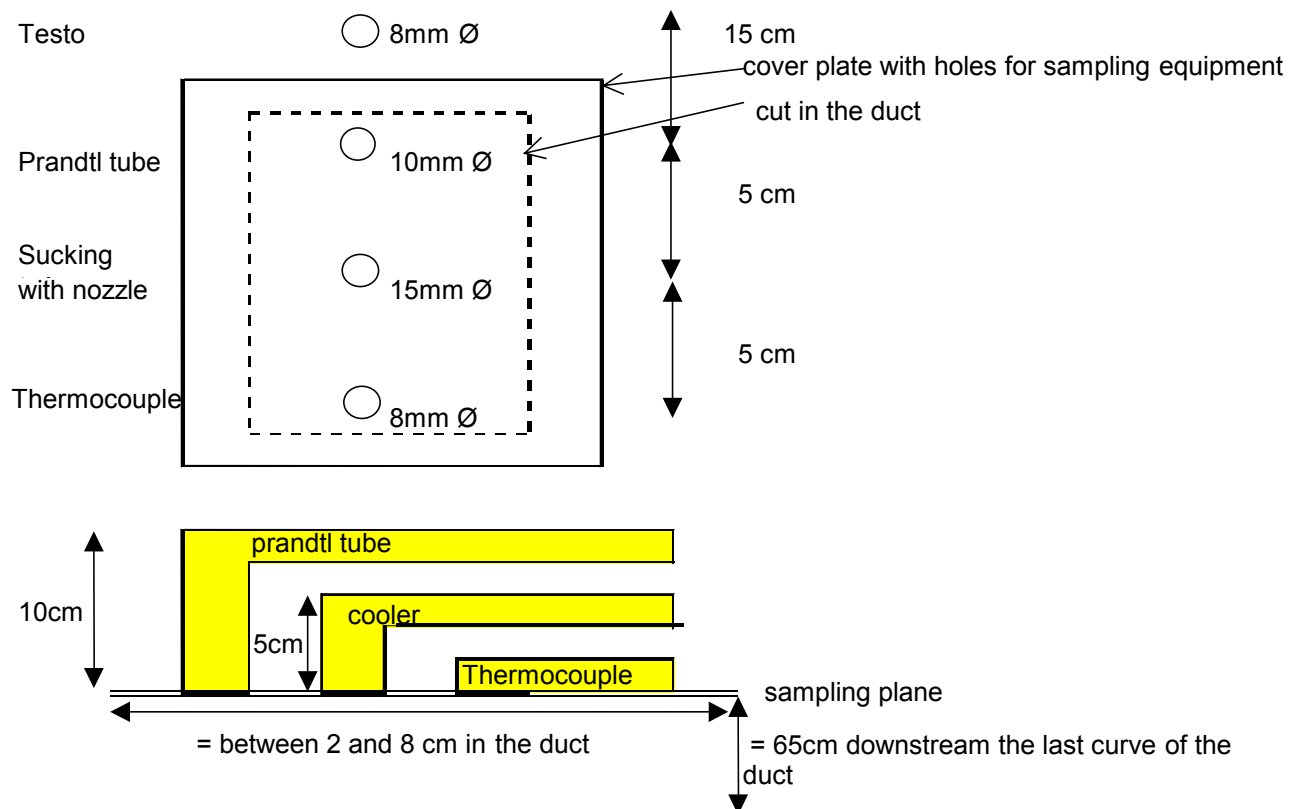

Fig. 4.4: Arrangement of the sampling points in the chimney.

4.1.8. Sampling campaigns

Several sampling campaigns are performed at different combustion conditions (Tab. 4.1.) by MRU sampling device. The fuel in use was:

- poplar wood
- Beech/ Oak wood
- PVC
- Solid waste

Tab. 4.1: Sampling campaigns

No	Sample number	Type of cartridge	Combusted Fuel	Quantity of Fuel (Kg)	PCCD/F analysis	PCB analysis	
1	C0109008	resin	- *	-			
2	C0111007	back-up	poplar wood	2.25	✓		
	C0111009	resin			✓		
	C0111010	glass wool			✓		
3	C0112007	back-up	poplar wood	4.8	✓		
	C0112008	resin			✓		
	C0112009	glass wool			✓		
4	C0201021	back-up	90% poplar wood :	2.25	✓		
	C0201022	resin and glass wool	10%PVC	0.26	✓	✓	
5	C0201024	back-up	poplar wood	2	✓		
	C0201025	resin and glass wool			✓		
6	C0202018	back-up	poplar wood	4	✓		
	C0202019	resin and glass wool			✓		
7	C0203005	resin	90% poplar wood :	3.4	✓	✓	
	C0203006	glass wool	10%PVC	0.34	✓	✓	
8	C0204001	resin	90% poplar wood :	1.77	✓	✓	
	C0204002	glass wool	10%PVC	0.18	✓	✓	
9	C0204016	resin	90% poplar wood :	2.2	✓	✓	
	C0204017	glass wool	10%PVC	0.22	✓	✓	
10	C0309019	resin and glass wool	85 % Beech/ Oak wood :	10	✓	✓ *	
			10% solid waste :	1.16			*
			5% Spanish PVC	0.57			
11	C0311039	resin and glass wool	97% (85% Beech/ Oak wood :	4.76	✓	✓ *	
			10% solid waste :	0.55			*
			5% Spanish PVC) :	0.22			
			3% (NH ₄) ₂ SO ₄	0.17			

* hair drier is used to maintain gas flow

** PCBz are also analyzed

The concentration of PCDD/F, PCB and PCBz are calculated in pg / Nm^3 . The sample gas flow at normal condition is on the base of: $T = 0 \text{ }^\circ\text{C}$, $p = 1013 \text{ mbar}$, $\text{O}_2 = 11 \text{ Vol}\%$, humidity = 0 Vol%. The sampled gas volume as well as the type of steering, temperature in the chimney and calculated isokinetic ratio are shown in Tab. 4.2.

Tab. 4.2: Sampling data

No sampling	Steering	T, °C in the chimney	Sample gas flow in normal condition
1	automatically	25	-
2	manual	150	1.47
3	manual	500	1.59
4	automatically	180	1.66
5	manual	250	0.97
6	manual	300	1.45
7	manual	200	2.84
8	manual	130	0.77
9	manual	700	0.42
10	automatically	383	1.73
11	automatically	330	0.66

4.2. Laboratory Scale Experiments

The proposed work to elaborate the efficiency of additional dioxin preventing compounds in the raw fuel, before combustion is studied at laboratory conditions. The examination of the effect of that inhibitors is tested at lower temperature area of the post combustion zone in the gas phase. These experiments require a furnace with safety feature, readily accessible control, controlled heating, clean and dust free work tube. A three zone horizontal tube furnace CARBOLITE GmbH, Ubstadt-Weiher, Germany is used for that purpose.

4.2.1 Laboratory apparatus

A laboratory scale horizontal split-tube furnace (Split Tube furnace (3-zone) type HZS & TVS, Carbolite, England) (Fig. 4.5.), is used for the lab-scale experiments. The laboratory reactor consisted of a quartz tube with ID=14 cm and a length of 150 cm, $\frac{3}{4}$ of the length of which is placed into the heatable zone of the furnace. From the

cooled part of the quartz tube the sampling boat is pushed to the middle of the heated zone when the desired temperature is achieved.

The flue gases occurring during the experiment are trapped into 3 impingers in series, each filled with 70 mL toluene. The remaining gases are passed into a small glass wool cartridge filled with active carbon. That unit is continuously connected to the vacuum pump. The inlet of the air flow and the outlet of the vacuum pump are controlled with a rotameter (ROTA). About 1mm size bubbles are observed during the process in the impinger. The first impinger is previously spiked with 100 μL CEN-sampling PCDD/F standard. The combustion experiments are performed according to the same procedure each time in order to achieve comparable results.

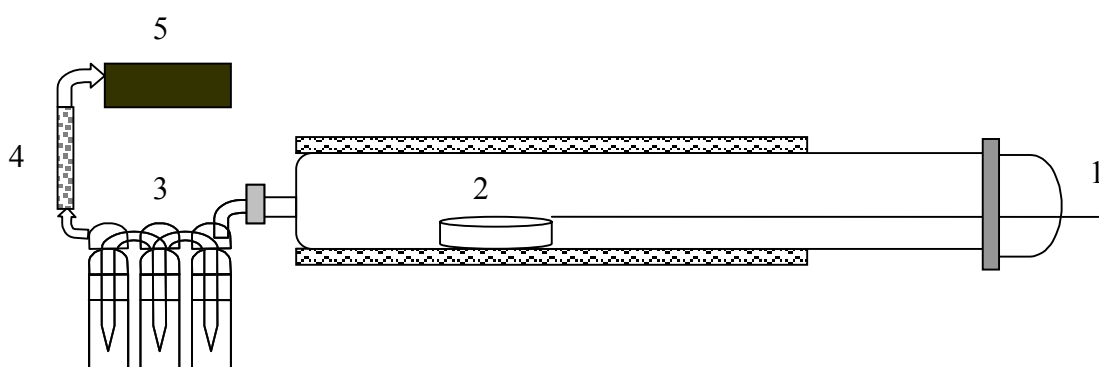

Fig. 4.5: Scheme of the laboratory scale furnace (1-inlet with air flow, 2-sampling boat, 3-toluene impingers, 4-glass wool filter, 5-vacuum pump).

To avoid memory effects, the furnace is cleaned mechanically and with the solvents toluene and acetone after each experiment. Afterwards it is heated at 850°C for 2 h at a gas flow of 2 L / min.

4.2.2. Experimental procedure

Several different experiments are performed in order to investigate the optimal PCDD/F formation and inhibitory effect of various compounds. During that study the general experimental parameters are the weight of the combusted fuel 10g and the air flow 2 L / min. Most of the experiments are performed with compressed air and some other with synthetic air. Blank samples are generated when the air supply is changed. The temperature in use and the duration of the experiments varied from serial of samples to other one. The experiments are explained below.

1. At 300°C and 500°C, the duration of the experiments is 15 min
2. At 400°C, the duration of the experiments is 30 min

3. In order to optimise the experiment at 1000°C two different procedures are performed
 - a) the sampling boat is pushed to the middle of the heated zone when 1000°C is achieved. The duration of the experiments is 15 min.
 - b) the sampling boat is pushed to 200°C heated zone and the temperature is increased continuously to 800°C and then 1000°C. The duration of the experiment in that case is 60 min

At 1000°C the impingners are placed in cups filled with dry-ice in order to cool the hot flue gases leaving from the furnace. The system is opened one hour after the experiment, to protect from accidental incidents of fast cooling. To avoid memory effects the furnace is cleaned mechanically and with the above mentioned solvents and heated at 1000°C for 2 h with a gas flow of 2 L / min.

4.2.3. Fuel type and examined inhibitors

In this study a series of experiments are performed for prevention of PCDD/F formation by use of various inhibitors added to the fuel before combustion. The fuel-types used in this study are lignite coal from Puertollano (Spain), pre-treated municipal solid waste (Rethmann Plano GmbH) and used PVC (waste from ground carpet).

The weight percentage content for the lignite coal is 80% of the total fuel. The motivation behind that high percentage is based on the main interest of coal-combustion in that study. The chlorinated compounds are 20% with a 13.3 : 6.7 ratio of the solid waste to PVC.

Different optimisation processes are examined before the final experimental procedure is established. That optimisations concern:

- the formation of dioxins in the mixture fuel. Experiments with coal / solid waste fuel and without any PVC are also performed. The emitted PCDD/F amount is not high enough to study the inhibition processes. Addition of 6.7% PVC to the fuel resulted in a substantial increase of PCDD/F, PCB and PCBz. The influence of PVC is already known as important parameter in incineration processes [47].
- sample homogeneity. Prior to the experiment, each fuel is stirred with a mechanical mortar to generate a particle size of less than 1mm. For the solid

waste, the mixing procedure is performed after cooling the larger pieces in liquid nitrogen for 30 min. This procedure preserves the composition of the solid waste. Before combustion the fuel mixture is thoroughly homogenized in the sampling boat. These measures are assumed to decrease the variables between the samples.

Twenty different additives are investigated at a level of 10% of the total fuel during the experiments. Generally they can be divided into four main groups according to their chemical structure: metal oxides; N-containing compounds; S-containing compounds and N- and S- containing compounds. For the inhibitor experiments, the inhibitor is added as 10 % of the fuel. The remaining 90% fuel is mixed in the same manner mentioned above for samples without additives. The three of the most effective inhibitors for PCDD/F reduction, $(\text{NH}_4)_2\text{S}_2\text{O}_3$, $(\text{NH}_4)_2\text{SO}_4$, and $((\text{NH}_2)_2\text{CO}+\text{S})$ (1:1) are also used at an amount of 5%, 3%, 1% of the fuel.

The compounds investigated as inhibitors are divided into four main groups according to their chemical nature and structure and are as followed:

1. Metal oxides:

chromium (III) oxide (Cr_2O_3) (Merck);
 titanium (IV) oxide (TiO_2) (Merck);
 sodium (meta) vanadate (NaVO_3) (Fluka);
 zirconium (IV) oxide (ZrO_2) (Merck);
 aluminium(III)oxide (Al_2O_3) (ICN-EcoChrom);
 sodium molybdate dihydrate ($\text{Na}_2\text{MoO}_4 \cdot 2\text{H}_2\text{O}$) (Fluka);
 sodium tungstate dihydrate ($\text{Na}_2\text{WO}_4 \cdot 2\text{H}_2\text{O}$) (Fluka).

2. N-containing:

di-ammoniumhydrogenphosphate ($(\text{NH}_4)_2\text{HPO}_4$) (Merck);
 triethanolamine ($\text{N}(\text{CH}_2\text{CH}_2\text{OH})_3$) (Merck);
 hexamethylphosphoramide ($[(\text{CH}_3)_2\text{N}]_3\text{P}(\text{O})$) (Sigma-Aldrich Chemie).

3. S- containing:

sulfur (S) (Sigma-Aldrich Chemie);
 phosphorus (V) sulfide (P_2S_5) (Merck);
 sodium sulfide ($\text{Na}_2\text{S} \cdot \text{H}_2\text{O}$) (Merck).

4. N- and S- containing:

hydroxylamine-O-sulfonic acid ($\text{H}_2\text{NSO}_4\text{H}$) (Merck);
 amidosulfonic acid ($\text{H}_2\text{NSO}_3\text{H}$) (Sigma-Aldrich Chemie);

sulfamide ($\text{H}_2\text{NSO}_2\text{NH}_2$) (Sigma-Aldrich Chemie);

ammoniumthiosulfate ($(\text{NH}_4)_2\text{S}_2\text{O}_3$) (Merck);

urea+sulfur ($(\text{NH}_2)_2\text{CO}+\text{S}$) (1:1) (urea, techn.);

ammoniumsulfate ($(\text{NH}_4)_2\text{SO}_4$) (Merck).

A residue of olive oil named pomace (50% carbon and 50% oxygen) is also tested as inhibitor for PCDD/F in such a fuel mixture.

4.2.4. Laboratory work before clean-up

After completing the experiment, the impingners are transferred in GSF-Research Centre for Environmental and Health, Institute for Ecological Chemistry, dioxin laboratory. There the sample is transferred into a 500 ml round flask. The used glassware is rinsed three times with pure toluene which is added to the same flask. The sample is reduced to 1 ml by the vacuum evaporator. The reduced extract is transferred to the first clean-up column.

4.2. Clean-up Procedure

The clean-up procedure for PCDD/F, PCB and PCBz take place in dioxin laboratory, GSF- Research Centre, Institute for Ecological Chemistry, (Neuherberg, Germany). Dioxin laboratory is an accredited laboratory against the standard DIN EN ISO/IEC 17025 [100]. That certificate provides for the dioxin laboratory a guarantee of the quality of its measurements. It demonstrates the competence of this testing laboratory to carry out specific tests.

The clean-up steps are explained below carried out according to the corresponding SOP (standard operated procedure) (Tab. 4.2.). These SOPs are verified against the above-mentioned standard. All rights of this SOPs are reserved from dioxin laboratory.

Once registered in dioxin laboratory sample is processed for further PCDD/F and/or PCB specific clean-up steps (Fig. 4.6. and 4.7.). The clean-up procedure for PCB and PCBz is general.

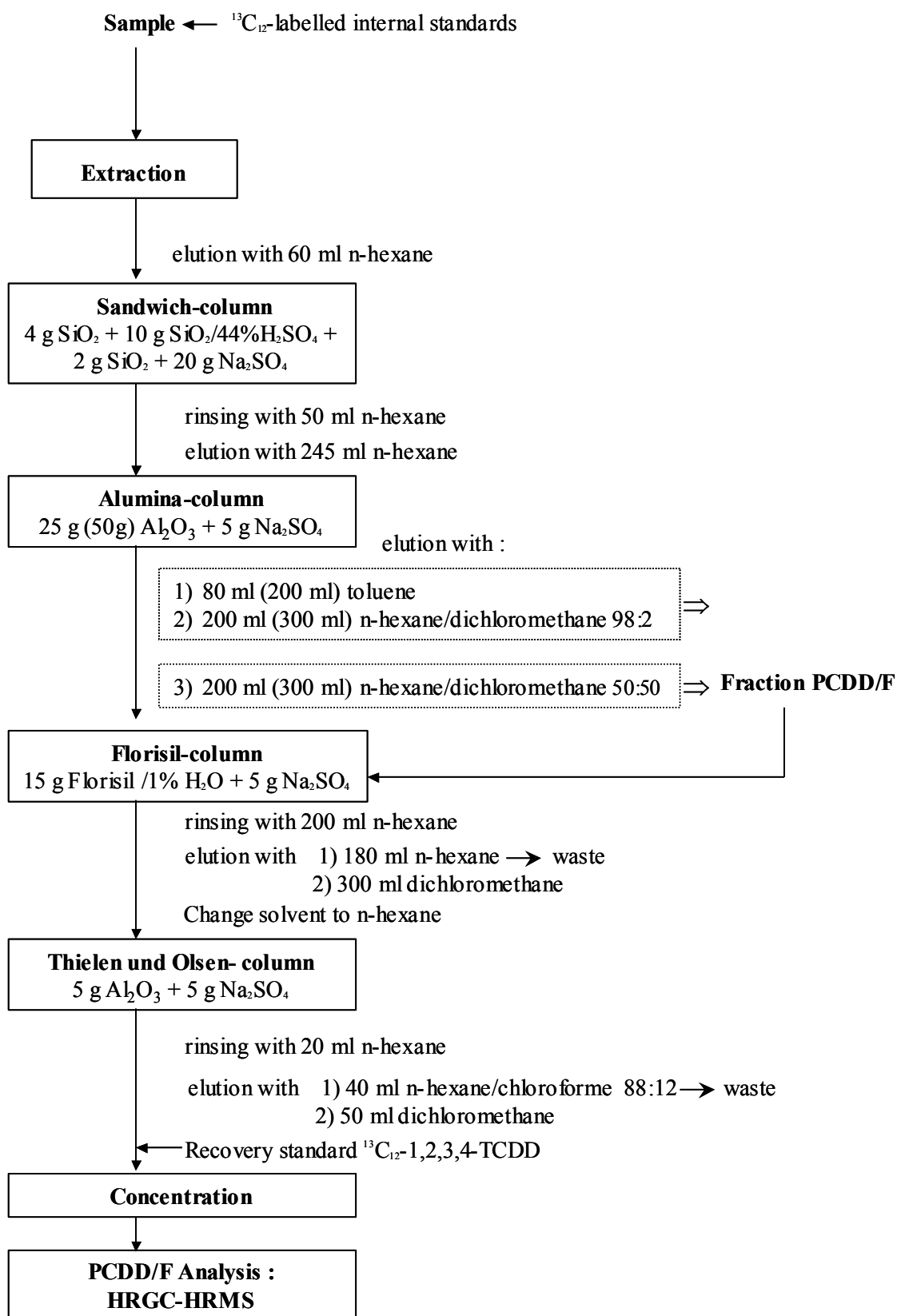

Fig. 4.6: Sample preparation flowchart for PCDD/F, PCB and PCBz analysis

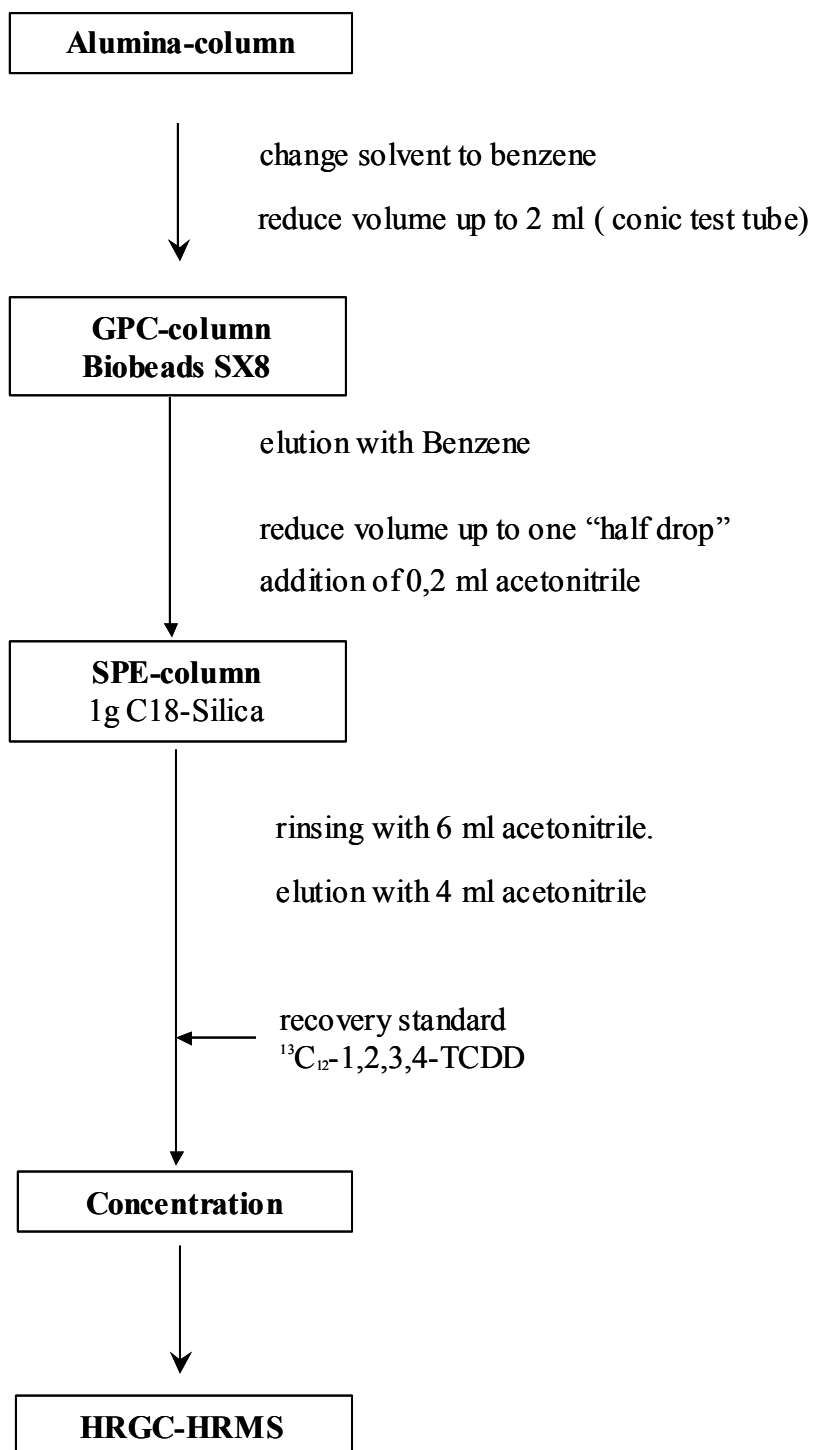

Fig. 4.7: Continued preparation flowchart for PCB and PCBz analysis

Tab. 4.2: Clean-up procedure for PCDD/F, PCB and PCBz analysis

PCDD/F analysis	PCB, PCBz analysis	Clean-up steps
✓	✓	Sandwich-column
✓	✓	Alox-column
	✓	GPC-column
	✓	C18-column
✓		Florisil-column
✓		Thielen and Olsen-column
✓	✓	Transfer from cleaned extracts into vials

4.3.1. Sandwich column

On the sandwich column many organic compounds are oxidized or sulphured by reaction with the sulphuric acid. The resulting polar bonds are absorbed at the silica gel. It is eluted with the non polar solvent n-hexane. This clean-up step oxidizes poly-aromatic hydrocarbons (PAH).

Preparation of the sandwich column:

4 g silica gel are weighed and transferred to a chromatography column. Similarly 10 g silica gel impregnated with concentrated sulphuric acid are weighed and transferred to the column. Subsequently, another 2 g silica gel are weighed and transferred to the column. The upper layer consists of 5 g water-free sodium sulphate.

Elution of the sample

In order to avoid blank values the packed sandwich column is rinsed with 60 ml n-hexane. Before the upper layer becomes dry appropriate (depending on the class of analysed compound) internal labelled standard solution 100 µl PCDD/F solution, 20 µl PCB solution, 10 µl T₄-T₆ CBz labelled standard solution is added (If the sample is processed already with Soxhlet extraction, the internal standard is not spiked again). The reduced 2 ml sample is transferred with a Pasteur pipette to the packed column. In case of samples treated prior with Soxhlet extraction, the upper layer of the sandwich column is loaded only with the 2 ml extract. Such procedure is performed for the emission cartridges which are spiked before Soxhlet extraction with internal standards.

Later, the sample flask is rinsed 3 times with a small quantity of n-hexane : the sample or rinsing solvent are given successively with the same Pasteur pipette on the sodium sulphate layer of the column. 245 ml n-hexane is filled into the dropping funnel. Before the upper layer is becoming dry, the eluent is slowly dropped on the column, and thus the upper layer is not whirled up. The sample (dropping rate is approx. 2 drops/second) is collected in a round flask. If the sulphuric acid layer is dark coloured till the lower end, the clean-up sandwich column is repeated. For the emission samples double sandwich column is prepared frequently.

Finally the sample is reduced at the rotary evaporator in a bath with temperature 60°C and at a pressure from 500 to 550 mbar. The reduced approx. 2 ml sample should be colourless or less coloured than the initial fraction.

4.2.2. Alox column

At that clean-up step, the first polar bond toluene fraction (PCDD/F) is collected and separated from the second fraction, which contains PCBs and other chlorinated aromatics.

Preparation of the alox column:

25 g alumina oxid is filled into a chromatography column with a high-grade steel funnel. The upper layer consists of 20 g water-free sodium sulphate.

For the determination of the PCB and PCBz the packed column is rinsed with 80 ml toluene in order to avoid blank values and for conditioning. The eluent is given to the solvent waste.

Elution of PCB and PCBz Fraction

Before the upper layer becomes dry, the reduced 2 ml sample is transferred with a Pasteur pipette to the already packed column. The sample flask is rinsed 3 times with a small quantity of toluene: the sample or rinsing solvent are given successively with the same Pasteur pipette on the sodium sulphate layer of column.

80 ml toluene are filled into the dropping funnel. Before the upper layer becomes dry, the eluent is slowly dropped on the column. A further elution is dropped as a mixture of 200 ml n-hexane / dichloromethane in the volume ratio of 98:2. The sample is collected in the same round flask.

Elution of the PCDD/F Fraction

Before the upper layer is becoming dry, 200 ml n-hexane / dichloromethane is filled into the dropping funnel in a volume ratio of 50:50 and carefully dropped on the column.

The sample is collected in a new round flask. Finally the collected sample is reduced to approx. 2 ml at the rotary evaporator first with 60°C with normal pressure to remove dichloromethane and then with 500 to 550 mbar for hexane.

4.3.3. Florisil column

At this step chlorinated aromatic bonds are separated. They are present in most samples at a very high excess.

Preparation of the florisil column:

15 g florisil deactivated with 1 % water are homogenized into a beaker and transferred over a glass funnel to the chromatography column. The upper layer consists of 5 g water-free sodium sulphate.

Elution of the sample

In order to avoid blank values the packed sandwich column is rinsed with 150 ml n-hexane. Before the upper layer is becoming dry, the reduced 2 ml sample is transferred with a Pasteur pipette to the already packed column. The sample flask is rinsed 3 times with a small quantity of n-hexane: the sample or rinsing solvent are given successively with the same Pasteur pipette on the sodium sulphate layer. 150 ml n-hexane are filled into the dropping funnel. Before the upper layer is becoming dry, the eluent is slowly dropped on the column, and thus the upper layer is not whirled up. The sample is collected in a round flask. This flask is kept until the end of the analysis. Before the upper layer is becoming dry, the column is eluted with 300 ml dichloromethane. The dichloromethane fraction is collected in a new flask. Finally the sample is reduced at the rotary evaporator up to approx. 2 ml (temperature 60°C, normal pressure).

- If a further clean-up step with a Thielen and a Olsen column will be carried out the sample is dissolved in n-hexane. Approx. 50 ml n-hexane are added to the florisil fraction and the sample is again reduced to approx. 2 ml with 500 to 550 mbar at the rotary evaporator.

4.3.4. Thielen and a Olsen column

At that clean-up step, the still remaining interfering compounds, such as non polar halogenated aromatics, sulphurs, PAH and some polar pollution are eliminated.

Preparation of the Thielen and a Olsen column

A small chromatography column is filled with 5 g alumina with a high-grade steel funnel. The upper layer consists of 5 g water-free sodium sulphate.

Elution of the sample

In order to avoid blank values the packed alumina oxid column is rinsed with 20 ml n-hexane. The reduced fractions of the florisil column are transferred with a Pasteur pipette to the already packed column. Before the upper layer is getting dried, the sample flask is rinsed 3 times with a small quantity of n-hexane / chloroform (88:12): the sample or rinsing solvent is given successively with the same Pasteur pipette on the sodium sulphate layer of column. 35 ml n-hexane/chloroform (88:12) is filled into the dropping funnel. Before the upper layer becoming dry, the eluent is slowly dropped on the column.

The sample is collected in a round flask. This flask is kept until the end of the analysis. Before the upper layer becoming dry, the column is eluted with 50 ml dichloromethane. The dichloromethane fraction is collected in an appropriate pear shape flask. Finally the collected sample is reduced to approx. 0.2 ml at the rotary evaporator (temperature 60°C and at a normal pressure, then 300 mbar).

4.3.5. GPC column for PCB analysis

GPC separates the molecules according their size. The separation is based on a negative filter effect of the porous stationary phase: small molecules are held, large molecules are eluted first. The stationary phase consists of Biobeads SX8, a copolymer of styrene and 8% divinylbenzene. Benzene is used as mobile phase. GPC separates: fats, oils, fatty acids, sulphur, 5-7-Ring PAH, a part of the phosphoric acid esters and a part of the Phthalic acid esters.

Sample preparation

The sample has to be present in benzene, because other solvents cause another swelling behaviour of the Biobeads and thus a destruction of the GPC column. For the GPC auto sampler, conic shaped glass has to be used and the sample volume needs to be exactly 2 ml.

The first alox PCB fraction is present as hexane extract. That sample is reduced to approx. 2 ml at the rotary evaporator at 60°C and 500 to 550 mbar and transferred in GPC auto sampler glass. The sample flask is rinsed three times with benzene. The glass is placed in the heating plot (water bath) of the blow-off equipment and the volume of solvent is reduced to 2ml at 50°C under gentle stream of nitrogen.

Operation with GPC column

About 110 ml benzene is used for every sample. Prior start of the GPC column the following program is loaded : Drain 30 min, Collect 14 min, Rinse 2 min. Later the pump is switched off independently after processing of the sample. In the conic flasks, the eluted fraction amounts is about 40 ml benzene solution. The volume of the fraction is reduced to nearly 0.5 ml at the rotary evaporator at 50°C and 250 mbar.

Note

That clean up procedure with GPC column is performed only for the emission samples. The laboratory scale experiments samples are not processed with that column. The first alox PCB fraction is transferred into a conic flask with a Pasteur pipette. The sample flask is rinsed 3 times with a small quantity dichloromethane and the rinsing solvent is given successively with the same Pasteur pipette to the conic flask.

4.3.6. C18 column

The C18-Material is an octadecyl modified silica gel. On this hydrophobic stationary phase, long chained hydrocarbons can be adsorbed; these hydrocarbons cause interferences mainly in the analysis of mineral oil, sewage sludge and sediment samples. Acetonitrile is used as a polar eluent.

Sample preparation

The sample from the GPC or the samples after aiox is reduced approx. to 0.5ml with a rotary evaporator. This volume is carefully reduced to approx. 1/2 drop (almost to the dryness) by a light stream of nitrogen at the sample concentrator. After that, 0.2 ml acetonitrile is given into the conical flask.

Preparation of the C18 column:

A PTFE frit is inserted into an empty 8 ml glass cartridge. The frit is pressed with a glass rod to the bottom of the cartridge. After filling with 1 g dry C18-material, the cartridge is plugged with another PTFE frit. The last frit is firmly pressed again with a glass rod into the cartridge.

Elution of the sample

The already prepared C18-cartridge is conditioned with 4 ml of acetonitrile. For that, the cartridge is placed on to the vacuum manifold. An empty 8 ml sample vial is placed in the vacuum manifold under the drain tube.

The solvent is sucked through the cartridge with a gentle vacuum (approx. 900 mbar) until the adsorbent is wet and the solvent is dropping free of bubbles out of the drain tube. After that, the vacuum is switched off, in order to keep a normal dropping rate of approx. 1 drop per second. The cartridge shouldn't run dry before sample addition.

For collecting the sample, a new empty 8 ml sample vial is placed in the vacuum manifold under the outlet of the already conditioned cartridge. The sample (0.2 ml), is added with a Pasteur pipette on the conditioned C18-cartridge. The conical flask is rinsed with two times with 0.4 ml acetonitrile. As soon as the rinsing solvent passed completely through the upper PTFE frit, another 3 ml acetonitrile is added for elution.

After C18 clean up column

The sample vial with the sample from the C18-cartridge is reduced (almost to the dryness) in the light stream of nitrogen at the sample concentrator. The evaporation is carried out very carefully, otherwise the recovery of the lower chlorinated PCBs is becoming worse. At the end of the evaporation the solvent is changed to toluene by three times adding 3 drops of toluene. Then the sample is transferred immediately into a vial.

4.3.7. Concentration

The sample concentrator is used in this step. The temperature of the heating block of that device is adjusted to 45°C and the safety temperature to 50°C. The nitrogen supply is opened. The valves, over the pipettes, are so far opened, that the surface of water moves gently, in order to check the nitrogen stream.

An appropriate quantity of PCB or PCDD/F recovery standards solutions (20 or 25 µl) is filled into a inner part of the vial with a micro litre syringe. The PCB recovery standard is general also for the PCBz. In case of further PCB and PCBz analysis, only one portion of 20 µl recovery standard is spiked. The level of the standard in the micro-insert is marked with a felt-tip pen. Afterwards, the micro-insert is placed into a brown glass vial sample and placed in the sample concentrator.

After the last clean-up step, the reduced sample is transferred carefully and stepwise with a Pasteur pipette into the micro-insert without dropping beside. The flask is rinsed 3 times with a small quantity of dichloromethane. This solvent is transferred with the already used pipette into the vial and evaporated to the correspondent mark. Then the vial is closed with a septum cap. After arrangement, the sample is either measured with HRGC/HRMS or kept in the refrigerator.

4.3. Detection & Quantification with HRGC/HRMS

The quantification of PCDD/F, PCB and PCBz is performed on a high-resolution gas chromatography instrument (60 m Rtx-2330 polar capillary column, Restek) coupled with a high-resolution mass spectrometer (MAT 95, Finnigan) (HRGC/HRMS). The tetra- to octachloro- isomers of PCDD/F, mono- to deca-isomers of PCB and tetra- to hexa- PCBz isomers are identified and quantified.

4.4.1. Detection of PCDD/F

The measuring of PCDD and PCDF is possible by GC/MS where the tetra – hexa chlorinated isomers are separated gas chromatographically through special isomer specific capillary column (Restek Rtx-2330) and detected by the help of mass spectroscopy Finnigan MAT 95.

The entry parameters of the isomer specific separation are:

Start temperature: 120°C, Start time: 0.00 min, Heating rate 1: 12.0°/s, End temperature 1: 280°C, Hold time 1: 5.00 min, Heating rate 2: 12.0°/s, End temperature 2: 300°C, Hold time 2: 5.00 min, Kryo-cooling: out, Equilibration time: 0.20 min, GC Run time: 50.00 min, Loading Modus: Splitless.

For confirmation of the result or in case of poor detection of 7- and 8- chlorinated isomers, second measurement with non polar capillary column (J&W DB-5ms), coupled to Finnigan MAT 95 mass-spectrometer is performed. The entry parameters of that non-polar column separation are:

Start temperature: 50°C, Start time: 0.00 min, Heating rate 1: 12.0°/s, Plateau temperature 1: 280°C, Hold time 1: 600 s, Heating rate 2: 12.0°/s, Plateau temperature 2: 300°C, Hold time 2: 600 s, Kryo-cooling: out.

Evaluation of the measurement

Before quantification analysis of the measured results, qualitative consideration has to be done. That procedure include control of the total ionic current and detection of eventual electronic interferences which can disturb the measurement.

The chromatographic separation is considered as sufficient when

- All marked standards are available and well-defined for identification
- The retention time of all isomers is present in the defintime window

4.4.2. Detection of PCB and PCBz

The measuring PCB is possible by GC/MS where the mono – deca chlorinated isomers are separate gas chromatographically through 5%-Phenylphase employed column (J&W DB-5ms or J&W DB-XLB) and coupled with mass spectroscopy Finnigan MAT 95. The measuring of PCB is performed by the sensitive MID-Mode where specific single bonds are registered.

The entry parameters of the isomer specific measurements are:

Start temperature: 50°C, Start time: 0.00 min, Heating rate 1: 12.0°/s, Plateau temperature 1: 280°C, Hold time 1: 300 s, Heating rate 2: 12.0°/s, Plateau temperature 2: 300°C, Hold time 2: 300 s, Kryo-cooling: out.

Evaluation of the measurement

The same procedure as the evaluation of the PCDD/F measurement.

4.4.4. Quantification of PCDD/F, PCB and PCBz

The quantification procedure of PCDD/F, PCB and PCBz is equal. The criteria of the final controlled values are also the same.

Response factor

Prior quantification, the amount of the internal standards of the investigated analyte (PCDD/F, PCB and PCBz) has to be calculated. In order to estimate it, the actual response factors of the recovery standards has to be documented. For that purpose 3 different mixtures are prepared:

For PCDD/F: 5 µl internal standard, 5 µl recovery standard and 5 µl sampling standard

For PCB: 5 µl internal standard, 5 µl recovery standard

For PCBz: 5 µl internal standard, 5 µl recovery standard

1 µl of each mixture is analysed and quantified as separate sample. The data is saved.

Quantification process

The quantification of the height of the available sample signals are integrated with QUAN program of the MAT95S Workstation. Here, the retention times given by the software are compared with the retention times during the measurement. When the check is completed, the chromatographic peaks are integrated. The calculated data file is saved as "rtx" in the QUAN program. Subsequently the file is transferred by FTP program into ".asc" file. The last one can be executed with Microsoft Excel program. Here, the calculated response factor, the type of measurement and the output data are requested. The saved excel data are finally placed in five sheets providing the following information:

1. *Raw data* - the measured raw data of the "rtx" file
2. *Calculation* – the concentration of each congeners calculated according to (10).

3. *Test report* – summary of the most important values such as the most toxic congeners, sum of the homologues, I-TEQ value and general information for the corresponding sample
4. *Test report II* – information on the limit of detection
5. *Graphic* – figure of the congeners and homologues profiles

Control of the final data

The final data is controlled again. The above mentioned criteria are manually checked, corrected and saved:

- The retention time of the labelled standards and the measured analytes are equal or differ less than ± 3 sec.
- The recovery rate of the used standards is between 50-120%
- The proportion of the two measured intensive isotope mass is less than $\pm 15\%$ of the theoretical value
- The signal/noise ratio of each isomer is higher than 3:1
- The amount of each isomer of the measured sample is 3 times higher than the blank sample

4.4. Statistical Analysis

Statistical Package 3.11g, Kovach Computing Service [101] is used for the Principle Component Analysis (PCA) and Correspondence Analysis (CA).

PCA is one of the best known and earliest methods. That methodology is first described by K. Pearson (1901) as a means of fitting planes by orthogonal least squares and later proposed by Hotelling (1933) for a particular purpose of analysing correlation structures.

The main applications of PCA are: (1) to reduce the number of the variables and (2) to detect structure in the relationship between the variables or to classify the variables. PCA fall under the general heading of factor analysis which have generated the dependence or variation in the responses [102]. Initially defined principle components of a multivariate sample statistically and algebraically are then visualized by a so-called score plot for observation. Samples with similar emissions are located close to each other in the score plot, while those that have divergent emission patterns are located further apart. That analysis is used to reflect on the effect of the different 20 inhibitors on the congener patterns emitted. The current

analysis is performed separately for PCDD PCDF and PCB. No transformation of the data is performed during the statistical analysis.

The first linear component of the observation is that linear compound of the responses whose sample variance is maximal for all coefficient vectors normalized.

The second linear component is perpendicular to the first, and so on (Fig. 4.8).

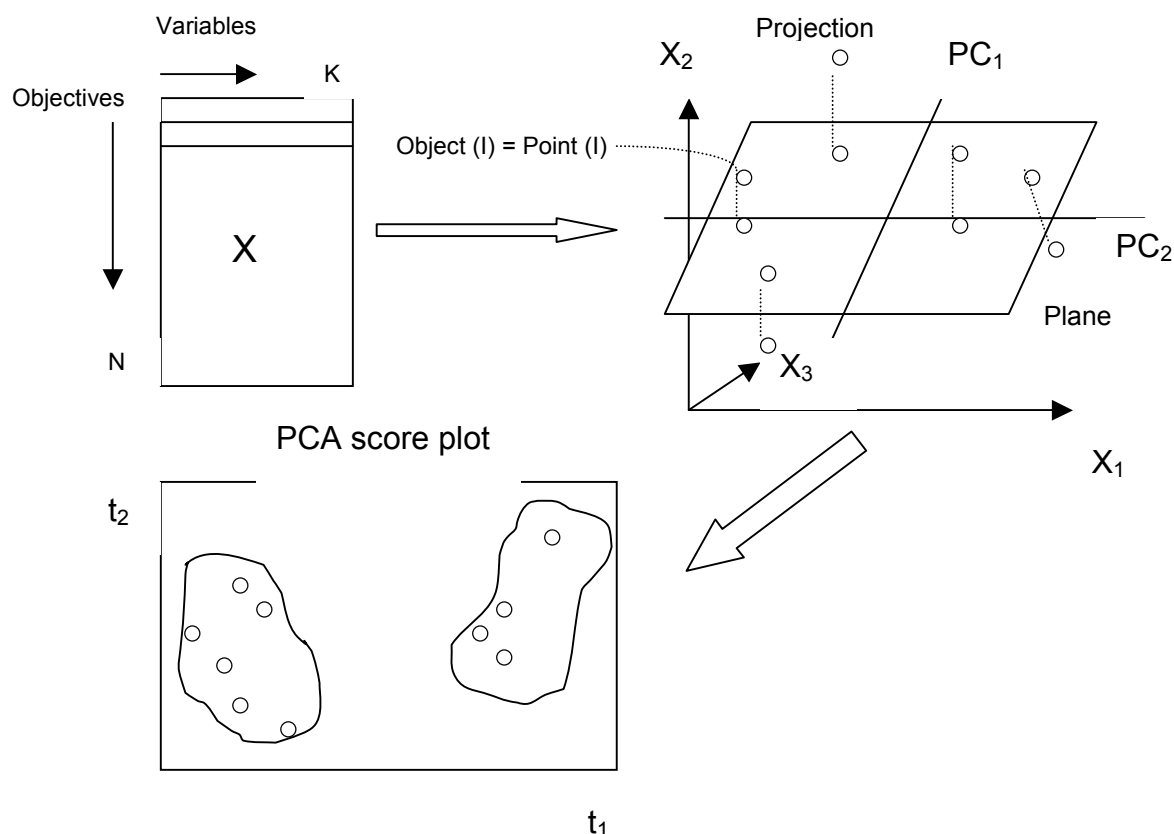

Fig. 4.8. Schematic representation of PCA.

Generally principal components are those linear combination of the responses which explain progressively smaller portion of the total sample variance. Geometrically the principal components are the new variates specified by the axes of a rigid rotation of the ordinal response coordinate system into an orientation corresponding to the direction of maximum variance in sample scatter configuration. The eigenvalue for the first axis is the largest, the second the second largest and so on [101]. Recommendable is when the first two or three axes account for a large proportion of variance of 50-60% or more. In some cases the first axis might account for over 90-95% of the variance.

Correspondence Analysis is a exploratory technique designed to analyse simple two-way and multi-way tables containing some measure of correspondence between the rows and columns. The purpose of CA is to reproduce the distances between the row

and/or column points in a two-way table and multi-way tables in a lower-dimensional display. The result provide information which is similar in nature to those produced by factor analysis and it allow to explore the structure of categorical variables included in the table. Important are the distances of the points in the two-dimensional display. That row points which are closer to each other reflect of their similarity regarding to the pattern. Obviously the final goal of CA is to find theoretical interpretation for the extract dimension. The effect result of CA is usually to find the most correlated variables (congeners and homologues) between the PCDD, PCDF, PCB and PCBz data. No transformation of the data is performed during the statistical analysis. CA is performed separately for the groups of samples (higher and lower toxicity) visualized prior by the PCA score plot. Points resulted closer to each other in CA score plot are additionally observed for their coefficient of determination (R^2) in a two-dimensional graphic. That method provide easier discussion about the best correlations among the set of different congeners and PCDD, PCDF, PCB and PCBz homologues.

5 Results and Discussion

5.1. Pilot Scale Sampling

5.1.1. Quality of the Data

The repeatability of the emission sampling can not be estimated because the operation parameters of the equipment are not constant. In order to control the repeatability, isochronously another sampling of independent accredited institute has to be performed. The comparison of the measured data is sufficiently assessed when the sampling and analytical values are repeatable.

Analytical data

The quality of the analytical data followed the above mentioned criteria (4.4.4, Control of the final data).

Recovery Rate

The recovery rate indicates the losses of the sample during its preparation such as rinsing of the glassware, extraction, clean-up. That grade show a statement of the quality of the final result. The recovery rate regard the rate of the marked standards corresponding for the sample. According US-EPA the recovery rate of the internal standard for aromatic and chlorinated aromatic compounds has to be between 40 and 120% [103] . In Table 5.1. the average recovery rate of the internal standard for the measured classes compounds is shown.

Tab. 5.1: Recovery rate of the internal standard for the analyzed compounds (PCDD/F data n=22, PCB data n= 8)

Analyst	Isotop labelend internal standard	Recovery rate (%)
PCDD/F	DiCDD-OCDD; TriCDF-OCDF	61-113
PCB	MCB-DCB	48-60

According VDI 2066, DIN EN 1948 and DIN EN 13284-1 [104], [105] the recovery rate of the sampling standard should be around 100% and even more than 100%. The maximal value is 120%. It is generally known that the recovery rate for the lower chlorinated and high-volatile compounds is lower than for the low volatile compounds. The reason can be found in the physical-chemical properties of that compounds and their high absorption affinity to the laboratory materials used (glassware, chemical absorbents). In Table 5.2. the average recovery rate of the sampling standard is calculated.

Tab. 5.2: Recovery rate of the sampling standard (n=22)

Sampling standard	Recovery rate (%)
DiCDD-OCDD; TriCDF-OCDF	72-104

Blank value

For every sampling campaign a blank sample is prepared. It supplied a value for the contaminations during the clean-up procedure of the glassware, absorbents, solvent and etc. The preparation procedure of the blank sample is the same as for all other samples.

Sampling data

The quality of the sampling data followed the above mentioned criteria (4.1.3. Validation of the sampling measurement).

Blank value

Two different blank samples are performed during the sampling campaigns explained in this study (Tab. 5.3.).

Tab. 5.3: Blank samples during the sampling campaigns

Sample number	Type blank sample	PCDD/F I-TEQ	PCB I-TEQ
0111008	Sampling without fire	0.71 pg/Nm ³	-
0201023	glassware	11.6 pg/sample	0.19 pg/sample

The PCDD/F amount of sample No. 0111008 is the amount of the dioxins in the sucked volume gas flow of the chimney examined at room temperature. During that sampling, the system is prepared for normal sampling campaign but no combustion is running. The sample is not analysed for PCB.

Sample No. 0201023 is a blank sample for the PCDD/F and PCB amount of the used glassware. Here, the sampling device and glassware are connected and ready for sampling but no sucking procedure was applied. Later all pieces are disconnected and processed for further rinsing, clean-up and analysis procedures as normal emission samples. The PCDD/F and PCB amount of that sample is used for validation of the other emission samples.

Back-up Cartridge

Low amounts of the PCDD/F in the back-up cartridge ensure good sampling practice. The achieved control proof that the analysed aromatic compounds are absorbed efficiently into the XAD-2 cartridge. The back-up cartridge is used during the training period, for the first No 2 - 6 sampling campaigns (Tab. 5.4.). The samples are

analysed for PCDD/F. It is accepted that the percentage of PCB amount in the back-up cartridge compared to the total sample, is not differ out from the received value for PCDD/F. During the performed sampling campaign No 2-6, only the back-up cartridge of sample 0201022 (campaign 4) is analysed for PCB.

Tab. 5.4: Comparison of the PCDD/F I-TEQ value of the back-up cartridge and the total emission sample

Sampling campaign	Back-up sample number	PCDD/F I-TEQ (pg/m ³) Back-up	PCDD/F I-TEQ (pg/m ³) Total sample *	% of the total sample
2	0111007	2.1	547	0.38
3	0112007	324	105520	0.31
4	0201021	254	17909	1.42
5	0201024	75.8	30809	0.25
6	0202018	371	14662	2.53

* total sample - glass wool and resin cartridge PCDD/F amount

Resin and glass wool cartridge

During the sampling campaigns No. 2-3 and 7-9, resin and glass wool cartridges are used (see Tab.4.1.). All the samples are analysed separately for PCDD/F and the samples corresponding to sampling campaigns No.7-9 are analysed also for PCB. The final results pointed out dominating PCDD/F and PCB amount in the glass wool cartridge compared to the resin XAD-2 cartridge (Tab.5.5.). The percentage of the PCDD/F and PCB I-TEQ value of the resin cartridge to the total sample is strongly dependent of the combustion conditions during the sampling. Very low PCDD/F content (0.9%) in the resin cartridge of campaign No.3 is estimated. It means that that sampling is characterized by a highly sooty gases which are mostly trapped into the first glass wool cartridge. According to the PCB data in Tab. 5.6., it seems that the XAD-2 cartridge absorbed more aromatic PCB compounds in comparison to the PCDD/F. During campaign No. 8, the PCDD/F amount in the resin cartridge is about three times lower than the PCB amount in the same sample.

Tab. 5.5: Comparison of the PCDD/F I-TEQ value of the resin XAD-2 cartridge and the total emission sample

Sampling campaign	PCDD/F I-TEQ (pg/Nm ³) resin cartridge	PCDD/F I-TEQ (pg/Nm ³) glass wool cartridge	PCDD/F I-TEQ (pg/Nm ³) total sample	% of the total sample
2	141	406	547	25.78
3	950	104570	105520	0.90
7	359	1076	1435	25.02
8	48.3	988	1036.3	4.66
9	5820	27489	33309	17.47

Tab. 5.6: Comparison of the PCB I-TEQ value of the resin XAD-2 cartridge and the total emission sample

Sampling campaign	PCB I-TEQ (pg/Nm ³) resin cartridge	PCB I-TEQ (pg/Nm ³) glass wool cartridge	PCB I-TEQ (pg/Nm ³) total sample	% of the total sample
7	9.7	53.4	63.1	18.16
8	5.4	25.1	31.5	17.70

Isokinetic ratio

The isokinetic ratio provide a standardization and a better comparability of the results. Furthermore the sampling error is minimized by using an automatic sampling system especially in processes with fluctuations and dust in the exhaust gas. The automatic system makes a continuous adaption to the velocity of the exhaust gas possible. With the fixed nozzle diameter and the varying gas velocity, the flow rate is regulated by the evaluation and the control unit by adding ambient air. The system is qualified for an isokinetic sampling according guideline VDI 2066 and EN 1948 [100], [106], [107], [104]. The calculated isokinetic ratios of the performed sampling campaigns are presented in Tab. 5.5. The values are based on the manual and automatic steering data during the sampling.

Tab. 5.7: Calculated isokinetic ratio during the sampling campaigns

No. of sampling campaign	Isokinetic Ratio	No. sampling campaign	Isokinetic Ratio
1	1.12	6	1.32
2	1.12	7	1.45
3	1.76	8	1.81
4	1.34	9	1.83
5	1.40	10	1.70

Regulation difference between calculated and measured sampled gas flow rate for MRU 4000 sampling system

The error of the MRU system between the actual and calculated gas flow rate called regulation difference is found as less than 5% [108]. The sample gas flow rate is calculated with the formulas above (10). The measured gas flow rate is acquired from the gas volume meter. It delivers electrical impulses to the control unit, proportional to the gas volume which is sucked through. Fig. 5.1. show the adjustment of the measured to the calculated standard sample gas flow rate.

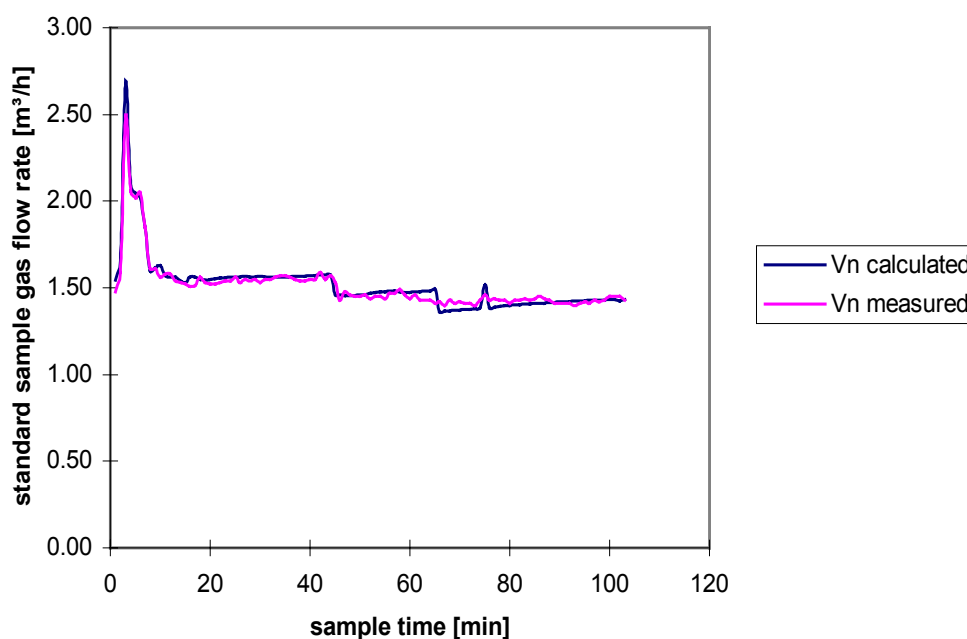

Fig. 5.1: Measured and calculated standard sample gas flow rate after a wood incinerator [108]

Discussion

The quality of the results concerning the analytical part can be characterized as very good. The recovery rate of the internal and sampling standard is assumed as expectable according the above mentioned guidelines for emission sampling.

The quality of the results concerning the sampling part are also estimated sufficiently. Proof of real competence in the field of emission sampling is the successful accreditation from the accreditation body for chemistry in Germany DACH (Deutsche Akkreditierungsstelle Chemie GmbH) on January 2003.

The amount of the blank value is lower than 10% of the limit value for PCDD/F for the flue gas $0.1 \text{ ng I-TEQ/Nm}^3$ [109]. The calculated PCDD/F values for all emission samples are lower than 10% of the blank samples.

The amount of the back-up cartridges show negligible percentage compared to the total sample. That result is a good evidence that the sampled gas during the campaigns is efficiently absorbed of the glass wool and / or XAD-2 cartridge and the final PCDD/F and PCB values are valid.

Another important parameter for the quality of the sampling data (even not included in the validation of the sampling measurements) is the sampled PCDD/F and PCB amount of the resin and glass wool cartridge. Generally such as first trap units such as the condensate flask and the glass wool cartridge are able to absorb most of the aromatic compounds formed during the emission sampling. Nevertheless, the amount of the PCDD/F and PCB in the resin cartridge should be also sufficient. For example, the poor gaseous PCDD/F absorbance in the resin cartridge of campaign No.3 should be taken in account for further investigations. During that campaign the temperature of the chimney is 500°C and high CO₂ and CO gas content is detected. That conditions stimulated the soot formation.

The PCB in the resin cartridges of the above mentioned No. 7 and 8 campaigns is higher compared to the PCDD/F. Explanation of that fact can be based of the physical-chemical properties of PCB molecules.

The estimated isokinetic ratio is most of the times more than 1. It means that the measured gas flow rate is lower than the theoretical one according equation 9. Furthermore the measured gas flow rate is strongly dependent on the velocity in the chimney and the dynamic pressure according (7) and (8).

As it was explained above a ventilator is used like a source of gas flow. By its operation during the first sampling campaigns a negligible velocity and dynamic pressure in the duct is estimated ($v = 0.4 \text{ m / s}$, $p_{dyn} = 0.01 \text{ mbar}$). That cause often a termination of the working of MRU program prior the automatic sampling start. In such cases manual steering of the sampling system where the sample gas flow rate is adjusted by manual regulation with ambient air is also sufficient. In order to avoid that troubleshooting, the ventilator is changed by a stronger one with options for different levels of air flow. It became possible to sample at different sample flow rates, according the equation (8) and to perform automatic sampling.

Here, it should be mentioned that often the fluctuations of the operation parameters related to the sampling (temperature, dynamic pressure, velocity) are varying during the combustion processes. In such cases the automatic steering rather than manual

is more practical. It responds immediately to any alterations parameters in the duct. Therefore a continuous isokinetic sample gas flow rate is guaranteed and a representative sampling is possible.

The calculated low regulation difference between calculated and measured sampled gas flow rate present MRU 4000 sampling system such as suitable apparatus for emission sampling.

5.1.2. Influence of Combustion Parameters on the Formation of PCDD/F and PCB in a Pilot Incinerator

The proposed objectives in this study to find a mechanism of dioxin prevention and the appropriate adjustments for optimum combustion conditions and minimum chlorinated hydrocarbon emission, required sufficient knowledge about the influence of combustion parameters on the dioxin formation.

A revaluation of Austrian national emission inventories performed in 1997 showed that domestic heating with wood is the third largest source of PCDD/F followed by emissions from metallurgical industry [110] and according to the European Emission Inventory [111], wood combustion is one of the most important air emission sources of dioxins. That is why the below mentioned investigations are performed in a domestic oven used for wood incineration. Different combustion conditions are applied in order the optimal parameters of dioxin formation to be determined.

Combustion temperature

Four sampling campaigns of poplar wood incineration were performed at different temperatures. The samples are analyzed at HRGC/HRMS and the I-TEQ PCDD/F values (pg/Nm^3) of all samples are calculated (Fig. 5.2.). Negligible amount of dioxins is measured for the samples at 150°C and higher values are detected at 250°C and 300°C. The amount of PCDD/F is about three fold more compared to the result at 500°C.

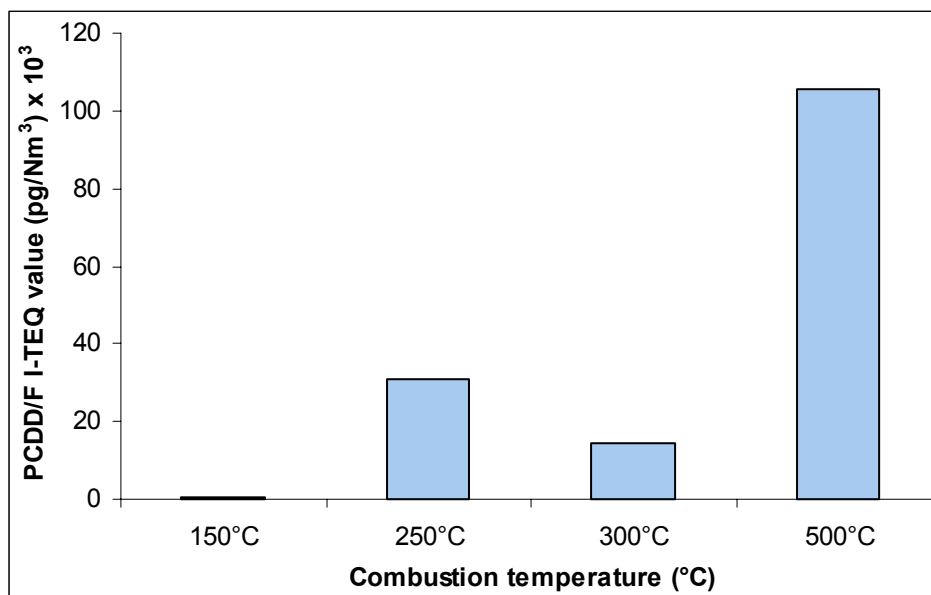

Fig. 5.2: PCDD/F I-TEQ value (pg/m³) in poplar wood combustion at different temperatures

Another three sampling campaigns of poplar wood and 10% PVC were performed at different temperatures. The samples are also analyzed at HRGC/HRMS and the I-TEQ PCDD/F values (pg/Nm³) of each samples are calculated (Fig. 5.3.).

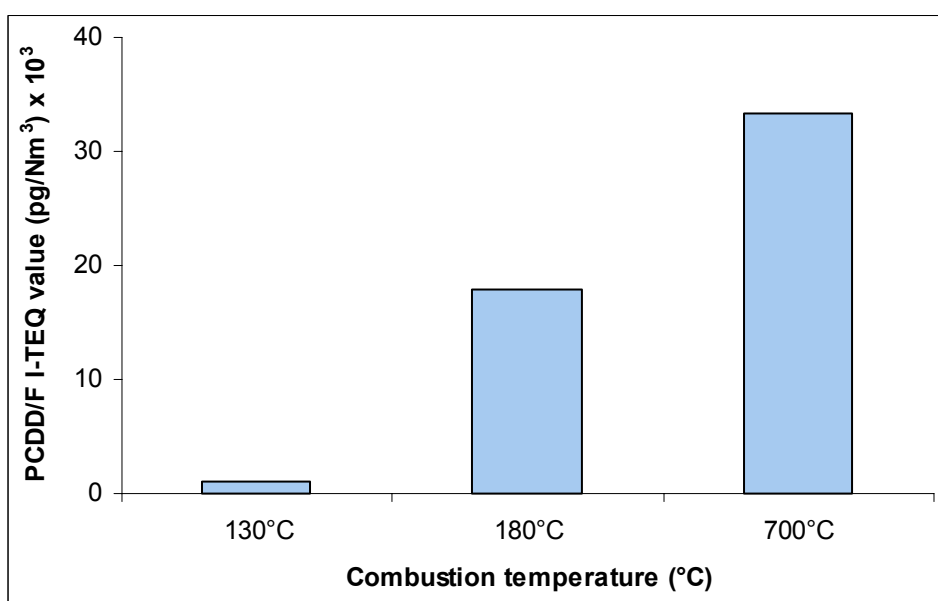

Fig. 5.3: PCDD/F I-TEQ value (pg/m³) in poplar wood and 10% PVC combustion at different temperatures

Low amount of dioxins is measured for the samples at 130°C and much higher at 180°C. Poplar wood and PVC combustion at 700°C show around two times higher PCDD/F amount compared to the result at 180°C.

The three wood and 10% PVC sampling campaigns are also analyzed for PCB compounds. The resulted values are shown in Fig. 5.4. and the final PCB concentration for each sample is converted in I-TEQ (pg/Nm^3) value. It is noticed that the ratio between the toxicity of the samples corresponding their PCB amount is different compared to the PCDD/F values (Fig. 5.4.). Here, the PCB I-TEQ value for the sample at 130°C is at negligible amount. At 180°C the PCB concentration is increased but that value is still around 3 times lower than the same value at 700°C . The PCDD/F distribution show less than 2 times prevail of the sample combusted at 700°C . That two comparison show weak correlation between PCDD/F and PCB of the investigated wood and PVC combustion samples.

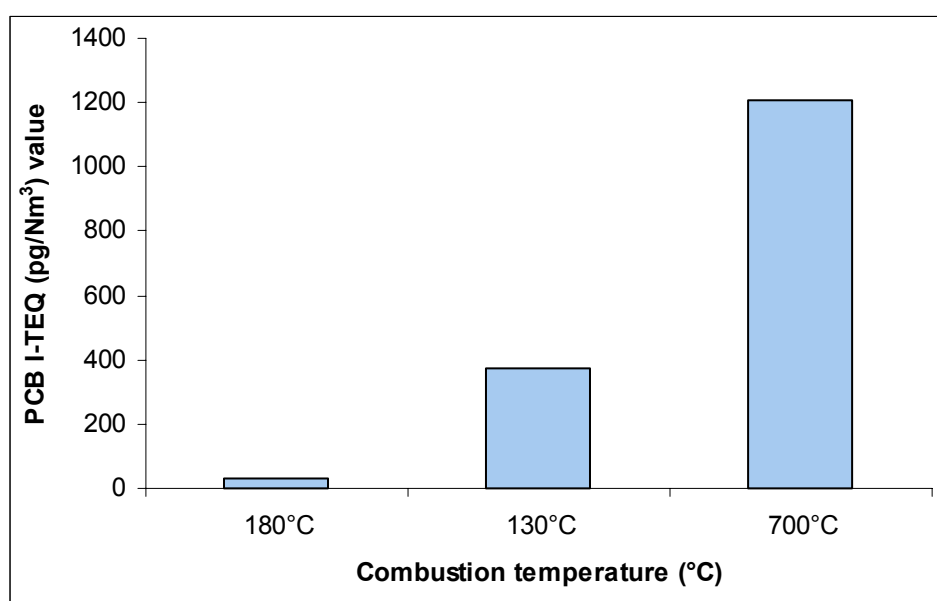

Fig. 5.4: PCB I-TEQ value (pg/m^3) in poplar wood and 10% PVC combustion at different temperatures

Chlorine in feed

The chlorine content of fuel is obviously an important parameter affecting the PCDD/F formation. Four different sampling campaigns were performed in order to prove the effect of the chlorine in the feed (Fig. 5.5).

These sampling campaigns of wood combustion and 10% PVC were performed at similar temperatures such as 130°C and 150°C ; 180°C - 200°C . The produced dioxins in wood / 10% PVC combustion are slightly higher at 130°C compared to the PCDD/F I-TEQ values at 150°C during the wood combustion campaign. Wood / 10% PVC combustion gives much higher PCDD/F values even at 180°C compare to the amount at 200°C in wood combustion. The toxicity of the sampling campaign

performed with chlorine in the feed is as 12 times as high than the one without chlorine in the feed.

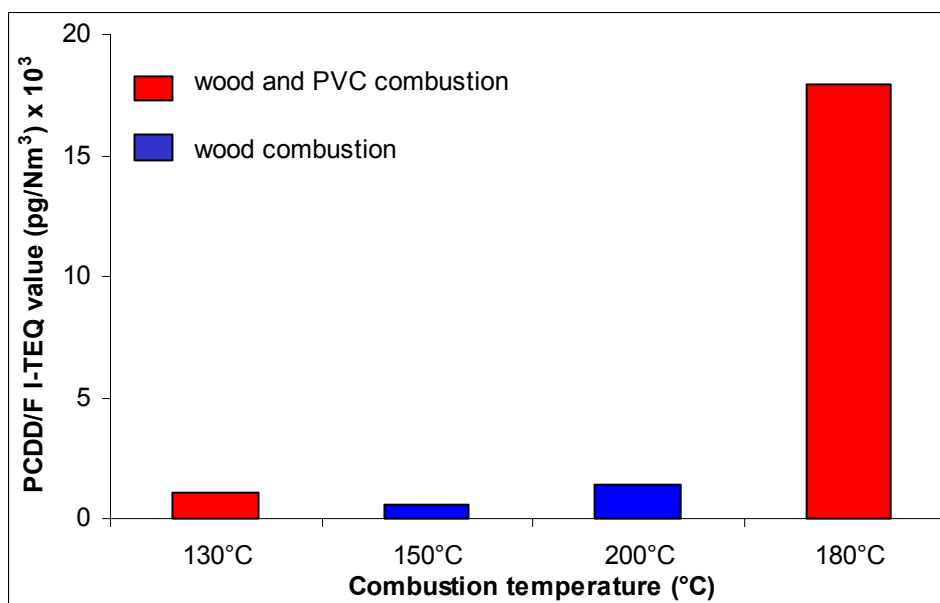

Fig. 5.5: PCDD/F I-TEQ value (pg/m³) in wood and wood/10% PVC combustion campaigns at similar temperatures

O₂, CO₂ and CO content

The flue gas concentration and the PCDD/F I-TEQ values of four sampling campaigns in wood/ 10% PVC combustion were studied in order to find out the correlation between them (Fig. 5.6).

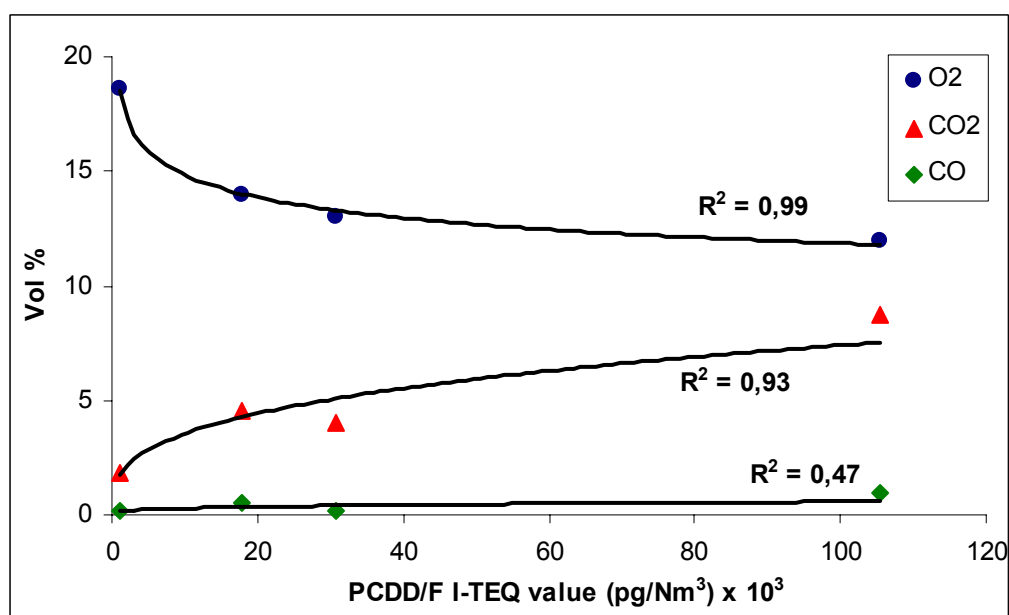

Fig. 5.6: Correlation between PCDD/F I-TEQ value (pg/m³) and O₂, CO₂ and CO gas concentration (Vol %) in wood/10% PVC combustion campaigns

O₂, CO₂ and CO were analyzed just before sampling on TESTO gas analyzer. Because of problems with the instrument during some of the sampling campaigns, not all combustion tests have been analyzed for the mentioned gases.

It is obvious that with increasing PCDD/F concentration, the volume percentage of the CO₂ is augmenting slowly from around 1 Vol% to around 9 Vol%. The opposite effect is observed for the analyzed O₂ concentration which drops from 19 Vol% to 12 Vol%. CO is mainly zero or slightly increased with the increase of the toxicity of the investigated samples. Very good correlation $R^2 = 0.93 - 0.99$ is found between O₂ and CO₂ gases and PCDD/F I-TEQ value. A weak dependence has been calculated for the CO concentration and PCDD/F emissions

Discussion

The experimental results of the performed sampling campaigns show that temperature of 200-500°C promotes PCDD/F formation while temperature greater than 700°C destroy the same substances. At temperatures between 130°C and 200°C the PCDD/F amount is negligible. These conclusions are in a good agreement with the *de novo* theory and the experimentally confirmed high emissions of PCDD/F in the temperature range of 250-450°C. The *de novo* theory suggests that the combustion of organic matter at high temperature of 750-1000°C and a short period of cooling from the incinerator to 300°C is a main source of PCDD/F [31]. Such conditions of fast cooling flue gases chimney are met in the investigated sampling campaigns. Probably at that time leaving the chamber gases were involved in surface reactions including different compounds of incomplete combustion and in combination with the condensate processes the high dioxins emissions were caused. Temperature of 500°C is found as a optimal temperature for PCDD/F formation in such type of incineration. Stimulated combustion conditions in an Entrained Flow Reactor by Wikström have shown also a maximum rate of PCDD/F between 300-400°C [46].

Tuppurainen have observed that the amount of PCDD/F does not depend on the temperature in the range of 750-1200°C because their destruction is already completed [9]. This means that dioxins are not thermodynamically stable at high combustion temperature. At such temperature the dioxins emission is minimized because some dehalogenation reactions is favour. The proposed results show also

lower PCDD/F I-TEQ values at 700°C compared to the same values at 500°C for example.

The PCB results for the sampling campaigns of wood and PVC incineration show much lower I-TEQ values compared to the dioxins concentration. Explanation of that is the lower PCB toxic equivalent factors (TEF) in comparison to the TEF for dioxins. The toxicity ratio in dependence of PCB and PCDD/F concentration is also different for the different samples. This gives the idea of different formation mechanisms of PCB and PCDD/F. The same statement by the help of statistical analysis is also proposed by Blumenstock [51]. Different emission samples of waste wood chips sampled in a waste incineration plant display no correlation between these two classes of toxic compounds.

When wood and 10% PVC are combusted at 180°C, enormous difference in PCDD/F emissions is detected compared to at 200°C. Because of the lower temperatures at 130°C and 150°C the effect of the chlorine in the fuel can not be accounted for or it is slightly noticed. Generally the known precursor theory and *de novo* synthesis involved always chlorine in order to explain the PCDD/F formation. Hence state that the dioxin formation will be an inevitable process unless chlorine can be completely eliminated [9]. The influence of the chlorine in the fuel mixture such as PVC and inorganic chlorine such as NaCl and the different percentage of such chlorine additives is widely investigated by Wikström [52] [46] [112]. All conclusions suggest that chlorine evolved mostly as HCl promote dioxin formation. Atomic chlorine is quite reactive and therefore it may react with the surface of carbonaceous material such as lignin of the wood to form species which can continue to react and form PCDD/F.

On the basis of the sampling campaigns that were carried out it has been found that CO₂ concentration in the flue gas is positively, and O₂ concentration is negatively correlated with the PCDD/F emissions. This dependence affect the I-TEQ value or the toxicity of the examined samples. The same relationship has been also found by Lenoir [47] investigating the influence of the operating parameters on PCDD/F emissions in a fluidized bed incinerator. The experimental results of Fängmark show that high level of O₂ resulted in less effective formation of PAH, PCDD/F, PCB and PCBz [50].

Nevertheless the recent findings show that CO and CO₂ are no surrogates of PCDD/F formation [9]. *De novo* synthesis suggests that in processes of gasification

of the carbon in the fuel the major products are CO and CO₂. Further condensation processes in the post combustion zone form some byproducts such as a variety of organic compounds including PCDD, PCDF, PCB, PCBz and etc.

5.3. PCDD, PCDF and PCB Homologues Profiles

Knowledge of the congeners patterns and homologues profiles of PCDD/F and PCB is important because the toxicity is related to the concentration distribution of the 17 congeners that are fully chlorinated with in the 2,3,7,8 positions. To understanding the mechanism of how chlorine partitions among the homologues is able to reduce or increase formation of PCDD/F and PCB and/or reduce or increase the concentration of the 17 congeners that comprise the toxic equivalency (TEQ) value. The effort of the work here is to predict both PCDD/F total (sum of tetra- to octa CDD/F concentration) and TEQ values and PCB total (sum of mono- to deca CB) and TEQ values. Sampling results of wood and wood and PVC combustion and different operation conditions (temperature, gas content, etc.) are used to establish a tool for understanding of the mechanism of PCDD/F and PCB formation and to find methods and controls to prevent their formation.

A pattern analysis has been performed for PCDD and PCDF for the 7 sampling campaigns. The percentage of the homologue pattern for PCB for 3 sampling campaigns is also calculated. The results are presented separately for PCDD and PCDF in Fig. 5.7 and Fig. 5.8. and for PCB in Fig. 5.9.

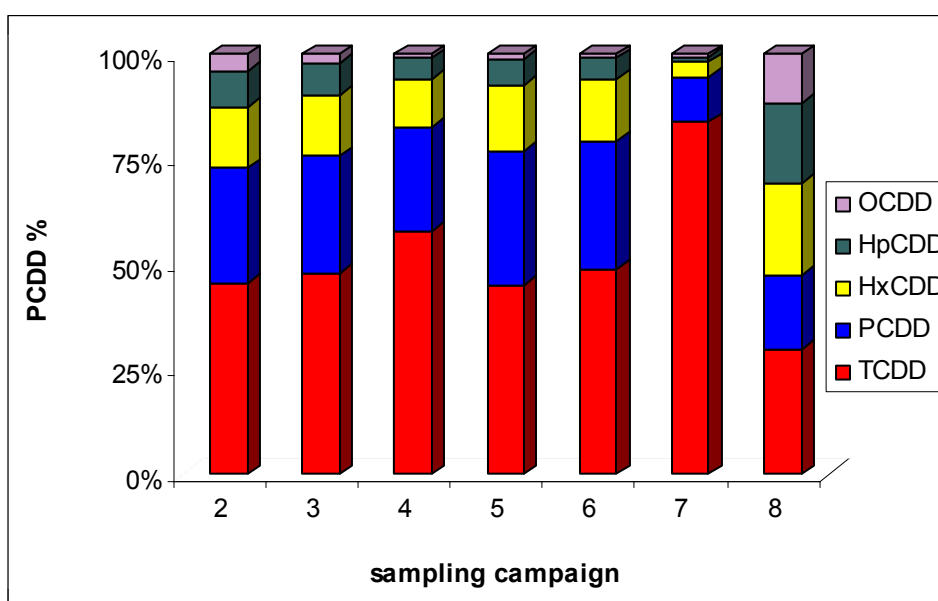

Fig. 5.7: Percentage of PCDD homologues mass distribution of the sampling campaign No.2-8.

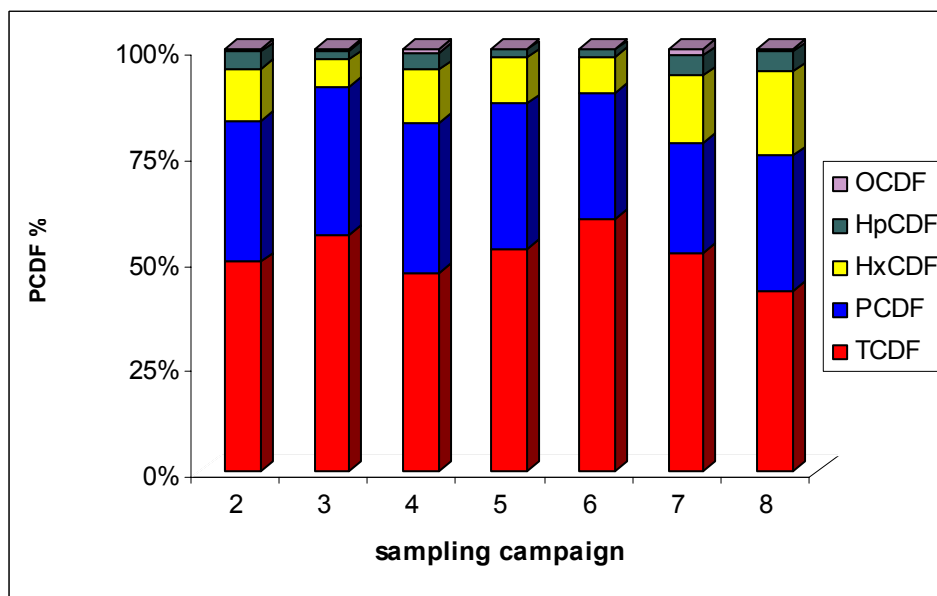

Fig. 5.8: Percentage of PCDF homologues mass distribution of the sampling campaign No.2-8.

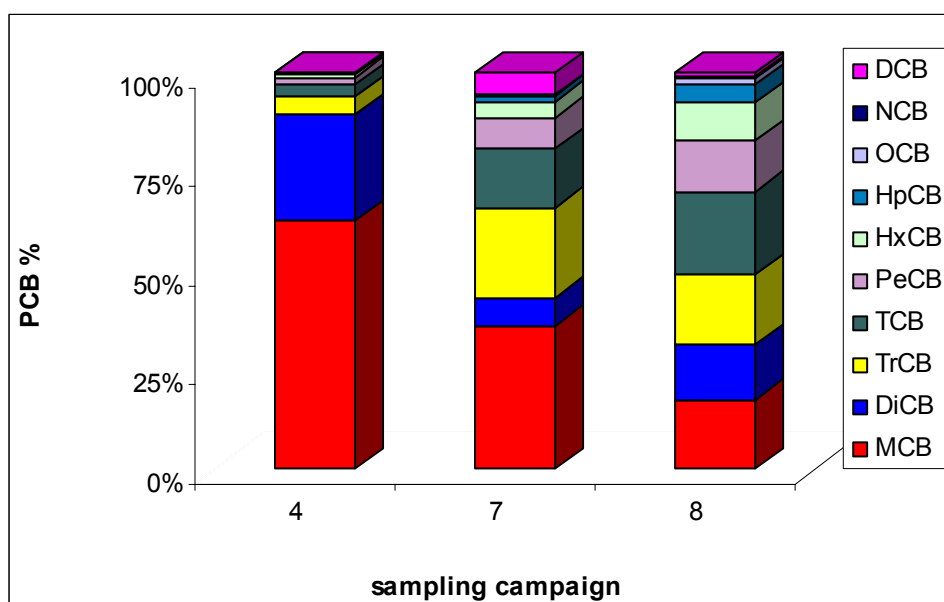

Fig. 5.9: Percentage of PCB homologues mass distribution of the sampling campaign No.4,7 and 8.

Fig. 5.7 shows that for all samples TCDD is the dominant homologue followed by PCDD. HxCDD and HpCDD are present with comparable low percentages but OCDD is almost everywhere in negligible amount. It is observed that sampling campaign 8, shows very different results for its PCDD pattern. Here, all chlorinated PCDD homologues is present with similar percentage. That sampling campaign is performed at 700°C during wood and PVC combustion. In 5.2 it was mentioned that probably during this sampling, destruction reactions of PCDD/F already have occurred. Very high TCDD percentage of around 85% is estimated for sampling

campaign No. 7. This sample belongs to wood and PVC combustion at 130°C. It is known that at that temperature the PCDD/F formation is still not active and here the measured I-TEQ value is low. The other wood and PVC sampling campaign No. 4 is characterized also by a different and slightly higher percentage for TCDD pattern compared to the same TCDD homologue measured during wood combustion.

The percentages of the PCDF homologues shown in Fig. 5.8. indicate very similar results. The dominance of the PCDF homologues is of the following order: TCDF>PCDF>HxCDF>HpCDF>OCDF.

The percentage of MCB-DCB homologues during the three wood and PVC sampling campaigns is drawn in Fig. 5.9. The pattern analysis shows very different results for the three samples. Sample No. 4 is an example for optimal conditions of PCDD/F and PCB formation (Fig. 5.3. and Fig. 5.4.) while during sampling campaign No. 7 the PCDD/F and PCB are not formed. Sample No.4 exhibits high percentage for MCB and DiCB. The other PCB patterns such as TrCB - NCB for that sample are present at lower amount compared to lower chlorinated benzenes. The DCB homologue is zero percent. For sample No. 7 the weight patterns are MCB and TrCB followed by TCB. All other chlorinated benzenes are present at lower percentages. DiCB is characterized here at a negligible amount of around 5%.

At 700°C during sampling campaign No. 8, the PCDD/F and PCB are already destroyed. The pattern analysis for that sample shows similar percentages during the mono – tetra CB. From penta - deca CB the percentage of these homologues is sufficiently decreased from 13% to 0.33%.

Discussion

The experimental results manifest that for all emission samples the lower chlorinated dioxins and furans such as TCDD/F and PeCDD/F prevail over the higher chlorinated ones, in agreement with the typical homologues pattern from combustion processes [2, 113, 114]. The same statement is also true for PCB homologues patterns. Cycloaddition of two chlorophenyl radicals gives polychlorinated biphenyls and PCB compounds even at a lower temperature [9]. PCB can be oxidized and are thus possible precursors for PCDF. In general, the reactivity of the higher chlorinated compounds with oxygen is high and this can explain why they are almost absent from all products of incomplete combustion such as PCDD/F, PCB, PCBz etc. During sampling campaign No. 4 the optimal condition of PCDD/F and PCB formation are

met. Thus the measured I-TEQ values are also high. For this sample the most dominant is MCB pattern and the abundance of the followed homologues gradually decrease.

The pattern PCDD/F and PCB analysis remains difficult to explain the results regarding the homologues amounts for sample No. 8. Probably because of the higher temperatures some decomposition reactions are preponderant and other mechanisms take place. Thus, the typical homologues pattern for combustion processes are also destroyed. An example where the incineration conditions are characterized by low combustion temperature, high O₂ and low CO₂ and CO gas content or generally conditions which are not optimal for PCDD/F and PCB formation, is sample No. 7. In addition the aromatic compounds can participate in various decomposition reactions where the amount of the oxygen is stoichiometric or less. Then, the final products are carbon dioxide and water and the PCDD/F and PCB I-TEQ values are very low. For sample No.7 also the pattern analysis shows particularly different results compared to the homologues pattern of sample No.4. The result of Fig. 5.6. show very high TCDD amount. That can be explained only by the higher total sum amount of the rest TCDD isomers. A peculiarity for sample No. 7 is also the PCB homologues behaviour. Normally the most dominant compounds for such emission samples are the lower chlorinated benzenes [114] and their dominance decrease with increasing the chlorine in the benzene ring. For sample No.7 this distribution is not observed. Here, the most abundant homologue are MCB and TrCB, the next dominant homologues are TCB and DiCB is present with a negligible percentage. Lenoir proposed that via condensation reaction in the post-combustion zone in the gas phase, molecular growth reactions of alkyl and chlorinated vinyl radicals might turn out to be important reaction channels to formation of chlorinated aromatics [36]. In the same work it is also mentioned that the octachlorinated PCDD/F isomers are supposed to be formed first, while the other dioxins are subsequently produced through dechlorination of the higher chlorinated isomers. So it is possible that the same mechanism is also valid for the PCB formation. This can explain why MCB and especially DiCB are present at lower percentage for sample No.7.

PCDD, PCDF and PCB Concentrations. Congeners profile

The actual concentrations of the investigated aromatic compounds presented in (pg/Nm^3) for the 7 sampling campaigns are additionally calculated. The view of such type analysis makes possible to look over the ratio between the dioxin/furan and to find the differences between sample to sample according their congeners pattern. The congeners whose concentrations which correlate strongly with the corresponding high or low TEQ of the samples can be easily detected.

The sum of the PCDD and PCDF homologues for the 7 emission samples are shown in Fig. 5.10 (A) and (B).

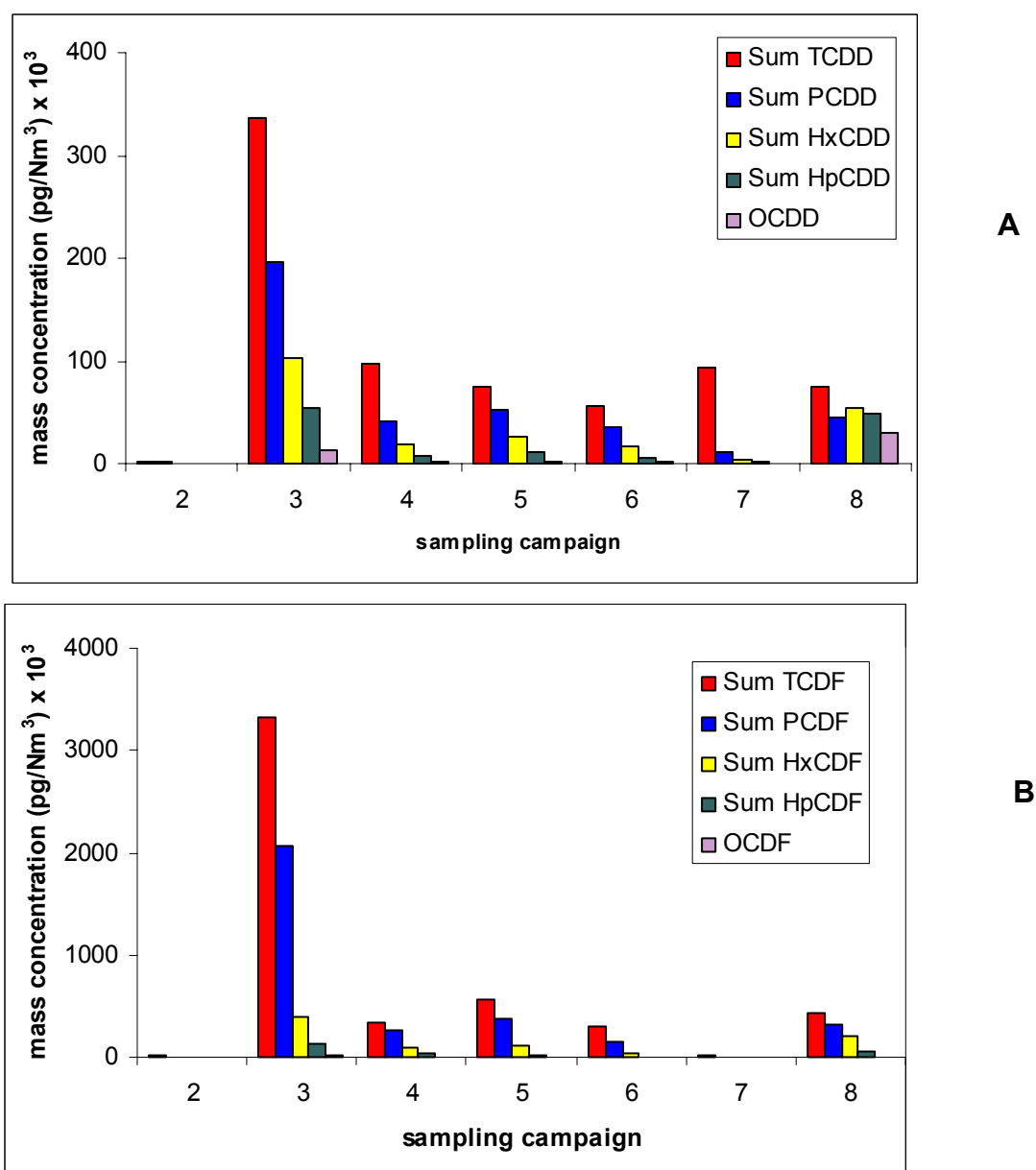

Fig. 5.10: Sum of tetra-octa PCDD (A) and sum of tetra-octa PCDF (B) for sampling campaign No. 2-8

It is clear that the PCDF content is higher than the PCDD amount for all samples. The estimated exhibit ratio is 9 times more abundant furans than dioxins. Sample No. 3 is representing the most abundant PCDF in an emission sample. In the other samples the PCDD amount is about 5 times less compared to PCDF.

It is obvious that samples No. 3-6 in Fig. 5.10. (A) and (B) decrease gradually their tetra to octa chlorinated PCDD and PCDF amount. Samples No. 2 and 7 are present with low PCDD/F amount but the distribution of the chlorinated homologues is similar to that of the other sample. The much higher sum of TCDD for sample No. 7 is an exception among the other PCDD/F homologues. Samples No 2 and 7 belong to samples with lower TEQ. According to Fig. 5.10. (A) and (B) samples 8 has similar to samples 4,5 and 6 abundance. However the TCDD-OCDD distribution of the chlorinated dioxins for this sample is different. In Fig. 5.11. (A) the amount of PeCDD to OCDD for sample No. 8 is similar.

The sums of mono to deca polychlorinated biphenyls (PCB) concentrations (pg/Nm^3) for samples No. 4,7 and 8 are shown in Fig. 5.11.

The comparison of the PCB amount in Fig. 5.11 with that of Fig. 5.10 where the sums of PCDD/F homologues are shown, lead to the conclusion that the concentration of PCB compounds in sample No. 4 is much higher than that of dioxins and furans. These are mainly mono and dichlorinated biphenyls present.

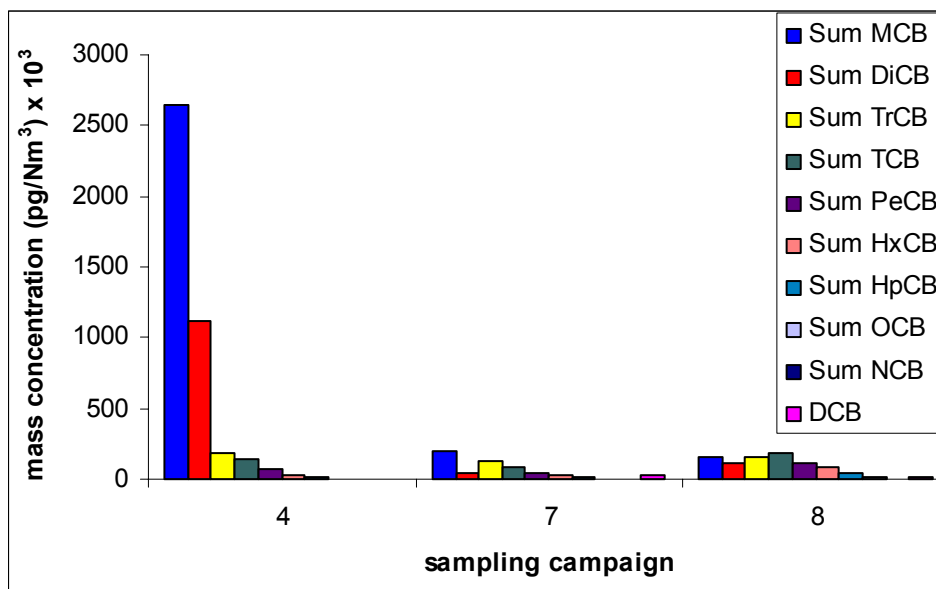

Fig. 5.11: Sum of mono-deca PCB for sampling campaign No. 4,7 and 8.

Sample No. 7 is identified with low PCDD/F and PCB values. It is noticed that sample No. 8 has lower PCB amount compared to PCDF and similar to PCDD value.

According to the high PCB I-TEQ value (Fig. 5.4.) of sample No 8, also here in Fig. 5.11. high abundances PCB homologues supposed to be detected. Probably the explanation could be the high abundance of some PCB congeners presented with high TEF. Thus, a knowledge of the concentrations of the 12 toxic PCB isomers is indispensable. The distribution of these isomers for the three emission samples is shown in Fig. 5.12.

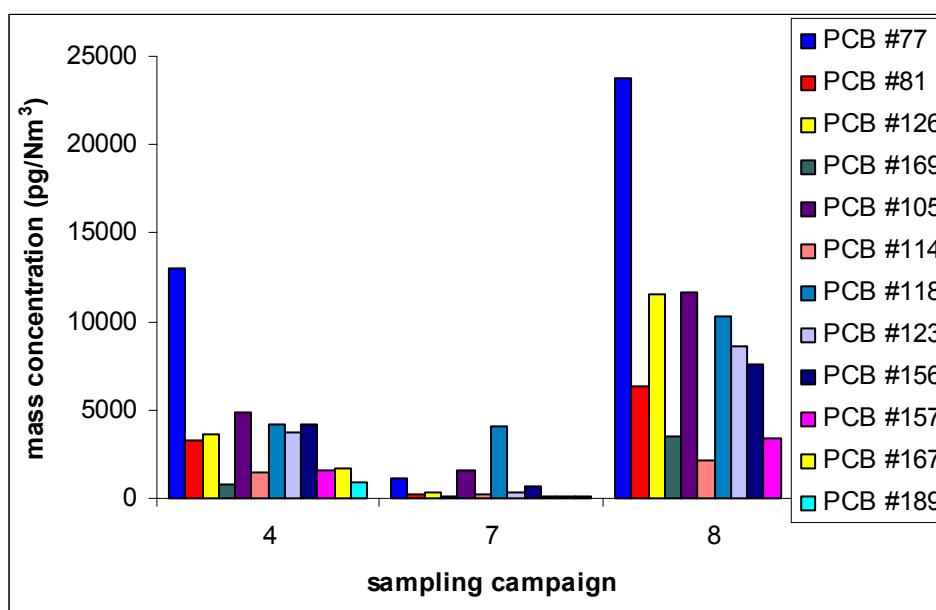

Fig. 5.12: Mass concentration of the 12 toxic PCB congeners for samples No. 4, 7 and 8

Since PCB #126 is the most toxic congener (TEF=0.1) the PCB I-TEQ is strongly dependant of the concentration of that isomer. The next isomer with also high TEF = 0.01 is PCB #169. Fig. 5.12 shows that both congeners are highly present in sample No.8. Thus, the measured I-TEQ amount is also high and considering the sum of the PCB homologues makes clear that the concentration of the rest non-toxic PCB isomers is low. Sample No. 8 is present with highest PCB emissions for the 12 toxic congeners. Low values for the mentioned congeners are detected for sample No. 7, and slightly higher values are measured for sample No. 4.

The mass concentrations (pg/Nm³) of the 17 toxic PCDD and PCDF isomers for samples No. 2-8 are shown in Fig. 5.13. The recent values shows the strong correlation between the PCDD/F I-TEQ amount and some of the most toxic congeners like 2,3,7,8-TCDD, 1,2,3,7,8-PCDD and 2,3,4,7,8-PCDF. The more abundant the congeners such as 2,3,7,8-TCDD, 1,2,3,7,8-PCDD and 2,3,4,7,8-PCDF are the more toxic the corresponding samples are. Such examples are samples No. 3 and 8 which are present with a high emission of the above mentioned congeners. Both samples are presented also with a high amounts of 1,2,3,4,6,7,8-HpCDD and

OCDD. Samples No. 2 and 7 show also a negligible or almost zero PCDD/F amount for the 17 toxic congeners. These results are in a good agreement with their I-TEQ values. The other samples No. 4,5 and 6 are also present with comparable 2,3,7,8-TCDD, 1,2,3,7,8-PCDD and 2,3,4,7,8-PCDF amount like their PCDD/F I-TEQ values.

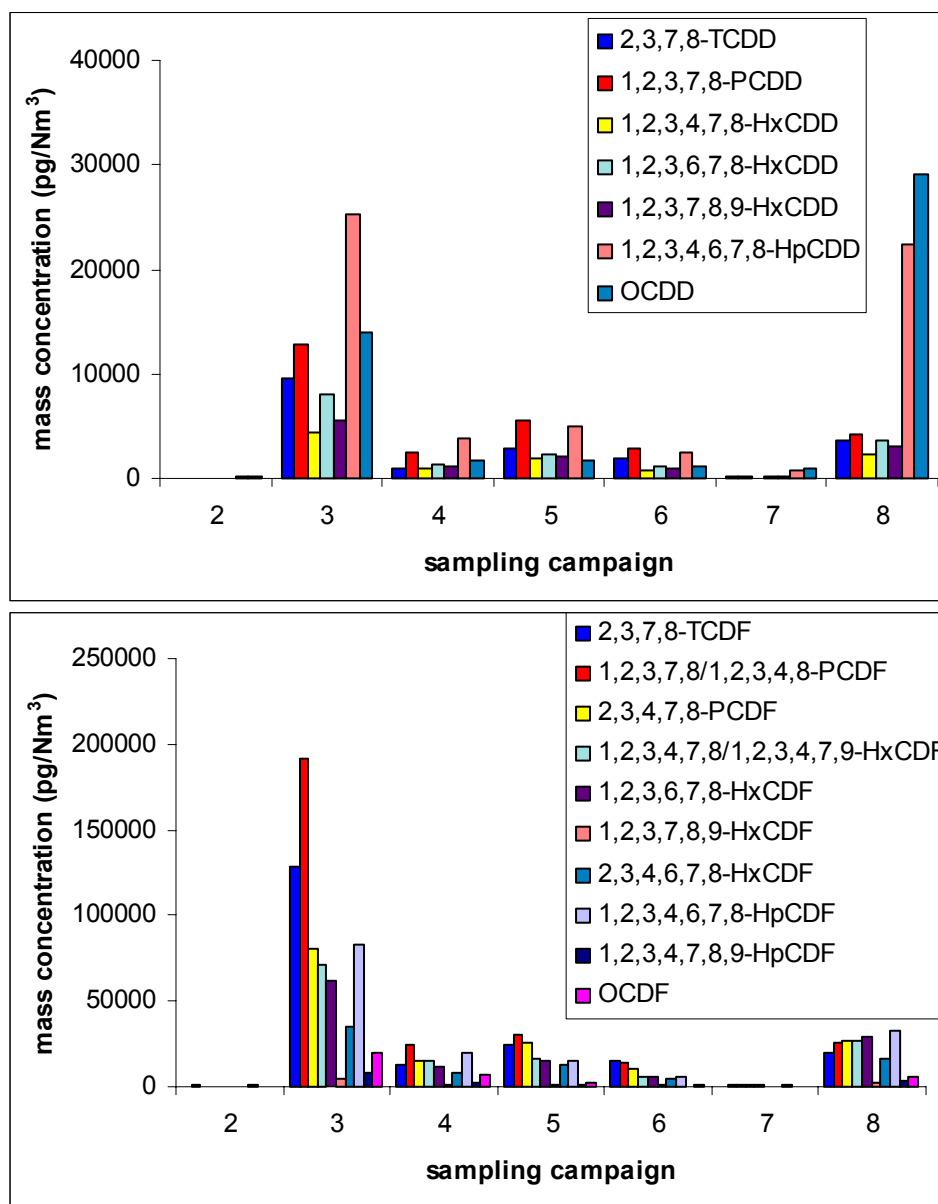

Fig. 5.13: Mass concentration of the 17 toxic PCDD/F congeners for sample No. 2-8.

Discussion

The PCDF concentrations of the 7 emission samples are between 5-9 times higher than the concentrations of PCDD. Recent finding in pilot plant incinerators indicate similar PCDD/PCDF ratios for different combusted emission samples [2, 65, 115, 116]. Huang has compared de novo synthesis and the precursor theory and has

proposed that the typical homologues profile for de novo synthesis in actual incinerators is present if the furan/dioxin ratio is higher than 1. In contrast in formation from precursors small amounts of furans are produced and the furan/dioxin ratio is smaller than 1 [29] .

In addition, as shown in Fig. 5.11., the lower chlorinated PCDD/F homologue pattern prevailed over the higher chlorinated, in accordance with the typical profile from combustion process. The same findings are also valid for sample No. 4 and No. 7 concerning their PCB homologues profile. Relatively low PCB abundance and high I-TEQ are estimated for sample No. 8. This is due to the higher concentrations of most toxic congeners #77, #126 #169 and #105. The rest isomers and generally the mono-deca homologues are shown in Fig. 5.10 at low amounts.

The most toxic congeners all over the PCDD/F such as 2,3,7,8-TCDD, 1,2,3,7,8-PCDD and 2,3,4,7,8-PCDF show a good correlation with PCDD/F I-TEQ value for all samples.

5.2. Laboratory scale experiments

In this study, a laboratory-scale furnace is used to perform a series of experiments aiming at prevent the formation of PCDD/F by the use of inhibitors. The objective of this work is to identify the most effective low cost and low toxicity inhibitors for PCDD/F, making them applicable for use in full-scale combustion units. A mixture of lignite coal, solid waste and PVC is combusted in a laboratory-scale furnace at 400°C. The most effective inhibitor is also studied at 1000°C.

5.2.1. Optimization of the experiment

Laboratory experiments are known to be very sensitive scale to different factors. Thus, the executed procedure should be carefully identified and carried out in the same manner each time in order to achieve reproducible results. The parameters of main importance are: homogenization of the fuel, fuel content, temperature, air flow and duration of the experiment. Blank samples are generated frequently. The analytical procedure includes clean-up steps and further quantification analysis of PCDD/F, PCB and PCBz is performed on a HRGC/HRMS. Many different experiments are performed in order to elaborate the optimum procedure where the emitted toxic emissions are high enough to study the inhibition processes.

Homogenization of the combustion fuel

Fuel mixture of 10g lignite coal (80%) and solid waste (20%) is combusted at 300°C with 2 L/min air flow for 15 min. Prior to the experiment, each fuel of sample 0206016 is stirred with a mechanical mortar to generate a particle size of less than 1mm. Another sample 0206015 with non stirred solid waste is also combusted employing the same procedure. Both samples are analyzed for PCDD/F. The difference between the results are quite large. Sample 0206015 shows much higher PCDD/F values than sample 0206016 (Tab 5.8).

Tab. 5.8: PCDD/F I-TEQ value (pg/g) of homogenized and not homogenized combusted fuel samples

Sample number	PCDD/F I-TEQ
0206015	4.75
0206016	0.33

Combustion temperature

The content of compounds added to the fuel was 10%. The results of the most toxic 17 PCDD and PCDF congeners for these samples are shown in Fig. 5.14.

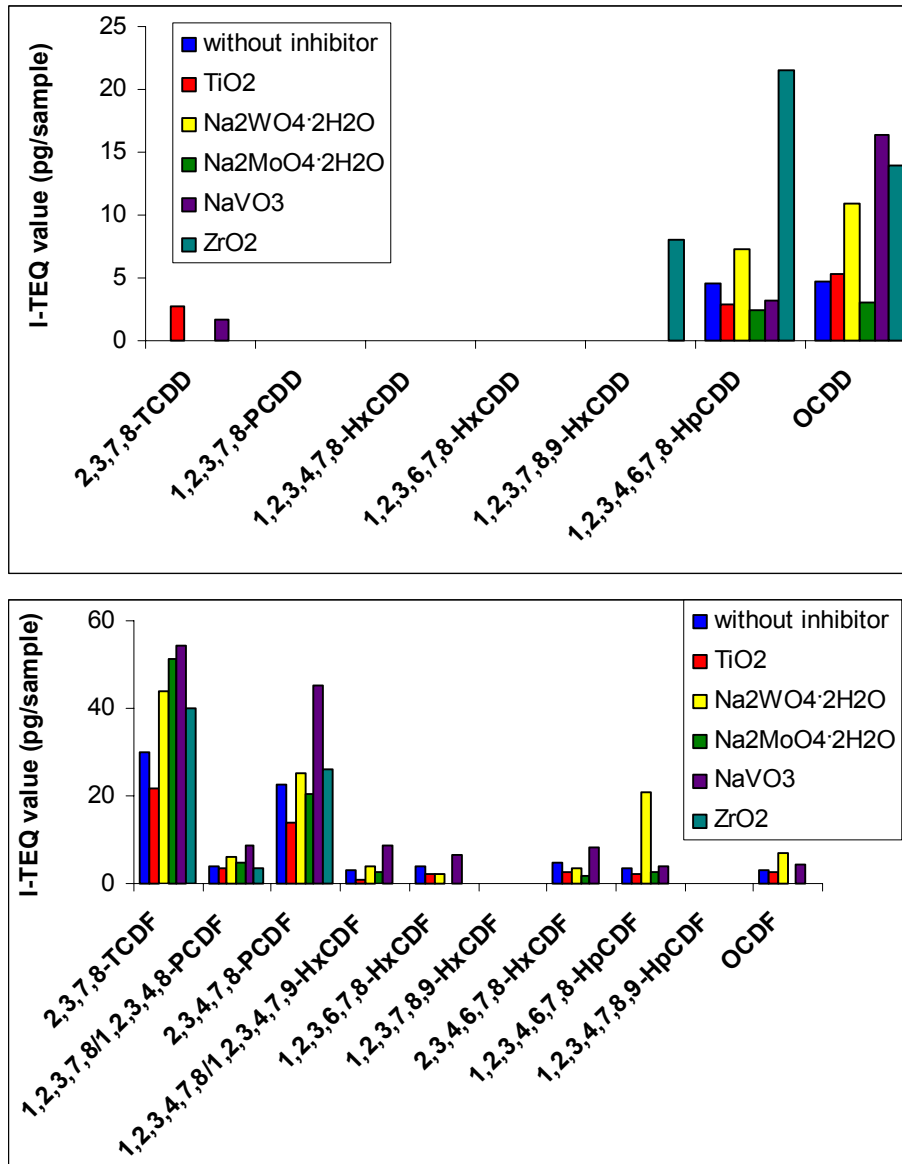

Fig. 5.14: I-TEQ values (pg/sample) of the 17 toxic PCDD and PCDF congeners emitted during fuel combustion at 500°C in a laboratory scale furnace.

Before the optimization of the operation procedure for combustion, temperature of 500°C, duration of the experiment 15 min and 2 L/min air flow were used to investigate the effect of TiO₂, Na₂MoO₄·2H₂O, Na₂WO₄·2H₂O, NaVO₃ and ZrO₂ as inhibitors.

Fig. 5.14. shows that the most toxic TCDD, PeCDD and HxCDD and some HxCDF and HpCDF congeners are not detected in the sample treated without inhibitor. The lack of these values means that the performed combustion procedure is not favorable for the PCDD/F formation. Thus, the effect of the used inhibitors cannot be further discussed. However, TiO_2 and NaVO_3 show some low values for the most toxic PCDD/F isomer 2,3,7,8-TCDD. This result should be taken into account for further experiments where these two compounds are used as inhibitors. It was also noticed that results for the sample without inhibitor are not always the highest values compared to the corresponding results of the five samples treated with inhibitors.

Samples of 10g stirred lignite coal (80%) and solid waste (20%) were combusted for 15 min at 400°C with 2 L/min air flow (sample number 0206022). The resulting PCDD/F and PCB I-TEQ values are compared to the results at 300°C and 500°C in Tab. 5.9.

Tab. 5.9: PCDD/F and PCB I-TEQ values (pg/g) for samples combusted at 300°C, 400°C and 500°C.

Sample number	Combusted T°C	PCDD/F I-TEQ	PCB I-TEQ
0206016	300°C	0.33	
0206022	400°C	2.03	0.27
0207001	500°C	1.58	0.03

According to the presented data, the highest PCDD/F and PCB values are detected at 400°C. The laboratory scale results are in disagreement with the pilot scale incineration where the sample with the highest PCDD/F and PCB emissions is achieved at 500°C.

Fuel material

Although a temperature of 400°C is the optimum for dioxin formation in the laboratory scale furnace the emissions are still not very high. Thus, the addition of PVC to the lignite coal / solid waste mixture is mandatory. On the basis of the pilot scale wood incineration, it is already known that PVC can highly increase the toxic emissions during its cofiring. Therefore the chlorine containing fraction of the fuel mixture is 20% with a 13.3 : 6.7 ratio of the solid waste to PVC. PVC was present with a particle size <1mm.

Duration of the experiment

After each experiments the fly ash of the samples was weighted with a balance. It is noticed that at the end of the 15 min combustion at 400°C and 500°C the residues fuel were only 15-20% of the total sample. Thus, extension of the time or an increase of the air flow is required. It was found that 2 L/min air flow is suitable value and 30 min experimental time.

Blank samples

Blank samples are generated before each series of experiments. These results gives information about the memory effect of the furnace. The PCDD/F and PCB I-TEQ values for the performed blank samples are shown in Tab. 5.10.

Tab. 5.10: PCDD/F and PCB I-TEQ values (pg/sample) of the blank samples performed in a laboratory scale furnace

Sample number	Operation conditions	PCDD/F I-TEQ value (pg/sample)	PCB I-TEQ value (pg/sample)
0207023	500°C, 2 L/min air flow, 15 min	2.1	0.26
0208003	400°C, 2 L/min air flow, 30 min	1.8	0.08
0301001	400°C, 2 L/min synthetic air flow, 30 min	0.09	0.09
0307001	400°C, 2 L/min synthetic air flow, 30 min	-	0.32
0310056	1000°C, 2 L/min air flow, 15 min	2.3	0.49

Discussion

On the basis of the above mentioned experiments the optimal operation parameters where the PCDD/F and PCB values are high enough to investigate the effect of inhibition is temperature: 400°C; duration of the experiment: 30 min, air flow: 2 L/min.

At these conditions sample 0208002 was generated. The weight of the fly ash after the experiment was measured to be 5.3 g or about 47 % of the total sample. The evaluated PCDD/F I-TEQ value was 8.74 pg/g and PCB I-TEQ value is 0.58 pg/g. Such high I-TEQ amounts of the most toxic PCDD/F and PCB congeners show that sample 0208002 can be used as a reference sample for PCDD/F and PCB formation.

The results of the blank samples are very low. However, the values for synthetic air as air source are almost negligible or zero.

5.2.2. Effect of various inhibitors

Experiments with a mixture of 80% lignite coal and 20% (13.3 : 6.7 ratio) solid waste and PVC were performed five times. The sample number of that experiments is 0208002, 0209018, 0209019, 0212010 and 0212015. The 20 different compounds investigated as inhibitors are added as 10 % of the fuel. The sample number of the used 10% inhibitors is: 0208004 (TiO_2), 0209007 ($\text{MoNa}_2\text{O}_4 \cdot 2\text{H}_2\text{O}$), 0209024 (NaVO_3), 0209005 (ZrO_2), 0209008 (Al_2O_3), 0209009 ($\text{H}_2\text{NSO}_4\text{H}$), 0209025 ($\text{H}_2\text{NSO}_3\text{H}$), 0209030 (S), 0210171 ($\text{H}_2\text{NSO}_2\text{NH}_2$), 0211001 (pomace), 0211009 (P_2S_5), 0211008 ($\text{Na}_2\text{O}_4\text{W} \cdot 2\text{H}_2\text{O}$), 0211006 ($\text{N}(\text{CH}_2\text{CH}_2\text{OH})_3$), 0211011 ($\text{Na}_2\text{S} \cdot \text{H}_2\text{O}$), 0212007 (Cr_2O_3), 0301002 ($(\text{NH}_4)_2\text{S}_2\text{O}_3$), 0301005 ($(\text{NH}_4)_2\text{HPO}_4$), 0301006 ($(\text{NH}_2)_2\text{CO} + \text{S}$ (1:1)), 0212016 ($(\text{NH}_4)_2\text{SO}_4$) and 0211002 ($[(\text{CH}_3)_2\text{N}]_3\text{P}(\text{O})$).

PCDD/F concentration

The total amounts of PCDD and PCDF generated during the experiments with a mixture of lignite coal, solid waste and PVC are enough to investigate the effect of inhibition along orders of magnitude. The average I-TEQ value of the sum of PCDD/F is about 15 pg/g (Fig.5.15).

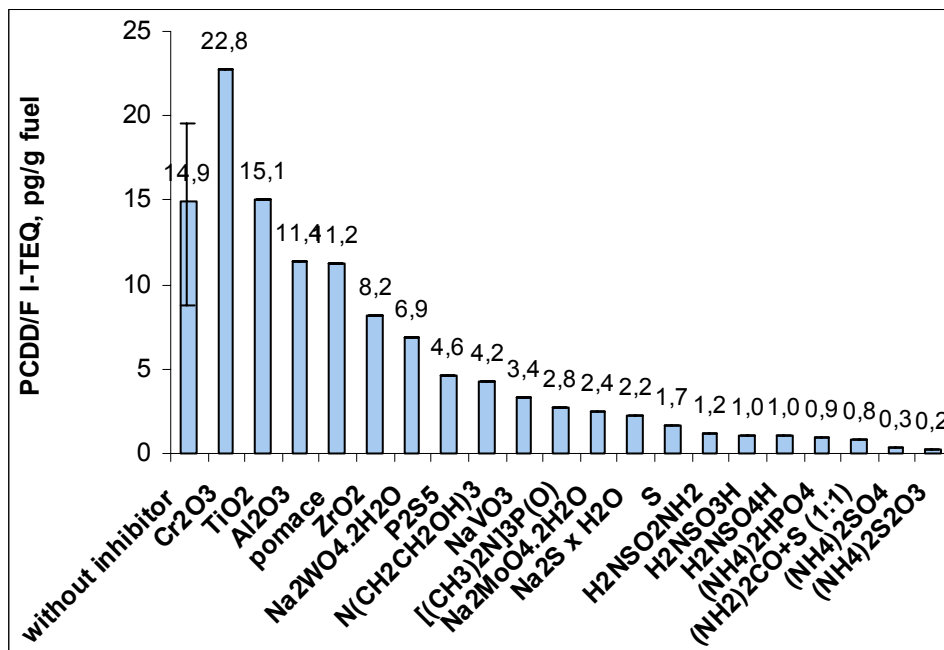

Fig. 5.15: PCDD/F I-TEQ (pg/g) values of the flue gas after combustion of lignite coal, solid waste and PVC for the samples without inhibitor and 20 different compounds used at 10% inhibitor of the fuel.

$(\text{NH}_4)_2\text{SO}_4$ and $(\text{NH}_4)_2\text{S}_2\text{O}_3$ can reduce the PCDD/F emission up to 98-99%. The performed five replicates show a relatively low standard deviation. The experimental

results with 10% inhibitor show very different I-TEQ values. According to Fig. 5.16 some of the compounds led to similar and sometimes higher amount of PCDD/F compared to the samples without an inhibitor. Some other additives show a very strong inhibitory effect in the flue gases.

PCB concentration

The average I-TEQ value of the sum of PCB for the samples treated without inhibitor is about 1 pg/g (Fig.5.16). The five replicates show a relatively low standard deviation similar to PCDD/F.

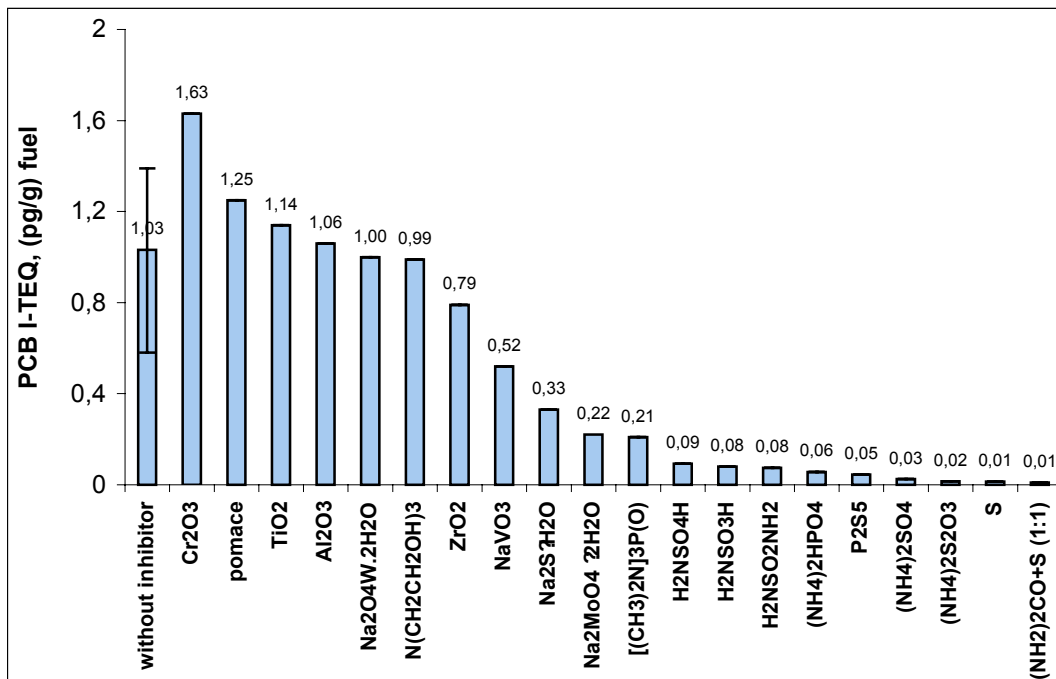

Fig. 5.16: PCB I-TEQ (pg/g) values of the flue gas after combustion of lignite coal, solid waste and PVC for the samples without inhibitor and 20 different compounds used at 10% inhibitor of the fuel.

The experimental results with 10% inhibitor display also for PCB very different, from very high to very low, PCB I-TEQ values. The four compounds placed rightly in Fig. 5.16 can inhibit the PCB emission to up to 97-99%. Two of these compounds $(\text{NH}_4)_2\text{SO}_4$ and $(\text{NH}_4)_2\text{S}_2\text{O}_3$ are show also strong effects of the PCDD/F emissions.

Principle Component Analysis

A statistical method called principle component analysis (PCA) is used in order to give a better view of the similarity between the samples using the concentrations of

the PCDD and PCDF isomers. The statistical score plot for the laboratory-scale experiments with 20 inhibitors is shown in Fig. 5.17.

The matrix for PCDD consists of 37 variables (PCDD isomers) and 25 cases (samples), the matrix of PCDF is comprises 63 variables (PCDF isomers) and 25 cases (samples) and the matrix of PCB consists of 168 variables (PCB isomers) and 25 cases (samples). No transformation of the data was performed during statistical analysis.

Two main groups of samples were observed in the first and second score plots. One group is placed to the right and the other to the left of the ordinate axis. The samples without inhibitor are placed on the right side of the multidimensional space. Neighbouring these toxic samples are some other points, which can be attributed to the metal oxide inhibitors Cr_2O_3 , TiO_2 , Al_2O_3 and pomace. In addition they also belong to the samples with higher concentrations. Near to the ordinate axis and between both groups, other inhibitors as P_2S_5 , $\text{N}(\text{CH}_2\text{CH}_2\text{OH})_3$, $\text{Na}_2\text{WO}_4 \cdot 2\text{H}_2\text{O}$ and ZrO_2 are located. They belong to the N-, S- and metal oxide group. These four compounds are probably additives that manifest low inhibitory effects or samples with high variation of PCDD/F amount.

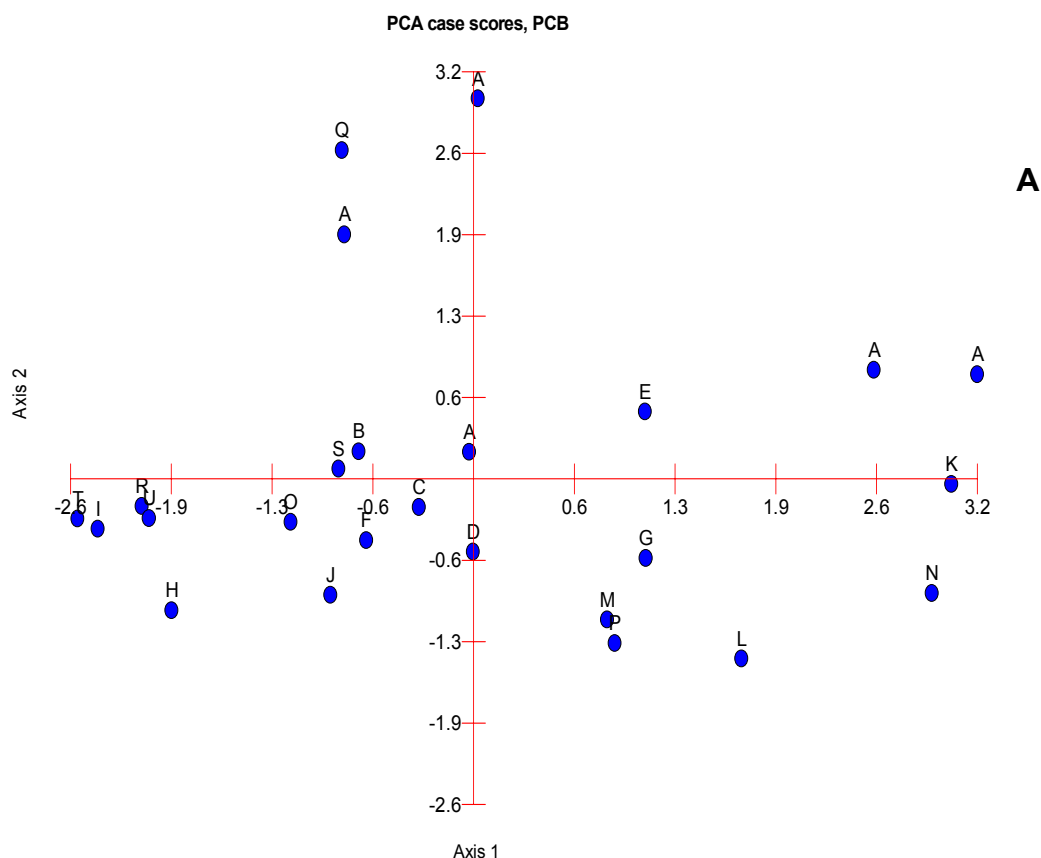

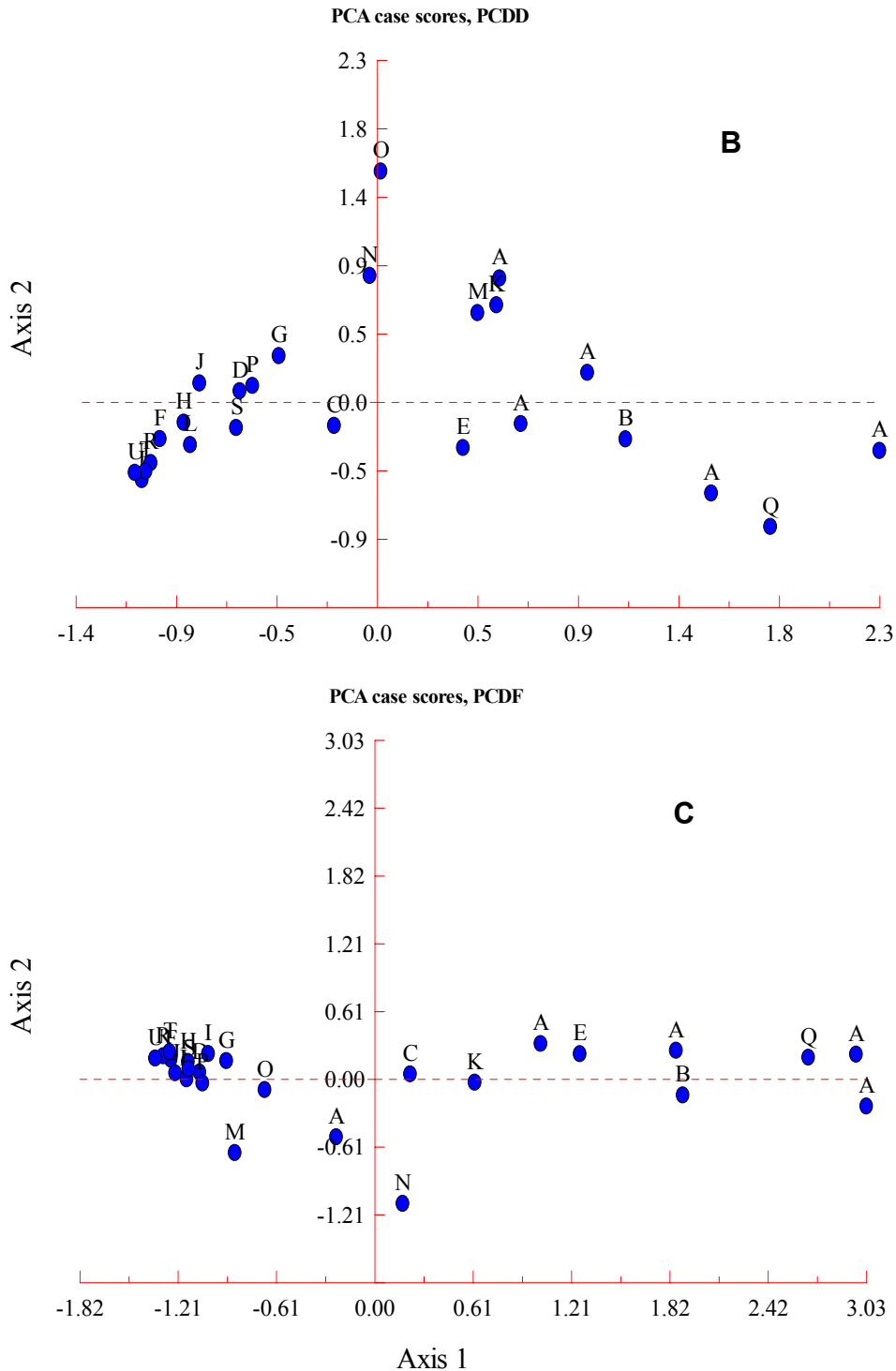

Fig. 5.17: Score plot of PCB (A), PCDD (B) and PCDF (C) of 5 replicates treated without any inhibitor (A) and 20 samples with 10% inhibitor (B- TiO_2 , C- ZrO_2 , D- $\text{Na}_2\text{MoO}_4 \cdot 2\text{H}_2\text{O}$, E- Al_2O_3 , F- $\text{H}_2\text{NSO}_4\text{H}$, G- NaVO_3 , H- $\text{H}_2\text{NSO}_3\text{H}$, I- S, J- $\text{H}_2\text{NSO}_2\text{NH}_2$, K- pomace, L- $[(\text{CH}_3)_2\text{N}]_3\text{P}(\text{O})$, M- $\text{N}(\text{CH}_2\text{CH}_2\text{OH})_3$, N- $\text{Na}_2\text{WO}_4 \cdot 2\text{H}_2\text{O}$, O- P_2S_5 , P- $\text{Na}_2\text{S} \cdot \text{H}_2\text{O}$, Q- Cr_2O_3 , R- $(\text{NH}_4)_2\text{SO}_4$, S- $(\text{NH}_4)_2\text{HPO}_4$, T- $(\text{NH}_2)_2\text{CO} + \text{S}$, U- $(\text{NH}_4)_2\text{S}_2\text{O}_8$)

A highly agglomerated group especially for PCDF score plot is on the left hand side. It includes samples with 10% inhibitor of the fuel, which are all N- and S-containing compounds, and other such as NaVO_3 , $\text{Na}_2\text{MoO}_4 \cdot 2\text{H}_2\text{O}$, $(\text{NH}_4)_2\text{HPO}_4$,

$[(\text{CH}_3)_2\text{N}]_3\text{P}(\text{O})$, S and $\text{Na}_2\text{S}\cdot\text{H}_2\text{O}$. The points are very close to each other which can be explained by the similarity in their pattern and their PCDD/F amount formed.

Here the N-and S- containing compounds are placed much more to the left in the score plot. The more left point in the statistical plot appears, the lower concentration of PCDD/F is found. This effect can also be observed in Fig. 5.15 where the same compounds show a strong inhibitory effect for I-TEQ PCDD/F value in the flue gas. The most agglomerated group especially for PCDF score plot is the left one, representing samples containing the lowest PCDD/F amount with inhibitors used from all N-and S-compounds and other such as $(\text{NH}_4)_2\text{HPO}_4$, $[(\text{CH}_3)_2\text{N}]_3\text{P}(\text{O})$, S, $\text{Na}_2\text{S}\cdot\text{H}_2\text{O}$, NaVO_3 , $\text{Na}_2\text{MoO}_4\cdot 2\text{H}_2\text{O}$, representing N, S, and metal oxide substances. The points are very close to each other which can be explained by the similarity in their pattern and their PCDD/F abundance. The samples treated without any inhibitor, and samples with metal oxides, are spread on the right site of the score plot.

The PCB score plot does not show any agglomerated groups between the samples. The sample points are spread over the multidimensional space which explain their high variability of the 168 PCB isomer. Can be noticed that the samples without inhibitor are placed to the right and along the ordinate axis. Close to these samples are the points of pomace, $\text{Na}_2\text{WO}_4\cdot 2\text{H}_2\text{O}$, $[(\text{CH}_3)_2\text{N}]_3\text{P}(\text{O})$, Al_2O_3 , NaVO_3 , $\text{N}(\text{CH}_2\text{CH}_2\text{OH})_3$, $\text{Na}_2\text{S}\cdot\text{H}_2\text{O}$, $\text{Na}_2\text{MoO}_4\cdot 2\text{H}_2\text{O}$. Most of these compounds belong to the group of the metal oxides. Some of the N-, S- and N-and S-containing compounds such as $(\text{NH}_4)_2\text{HPO}_4$, $\text{H}_2\text{NSO}_4\text{H}$, $\text{H}_2\text{NSO}_2\text{NH}_2$, P_2S_5 and $\text{H}_2\text{NSO}_3\text{H}$ are placed on the left side with respect of the ordinate axis. The samples $(\text{NH}_4)_2\text{SO}_4$ and $(\text{NH}_4)_2\text{SO}_4$; S and $(\text{NH}_2)_2\text{CO}+\text{S}$ are grouped in two couples on the quite left side of the PCB score plot. These compounds show also similar low I-TEQ values as shown in Fig. 5.17.

The 17 Toxic PCDD/F Isomers

It is generally accepted that only 17 out of the 210 dioxin and furan congeners are toxic [117]. A measure for the toxicity of these isomers is the TEF. The calculated value is called the toxic equivalent (TEQ). The TEF of 2,3,7,8,-TCDD TEF is 1, indicating that it is the most toxic congener. Table 5. 11. shows nine of the most effective PCDD/F inhibitors and present a comparison with the samples without inhibitor according their mass concentration value (pg/g) for the 17 toxic PCDD/F isomer.

Since 2,3,7,8- TCDD is the most toxic dioxin it must be considered. The inhibitors which have values below the detection limit for this isomer are: $\text{H}_2\text{NSO}_3\text{H}$, S, $\text{H}_2\text{NSO}_2\text{NH}_2$, $(\text{NH}_4)_2\text{S}_2\text{O}_3$, $(\text{NH}_2)_2\text{CO}+\text{S}$ (1:1) and $(\text{NH}_4)_2\text{SO}_4$. These are also samples with low PCDD/F values in general. Almost all examples with inhibitor additives show non-detectable values for 1,2,3,7,8 – PCDD, 1,2,3,4,7,8 – HxCDD, and 1,2,3,7,8,9 – HxCDF. The HpCDD and OCDD values are slightly higher for the nine most effective inhibitors. These congeners are as a low TEF which contribute less to the final I-TEQ value.

The TEF for 2,3,4,7,8-PeCDF, the most toxic isomer among all PCDF congeners, is 0.5. The smallest detectable value of this isomer was found using $(\text{NH}_2)_2\text{CO}+\text{S}$ (1:1), $(\text{NH}_4)_2\text{SO}_4$ and $(\text{NH}_4)_2\text{S}_2\text{O}_3$ as inhibitors. The latter two inhibitors show undetectable or negligible amounts for all other PCDF homologues. $(\text{NH}_2)_2\text{CO}+\text{S}$ (1:1) together with $\text{H}_2\text{NSO}_3\text{H}$ and S also exhibit very low and sometimes undetectable values for PCDF congeners. All samples have values below the detection limit for 1,2,3,7,8,9-HxCDF.

The average amounts of the 17 toxic isomers in the samples without inhibitor is much higher than in those with inhibitor. Some of the most abundant isomers are 2,3,7,8-TCDD and 2,3,4,7,8-PeCDF, which make them sufficiently toxic for further inhibition experiments. Looking carefully at the values of the 9 inhibitors and their PCDD/F value, it is obvious that $(\text{NH}_4)_2\text{SO}_4$ and $(\text{NH}_4)_2\text{S}_2\text{O}_3$ are the inhibitors with the most diminished PCDD/F amount.

Tab. 5.11: Values of the 17 toxic PCDD/F isomers pg/g fuel for the most effective inhibitors and the average value of the sample without inhibitor (A- H_2NSO_4H , B- H_2NSO_3H , C- S, D- $H_2NSO_2NH_2$, E- $Na_2MoO_4 \cdot 2H_2O$, F- $Na_2S \times H_2O$, G- $(NH_4)_2S_2O_3$, H- $(NH_2)_2CO + S$ (1:1), I- $(NH_4)_2SO_4$)

The 17 toxic PCDD/F isomers	Without inhibitor	A	B	C	D	E	F	G	H	I
		2,3,7,8 -TCDD	0.23	0.15	n.d.	n.d.	n.d.	0.35	0.08	n.d.
1,2,3,7,8 - PCDD	2.12	n. d.	n.d.	n.d.	n.d.	n.d.	0.61	n.d.	n.d.	n.d.
1,2,3,4,7,8 - HxCDD	5.40	0.91	n.d.	n.d.	n.d.	n.d.	n.d.	n.d.	n.d.	n.d.
1,2,3,6,7,8 -HxCDD	1.94	0.83	1.42	0.20	2.03	1.71	1.52	n.d.	n.d.	n.d.
1,2,3,7,8,9 - HxCDD	1.79	0.54	0.55	n.d.	0.76	1.04	1.34	n.d.	n.d.	n.d.
1,2,3,4,6,7,8 - HpCDD	9.83	2.36	4.37	0.52	5.31	5.07	5.65	1.66	2.12	4.01
OCDD	24.54	6.22	11.20	0.54	12.50	10.40	12.80	6.85	8.14	16.6
2,3,7,8 - TCDF	38.44	1.13	1.53	4.48	0.78	3.87	3.65	0.57	1.41	1.09
1,2,3,7,8/1,2,3,4,8 - PCDF	11.37	0.22	0.28	1.04	0.24	0.83	1.08	n.d.	1.02	0.14
2,3,4,7,8 - PCDF	9.42	0.99	1.06	2.00	1.35	2.38	1.45	0.24	0.28	0.22
1,2,3,4,7,8/1,2,3,4,7,9 - HxCDF	3.21	0.29	0.25	0.59	0.46	0.49	0.45	n.d.	0.03	n.d.
1,2,3,6,7,8 - HxCDF	3.05	0.06	0.26	0.35	n.d.	0.33	0.30	n.d.	0.09	0.17
1,2,3,7,8,9 - HxCDF	0.45	n.d.	0.07	n.d.	n.d.	n.d.	n.d.	n.d.	n.d.	n.d.
2,3,4,6,7,8 - HxCDF	1.82	0.37	0.29	0.50	0.47	0.59	0.40	n.d.	0.08	0.20
1,2,3,4,6,7,8 - HpCDF	1.57	0.28	0.30	0.15	0.33	0.37	0.56	0.21	0.06	0.34
1,2,3,4,7,8,9 - HpCDF	0.23	n.d.	n.d.	n.d.	n.d.	0.09	0.50	n.d.	n.d.	n.d.
OCDF	0.74	0.82	n.d.	n.d.	0.34	0.37	n.d.	n.d.	0.42	n.d.

The 12 Toxic PCB isomers

It is generally accepted that only 12 out of the 210 PCB congeners are toxic. The toxicity rating of these isomers is reflected by their toxic equivalent factor, or TEF. The calculated value is called the toxic equivalent (TEQ). The TEF of 3,3',4,4',5-PeCB (#126) is 0.1 indicating that it is the most toxic congener. It is followed by the other very toxic congener 3,3',4,4',5,5'-HxCB (#169) which TEF is 0.01. Table 5. 12 shows four of the most effective PCDD/F inhibitors and compares to the samples without inhibitor according their mass concentration value (pg/g) for the 12 toxic PCDD/F isomer.

Tab. 5.12: Values of the 12 toxic PCB isomers pg/g fuel for the most effective inhibitors and the average value of the sample without inhibitor (A-S, B-(NH₂)₂CO +S (1:1), C-(NH₄)₂SO₄, D- (NH₄)₂S₂O₃)

The 12 toxic PCB isomers	Without inhibitor	A	B	C	D
PCB #77	166.64	8.04	23.10	5.24	9.84
PCB #81	28.82	1.48	n.d	n.d	n.d
PCB #126	9.08	n.d	n.d.	n.d.	n.d.
PCB #169	1.40	n.d.	n.d.	n.d.	n.d.
PCB #105	106.90	16.30	19.60	43.60	30.50
PCB #114	13.68	n.d.	n.d.	n.d	n.d.
PCB #118	318.12	37.90	46.20	107.00	86.40
PCB #123	40.52	4.18	2.72	9.17	7.59
PCB #156	64.42	1.52	1.74	7.77	5.08
PCB #157	7.80	n.d.	n.d.	n.d	n.d.
PCB #167	8.62	1.13	n.d.	1.97	0.13
PCB #189	8.25	0.89	n.d.	n.d	n.d.

The observed inhibitors are the samples with very low PCB I-TEQ values (Tab. 5.12.). These inhibitors show values below the detection limit for the most toxic #126 and #169 isomers. All inhibitor compounds show non- detectable values for #114 and #157. Seven of total 12 toxic PCB congeners are non-detectable for (NH₂)₂CO+S (1:1), (NH₄)₂SO₄ and (NH₄)₂S₂O₃ proposed as inhibitors in Tab. 5.12. Taking into account their similar low I-TEQ values (Fig.5.17) and the current values, it's obvious that these three compounds can successfully suppress the PCB emissions.

Discussion

Twenty different compounds subsumed into four different types of groups according to their chemical nature are studied as inhibitors of PCDD/F and PCB in flue gases of lignite coal, solid waste and PVC combustion. This method is simpler than others where the inhibitor is sprayed into the post combustion zone, resulting in significant disturbances of large incineration plants. The effect of inhibitors is studied here empirically, and mechanistic studies are under way. The results show that the substances belonging to the metal oxide group have no inhibitory effect. Some of the additives such as Cr_2O_3 , Al_2O_3 and TiO_2 could even slightly increase the PCDD/F emissions. This fact can be explained by the mechanism of the de novo reaction for PCDD/F formation. The catalyst is a transition metal, such copper, iron or one of the oxides of these metals. It seems that the metal oxides can also promote the de novo reaction. They produce very high amounts of the most toxic isomers and a high amount of lower chlorinated PCDD/F. Some other substances belonging to the metal oxide groups such as NaVO_3 , $\text{Na}_2\text{MoO}_4 \cdot 2\text{H}_2\text{O}$ and $\text{Na}_2\text{WO}_4 \cdot 2\text{H}_2\text{O}$ show low but still inhibitory effects, especially for PCDD. These substances are active for catalytic oxidation. Their chemical structure consists of a strong oxide base such as VO_3^- , MoO_4^{2-} , WO_4^{2-} . Probably due to this base, a better performance of incineration during the experiments occurs. Regardless, these additives cannot reduce PCDD/F and PCB sufficiently.

Relatively low inhibitory effects are also observed for the N-containing substances. The samples of this group of additives are located somewhere between the two extremes of the score plot. The inhibition behaviour of triethanolamine was investigated with FTIR analysis [118]. Ethanolamine as an inhibitory molecule containing the amino and hydroxyl functional groups and can undergo intermolecular dehydroamination reactions. Bromobenzene or the benzene precursors are displaced from the catalytically active sites, which are blocked by ethanolamine.

Higher reduction effects of PCDD/F and PCB can be derived for the S- containing substances present at 10% of the fuel. Sulfur shows a very strong inhibition effect of PCDD/F and especially of PCB. It is already known that sulfur is converted into SO_2 and it reduces Cl_2 to HCl , and therefore dioxin and PCB formation can be reduced [38]. Probably, also because of this mechanism, the rest of the S-containing compounds inhibit PCDD/F flue gases.

Although the single N- and S- containing compounds are not very effective as inhibitors, all other N- and S- containing substances seem to be able to reduce strongly PCDD/F flue gas emission if used as a 10% additive of lignite coal, solid waste and PVC as fuel. Mixture of $(\text{NH}_2)_2\text{CO}+\text{S}$ (1:1) can strongly suppress the PCB emissions and this additive can also successfully inhibit PCDD/F toxic gases. However, the most effective inhibitors for PCDD/F and PCB are $(\text{NH}_4)_2\text{SO}_4$ and $(\text{NH}_4)_2\text{S}_2\text{O}_3$. Both compounds are cheap and non-toxic materials.

5.2.3. Experiments with Varying Inhibitor Amount

The combustion experiments are performed according to the same procedure each time in order to achieve comparable results. The sample number of these experiments is 0208002, 0209018, 0209019, 0212010, 0212015 and 0307002. The sample numbers of: 10% $(\text{NH}_4)_2\text{SO}_4$ (0212016, 0302031, 03030017) and 10% $(\text{NH}_4)_2\text{S}_2\text{O}_3$ (0301002, 0303019, 0303022); 5% $(\text{NH}_4)_2\text{SO}_4$ (03030023, 0305002, 0305003) and 5% $(\text{NH}_4)_2\text{S}_2\text{O}_3$ (0303034, 0305148, 0305151); 3% $(\text{NH}_4)_2\text{SO}_4$ (0304014, 0307045, 0308095), 3% $(\text{NH}_4)_2\text{S}_2\text{O}_3$ (0304020, 0307046, 0308096) and 3% $(\text{NH}_2)_2\text{CO}+\text{S}$ (1:1) (0307047); 1% $(\text{NH}_4)_2\text{SO}_4$ (0304022, 0307007, 0308102), 1% $(\text{NH}_4)_2\text{S}_2\text{O}_3$ (0304021, 0307016, 0308103) and 1% $(\text{NH}_2)_2\text{CO}+\text{S}$ (1:1) (0307039).

PCDD/F concentration

$(\text{NH}_4)_2\text{SO}_4$ and $(\text{NH}_4)_2\text{S}_2\text{O}_3$ show stronger inhibition effects than the other substances. The resulted differences between the samples treated without any inhibitors and these substances are promising. Therefore, they were examined another two times and experiments in which these substances constituted at a lower fraction of the fuel were performed. $(\text{NH}_4)_2\text{SO}_4$ and $(\text{NH}_4)_2\text{S}_2\text{O}_3$ result in an approximately 50 fold reduction of PCDD/F I-TEQ values (Fig. 5.15). Another effective inhibitor for PCDD/F is $(\text{NH}_2)_2\text{CO}+\text{S}$ (1:1) even not so strong as $(\text{NH}_4)_2\text{SO}_4$ and $(\text{NH}_4)_2\text{S}_2\text{O}_3$. Thus, these substances are examined further in the same laboratory furnace under the same conditions in order to generate comparable results (Fig.5.18).

To optimise the amount of inhibitor needed, these substances are also studied at 5%, 3%, 1 % of the fuel. The experiments were performed in triplicate. The experiments with $(\text{NH}_2)_2\text{CO}+\text{S}$ (1:1) are studied only once at 10%, 3% and 1%. In addition, the experiment without any inhibitor was repeated in order to obtain actual value during

the time of the investigation. The standard deviation of that pattern is calculated on the basis of six measurements. The calculated average value for PCDD/F I-TEQ is 16.4 pg/g with a maximum value of 21.2 pg/g and minimum value of 13.4 pg/g.

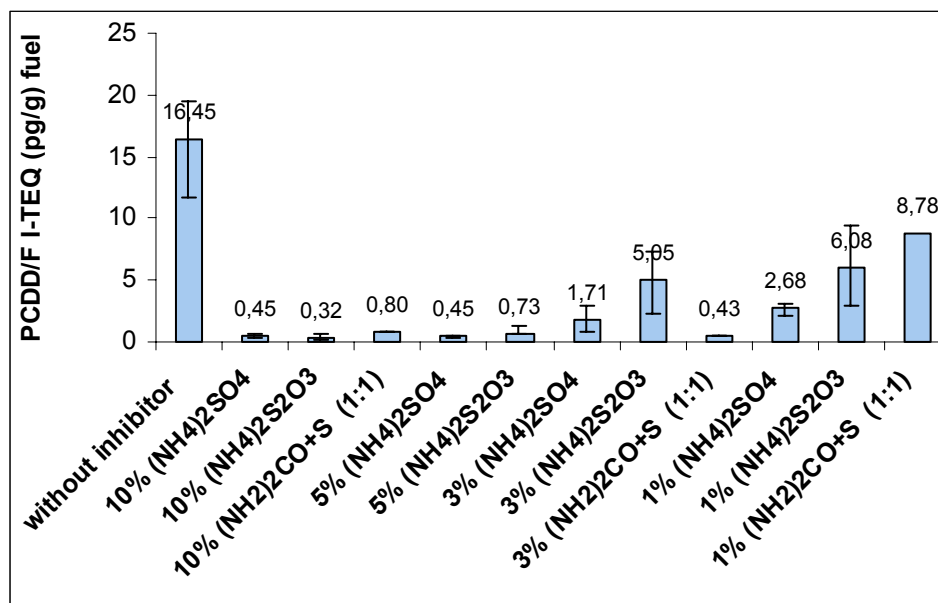

Fig. 5.18: PCDD/F I-TEQ pg/g fuel values in the flue gas for the samples without inhibitor and with (NH₄)₂SO₄ and (NH₄)₂S₂O₃ at 10%, 5%, 3% and 1% and (NH₂)₂CO+S at 10%, 3% and 1% as inhibitor of the fuel.

The variation among the results is found to be acceptable for such type of laboratory experiments. (NH₄)₂SO₄ and (NH₄)₂S₂O₃ are still effective inhibitors at 10% and 5% of the fuel for PCDD/F (Fig.5.19). If the percentage of these substances is decreased further, the suppressing effect of PCDD/F formation is also decreased. According to Fig. 5.16, (NH₂)₂CO+S (1:1) can suppress strongly the PCDD/F emissions even at 3% of the fuel but the obtained value at 1% shows a high increase of the measured dioxins amount. (NH₄)₂SO₄ might also reduce the PCDD/F flue gas emission at 3% but not as effectively as at higher percentages.

PCB concentration

(NH₄)₂SO₄, (NH₄)₂S₂O₃ and (NH₂)₂CO+S (1:1) show stronger inhibition effect for PCB emissions. Thus, these compounds were also examined in triplicate with a lower percentage of the fuel such as 5%, 3% and 1% of the fuel. The experiments with (NH₂)₂CO+S (1:1) were also here repeated once at 10%, 3% and 1% of the fuel mixture. The results present in I-TEQ (pg/g) fuel are drawn in Fig. 5.19.

The experiment without any inhibitor was repeated also for PCB concentrations in order to have actual value during the time of the investigation. The standard deviation of that pattern is calculated on the basis of six measurements. The calculated

average value for PCB I-TEQ is 1.01 pg/g with a maximum value of 1.39 pg/g and minimum value of 0.58 pg/g. $(\text{NH}_4)_2\text{SO}_4$ and $(\text{NH}_4)_2\text{S}_2\text{O}_3$ are still effective inhibitors at 10% and 5% of the fuel for PCDD/F (Fig.5.19).

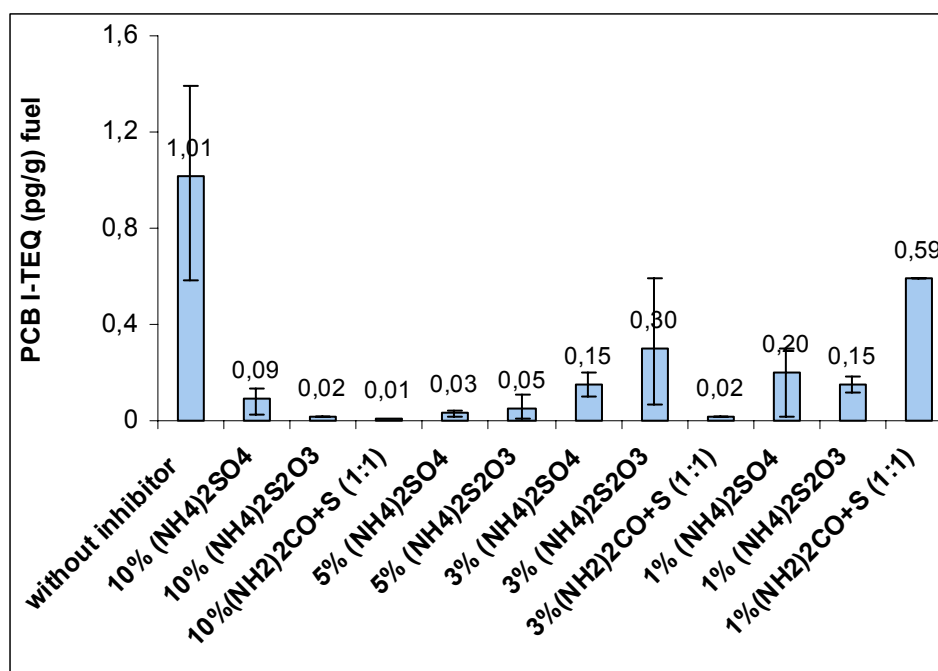

Fig. 5.19: PCB I-TEQ pg/g fuel values in the flue gas for the samples without inhibitor and with $(\text{NH}_4)_2\text{SO}_4$ and $(\text{NH}_4)_2\text{S}_2\text{O}_3$ at 10%, 5%, 3% and 1% and $(\text{NH}_2)_2\text{CO}+\text{S}$ at 10%, 3% and 1% as inhibitor of the fuel.

However it, the percentage of these substances is decreased further, the suppressing effect of PCB formation also decreased. $(\text{NH}_2)_2\text{CO}+\text{S}$ (1:1) show very strong reduction effect at 3% of the fuel and very low inhibitory effect at 1% of the fuel for PCB formation in the same laboratory furnace under the same conditions such type laboratory experiments (see also Fig. 5.18).

PCBz concentration

The triplicate experiments with 5%, 3% and 1% $(\text{NH}_4)_2\text{SO}_4$ and $(\text{NH}_4)_2\text{S}_2\text{O}_3$ and the sample treated without any inhibitor performed during that time of the same series of investigations are analysed for PCBz concentrations. $(\text{NH}_2)_2\text{CO}+\text{S}$ (1:1) is also used once as inhibitor for PCBz with 3% and 1% of the fuel. The sum of the PCBz mass concentrations for the analysed samples is shown Fig. 5.20.

According to the single experiment where the mixture of lignite coal and solid waste/PVC was combusted without addition of any inhibitor the sum of the PCBz is 135 pg/g fuel. The additives of 5% and 3% $(\text{NH}_4)_2\text{SO}_4$ show strong inhibition effect of

PCBz. 5% $(\text{NH}_4)_2\text{S}_2\text{O}_3$ is relatively good example for PCBz reduction but at 3% of the same compound the PCBz concentration is drastically increased.

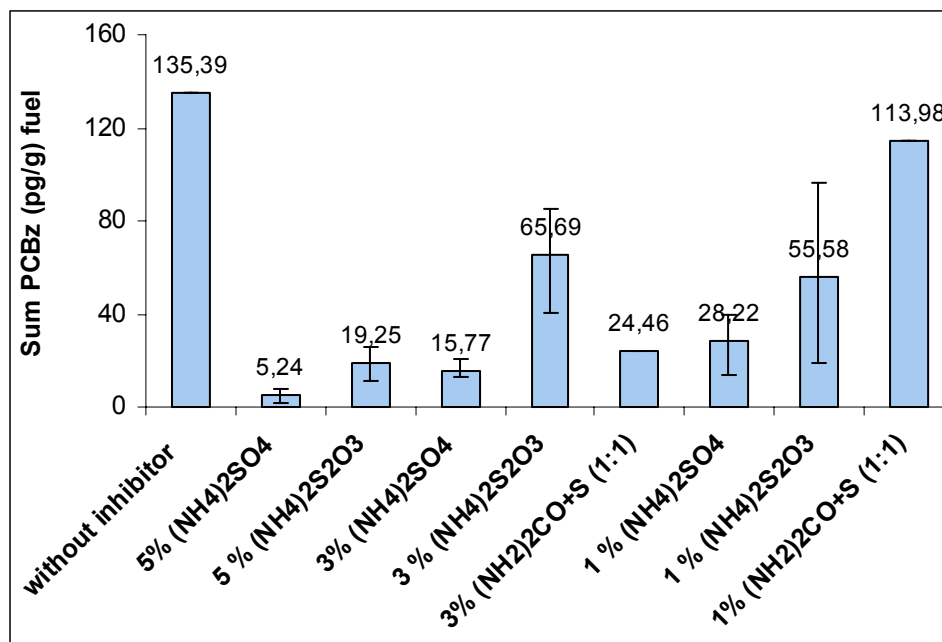

Fig. 5.20: Sum PCBz pg/g fuel values in the flue gas for the samples without inhibitor and with $(\text{NH}_4)_2\text{SO}_4$ and $(\text{NH}_4)_2\text{S}_2\text{O}_3$ at 5%, 3% and 1% and $(\text{NH}_2)_2\text{CO}+\text{S}$ at 3% and 1% of the fuel.

The samples at 3% and 1% $(\text{NH}_4)_2\text{S}_2\text{O}_3$ Fig. 5.18 show a high standard deviation. $(\text{NH}_2)_2\text{CO}+\text{S}$ (1:1) used as inhibitor at 3% show relatively similar PCB amount as the sample with 3% $(\text{NH}_4)_2\text{SO}_4$. Despite that at 1% $(\text{NH}_2)_2\text{CO}+\text{S}$ (1:1) the PCB concentrations are nearly the same as the sample treated without any inhibitor.

Discussion

The most effective inhibitors all over the used 20 different compounds are $(\text{NH}_4)_2\text{SO}_4$, $(\text{NH}_4)_2\text{S}_2\text{O}_3$ and $(\text{NH}_2)_2\text{CO}+\text{S}$ (1:1). $(\text{NH}_4)_2\text{SO}_4$ present at 3% of the fuel can reduce the PCDD/F, PCB and PCBz emissions by 90% and at 1% the reduction of the same toxic compounds is slightly decreased to 80-85%. $(\text{NH}_4)_2\text{S}_2\text{O}_3$ present at 3% of the fuel can reduce the PCDD/F, PCB emissions to around 70% and poorly decrease the PCBz emissions up to 60%. $(\text{NH}_2)_2\text{CO}+\text{S}$ (1:1) present at 3% show very strong reduction of PCDD/F, PCB and PCBz emissions of about 80-97%. It is noticed that at 3% $(\text{NH}_2)_2\text{CO}+\text{S}$ (1:1) the reduction of PCDD/F is stronger than the result at 10% of the same substances. However $(\text{NH}_2)_2\text{CO}+\text{S}$ (1:1) at 1% of the fuel does not show any reduction effect (50-15%) for the analysed toxic congeners.

Finally the results presented in this chapter show that $(\text{NH}_4)_2\text{SO}_4$ is the most effective inhibitor for PCDD/F, PCB and PCBz emissions. This compound is low cost and a non-toxic material, making it applicable for use in full-scale combustion units.

5.2.4. PCDD/F and PCB Homologue Distribution for the 20 Different Inhibitors Present as 10% of the Fuel

The results of pattern analysis are compared to the samples without inhibitors and to the samples investigated with metal oxide additives. The percentage of the homologue pattern for PCDD and PCDF and PCB is calculated for the twenty different inhibitors used at 10% of the fuel including the average value of five samples without any inhibitors. The PCDD, PCDF and PCB results are presented in Fig. 5. 21.

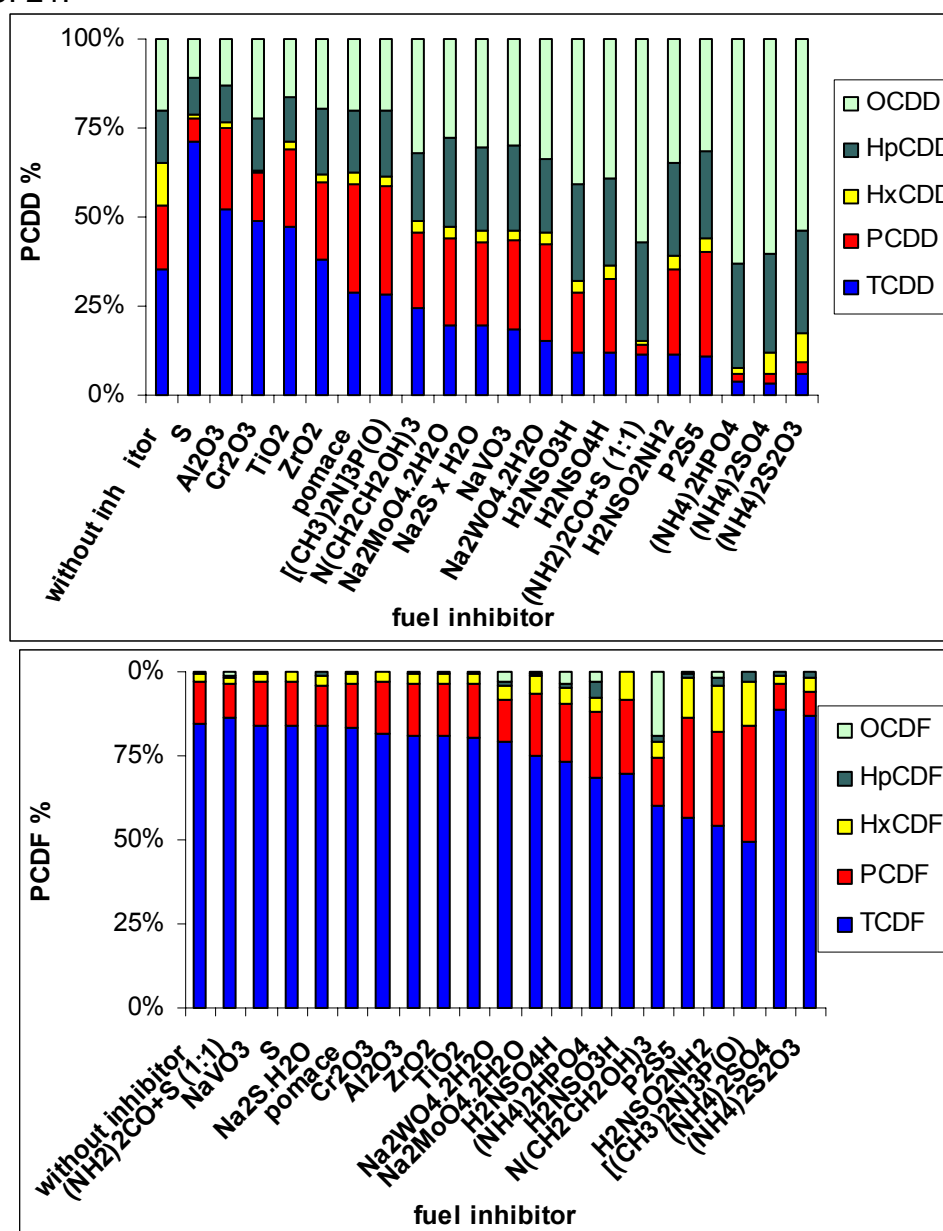

A

B

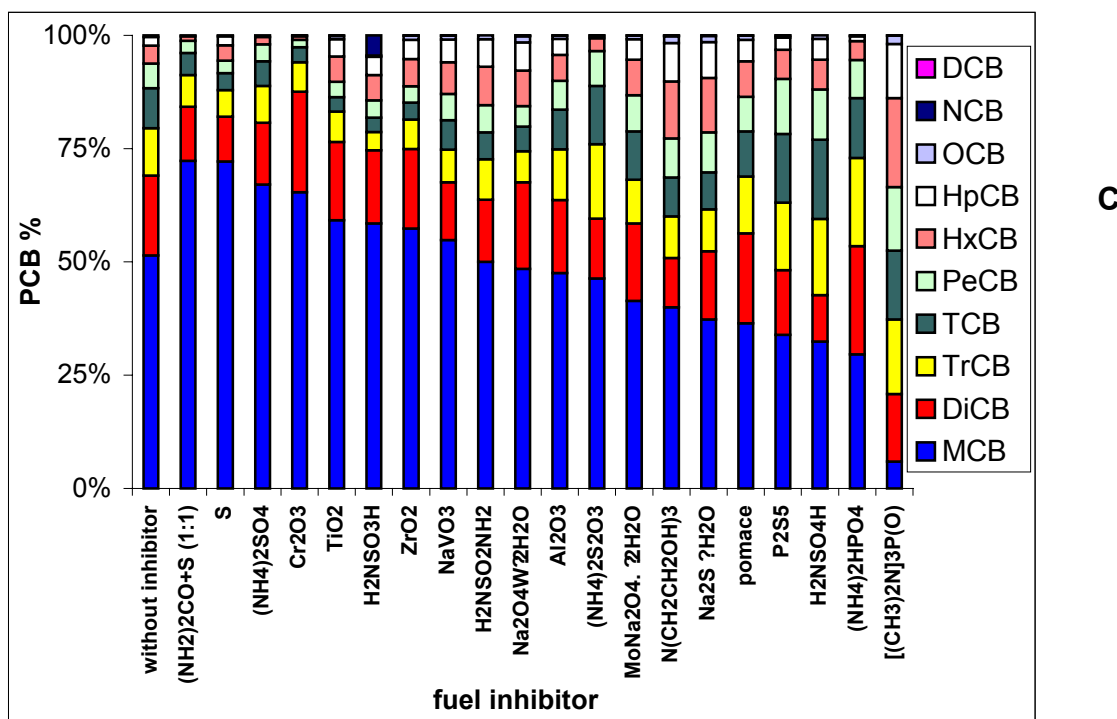

Fig. 5.21: Percentage of PCDD (A), PCDF (B) and PCB (C) homologues mass distribution of the samples with and without inhibitor during combustion of lignite coal, solid waste and PVC in lab scale experiments.

Fig. 5.21. shows very different results for the PCDD pattern. For almost half of the samples TCDD is the dominant homologues and for the other half OCDD is the most dominant compound. PeCDD and HpCDD vary strongly from sample to sample and HxCDD is always present at negligible amounts. For the samples without inhibitor, PeCDD, HxCDD and HpCDD are at similar percentages. The samples combusted without inhibitors and samples belonging to the metal oxide group and sulphur exhibit higher percentage for TCDD. The next dominant pattern is PeCDD followed by OCDD and HpCDD. For the weak inhibitors positioned in the middle of that ordinate, the percentage of all homologues except HxCDD is on average around 25%.

Compounds which drastically reduced TCDD and PCDD are $(\text{NH}_4)_2\text{HPO}_4$, $(\text{NH}_4)_2\text{SO}_4$ and $(\text{NH}_4)_2\text{S}_2\text{O}_3$. The latter two compounds were already assigned to be the most effective inhibitors of PCDD. Despite the lower percentage of the lower chlorinated congeners here, HpCDD and OCDD compose around 80% of the remaining homologues. Fig. 5.21. shows similar results for the TCDF pattern. For all samples, TCDF is the most dominant homologue groups, taking around 75% of the remaining homologues. There is also a low reduction to 50% for the samples inhibited with

$\text{H}_2\text{NSO}_2\text{NH}_2$, $[(\text{CH}_3)_2\text{N}]_3\text{P}(\text{O})$, P_2S_5 , $(\text{NH}_4)_2\text{SO}_4$, $(\text{NH}_4)_2\text{S}_2\text{O}_3$ and $(\text{NH}_2)_2\text{CO}+\text{S}$ (1:1) cannot reduce

TCDF, but increase it up to 85%. The other PCDF congeners are present at very low or zero percent. One exception is $\text{N}(\text{CH}_2\text{CH}_2\text{OH})_3$, which has around 20% OCDF.

Fig. 5.21. shows similar results for the MCB pattern. For all samples, MCB is the most dominant homologue, taking between 40-75% of the remaining homologues. An exceptional species is $[(\text{CH}_3)_2\text{N}]_3\text{P}(\text{O})$ where MCB percentage is less than 20%. $(\text{NH}_4)_2\text{SO}_4$, $(\text{NH}_4)_2\text{S}_2\text{O}_3$ and $(\text{NH}_2)_2\text{CO}+\text{S}$ (1:1) show also high values of around 70% MCB. The next prevailed pattern for all samples is DiCB. From Fig. 5.21. it seems that $(\text{NH}_4)_2\text{SO}_4$, $(\text{NH}_4)_2\text{S}_2\text{O}_3$ and $(\text{NH}_2)_2\text{CO}+\text{S}$ (1:1) can strongly suppress the PeCB and HxCB and the HpCB-DCB content for that samples is almost zero.

Discussion

The homologues patterns analysis shows that the most effective inhibitors have a strong effect on the formation mechanisms of PCDD and PCDF. They remove the TCDD amount in combustion with a high percentage of TCDF and MCB. The lower chlorinated dioxin isomers, PeCDF, PeCB and HxCB isomers show negligible or undetectable amount for those substances and due to their high TEF, they do not contribute to the I-TEQ values.

The samples treated without any inhibitor and samples treated with metal oxides shows higher percentage of the mentioned above isomers. So that their I-TEQ values is also high. The samples where single N- and S-compounds are used as inhibitors the final PCDD/F and PCB I-TEQ values are low. These samples are present with relatively high TCDD amount which include the amount of the most toxic congener 2,3,7,8-TCDD. The PeCDF, PeCB and HxCB amount is nearly similar to the values of the reference samples without inhibitor.

In general, a constant ratio of various classes of chloroaromatic compounds like PCDD, PCDF and PCB have been found expressed by indicator parameter relationship. This relationship may be explained by quasi-stationary equilibria of the various classes of chloroaromatic compounds occurring by catalytic reactions on the surface of fly ash species. By the inhibitors the catalytic active sides of the fly ash become blocked resulting in breaking down the quasi-stationary equilibria. This is also true for the distribution of homologues with the series PCDD, PCDF and PCB.

5.2.5. PCDD/F, PCB and PCBz Homologue Distribution for the $(\text{NH}_4)_2\text{SO}_4$ and $(\text{NH}_4)_2\text{S}_2\text{O}_3$ Present as 10%, 5%, 3% and 1% of the Fuel.

PCDD and PCDF pattern analysis is also performed for $(\text{NH}_4)_2\text{SO}_4$ and $(\text{NH}_4)_2\text{S}_2\text{O}_3$ at 10, 5, 3 and 1% of the fuel. The homologue percentages in Fig. 5.22. are presented as average values of the triplicate experiments with inhibitor and 6 combustion measurements for the samples without inhibitor.

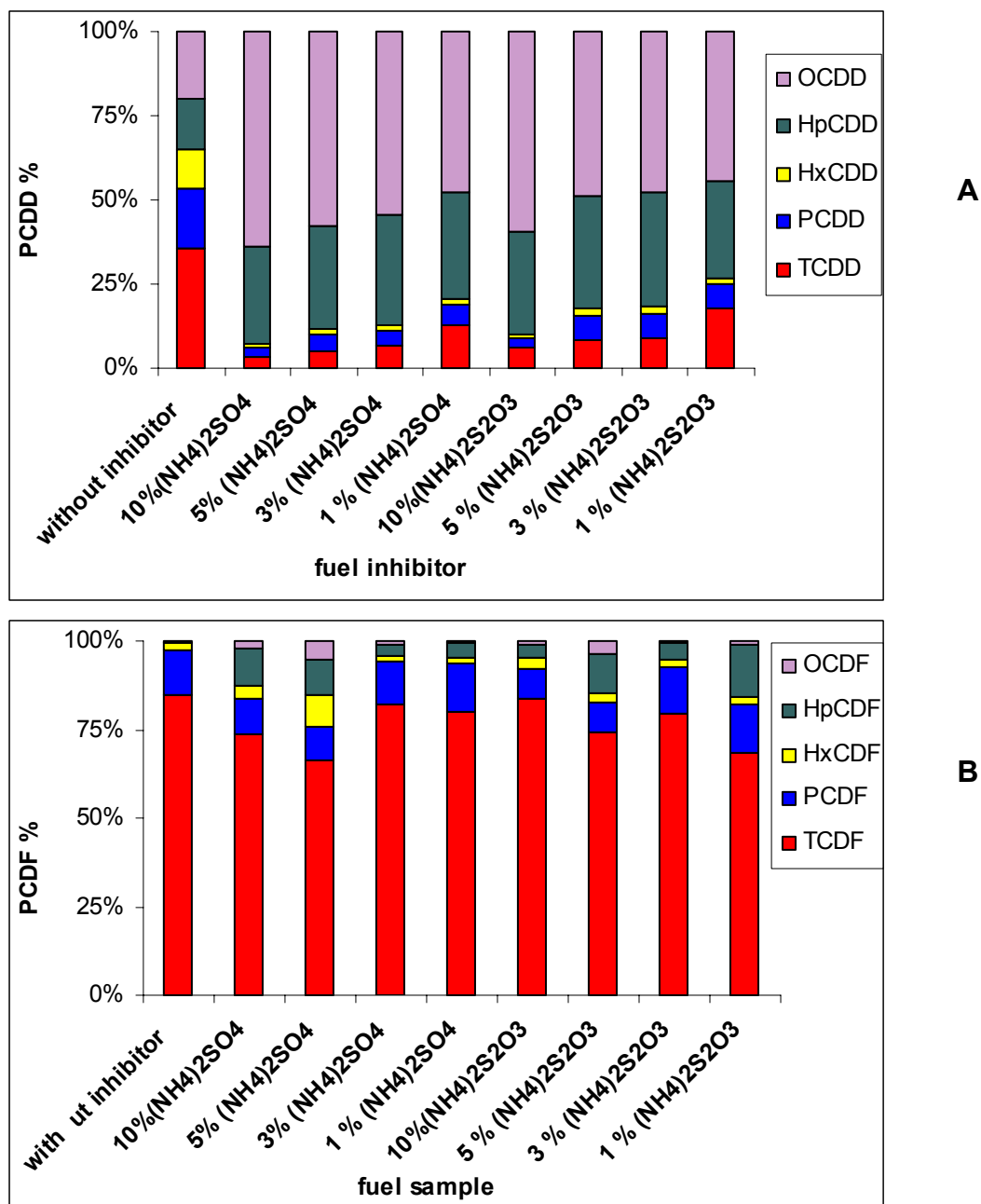

Fig. 5.22: Percentage of PCDD (A) and PCDF (B) homologues mass distribution of the samples without inhibitor and with 10%, 5%, 3% and 1% $(\text{NH}_4)_2\text{SO}_4$ and $(\text{NH}_4)_2\text{S}_2\text{O}_3$ during combustion of lignite coal, solid waste and PVC in lab scale experiments

According to Fig.5.22., it becomes obvious that in the samples with $(\text{NH}_4)_2\text{SO}_4$ and $(\text{NH}_4)_2\text{S}_2\text{O}_3$, the lower chlorinated PCDD as TCDD, PeCDD and HxCDD took the smaller part among all other homologues. Despite that, the opposite was found for samples without inhibitors. In that case, the higher chlorinated PCDDs as OCDD, HpCDD and HxCDD took the smaller part of all other homologues. If a trend is observed along different percentages of inhibitors, the result can be proven. The lower percentage of the inhibitors results in the higher percentage of lower chlorinated PCDD. The same relationship is also valid for the I-TEQ PCDD/F values. The percentages of the PCDF homologues are also shown in Fig. 5.22. Here the TCDF is the dominant homologue group for all samples, at around 75%. The next dominant homologue group for almost all samples is PeCDF. While higher percentage of inhibitors can suppress the lower PCDD, the opposite relationship seems to be valid for PCDF. As we have concluded from Fig. 5.18, promising inhibitors such as $(\text{NH}_4)_2\text{SO}_4$ and $(\text{NH}_4)_2\text{S}_2\text{O}_3$ used at 10% can increase the lower-chlorinated furans like TCDF. Thus, reducing the percentage of the inhibitor should decrease the relative TCDF amount. This relation holds true for each sample at 10% and 5% of additives and 1% of $(\text{NH}_4)_2\text{S}_2\text{O}_3$. The TCDF content is reduced slightly with decreasing the percentage of the inhibitor. The other combustion experiments at 3% of inhibitor and 1% of $(\text{NH}_4)_2\text{SO}_4$ do not obey the abovementioned rules. Instead of TCDF for the samples with 5% $(\text{NH}_4)_2\text{SO}_4$ and $(\text{NH}_4)_2\text{S}_2\text{O}_3$, HpCDF and OCDF increase their percentage compared to the reference samples without an inhibitor. All other samples are found at negligible amounts for HxCDF and OCDF.

PCB and PCBz pattern analysis is performed for $(\text{NH}_4)_2\text{SO}_4$ and $(\text{NH}_4)_2\text{S}_2\text{O}_3$ at 5, 3 and 1% of the fuel. The homologue percentages in Fig. 5.23 are presented as average values of the triplicate experiments with inhibitor and 6 combustion measurements for the samples without inhibitor. The amount of PCB homologues MCB-DCB and the PCBz homologues TCBz-HxCBz is shown in percentage in Fig.5.23.

Here the MCB is the dominant homologue group for all samples, at around 50% followed by DiCB at about 20% and TrCB at about 10%. The higher chlorinated PCB homologues TCB-DCB are present with gradual decreasing percentage. According to Fig. 5.23 it seems that 5% and 3% of $(\text{NH}_4)_2\text{SO}_4$ results slightly decrease of MCB amount prevailed over the TrCB. The lower percentage of $(\text{NH}_4)_2\text{SO}_4$ results in the higher percentage of higher chlorinated HxCB and HpCB. The varying amounts of

5,3 and 1% of $(\text{NH}_4)_2\text{S}_2\text{O}_3$ show no changes in PCB homologues pattern compared to reference samples without an inhibitor.

The percentages of the PCBz homologues are also shown in Fig. 5.23.

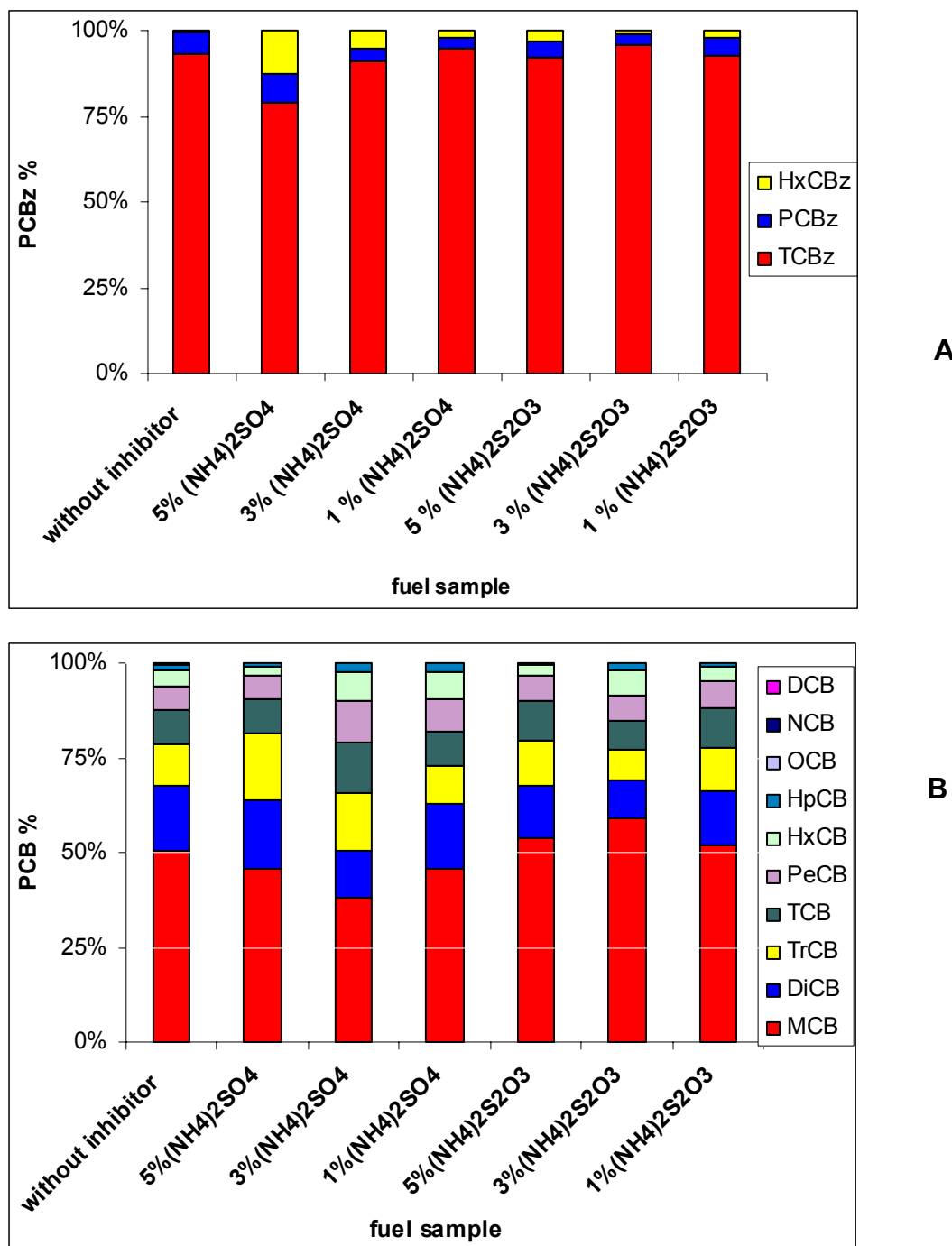

Fig. 5.23: Percentage of PCB (A) and PCBz (B) homologues mass distribution of the samples without inhibitor and with 5%, 3% and 1% $(\text{NH}_4)_2\text{SO}_4$ and $(\text{NH}_4)_2\text{S}_2\text{O}_3$ during combustion of lignite coal, solid waste and PVC in lab scale experiments

Here the TCBz is the dominant homologue group for all samples at around 95%. The samples treated without any inhibitors are illustrated in Fig. 5.23 at about 5% PCBz and almost zero percentage of HxCBz. Taking into account the same figure it

becomes obvious that the higher percentage of $(\text{NH}_4)_2\text{SO}_4$ results in a lower percentage of lower chlorinated PCBz. The TCBz amount is gradually increased from 80% to 95% with decreasing the $(\text{NH}_4)_2\text{SO}_4$ concentration. The same effect but not so pronounced is shown for the samples treated with $(\text{NH}_4)_2\text{S}_2\text{O}_3$.

Discussion

Higher percentages of the most effective inhibitors $(\text{NH}_4)_2\text{SO}_4$ and $(\text{NH}_4)_2\text{S}_2\text{O}_3$ produced lower percentage of lower chlorinated PCDD and PCBz. For the PCDF and PCB content the opposite is found. The lower chlorinated dioxin isomers, PeCDF, PeCB and HxCB isomers show negligible amounts when those substances are present with 10% and 5% of the fuel. That concentrations of $(\text{NH}_4)_2\text{SO}_4$ and $(\text{NH}_4)_2\text{S}_2\text{O}_3$ are the best examples where the PCDD/F, PCB and PCBz emissions can be strongly suppressed.

Lower percentage of 3% and 1% $(\text{NH}_4)_2\text{SO}_4$ and $(\text{NH}_4)_2\text{S}_2\text{O}_3$ produced still lower percentage of lower chlorinated PCDD and PCBz. However, less than 5% inhibitor of the fuel resulted in a weaker inhibition of TCDD and TCBz. The PeCDF, PeCB and HxCB are illustrated with a higher content comparable to the reference samples without inhibitor. Thus, the inhibition effect of these two substance is slightly decreased. Due to the strong reduction of TCDD amount for the sample at 3% $(\text{NH}_4)_2\text{SO}_4$ the PCDD/F I-TEQ value is kept low (Fig. 5.19).

The samples treated without any inhibitor show higher percentage of TCDD, PeCDF, PeCB and PCBz.

5.2.6. Inhibitory Effect of $(\text{NH}_4)_2\text{SO}_4$ at 1000°C

Laboratory scale experiments are a very sensitive system for sample investigations. Many factors influence the final data results (5.2.1). High temperature of 1000°C may establish quite different thermal behaviour of the fuel sample and the additionally used inhibitors.

Based on the preliminary results described above another series experiments are carried out with $(\text{NH}_4)_2\text{SO}_4$ using different duration of the experiment time (15 min and 60 min) and different combustion conditions at a temperature of 1000°C in order to find the (1) optimal inhibition, (2) to examine the mechanism of inhibition, (3) to

obtain comprehensive data set for studies of PCDD, PCDF, PCB and PCBz correlations, (4) the stability and efficiency of the inhibitor.

5.2.6.1. Combustion where the sample is introduced at preheated 1000°C furnace

The combustion experiments are performed according to the same procedure each time in order to achieve comparable results. The furnace is electrically preheated to the desired temperature of 1000°C and the sample is pushed in the centre of the heating zone and combustion took place 15 min at a flow of 2 L / min synthetic air. Experiments without inhibitor are performed two times. The sample number of that experiments is 0311014 and 0311036. The sample numbers of 10% and 5% $(\text{NH}_4)_2\text{SO}_4$ used as inhibitor are 0312006 and 0312013.

PCDD/F concentration

The PCDD/F I-TEQ amount generated during the experiments with a mixture of lignite coal, solid waste and PVC is enough to investigate the effect of inhibition along orders of magnitude. The measured two samples show around 600 pg/g and around 1200 pg/g PCDD/F I-TEQ values (Fig.5.24). The PCDD/F flue gas concentrations during these experiments is much higher values compared to the same samples at 400°C. That two-fold difference between the samples is explained by the higher variation during the conducted experiments at 1000°C.

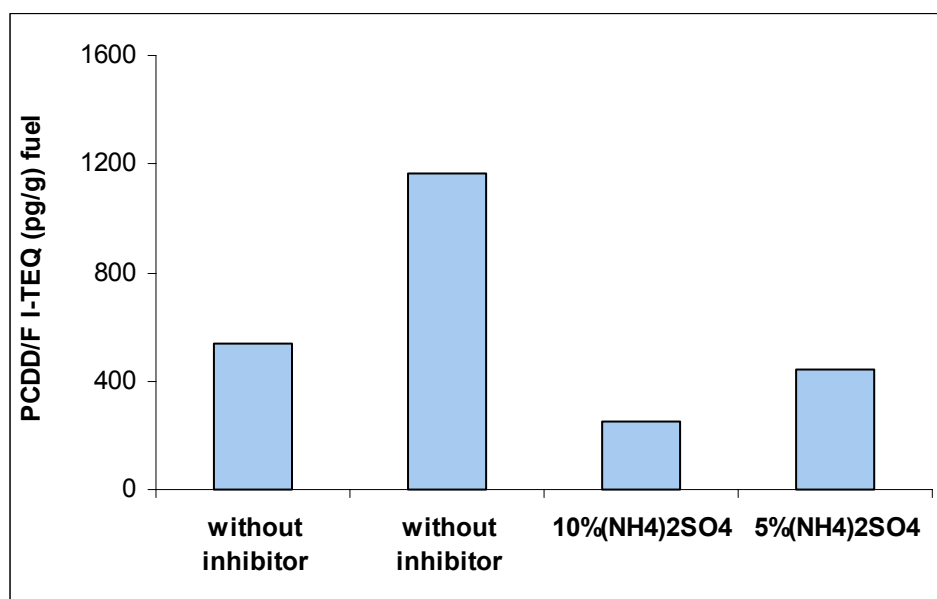

Fig. 5.24: PCDD/F I-TEQ pg/g fuel values in the flue gas at 1000°C for the samples without inhibitor and with $(\text{NH}_4)_2\text{SO}_4$ at 10% and 5% introduced at preheated 1000°C furnace.

However, the amount of the most toxic PCDD/F congener 2,3,7,8-TCDD is considered for the samples without inhibitor and with 10% and 5% $(\text{NH}_4)_2\text{SO}_4$ (Tab. 5.13). The samples treated with $(\text{NH}_4)_2\text{SO}_4$ show non detectable values for this toxic isomer.

Tab. 5.13: 2,3,7,8-TCDD I-TEQ (pg/g) fuel values in the flue gas at 1000°C for the samples without inhibitor and with $(\text{NH}_4)_2\text{SO}_4$ at 10% and 5% introduced at preheated 1000°C furnace.

Sample	2,3,7,8-TCDD I-TEQ (pg/g) fuel
without inhibitor	3.3
without inhibitor	8.7
10% $(\text{NH}_4)_2\text{SO}_4$	n.d.
5% $(\text{NH}_4)_2\text{SO}_4$	n.d.

PCB concentration

The measured PCB amount for the two samples treated without inhibitor is around 2 pg / g and around 4 pg / g PCDD/F I-TEQ values (Fig.5.25).

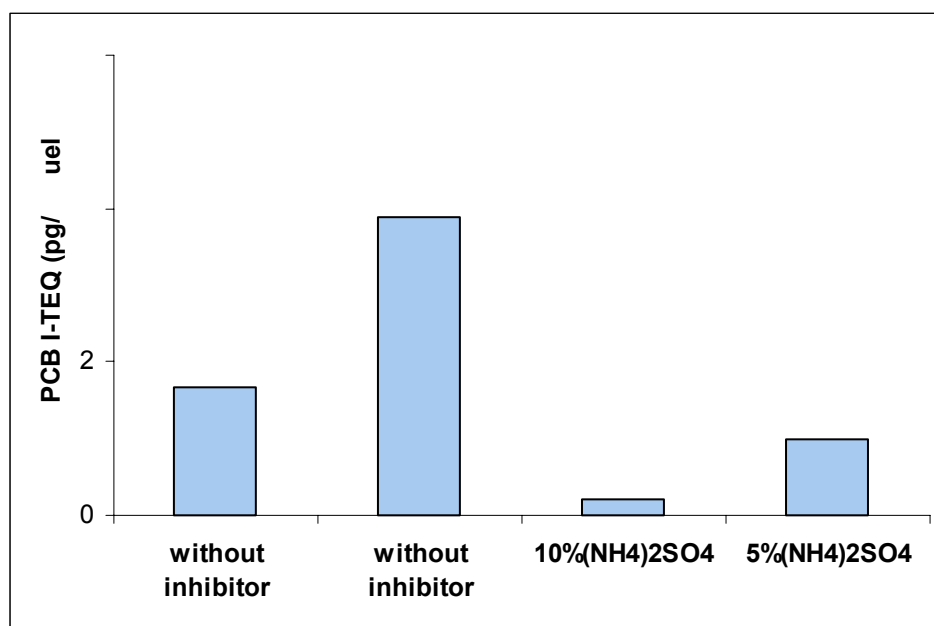

Fig. 5.25: PCB I-TEQ pg/g fuel values in the flue gas at 1000°C for the samples without inhibitor and with $(\text{NH}_4)_2\text{SO}_4$ at 10% and 5% introduced at preheated 1000°C furnace.

Discussion

At 1000°C, higher PCDD/F amount for the samples without inhibitor is detected. During these experiments the inhibition effect of $(\text{NH}_4)_2\text{SO}_4$ shows lower values for PCDD/F and PCB and a non detectable concentration for 2,3,7,8-TCDD isomer. It should be taken into account that the conclusions for inhibitory effect are quite tentative due to low number of cases.

Probably the much higher PCDD/F and PCB I-TEQ values at 1000°C can be explained by the very different combustion conditions during that type of experiments. Here, combustion evolves in a quite different way compared to that at 400°C. The introduced sampling boat in the hot zone of the furnace at 1000°C cause a lot of sooty gases in oven for short time. Soot appeared in the first couples of minutes of the experiment. The chlorine sources such as solid waste and PVC of the sample fuel are completely burnt during the shorter experimental time. Due to the lower temperature of 400°C and more stable combustion the formation of the high soot did not occur. It's recommendable that the experiments at 1000°C for the best inhibitor by employing an adjusted protocol, which avoids the fast initial poor combustion be repeated. It is proposed to push the sample in already to 200°C preheated hot zone and continuously increase the temperature to 1000°C. That can avoid the soot formation during the experiment and provide good performance and representability.

5.2.6.2. Combustion where the sample is introduced at preheated 200°C programmed furnace

The combustion experiments are performed according to the same procedure each time in order to achieve comparable results. The furnace is preheated to 200°C and the sample is pushed in the centre of the heating zone. Immediately the furnace is set to 800°C for 30 min and in a final step to 1000°C for another 30 min. The combustion took time 60 min at a flow of 2 L / min synthetic air. Experiments with a mixture of 80% lignite coal and 20% (13.3 : 6.7 ratio) solid waste and PVC are performed two times. The sample numbers of these experiments are 0402016 and 0403001. Experiments at 5% (NH₄)₂SO₄ used as inhibitor are performed also two times. The sample numbers of these experiments are 0402028 and 0402036.

PCDD/F concentration

The PCDD/F I-TEQ amount generated during the experiments with a mixture of lignite coal, solid waste and PVC is enough to investigate the effect of inhibition along orders of magnitude. The two samples show around 60 pg/g and around 25 pg/g PCDD/F I-TEQ (Fig. 5.26). These amount is slightly higher compared to the same samples performed at 400°C but much lower than the experiments at 1000°C where the sampling boat was pushed into the hot zone for a experimental time of 15 min.

The difference determined between the samples is also around two-fold for this type of samples. The sample generated first among this series of experiments exhibits the highest concentration of dioxins at 60 pg/g. It is a sample without an inhibitor. Second and third samples treated with 5% $(\text{NH}_4)_2\text{SO}_4$. According to Fig. 5.23 it seems that the PCDD/F I-TEQ amount decrease among this two repeated samples. If the average values of PCDD/F for the two type of samples are taken in account then the inhibitory effect of $(\text{NH}_4)_2\text{SO}_4$ is estimated up to 90%.

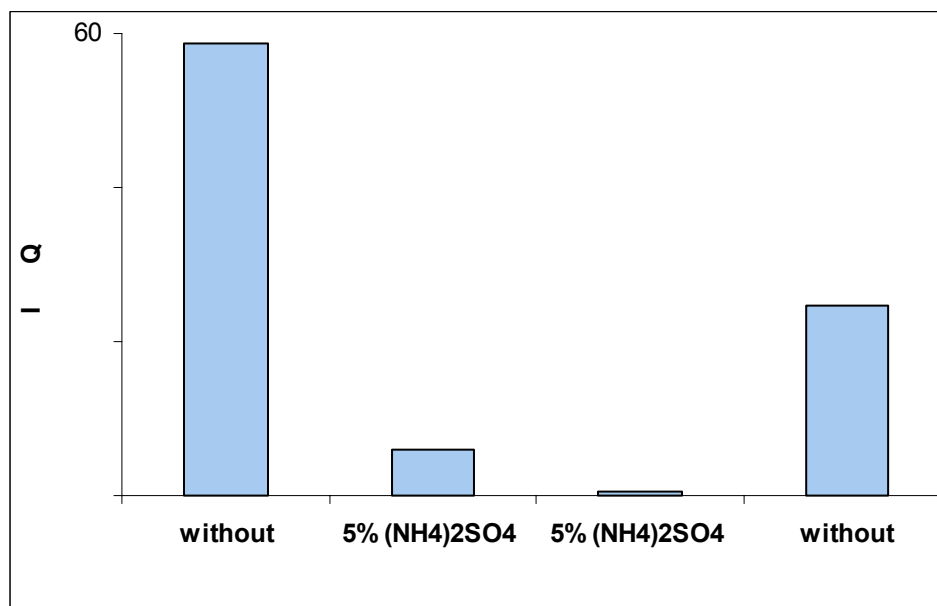

Fig. 5.26: PCDD/F I-TEQ pg/g fuel values in the flue gas at 1000°C for the samples without inhibitor and with $(\text{NH}_4)_2\text{SO}_4$ at 5% introduced at preheated 200°C programmed furnace.

PCB concentration

Only one sample treated without inhibitor was analysed for the PCB concentration. The amount of 1.6 pg/g PCB I-TEQ value in Fig. 5.27 is similar to the one of the generated PCB concentrations during the experiments at 1000°C with experimental time of 15 min (Fig. 5.25). The two samples where 5% of $(\text{NH}_4)_2\text{SO}_4$ is used as a inhibitor show significant suppressed effect for the PCB emissions. It is estimated up to 75-97%. The variation between both results is lower than the PCDD/F variables for the same samples.

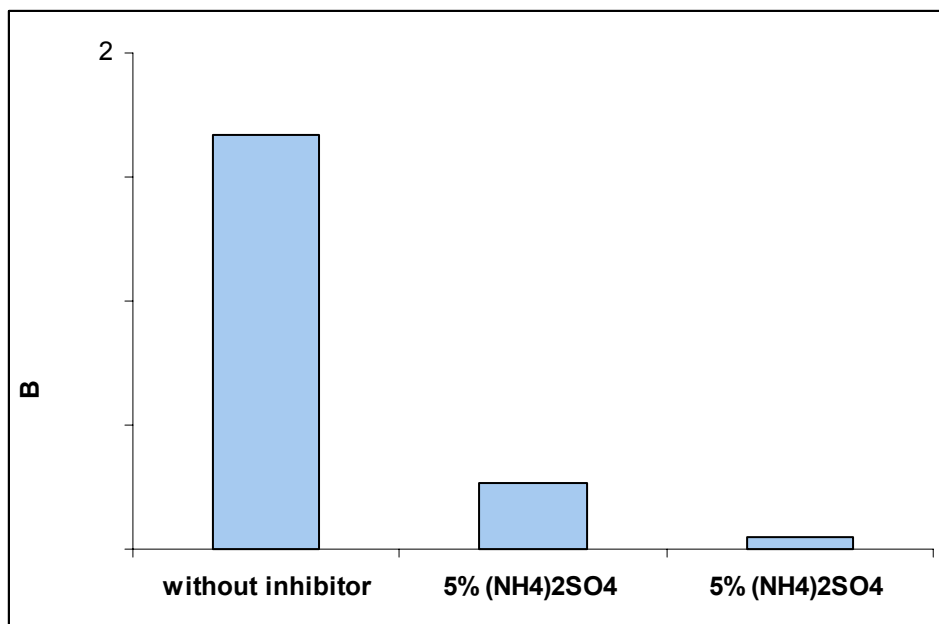

Fig. 5.27: PCB I-TEQ pg/g fuel values in the flue gas at 1000°C for the sample without inhibitor and with (NH₄)₂SO₄ at 5% introduced at preheated 200°C programmed furnace.

PCBz concentration

Both samples treated with 5%(NH₄)₂SO₄ and the sample without inhibitor was also analysed for PCBz concentration. The results are shown in Fig. 5. 28.

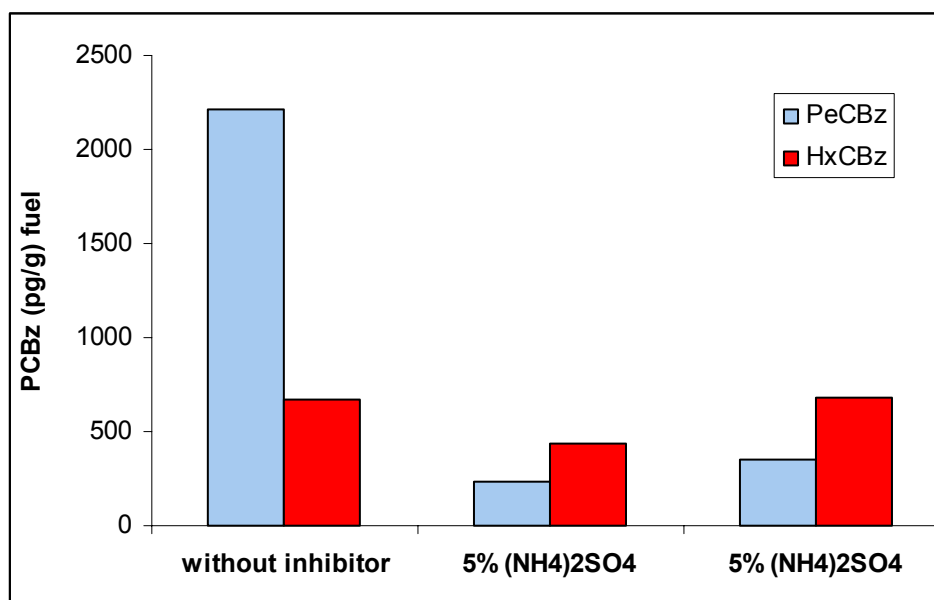

Fig. 5.28: PCBz pg/g fuel values in the flue gas at 1000°C for the sample without inhibitor and with (NH₄)₂SO₄ at 5% introduced at preheated 200°C programmed furnace.

Due some impurities in the samples the lower chlorinated TCBz were not calculated. Fig. 5.28 present the amount of the penta- and hexa-chlorinated benzenes. Regarding PeCBz the inhibitory effect of 5%(NH₄)₂SO₄ is estimated up to 85-90%.

However, the HxCBz amount is not reduced when the inhibitor is used. The values for that homologue are nearly similar for all samples.

Discussion

Combustion of lignite coal, solid waste and PVC where the sample is introduced at preheated 200°C programmed furnace generate high PCDD/F, PCB and PCBz concentrations. These values are much higher compared to the emissions measured at 400°C for the same type of samples. However, the dioxins amount during that combustion procedure are about 10 times lower than the values estimated at 1000°C where the sample was pushed into the hot zone. Using the procedure where the sample is gradually preheated into the hot zone, better combustion was occurred.

Strong suppression of PCDD/F, PCB and PCBz is estimated when 5%(NH₄)₂SO₄ is added to the fuel. The variables determined between the results are less than two-fold for this type of samples. No inhibition of HxCBz is evaluated during the experiments with 5%(NH₄)₂SO₄. Despite the amount of the PeCBz is sufficiently reduced.

The final conclusions state that if (NH₄)₂SO₄ is used at concentration of 5% of the fuel, the optimal inhibition of PCDD/F, PCB and PCBz formation is determined. The stability and the efficiency of the inhibitor at high temperature such as 1000°C are still valid. The reduction by its use is estimated up to 90%. Thus, (NH₄)₂SO₄ can block successfully the chloroaromatic mechanisms of dioxin formation in the post-combustion zone of an incinerator. This compound is low cost and non-toxic materials, making it applicable for use in full-scale combustion units.

5.3. Correlation between PCDD, PCDF, PCB and PCBz in coal / solid waste and PVC combustion at the influence of various inhibitors.

The relationship between PCDD/F and indicator parameters can be used in several ways, e.g. for optimizing incinerator operating condition, for emission monitoring. Furthermore using of indicator parameters can save a lot of time and make the PCDD/F control emission low cost.

5.3.1. Correlation between PCDD, PCDF, PCB and PCBz. Influence of Varying Inhibitors Amount

Principle component analysis (PCA) is used in order to give a better view of the similarity between the 21 samples including samples treated with and without inhibitor and different percentage of inhibitors (Tab 5.14.). The matrix used for statistical investigation of PCB, PCBz and PCDD/F includes 36 variables, see Tab. 5.15.

Tab. 5.14: Number of the cases used for PCA and CA statistical analyses.

S1	5% (NH ₄) ₂ SO ₄	S11	without inhibitor
S2	5 % (NH ₄) ₂ S ₂ O ₃	S12	1 % (NH ₄) ₂ SO ₄
S3	3% (NH ₄) ₂ SO ₄	S13	1 % (NH ₄) ₂ S ₂ O ₃
S4	3 % (NH ₄) ₂ S ₂ O ₃	S14	1% urea+S (1:1)
S5	1 % (NH ₄) ₂ S ₂ O ₃	S15	3% (NH ₄) ₂ SO ₄
S6	1 % (NH ₄) ₂ SO ₄	S16	3 % (NH ₄) ₂ S ₂ O ₃
S7	5% (NH ₄) ₂ SO ₄	S17	3% urea+S (1:1)
S8	5% (NH ₄) ₂ SO ₄	S18	3% (NH ₄) ₂ SO ₄
S9	5 % (NH ₄) ₂ S ₂ O ₃	S19	3 % (NH ₄) ₂ S ₂ O ₃
S10	5 % (NH ₄) ₂ S ₂ O ₃	S20	1 % (NH ₄) ₂ SO ₄
		S21	1 % (NH ₄) ₂ S ₂ O ₃

Tab.5.15: Number of the variables used for PCA and CA statistical analyses. * - I-TEQ value

V1	TCDD	V13	PCDD/F *	V25	HxCDF *
V2	PeCDD	V14	TCB *	V26	HpCDF *
V3	HxCDD	V15	PeCB *	V27	TCDD/F *
V4	HpCDD	V16	HxCB *	V28	PeCDD/F *
V5	OCDD	V17	HpCB *	V29	HxCDD/F *
V6	Sum PCDD	V18	PCB *	V30	HpCDD/F *
V7	TCDF	V19	TCDD *	V31	1,2,3,5-TCIBz
V8	PeCDF	V20	PeCDD *	V32	1,2,4,5-TCIBz
V9	HxCDF	V21	HxCDD *	V33	1,2,3,4-TCIBz
V10	HpCDF	V22	HpCDD *	V34	PeCIBz
V11	OCDF	V23	TCDF *	V35	HxCIBz
V12	Sum PCDF	V24	PeCDF *	V36	Sum PCIBz

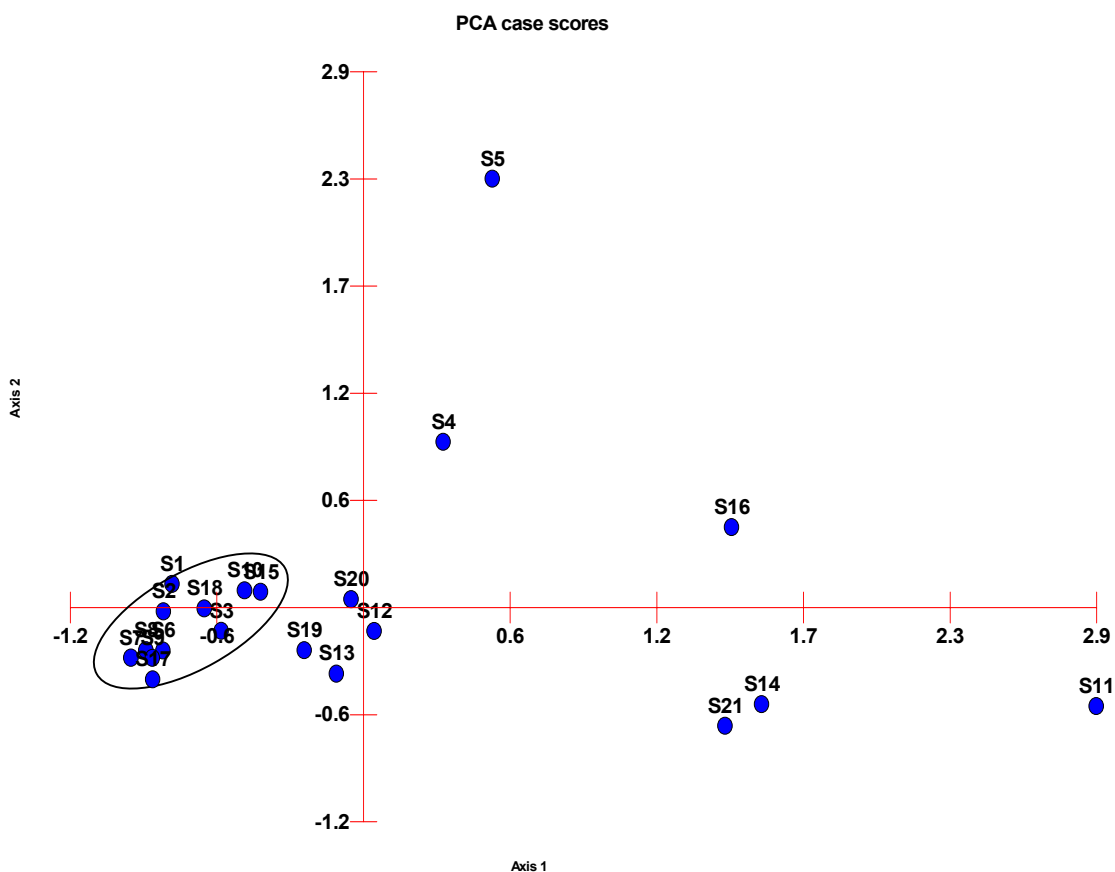
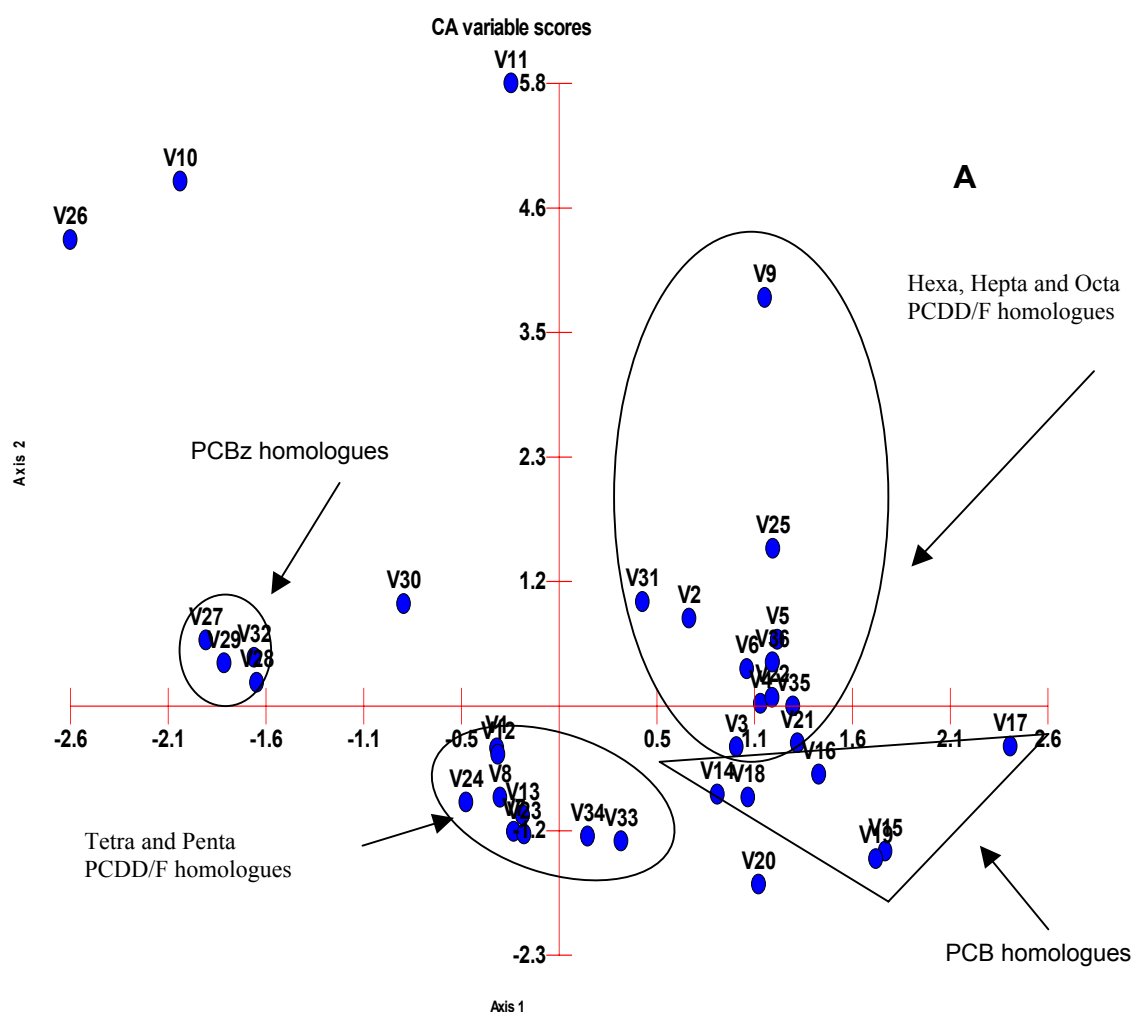

Fig.5.27: PCA score plot of 21 cases (samples) and 36 variables (PCDD/F, PCB and PCBz homologues)

One agglomerated group of samples, placed to the left of the ordinate axis is observed in the proposed PCA score plots (Fig. 5.27). These are the samples with lower concentrations of the investigated toxic compounds or samples treated with higher percentage such as 5 % and 3% of the inhibitor. The samples to the right of the ordinate and in the middle of the multidimensional space are the ones without inhibitor and with higher amount of PCDD/F, PCB and PCBz i.e. to the sample number S4, S5, S11, S12, S13, S14, S16, S19, S20 and S21. The more right the points in the statistical plot are appear the higher the concentration of PCDD/F has been found. Since S11 belongs to a sample treated without an inhibitor, and it is placed extremely to the right in the score plot. Vicinity of these toxic sample are some other points which can be attributed to the 1% $(\text{NH}_2)_2\text{CO}+\text{S}$ (1:1), 3 % $(\text{NH}_4)_2\text{S}_2\text{O}_3$ and 1 % $(\text{NH}_4)_2\text{S}_2\text{O}_3$. It is already known that these two inhibitors show weaker inhibitory effect than $(\text{NH}_4)_2\text{SO}_4$. Their PCDD/F, PCB and PCBz reduction ability is highly decreased at 3% of the fuel.

CA is performed separately for these two groups of samples visualised by the PCA score plot (Fig. 5.28).



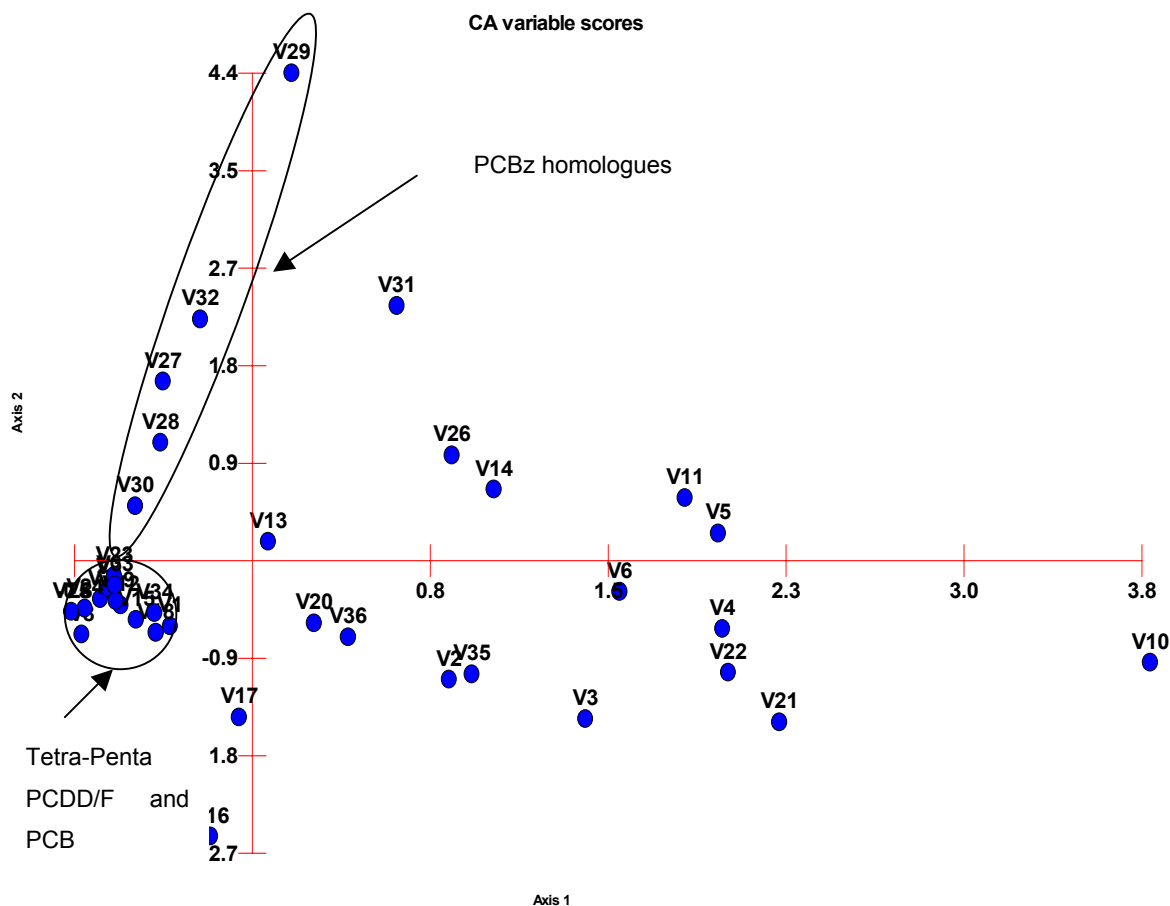
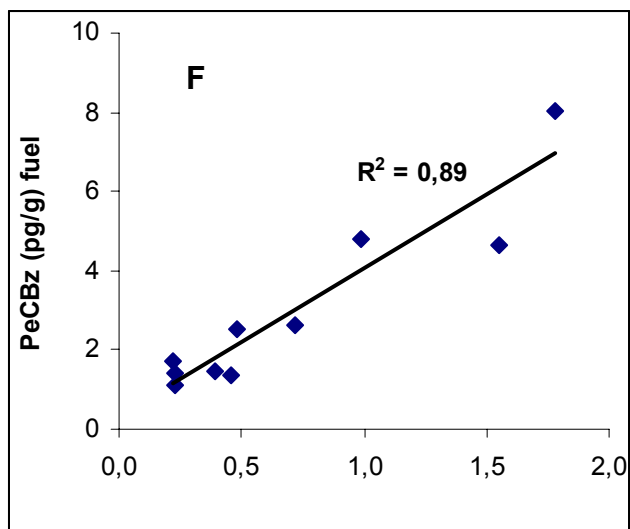
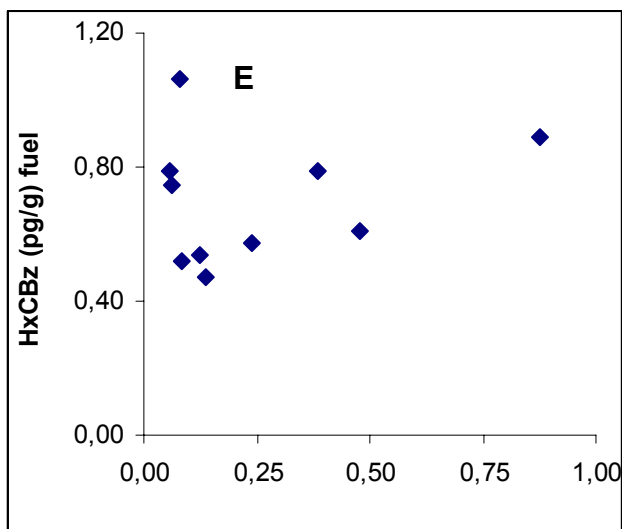
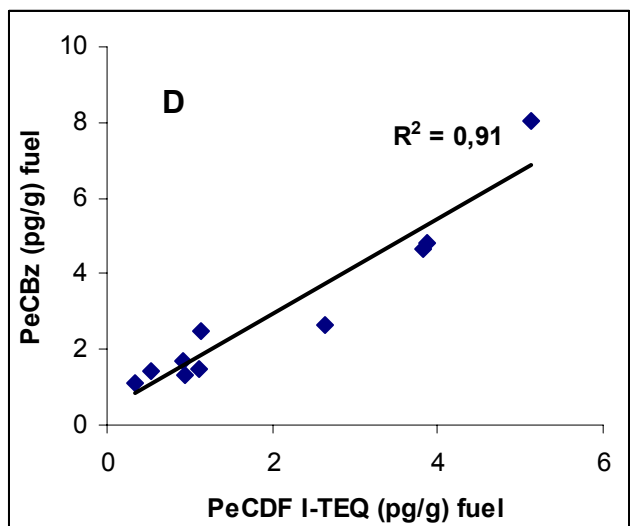
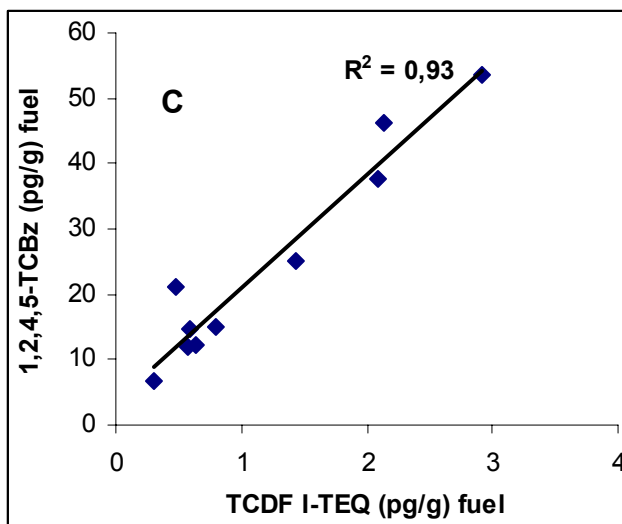
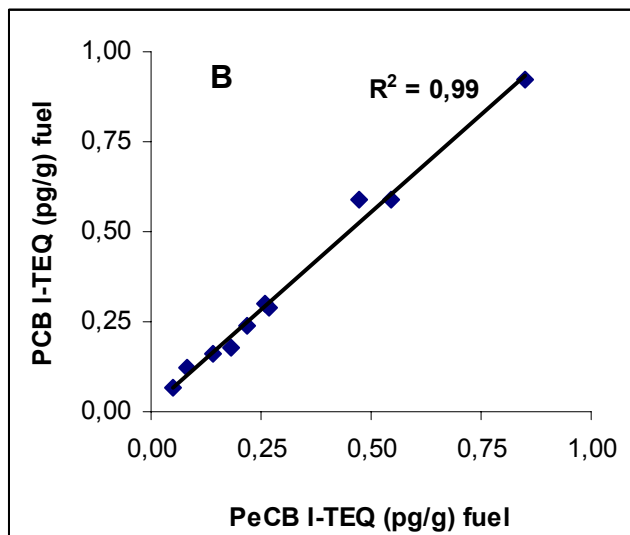
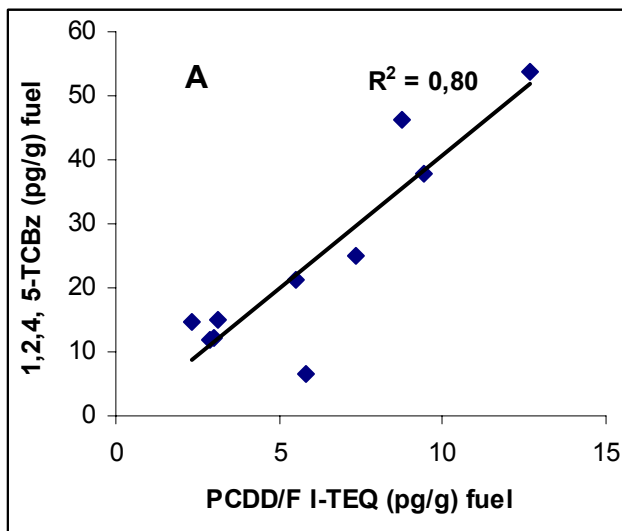

Fig. 5.28: CA score variables plots for the samples with lower TEQ (A) and higher TEQ (B)

The first matrix used for CA includes 10 cases and 36 variables and the second is present with 11 cases and 36 variables. Taking into account that in case of the effective inhibitors the higher chlorinated PCDD/F prevailed over the lower chlorinated one, Fig. 5.28 (B) proves this statement. Thus, the tetra-penta PCDD/F are placed more to the left of the ordinate axis and hexa, hepta and octa PCDD/F group to the right of the multidimensional space. In the score plot (B) the observed agglomerated groups are mostly pairs which consist of different classes of compounds and/or different levels chlorinated congeners. There is also one main group of samples placed to the left of the ordinate axis. It includes almost all tetra and penta PCDD/F congeners, PeCB I-TEQ and PCB I-TEQ variables. This agglomerate is very close to the PCBz group.

So that many different combinations of good correlated tetra and penta PCDD/F, PCB and PCBz congeners and homologues can be elaborated.

Some of the most interesting corresponding correlations are drawn in two dimensional figures in Fig. 5.29.



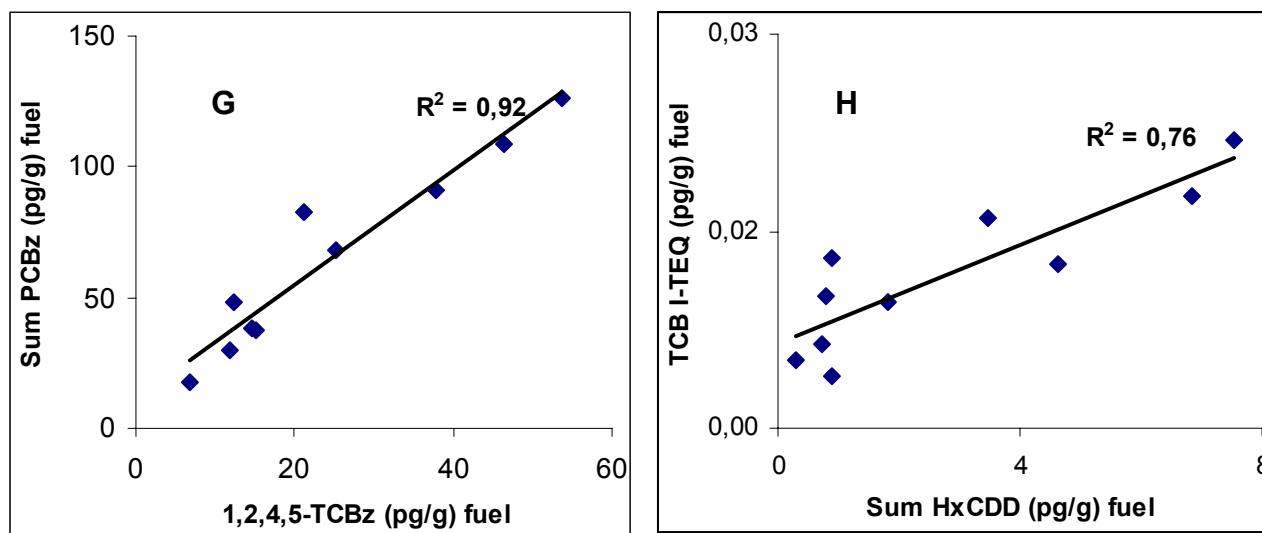

Fig. 5.29: Couple points of score variables plot (B) of CA in Fig. 22. (V15 and V18 (A); V13 and V32 (B); V23 and V32 (C); V24 and V34 (D); V25 and V35 (E); V 19 and V34 (F); V32 and V36 (G); V3 and V14 (H)).

A well expressed linear dependence is found for PeCB I-TEQ value and PCB I-TEQ value for the samples treated without inhibitor or with low percentage of inhibitor. The total PCDD/F I-TEQ amount is well correlated with 1,2,4,5-TCBz congener. The last one shows also high correlation coefficients of determination (R^2) with TCDF I-TEQ value. On the basis of plot (G) an implication that 1,2,4,5-TCBz strongly correlated with the sum of all PCBz congeners can be made. According to Fig. 5.23 the concentration profile I-TEQ value of the most toxic 2,3,7,8-TCDD congener is quantitatively similar to those of PeCBz. A fairly good relationship is obtained for PeCBz and PCDF I-TEQ. However, the higher chlorinated HxCDF and HxCBz congeners do not show correlation. The PCB homologues and the other PCDD/F and PCBz for the samples with higher toxicity have relatively low correlation coefficient. These homologues are placed far apart in score plot (B) of Fig. 5.29., the results demonstrate that TCB I-TEQ can be correlated with the sum of HxCDD in flue gas even with a low correlation coefficients.

Fig. 5.23 show the correlation between tetra and penta PCBz and PCDF corresponding homologues and some of the close by located variables points of score plot (A) Fig. 5. 28. Most of the observed pairs of variables in the same score plot belong to the same class of compounds. No correlation is observed between tetra and penta PCBz homologues and the corresponding PCDF- homologues (Fig. 5.30) for the samples with lower toxicities. Even the close to space located variables in the multidimensional space such as the higher chlorinated PCDD/F and PCB homologues show no any relationship. Only TCB I-TEQ and sum of HxCDD show

significantly high correlation coefficient. Also 1,2,4,5-TCBz is strongly correlated with the sum of PCBz homologues.

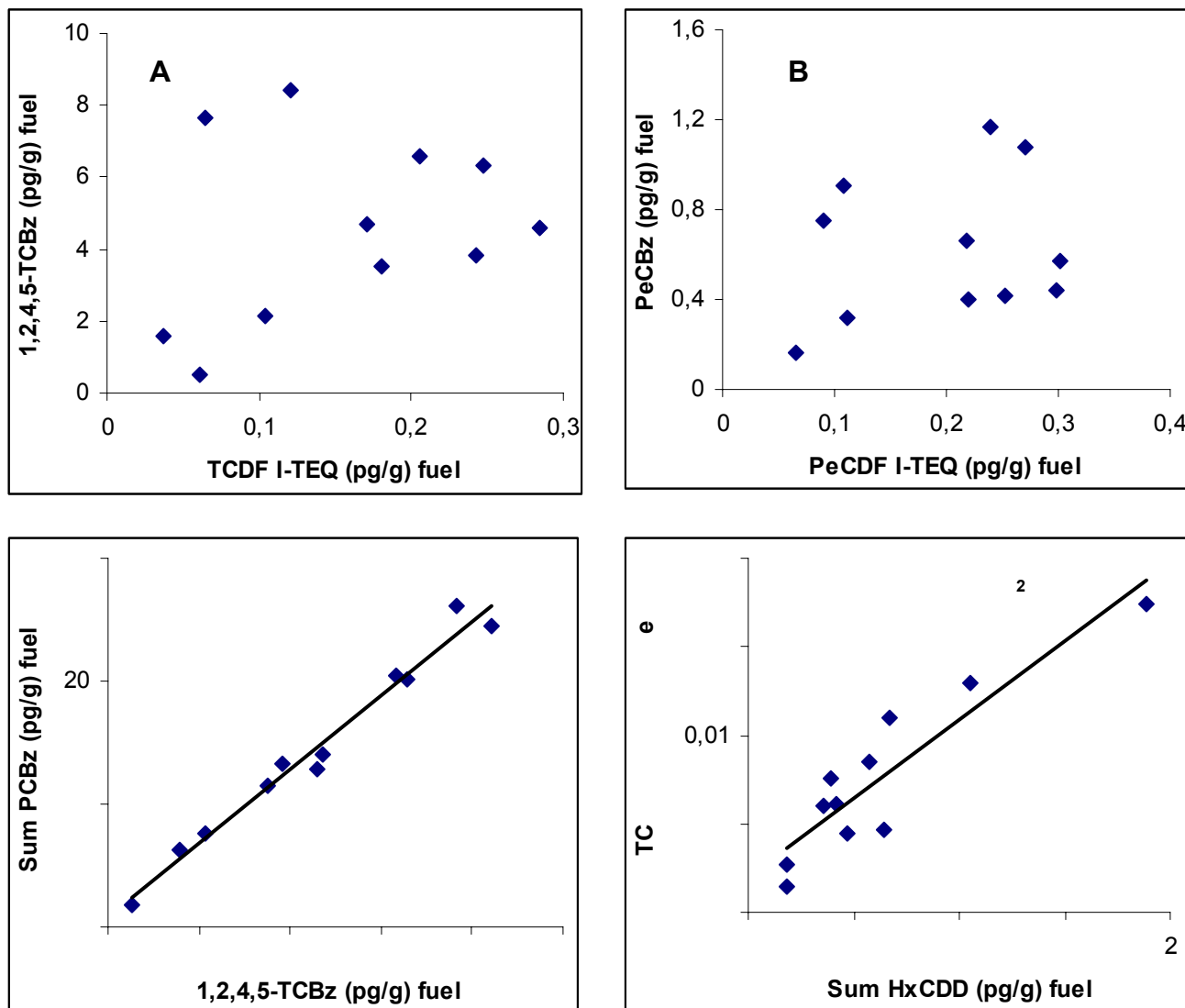

Fig.5.30: Couple points of score variables plot (A) of CA in Fig. 22. (V27 and V32 (A); V28 and V34 (B); V32 and V36 (C); V3 and V14 (D)).

Discussion

Among the samples two groups of different toxicity are estimated by PCA. Each of that group is further analysed with CA. A good correlation is found between tetra and pentachlorinated benzenes and tetra and penta chlorinated dibenzo-p-furans for the samples treated without inhibitor or with low percentage of inhibitor. According to the precursor theory of PCDD/F formation a fusion of two chlorophenyl radicals result in PCB compounds. In a later steps that molecules can be oxidized and are thus potential precursors of PCDF [9]. This relationship could be also due to the similar

temperature dependence of PCBz and PCDF in formation processes [119]. Furthermore, Blumenstock showed that more than 80% of the total I-TEQ value is assigned to the PCDF [57]. For the basic thermodynamics of PCDD/F it has been observed that the precursor mechanism produced more PCDFs and particular penta congeners, than PCDDs, of which the most favoured are hexa and hepta congeners [9]. These arguments may explain the high and reliable correlation between chlorinated benzene and the emissions of PCDF I-TEQ.

The best indicator parameter between the investigated PCBz congeners is 1,2,4,5-TCBz. That isomer is also significantly correlated with PCDD/F I-TEQ value. Blumenstock observed statistically the same promising correlation between the lower chlorinated PCBz congeners and PCDD/F I-TEQ value [57]. However Öberg proposed hexachlorobenzene [61] and Kaune penta-chlorobenzene and penta-chlorobiphenyl [62] as an indicator parameters of PCDD/F formation.

The best relationship between the chlorinated benzenes and PCB I-TEQ value, is found for PeCB. The relationship between 2,3,7,8-TCDD I-TEQ amount and PeCBz are in a good agreement with the work of Kaune [59]. The current publication proposed the same correlation on the base of different sampling points of three hazardous waste incinerators. PCBz is precursor of PCDD/F [44] and is involved in the complex reaction pathway of chloroaromatic compounds.

For the samples treated with high percentage of inhibitors the above mentioned relationships are not observed. This missing correlation is probably due to the strong inhibition of the compounds used and the non-detectable values for some of the most important congeners such as 2,3,7,8-TCDD and some other lower chlorinated PCDD/F isomers. It is also possible that different pathways of chloroaromatic formation are dominating for that type of samples.

Generally no correlation is found for both group of samples between PCB homologues and PCDD/F or PCBz homologues. The only promising correlated couples is the sum of HxCDD and the TCB I-TEQ values for the samples with higher and lower toxicity. Probably that correlation is possible due to the significant HxCDD amount also for the samples treated with high percentage of inhibitor. The lower chlorinated PCDD and PCDF homologues for the samples of lower toxicity are present with a negligible amount. 1,2,4,5-TCBz is the best correlated isomer with the sum of PCBz among the other PCBz congeners.

5.3.2. Correlation between PCDD, PCDF and PCB. Influence of Various Inhibitors.

Principle component analysis (PCA) is used to give a better view of the similarity between the 49 samples including samples treated without and with inhibitor and different percentage of inhibitors (Tab. 5.16.). Some of the samples were performed more only once. The matrix used for statistical investigation of PCB and PCDD/F includes 26 variables (see Tab.5.17). Not all 49 samples were analysed for PCBz so that this values are not included as variables in the matrix.

Tab. 5.16: Number of the cases used for PCA and CA statistical analyses..

without inhibitor	S1,2,3,4,5,49	TiO ₂	S6	Cr ₂ O ₃	S21
10% (NH ₄) ₂ SO ₄	S22,26,27	ZrO ₂	S7	(NH ₄) ₂ HPO ₄	S24
10% (NH ₄) ₂ S ₂ O ₃	S 23,28	Na ₂ MoO ₄ ·2H ₂ O	S8	[(CH ₃) ₂ N] ₃ P(O)	S16
5% (NH ₄) ₂ SO ₄	S29, 35,36	Al ₂ O ₃	S9	N(CH ₂ CH ₂ OH) ₃	S17
5 % (NH ₄) ₂ S ₂ O ₃	S30, 37,38	H ₂ NSO ₄ H	S10	Na ₂ WO ₄ ·2H ₂ O	S18
3% (NH ₄) ₂ SO ₄	S31,41,45	NaVO ₃	S11	P ₂ S ₅	S19
3 % (NH ₄) ₂ S ₂ O ₃	S32,42,46	H ₂ NSO ₃ H	S12	Na ₂ S ·H ₂ O	S20
1 % (NH ₄) ₂ SO ₄	S34, 39,47	S	S13	(NH ₂) ₂ CO+S	S25
1 % (NH ₄) ₂ S ₂ O ₃	S33, 40,48	H ₂ NSO ₂ NH ₂	S14	3% (NH ₂) ₂ CO+S	S43
		pomace	S15	1% (NH ₂) ₂ CO+S	S44

Tab. 5.17: Number of the variables used for PCA and CA statistical analyses. * - I-TEQ value

V1	TCDD	V10	HpCDF	V19	TCDD *
V2	PeCDD	V11	OCDF	V20	PeCDD *
V3	HxCDD	V12	Sum PCDF	V21	HxCDD *
V4	HpCDD	V13	PCDD/F *	V22	HpCDD *
V5	OCDD	V14	TCB *	V23	TCDF *
V6	Sum PCDD	V15	PeCB *	V24	PeCDF *
V7	TCDF	V16	HxCB *	V25	HxCDF*
V8	PeCDF	V17	HpCB *	V26	HpCDF*
V9	HxCDF	V18	PCB *		

One agglomerated group of samples, placed to the left side of the ordinate axis is observed in the proposed PCA score plots (Fig. 5.31). These are the samples with lower concentrations of the investigated toxic compounds or samples treated with N- and S- compounds or with higher percentage (NH₄)₂SO₄ and (NH₄)₂S₂O₃. The samples to the right hand side and in the middle of the multidimensional space are samples without an inhibitor and with higher amount of PCDD/F and PCB i.e. sample

number S1, S2, S3, S4, S5, S6, S7, S9, S11, S15, S17, S18, S19, S21, S32, S42, S44, S48 and S49.

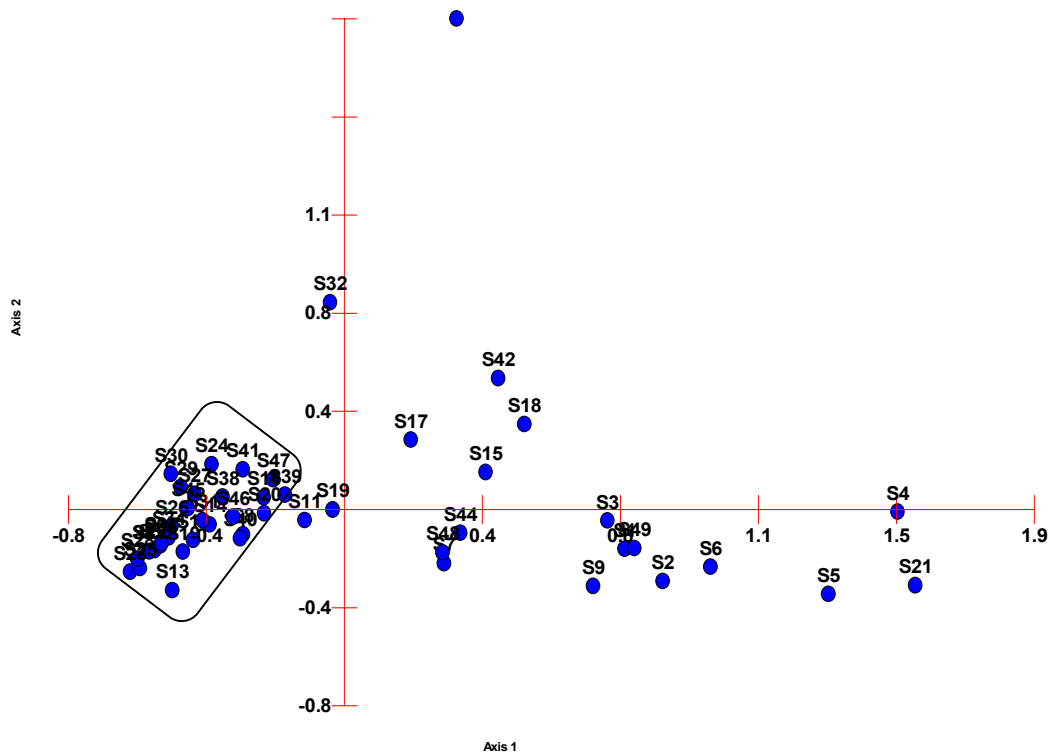

Fig.5.31: PCA score plot of 49 cases (samples) and 26 variables (PCDD/F and PCB homologues)

The more right the point in the statistical plot are appeared the higher concentration of PCDD/F and PCB has been found. Since S3, S4, S5, S6 and S49 belong to sample treated without an inhibitor and it is placed much more to the right in the score plot. Vicinity of these toxic samples are some other points which can be attributed to the Cr_2O_3 , TiO_2 , Al_2O_3 . It is already discusses that these metal oxides show no inhibitory effect even their PCDD/F and PCB emissions are higher compared to the samples treated without an inhibitor. Far apart of all sample points of the PCA score plot is placed sample S33. This sample represents to the experiment where 1% $(\text{NH}_4)_2\text{S}_2\text{O}_3$ is used as inhibitor for PCDD/F and PCB minimization. Due to its high variation, that sample could be assigned as outlier and is not included in further statistical analysis.

CA is performed separately for that two groups of samples visualised by the PCA score plot. The score variable plots are shown in Fig. 5.31.

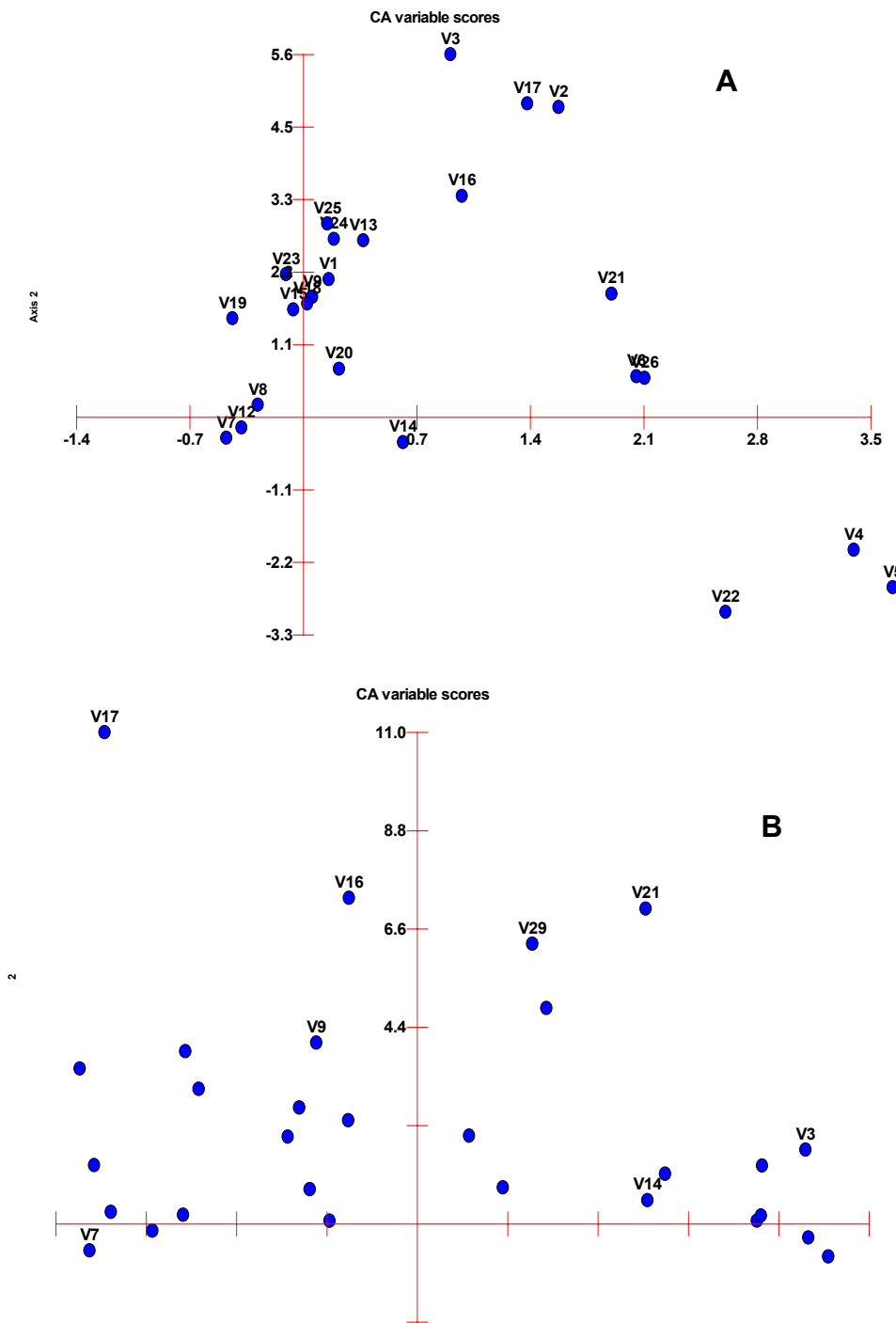

Fig. 5.32: CA score variables plots for the samples with higher TEQ (A) and lower TEQ (B)

The first matrix used for CA includes 19 cases and 24 variables. Due to the higher variation of V10 and V11, the values of the sum of HpCDF and OCDF are dismissed of the matrix. The second matrix is present with 29 cases and 25 variables. Also here V10 is considered as outlier and is removed from the matrix variations.

In score variables plot (A) of Fig. 5.31. the observed agglomerated groups are mostly pairs which consist of different classes of compounds and/or different levels chlorinated congeners. There is also one main group of samples placed on the ordinate axis. It includes some PCB and PCDD/F congeners. In score variables plot (B) of Fig. 5.31. it seems that all PCDD/F and PCB homologues variables are spread chaotic in the multidimensional space. Most of the neighboured variable points belong to the same PCDD or PCDF homologues groups.

No correlation is found between PCDD/F and PCB homologues for the samples with higher and lower I-TEQ.

Some of the most interesting corresponding correlations concerning the samples with higher toxicity are drawn in two dimension plots in Fig. 5.32.

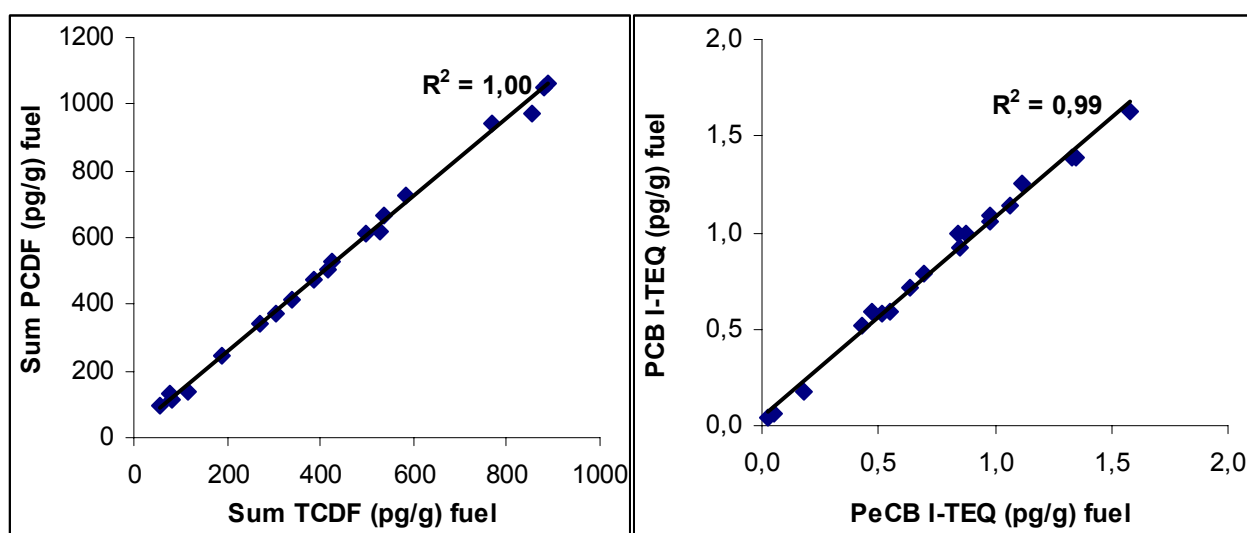

Fig.5.33: Couple points of score variables plot (A) of CA in Fig. 26. (V7 and V12 (A); V15 and V18 (B))

Discussion

Among the samples two groups of different I-TEQ are estimated by PCA. Each group is further analysed with CA. Very good correlation is found for the sum of TCDF congeners and the sum of all PCDF congeners. The calculated coefficient of determination (R^2) = 1.00 show that that two variables are perfectly correlated. According to Fig. 5.21. the percentage of the TCDF homologues among the other PCDF homologues for the samples with higher I-TEQ is estimated to be up to 85%. Thus, the above-mentioned correlation mainly is a result of the TCDF presence. Significant relationship for the samples with higher I-TEQ is also found between PeCB I-TEQ and PCB I-TEQ values. Since PCB 126 is the most toxic isomer among

the PeCB homologue and all other PCB congeners, it is very possible that that isomer relate strongly to the correlation and correlate with itself.

The samples with lower I-TEQ show no any sufficient correlation between the variables investigated. The missing correlation can be also explained with the strong inhibition of the used compounds and the non-detectable values for some of the most important congeners.

No correlation is found between PCDD/F and PCB homologues for the samples with higher and lower toxicity. Generally the knowledge about PCB and PCDD/F correlation is less than the investigated relation between PCBz and PCDD/F homologues. From practical view the measurement of PCB homologue is more difficult than that of PCBz. Based on statistical analysis such as PCA, Blumenstock proposed that the formation of PCB differs from the other chlorinated aromatics like PCDD/F [51]. The theory of precursor character of PCB for PCDF, via an oxidation followed by an internal ring closure [120] was not found for the proposed results. Investigations at a hazardous waste incinerator, for example, pointed out that some PCBs such as PCB 138, hexa- and heptachlorobiphenyls are good indicators for I-TEQ values [62]. Furthermore taking into account the same paper, Kaune discussed that in the stack gas of the HWI no correlation between PCB and PCDD/F homologues or congeners appeared.

6 Discussion

High emissions of PCDD/F and PCB are formed during the investigated pilot plant emission sampling campaigns. It is well known that PCDD/F are formed during wood combustion via precursors like phenol and lignin [121]. Wood combustion is important source of PAH and also considered to be responsible for significant amount of PCDD/F [122]. Choudhry and Hutzinger [120] identified that in the combustion of lignin could ultimately yield benzene. The last one take part in de novo dioxins synthesis. Even non-treated wood contain small amount of chlorine which can promote dioxins formation [121].

Much higher PCDD/F and PCB emission are detected during poplar wood and PVC incineration (campaign No. 4, 7, and 8). Alkyl substituted benzenes are the major organic products of the thermal decomposition of poly(vinyl chloride) PVC. On chlorination of benzene, polychlorinated benzenes are formed. By later steps the free radicals species react with oxygen to form peroxide radicals and finally the PCDFs are generated. The PCDDs are produced by incinerations of precursors like polychlorinated phenols [120].

The highest PCDD/F emissions are detected during wood incineration at 500°C where the measured O₂ content is low and the analyzed CO₂ and CO concentrations are high. These conditions stimulate soot formation and by de novo synthesis high concentrations of dioxins are formed. That process become possible if the sooty particles of the flue gas are reacting with O₂, chlorine and metal ion create dioxins in the flame.

The results of the poplar wood combustion and PVC at 700°C show that dioxins are not thermodynamically stable at higher temperature. 2,3,7,8-TCDD isomer and the I-TEQ value of that sample are present at a lower values than the combusted sample at 500°C. Choudhry proposed that the chlorine source (Cl₂) may react with oxygen to produce chlorine gas but the extend of the reaction decrease as the temperature rise [120]. Relatively low are the PCDD/F and PCB emissions of samples No. 2 and 7, combusted at 150°C and 130°C.

According to the sampling campaigns performed and their corresponding operation conditions and their final PCDD/F and PCB I-TEQ values it can be concluded that different parameters influence dioxin formation. That is the combustion temperature, oxygen availability, chlorine in the feed and residence time.

Experimental evidence suggests that temperature of 250-500°C promote PCDD/F and PCB formation, while temperature greater than 700°C decrease the concentrations of the same compounds. Insufficient oxygen content of around 12 Vol% increase the dioxins emissions and poor combustion conditions are promoted. Presence of chlorine in the fuel such as PVC indicates higher PCDD/F and PCB emissions.

In this study, a laboratory-scale furnace is used to perform a series of experiments designed to prevent the formation of PCDD/F formation by use of inhibitors. A mixture of lignite coal, solid waste and PVC are combusted at 400°C. Twenty different additives are investigated at a level of 10% of the total fuel during the experiments. They divide into four different types of groups according their chemical nature are studied as inhibitors of PCDD/F in flue gases of lignite coal, solid waste and PVC combustion.

This method is much simpler than others in which the inhibitor is sprayed into the post combustion zone, resulting in significant disturbances of large incineration plants. The results show that the substances belonging to the metal oxide group have no inhibitory effect. Some of the additives such as Cr_2O_3 , Al_2O_3 and TiO_2 could even increase the PCDD/F emissions. This fact can be explained by the mechanism of the *de novo* reaction for PCDD/F formation. The catalyst is a transition metal, such as copper, iron or one of the oxides of these metals, as it seems that the metal oxides can also promote the *de novo* reaction. They produce very high amounts of the most toxic isomers and high amount of lower chlorinated PCDD/F. Some other substances belonging to the metal oxides groups such as NaVO_3 , $\text{Na}_2\text{MoO}_4 \cdot 2\text{H}_2\text{O}$ and $\text{Na}_2\text{WO}_4 \cdot 2\text{H}_2\text{O}$ show low but still inhibitory effects, especially for PCDD. These substances are active for catalytic oxidation. Their chemical structure consists of a strong oxide base such as VO_3^- , MoO_4^{2-} , WO_4^{2-} . Probably due to that base, a better performance of incineration during the experiments occurs. Regardless, these additives cannot reduce PCDD/F sufficiently.

Relatively low inhibitory effects are also observed for the N-containing substances. The samples of that group of additives are located somewhere between the two extremes of the score plot. Ethanolamine as an inhibitory molecule contains the amino and hydroxyl functional groups and can undergo intermolecular dehydroamination reactions. Bromobenzene or the benzene precursors are displaced from the catalytically active sites, which are blocked by ethanolamine.

Higher reduction effects of PCDD/F can be derived for the S- containing substances present at 10% of the fuel. Sulfur shows a very strong inhibition effect of PCDD. It is already known that sulfur is converted into SO_2 and it reduces Cl_2 to HCl , and therefore dioxin formation can be reduced [38]. Probably, also because of this mechanism, the rest of the S-containing compounds inhibit PCDD/F flue gases.

Although the single N- and S- containing compounds are not very effective as inhibitors, all other N- and S- containing substances seem to be able to reduce strongly PCDD/F flue gas emission if used as a 10% additive of lignite coal, solid waste and PVC as fuel. The most effective inhibitors are $(\text{NH}_4)_2\text{SO}_4$ and $(\text{NH}_4)_2\text{S}_2\text{O}_3$; they are inexpensive and non-toxic materials. Both compounds can suppress the formation of toxic compounds like PCDD/F by more than 98-99%, and the most toxic PCDD/F isomers are not detectable in most of the samples. Thus, these compounds were also studied at lower percentage of the fuel. $(\text{NH}_4)_2\text{SO}_4$ resulted in a greater than 90% reduction of PCDD/F even composing only 3% of the fuel combusted. However, less than 5% $(\text{NH}_4)_2\text{S}_2\text{O}_3$ of the fuel resulted in weaker inhibition. The PCDD/F homologues distribution ratio for all samples and samples with varying percentage of $(\text{NH}_4)_2\text{SO}_4$ and $(\text{NH}_4)_2\text{S}_2\text{O}_3$ is also investigated. Higher percentages of the inhibitors produced lower percentage of lower chlorinated PCDD and PCBz. For the PCDF and PCB content the opposite is found.

At 1000°C , higher PCDD/F amount for the samples without inhibitor is determined. During that experiments the inhibition effect of $(\text{NH}_4)_2\text{SO}_4$ show lower values for PCDD/F and PCB but not detectable concentration for 2,3,7,8-TCDD isomer. Despite conclusions for inhibitory effect are quite uncertainty because of the high variable PCDD/F and PCB emissions emitted during the experiments where no any inhibitor is used. Thus, it's recommendable to repeat the experiments by employing an adjusted protocol. During that new set experiments, the furnace is prior electrically preheated to the 200°C and the sample is introduced in the centre of the heating zone. In later steps the furnace is set to 800°C for 30 min and then to 1000°C for another 30 min. During that procedure the estimated PCDD/F is higher compared to the same samples performed at 400°C but much lower than the previously performed experiments at 1000°C . Concerning the inhibitory effect of $(\text{NH}_4)_2\text{SO}_4$, according Fig. 5. 23, seems that the PCDD/F I-TEQ amount decrease among the two repeatable samples. Explanation is found due to the amass lay of $(\text{NH}_4)_2\text{SO}_4$ in the post combustion zone which can inhibit additionally the further produced PCDD/F

emissions during the next experiments. Taking into account that hypotheses, the realistic value for the inhibitory effect of $(\text{NH}_4)_2\text{SO}_4$ at 1000°C is estimated at about 90% reduction of PCDD/F emission. That result is considered for the experiments where the inhibitor is used firstly among the set of experiments.

The correlation between the PCDD/F, PCB and PCBz for the samples elaborate in a laboratory furnace is also investigated. By the help of PCA, the samples are easily divided according their toxicity. A good correlation is found between tetra and penta chlorinated benzenes and tetra and penta chlorinated dibenzo-p-furans for the samples with higher toxicity. The best indicator parameter between the investigated PCBz congeners is 1,2,4,5-TCBz. That isomer is also significantly correlated with PCDD/F I-TEQ value. For the samples treated with high percentage of inhibitors the above mentioned relationships are not observed. This correlation lacks is probably due to the strong inhibition of the used compounds and the non-detectable values for some of the most important congeners such as 2,3,7,8-TCDD and some other lower chlorinated PCDD/F isomers. It is also possible that different pathways of chloroaromatic formation are dominated for that kind of samples. However good correlation between I-TEQ value and PCBz concentration is found in the flue gases of wet scrubber and stack gas of HSW incinerator [62], [50], [123]. That proof the fact that the minimization of toxic emissions by cleaning systems like wet scrubber can not influence to the pathway of dioxin formation. While when addition of selected compounds like inhibitors is used, the dioxins and their precursors are totally blocked or probably some other mechanistic ways prevailed.

No correlation is found for both group of samples between PCB homologues and PCDD/F or PCBz homologues. It may mean that the formation mechanisms of PCB and PCDD/F and / or PCBz is different. Such conclusion is also proposed from other authors.

7 Outlook

According to the final results $(\text{NH}_4)_2\text{SO}_4$ is the most effective inhibitor for dioxin emissions among the used additives to the fuel mixture in a laboratory scale furnace. It is an inexpensive and non-toxic material. So that this compound is recommendable to be used in a full scale plant of coal / waste combustion.

The mechanism of $(\text{NH}_4)_2\text{SO}_4$ inhibition is necessary to be considered. During the performed laboratory experiments the fly ash of each sample was saved in bottles sealed in Ar atmosphere. A further spectroscopic investigation can on one hand light shed upon the mechanisms of the bond formation in molecules in the combustion processes and on the other hand it may detect some new complexes which manifest dioxin suppression effects.

8. Appendix

8.1. Dioxin Laboratory

8.1.1. Materials

Equipment	Company	Type
Rotary evaporator	Büchi	EL 131
precision Balance	Sartorius	LC 4800 P
N ₂ -Thermoblock	Labor Technik Barkley	
Ultrasonic bath	Bandelin, Sonorex	RK 510 H
Drying oven	Heraeus-Wärmetechnik	WU 610
Laboratory machine for rinsing	Miele, Typ Mielabor	G 7733
Glassware	Volume	Trimble
Round flask	100, 250, 500, 1000 mL	NS 29/32
Erlenmeyer flask	50, 100, 250, 500, 1000 mL	NS 29/32
Soxhlet apparatus	500, 1000 mL	NS 29/32
Dropping funnel	100, 300 mL	NS 29/32
Graduated cylinder	25, 50, 100, 250, 500 mL	
Chromatographic column		
Pasteur pipet		
Solvents, adsorbents, consumptions	Package Quantity	Supplier
Aceton	4 L	Promochem
Acetonitrile	2. 5 L	Riedel-de-Haen
Benzene	2. 5 L	Promochem
Dichloromethane	4 L	Promochem
Chloroform	2. 5 L	Merck
Nonan	2. 5 L	Promochem
n- Hexane	2. 5 L	Promochem
Tetradecan	500 mL	Aldrich Chemical
Toluene	2. 5 L	Riedel-de-Haen
Aluminium oxide B Super I	500 g	ICN Biomedicals
Bio-Bed SX-8		Bio Rad
C-18	100 g	Bulb
Sodium chloride	5 Kg	Merck
Silica gel	1 Kg	Promochem
Florisil	500 g	Promochem
Glass wool	1 Kg	Neolab
XAD -2	100g	Supelco
Vials		neolab

8.1.2. Equipment and Program adjustment

Tab. 8.1: Equipment and program adjustment for PCDD/F analysis

PCDD/F			
Equipment			
HRGC	Agilent 6890		
HRMS	Finnigan MAT 95S		
Capillary column	Restek Rtx-2330		
	length: 60 m	Ionisation mode	EI
	Inner Diameter: 0.25 mm	Ionisation energy	70 eV
	Film thickness: 0.1 µm	Ion source temperature	260 °C
Carrier gas	Helium, 1.2ml/min constant flow	Interface temperature	260 °C
Injection	Gerstel KAS 4	Resolution	10000
	splitless		
	120°C, 12°C/sec 280 °C		
Temperature-program	90 °C; 1.5 min, 25 °C/min 180 °C, 2 °C/min 260 °C; 15 min		

Tab. 8.2: Equipment and program adjustment for PCB analysis

PCB			
Equipment			
HRGC	Agilent 5890 Series II		
HRMS	Finnigan MAT 95		
Capillary column	J&W DB-5ms		
	length: 60 m	Ionisation mode	EI
	Inner Diameter: 0.25 mm	Ionisation energy	70 eV
	Film thickness: 0.1 µm	Ion source temperature	260 °C
Carrier gas	Helium, 2 bar head pressure		
Injection	Gerstel KAS 3	Interface temperature	300 °C
	splitless		
Temperature program	60°C, 12°C/sec 280 °C	Resolution	8500
	90 °C; 1.5 min, 20 °C/min 170 °C; 7.5 min, 3 °C/min 280 °C; 10 min		

8.1.3. Standard substances

PCDD/F	c (pg/µl)	PCDF	c (pg/µl)	PCB	c (pg/µl)
<i>Sampling standard</i>		<i>Internal standard</i>		<i>Recovery standard</i>	
¹³ C ₆ -1,2,3,4-TCDD	500	¹³ C ₁₂ -2,8-DiCDF	100	¹³ C ₁₂ -1,2,3,4-TCDD	500
¹³ C ₁₂ -1,2,3,7,8,9-HxCDD	500	¹³ C ₁₂ -2,3,7,8-TCDF	100	4-MCB	800
		¹³ C ₁₂ -1,2,3,7,8-PeCDF	400	4,4'-DiCB	800
<i>Internal standard</i>		¹³ C ₁₂ -2,3,4,7,8-PeCDF	200	2,4,4'-TriCB	800
¹³ C ₁₂ -1,2,3,4-TCDD	100	¹³ C ₁₂ -1,2,3,4,7,8-HxDF	300	2,2',5,5'-TeCB	700
		¹³ C ₁₂ -1,2,3,6,7,8-HxDF	300	3,3',4,4'-TeCB	1000
<i>Recovery standard</i>		¹³ C ₁₂ -1,2,3,7,8,9-HxDF	300	2,2',4,5,5'-PeCB	1000
¹³ C ₁₂ -2,7-DiCDD	100	¹³ C ₁₂ -2,3,4,6,7,8-HxDF	300	2,3,3',4,4'-PeCB	1000
¹³ C ₁₂ -2,3,7-TriCDD	100	¹³ C ₁₂ -1,2,3,4,6,7,8-HpDF	400	3,3',4,4',5-PeCB	700
¹³ C ₁₂ -2,3,7,8-TCDD	100	¹³ C ₁₂ -1,2,3,4,7,8,9-HpDF	400	2,2',4,4',5,5'-HxCB	1200
¹³ C ₁₂ -1,2,3,7,8-PeCDD	250	OCDF	900	2,2',3,4,4',5'-HxCB	700
¹³ C ₁₂ -1,2,3,4,7,8-HxDD	200			3,3',4,4',5,5'-HxCB	900
¹³ C ₁₂ -1,2,3,6,7,8-HxDD	200			2,2',3,4,4',5,5'-HpCB	1000
¹³ C ₁₂ -1,2,3,7,8,9-HxDD	200			2,2',3,3',4,4',5,5'-OCB	700
¹³ C ₁₂ -1,2,3,4,6,7,8-HpDD	300			2,2',3,3',4,4',5,5',6-NCB	1000
OCDD	900			2,2',3,3',4,4',5,5',6,6'-DCB	800

8.2. Emission Sampling

8.2.1. Equipments

Equipment	Specifications	Company
Nozzles	material: high-grade steel diameter: 25; 30 mm	Ströhlein
Nozzles	material:titanium diameter: 6; 8; 10; 12; 14; 18	Gothe
Sampling tube	DURAN glass, 1460 mm, internal Ø 9mm, outside Ø10mm	Hand made
Suction tube	Steel, 1000 mm	Ströhlein
Condensate flask	2 L, brown glass, DURAN	
Hose connection	Rubber Hose Variopress 20 bar BD	Pirelli Treg
Gas meter	Typ G4/6, 1996	Elster
Gas meter	Typ G4, 1995	Ströhlein
Drying tower	70 mm Ø	Ströhlein
Gas-tight pump	Typ TV15/12, 1450 per min, Motor Leistung 0,58 kw, 50 Hz, 16,3 m ³ /h	Ströhlein
MRU 4000V Regulating valve	230 V , 50 Hz	Ströhlein
MRU 4000R control unit	230 V, 50 Hz, 25 VA	Ströhlein
Notebook for MRU 4000	75 MHz, Pentium	Texas Instrument
Prandtl tube	length 1000mm, nozzle head 15mm,	Ströhlein
Prandtl tube	length 1000mm, nozzle head 10mm,	Gothe
Manometer	Typ Digima LPU 250	Special Instrument
Thermocouple	NiCr-Ni, length 1020mm	Ströhlein
TESTO analyzer	Typ 350	TESTO
Notebook for TESTO 350	Pentium III, Hard disk 10 G bytes	Dell
Klimacenter with	hygrometer, barometer and thermometer	TFA, Germany
U-shaped tube	glass, internal diameter 14 mm	Ströhlein
calcium chloride	dried, granulate, 1-2 mm,	Merck
Pump	flow rate of 2 Litres per minute	

8.2.2. Combusted fuel

Combusted fuel	Supplier
Poplar wood	OBI market
Beech/ Oak wood	Brennstoff- Vertrieb-Gesellschaft, München
PVC	waste from ground carpet
PVC	CIEMAT, Spain
Solid waste	Rethmann Plano GmbH

8.3. Laboratory Scale Experiments

8.3.2. Equipment

Equipment	Specifications	Company
Three zone horizontal tube furnace	type HZS & TVS length: 900 mm max temperature: 1200°C 415V, 3 phases, 50Hz, 4.5 kW	CARBOLITE GmbH, Ubstadt-Weiher
mechanical mortar	6 A	Retsch apparatus

8.3.2. Reagents

chromium (III) oxide (Cr_2O_3)	Merck
titanium (IV) oxide (TiO_2)	Merck
sodium (meta) vanadate (NaVO_3)	Fluka
zirconium (IV) oxide (ZrO_2)	Merck
aluminium(III)oxide (Al_2O_3)	ICN-EcoChrom
sodium molybdate dihydrate ($\text{Na}_2\text{MoO}_4 \cdot 2\text{H}_2\text{O}$)	Fluka
sodium tungstate dihydrate ($\text{Na}_2\text{WO}_4 \cdot 2\text{H}_2\text{O}$)	Fluka
di-ammoniumhydrogenphosphate ($(\text{NH}_4)_2\text{HPO}_4$)	Merck
triethanolamine ($\text{N}(\text{CH}_2\text{CH}_2\text{OH})_3$)	Merck
hexamethylphosphoramide ($[(\text{CH}_3)_2\text{N}]_3\text{P}(\text{O})$)	Sigma-Aldrich Chemie
sulfur (S)	Sigma-Aldrich Chemie
phosphorus (V) sulfide (P_2S_5)	Merck
sodium sulfide ($\text{Na}_2\text{S} \cdot \text{H}_2\text{O}$)	Merck
hydroxylamine-O-sulfonic acid ($\text{H}_2\text{NSO}_4\text{H}$)	Merck
amidosulfonic acid ($\text{H}_2\text{NSO}_3\text{H}$)	Sigma-Aldrich Chemie
sulfamide ($\text{H}_2\text{NSO}_2\text{NH}_2$)	Sigma-Aldrich Chemie
ammoniumthiosulfate ($(\text{NH}_4)_2\text{S}_2\text{O}_3$)	Merck
urea+sulfur ($(\text{NH}_2)_2\text{CO}+\text{S}$) (1:1)	urea, techn.
ammoniumsulfate ($(\text{NH}_4)_2\text{SO}_4$)	Merck
synthetic air	Linde

9 References

1. Stieglitz, L., G. Zwick, J. Beck, W. Roth, and H. Vogg, *On the De-Novo Synthesis of PCDD/PCDF On Fly-Ash of Municipal Waste Incinerators*. Chemosphere, 1989. **18**(1-6): p. 1219-1226.
2. Samaras, P., G. Skodras, G.P. Sakellaropoulos, M. Blumenstock, K.-W. Schramm, and A. Kettrup, *Toxic emissions during co-combustion of biomass-waste wood-lignite blends in an industrial boiler*. Chemosphere, 2001. **43**(4-7): p. 751-755.
3. Technology status report, *Waste/biomass co-gasification with coal*. Department of trade and industry, 2002.
4. VGB Power Tech, *Co-Combustion Emission Control*. Technical report project ECSC 7220-PR-108, 2002.
5. München, A., *Müll von A bis Z*. 2003: p. 1-1.
6. Kicherer, A., T. Gerhardt, H. Spliethoff, and K.R.G. Hein, *Final report IVD, APAS-Clean Coal Technology Programme*. 1995.
7. Van de Kamp, W.L. and D.J. Morgan, *Final report IFRF, APAS-Clean Coal Technology Programme*. 1995.
8. Thomé -Kozmiensky, K.J., *Thermische Abfallbehandlung*. EF- Ver. Für Energie- und Umwelttechnik, 1994. **ISBN 3-924511-77-2**.
9. Tuppurainen, K., I. Halonen, P. Ruokojarvi, J. Tarhanen, and J. Ruuskanen, *Formation of PCDDs and PCDFs in municipal waste incineration and its inhibition mechanisms: A review*. Chemosphere, 1998. **36**(7): p. 1493-1511.
10. Olie, K., P.L. Vermeulen, and H. O., *Chlorodibenzo-p-dioxins and chlorodibenzofurans are trace components of fly ash and fly gas of some municipal incinerators in the Netherlands*. Chemosphere, 1977. **6**: p. 182-191.
11. Bundesgesetzblatt, *Siebzehnte Verordnung zur Durchführung des Bundes-Immissionsschutzgesetzes: Verordnung über Verbrennungsanlagen für Abfälle und ähnliche brennbare Stoffe*.
12. United States Environmental Protection Agency., *Combustion Emission Technical Resource Document (CETRED), Report No. EPA 530-R-94-014*. 1994b.
13. United States Environmental Protection Agency, *Office of Research and Development; Health Assessment Document for 2,3,7,8-Tetrachlorodibenzozo-*

- p*-dioxin (TCDD) and Related Compounds; EPA/600/Bp-92/001c Estimation Exposure to Dioxin-Like Compounds, EPA/600/6-88/005Cb;. 1994a.
14. Öberg, L.G., R. Anderson, and R. C., *De novo formation of hepta- and octachlorodibenzo-p-dioxins from pentachlorophenol in municipal sewage sludge*. Organohalogenic Compounds, 1992. **9**: p. 351-354.
 15. Schramm, K.-W., C. Klimm, B. Henkelmann, and A. Kettrup, *Formation of octa- and heptachlorodibenzo-p-dioxins during semi-anaerobic digestion of sewage sludge*. Organohalogen Compounds, 1996. **27**: p. 84-87.
 16. Hutzinger, O., M.J. Blumich, M. Vanderberg, and K. Olie, *Sources and Fate of PCDDs and PCDFs - an Overview*. Chemosphere, 1985. **14**(6-7): p. 581-600.
 17. Luthardt, P., J. Mayer, and J. Fuchs, *Total TEQ emissions (PCDD/F and PCB) from industrial sources*. Chemosphere, 2002. **46**(9-10): p. 1303-1308.
 18. Gullett, B.K., P.M. Lemieux, C.C. Lutes, C.K. Winterrowd, and D.L. Winters, *Emissions of PCDD/F from uncontrolled, domestic waste burning*. Chemosphere, 2001. **43**(4-7): p. 721-725.
 19. Vogg, H. and L. Stieglitz, *Thermal-Behavior of PCDD/PCDF in Fly-Ash From Municipal Incinerators*. Chemosphere, 1986. **15**(9-12): p. 1373-1378.
 20. Manninen, H., K. Peltola, and J. Ruuskanen, *Co-combustion of refuse-derived and packaging-derived fuels (RDF and PDF) with conventional fuels*. Waste Management & Research, 1997. **15**(2): p. 137-147.
 21. Fre, R., M. Wevers, and G. Vanermen, *Dioxin and PAH in chimney soot from domestic heating appliances with solid fuels*. Dioxin 2003 Boston Conference, 2003. **60-65**.
 22. Yoneda, K., T. Ikeguchi, Y. Yagi, Y. Tamade, and K. Omori, *A research on dioxin generation from the industrial waste incineration*. Chemosphere, 2002. **46**(9-10): p. 1309-1319.
 23. Sakai, S., T. Ukai, H. Takatsuki, K. Nakamura, S. Kinoshita, and T. Takasuga, *Substance flow analysis of coplanar PCBs released from waste incineration processes*. J. Mater Cycles Waste Manag., 1999. **1**: p. 62-74.
 24. Sakai, S.I., K. Hayakawa, H. Takatsuki, and I. Kawakami, *Dioxin-like PCBs released from waste incineration and their deposition flux*. Environmental Science & Technology, 2001. **35**(18): p. 3601-3607.

25. Jiang, K., L.J. Li, Y.D. Chen, and J. Jin, *Determination of PCDD/Fs and dioxin-like PCBs in Chinese commercial PCBs and emissions from a testing PCB incinerator*. Chemosphere, 1997. **34**(5-7): p. 941-950.
26. Levendis, Y.A., A. Atal, J.B. Carlson, and M.D. Quintana, *PAH and soot emissions from burning components of medical waste: examination/surgical gloves and cotton pads*. Chemosphere, 2001. **42**(5-7): p. 775-783.
27. Kaune, A., K.-W. Schramm, R. Lehnardt, A. Kettrup, I. Ollenschlager, and H. Rossel, *Polychlorinated dibenzodioxins and dibenzofurans in the aluminium recycling process*. Journal of Analytical and Applied Pyrolysis, 1999. **49**(1-2): p. 191-198.
28. Snaub, W.M. and W. Tsang, *Dioxin formation in incinerators*. Environ. Sci. & Technol., 1983. **17**: p. 721-730.
29. Huang, H. and A. Buekens, *On the Mechanisms of Dioxin Formation in Combustion Processes*. Chemosphere, 1995. **31**(9): p. 4099-4117.
30. Stieglitz, L., *Selected topics on the de novo synthesis of PCDD/PCDF on fly ash*. Environmental Engineering Science, 1998. **15**(1): p. 5-18.
31. Stieglitz, L., H. Bautz, W. Roth, and G. Zwick, *Investigation of precursor reactions in the de-novo-synthesis of PCDD/PCDF on fly ash*. Chemosphere, 1997. **34**(5-7): p. 1083-1090.
32. Stieglitz, L., H. Vogg, G. Zwick, J. Beck, and H. Bautz, *On Formation Conditions of Organohalogen Compounds From Particulate Carbon of Fly-Ash*. Chemosphere, 1991. **23**(8-10): p. 1255-1264.
33. Stieglitz, L., M. Eichberger, J. Schleihauf, J. Beck, G. Zwick, and R. Will, *The Oxidative-Degradation of Carbon and Its Role in the De-Novo-Synthesis of Organohalogen Compounds in Fly-Ash*. Chemosphere, 1993. **27**(1-3): p. 343-350.
34. Taylor, P.H., A. Wehrmeier, S.S. Sidhu, D. Lenoir, K.W. Schramm, and A. Kettrup, *Copper-catalyzed chlorination and condensation of acetylene and dichloroacetylene*. Chemosphere, 2000. **40**(12): p. 1297-1303.
35. Taylor, P.H. and D. Lenoir, *Chloroaromatic formation in incineration processes*. Science of the Total Environment, 2001. **269**(1-3): p. 1-24.
36. Lenoir, D., A. Wehrmeier, K.-W. Schramm, A. Kaune, R. Zimmermann, P.H. Taylor, and S.S. Sidhu, *Thermal formation of polychlorinated dibenzo-p-*

- dioxins and -furans: Investigations on relevant pathways.* Environmental Engineering Science, 1998. **15**(1): p. 37-47.
37. Lenoir, D., A. Wehrmeier, S.S. Sidhu, and P.H. Taylor, *Formation and inhibition of chloroaromatic micropollutants formed in incineration processes.* Chemosphere, 2001. **43**(1): p. 107-114.
 38. Gullett B., Bruce K.R., and Beach L.O., *Effect of sulfur dioxide on the formation mechanism of polychlorinated dibenzodion and dibenzofuran in municipal waste combustors.* Environ. Sci. Technol., 1992. **26**: p. 1938.
 39. Milligan, M.S. and E. Altwicker, *The relationship between de novo synthesis of polychlorinated dibenzo-p-dioxins and dibenzofurans and low temperature carbon gasification in fly ash.* Environ. Sci. & Technol., 1993. **27**: p. 1595-1601.
 40. Blaha, J. and H. Hagenmaier, *Time dependence of the de novo synthesis of PCDD/PCDF and potential precursors on the fly ash.* Organohalogen Compounds, 1995. **23**: p. 403-406.
 41. Huang, H. and A. Buekens, *Chemical kinetic modeling of de novo synthesis of PCDD/F in municipal waste incinerators.* Chemosphere, 2001. **44**(6): p. 1505-1510.
 42. Lippert, T., A. Wokaun, and D. Lenoir, *Copper Catalyzed Aryl Dehalogenation Reactions and Their Inhibition.* Berichte Der Bunsen-Gesellschaft-Physical Chemistry Chemical Physics, 1991. **94**(12): p. 1465-1471.
 43. Karasek, F. and D.C. Dickson, *Model studies of polychlorinated dibenzo-p-dioxin formation during municipal refuse incineration.* Science, 1987. **19**(754-756).
 44. Altwicker, E.R., *Formation of PCDD/F in municipal solid waste incinerators: Laboratory and modeling studies.* Journal of Hazardous Materials, 1996. **47**(1-3): p. 137-161.
 45. Hell, K., L. Stieglitz, E.R. Altwicker, R. Addink, and R. Will, *Reactions of 2,4,6-trichlorophenol on model fly ash: oxidation to CO and CO₂, condensation to PCDD/F and conversion into related compounds.* Chemosphere, 2001. **42**(5-7): p. 697-702.
 46. Wikström, E., S. Ryan, A. Touati, and B.K. Gullett, *Key parameters for de novo formation of polychlorinated dibenzo-p-dioxins and dibenzofurans.* Environmental Science & Technology, 2003. **37**(9): p. 1962-1970.

47. Lenoir, D., A. Kaune, O. Hutzinger, G. Mutzenich, and K. Horch, *Influence of Operating Parameters and Fuel Type On Pcd-d-F Emissions From a Fluidized-Bed Incinerator*. Chemosphere, 1991. **23**(8-10): p. 1491-1500.
48. Takeshita, R., Y. Akimoto, and S. Nito, *Relationship Between the Formation of Polychlorinated Dibenzo-Para-Dioxins and Dibenzofurans and the Control of Combustion, Hydrogen-Chloride Level in Flue-Gas and Gas Temperature in a Municipal Waste Incinerator*. Chemosphere, 1992. **24**(5): p. 589-598.
49. Gullett, B.K., J.E. Dunn, S.K. Bae, and K. Raghunathan, *Effects of combustion parameters on polychlorinated dibenzodioxin and dibenzofuran homologue profiles from municipal waste and coal co-combustion*. Waste Management, 1998. **18**(6-8): p. 473-483.
50. Fängmark I., Bavel B., Marklund S., Strömberg B., Berge N., and Rappe C., *Influence of Combustion Parameters on the Formation of Polychlorinated Dibenzo-p-dioxins, Dibenzofurans, Benzenes, and Biphenyls and Polyaromatic Hydrocarbons in a Pilot Incinerator*. Environ. Sci. Technol., 1993. **27**: p. 1602-1610.
51. Blumenstock, M., R. Zimmermann, K.-W. Schramm, and A. Kettrup, *Influence of combustion conditions on the PCDD/F-, PCB-, PCBz- and PAH-concentrations in the post-combustion chamber of a waste incineration pilot plant*. Chemosphere, 2000. **40**(9-11): p. 987-993.
52. Wikström, E. and S. Marklund, *The influence of level and chlorine source on the formation of mono- to octa-chlorinated dibenzo-p-dioxins, dibenzofurans and coplanar polychlorinated biphenyls during combustion of an artificial municipal waste*. Chemosphere, 2001. **43**(2): p. 227-234.
53. Halonen, I., J. Tarhanen, S. Ollikainen, P. Ruokojarvi, K. Tuppurainen, and J. Ruuskanen, *The Effect of Inorganic and Organic Chlorine On Formation of Highly Chlorinated Organic-Compounds During Incineration - Laboratory Pilot-Study (Vol 12, Pg 2129, 1994)*. Chemosphere, 1994. **29**(6).
54. Halonen, I., J. Tarhanen, P. Ruokojarvi, K. Tuppurainen, and J. Ruuskanen, *Effect of Catalysts and Chlorine Source On the Formation of Organic Chlorinated Compounds*. Chemosphere, 1995. **30**(7): p. 1261-1273.
55. Wang, L.C., W.J. Lee, W.S. Lee, G.P. Chang-Chien, and P.J. Tsai, *Effect of chlorine content in feeding wastes of incineration on the emission of*

- polychlorinated dibenzo-p-dioxins/dibenzofurans*. Science of the Total Environment, 2003. **302**(1-3): p. 185-198.
56. Wobst, M., H. Wichmann, and M. Bahadir, *Influence of heavy metals on the formation and the distribution behavior of PAH and PCDD/F during simulated fires*. Chemosphere, 2003. **51**(2): p. 109-115.
57. Blumenstock, M., R. Zimmermann, K.-W. Schramm, A. Kaune, U. Nikolai, D. Lenoir, and A. Kettrup, *Estimation of the dioxin emission (PCDD/FI-TEQ) from the concentration of low chlorinated aromatic compounds in the flue and stack gas of a hazardous waste incinerator*. Journal of Analytical and Applied Pyrolysis, 1999. **49**(1-2): p. 179-190.
58. Zimmermann, R., H.J. Heger, M. Blumenstock, R. Dorfner, K.-W. Schramm, U. Boesl, and A. Kettrup, *On-line measurement of chlorobenzene in waste incineration flue gas as a surrogate for the emission of polychlorinated dibenzo-p-dioxins/furans (I-TEQ) using mobile resonance laser ionization time-of-flight mass spectrometry*. Rapid Communications in Mass Spectrometry, 1999. **13**(5): p. 307-314.
59. Kaune, A., D. Lenoir, K.-W. Schramm, R. Zimmermann, A. Kettrup, K. Jaeger, H.G. Ruckel, and F. Frank, *Chlorobenzenes and chlorophenols as indicator parameters for chlorinated dibenzodioxins and dibenzofurans in incineration processes: Influences of various facilities and sampling points*. Environmental Engineering Science, 1998. **15**(1): p. 85-95.
60. Blumenstock, M., R. Zimmermann, K.-W. Schramm, and A. Kettrup, *Identification of surrogate compounds for the emission of PCDD/F (I-TEQ value) and evaluation of their on-line realtime detectability in flue gases of waste incineration plants by REMPI-TOFMS mass spectrometry*. Chemosphere, 2001. **42**(5-7): p. 507-518.
61. Öberg T. and Bergström J.G.T., *Hexachlorobenzene as an indicator of dioxin production from combustion*. Chemosphere, 1985. **14**(8): p. 1081-1086.
62. Kaune, A., D. Lenoir, U. Nikolai, and A. Kettrup, *Estimating concentrations of polychlorinated dibenzo-p-dioxins and dibenzofurans in the stack gas of a hazardous waste incinerator from concentrations of chlorinated benzenes and biphenyls*. Chemosphere, 1994. **29**(9-11): p. 2083-2096.
63. Oehme, M., S. Man, and A. Mikalsen, *Formation and presence of polyhalogenated and polycyclic compounds in the emissions of small and*

- large scale municipal waste incinerators*. Chemosphere, 1987. **16**(1): p. 143-153.
64. Tuppurainen, K., A. Asikainen, P. Ruokojarvi, and J. Ruuskanen, *Perspectives on the formation of polychlorinated dibenzo-p-dioxins and dibenzofurans during municipal solid waste (MSW) incineration and other combustion processes*. Accounts of Chemical Research, 2003. **36**(9): p. 652-658.
65. Gullett, B.K. and E. Wikstrom, *Mono- to tri-chlorinated dibenzodioxin (CDD) and dibenzofuran (CDF) congeners/homologues as indicators of CDD and CDF emissions from municipal waste and waste/coal combustion*. Chemosphere, 2000. **40**(9-11): p. 1015-1019.
66. Öberg, T. and B. J.G.T., *Indicator parameters for PCDD/F*. Chemosphere, 1989. **19**: p. 337-344.
67. Manninen H., Perkiö A., Vartianen T., and Ruuskanen J., *Effect of fuel and fly ash composition on the formation of PCDD/PCDF in the co-combustion of refuse-derived and packaging-derived fuels*. Environ. Sci. & Pollut. Res., 1996. **3**(3): p. 129-134.
68. McKay, G., *Dioxin characterisation, formation and minimisation during municipal solid waste (MSW) incineration: review*. Chemical Engineering Journal, 2002. **86**(3): p. 343-368.
69. Hentschel, B. and H. Riedel, *Contribution of stack gases and solid process wastes to the organic pollutant output of thermal waste treatment plants*. Chemosphere, 2001. **43**(4-7): p. 727-735.
70. Bonte, J.L., K.J. Fritsky, M.A. Plinke, and M. Wilken, *Catalytic destruction of PCDD/F in a fabric filter: experience at a municipal waste incinerator in Belgium*. Waste Management, 2002. **22**(4): p. 421-426.
71. Huang, Y., M. Takaoka, and N. Takeda, *Chlorobenzenes removal from municipal solid waste incineration fly ash by surfactant-assisted column flotation*. Chemosphere, 2003. **52**(4): p. 735-743.
72. Takaoka, M., P. Liao, N. Takeda, T. Fujiwara, and K. Oshita, *The behavior of PCDD/Fs, PCBs, chlorobenzenes and chlorophenols in wet scrubbing system of municipal solid waste incinerator*. Chemosphere, 2003. **53**(2): p. 153-161.
73. Takeda, N., M. Takaoka, T. Fujiwara, H. Takeyama, and S. Eguchi, *Measures to prevent emissions of PCDDs/DFs and co-planar PCBs from crematories in Japan*. Chemosphere, 2001. **43**(4-7): p. 763-771.

74. Naikwadi, K.P. and F.W. Karasek, *Prevention of Pccd Formation in Msw Incinerators By Inhibition of Catalytic Activity of Fly-Ash Produced*. Chemosphere, 1989. **19**(1-6): p. 299-304.
75. Strömberg, B., *Low temperature formation and minimization of chlorinated hydrocarbons*. Chemosphere, 1991. **23**(8-10): p. 1515-1525.
76. Addink, R., R. Paulus, and K. Olie, *Prevention of polychlorinated dibenzo-p-dioxins/dibenzofurans formation on municipal waste incinerator fly ash using nitrogen and sulfur compounds*. Environmental Science & Technology, 1996. **30**(7): p. 2350-2354.
77. Weber, R., T. Takasuga, K. Nagai, H. Shiraishi, T. Sakurai, T. Matuda, and M. Hiraoka, *Dechlorination and destruction of PCDD, PCDF and PCB on selected fly ash from municipal waste incineration*. Chemosphere, 2002. **46**(9-10): p. 1255-1262.
78. Sun, R.D., H. Irie, T. Nishikawa, A. Nakajima, T. Watanabe, and K. Hashimoto, *Suppressing effect of CaCO₃ on the dioxins emission from poly(vinyl chloride) (PVC) incineration*. Polymer Degradation and Stability, 2003. **79**(2): p. 253-256.
79. Suzuki, K., T. Yamasaki, and Y. Yamashita, *Control of dioxin formation using new sorbent contained calcium compound as main componenet in incinerators*. Dioxin 2003 Boston Conference, 2003. **60-65**.
80. Cho, C.H. and S.K. Ihm, *Development of new vanadium-based oxide catalysts for decomposition of chlorinated aromatic pollutants*. Environmental Science & Technology, 2002. **36**(7): p. 1600-1606.
81. Stoll, M., J. Furrer, H. Seifert, G. Schaub, and D. Unruh, *Effects of flue gas composition on the catalytic destruction of chlorinated aromatic compounds with a V-oxide catalyst*. Waste Management, 2001. **21**(5): p. 457-463.
82. Krishnamoorthy, S., J.A. Rivas, and M.D. Amiridis, *Catalytic oxidation of 1,2-dichlorobenzene over supported transition metal oxides*. Journal of Catalysis, 2000. **193**(2): p. 264-272.
83. Yim, S.D., D.J. Koh, and I.S. Nam, *A pilot plant study for catalytic decomposition of PCDDs/PCDFs over supported chromium oxide catalysts*. Catalysis Today, 2002. **75**(1-4): p. 269-276.
84. Andreeva, D., T. Tabakova, L. Ilieva, A. Naydenov, D. Mehanijev, and M.V. Abrashev, *Nanosize gold catalysts promoted by vanadium oxide supported on*

- titania and zirconia for complete benzene oxidation*. *App. Catal. A.*, 2001. **209**: p. 291-300.
85. Dickson, L.C., D. Lenoir, O. Hutzinger, K.P. Naikwadi, and F.W. Karasek, *Inhibition of Chlorinated Dibenzo-Para-Dioxin Formation On Municipal Incinerator Fly-Ash By Using Catalyst Inhibitors*. *Chemosphere*, 1989. **19**(8-9): p. 1435-1445.
86. Buekens, A., L. Stieglitz, K. Hell, H. Huang, and P. Segers, *Dioxins from thermal and metallurgical processes: recent studies for the iron and steel industry*. *Chemosphere*, 2001. **42**(5-7): p. 729-735.
87. Xhrouet, C., C. Nadin, and E. De Pauw, *Amines compounds as inhibitors of PCDD/Fs de novo formation on sintering process fly ash*. *Environmental Science & Technology*, 2002. **36**(12): p. 2760-2765.
88. Lenoir, D., H. O., G. Mützenich, and K. Horch, *Verhinderung der Entstehung chlorierter Dibenzodioxine und Furane bei der Müllverbrennung: Inhibierung der katalytische Bildung*. *UWSF.-Z. Umweltchem*, 1989. **4**: p. 3-6.
89. Tuppurainen, K., M. Aatamila, P. Ruokojärvi, I. Halonen, and J. Ruuskanen, *Effect of liquid inhibitors on PCDD/F formation, prediction of particle-phase PCDD/F concentrations using PLS modelling with gas-phase chlorophenol concentrations as independent variables*. *Chemosphere*, 1999. **38**(10): p. 2205-2217.
90. Yli-Kenturi, N., P.H. Ruokojärvi, A. Asikainen, J. Ruuskanen, I. Halonen, and K. Hänninen, *Urea as PCDD/F inhibitor in incineration of RDF*. *Organohalogen Compounds*, 1999. **41**: p. 311-314.
91. Ruokojärvi, P., M. Aatamila, K. Tuppurainen, and J. Ruuskanen, *Effect of urea on fly ash PCDD/F concentrations in different particle sizes*. *Chemosphere*, 2001. **43**(4-7): p. 757-762.
92. Ruokojärvi, P.H., I.O.A. Halonen, K.A. Tuppurainen, J. Tarhanen, and R. J., *Effect of gaseous inhibitors on PCDD/F formation*. *Environ. Sci. & Technol.*, 1998. **32**: p. 3099-3103.
93. Samaras, P., M. Blumenstock, D. Lenoir, K.-W. Schramm, and A. Kettrup, *PCDD/F inhibition by prior addition of urea to the solid fuel in laboratory experiments and results statistical evaluation*. *Chemosphere*, 2001. **42**(5-7): p. 737-743.

94. Buekens, A. and H. Huang, *Coparative evaluation of techniques for controlling the formation and emnission of chlorinated dioxins/furans in municipal waste incineration*. J.Hazard. Mater., 1998. **62**: p. 1-33.
95. Bechtler, R., L. Stieglitz, G. Zwick, R. Will, W. Roth, and K. Hedwig, *Influence of elemental sulfur on the de-novo-synthesis of organochlorine compounds from residual carbon on fly ash*. Chemosphere, 1998. **37**(9-12): p. 2261-2278.
96. Ogawa, H., N. Orita, M. Horaguchi, T. Suzuki, M. Okada, and S. Yasuda, *Dioxin reduction by sulfur component addition*. Chemosphere, 1996. **32**(1): p. 151-157.
97. Samaras, P., M. Blumenstock, D. Lenoir, K.-W. Schramm, and A. Kettrup, *PCDD/F prevention by novel inhibitors: Addition of inorganic S- and N-compounds in the fuel before combustion*. Environmental Science & Technology, 2000. **34**(24): p. 5092-5096.
98. VDI 4220, *Quality assurance - Requirements for emission and immission testing laboratories for the determination of air pollutants*. 1999.
99. DIN-EN-ISO/IEC 17025, *General requirements for the competence of testing and calibration laboratories*. 2000.
100. VDI 2066, *Particulate matter measurement; measuring of particulate matter in flowing gases; gravimetric determination of dust load; fundamentals*. 1975. **sheet 1**.
101. Multi-Variate-Statistical Package (MVSP)., *Kovach Computing Services*. <http://kovcomp.com>, 2000. **Version 3.11**.
102. Morrison, D.F., *Multivariate statistical method*. 1978: p. 266-302.
103. EPA, Method 8290 A., *Polychlorinated Dibenzodioxins (PCDDs) and polychlorinated dibenzofurans (PCDFs) by high resolution gas chromatographie/high resolution mass spectrometry (HRGC/HRMS)*." 1998: p. 1-67.
104. DIN-EN 1948-1, D.E., *Emissions from stationary sources- Determination of mass concentration of PCDD/PCDF*. 1997(1).
105. DIN-EN 13284-1, *Stationary source emissions-Determination of low range mass concentration of dust*. 2002(1).
106. VDI 2066, *Measurement of particulate matter; manual dust measurement in flowing gases; gravimetric determination of dust load; tubular filter devices (4 m³/h, 12 m³/h)*. 1993. **sheet 2**.

107. DIN-EN 1948, *Emissionen aus stationären Quellen - Bestimmung der Massenkonzentration von PCDD/PCDF, German standards*. 1997. **parts 1, 2, 3**.
108. Lehnardt, R., A. Kaune, K.-W. Schramm, A. Kettrup, and . *Sampling exhaust gases of thermal processes with continuous, automatic adjustment to isokinetic conditions*. *Organohalogen Compounds*, 1998. **36**: p. 77-80.
109. Bundesimmissionsschutzverordnung, *Verordnung über Qualitätssicherungskonzept- Analytik von PAK, PCB und Dioxinen im Boden*. 1990.
110. Agency-Austria, U.F.E., *Emission von Dioxinen, PCbs und PAHs aus Kleinf Feuerungsanlagen*. 2002: p. M-153.
111. Quass, U., Fermann, MW., and Bröger, G., *Steps towards a European dioxin inventory*. *Chemosphere*, 2000. **40**(9-11): p. 1125-9.
112. Wikström, E., S. Ryan, A. Touati, M. Telfer, D. Tabor, and B.K. Gullett, *Importance of chlorine speciation on de Novo formation of polychlorinated dihenzo-p-dioxins and polychlorinated dibenzofurans*. *Environmental Science & Technology*, 2003. **37**(6): p. 1108-1113.
113. Skodras, G., P. Grammelis, P. Samaras, P. Vourliotis, E. Kakaras, and G.P. Sakellaropoulos, *Emissions monitoring during coal waste wood co-combustion in an industrial steam boiler*. *Fuel*, 2002. **81**(5): p. 547-554.
114. Hunsinger H., Kreis S., and Vogg H., *Experiences gained from the sampling of chlorine aromatics in the raw gas of waste incineration plants*. *Chemosphere*, 1996. **32**(1): p. 109-118.
115. Samaras, P., M. Blumenstock, K.-W. Schramm, and A. Kettrup, *Emissions of chlorinated aromatics during sludge combustion*. *Water Science and Technology*, 2000. **42**(9): p. 251-258.
116. Wirkstöm E. and M. S., *Combustion of an artificial municipal solid waste in a laboratory fluidised bed reactor*. *Waste Management & Research*, 1998. **16**(4): p. 342-350.
117. United States Environmental Protection Agency., *Office of Research and Development; Health Assessment Document for 2,3,7,8-Tetrachlorodibenzo-p-dioxin (TCDD) and Related Compounds; EPA/600/Bp-92/001c Estimation Exposure to Dioxin-Like Compounds, EPA/600/6-88/005Cb*; 1994.

118. Lippert, T., A. Wokaun, and D. Lenoir, *Copper Catalyzed Aryl Dehalogenation Reactions and Their Inhibition*. Berichte Der Bunsen-Gesellschaft-Physical Chemistry Chemical Physics, 1990. **94**(12): p. 1465-1471.
119. Wikström, E., Persson A., and Marklund S., *Secondary formation of PCDDs, PCDFs, PCBs, PCBz, PCPhs and PAHs during MSW combustion*. Organohalogen Compounds, 1998. **36**: p. 65-68.
120. Choudhry GG. and Hutzinger O., *Mechanistic aspects of the thermal formation of halogenated organic compounds including polychlorinated dibenzo-p-dioxins*. New York: Gordon and Breach, 1983.
121. Salthammer T., Klipp H., Peek RD., and Marutzky R., *Formation of polychlorinated dibenzo-p-dioxins (PCDD) and polychlorinated dibenzo-p-furans(PCDF) during the combustion of impregnated wood*. Chemosphere, 1995. **30**(11): p. 2051-60.
122. Schatowitz B., Brandt G., Gatner F., Schlumpf E., Bühler R., Husler P., and Nussbaumer T., *Dioxin emissions from wood combustion*. Chemosphere, 1994. **29**: p. 2005-2013.
123. Öberg, T. and B. J.G.T., *Indicator parameters for PCDD/PCF-plant specific models*. Organohalogen Compounds, 1992. **8**: p. 197-200.

LEBENS LAUF

Persönliche Angaben

Name: Marchela Pandelova
Geburtsdatum: 07. März 1977
Geburtsort: 7000 Russe, Bulgarien
Staatsangehörigkeit: bulgarisch
Familienstand: verheiratet
Ledig Name: Lebikyan

Ausbildung

1990 - 1995 Naturwissenschaftliches Gymnasium,
„Olimpi Panov“, Bulgarien
Abitur mit Note: Sehr gut

1995- 2000 Studium, Fachrichtung allg. Chemie, Diplom
an der Sofia Universität „St. Kliment Ochridski“, Bulgarien

Diplomarbeit im Bereich elektrothermische
Atomabsorptionsspektroskopie
Abschluss mit Note: Ausgezeichnet

Seit 2001 Studium, Ökologische Chemie, Promotionsstudium
an der Technischen Universität München

Tätigkeiten

2000-2000: Wissenschaftliche Mitarbeiterin
Bulgarische Akademie der Wissenschaften, Institute für Ökologie,

2000-2001: Wissenschaftliche Mitarbeiterin im Chromatographischen
Labor
Umwelt und Wasser Ministerium – Bulgarien, Agentur- Russe

Seit 2001 Doktorand, GSF - Forschungszentrum für Umwelt und
Gesundheit GmbH