

TECHNISCHE UNIVERSITÄT MÜNCHEN

Lehrstuhl für Bauprozessmanagement und Immobilienentwicklung

**Conditions for Applying Public Private Partnership (PPP) in
Iraq Infrastructure Projects Successfully**

Omar Akrm Abd Alwahab Al-juboori

Vollständiger Abdruck der von der Ingenieur fakultät Bau Geo Umwelt der Technischen
Universität München zur Erlangung des akademischen Grades eines
Doktor-Ingenieurs (Dr.-Ing.)

genehmigten Dissertation.

Vorsitzender:

Univ.-Prof. Dr.-Ing. Oliver Fischer

Prüfer der Dissertation:

1. Univ.-Prof. Dr.-Ing. Josef Zimmermann
2. Univ.-Prof. Dr.-Ing. Hans Wilhelm Alfen
Bauhaus-Universität Weimar

Die Dissertation wurde am 11.02.2015 bei der Technischen Universität München eingereicht
und durch die Ingenieur fakultät Bau Geo Umwelt am 10.04.2015 angenommen.

“Gedruckt mit Unterstützung des Deutschen Akademischen Austauschdienstes“

Abstract

Public private partnership (PPP) is a way to procure public projects. PPP is expected to achieve additional value for money through efficiency and higher quality of services. Nevertheless, PPPs are very complex and expensive. In order to construct a PPP, large preparation and bidding costs arise and, as a result, only very specific and complex projects are granted the option to be considered for PPPs.

The acute need for infrastructure and the lack of financial resources have led the government of Iraq towards the privatization of infrastructure. Began with the privatization of telecommunications and oil sectors since 2003, the process of privatizing infrastructure service provision in Iraq is still in its initial phases.

Since 2006, the government of Iraq aimed to implement a number of power projects on the basis of PPP schemes (especially under BOT arrangements). PPP in infrastructure projects are exposed to a wide spectrum of risks. The expected risk usually determines the expected return. This study explores the concepts of PPP, and what advantages and disadvantages this kind of partnership delivers. In addition, the reasons for PPP implementation were reviewed and circumstances surrounding them were explored. Current Iraq infrastructure projects situations and needs were studied, as well as, some aspects relating to the Iraq's construction market, Iraqi legal, financial and contract systems were discussed.

A financial model was carried out and applied to a real-life case study project to obtain the distribution of net present value NPV of the project from the view point of equity. The output indicated that the equity investor's return increases significantly after the paying of all other obligations.

Due to lack of a comprehensive database on PPPs in Iraq, a survey targeted investors and professionals from researchers, public and private-sector organizations revealed that the government stability, administrative efficiency and poor public decision-making process are considered as the most important criteria. The survey indicated, however, that Iraq's performance is regarded as poor. Practitioners in public sector may not have the necessary talents to conduct PPP projects due to the minimal PPP project experience in Iraq. Therefore, gaining experience or importing expertise has been a solution.

The survey results also demonstrated attractive and negative factors for adopting PPP in Iraq. As expected, government supports are considered as mostly required, while those supports associated with risks best managed by the private sector are less generally demanded.

Moreover, a new method for risk allocation was applied, on risk allocation preferences, this research shows that (40%) of risk factors are preferred to be allocated to the private sector, as well as (40%) risk factors are to be allocated to the public sector and (20%) of the risk factors are to be equally shared between the private and public sectors. Based on the research findings, a recommendation policy demonstrates "What" needs to be done by GoI in order to implement a successful PPP project in Iraq, taking the specific context of Iraq.

Lastly, despite these problems that facing PPP in Iraq, the respondents remain optimistic about the future of PPP in infrastructure projects.

Acknowledgements

At first, I thank God for enabling me to achieve this research.

This research is conducted at the Chair of Construction Management and Real Estate Development, Faculty of Civil Geo and Environmental Engineering, Technical University of Munich.

I would like to thank many institutions and individuals who supported and assisted me to complete the research. With a deep sense of gratitude, I wish to express my sincere thanks to my academic supervisor, Prof. Dr. Josef Zimmermann, for his encouragement, stimulating suggestions, and immense help in planning and executing the works in time. His valuable instructions and suggestions during the course of work are greatly acknowledged.

I wish to express my thanks to the examiners Prof. Dr. Hans Wilhelm Alfen, Bauhaus-Universität Weimar for serving on the thesis committee and Oliver Fischer for moderating the thesis defence.

My sincere thanks are due to Dr. Wolfgang Eber for providing me constant encouragement and extending timely help, and for the numerous joint discussions and new ideas on risk allocation.

I would also like to thank all the friends and current and former colleagues at LBI, for all the good memories and the support during these years. You were all part of an unforgettable experience and I am grateful to have met and known each and every one of you. The instructions and kind considerations I received from other faculty members of my department are gratefully acknowledged.

I would like to thank the German Academic Exchange Service (DAAD), and the Ministry of higher education and scientific research of Iraq that provided me all the support to study and research in Germany by providing full financial assistance, including opportunities to learn its language, culture, science and people.

Additional thanks go to all respondents and interviewees whose participation in the survey of perceptions rendered to me a highly appreciated assistance.

I would also like to thank TUM graduate school; particular Dr. Annette Spengler; for their support throughout the process.

I especially thank my wife and kids, who always supported me in both nice and hard times, and all members of my family particularly my brother Mohamed who had always encouraged and supported me to continue this work. Lastly, no words can sufficiently translate the extent to which I thank my mother for all that she did for me.

Finally, I would like to thank all whose direct and indirect support helped me completing my thesis in time.

Munich, February 2015

Omar Akrm Al-juboori

Table of Contents

Table of Contents	II
List of Figures	XI
List of Tables	XIV
List of Equations	XVI
1 Introduction	1
1.1 Background	1
1.2 Research Objectives	2
1.3 Research Methodology	3
1.4 The Organization of Writing.....	5
2 Basics of Public Private Partnership (PPP).....	6
2.1 Definition of PPP	6
2.1.1 PPP Organization	8
2.1.2 The Concept of Privatization	10
2.1.3 The Concept of Concessions	11
2.1.4 Attractive and Negative Factors of PPP projects	12
2.1.4.1 Attractive Factors of PPP Projects	12
2.1.4.2 Negative Factors of PPP Projects	13
2.1.5 Forms of PPPs	15
2.1.6 Project Shareholders	17
2.1.7 Phases of a PPP Project	18
2.1.8 PPP Differences with Traditional Procurement	21
2.1.9 PPP in Infrastructure Projects	24
2.1.10 Private Infrastructure in Developing Countries.....	26
2.2 PPP Project Finance Structure Overview	30
2.2.1 Phases of Financing.....	32
2.2.2 Source of Capital	32
2.2.2.1 Equity Capital	33
2.2.2.2 Senior Debt.....	33
2.2.2.3 Subordinated Debt.....	34
2.2.2.4 Supplier Credit.....	34
2.2.2.5 Bond Issues.....	34
2.2.2.6 Export Credit Agency Facility (ECA)	35
2.2.2.7 Multilateral or Bilateral Agency Facility.....	36
2.2.3 Value for Money in PPP Projects	37
2.2.4 Financial Appraisal Technique of PPP Projects.....	38
2.2.4.1 Financial Appraisal from Public Authority's Perspective	39
2.2.4.2 Financial Appraisal from Equity Investors' Perspective	39
2.2.4.3 Financial Appraisal from Lenders' Perspective	40
2.2.5 Public Sector Finance (Government Support)	42
2.2.6 PPP Financing Models in Germany	46
2.2.6.1 PPP Light.....	54
2.2.6.2 Forfeiting Model.....	54
2.3 Risk in PPP Projects.....	58
2.3.1 Risks in Private Infrastructure	59
2.3.2 Risk Management in PPP	61
2.3.2.1 Risk Identification	64
2.3.2.2 Risk Assessment.....	70
2.3.2.3 Risk Allocation	73
2.3.2.4 Risk Mitigation	76
3 Iraq Infrastructure	81
3.1 Status of Iraq Infrastructure.....	81

3.1.1	Status of Railways & Logistics	84
3.1.2	Status of Road Sector	90
3.1.3	Status of Water Supply Sector	93
3.1.4	Status of Wastewater Sector	97
3.1.5	Statuses of Electricity Sector	103
3.1.5.1	Iraq Power Sector: Past and Present	105
3.1.5.2	Expectations of Electricity Demand.....	109
3.1.6	Iraq Labour Force and Capacity Building.....	112
3.1.7	Change from Public to Private Finance in Iraq.....	115
3.1.8	Power Purchase Agreement	118
3.1.9	Tendering Systems and PPAs in Iraq	120
3.1.9.1	Bidding Evaluation.....	122
3.1.9.2	Governmental Approvals of Investment Projects	123
3.1.10	Contract System in Iraq.....	126
3.1.11	Iraq's Regulatory System	128
3.1.11.1	PPP Legal Framework Development in Iraq	128
3.1.11.2	Investment Law No. 13 of 2006.....	130
3.1.11.3	The Private Investment Law in the Refining of Crude Oil No. 64 for 2007	132
3.1.11.4	The Public-Private Partnership Law	132
3.1.11.5	Other Laws Affecting doing Business in Iraq	133
3.1.12	Structure of the Financial System of Iraq	134
3.1.12.1	Banking System of Iraq	136
3.1.12.2	Iraqi Insurance Market.....	138
3.2	The BOT Financial Model: Al-Quds-Gas Power Plant Project.....	140
3.2.1	Model Selection	140
3.2.2	Key Definitions.....	141
3.2.3	Assumptions for the Financial Model	144
3.2.4	Derivation of the Financial Model	145
3.2.5	Cash flows from Different Perspectives of PPP Projects	151
3.2.6	Financial Performance Measures.....	151
3.2.7	Numerical Example	154
3.2.8	Basic Assumptions of Iraq.....	155
3.2.9	Basic Financial Concepts	157
3.2.10	Model Results and Scenario Analysis	159
3.2.10.1	Case A.....	159
3.2.10.2	Case B.....	160
3.2.10.3	Case C.....	160
3.2.10.4	Case D.....	160
3.2.10.5	Case E.....	160
3.2.10.6	Case F.....	161
3.2.11	Summary Results	170
4	Methodology for Data Collection	172
4.1	Introduction.....	172
4.2	Questionnaire Survey.....	172
4.2.1	Questionnaire Objectives and Structure	173
4.2.2	Questionnaire Types	177
4.2.3	Questionnaire Test	177
4.2.4	Sample Selection	178
4.2.5	Questionnaire Distribution Methods	179
4.3	Interviews	180
4.4	Frequency Analysis	181
4.5	Statistical Tool for Data Reliability.....	181
4.5.1	General Descriptive Statistics	182
4.5.2	Normality Test	182
4.5.3	Kendall's Coefficient of Concordance (W)	183
4.5.4	Kruskal Wallis H Test	184
4.5.5	Mann-Whitney U Test.....	185
4.5.6	Effect Size Index.....	186

4.5.7	Center of Mass Theory	188
4.6	Summary	188
5	Data Analysis and Results	189
5.1	Questionnaire Survey Analysis	189
5.1.1	General Characterization of Respondents	191
5.1.2	General Experience with PPP (Survey-Section 2)	195
5.1.2.1	PPP experience (Question 1)	195
5.1.2.2	PPP Project Undertaken by the Organization/ Company (Question 2)	196
5.1.2.3	Type of PPP Project Undertaken (Question 3)	197
5.1.2.4	Type of PPP Contract Undertaken (Question 4)	197
5.1.2.5	PPP Implementation Guidance (Question 5)	198
5.1.2.6	Viability of PPP for Public Projects (Question 6)	198
5.1.2.7	Projects Best Suited to Use PPP in Iraq (Question 7)	199
5.1.3	Criteria and performance of PPP in Iraq (Survey-Section 3)	200
5.1.3.1	Attractive Factors for Adopting PPP (Question 8)	200
5.1.3.2	Negative Factors for Adopting PPP (Question 9)	203
5.1.3.3	Knowledge Management and Capacity-Building (Question 10)	206
5.1.3.4	Comparing PPP with Traditional Procurement Methods (Question 11)	212
5.1.3.5	Availability of PPP Legal Framework (Question 12)	214
5.1.3.6	Government Support (Question 13)	220
5.1.4	Major risk Factors of PPP Projects in Iraq (Section 4-Q.13)	222
5.1.4.1	Overall Respondents' Perceptions Concerning the Importance of risk factors	223
5.1.4.2	Perceptions of Survey Groups Respondents Concerning the Importance of Risk Factors	228
5.1.4.3	Test for Internal Agreement of Risk Ranking	231
5.1.4.4	Agreement of the Survey Respondents on Risk Factors	232
5.1.5	Risk Allocation Preferences by Survey Respondents	239
5.1.5.1	Risk Allocation by Overall Respondents	245
5.1.5.2	Risks Allocated to the Public Sector (M1)	245
5.1.5.3	Risks Shared between the Public and Private Sectors (M2)	246
5.1.5.4	Risks Allocated to the Private Sector (M3)	246
5.1.5.5	Center of Overall Risk Factors	246
5.1.6	Prospects of the Future of PPP in Infrastructure Projects in Iraq (Question 15)	248
5.2	Policy Recommendations for Gol	250
5.2.1	Government Role and Responsibilities	251
5.2.1.1	Government Stability	251
5.2.1.2	Establishing a Coordinating and Supportive Authority (PPP Unite)	251
5.2.1.3	Develop a Clear PPP Policy, Prioritize and Assessment for PPP Projects	251
5.2.1.4	Maintain Experience and Knowledge of the Government Staff	252
5.2.1.5	Maintain Competition	252
5.2.1.6	Government Support and Guaranties	252
5.2.1.7	Improve Responsiveness to the Needs of Investors	253
5.2.2	Regulatory Framework Role	253
5.2.2.1	Maintain the Stability and Enforcement of Laws through Long-Term Contract	253
5.2.2.2	Availability of PPP Legislation Define PPP Forms and Requirements	253
5.2.3	Economic Conditions Role	254
5.2.3.1	Market Demand	254
5.2.3.2	Financing Technique and Strategies	254
5.2.3.3	Economic Environment	254
5.2.3.4	Ensure Adequate Cash Flow in the Project	254
5.2.4	PPP Risks Analysis Role	255
6	Conclusions	256
6.1	Summary of Research Findings	256
6.2	Limitations of Research	258
6.3	Suggested Areas of Future Research	259
	Bibliography	260
	Appendices	276

Appendix A.....	277
Appendix B.....	281
Appendix C.....	290
Appendix D.....	292

List of Figures

Figure 1-1: Flow diagram of research process	4
Figure 2-1: PPP structure	9
Figure 2-2: Horizontal and vertical Partnerships (Previous reference)	10
Figure 2-3: PPP and Privatisation	11
Figure 2-4: PPP project phases.....	19
Figure 2-5: Traditional and PPP procurement stages	21
Figure 2-6: Traditional difference in public payments between Traditional and PPP Procurements	23
Figure 2-7: Total private investment infrastructure projects of developing countries (1990-2012) in Millions of USD	27
Figure 2-8: Number of infrastructure projects with private participation in developing countries by type of project, 1990–2012	27
Figure 2-9: Private investment in infrastructure projects of developing countries by Sector (1990-2012)	29
Figure 2-10: Number of private investment in infrastructure projects of developing countries (1990-2012)	29
Figure 2-11: Investment in infrastructure projects with private participation in developing countries in different sectors, 1990–2012	29
Figure 2-12: The typical flow of services, payments for services and funding	31
Figure 2-13: The relationship between SPV and the ECA	36
Figure 2-14: Value for Money (VFM) Demonstration	37
Figure 2-15: Monitoring debt ratio level over time	42
Figure 2-16: Publicly assisted PPP financing model	43
Figure 2-17: The government financial exposure and the ease of raising finance for the different government support.....	45
Figure 2-18: High risks PPP financing model.....	46
Figure 2-19: Number PPP project and investment in Germany (2002-2013)	47
Figure 2-20: PPP in public construction works in Germany 2013	47
Figure 2-21: Organization and ownership structure of ÖPP Deutschland AG	51
Figure 2-22: Market structure of PPP in Germany	52
Figure 2-23: Obstacles towards PPP in Germany.....	52
Figure 2-24: Financing in Forfeiting model.....	56
Figure 2-25: Composition of financing costs	56
Figure 2-26: Advantages and disadvantages of Project Finance and the Forfeiting Model from the public principal's point of view.....	57
Figure 2-27: Definition of Risk	59
Figure 2-28: Typical risk and cash flow profile of the PPP project	60
Figure 2-29: Risk Management in business processes.....	62
Figure 2-30: Development of Risk in Steps of Risk Management.....	62
Figure 2-31: The effect of Risk Management	63
Figure 2-32: One possibility of risk classification.....	65
Figure 2-33: Schematic example of risk impact related to the business processes	66
Figure 2-34: Examples of qualitative risk matrix.....	72
Figure 2-35: Risk in PPP projects.....	74
Figure 2-36: Optimal risk allocation point	75
Figure 2-37: Degree of risk transfer by PPP types.....	75
Figure 2-38: Amount and duration of security bond in a concession	79
Figure 3-1: Percentage of deprived families by different fields – Iraq (%)	82
Figure 3-2: Government agencies responsible for the implementation of infrastructure projects	82
Figure 3-3: Revenue versus expenditure of Iraq government (2007-2014)	83
Figure 3-4: Iraq main railways roads	85
Figure 3-5: Iraq main roads and highways	91

Figure 3-6: Electricity system in Iraq	104
Figure 3-7: Electricity Distribution Pre- and Post-war.....	106
Figure 3-8: Supplied energy by sector in Iraq	106
Figure 3-9: Average electricity Supply on Grid VS. Demand, 2000–2012 in Megawatts.....	107
Figure 3-10: Access to public and private electricity in different provinces.....	108
Figure 3-11: Forecasted electricity demand.....	110
Figure 3-12: Provision of training to workers.....	113
Figure 3-13: PPP projects in Iraq	116
Figure 3-14: One-Stop-Shop work mechanism.....	124
Figure 3-15: Procedure of obtaining an investment license.....	125
Figure 3-16: Contract procurement categories.....	127
Figure 3-17: Excerpt of the Iraq investment law No. 13 of 2006.....	131
Figure 3-18: Structure of the Iraq economy 2008.....	135
Figure 3-19: Financial sector structure in Iraq.....	137
Figure 3-20: Structure of the Iraqi banking system (share in credits to the economy).....	138
Figure 3-21: Cash flows for a typical BOT project.....	141
Figure 3-22: Structure of the financial model	145
Figure 3-23: Concession structure	157
Figure 3-24: Equity cash flow - Case A.....	161
Figure 3-25: Project cash flow - Case A.....	161
Figure 3-26: Project cumulative cash flow - Case A.....	162
Figure 3-27: Project net present value (NPV) - Case A.....	162
Figure 3-28: Project debt servicing coverage ratio (DSCR).....	162
3-29: Relation between equity, IRR and NPV	163
Figure 3-30: Project financing structure	163
Figure 4-1: Questionnaire sections relation with chapters	174
Figure 4-2: Questionnaire structure.....	176
Figure 5-1: Distribution of respondents by sector.....	191
Figure 5-2: Distribution of respondents by age	191
Figure 5-3: Distribution of respondents by academic degree.....	192
Figure 5-4: Distribution of respondents by experience in construction industry.....	193
Figure 5-5: Distribution of respondents by job title	194
Figure 5-6: Distribution of public sector respondents by Ministries	194
Figure 5-7: : Distribution of private sector respondents by project types	195
Figure 5-8: Distribution of respondents by PPP experience	196
Figure 5-9: Availability of PPP project undertaken by the organization	196
Figure 5-10: Main PPP project types undertaken by the organization.....	197
Figure 5-11: Contract type of PPP project undertaken by the organization.....	197
Figure 5-12: Availability of guidance on PPP implementation.....	198
Figure 5-13: Viability of PPP for acceleration of public infrastructure projects	199
Figure 5-14: Best suited projects for PPP projects in Iraq	200
Figure 5-15: Attractive factors for PPP projects among survey groups	202
Figure 5-16: Negative factors for PPP projects among survey groups	205
Figure 5-17: Availability of knowledge and capacity-building for PPP project among survey groups.....	207
Figure 5-18: Availability of knowledge and capacity-building for PPP project	208
Figure 5-19: Knowledge for planning and participation in PPP project.....	209
Figure 5-20: Knowledge for tendering and negotiation in PPP project	210
Figure 5-21: Commitment with the other parties in PPP project.....	211
Figure 5-22: Comparing PPP with traditional procurement among survey groups.....	213
Figure 5-23: Suitability of current legal frame work.....	215
Figure 5-24: Existing legal framework for a PPP project.....	216

Figure 5-25: Judicial independence from government influence.....	217
Figure 5-26: Regulatory commitment sustained through long-term PPP contract.....	218
Figure 5-27: Existence of regulation defining PPP contracts, forms and requirements.....	219
Figure 5-28: Valuation of Gol supports in PPP projects among survey groups.....	220
Figure 5-29: The need for government supports in PPP projects.....	221
Figure 5-30: Level of government supports in PPP projects.....	222
Figure 5-31: Land allocation in Iraq.....	228
Figure 5-32: Calculating risk allocation according to center of mass theory.....	240
Figure 5-33: Preferred risk allocation of PPP projects in Iraq by survey groups.....	241
Figure 5-34: Closeness parameter calculation.....	242
Figure 5-35: Risk allocation percentage by overall groups.....	245
Figure 5-36: The center of all risk factors by survey groups.....	247
Figure 5-37: Proposed policy recommendation for Gol.....	250

List of Tables

Table 2-1: Summary of key features of the basic forms of Public-Private Partnership (PPP)	16
Table 2-2: Role of different stakeholders in the PPP process.....	18
Table 2-3: Traditional and PPPs procurement	24
Table 2-4: Investment in infrastructure for developing countries - number of projects (1990-2012)	26
Table 2-5: Infrastructure projects investment with private participation in developing countries by Class 1990-2012 (in Million USD)	28
Table 2-6: Number of infrastructure projects with private participation in developing countries by Class (1990-2012)	28
Table 2-7: Bond rating	35
Table 2-8: Description of PPP-models in Germany.....	50
Table 2-9: Design risks in PPP projects	67
Table 2-10: Construction and development risks in PPP projects	68
Table 2-11: Operating risks in PPP projects	68
Table 2-12: Financing risk in PPP projects	69
Table 2-13: Project life cycle risks in PPP projects	69
Table 3-1: Iraq's expected overall revenues 2010 – 2014	83
Table 3-2: Principal railway lines 2012.....	85
Table 3-3: Total activity of the Iraqi railroad system 1979-2012	86
Table 3-4: Lack of financial allocations of railways (Million USD)	87
Table 3-5: Number of workers by specializing and education level of State Company for railways 2013	87
Table 3-6: Proposed development plan for the Iraq railway network 2012-2017.....	88
Table 3-7: New Provincial interconnection railways plan routes in Iraq's	89
Table 3-8: Future investment of international links in Iraq's railways	89
Table 3-9: Iraq roads, length, and condition.....	90
Table 3-10: Number of workers by specializing of State Commission for roads and bridges 2013.....	92
Table 3-11: Road maintenance cost and annual financial allocation for the period 2009-2013 in Million USD	92
Table 3-12: Roads length and number of bridges required for 2012-2017	93
Table 3-13: Design and actual capacity of the existing water production facilities for 2004-2008.....	94
Table 3-14: Annual allocations and expense of water supply projects	95
Table 3-15: Number of management and technical employers of Iraq water sector 2012	95
Table 3-16: Supply and demand data of water for 15 Iraqi provinces except Kurdistan region 2010	96
Table 3-17: Number of new water projects in 2013-2017 plan	98
Table 3-18: An annual financial allocation of wastewater projects during the period 2004-2013 in Million USD	100
Table 3-19: Number of employers in the sewage sector.....	101
Table 3-20: Sewage projects present in the Governorates except provinces of Kurdistan	101
Table 3-21: Proposed plan for the new sewage projects for years (2010-2015)	103
Table 3-22: Gap between the design and the actual system capacity.....	109
Table 3-23: Long term generation investment - Millions USD.....	110
Table 3-24: Annual financial allocations of electricity sector for the period 2010-2013 in Billion USD	111
Table 3-25: Comparisons of the Iraqi electricity sector with some Arab countries 2013	112
Table 3-26: Iraq population working age	112
Table 3-27: Foreign Direct Investment in Iraq in Million USD for years 2007 – 2013.....	116
Table 3-28: MoE evaluation criteria for the technical proposals of PPP proposals	122
Table 3-29: Resent Iraq economic indicators.....	135
Table 3-30: Main data for AQPP	155
Table 3-31: Cost requirement of AQPP.....	155
Table 3-32: Costs and investment ratios on different items of AQPP	156
Table 3-33: Cash flow concept in Million USD -viewpoint of equity Case A	164
Table 3-34: Cash flow concept in Million USD-viewpoint of equity Case B	165
Table 3-35: Cash flow concept in Million USD-viewpoint of equity Case C	166
Table 3-36: Cash flow concept in Million USD-viewpoint of equity Case D	167
Table 3-37: Cash flow concept in Million USD-viewpoint of equity Case E	168
Table 3-38: Cash flow concept in Million USD-viewpoint of equity Case F.....	169
Table 3-39: Summary table of parameters and results	170
Table 4-1: Rang of reliability and its coefficient for Cronbach's alpha	178
Table 4-2: Survey coefficient for Cronbach's alpha.....	178
Table 5-1: Comparison among the distributed, returned, valid and invalid questionnaires by sector.....	190

Table 5-2: Adequacy of valid response rate for analysis and reporting	190
Table 5-3: Attractive factor for PPP projects	201
Table 5-4: Kruskal Wallis test results of attractive factor for PPP projects	203
Table 5-5: Negative factors of PPP projects	204
Table 5-6: Kruskal Wallis test results for negative factors of PPP projects.....	206
Table 5-7: Methods of comparing PPP with traditional procurement	212
Table 5-8: Kruskal Wallis test results for methods of comparing PPP with traditional procurement.....	214
Table 5-9: Perception of survey respondents concerning the relative importance of risk factors in PPP Projects	225
Table 5-10: Top five risk factors in different groups	229
Table 5-11: Risk ranking of PPP projects and Kendall's test	231
Table 5-12: Kruskal Wallis test for risk factors among survey groups	233
Table 5-13: Mann- Whitney U-test for risk factors between group A and group B.....	235
Table 5-14: Mann- Whitney U-test for risk factors between group A and group C	236
Table 5-15: Mann- Whitney U-test for risk factors between group B and group C	237
Table 5-16: Summery of Mann- Whitney U-test for risk factors among survey groups	238
Table 5-17: Preferred risk allocation of the overall groups.....	244
Table 5-18: Center of overall risk by survey groups.....	248
Table 5-19: Survey general conclusions	248
Table 5-20: Kruskal Wallis test for survey general conclusions	249

List of Equations

Equation 2-1: Annual debt-service cover ratio	40
Equation 2-2: Loan life coverage ratio.....	41
Equation 2-3: Project life coverage ratio	41
Equation 3-1: Total project cost from sponsors' perspective	146
Equation 3-2: Base cost at beginning of the construction period	146
Equation 3-3: Inflation cost.....	146
Equation 3-4: Debt interest.....	147
Equation 3-5: Gross revenue.....	147
Equation 3-6: Annual operation and maintenance cost as a percentage	147
Equation 3-7: Annual operation and maintenance cost from main components.....	148
Equation 3-8: Accumulated debt	148
Equation 3-9: Annual equal debt instalments method.....	149
Equation 3-10: the debt principal in annual equal debt instalments.....	149
Equation 3-11: annual interests contained in annual equal debt instalments	149
Equation 3-12: Annual equal principal debt instalments method	149
Equation 3-13: Annual interest in the equal principal debt instalments method	150
Equation 3-14: Depreciation	150
Equation 3-15: Tax calculation	150
Equation 3-16: Profit before interests and tax.....	150
Equation 3-17: Sponsors' annual cash flow during construction.....	151
Equation 3-18: Sponsors' annual cash flow during operation period	151
Equation 3-19: Government annual cash flow during government period	151
Equation 3-20: NPV of sponsor's cash flow	152
Equation 3-21: weighted average cost of capital (WACC) discount rate	152
Equation 3-22: Internal rate of return	152
Equation 3-23: Debt-service coverage ratio	153
Equation 3-24: Loan life coverage ratio.....	153
Equation 3-25: Project life coverage ratio	153
Equation 3-26: net present value of government cash flow	154
Equation 4-1: Cronbach's alpha	178
Equation 4-2: Mean of sample.....	181
Equation 4-3: Median	181
Equation 4-4: Variance and standard deviation of sample.....	181
Equation 4-5: Kolmogorov-Smirnov (K-S) test	183
Equation 4-6: Kendall's coefficient of concordance (W).....	184
Equation 4-7: Kruskal Wallis H Test for independent samples	185
Equation 4-8: Mann-Whitney U Test for independent samples.....	186
Equation 4-9: Effect size for independent samples (Cohen)	186
Equation 4-10: Effect size for independent samples (Cohen) using mean square standard deviation ...	187
Equation 4-11: Effect size for independent samples (Cohen) using pooled standard deviation.....	187
Equation 4-12: Effect size for independent samples (Cohen) for more than two groups.....	188
Equation 4-13: Center of mass.....	188

Keywords

A

ACF	Available Cash Flow
ADB	Asian Development Bank

B

BLO	Build, Lease, and Own
BLT	Build, Lease, and Transfer
BOO	Build, Own, and Operate
BOT	Build, Operate, and Transfer
BROT	Build Rehabilitate Operate Transfer
BTO	Build, Transfer, and Operate
BMVBS	Bundesministerium für Verkehr, Bau und Stadtentwicklung-Federal Ministry of Transport, Building and Urban Affairs
BOO	Build, Operate, Own
BOT	Build, Operate, Transfer

C

CAPM	Capital Asset Pricing Model
COI	Central Bank of Iraq
CFMA	Construction Financial Management Association

D

DBFOT	Design, Build, Finance, Operate and Transfer
Difu	Deutsches Institut für Urbanistik
DSCR	Debt Service Coverage Ratio
DER	Debt Equity Ratio

E

EBST	Erhvervs- og byggestyrelsen - Danish Enterprise and Construction Authority
EBIT	Earning Before Interest and Taxes
ECA	Export Credit Agency
Eq.	Equation

F

Fig.	Figure
------	--------

G

GDP	Gross Domestic Product
Gol	Government of Iraq

I

ID	Iraqi Dinar
IMF	International Money Fund

IPP	Independent Power Producers
IRR	Internal Rate of Return
K	
KWh	Kilowatt per Hour
L	
Lppd	Liters per person per day
M	
MoE	Ministry of Electricity
MoF	Ministry of Financing
MoMPW	Ministry of Municipalities and Public Works
MoP	Ministry of Planning
MoT	Ministry of Transport
MoCH	Ministry of Construction and Housing
N	
NPV	Net Present Value
NIC	National Investment Commission
O	
O/M	Operation and Management
OBB	Oberste Baubehörde im bayerischen Staatsministerium des Innern – Supreme building authority in the Interior Ministry of Bavaria
P	
PBP	Payback Period
PFI	Project Finance Initiative
PSC	Private Sector Comparator
PPA	Power Purchase Agreement
PPI	Private Sector Participation in Infrastructure
PPP	Public-Private Partnership
R	
RLT	Rehabilitate Lease or Rent Transfer
ROE	Return on equity
ROO	Rehabilitate, Own, and Operate
ROT	Rehabilitate, Operate, and Transfer
S	
SCRB	State Commission for Roads and Bridges
STPs	Sewage treatment plants
T	
TIC	Total Investment Cost for a Project

U

UNCITRAL	United Nations Commission on International Trade Law
UNDP	United Nations Development Program
UNIDO	United Nations Industrial Development Organization
USD	United States Dollar
USAID	United States Agency for International Development

V

VAT	Value Added Tax
-----	-----------------

W

WACC	Weighted Average Cost of Capital
------	----------------------------------

1 Introduction

1.1 Background

In Iraq, the Public-Private Partnerships (PPP) concept is comparatively new to the Government of Iraq (GoI), where the creation of infrastructure services and products has traditionally been the responsibility of the government of Iraq, but this has changed with the private sector becoming more involved through public private partnerships.

Development of PPP in Iraq created many questions concerning construction development as to the complementation and innovation of the infrastructure in the country, the utility of modern construction patterns, and the acceleration of construction development and innovation of the managerial and organizational systems and means in a way that would adapt the intended construction development. It is obvious that realizing these aims depends largely on construction industry as no construction development can occur in absence of comprehensive construction industry with developed managerial and technical patterns. Since the construction industry is a leading indicator of Iraq economic growth, it is important that the efficiency of construction practices be improved as part of any economic growth program.

For the Government of Iraq, despite significant security and economic growth in many areas of infrastructure, much still remains to be undertaken. In a view of situation of construction industry in Iraq, it is still lagging behind the capacity that could meet the requirements of the intended development. It is important for the GoI to increase its ability to deliver basic services given that the Iraqi population is on a considerable growth trajectory, there are increased expectations of a higher standard of living, and there is a need to accommodate economic growth. Responding to these needs will demand considerable strengthening of infrastructure.

Facing increasing demand on infrastructure facilities and inadequate financial status, government of Iraq exploring new infrastructure procurement routes through PPP. Other aims of using PPP arrangements were driven by risk sharing, expertise availability and fiscal constraints, increased revenues and reduced deficits/debts, quicker market development faster foreign investment and increased competition.

Globally, recent years have seen a marked increase in cooperation between the public and private sectors for the development and operation of infrastructure for a wide range of economic activities. PPP are more widely used in Anglo Saxon countries, the developing countries have been very keen to explore the feasibility of PPP to develop the country's infrastructure. Government in developing country sees PPP as having the potential to promote greater growth to the economy since the country requires many infrastructure as a base for development. PPP has been used mainly in roads projects in developing countries like India and Malaysia because the country needs good road infrastructure to during their early developing years.

The application of PPP in broad sense is not restricted to roads only. Other infrastructure projects like schools, airports, hydroelectric dams, power plants, railways, prisons and broadband cables that require massive capital expenditure are also possible candidates for the application of PPP. Although PPP brings about many benefits in a win-win situation, not all PPP projects are successful since there could be problems like bankruptcy of the private sector, lop sided contractual agreements, corruption, delays and external factors like global economy crisis that threatens the viability of projects under PPP. One could say that PPP is only feasible within one set of conditions subjected to sensitivity analysis.

PPP is highly dependent on how accurate are the cash flow forecast since PPP project could be a very long term concession agreement of 30 years, the implementation of the PPP process and the due diligence level of the government. When the interest of both party are align and achieves the same goal the PPP project is viable but under many circumstances PPP could achieve a non-optimal result since non-monetary factors are not taken into account.

In Iraq, PPP in infrastructure service provision is still in its initial phases. There are few PPP projects. However, the number is increasing. Currently, The GoI is elaborating plans to rebuild the country's infrastructure, including major power projects, with a total budget of \$ 150 billion by 2025. In addition to budgetary funds, and take important steps towards enhancing the private sector through several legislative reforms.

However, to attract the private sector to commit its resources to commercial activities in infrastructure is of peculiar problem because has specific characteristics that differ from other sectors. Infrastructure investment requires up front large capital with immobile assets that needs long period to recoup. During this period, investors are exposed to serious risks whose profiles are varying according to the life cycle phase. In addition because it is in the public interest, infrastructure service tends to be politically sensitive, particularly in relation to tariff charged to consumer.¹

Owing to the high cost of the infrastructure projects in the recent years, the PPP schemes are getting popular in the global construction market. By implementing them, governments are able to put projects on track without concerning itself too much about rising funds. For successful implementation of PPP schemes, a number of criteria that can be classified into country and project levels must be fulfilled.²

1.2 Research Objectives

The acute need for infrastructure and the lack of public financial resources have brought about the private participation in infrastructure projects in Iraq. This dissertation examines specific problems related to the Public-Private Partnership in infrastructure projects generally. Actually, there is a lack of research and studies in this area with Iraq being the focus. This research is intended to find solutions and recommendations toward successful implementation of public-private power projects in Iraq. Objectives of this dissertation research have been the following:

Study of financial and contractual aspects of PPP in infrastructure projects, the research develops a theoretical framework on the concept of the project finance in private infrastructure with the relevant financial and contractual issues. In the context of financial theories, risk is often simply translated into statistical measures of spread such as variance or standard deviation.

Study of attractive and negative factors of PPP contracts, the research present and discuss advantages and disadvantages of various methods and criteria in the PPP project sponsor procurement, this will enable the public sector to choose the most appropriate system.

Study the structure of PPP contracts in the infrastructure projects. In many respects, private investment in the infrastructure industry differs from that in other industries. In general, PPP given its popularity has been used in many different infrastructure projects like: power

¹ Liddle, B.: Privatization decision ad civil engineering projects. Journal of Construction Engineering and Management, ASCE, vol. 13(3), 1997, P. 73-78.

² UNIDO: Guidelines for Infrastructure Development through Build-Operate-Transfer. United Nations Industrial Development Organization, Vienna, 1996.

generation and distribution, water and sanitation, refuse disposal, hospitals, medical and research centre, school buildings and libraries, stadiums and sport complexes, airports, prisons, railways, roads and highways, broadband and telecommunication and housing.

Study of the financial planning of PPP in infrastructure projects, there are so many details included that appropriate financial planning procedures and financial assessment methods should be developed in order to evaluate the viability of a project and to come up with the best scenario. To achieve this goal, the research develops a model for financial planning and evaluation of a BOT project. The model enables also the government to evaluate bidder's proposals. The model is then applied to a real life Iraqi gas electric power project with little modifications.

Evaluate of risk management of PPP in infrastructure projects, the research presents a theoretical framework on risk management in private infrastructure service provision. The risk management includes: risk identification, risk assessment, risk allocation, risk mitigation. The research addresses the following questions: what are the character and the extent of risk of PPP projects for both private and public sectors? Is it possible to reduce the sum of the investor's and government's risk through appropriate PPP arrangement? What could be appropriate arrangement? Should these risks be shared? And if so, in what proportion and by whom? What are the trends in risk allocation? And what is the current view of risk in the industry?

Analysis PPP risk factors, the problem of PPPs is that there is a high degree of possibility for approval of projects that do not generate better value for money but are accepted for the financial resources only – getting a project procured while having debt off government's balance sheet.³ The research identifies and quantifies major risks that can be associated with Iraqi PPP projects under the chosen set of parameters.

Finally, what needs to implement a successful PPP project in Iraq, the research uses the questionnaire survey findings collected by this study to determine recommendations framework and what needs to implementing PPP in Iraq.

1.3 Research Methodology

Extensive literature review in the area of PPP corporate and project finance theories, privatization in infrastructure, domestic, and international practice from various resources (e.g., textbooks, Internet web sites, business magazines, research papers) was undertaken. Data and materials were collected, compiled, and extracted personally and from homepages of various organizations such as (WB) World Bank, (MoE) Ministry of Electricity of Iraq, (MoF) Ministry of finance, International Finance Corporation (IFC), (MoP) Ministry of planning, (NIC) National Investment Commission of Iraq, Al-Quds power station Agency, (CB) The Central Bank of Iraq, and some other research institutions.

Moreover, Face-to-face informal interviews were undertaken to collect information. These interviews were achieved by holding informal discussions with experts and running brainstorming sessions with supervisors and colleagues.

³ Maski, E., & Tirole, J.: Public-private partnerships and government spending limits. *International Journal of Industrial Organization*, Vol. 26, 2008, P.412-420.

Furthermore, questionnaire survey was conducted, the issues covered in the questionnaire included: 1) Investigate the current conditions in terms of capacity building, experience, project nature, project types under which the use of PPP is the most appropriate. 2) Attractive and negative factors for adopting PPP, instead of traditional procurement. 3) Suitability of current legal system and availability of knowledge. 4) Importance of risk factors and risk allocation preferences. 5) Prospects of the future of PPP in infrastructure projects in Iraq.

Figure 1-1 shows a flow diagram of the research process that was adopted for this study.

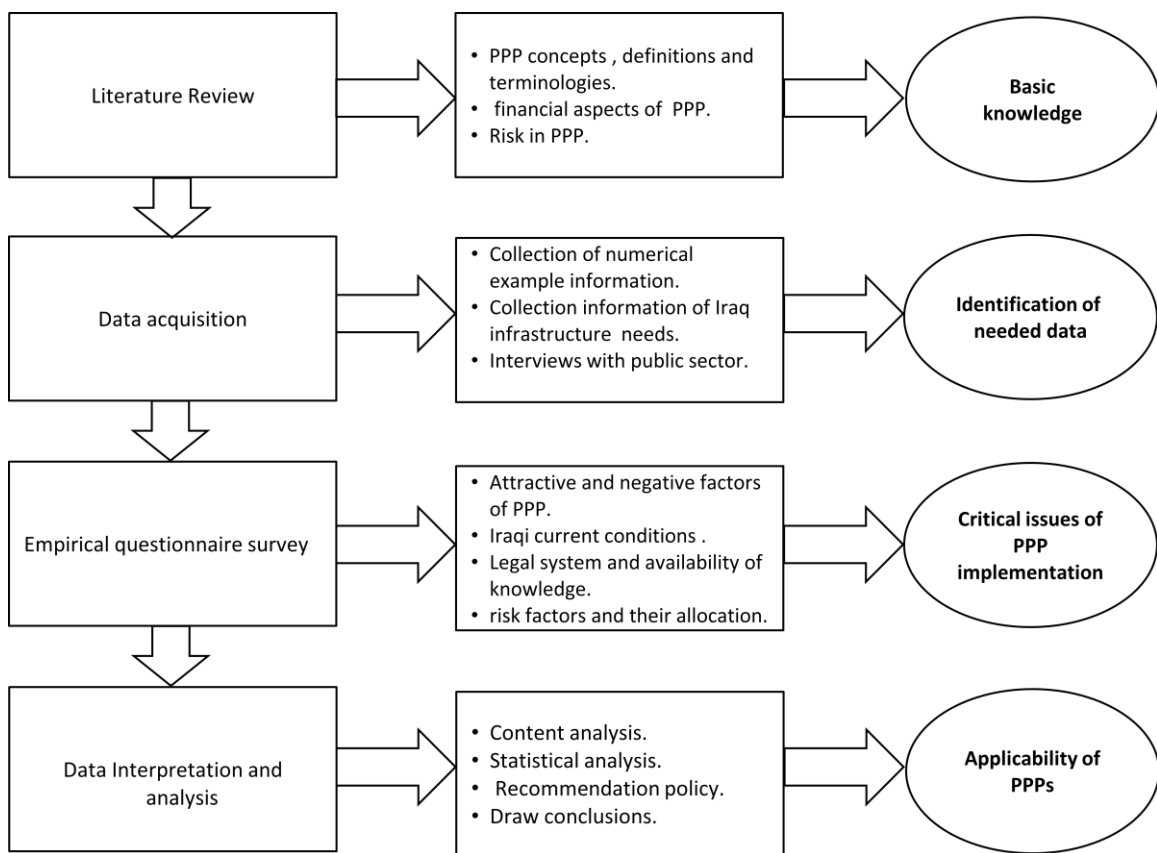

Figure 1-1: Flow diagram of research process

1.4 The Organization of Writing

The research is composed of 6 chapters:

- **Chapter 1** discusses the background, research objectives and methodology, and the organization of the research writing.
- **Chapter 2** provides an insight into the existing literature of the research topic, the literature studies concepts of PPP, and explore the most common definitions and terminologies in this field, the traditional practice of procuring public works projects and also looks into the option of using PPP. Specific features of PPP have also been covered including the attractive factors, the negative factors of PPPs. Moreover, studies the financial aspects of the private infrastructure, describes the tools of project financial evaluation. Furthermore, this chapter gives overviews on the risk management techniques (risk identification, risk assessment, risk allocation, risk mitigation and risk calculation).
- **Chapter 3** deals with the Iraq infrastructure project's needs, and discusses some aspects relating to the Iraq's construction market, and explore the Iraqi legal, financial and contract systems. Moreover, this chapter presents and discusses numerical example of assumed BOT project financial model under current Iraqi contracting laws.
- **Chapter 4** expresses the methodology of the survey data collection. This chapter explains the questionnaire survey design and process. The theoretical of empirical research is performed. Prior to the survey carried out, plans regarding the conduct of the survey as well as the theoretical evaluation of the test data are also described.
- **Chapter 5** presents a questionnaire survey, in this chapter; researcher; from the findings of a questionnaire survey; summarized attractive and negative factors for adopting PPP, the suitability of of procuring PPP under current conditions, possible PPP project risks and their allocation, and future perspectives. Furthermore, this chapter presents a recommendation policy for the government of Iraq for implementing PPP. The framework is presented according to the results obtained in this study. As a result the Iraqi public sector can better conduct future PPP projects by referring to this framework.
- **Chapter 6** concludes this research study. A presentation of the major findings, the limitations have been highlighted and finally potential future research areas have been suggested.

2 Basics of Public Private Partnership (PPP)

The concept of Public-Private Partnership (PPP) has existed for centuries in Europe, United States while being a more recent development in other parts of the world. Public Private Partnership as a concept has its origin in UK and its early development has primarily been driven by the need for new investing and financing possibilities together to provide and deliver public sector assets and services.

This chapter will review the literature, and gives a general understanding of PPPs. Before making any comments about PPPs, one should have a good understanding of different aspects of PPPs in order to be able to analyze the performance of PPPs. Reviewing what other scholars have found about PPP delivery method will help us to better understand the PPP process, characteristics and performance measurement.

2.1 Definition of PPP

The role played by a private entity in the development of an infrastructure asset may vary greatly. Thus Public-Private Partnerships (PPP) can be defined in a number of ways based on the context they have been applied to.

PPPs in facilities development involve private companies in the design, financing, construction, ownership and operation of a public sector utility for long term contract (20-30) year. Such partnerships between public and private sector are now an accepted alternative to the traditional state provision of public facilities and service⁴. PPPs are known worldwide with various other alternative names such as Private Participations in Infrastructure (PPI), Private-Sector Participation (PSP), P3, Privately Financed Projects (PFP), and Private Finance Initiatives (PFI).

PPPs can be defined as:⁵

“Contractual agreements between a private party (which can comprise one or more private partners) and all or part of a government. Under such a contract the private party agrees to perform certain functions or activities that are partially or traditionally considered to be of public responsibility”.

In Germany PPP is described by the Federal Ministry of Transport, Building and Urban Affairs (BMVBS) as:⁶

“Long-termed, contractually regulated co-operation between the public authority and the private industry in the fulfillment of public tasks”.

According to Michael Glos, Germany’s Federal Minister of Economics and Technology:⁷

“Technical progress linked together with cost reductions are always driven at a faster pace within a free enterprise environment than by the administrative initiatives of the government”.

⁴ Akintola A., Matthias B., Cliff H.: Public-Private Partnerships, School of the Built and Natural Environment. Glasgow Caledonian University, 2003.

⁵ Pantelias, A.: A Methodological Framework for Probabilistic Evaluation of Financial Viability of Transportation Infrastructure under PPPs. PhD. thesis, University of Texas, Austin, 2009.

⁶ Zimmermann, Josef: Project Delivery Systems. Lecture Notes, Lehrstuhl für Bauprozessmanagement der TU München, 2013.

⁷ Pauly, L.: Das neue Miteinander (the new cooperation), Public Private Partnership in Germany. Hoffmann and Campe, Hamburg, 2006, P. 50.

According to the PPP Task Force Germany ⁸, Public Private Partnerships are modern and efficient forms of administration. They form part of the Federal Government's innovation drive and aim at improving the efficiency of infrastructure projects by means of long-term cooperation between public authorities and the world of private business.

For the purpose of this thesis, the definition used by World Bank (2007)⁹ shall be adopted. The World Bank defines a PPP broadly as:

"an agreement between a government and a private firm under which the private firm delivers an asset, a service, or both, in return for payments contingent to some extent on the long-term quality or other characteristics of outputs delivered".

One of the major objectives of PPP is to transfer tasks and responsibility for the provision of infrastructure to the private sector, in order to gain efficiency, cost reliability and financial security. The traditional procurement of public infrastructure and its related services has given way to the private sector assuming responsibility for design, construction, operation, management, maintenance and finance, with the public sector as the customer or, sometimes, as the direct user, paying for the provision of a service. And for a period that should be sufficient to enable the private sector to recover construction and maintenance costs and achieve the required rate of return on its investment, through either user fees like tolls, water tariffs, ticketing or down payments like availability payments made by the principal.

In such cooperation, the role of government is essentially limited to the perception of the user function, and monitoring the performance of private and contract management. Management functions are not direct, so that the public performance of work is now in private hands. The private partners in turn open up the PPP contracts and new business segments that offer them a hand, a long-term stabilization of cash flows. However private sector acquisition or management of existing public infrastructure without any major new capital investment or upgrading is not considered to be a PPP. Similarly private-sector provision of infrastructure which involves no significant investment in fixed assets (and hence no need for private sector financing), falls into the category of "outsourcing" rather than PPPs.¹⁰

A PPP project involves a number of important contractual arrangements among the participants. It is a complex network of relationships involving multiple parties and their formal relationships are defined by contracts. The underlying logic for establishing partnerships is that both the public and the private sector have unique characteristics that provide them with advantages in specific aspects of service or project delivery. The most successful partnership arrangements draw on the strengths of both the public and private sector to establish complementary relationships.¹¹

A purely public approach may cause problems such as slow and ineffective decision-making, inefficient organizational and institutional frameworks, and lack of competition and efficiency, which are collectively known as government failure. On the other hand, a purely private

⁸ <http://www.ppp-bund.de/en/home.htm>.

⁹ Robinson, H., Carillo, P., Anumba, C. and Patel, M.: Governance & Knowledge Management for PPP, Department of Civil Engineering, Loughborough University, A John Wiley & Sons, Ltd, 2010.

¹⁰ Yescombe, E. R.: Public-Private Partnerships Principles of Policy and Finance. Yescombe Consulting Ltd., London, 2007.

¹¹ Kwan, Jenny: Public Private Partnership a Guide for Local Government. British Columbia, Ministry of Municipal, 1999.

approach may cause problems such as inequalities in the distribution of infrastructure services, an example of what is known as market failure.¹²

In order for these PPPs to work, they must include the following factors:¹³

- A common interest among all concerned parties. In other words, each of the parties to the public-private transaction must have mutual objective to provide services that benefit both parties.
- Well-defined roles and responsibilities. Each participant in the partnership must understand its responsibilities and its role well as time and risks involved.
- Economic feasibility. The successful partnership must be a “win-win” proposition with both the citizens and the private party benefiting.
- Planned development and implementation. The partnership must have a clearly defined plan.

To be successful, any form of PPP must foster the self-interest of the participants. It is not a hand out or grant program, but rather a partnership for the benefit of the public and private organizations.

2.1.1 PPP Organization

PPP projects differ from traditional projects not only conceptually but also procedurally. Preparations, process of offering, organization, contract, financing and follow-up are different. The preparations are extensive for all parts. The specification of public demands to the outcome and the locating and dividing of risks are time-consuming processes. It is advisable to specify needs in an early stage in traditional projects, but it seems to be in focus in PPP projects. The economic consumption by the private companies in the offering process can also be extensive, which besides from contributing to higher transaction costs also can make smaller companies refrain from entering.

Traditionally the public authority enters into contracts with all subcontractors involved, but in a PPP project the public enters only into one contract containing all the elements of PPP with a private owned PPP Project Company, established for the current project.

The PPP Project Company is a public limited company compounded by a source of funds (usually a bank), investors, an insurance company and suppliers such as service contractors, facility managers and entrepreneurs. The PPP Project Company engages only in activities concerning the PPP project.

The PPP Project Company enters into contract with all parts involved (shareholders).¹⁴ ¹⁵ For the rest of this thesis the PPP Project Company will be the “Private part” and the contracting

¹² Kwak, Y., Chih, Y. and William, C.: Towards a Comprehensive Understanding of PPPs for Infrastructure Development. California Management Review. Vol. 51, No. 2, 2009.

¹³ Gunzon: Financial Analysis for Public-Private Partnership. Government Finance Research Centre, Washington, D.C, 1998.

¹⁴ On the basis of COWI: Rammekontrakt om tjenesteydelser til brug for OPP-forundersøgelser. Copenhagen, 2007.

¹⁵ Khan, M. Fouzul Kabir and Parra, Robert J.: Financing Large Projects- Using Project Finance Techniques and Practices. 2003.

authority will be the “Public part”. The structure of the PPP organization is project specific. The basic structure is illustrated in Figure 2-1.

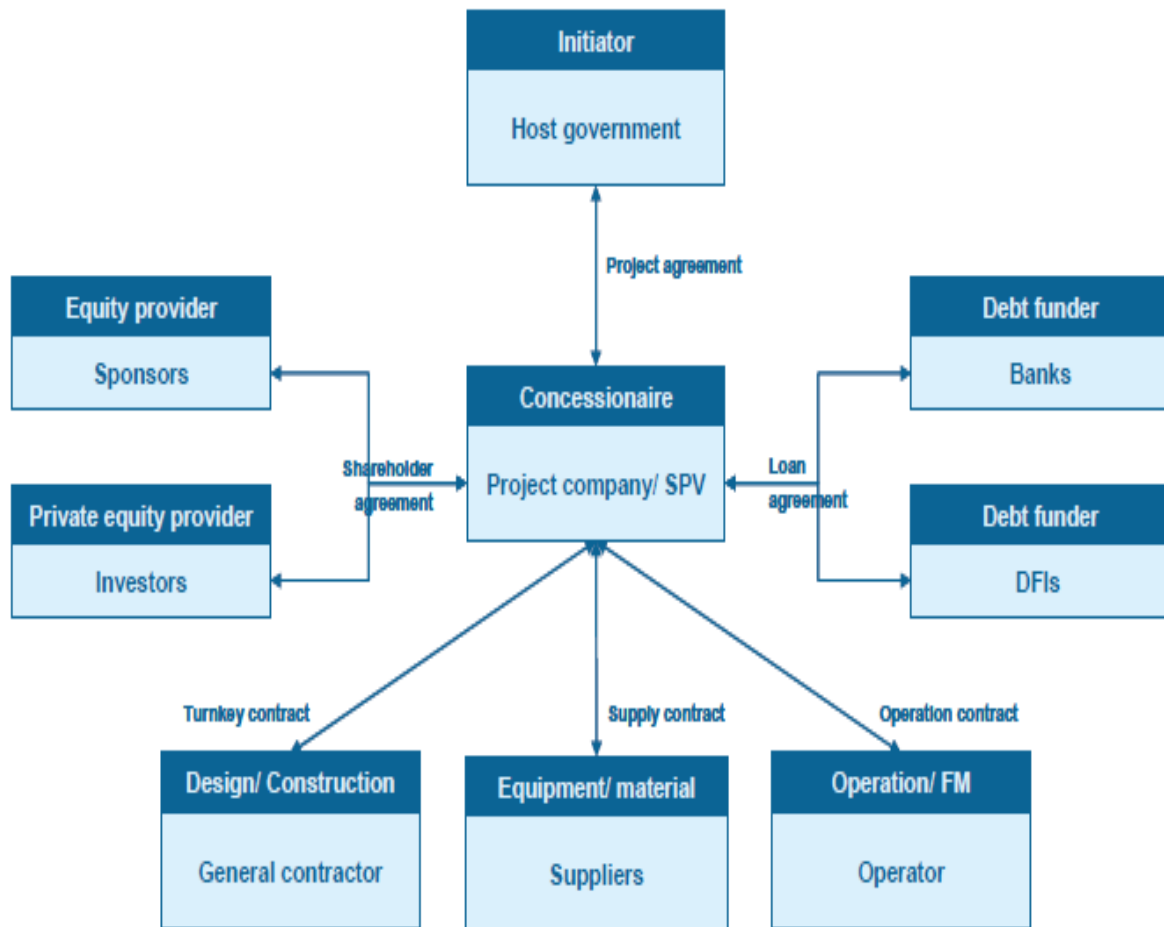

Figure 2-1: PPP structure¹⁶

The public private relationship in PPPs can either be vertical or horizontal in nature. In a vertical partnership the public sector contracts with the private partner through a concession agreement or a PPP-contract, and the latter is responsible for providing required services. In a horizontal partnership both partners are directly engaged as shareholders in a special purpose vehicle (SPV), which is the company responsible to providing required infrastructure services. Figure 2-2 illustrates the structures of these two partnerships.¹⁷

¹⁶ Alfen, Hans-Wilhelm, *et al*: Public-Private Partnership in Infrastructure Development- Case Studies from Asia and Europe. Bauhaus-Universität Weimar, Faculty of Civil Engineering, Chair Construction Economics, 2009.

¹⁷ Previous reference.

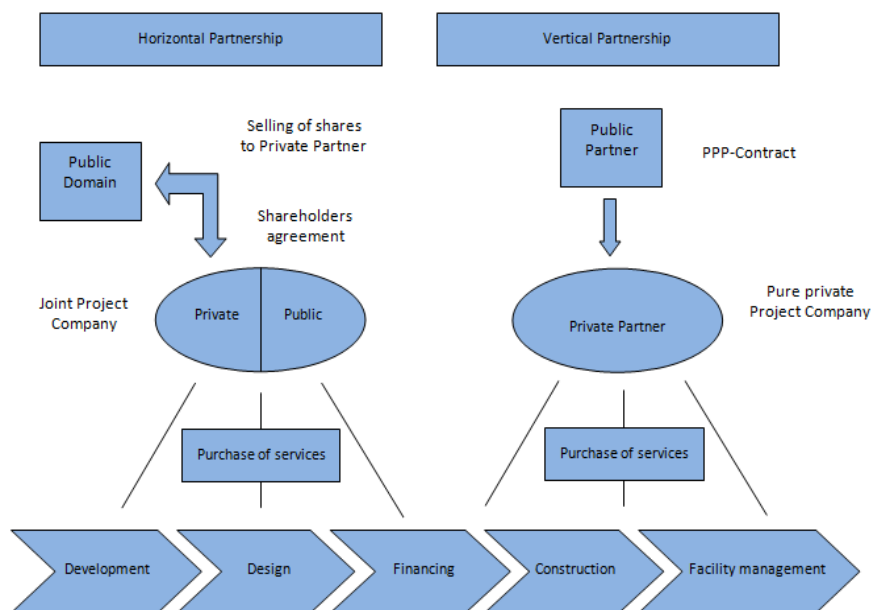

Figure 2-2: Horizontal and vertical Partnerships (Previous reference)

2.1.2 The Concept of Privatization

PPP is considered to be placed in between two ends of the extreme of privatization and fully public delivery project with different level of risk and obligation for both private sector and governments respectively. Hence the level of participation between the public and private sector governs how this public private partnership is being classified for example traditional public procurement, concessionaire, private finance initiative, joint venture, leasing or other terms (See Figure 2-3).¹⁸

The privatisation of public services is a British initiative began at 1980s, and it has also spread into many other countries. The main drivers for privatisation were providing services where this is more efficient, and introduction of competition leads to a better service and lower cost for the citizen, as well as less waste of economic resources. However there are important differences between privatisation and PPPs, some of which make it difficult for a PPP to achieve the same results as a privatisation:¹⁹

- The Public Authority remains politically accountable for a PPP-provided service, but not for a privatised service.
- The citizen will usually not be especially conscious that a PPP based service is being provided by a private-sector company rather than the public sector, whereas this is obvious for privatised services.
- In a PPP ownership of physical assets normally remains with the public sector, whereas in a privatisation they become permanently private-sector owned.

¹⁸ OECD: Public-Private Partnerships In Pursuit of Risk Sharing and Value for Money, 2008, P.20.

¹⁹ Yescombe, E. R.: Public-Private Partnerships Principles of Policy and finance. Yescombe Consulting Ltd, London, UK, 2007.

- A PPP usually involves the provision of a monopoly service, whereas a privatisation usually means that the private firm is subject to disciplines from both product and capital markets in the form of competition from other firms and competition when raising finance.
- In a PPP the scope and cost of services is fixed by a specific contract between the private and public sectors, whereas in a privatisation they are controlled, if at all, by some form of licensing or regulation which allows for regular cost changes, or are simply left to the forces of market competition.

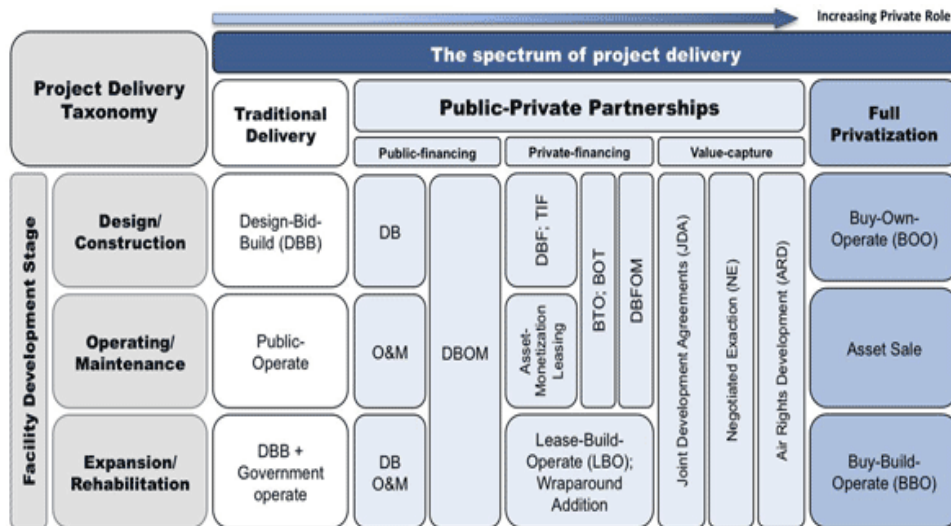

Figure 2-3: PPP and Privatisation²⁰

2.1.3 The Concept of Concessions

In the large sense of the definition given by the interpretative communication of the EU Commission, under a concession “the public authority entrusts to a third party ... the total or partial management of services for which that authority would normally be responsible and for which the third party assumes the risk.” The ownership of assets remains usually within the public sector, while the private party is entitled to cover its expenditures through imposition of user fees.

A long-term Brownfield concession of an existing infrastructure asset involves an upfront payment made by the private sector or investment in the construction of a new facility in return for the cash-flows generated by the asset over the term of the lease. The consortium may have the right (as per the clauses in the agreement) to increase the concession as per a predetermined schedule, up to a certain period after which it normally is tied with increase in gross development product (GDP) or inflation. The long term concession agreement usually transfers operating risk and unless it is availability type of contract, also the revenue risk to the private sector. Capital expenditures like expansion, modernization of the infrastructure and maintenance of the infrastructure usually fall in the books of private sector. The private

²⁰ Zhao, Zhirong (Jerry), Saunoi-Sandgren, Emily and Barnea, Avital: Advancing Public Interest in Public-Private Partnership of State Highway Development. Humphrey Institute of Public Affairs, University of Minnesota, February 2011.

sector is considered capable of contributing innovative ideas thereby achieving operating efficiency.²¹

Depending on the object of the concession, two types of concessions are defined public works concession and services concession.

- The public works concession represents the right of the concessionaire to build a facility and operate and manage the constructed facility for a defined period.
- The service concession represents the right of the concessionaire to manage and operate a public facility. It may also involve partial extension, partial reconstruction, partial rehabilitation, or renovation of the object of the concession.

2.1.4 Attractive and Negative Factors of PPP projects

2.1.4.1 Attractive Factors of PPP Projects

From public sector perspective, governments are under constant pressure to improve the performance of public services with limited resources where legal and administrative limitations rendered public organizations less responsive than private entities. Another broad objective of the government is to promote economic growth and development, or, more generally, to enhance social welfare. The theory of social choice predicts that the government should adopt programs that increase social welfare, meaning “finding those programs that put the society on the highest social indifference curve”.²² Overall, governments take into account the potential positive externalities generated by the project, which range from health benefits (such as those associated with water and sewage provision) to environment protection (in railroads, road transportation, power plants etc.) and economic development (infrastructure is viewed as an important factor in promoting regional and national development). The most cited economic justification for the government to get involved into PPPs is that they are :^{23 24 25}

- The difficulty for the government to enter the bond markets and raise money for certain capital assets.
- Reduce the whole life cost, the total cost of the construction or the acquisition of a major asset by the private sector will be smaller than the government constructs or acquires it.
- PPP may result in more efficient and less costly public services.
- Private sector offers financing for the capital, which the public sector might not be able to finance it alone.
- Private sector can provide services at lower costs and faster implementation.
- Acceleration of infrastructure provision - PPPs often allows the public sector to translate upfront capital expenditure into a flow of ongoing service payments.

²¹ Priyanka A. Shingore: Organizational and Risk Characteristics of Emerging Public-Private Partnership Models. MSc. Thesis, Civil & Environmental Engineering, Virginia university, USA, 2009.

²² Stiglitz, J. E.: Economics of the public sector. New York, W. W. Norton, 1999.

²³ Barnier, Michel: Guidelines for Successful Public Private Partnerships, European Commission, Brussels, 2003.

²⁴ Construction Financial Management Association (CFMA): Financial Management and Accounting for the Construction Industry. Vol. 1, No. 14, 2002.

²⁵ Alfen, Hans-Wilhelm, *et al*: Public-Private Partnership in Infrastructure Development- Case Studies from Asia and Europe. Bauhaus-Universität Weimar, Faculty of Civil Engineering, Chair Construction Economics, 2009.

- Better risk allocation – the main principle of any PPP is the allocation of risk to the party best able to manage it at least cost.
- Provides access to skill sets that are not available in the public sector. By knowledge transfer, the private sector brings its know-how, which not only improves efficiency, but also the public sector working methods and knowledge.

From private sector perspective, the obvious reason of the private sector's involvement in PPPs is profit seeking, a PPP project is also seen by the private partner as a venue to share risk with the public partner, and to benefit from government support (share cost), especially if compared to complete privatization. The private firm can thus have access to a new market in which the opportunity to invest and gain profit would not be possible due to political barriers to entry or public good-market characteristics. The reasons behind the private sector's involvement in PPPs are: (previous two references):

- Increased sales and profits.
- PPP leads businesses to new markets that perhaps have not been open to them before.
- PPP provides opportunities for imagination and innovation by the private sector.
- Claims and cost overruns rarely occur and, if they do, will rarely affect the public participant.
- Major investors are also interested in privatization. For example several large investment bankers are considering or have already established investment pools to fund the Privatization activities.

However, the privatization opportunities are available to wide variety of businesses. These include developers, contractors, and other supplying construction services.

2.1.4.2 Negative Factors of PPP Projects

According to Berg *et al.* (2002)²⁶ negative points of PPP projects are:

- Lengthy bidding process – from initial phase of public sector assessment to signing of contract takes up to two years. The process of inviting, preparing, assessing and refining bids and negotiating contracts is complex and procedural.
- High bidding costs – the detailed and lengthy nature of the bidding process implies increased transaction costs.
- Small number of bidders
- Cost overruns – considerable scope for cost inflation through the bidding process.
- Excessive risks – not clear to what extent the government can shift risk.

One of the main disadvantages of PPPs is large bidding and contractual costs, which refer both to the government and the private partner. Large bidding costs of the PPP projects act as a rejecting force for the private parties as they are unwilling to invest heavily in the bidding process just to be rejected later. What concerns government, large preparation costs consist of

²⁶ Berg, S.V., Pollitt, M.G. and Tsuji, M.: Private Initiatives in Infrastructure. Edward Elgar, Cheltenham, United Kingdom, 2002.

feasibility studies, lawyers, etc. Moreover, PPP projects are highly complicated. Usually, they involve more than two parties: public, private and banking sectors, and all of these parties have their own contradicting aims. In order to construct a unified agreement, a lot of time and capital needs to be invested on complex negotiations.

The PPP bidding process is also regarded as lengthy and complicated. For example, bidders are required to prepare tender proposals attached with a bundle of additional materials. Such a process may take three to four months. Besides, another several lengthy negotiations will be required for the formation of the contract. Clearly, setting up a complicated agreement framework for successful PPP implementation can slow down the bidding process.²⁷

Another common complaint by the public is the high tariff charged for the services provided. More often, the private sector would face political uphill in raising tariff to a level sufficient to cover its costs and earn reasonable profits and returns on investment. The participation of the private sector to provide public service will undoubtedly bring innovations and efficiencies in the operation, but may produce a fear of downsizing in the public sector. To a certain extent, there would be fewer employment opportunities if no regulatory measures were implemented.²⁸

In a PPP agreement, government bounds itself to a single private partner for a long term period and it agrees today for services/assets that will be in use in further future. There is a certain amount of risk concerning the future consumers' need for the specific service. The idea behind the risks concerned is that the partnership may end up delivering services that are no longer required by the public. As a result, the partnership will appear to be less valuable than initially expected.

The impact of risks to project objectives in completing a PPP project is usually significant, and these risks arise from multiple sources including the political, social, technical, economic and environmental factors, due mainly to the complexity and nature of the disciplines, public agencies and stakeholders involved. Both the private and public sectors need to have a better understanding of these risks in order to achieve an equitable risk allocation and enable the project to generate better outcomes.²⁹

Furthermore, PPPs are said to deliver benefits because they transfer a significant amount of risks to the private partner. Nevertheless, it should be kept in mind that even though most of the risks are transferred to the private partner, the final entity that is responsible for providing services to the public is the government. As a matter of fact, if the private partner goes bankrupt, solely the government has to deal with the consequences and try to find other expedients how to keep delivering the service to the public. This implies that even though the risks are contractually transferred to the private partner, in practice, government retains a large portion of them in case of the private partner's failure.

Finally, PPPs work well only for specific projects, which are complex and require specific private partner's know-how, skills, and experience. Therefore, advantages that are attached to PPPs are attained only if certain project characteristics are met, whereas if the project is simple,

²⁷ Grimsey, D. and Lewis, M.K.: *Public Private Partnerships- The Worldwide Revolution in Infrastructure Provision and Project Finance*. Edward Elgar, Cheltenham, The United Kingdom, 2004.

²⁸ Li, B.: *Risk Management of Construction Public Private Partnership Projects*. PhD. Thesis, Glasgow Caledonian University, United Kingdom, 2003.

²⁹ Chan, D.W.M., Chan, A.P.C. and Lam, P.T.I.: *A Feasibility Study of the Implementation of Public Private Partnership (PPP) in Hong Kong*. Proceedings of the CIB W89 International Conference on Building Education and Research, April 10-13, 2006.

executing it through a PPP implies higher preparation costs, and as a result, lower value for money.

2.1.5 Forms of PPPs

PPPs are implemented using different models. There are varying degrees of private sector composition and participation, resource allocation and risk–reward structure. The partnerships range from those dominated by the private sector to the other extreme where the public sector plays a dominant role. A broader classification that represents the variety of contracts across all infrastructure sectors was initiated by the World Bank.³⁰ According to it, the private infrastructure transactions are classified to:

- 1- Management and operation (M&O) contract.
- 2- M&O with major private capital expenditure (Concession).
- 3- Greenfield projects.
- 4- Divestiture (full private ownership)

Organization and Operation Contract (M&O): They are set up specifically for management contract or lease –operate contract for the long-term provision of a given public service by negotiating and contracting it with specialized private company, the private partner takes over the management and the operating part, but the public partner takes over the capital expenditure and the ownership, and for the operating expenditure it takes over by private or public.

Management and Operation (M&O) with major private capital expenditure (Concession): These contracts are cover: BTO (Build Transfer Operate), BLT (Build Lease or rent Transfer), ROT (Rehabilitate Operate Transfer), RLT (Rehabilitate Lease or rent Transfer), and BROT (Build Rehabilitate Operate Transfer). A private entity takes over the management, operate, capital expenditure and operating expenditure of a state – owned enterprise for a given period during which it also assumes significant investment risk.

Greenfield Projects: These contracts are for: BLO (Build Lease Owen), BOT (Build Operate Transfer), BOO (Build Owen Operate). A private entity or a public private joint venture builds and operate a new facility for a given period specified in the project contract. The facility may return to the government at the end of the concession period, and for the ownership, operating, capital expenditure and operating expenditure it takes over by the private or mixed.

Divestiture: It is for, 1) Full Contract, the government transfers 100% of the equity in the state-owned company to the private entities. 2) Partial Contract, the government transfers part of the equity in the state-owned company to the private entities.

A private consortium buys an equity stake in a state-owned enterprise through asset sale, public offering or mass privatization program, and for the ownership, capital expenditure and operating expenditure it takes over by the private or mixed, but the operating can by private or mixed or public.

Furthermore, the Asian Development Bank classifies PPP by the contracts type into six different categories: 1) Service contracts, 2) Management contracts, 3) Affermage (franchise) or lease

³⁰ www.worldbank.org

contracts, 4) Build–operate–transfer (BOT) and similar arrangements, 5) Concessions, and, 6) Joint ventures. The characteristics of the different PPP contracts are summarised in Table 2-1.

Branch	Service contracts	Management contracts	Lease contracts	Concessions	BOT
Scope	Multiple contracts for a variety of support services such as meter reading, billing, etc.	Management of entire operation or a major component	Responsibility for management, operations, and specific renewals	Responsibility for all operations and for financing and execution of specific investments	Investment in and operation of a specific major component, such as a treatment plant
Asset Ownership	Public	Public	Public	Public/Private	Public/Private
Duration	1–3 years	2–5 years	10–15 years	25–30 years	Varies
O&M Responsibility	Public	Private	Private	Private	Private
Capital Investment	Public	Public	Public	Private	Private
Commercial Risk	Minimal	Public	Shared	Private	Private
Overall Level of Risk Assumed by Private Sector	Unit prices	Minimal/moderate	Moderate	High	High
Compensation Terms	Intense and ongoing	Fixed fee, preferably with performance incentives	Portion of tariff revenues	All or part of tariff revenues	Mostly fixed, part variable related to production parameters
Competition	Useful as part of strategy for improving efficiency of public company;	One time only; contracts not usually renewed	Initial contract only; subsequent contracts usually negotiated	Initial contract only; subsequent contracts usually negotiated	One time only; often negotiated without direct Competition
Special Features	Promotes local private sector development	Interim solution during preparation for more intense private participation	Improves operational and commercial efficiency; Develops local staff	Improves operational and commercial efficiency; Mobilizes investment finance; Develops local staff	Mobilizes investment finance; Develops local staff
Problems and Challenges	Requires ability to administer multiple contracts and strong enforcement of contract laws	Management may not have adequate control over key elements, such as budgetary resources, staff policy, etc.	Potential conflicts between public body which is responsible for investments and the private operator	How to compensate investments and ensure good maintenance during last 5–10 years of contract	Does not necessarily improve efficiency of ongoing operations; May require guarantees

Table 2-1: Summary of key features of the basic forms of Public-Private Partnership (PPP)³¹

³¹ Asian Development Bank (ADB): Public-Private Partnership Handbook, 2007, P.28.

2.1.6 Project Shareholders

The financial viability of a project is usually measured by the fulfillment of certain indicators that point to the attainment of the financial targets of the various project stakeholders. In PPP projects the two parties whose interests have to be bridged in order for the project to be successfully completed and operated are the public authority and private partners (lenders and the equity investors). The existence of these different project stakeholders naturally assigns to the financial viability a different meaning based on their different perspectives and targets.

Public entities are more conscious of the need for investment in infrastructure as it has spill over effects with widespread social and economic costs and benefits. However, allocation of budgetary resources in building the infrastructure is constrained by the need for huge investments in social and economic development projects. Governments are motivated to procure infrastructure projects through PPP route in view of their desire to reduce sovereign borrowings, leverage the scarce budgetary resources, bring in efficiency in the erstwhile inefficient public procurement system, and the consideration of benefits due to sharing of the financial risks and rewards between public and private sectors³².

The private partners in the public private partnership have a different perspective from those of the public partners. The private sector bodies that form the other partner of the partnership come from different industries with diverse core competencies.

From the financing perspective, the two key players constituting the private sector can be broadly classified as investors and lending agencies. The major private entrepreneurs providing equity to PPP projects are the EPC contractors, O&M contractors, governments (providing equity in the form of subsidies and grants), and capital markets. Whereas, the organisations providing debt financing are, but not limited to, commercial banks, national and regional development banks, and multilateral and bilateral organisations.

Moreover, the investors are focused on gains that can be expected from the construction and operation of the projects. The lenders look at the higher returns that can be achieved by investing in infrastructure projects in comparison with other investment avenues. There is also a difference in perspectives of the investors and lenders. Investors are more focussed on the opportunities associated with the project while lenders are more concerned with the downside risks of the project. Table 2-2 below shows the role of different stakeholders in the PPP process. On the other hand, public entities and private sector bodies analysed the viability of the project from their perspectives to examine the fulfilment of their objectives. Governments give more focus on the economic appraisal while the private parties do concentrate more on the financial appraisal of the project.

³² Grimsey, D. and Lewis, M.K.: Public Private Partnerships- The Worldwide Revolution in Infrastructure Provision and Project Finance. Edward Elgar, Cheltenham, United Kingdom, 2004, P.27.

Stakeholder	Role
Political decision makers	<p>Establish and prioritize goals and objectives of PPP and communicate these to the public</p> <p>Approve decision criteria for selecting preferred PPP option</p> <p>Approve recommended PPP option</p> <p>Approve regulatory and legal frameworks</p>
Company management	<p>Identify company-specific needs and goals of PPP and staff</p> <p>Provide company-specific data</p> <p>Assist in marketing and due diligence process</p> <p>Implement change</p>
Consumers	<p>Communicate ability and willingness to pay for service</p> <p>Express priorities for quality and level of service</p> <p>Identify existing strengths and weaknesses in service</p>
Investors	<p>Provide feedback on attractiveness of various PPP options</p> <p>Follow rules and procedures of competitive bidding process</p> <p>Perform thorough due diligence resulting in competitive and realistic bidding</p>
Strategic consultants	<p>Provide unbiased evaluation of options for PPP</p> <p>Review existing framework and propose reforms</p> <p>Act as facilitator for cooperation among stakeholders</p>

Table 2-2: Role of different stakeholders in the PPP process³³

2.1.7 Phases of a PPP Project

The progression of a PPP project can be divided into five main phases³⁴. The phases are time-fixed successive periods. The constituent elements can vary and are not necessarily successive, some run parallel.

- 1) **Initiative:** It is determined whether or not the project at hand is suitable as a PPP project. If that is the case the preliminary investigations are started and evaluate the current and the future needs and the alternatives, including the risks associated.
- 2) **Design:** Includes announcing, prequalification and procurement. The public part enters into contract with the private part with the economically most lucrative tender. The financing aspect is audited.
- 3) **Build:** The facility is planned in details and build. Detailed plans for operation and service are worked out. By completion the public and private part evaluates the facility to make sure that quality and arrangement are as agreed.
- 4) **Operate:** The facility is set into operation. Maintenance and services are provided as set up in the contract.
- 5) **Transfer:** The facility is transferred to the public part or stays by the private part. The way of doing so depends on the applied model.

³³ ADB: Public-Private Partnership Handbook. 2007, P.21.

³⁴ On the basis of EBST: OPP – Vejledning til basiskontrakt. Copenhagen, 2005, P. 10.

The public sector involvement should be the most during the initial phase and as the project progresses; the government role will slowly reduce and it serves as a regulatory role and the private sector's role will be increasingly during the infrastructure operational. The sequence of PPP process is shown below in Figure 2-4.

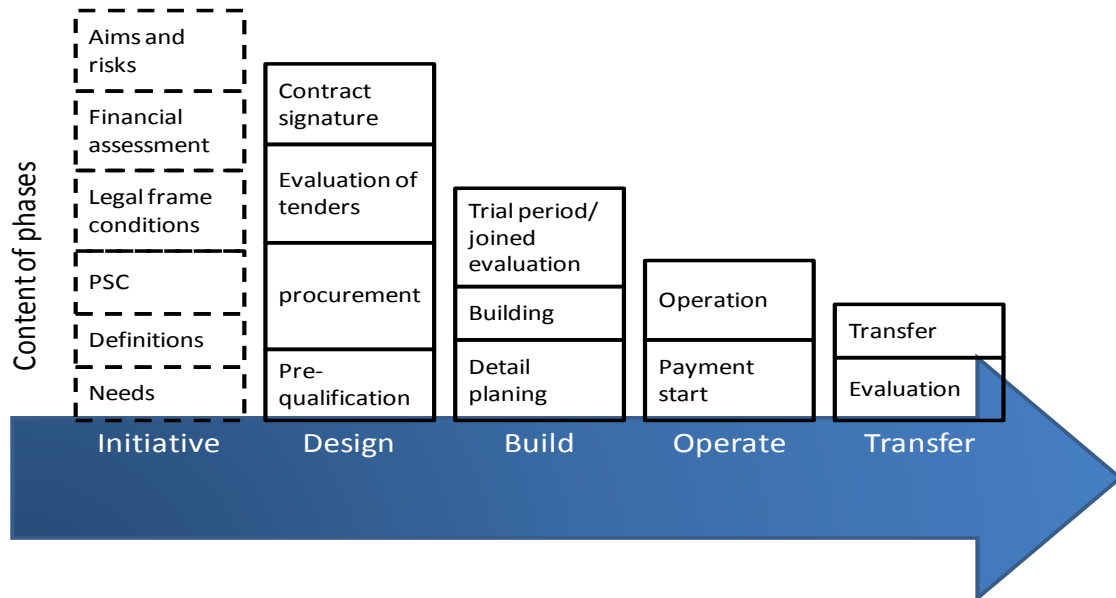

Figure 2-4: PPP project phases³⁵

The first phases, initiative, development and design, such as the planning phases, are important since the following phases are explained and analyzed here. The initiative phase only concerns the public part. The content of the design phase differs depending on the form of procurement. In time aspect the operating phase is of course the most extensive. The building phase is aimed to be as short as possible.³⁶ The phases and the project model are adjusted to each project.

During the initiative phase a number of things are evaluated, the first no matter if the choice goes to a PPP model or a traditional model. This is done by evaluate the current and the future needs, the alternatives, including PPP, and the associated risks. Then the project is defined according to the function and output.

In this step, urban planning includes the national and local land planning is presented, that is created by the responsible local authority, and forms the legal basis for the admissibility of the project. The urban land consists of the land use plan (preparatory land use plan) and the development plan (binding land use plan). This determines the type and degree of building and land use. Volume models are then developed in collaboration with planners that meet the legal planning principles and the requirements of the users' needs program requirements. The volume models allow by setting specific square footage first economic considerations. With the completion of the feasibility statement, the first stage of investment appraisal is completed. Based on the results of the various analyzes on the space program and the volume models, a

³⁵ On the basis of EBST: OPP – Vejledning til basiskontrakt. Copenhagen 2005, P. 11.

³⁶ TUM, Bauindustrie Bayern: PPP-Know-How-Transfer. Kolloquium 2006 Investor-Hochschule-Bauindustrie, Potenzial Partnerschaft, München 2006, P. 30

general schedule is prepared which contains the dates of the major milestones of the project. With these basics, an object concept is developed.³⁷

Having completed the preliminary appraisal, the state authority undertakes a detailed appraisal of the project. As part of the detailed appraisal, the state authority will be expected to identify the most appropriate procurement mechanism by carrying out a PPP procurement assessment. PPP is to be further investigated a reference project is defined according to the function specification. There are a number of other tasks to be completed at this stage. Where the outcome of the PPP procurement assessment and the detailed appraisal indicates that a PPP arrangement is an appropriate procurement option, and it is intended to pursue this approach. A first edition of a public sector comparator PSC; which is a tool used to compare the project cost between public funding and PPP approaches,³⁸ is developed and if it shows that a PPP model can give more value for money the rest of the initiative phase is directed towards PPP. Now, the state authority should approach the approval to proceed with the project as a PPP.

In this step, the preliminary investigations consist of the explaining of the legal and financial aspects, as the frame conditions for procurement are determined. Generally, the government has collective responsibility for formulating overall budgetary policy. Within this overall framework, it is also to be determined if the public budget is fit to a long-termed PPP contract with rates of payment over many years. In the light of this a descriptive project plan is worked out and ends with a realization of decision. At this point the public part hires consultants to match the counseling on the private side.³⁹ The developing of the project is begun.

Having decided to explore the option of using PPP procurement the sponsoring agency should consider the following broad questions, which are dealt with in the following sections:⁴⁰

- Does the sponsoring agency have the power and/or resources to enter into a PPP arrangement, in the meaning of affordability and sustainability?
- Is a public private partnership arrangement a viable option for procuring a particular project, in the meaning of scale of the project and operational requirements, generated user charges, market existence, stability of future demand for the project, Performance and output?
- What is the most appropriate form of public private partnership arrangement to use for a particular project?

The next step is the design phase which contains the awarding procedure. The PPP project can be sent to offering using either limited offering, offering after negotiation, also called the negotiated procedure, or Competitive Dialogue. If the negotiated procedure or the competitive dialog is used, the procurement stretches over a longer period with one or more dialogue phases. Regardless of which of the above mentioned procurement forms is used, a prequalification of the bidders is necessary, with specification of the demands to the bidders technical and economic situation. The prequalification material also contains sub criteria to what the "economically most lucrative tender" is. Depending on the extent and complexity of the procurement process, the offering material is produced with or without a preceding dialogue⁴¹.

³⁷ Vgl. Zimmermann, Josef: Kybernetik der Planungsprozesse. Vorlesungsskriptum zur gleichnamigen Vorlesung am Lehrstuhl für Bauprozessmanagement und Immobilienentwicklung an der Technischen Universität München. Ausgabe 05/2009, S. 2-7.

³⁸ For more details see section 2.2.3.

³⁹ EBST: OPP – Vejledning til basiskontrakt. Copenhagen,2005, P. 12-14.

⁴⁰ The Official Department of Public Expenditure and Reform PPP: Assessment of Projects for Procurement as Public private Partnership. Dublin, 2006, www.ppp.gov.ie .

⁴¹ EBST, OPP – Vejledning til basiskontrakt. Copenhagen,2005, P. 14-16. www.ebst.dk.

During the process, the public part enters into contract with the bidder who has the economically most lucrative tender. It can be difficult to select this tender and to select precise and liable benchmarking tools. This might be because of the complexity of the project where aspects not normally priced are given an economic value and because of the maybe very different contents of the tenders.

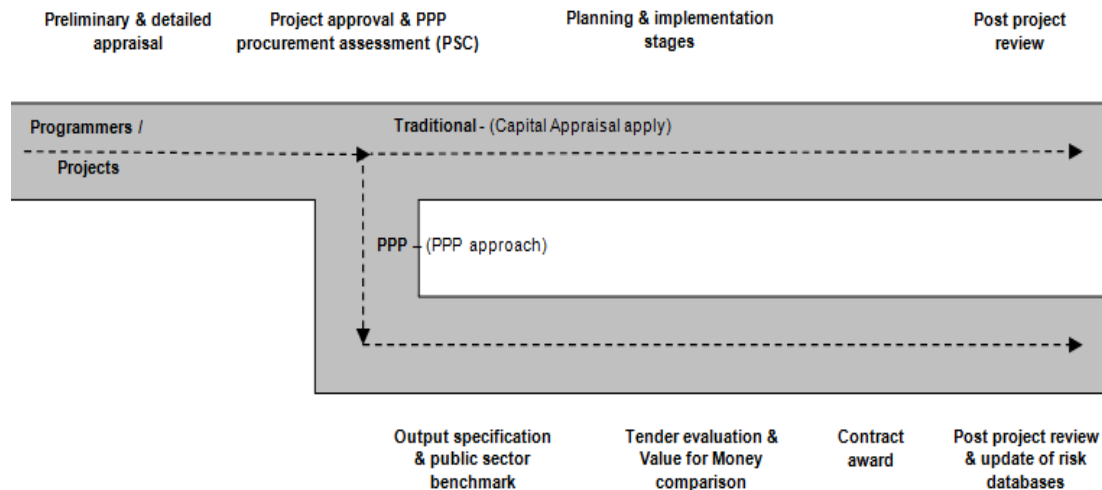

Figure 2-5: Traditional and PPP procurement stages⁴²

In the build phase the detailed plans are made and the building is erected. The parts work out detailed plans for the operation and services. When the building is completed the public and private part evaluates the facility to make sure that quality and arrangement are as agreed. It could be possible with a trial period before the “real” operation phase is begun. There is at least a joined evaluation. After a successful trial period or evaluation the facility is set into operation. The payment starts. During the operation phase the services and maintenance is carried out as stated in the contract with appurtenant reporting. At the end of the contract period the facility is transferred to the public part.⁴³ The way of doing so depends on the model used.

2.1.8 PPP Differences with Traditional Procurement

In the traditional procurement, public sector will request the relevant works department to design their desired facility. Via the PPP procurement, the public sector would define their desired facility in terms of the service required. Next, for both approaches the public sector (sometimes with an external expert) would form a group to monitor the project.

In the traditional procurement, after planning and approvals are obtained, the works department would call for tenders from private contractors to construct or to design and build the facility. On the other hand, in PPP procurement the public sector specifies its requirements in terms of outputs, which set out the public services which the facility is intended to provide, but which do

⁴² www.ppp.gov.ie.

⁴³ EBST, OPP – Vejledning til basiskontrakt. Copenhagen ,2005, P. 16.

not specify how these are to be provided. It is then left to the private sector to design, finance, build and operate the Facility to meet these long-term output specifications.

For both approaches the public sector would then conduct a consultation with the general public and legislative council before obtaining financial endorsement. The successful bidder in a traditional procurement would be the one that satisfies the minimum requirements specified by the public sector with respect to quality of service or product, and also scores the highest mark in the tender evaluation which weighs both the technical and cost aspects. In PPP, on the other hand, the successful consortium bidder would be the one that satisfies the mandatory requirements specified with respect to the ability of the facility to deliver the service required, the quality of design, construction and operation and on terms which provide best value for money.⁴⁴

Once the contract has been awarded the works department would monitor the construction process under a traditional procurement. In PPP procurement, the public sector advisors would deal solely with the consortium only. The consortium would also manage the specialist contractors involved (See Figure 2-6).

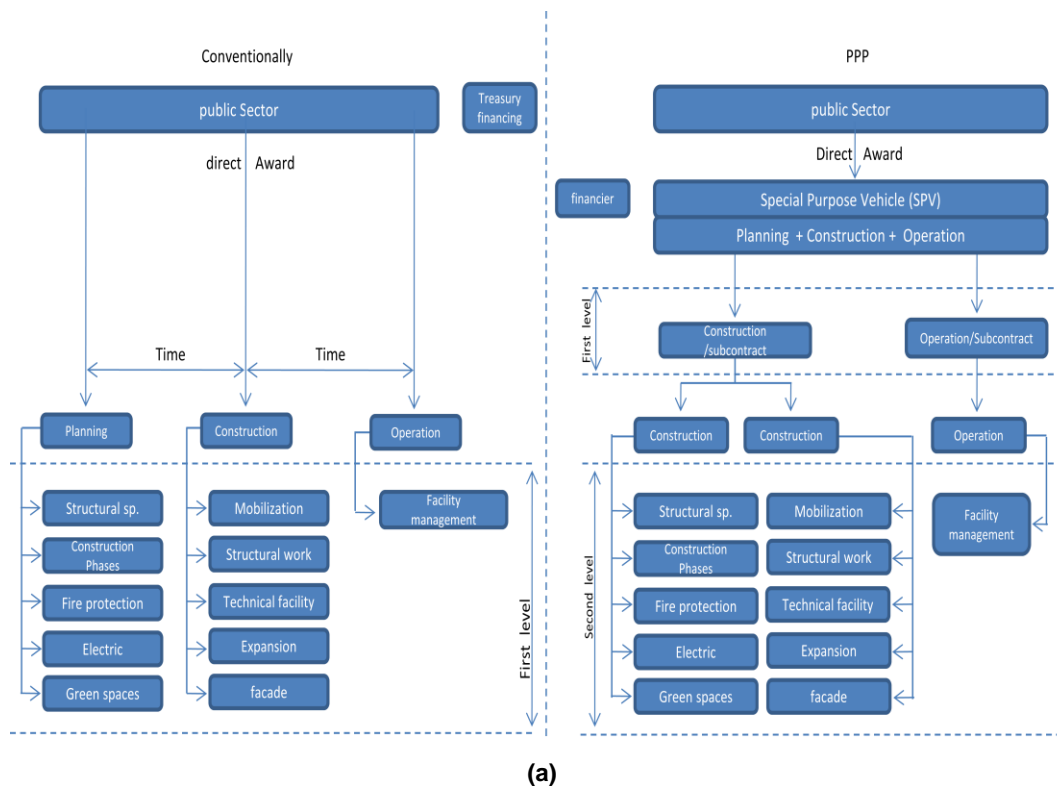

⁴⁴ Information Services Department: Shatin-Central link Construction Set for 2010. Hong Kong Special Administrative Region Government, Hong Kong, 2008b.

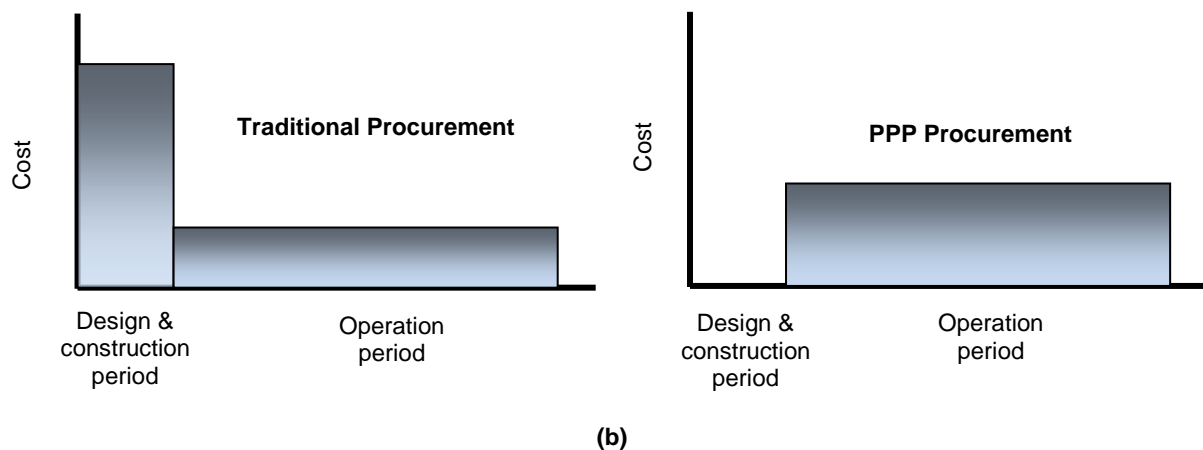

Figure 2-6: Traditional difference in public payments between Traditional and PPP Procurements⁴⁵

After completion of a traditional project the works department would inspect the works, and upon satisfaction payment would be made to the contractor. Under a traditional procurement the public sector enters into several contractual relationships in order to produce a particular asset or service. All these contracts are for the short term and lack long-term commitment from the involved parties. Also, in most cases, performance risks relating to cost and time overrunning are not contracted out to the private sector.

Operational service standards, performance measurement risk, and maintenance of the facility are entirely handled by the public sector, and the contractor takes no responsibility for the long-term performance of the facility after the (relatively short) construction-warranty period has expired.

On the other hand, in PPP procurement, the public sector verifies the facility to be fit for the purpose before payment is made to the consortium. The private sector receives payments (Service Fees) over the life of the PPP contract on a pre-agreed basis, which is intended to repay the financing costs and give a return to investors. The service fees are subject to deductions for failure to meet output specifications, and there is generally no extra allowance for cost overruns which occur during construction or in operation of the Facility. Table 2-3 shows some of the key differences in procurement methodology.⁴⁶

The result of PPP approach is that significant risks relating to costs of design and construction of the facility, market demand for the facility (usage), or service provided by the facility, and the facility's operation and maintenance costs are transferred from the public authority to the private sector.⁴⁷

⁴⁵ Irimescu, Gabriel: Bewertung von ÖPP- und konventioneller Beschaffungsvariante aus Sicht der öffentlichen Hand und der Privatwirtschaft. Masterarbeit am Lehrstuhl Bauprozessmanagement und Immobilienentwicklung an der TU München, München, 2012.

⁴⁶ Australian government: National Public Private Partnership Guidelines, Vol. 1, 2008.

⁴⁷ Yescombe, E. R.: Public-Private Partnerships Principles of Policy and finance. Yescombe Consulting Ltd, London, UK, 2007.

Traditional procurement	PPP procurement
<ul style="list-style-type: none"> • Government purchases an infrastructure asset 	<ul style="list-style-type: none"> • Government purchases infrastructure services
<ul style="list-style-type: none"> • Short-term design and construction contracts (two to four years) 	<ul style="list-style-type: none"> • One long-term contract integrating design, build, finance and maintenance
<ul style="list-style-type: none"> • Input- based specifications 	<ul style="list-style-type: none"> • Output-based specifications
<ul style="list-style-type: none"> • Successful bidder would be the one that satisfies the minimum requirements specified by the client department with respect to quality of service or product and scores the highest mark in the tender evaluation which weighs both the technical and cost aspects 	<ul style="list-style-type: none"> • Successful consortium bidder would be the one that satisfies the mandatory requirements specified with respect to the ability of the facility to deliver the service required, the quality of design, construction and operation and on terms which provide best value for money
<ul style="list-style-type: none"> • Government retains whole-of-life asset risk 	<ul style="list-style-type: none"> • Private sector retains whole-of-life asset risk
<ul style="list-style-type: none"> • Payment profile has a spike at the start to pay for capital costs, with low ongoing costs 	<ul style="list-style-type: none"> • Payments begin once the asset is commissioned. The payment profile is relatively even, reflecting the level of service provision over the longer term of the contract
<ul style="list-style-type: none"> • Government is usually liable for construction time and cost overruns 	<ul style="list-style-type: none"> • Private contractor is responsible for construction time and cost overruns
<ul style="list-style-type: none"> • Government operates the facility 	<ul style="list-style-type: none"> • Government may or may not operate the facility
<ul style="list-style-type: none"> • Government manages multiple contracts over the life of facility 	<ul style="list-style-type: none"> • Government manages one contract over the life of the facility
<ul style="list-style-type: none"> • Often no ongoing performance defined 	<ul style="list-style-type: none"> • Performance standards are in place. Payments may be abated if services are not delivered to contractual requirement
<ul style="list-style-type: none"> • Handover quality less defined 	<ul style="list-style-type: none"> • End-of-term handover quality defined

Table 2-3: Traditional and PPPs procurement⁴⁸

2.1.9 PPP in Infrastructure Projects

Public infrastructure can be defined as facilities that usually required substantial capital investment, provide public services or solve problems perceived to be the public's responsibility, and are planned, designed, constructed, and operated by or under the auspices of government agencies.⁴⁹ Infrastructure projects are necessary for the functioning of the economy and society, especially in low-income countries or regions in poor nations. These are thus not an end in themselves, but a means of supporting a nation's economic and social activity, and include facilities which are ancillary to these functions. Infrastructure facilitates crucial economic activity such as manufacturing, trade, services and human capital growth. According to a World Bank

⁴⁸ Australian Government: National Public Private Partnership Guidelines. Vol.1, 2008 .

⁴⁹ Goodman, Alvin S. and Hastak, Makarand: Infrastructure Planning Handbook-Planning, Engineering and Economics. ASCE,2006, P.1.3

study, a 1% increase in infrastructure stock is associated with a 1% increase in GDP. The importance of infrastructure has been summarized as under: ⁵⁰

- Infrastructure increase economic output directly by making private capital more productive, by increasing the attractiveness of a region, and by the stimulation of the construction market.
- As the infrastructure network expands, national economic and financial efficiencies grow.
- Infrastructure has long term effects on the type of social structure which will be developed – in particular the growth of urban centers and their linkages.
- Inadequate infrastructure maintenance can cause an increase in costs to producers and, in extreme cases, a breakdown in economic activities.
- Badly planned sequencing of infrastructure provision can tie up capital unnecessarily.

Mainly, public infrastructure can be divided into: ⁵¹

- Economic infrastructure, such as transportation facilities and utility networks (for water, sewage, electricity, airports, roads, etc.), i.e. infrastructure considered essential for daily economic activity. Economic infrastructure normally involves the user pay principle. The fees collected from the user enable the private sector to repay its investor
- Social infrastructure such as schools, hospitals, libraries, housing, prisons, etc., i.e. infrastructure considered essential for the structure of society. The social infrastructures typically are availability-based which involves service payment by the government.

Over the past few years a number of organizations have estimated a wide gap between the government spending and the actual need for capital investment in infrastructure. Gramlich (1994) ⁵² has attempted to rationalize whether there really is a shortfall in government spending on infrastructure. He has addressed the need for a change in the policy for infrastructure investments. He hints at the possibility of funding infrastructure using user fees. Mansour and Nadji (2006) ⁵³ have discussed the policy issues for “privatization” of infrastructure in the U.S. They contend that the state/local government is not only pressed to fund the deficits but at the same time have other competing commitments towards health care and retirement. In this situation they believe, public-private partnerships are an alternative to traditional financing of infrastructure.

In general, PPP given its popularity has been used in many different infrastructure projects like: power generation and distribution, water and sanitation, refuse disposal, hospitals, medical and research centre, school buildings and libraries, stadiums and sport complexes, airports, prisons, railways, roads and highways, broadband and telecommunication and housing.

Infrastructure has public characteristics and features which are: ⁵⁴

- Presence of network services, providing activities that bind economic activity together
- Infrastructure frequently provides public goods where the benefits are shared by the whole community

⁵⁰ Sachs, Goldman: Building the World- Mapping Infrastructure Demand. New York, NY: Goldman Sachs, 2008.

⁵¹ Yescombe, E. R.: Public-Private Partnerships Principles of Policy and Finance. Yescombe Consulting Ltd, London, UK, 2007.

⁵² Gramlich, E. M.: Infrastructure Investment a Review Essay, J. of Economic Literature 32, 1994, P. 1176-1196.

⁵³ Mansour, A. and H. Nadji : Performance Characteristics of Infrastructure Investments. RREEF Research 128 MIG (Macquarie Infrastructure Group), SR 125 South Financial Close, 2007.

⁵⁴ Grimsey, D. and Lewis, M.K.: Public Private Partnerships-The Worldwide Revolution in Infrastructure Provision and Project Finance. Edward Elgar, Cheltenham, United Kingdom, 2004, P.27.

- There may be network externalities, whereby benefits and costs are conferred on those not a party to the transaction
- Infrastructure gives rise to natural monopolies, when scale economies make it practicable to have only one provider
- Infrastructure usually involves very large capital investments as compared to the running operational cost.
- Infrastructure characterized by construction, social, and environmental risks, complex and long bidding procedures, difficult stakeholder management, and long-drawn negotiations to financial closure.

Infrastructure itself is becoming more commercially oriented. There is a shift of paradigm from “taxpayer pays” to “user pays” principle.

2.1.10 Private Infrastructure in Developing Countries

During the 1990s, 121 developing countries had some private activity in at least one infrastructure sector, and 20 had private activity in all four. Of these 121, fifty are countries with lower incomes, forty-eight with lower middle incomes, and twenty-three with upper middle incomes⁵⁵. According to the PPI Project Data Base of the World Bank, from 1990 to 2012 private investment in developing countries in airport, port, rail, road, gas, electricity, telecommunication, and water and sewage sectors was worth about 2,653 billion USD allocated, among about 5,781 projects worldwide (See Table 2-4 and Figure 2-7).

Region	No. of projects	Investment in Million
Latin America and the Caribbean	1,705	769,444
East Asia and Pacific	1,666	358,547
South Asia	972	358,259
Europe and Central Asia	819	312,989
Sub-Saharan Africa	471	133,917
Middle East and North Africa	148	93,101
Total	5,781	2,026,257

Table 2-4: Investment in infrastructure for developing countries - number of projects (1990-2012)⁵⁶

In terms of class, the private investment takes on the form of divesture (23.91%), Greenfield (57.52%), M&O (0.35%), and M&O with major capital expenditure (Concession) (18.22%) (See Figure 2-8).

⁵⁵ Izaguirre, A. K .and Geetha, R.: Private Activity Fell by 30 Percent in 1999. Note no. 215, World Bank, Washington, D.C, 2000.

⁵⁶ www.worldbank.org.

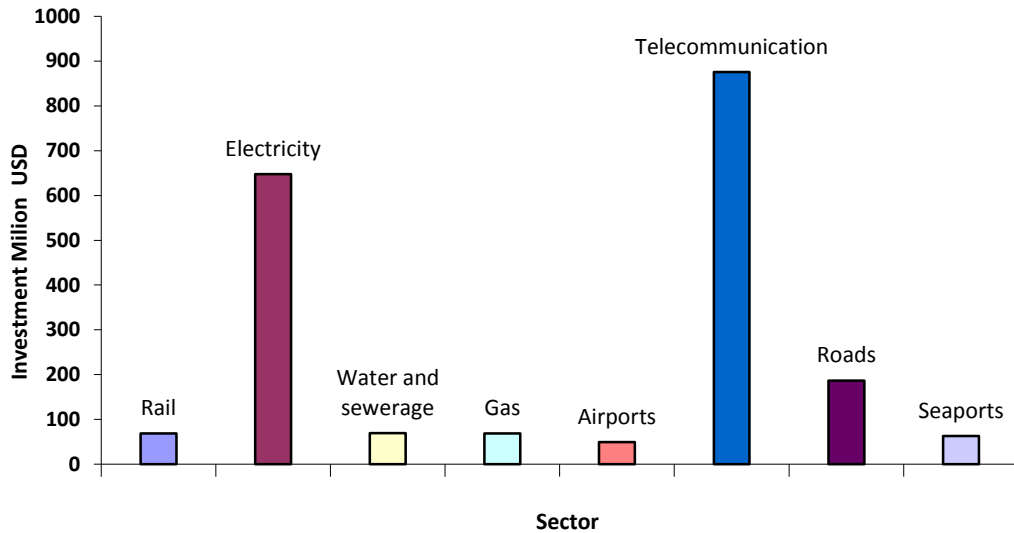

Figure 2-7: Total private investment infrastructure projects of developing countries (1990-2012) in Millions of USD⁵⁷

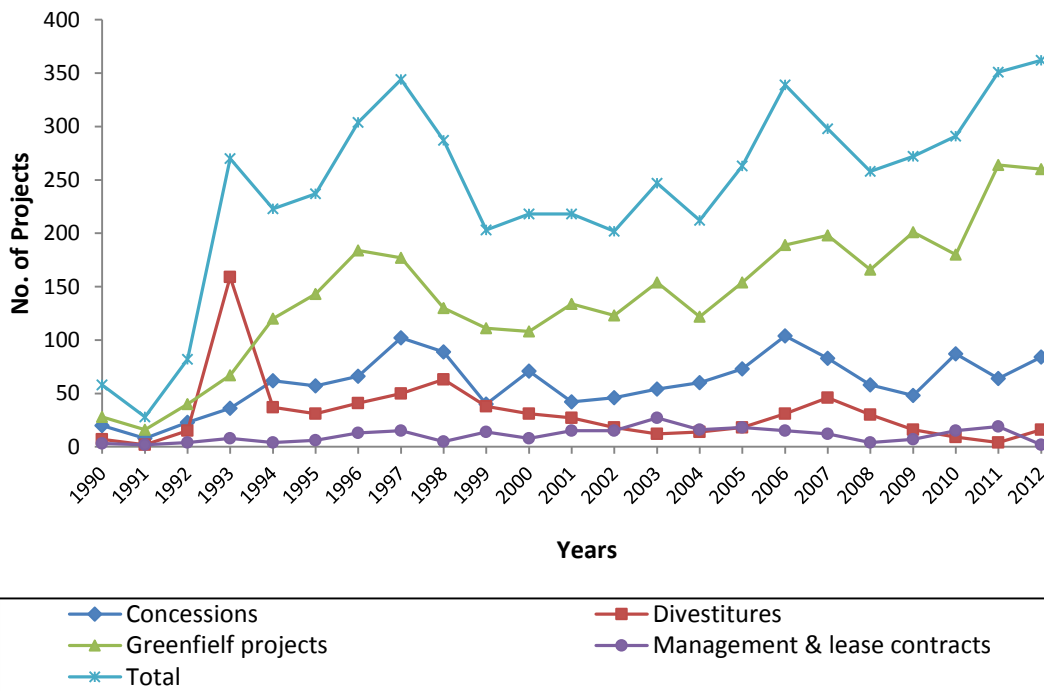

Figure 2-8: Number of infrastructure projects with private participation in developing countries by type of project, 1990-2012⁵⁸

In terms of numbers, the majority of private investment is Greenfield and concession projects, with 3,406 and 1406 projects, respectively, and 719 projects for the divesture (See Table 2-5 and Table 2-6). By sector, telecommunications and electricity dominated the total investment; representing about 43.16% and 31.93%, respectively (See Figure 2-9). The dominance of these

⁵⁷ www.worldbank.org.
⁵⁸ Previous reference.

sectors persists in term of the number of projects: 2300 projects in the electricity sector and 843 projects in the telecommunication sector (See Figure 2-10).

Sector	Divesture	Greenfield	M&O	M&O with major capital expenditure (Concession)
Telecommunication	332,985	536,811	0	5,602
Electricity	108,936	451,149	451	87,098
Water and sewerage	9,680	15,225	1,412	42,934
Gas	15,894	35,840	0	16,841
Airport	3,123	4,661	4,708	36,855
Rail	8,351	26,561	170	33,456
Road	3,789	62,162	0	120,574
Seaport	2,378	33,971	397	26,060
Total	485,136	1,166,380	7,138	369,420

Table 2-5: Infrastructure projects investment with private participation in developing countries by Class 1990-2012 (in Million USD)⁵⁹

The top three sectors which received most investment commitment with private participation are energy (Electricity and Gas), telecommunications and transport (See Figure 2-11). The trends of investment in the different sectors show the priority of the government at that point of time.

Sector	Divesture	Greenfield	M&O	M&O with major capital expenditure (Concession)
Telecommunication	195	632	7	9
Electricity	366	1,755	44	135
Water and sewerage	29	330	121	334
Gas	60	229	0	65
Airport	19	35	23	81
Rail	10	33	9	66
Road	19	232	24	535
Seaport	21	160	26	181
Total	719	3,406	254	1406

Table 2-6: Number of infrastructure projects with private participation in developing countries by Class (1990-2012)⁶⁰

⁵⁹ www.worldbank.org.

⁶⁰ Previous reference.

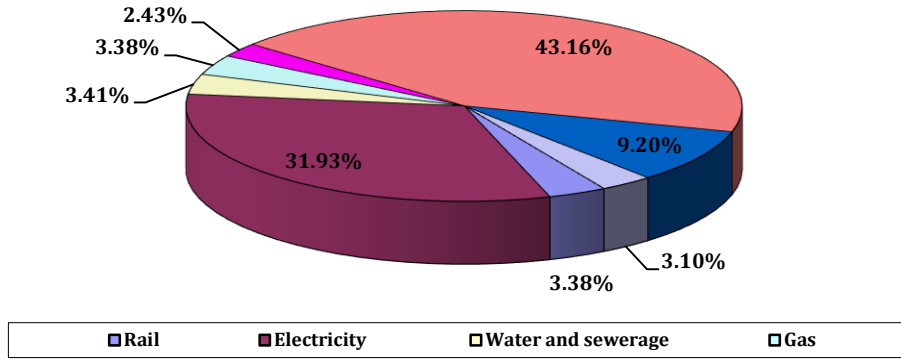

Figure 2-9: Private investment in infrastructure projects of developing countries by Sector (1990-2012)⁶¹

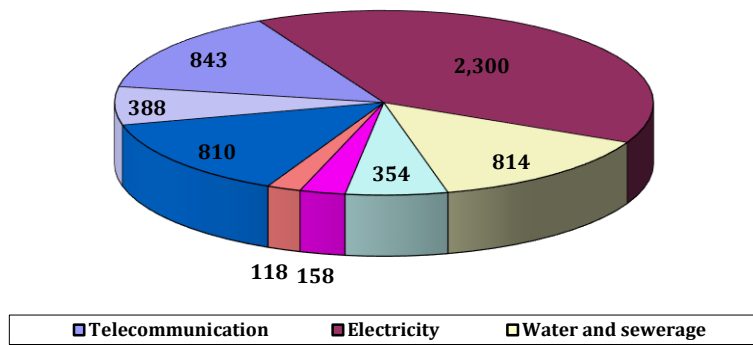

Figure 2-10: Number of private investment in infrastructure projects of developing countries (1990-2012)⁶²

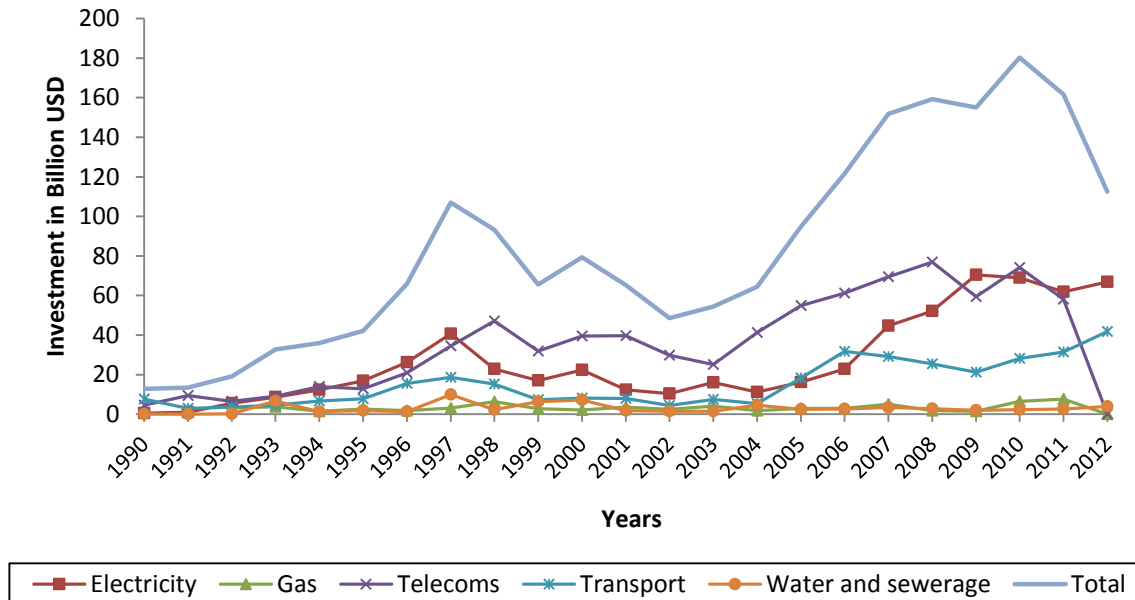

Figure 2-11: Investment in infrastructure projects with private participation in developing countries in different sectors, 1990-2012⁶³

⁶¹ www.worldbank.org.

⁶² Previous reference.

⁶³ Previous reference.

2.2 PPP Project Finance Structure Overview

When it comes to define the meaning of project finance, we may find the answer obscure since the methodologies and tools used in project finance vary from project to project, and country to country. Project finance is traditionally used to develop and operate many types of infrastructures projects. Project Finance is defined as:

“Method of raising long-term debt based on the projected cash-flow from the project which is yet to be established”.^{64 65}

One of the main attractions of pursuing PPP projects is the possibility of undertaking development infrastructure project without putting additional strain to the public finance. Hence, PPP arrangements will always involve private sector and private finances. The typical structure of a PPP normally involves a special purpose vehicle SPV. This SPV consist of several private sector companies join forces, become project promoters, and form a separate company that becomes responsible for financing, building, and operating the facility.

In order to form this SPV, project promoters must determine how to fund the associated construction and start-up costs. It is customary nevertheless for most project financings to have certain specifications for the ranges of the different types of capital present in their structuring, they must decide how much to borrow, how much to infuse from their own funds, and how much to rise from outside investors. They must balance the higher returns on equity against greater exposure. However, since debt usually comes at a lower price, the consortium must balance the amount of debt against the overall financial costs of the project. Hence, finding the right balance between equity and debt is always a difficult issue.⁶⁶

Figure 2-12 shows the flow of services, payments and funding with the different stakeholders. Since the public sector has transferred substantially many of it risk and obligations under traditional procurement to the private sector, the whole operation and funding will be the responsibility of the private sector.⁶⁷

Usually, raising the necessary capital is achieved through a combination of debt and equity, where the debt that is raised for the capital costs of a project is then repaid based on cash-flows that are generated from the operation of the project. This debt is financed on a non- or limited recourse basis with the recourse (if applicable) being restricted only to the assets or cash-flows of the project itself.⁶⁸ If the promoting team does not have the necessary equity to achieve the optimal debt-to-equity ratio, then it should search for additional investors until there are enough resources to achieve the optimal capital structure.

The use of debt is essential to fund large infrastructure concession projects because promoters rarely have all the necessary financial resources. Typically, the higher percentage of debt to equity, the more financially risky the project will be. The lower percentage of debt to equity, the less profitable the project will be. The margin of profitability is very difficult to determine

⁶⁴ E.R Yescombe: Principle of Project Finance. 2002.

⁶⁵ Khan, M. Fouzul Kabir and Parra, Robert J.: Financing Large Projects- Using Project Finance Techniques and Practices. 2003.

⁶⁶ Boussabaine, Abdelhalim: Cost Planning of PFI and PPP Building Projects. 1st edition, Taylor & Francis, New York, 2007.

⁶⁷ Zimmermann, Josef: Project Delivery Systems. Lecture Notes, Lehrstuhl für Bauprozessmanagement der TU München, 2013.

⁶⁸ Asenova, D. and M. Beck.: A Financial Perspective on Risk Management in Public-Private Partnership. Public-Private Partnerships-Managing Risks and Opportunities. Blackwell Science Ltd, Oxford, UK, 2003.

accurately because the profits are shared by a large number of equity investors in the project.⁶⁹ However, the use of equity is also essential because it complements debt financing and more easily accommodates the financial needs of the project. Equity is more flexible because dividends are paid based on the availability of funds.

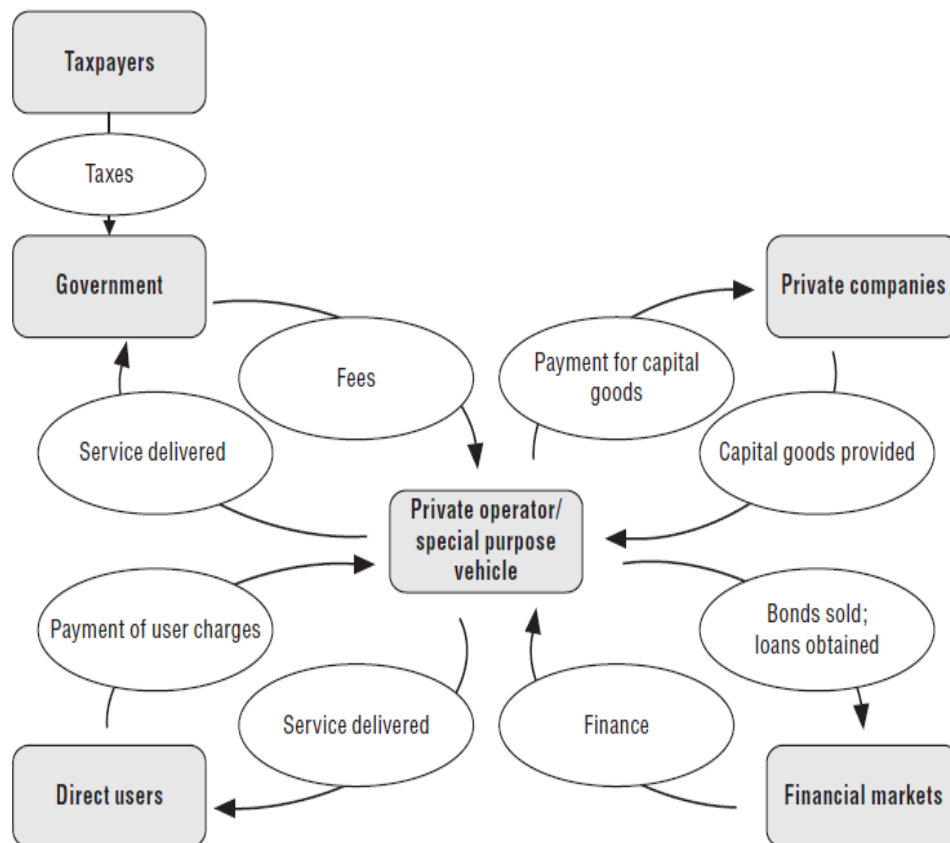

Figure 2-12: The typical flow of services, payments for services and funding⁷⁰

Furthermore, the determination of debt capacity and optimum financial structure provides the basis for the structure and evaluation of the possible types of guarantees (minimum production, minimum revenue, etc.) that the host government may extend to the project.⁷¹

Project financing benefits are represented by the distribution of risk by the investor to the project company, as the only liable established company with their assets, and even if the project fails, the balance of the investor remains untouched. On the other side, project financing disadvantages are by the requires equity in the project company, and that the cash flows of the project must ensure the debt service with respect to all risks.⁷²

⁶⁹ Boussabaine, Abdelhalim: Cost Planning of PFI and PPP Building Projects. 1st edition, Taylor & Francis, New York, 2007.

⁷⁰ OECD: Public-Private Partnerships In Pursuit of Risk Sharing and Value for Money. 2008, P.51.

⁷¹ Dias, A and Ioannou, P G: Optimal Capital Structure for Privately Financed Infrastructure Projects – Valuation of Debt, Equity, and Guarantees. UMCEE Report No. 95-10, Department of Civil and Environmental Engineering, University of Michigan, 1995.

⁷² Zimmermann, Josef: Einführung Public private Partnership. Seminar Immobilienwirtschaft, Lehrstuhl für Bauprozessmanagement der TU München, 2013.

2.2.1 Phases of Financing

PPP projects funding is provided, as they are understood in this research, by private companies. That is, the private receives a loan to finance the design, construction and operation. Even with the models that were presented in chapter two, the financial closing is always represented by the private side. For the financing of PPP projects there are two phases:

- Interim financing (short-term financing), such as financing during the building up to the building completion
- Final financing (long term), such as financing from completion of construction until the end of the use phase (operation phase).

The interim financing will be provided by the private companies. This is also the case in the conventional way procurement. It takes the form of short-term borrowing by the contractor or in PPP by the project company. Not only the creditworthiness of the borrower (project company), but also the banks and the prevailing economic situation have a significant impact on financing conditions. Especially in long-term borrowings and large-volume loans, financing conditions may have a significant disadvantage in the economic success of the project. The risk for the bank is thereby expressed by a rating of the borrower. The better the rating, the lower the cost of financing is.

The average interest rates are the basis for the services offered by the bank for the interim financing. Since the pre-financing refers exclusively to the construction time, however, the impact on the overall economics of the PPP project for maturities of up to 30 years should be checked in each case by case basis.⁷³

For final financing (operation phase), there is several different possibilities. Basically here is to distinguish between so-called pure project financing on the one hand, which must be judged solely on the profitability of the project, and on the other hand, partially or wholly publicly hedged financing. (Previous reference)

2.2.2 Source of Capital

It is well known that one of the main obstacles in the delivery of public and private projects is the availability of funding. PPP normally entails large capital expenditure. Hence it would be prudent to consider all ways of financing to meet both long term capital investment and short term working capital for operation purpose. PPP financing sources is determined by the different incentive problems faced in the construction and operational phases. Construction is subject to substantial uncertainty, major design changes and costs depend crucially on the diligence of the sponsor and the building contractor. Thus, there is a wide range for moral risk at this stage. Later and during the operation phase, when private financiers commit funds under PPPs for infrastructure, they need to be convinced that a viable revenue stream can be tapped. In a public–private arrangement, revenues to the private firm can come from two sources, namely consumer payments, or public entity payments (or from some combination of both). The source is important because it determines (1) the incentives of a private firm to adjust the cost and quality to consumers' willingness to pay for them, (2) the amount and timing of public expenditures, and (3) the nature of the risks to which revenues are exposed.⁷⁴ This section

⁷³ Gabriel Irimescu: Bewertung von ÖPP- und konventioneller Beschaffungsvariante aus Sicht der öffentlichen Hand und der Privatwirtschaft. Master thesis, 2012, P.21.

⁷⁴ Grimsey, D. and Lewis, M.K.: Public Private Partnerships-The Worldwide Revolution in Infrastructure Provision and Project Finance. Edward Elgar, Cheltenham, U K, 2004.

outlines the main sources of private-sector capital that a project may use in raising funds. Each source of financing will take differing levels of risk, and have different financing terms attached to them.

2.2.2.1 Equity Capital

Equity refers to the long-term capital invested by the sponsor that have an active interest in the project such as governments, contractors, operators, suppliers, etc. and minority sponsors that have a passive interest such as pension funds or insurance companies.⁷⁵ Equity investment can take in two forms: preferred stock and common stock. The preferred stock pays dividends and is senior to common stock. Preferred stock has fixed return, while return on common stock depends on the financial performance of the company.

Equity investors are the last in priority for claim repayment i.e. equity payment would take place after other obligations have been met. In contrast, equity investors have chance to gain potential upside if the project is successful without being capped as other investors. Equity investors normally expect higher returns on equity in exchange for assumed higher risks than that of other capital providers. Lenders look to the equity investment as providing margin of safety. They have two primary motivations for requiring equity investments in projects which they finance:⁷⁶

- The more burden the debt service puts on the cash flow of the project, the greater the lender's risk.
- Lenders do not want the investors to be in a position to walk away easily from the project.

To find the appropriate debt to equity ratio for the project, many factors taken into consideration, including debt to equity ratios for the particular industry involved and market expectation and risk. Unless guarantees are available, lenders will require a large equity investment in a project. Equity may be in the form of preferred stock as well as common stock (previous reference).

2.2.2.2 Senior Debt

Senior debt are normally available with shorter periods at a floating rate and are therefore often less suited for use in financing a long-term infrastructure project. Additionally, commercial banks may request guarantees from export credit agencies to protect them from pre-completion risks before providing financing.⁷⁷ Nevertheless, the flexibility of these debts prompts many project sponsors to use them in financing projects. Commercial banks are normally more willing (than institutional investor, for instance) to tailor debt structures that meet the specific needs and are prepared to work with in the interest of continuing the project in case of default rather than simply forcing borrowers into bankruptcy.⁷⁸

Senior debt is not subordinate to any other liability. It falls into two categories: unsecured loans and secured loans. Senior debt holders have an advantage in liquidation over unsecured debt holders. An unsecure loan is debt backed by the general credit of the borrower, and is not

⁷⁵ Cited in, Kohli, H at al.: Choices for Efficient Private Provision of Infrastructure in East Asia. from Kohli, H *et al.*: Making the Next Big Leap-Systemic Reform for Private Infrastructure in East Asia. World Bank, Washington, D.C., 1997, P. 1-20.

⁷⁶ Nevitt, Peter: Project financing. 5th edition, Euro money, 1989.

⁷⁷ Ferreira, D and Khatami, K: Financing Private Infrastructure in Developing Countries. Paper No 343, World Bank, Washington, D.C, 1996.

⁷⁸ UNIDO: Guidelines for Infrastructure Development Through Build-Operate-Transfer. United Nations Industrial Development Organization, Vienna, 1996.

secured by a security interest in any asset. Secured loans are available to most projects where the asset securing the debt has value as collateral. Banks are good source of secured loans.⁷⁹

The interest rate is the price lenders charge for lending their money to the project. The lenders' profit is the spread. It is related to the risk in the project. The greater the cash flow of the project, the more the loan is protected. The DSCR (debt service coverage ratio) is the most common financial ration used in cash flow lending. It measures the level of protection the cash flows of the project provide for servicing of principal and interest on the debt.⁸⁰

2.2.2.3 Subordinated Debt

Subordinated debts, called mezzanine debts or quasi equities, are senior to equity capital but junior to senior debt and secured debt. Senior debt is relied upon in cases where there is a gap between senior debt and sponsor equity. This situation typically arises when senior debt providers are not prepared to increase the level of debt and the sponsors cannot invest more equity. This can be due to the small size of equity provided by the sponsors or specific project circumstances.⁸¹

Subordinated debt has the advantage of being fixed rate of interest higher than the cost of senior debt,⁸² long term, insecure and be considered as equity. A subordinated loan is often used by a sponsor to provide capital to a project which will support senior borrowings from third party lenders. Subordinated lenders are cash flow lenders. They are unsecured. Subordinated lenders are sensitive to the capabilities of the management of the project to production and market share while servicing debt.⁸³ Because of assuming higher risks than commercial loan providers, subordinated loans holders are promised either a higher return or a partial participation on profit or capital gains of project equity.^{84 85}

2.2.2.4 Supplier Credit

This form of funding normally is used by equipment suppliers, when they provide a credit facility for the Project Company especially when project equipment involves a large amount of capital. Normally, it is for short-term periods.

2.2.2.5 Bond Issues

A bond issued by a Project Company is a loan,⁸⁶ shares in which can be traded on the stock exchange, just like shares in equity. There is increasing use of the bond markets to fund PPP projects. Because of longer tenors and lower interest rates, bond appears to be more suited to financing major infrastructure projects than are other commercial loans, this type of funding is mostly used to finance large projects. Usually bond financing is used as an alternative to senior

⁷⁹ Nevitt, Peter: Project Financing. 5th edition, Euro money, 1989.

⁸⁰ Walker, C. and Smith, A. J.: Privatized Infrastructure-The Build Operate Transfer approach. Thomas Telford, London, 1995.

⁸¹ Akintola A., Matthias B. And Cliff H.: Public private partnerships: Managing risks and opportunities, School of the Built and Natural Environments, Glasgow Caledonian University, 2003, P.132.

⁸² Yescombe, E.R: Principle of project finance, UK, 2002.

⁸³ Walker, C. and Smith, A. J.: Privatized infrastructure: The Build Operate Transfer approach, Thomas Telford, London, 1995.

⁸⁴ Peter K. Nevitt and Frank J. Fabozzi: Project financing. 7th edition, Euromoney Institutional Investor PLC, 2000, P.58.

⁸⁵ UNIDO: Guidelines for Infrastructure Development through Build-Operate-Transfer. United Nations Industrial Development Organization, Vienna, 1996.

⁸⁶ Yescombe, E.R: Principle of project finance, UK, 2002.

debt. In this funding mechanism the payments from the return from the project are used to pay the interest on the bonds. It is a requirement that the bond issued must be underwritten by a lender so that they have a guarantee that it will have adequate cash to carry out its activities.⁸⁷ Generally, Bonds are graded into investment grade bonds if rated Baa or above when using bond rating given by Moody's and Standard and Poor's and junk bonds if below Baa. Rating bond normally reflect its default risk (See Table 2-7). Low-rated bonds usually promise higher yields to attract investors with shorter maturities.⁸⁸

Moody's	Standard Poor's	Rating
Aaa	AAA	Investment grade
Aa	AA	Investment grade
A	A	Investment grade
Baa	BBB	Investment grade
Ba	BB	Junk bonds
B	B	Junk bonds
Caa	CCC	Junk bonds
Ca	CC	Junk bonds
C	C	Junk bonds

Table 2-7: Bond rating⁸⁹

2.2.2.6 Export Credit Agency Facility (ECA)

Credit facility provided by export credit agency, typically a government owned company, established to promoting and supporting the country's export. Essentially, an ECA protects exporters or their financiers against a default in payment by buyers of goods, whether the default is due to commercial or political causes.⁹⁰

This facility is suited to financing infrastructure project because of their long-term maturities and the agency sometimes provides so-called subsidies. However, this facility is not lunch free because it is normally accompanied by some requirements, such as when the borrower shall purchase equipment from the lending country. Hence, the project company should take costs associated with the credit such as currency, tying, negotiation and delay, project bias, political and bureaucratic costs, and other financial costs into account.⁹¹

Moreover, most agencies limit their tenors to ten years (twelve years for power plants), mandate semi-annual repayment of principal, and allow only a six-month grace period following project completion.⁹² Figure 2-13 below shows the relationship between SPV and the ECA.

⁸⁷ Boussabaine, Abdelhalim: Cost planning of PFI and PPP building projects, 1st edition, Taylor & Francis, New York, 2007, P.93.

⁸⁸ Brealey, R A and Myers, S C: Principles of corporate finance. 4th edition, Irwin McGraw Hill, New York, 1991.

⁸⁹ Previous reference..

⁹⁰ Sapte, Wilde: Project finance: The guide to finance Build Operate Transfer projects uses in PPP. Euromoney, 1997.

⁹¹ Harvey, C: Analysis of project finance in developing countries. 1st edition, Heinemann, London, 1983.

⁹² Ferreira, D and Khatami, K: Financing private infrastructure in developing countries. Paper No 343, World Bank, Washington, D.C, 1996.

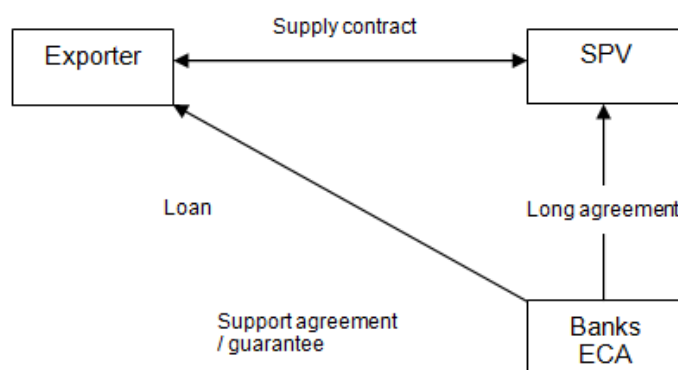

Figure 2-13: The relationship between SPV and the ECA⁹³

2.2.2.7 Multilateral or Bilateral Agency Facility

Multilateral or bilateral agency facility in the context of financing PPP projects is referring to development finance institutions (DFIs), which play an important role in infrastructure projects in the emerging markets.⁹⁴ It can be extremely effective in addressing sovereign risks faced by private sector infrastructure providers rather than directly lending funds. They can provide financing in forms of equity, senior loans, and subordinated loans with maturities longer, for longer than 10 years, which is likely difficult to access from the market.

Usually, DFIs making of agreements entered into by governments and are sponsored by multi governmental institutions such as the World Bank, the European Union (the same previous reference), the United States Agency for International Development (USAID), the Canadian International Development Agency (CIDA), and the Overseas Development Administration of the United Kingdom (ODA), the Asian Development Bank (ADB), and the European Bank for Reconstruction and Development (EBRD). To promote private investment growth, some financial institutions are also providing funds for private sector. They include the International Finance Corporation (IFC), Private Sector Department of ADB, the Merchant Banking Department of EBRD, the Commonwealth Development Corporation of the United Kingdom, and the Overseas Private Investment Corporation (OPIC) of the United States.^{95 96}

Guarantees can be arranged such that commercial risk resides with the private investors. Two types of guarantees are used:⁹⁷

- **Guarantees for Project Finance:** This is a partial sovereign risk guarantee in that the development bank assumes part of the political risk for a project, thus helping to make the project more financially viable.

⁹³ Previous reference.

⁹⁴ Sapte, Wilde: Project finance: The guide to finance Build Operate Transfer projects uses in PPP, Euromoney, 1997.

⁹⁵ UNIDO: Guidelines for Infrastructure Development through Build-Operate-Transfer, United Nations Industrial Development Organization, Vienna, 1996.

⁹⁶ Khan, M. Fouzul Kabir and Parra, Robert J.: Financing Large Projects: Using project finance techniques and practices, 2003.

⁹⁷ Grimsey, D. and Lewis, M.K.: Public private partnerships: The worldwide revolution in infrastructure provision and project finance, Edward Elgar, Cheltenham, U K, 2004.

- **Guarantees for Extending Loan Maturities:** A partial credit guarantee is designed to extend loan maturities; that is, to extend loan terms beyond those that commercial lender normally would be willing to offer.

Participation of the multilateral development banks also gives a 'seal of approval' to the projects concerned because of the additional monitoring and project evaluation.

2.2.3 Value for Money in PPP Projects

One of the main reasons that projects are procured by PPP is to enhance Value for Money (VFM) by inviting the private sector to handle public works projects. VFM, defined as the optimum combination of whole life cycle costs, risks, completion time and quality in order to meet public requirements.⁹⁸ This is another important consideration when deciding whether to proceed with the PPP option, especially for the public sector.⁹⁹ "Public Sector Comparator" PSC is the most common tool used by the public sector to show how much it would cost the government to build the asset through public funding, which is then used to compare with how much it would cost to build it as a PPP (See Figure 2-14 below).¹⁰⁰

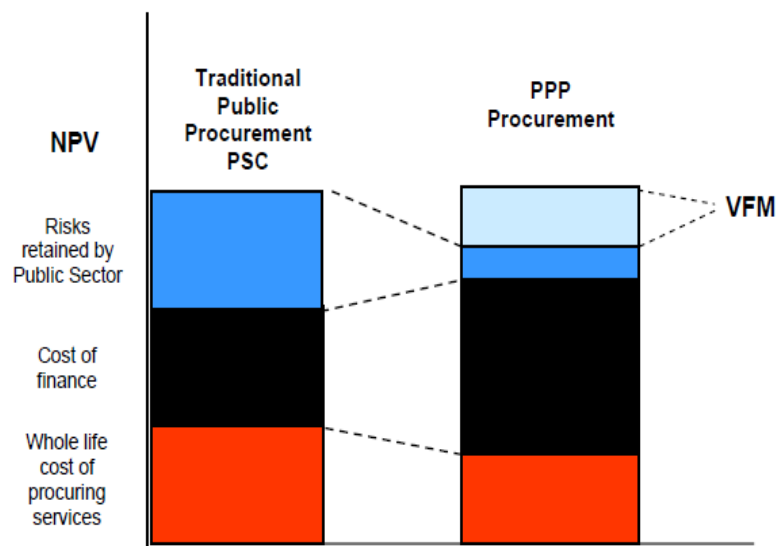

Figure 2-14: Value for Money (VFM) Demonstration¹⁰¹

The concept of PSC is, like PPP, developed in Great Britain. Basically the PSC provides a fictive value level to the comparison of a traditional reference project to a project involving a private part.¹⁰² In the first stage of the evaluation the PSC is used to estimate the financial, societal and operational assessment. The financial assessment is of great importance, but only includes the economic consequences. Therefore it is also important to evaluate the societal and

⁹⁸ Previous reference.

⁹⁹ Boussabaine, A.: Cost planning of PFI and PPP building projects. Taylor and Francis, 2007.

¹⁰⁰ Farrah, T.: Brumby wins battle to keep East Link costs secret, 2007.
<http://www.theage.com.au/news/national/brumby-wins-battle-to-keep-eastlink-costs-secret/2007/02/13/1171128974031.html>.

¹⁰¹ Skanska: European Commission: Second International Workshop on PPPs European Commission, 2004.

¹⁰² Initiative D21 *et al.*: Prozessleitfaden PPP, Berlin, 2003, P. 128.

operational opportunities in a PPP model.¹⁰³ In the preparation of the PSC, the public part must bear in mind the predicted cost of the project during the entire life cycle to use of the financial assessment. These are assessed based on demands of quality and quantity of the services and the risk associated. If the decision falls on PPP, the PSC is adjusted to use in the evaluation of the incoming tenders in the procurement phase.

Allan (2001)¹⁰⁴ stated there are two critical questions to be asked when determining PPP superiority over traditional models. First, does the project possess a positive NPV long-term? Secondly, is the NPV of PPP better than that of PSC? If so, the use of the PPP option then demonstrates superior VFM and the decision by officials is warranted. In other words, officials have indicated that the prerequisite for implementing PPP is evidence that whole life benefits of the project outweigh the risk costs of PPP procurement at a recognizable level. If PPP does not demonstrate superior VFM, then officials should use traditional procurement.

It is necessary to include all relevant public sector costs when calculating the PSC, such as inflation, construction costs, consultant costs, capital costs, maintenance costs, labor costs, employee costs, insurance costs, and corporate overhead costs, among others.¹⁰⁵

Often the public sector fails to consider some of the costs of a project (such as employee benefits, administrative costs, and utilities), which leads to an under-representation of the PSC's true cost.¹⁰⁶ It is important to ensure that the cost savings from using a PPP arrangement is not outweighed by the transition and oversight costs. For example, when a PPP is used the government must perform some oversight functions to ensure the private sector is complying with contract requirements and any additional regulations (such as environmental regulations). Additionally, there are some transition costs when the project is transferred from the private sector to the public sector. Managers need to ensure that the VFM from using a PPP is greater than the projected transition and oversight costs to the government.¹⁰⁷

2.2.4 Financial Appraisal Technique of PPP Projects

The financial appraisal of a project is usually defined and measured by the fulfillment of certain indicators that point to the attainment of the financial targets of the various project stakeholders. Financial feasibility analysis is conducted by developing a base case financial plan and assessing the sensitivity of the profitability of the project, and the projected return, on the investor's equity to various contingencies. Computer modeling is usually needed for analyzing these factors and can also be used in sensitivity analysis to analyze fluctuations in product price, changes in operating and maintenance cost, the effects of cost overruns, delay in completion, interruptions of project operations and other significant factors.¹⁰⁸

When conducting a financial feasibility analysis, the analyst must start by making certain assumptions about the investment project. As the project gets closer to reality, the assumptions

¹⁰³ EBST: Vejledning om OPP til bekendtgørelse om OPP. partnering og nøgletal, Copenhagen, 2004, P.12

¹⁰⁴ Allan, J. R.: Public-Private Partnerships: A Review of Literature and Practice (Rep. No. 4). Saskatchewan Institute of Public Policy, 2001.

¹⁰⁵ Department of Treasury: Public Private Partnerships: Public Sector Comparator Policy, Additional Policy guidance, Government of Western Australia, 2011.

¹⁰⁶ Goldbach, Claire *et al*: Public Cost Comparator for Public-Private Partnerships, National Council for Private-Public Partnerships, 2012.

¹⁰⁷ Dawn B., Amber K., Lucombo J., Benjamin S., Sean S., and Stephen W.: The Value for Money Analysis: A Guide for More Effective PSC and PPP Evaluation, 2012.

¹⁰⁸ Finnerty, J.D.: Project financing: asset-based financial engineering. 1st ed., USA: John Wiley & Sons, 1996.

become more accurate and reliable, and thus also the analysis. If a reasonable change in an assumption could make the project change from successful to unsuccessful, the assumption should be considered a key element. Hard facts should be clearly distinguished from assumptions and the sources for the facts and the rationale for key assumption noted.¹⁰⁹ The existence of these different project stakeholders naturally assigns to the financial viability a different meaning based on their different perspectives and targets. In PPP projects the three parties whose interests have to be bridged in order for the project to be successfully completed and operated are the public authority, the equity investors and the lenders.

Financial feasibility can be measured on the basis of accounting profits (from financial statements) or the projected cash flows of the project. Financial statements are records of actual financial activities of a business and are therefore not available for prospective projects, but projections of statements can be used to gain a better understanding of a project's finances. The cash flows of the project can also be projected and used to analyze the performance of the prospective project. The cash flow method is preferred over the accounting profits method, as the cash flow method considers the time value of money but accounting profits does not. Also, cash flows are always calculated in the same way but accounting profits can be calculated in several different ways, e.g. using different depreciation methods or inventory listings, which give different profit results. Hence, the cash flow method is considered more appropriate for evaluating the financial feasibility of investment projects.

There are several different cash flow based methods that can be used to measure the financial feasibility of projects, such as the Net Present Value (NPV), Internal Rate of Return (IRR), payback period; these measures will be studied further.

2.2.4.1 Financial Appraisal from Public Authority's Perspective

From the public authority's point of view, project appraisal is usually related with increasing social welfare from the project's development and achieving the best Value for Money (VfM).¹¹⁰ VfM is defined as the optimum combination of whole life cycle costs, risks, completion time and quality in order to meet public requirements.¹¹¹ In general, the major issue for the public authority decision makers is whether to proceed with the PPP option, a decision that is made well ahead of the procurement phase of the project and is justified through a cost-benefit analysis, the determination of the economic return of the project and by undertaking comparative studies and analyses, a very popular way being through the use of a Public Sector Comparator (PSC).¹¹²

2.2.4.2 Financial Appraisal from Equity Investors' Perspective

From the equity investors' point of view the main interest lays on the actual profitability and liquidity of the project and in particular on the profit left after the debt obligations have been fulfilled. The equity investors being the last link in the priority chain of the PPP financing in terms of gains and the first ones in terms of losses, Moreover, the typical measures used for the

¹⁰⁹ Matson, J.: *Cooperative Feasibility Study Guide*. [online] USA: United States Department of Agriculture. Rural Business – Cooperative Service. Report 58. 2000, <http://www.rurdev.usda.gov/rbs/pub/sr58.pdf>.

¹¹⁰ Yescombe, E.R.: *Public-private partnerships – principles of policy and finance*. Elsevier Ltd, UK, 2008.

¹¹¹ Grimsey, D. and Lewis, M.K.: *Public private partnerships: The worldwide revolution in infrastructure provision and project finance*. Edward Elgar, Cheltenham, U K, 2004.

¹¹² See Section 2.2.3.

financial analysis are: profit margin before and after tax, return on equity (ROE) and internal rate of return (IRR). Usually during the initial stages of PPP, a detailed cash flow analysis using net present value and discounting method will be carried out. The cash flow analysis deals with projection of future income and expenditure of the PPP. However the critical aspect is the cost of capital during the project cash flow appraisal. Generally a long term discount rate is used in order to prevent short term factors from influencing the appraisal.

Liquidity of the PPP can be analyzed using short term working capital ratios like creditor's payable, debtor's receivables, current ratio and even short term liability from credit facilities like overdraft from banks. The liquidity ratios are typically used to alert the management that the cash flow issues and difficulty to meet short term liability with the current assets available. All the above indicators are widely explained and calculated in Chapter 3, section 3.2.

2.2.4.3 Financial Appraisal from Lenders' Perspective

From lenders' point of view, the financial viability of the project compatibles to the repayment of the issued debt and is very much dependent on the relation between the project's costs and revenues generated during its operating life.

In that respect, an analysis of the profitability of the project is of much interest to prevent bankruptcy risks, to measure projects' ability in repaying debt obligations, Cover Ratios (CRs) are used. The most commonly CRs used are the Annual Debt-Service Cover Ratio (ADSCR), the Loan-Life Cover Ratio (LLCR) and Project-Life Cover Ratio (PLCR).¹¹³

DSCR is defined as the ratio of the annual cash available (after tax) to annual total debt service.¹¹⁴

$$DSCR_j = \left(\frac{REV_j - OMC_j - TAX_j}{ADI_j} \right)$$

Where

$DSCR_j$ = Annual debt-service cover ratio in the j th year.

REV_j = Gross revenue in the j th year.

OMC_j = Operation and maintenance cost for the i th year in current-dollar value

TAX_j = Tax payable to the government in the j th year; and

ADI_j = Annual equal debt installment in the j th year

j = Index for the operation period.

Equation 2-1: Annual debt-service cover ratio

LLCR is defined as the ratio of net present value of future income over the debt maturity period against outstanding debt.¹¹⁵

¹¹³ Yescombe, E.R.: Public-private partnerships – principles of policy and finance. Elsevier Ltd, UK, 2008.

¹¹⁴ Zhang, X.: Paving the Way for Public-Private Partnerships in Infrastructure Development. Journal of Construction Engineering and Management, Vol. 131(1), 2005, P.71-80.

¹¹⁵ Yescombe, E.R.: Public-private partnerships – principles of policy and finance. Elsevier Ltd, UK, 2008.

$$LLCR_j = \frac{\sum_{j=k}^{LRP} \left\{ \frac{PBIT_j + DEP_j - TAX_j}{(1 + r_b)^{j-k}} \right\}}{\sum_{j=k}^{LRP} \left\{ \frac{ADI_j}{(1 + r_b)^{j-k}} \right\}}$$

Where

$LLCR_j$ = Loan life coverage ratio in the j th year.

$PBIT_j$ = Profit before interests and tax

DEP_j = Depreciation in the j th year; and

r_b = Interest rate of debt borrowed;

Equation 2-2: Loan life coverage ratio

PLCR is used to measure the project capacity to service its debt; it is a ratio of net present value of future income over the whole life of the project to outstanding debt.

$$PLCR_j = \frac{\sum_{j=k}^{SOP} \left\{ \frac{PBIT_j + DEP_j - TAX_j}{(1 + r_b)^{j-k}} \right\}}{\sum_{j=k}^{LRP} \left\{ \frac{ADI_j}{(1 + r_b)^{j-k}} \right\}}$$

Where

$PLCR_j$ = Project life coverage ratio in the j th year.

SOP = Sponsor operation period (year).

LRP = Loan repayment period (year).

Equation 2-3: Project life coverage ratio

Lenders will determine minimum acceptable CRs based on their perceived risks of the project and have to be fulfilled at all times for the project to be ultimately financed. Furthermore, these CRs determine the actual leverage (ratio of debt to equity) of the project which should be optimal to achieve the required weighted average cost of capital (WACC), and also this will ensure that PPP's future profitability will be able to meet the required internal rate of return of the equity and debt investors.

In the case that the ratios are below the base case, the dividend lockup level will determine if the equity investor will get any dividend payment. When the ratio falls below dividend lock up level, it will be in a critical stage. This is because although debt interest can still be met, in the long run the risk of default will be higher. Effective monitoring will buy some time for the private party to manage the finance of the operation in order to stay close to the base case and to prevent further downward drift (See Figure 2-15).¹¹⁶

¹¹⁶ Zimmermann, Josef: Project delivery systems. Lecture Notes, Lehrstuhl für Bauprozessmanagement der TU München, 2013.

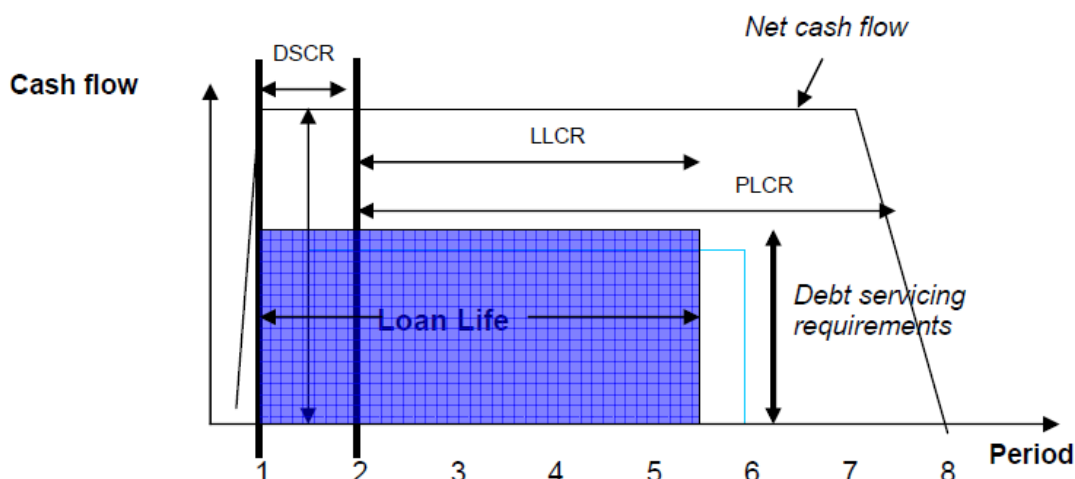

Figure 2-15: Monitoring debt ratio level over time¹¹⁷

2.2.5 Public Sector Finance (Government Support)

Government sometimes provide loan assistance using tax payers' money during the construction phase as a kind of subsidy, this take place when governments seek private investment in infrastructure, they find themselves pressured to give subsidies, guarantees, and other forms of support.¹¹⁸ These are particularly strong in developing countries and at times when investors' enthusiasm for developing-country infrastructure businesses is low.¹¹⁹ Fishbein and Babbar (1996)¹²⁰ indicated that there are two reasons for government to provide support to the Project Company in PPP project. Firstly, it is expected to reduce capital requirement and to improve income stream during the project. Secondly, it is to protect investors from risk of inadequate cash flows.

The problem with this approach is whether it is advisable to use tax payers' money to finance an infrastructure which may only be used by a certain group of users and whether this tax are used for current spending or capital investment. It can be argued if the project is now a private project or a public sector project. This leads to many grey area of whether it is beneficial to finance the PPP during its operation. Only when the project is finally transferred to the government will this infrastructure be included in the asset and liability of the public finance. This model is known as the assisted PPP financing model (See Figure 2-16).¹²¹

The private sector can use the projected income stream from a concession as collateral by issuing revenue bonds to the government. The government is indirectly financing the PPP via the SPV by holding the bonds. In order to make it attractive to other private investors, the government may actually demand a lower rate of return compared to the market rate and have its loan claim subordinated to that of other private investors.

¹¹⁷ UNESCAP: Public private partnerships : A financier's perspective, 2009, P.31.

¹¹⁸ Yescombe, E.R: Principle of project finance. UK, 2002.

¹¹⁹ Irwii, Tinmotliy: Public money for private infrastructure, deciding when to offer guarantees, output-based subsidies, and other fiscal support. working paper No.10, the World Bank, Washington D.C, 2003.

¹²⁰ Fishbein G, Babbar S: Private financing of toll roads. Discussion Paper Series No. 17. World Bank, Washington, D.C, 1996.

¹²¹ Zimmermann, Josef: Project delivery systems. Lecture Notes, Lehrstuhl für Bauprozessmanagement der TU München, 2013.

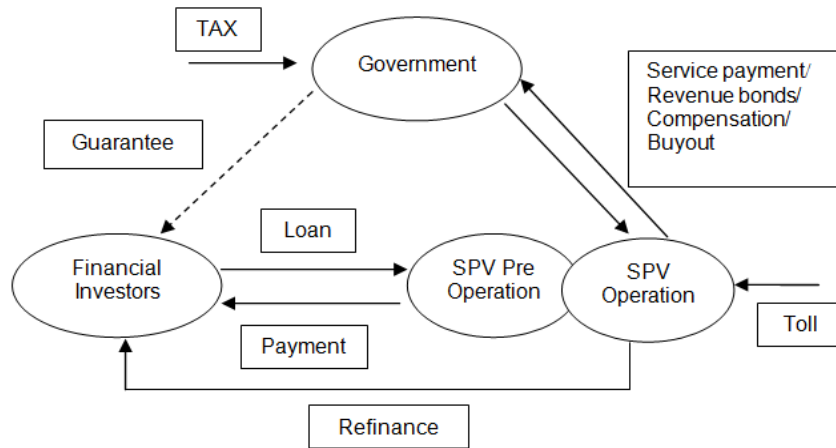

Figure 2-16: Publicly assisted PPP financing model¹²²

Other possible methods to support the PPP could be in the form of a land grant. This happens when the government decides to transfer some of the existing state owned land required to the SPV as part of the initial capital grant. It also relieves the burden of the SPV to acquire land from the government and other private land owner at the same time. Alternatively the land can be transferred in exchange for a portion of the future revenue to be collected. The government claim to future revenue is securitized by the SPV and sold off to another private investor. The sale proceeds will then be given to the government. Although the government receive the sale proceed, the government essentially is still financing the PPP. The financial support offered by the government also raises the question if there is adequate risk transfer from the public to private sector.

Typically once the PPP project is completed, a supplemental agreement will be signed between the public and private sector. This agreement will dictates among others the revenue sharing agreement in the event that the traffic projection is very optimistic and extra revenue is generated on top of the required return by the SPV. However, it may also be in a form of additional financial support to reduce operation risk in the form of revenue shortfall incurred by the private sector. This additional support is used by the private sector to obtain a better refinancing offer from the banks or private investor since once the project is completed the operational risk is lower as compared to the construction risk.

In the supplemental agreement, the government may provide revenue guarantee to the SPV in the event that the revenue forecast does not materialize. The government will top up the difference to meet the financial obligation of the private sector due to the revenue shortage. Sometimes a compensation clause may be included in the agreement as revenue subsidy. This usually happens when the government does not allow the increment of toll rate after the time interval stipulated in the agreement as part of the adjustment for external factors like inflation. The governments of the developing countries usually defer toll rate adjustment due to economic crisis and the need to protect the public interest from sudden increase in cost of living. In this regard, the government will compensate the SPV with the scheduled toll rate revision based on the actual traffic, in the case of toll roads, less the actual tolls collected. Government may also consider the extension of the concession to provide the additional revenue for the SPV to cover its debt obligation. The extension of concession was criticized for shifting the burden to future

¹²² Previous reference.

generations of user and the non-responsible behavior of the government when selecting PPP as the mode of delivery during the feasibility stage.

The private investors normally demands a higher rate of return from private entity as compared to the government borrowing due to the higher perceive default risk. Hence, in order for the SPV to get a more favorable loan from financial institution, the government may provide a debt guarantee to the private investor. This is seen as shifting some risks back to the government. There may be cases whereby due to liquidity issue in the finance sector where credit is not easily available or required a very high interest rate. The government may then provide a loan to the PPP at a slightly lower market rate and at the same time issue bonds to the general public at an attractive interest rate higher than the prevailing fixed deposit rate but lower than the base lending rate of commercial banks. It is arguable that the government is in the best position to act like a bank in providing finance to the PPP while at the same time plays a big role in helping the SPV to secure a favorable loan terms.

Figure 2-17 below shows the financial risk potential for the different type of financial support given by the government to the private sector. The higher the financial exposure held by the government the easier it is for the private sector to obtain financing.

There are mainly eight categories of government financial support given to SPV :¹²³

- **Equity Guarantees:** This kind of guarantee gives the Project Company the right to sell the project to the government with a guaranteed minimum return on equity.
- **Debt Guarantees:** Under this guarantee, government provides a full guarantee or a cash-flow deficiency guarantee for repayment of debt.
- **Exchange Rate Guarantees:** Fluctuation of currency can create significant impact on project which involved foreign capital: By the guarantee, government compensates the Project Company for increases in local cost of debt service due to exchange rate movements.
- **Grants and Subordinated Loans:** Government can help in enhancing project economics by providing non-repaying grants or subordinated loan. Subordinated loan will be repaid to government after the senior loan. At such time, project would normally be in the relieved financial stage.
- **Shadow Tolls:** In this system, government, instead of users, pay a specific annual payment to project company. The shadow tolls can be made into several rates depending on demand volume, such as declining schedule rate.
- **Minimum Revenue Guarantee:** Government will compensate to the Project Company in cash if revenue falls below a specified minimum level. This is the common type of support in PPP project.
- **Concession Extensions:** Government may give right to the Project Company to extend the concession term if revenue falls below a specified level. This type of support give less

¹²³ Fishbein, G. & Babbar, S.: Private financing of toll roads. RMC Discussion Paper Series 117, the World Bank, Washington D.C, 1996.

financial exposure to government, but also give less efficiency in easing financial status of project.

- **Revenue Enhancements:** Government normally enhances project revenue by limiting competition, tax reduction, facilitating demands, or allowing development of ancillary facilities.

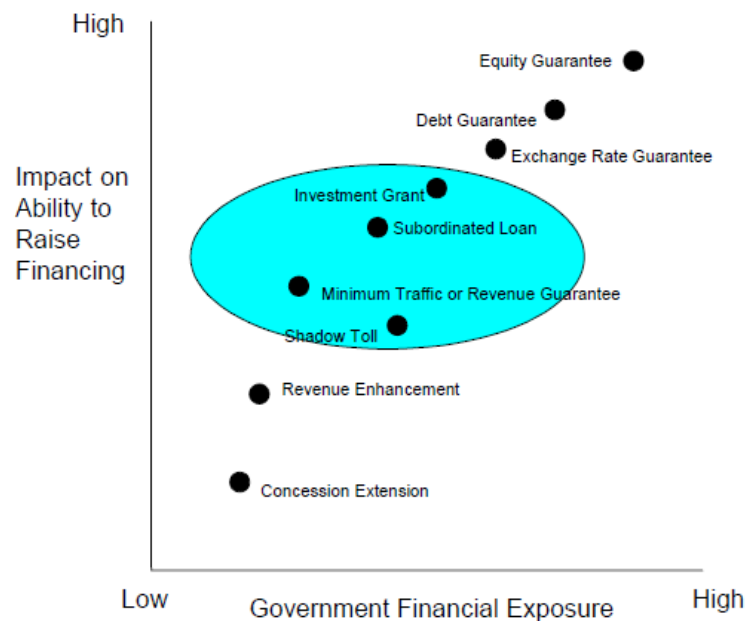

Figure 2-17: The government financial exposure and the ease of raising finance for the different government support¹²⁴

Thus, the government is now exposed to more risk compared to an ideal PPP financing model. The Project Company will in return give a claim to the future toll revenue for the government's loan contribution. The government can securitize this toll income as revenue bonds by using the Project Company to sell it to the financial investor when the construction is completed. The financial institution will be willing to refinance the original loan and the current revenue bond if the perceived risk is now lower in the operation phase. The proceeds of the refinance can be returned to the government. Although this model of financing entails more risk exposure for the public sector, the tax payers money are return back to the government during a shorter time frame (See Figure 2-18).¹²⁵

¹²⁴ Previous reference.

¹²⁵ Zimmermann, Josef: Project delivery systems. Lecture Notes, Lehrstuhl für Bauprozessmanagement der TU München, 2013.

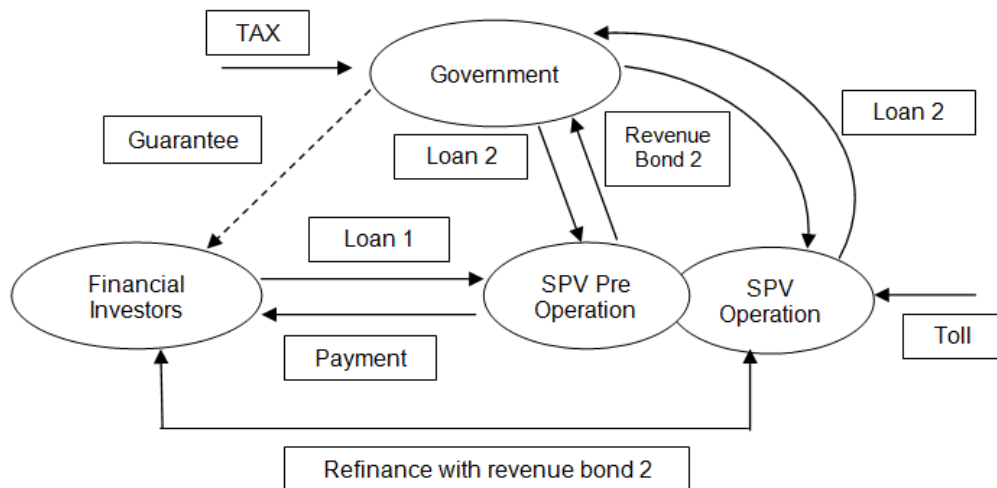

Figure 2-18: High risks PPP financing model¹²⁶

2.2.6 PPP Financing Models in Germany

After the union of Germany in 1990 the need for reparation, expansion and modernization of the infrastructure grew while the financial resources were short. Up until 1999 it was possible for the municipalities to carry out own investments through special investor and leasing models to a lower interest rate than normal public credit conditions because of special depreciation rules. After the abrogation of these rules the financial advantages of the collaborations decreases. Motives like shorter realization time and the fact that the payment of PPP does not start before the operation phase begins, also called “as-you-earn”, are dominant. While it is often focused on the extensive preliminary investigations and out-put specification the planning time and effort on the public side is lesser than by traditional models since the private part delivers a full packet solution.¹²⁷

In 2013, Germany has about 187 public-private partnership projects, 173 building construction projects with an investment amount of 5.021 Million Euro, and 16 highways projects with an investment amount of 2.438 Million Euro. For the period 2010-2015 the federal ministry of finance set an objective for 14 billion EUR for new PPP projects.¹²⁸ Moreover, the investment volume in 2013 in public-private partnerships in the construction and civil engineering in Germany is around 117 million Euros as shown in Figure 2-19.

¹²⁶ Previous reference.

¹²⁷ MVBS: PPP im öffentlichen Hochbau, Band IV, Berlin, 2003, P. 4.

¹²⁸ ÖPP-Projekt Datenbank : ÖPP-Projekte mit Vertragsabschluss im Hoch- und Straßenbau – Investitionsvolumen Hoch- und Straßenbau, 2013.

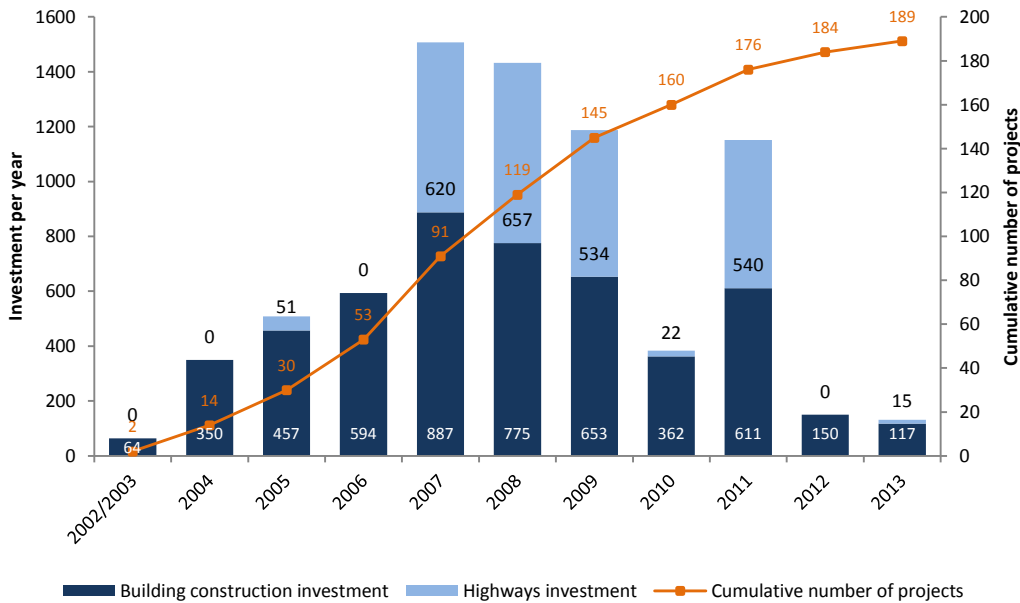

Figure 2-19: Number PPP project and investment in Germany (2002-2013)¹²⁹

In Germany there is generally made a distinction between 1st and 2nd generation PPP. In the first years of PPP in Germany, models only with the elements of build and finance whereas the public part handles the operation were used. These 1st generation models and projects fall under the category PPP light, 2nd generation PPP model ideally contains at least four of the five life-cycle elements hereunder considerable operation elements. 2nd generation projects are sometimes also called “real” PPP projects or “PPP imengeren Sinn”.¹³⁰

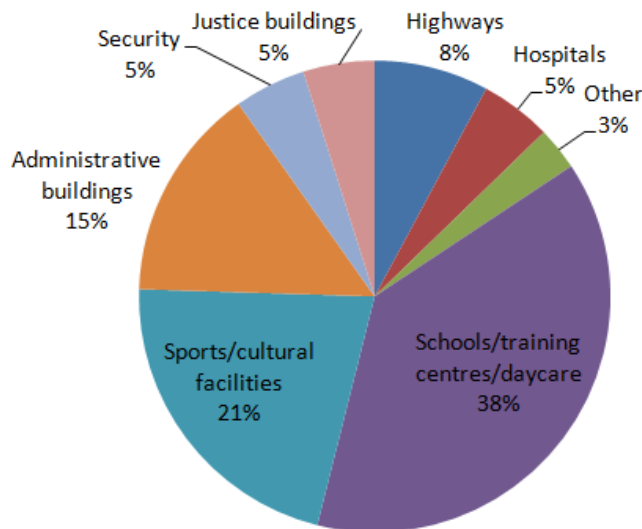

Figure 2-20: PPP in public construction works in Germany 2013¹³¹

¹²⁹ ÖPP Deutschland AG: Überblick zu ÖPP-Projekten im Hoch- und Tiefbau in Deutschland, Partnerschaften Deutschland, 2013, S. 4.

¹³⁰ Deutsches Institut für Urbanistik (Difu) : PPP und Mittelstand, Berlin, 2008, P. 7.

¹³¹ Previous reference.

It is estimated that the German PPP market now is partially transferred into the 2nd generation.¹³² There are four main PPP models in Germany relevant in this context, set up by national PPP Task Force in 2003, as part of the standardisation of PPP. The four models are:¹³³

- PPP-Erwerbermodell
- PPP-FMLeasingmodell
- PPP-Vermietungsmodell
- PPP-Inhabermodell

The four models differ primarily in ownership and in the element of transfer¹³⁴. The private part operates the facility including facility management, possibly including delivering services in reference to level 4 and/or 5 (See Section 2.1.7). In a PPP-Erwerbermodell the private part is obligated to sell (transfer) the facility to the public part to a fixed price included in the contract. In a PPP-FMLeasingmodell and PPP-Vermietungsmodell the private part is not in advance obligated to transfer the facility at the end of the contract period, but the public part may have a favourable buying option. In the PPP-FMLeasingmodell the public is offered to buy to an ex ante residual value, whereas the price is set after the current market value in the PPP-Vermietungsmodell. The buying option is almost always made use of in the PPP-FMLeasingmodell, but only as an exception in the PPP-Vermietungsmodell.¹³⁵

Internationally these types of models are often called BOT models (Build-Operate-Transfer) or BOO (Build-Operate-Own) if the private part stays owner, even though they contain more aspects. In the PPP-Inhabermodell, the public part is owner of the facility during the contract period and is also called a BTO model (Build-Transfer-Operate).

The PPP-Contracting model only concerns specific technical installations.¹³⁶ The different models are most often adjusted to the project at hand. When the project involves the transfer of a public service the models can also be called Betreibermodelle (Operator model).¹³⁷

The way of naming models with capital letters of the elements will not be used further in this context, because of a generally inconsistent and unclear use. Above is the Transfer in the model naming only concerned the transfer of ownership.

The Erwerbermodell, or Purchaser model, is roughly said a combination of the erection of a new building and the sale of this building after an operating period of typically 20-30 years, hence the name. During the project phases the private part undertakes the risks of planning, building, and operating. The public part typically undertakes the risk of destruction or deterioration and of price variation from the beginning of the operating phase. Some of these risks are though returned to the private part through the handling of facility management if the price trend on materials and salary is factored in on the remuneration. It can though also be decided that the risk of destruction or deterioration and of price variation is not transferred to the public part before the end of the contract period. The public part undertakes the risk of transferring, i.e. the risk of a cost effective operation after the transfer.

¹³² PPP Conference: Führungskräfte PPP, München, 2007.

¹³³ Zimmermann, Josef : Project delivery systems, Lecture notes, Lehrstuhl für Bauprozessmanagement der TU München, 2013.

¹³⁴ In a model with Transfer before the operating phase, it is sometimes seen as a model without the element of transfer.

¹³⁵ BMVBS: PPP im öffentlichen Hochbau, Band II, Berlin, 2003.

¹³⁶ BMVBS: Erfahrungsbericht ÖPP in Deutschland, Berlin, 2007, P. 35.

¹³⁷ OBB: PPP zur Realisierung öffentlicher Baumassnahmen in Bayern, Teil 1, München, 2006, P. 12.

The FMLeasingmodell is a combination of the provision of a building through leasing and facility management like in the Erwerbmodell, also for 20-30 years. The remuneration is calculated based on partial amortisation of the investment costs. Because of the leasing conditions the risk of destruction or deterioration and of price variation is by the private part. Only if the public part makes use of the buying option they undertake the transferring risk. It is possible instead of buying the facility to prolong the leasing period.

The Vermietungsmodell is like the FMLeasingmodell only here the conditions relate to rental conditions. The remuneration is calculated based on the usual market rent of similar facilities and on the operating costs. Only in exceptional cases the public part makes use of the buying option and only then the risk of transferring is by the public part.

In an Inhabermodell a private partner renovates and operates a building owned by the public partner. The private part receives reimbursement in rates for covering the needed investment and operating costs. The Inhabermodell is similar to the Erwerbmodell, but the transfer takes place before the operating phase and the public part is owner of the facility during the contract period. The private part is admitted user and possessor rights and is thus allowed to make decisions concerning the operation and facility management. In case of renovation the public part stays in possession of the facility. The risk allocation is also similar to the Erwerbmodell but the private part also undertakes the sanitation risk. The contract period is typically 15-20 years, but can be longer, possibly through a "sale-and-lease-back".¹³⁸ The Inhabermodell financed through the forfeiting model is the most common model in Bavaria, also because there with this model are possibilities of subventions. Standards to this model are also worked out.

The ownership relation is important in the matter of tax and VAT issues. Not only the ownership during the contract period but also the ownership after the contract period is important. If the private part owns the facility after the contract period, the private part will want to have big influence on the functions of the facility and its possibility of alternative applications.¹³⁹ The ownership after the contract period also affects which financing model is preferred.

As the use of PPP increases the involvement of small and medium enterprises (SME) becomes a political subject. Where the public-sector building trade in Germany is because of the federal system and the local self-governance characterized by many smaller projects and the building sector consists as a result of many small and medium enterprises (SME). These SME's also wants to be a part of PPP, not just as subcontractors but also as main contractors. A schematic overview of the models is shown in Table 2-8.

Moreover, the life-span and the extent of the contract in PPP is often beyond what is normal in the projects of SME's, which is characterized by many short-termed contracts with many different clients. Especially big PPP projects with project financing favours larger companies, as it requires a large amount of equity.¹⁴⁰

In Germany, since 2009 there is a new law to ensure the possibility of participation of smaller and mid-size building companies in public procurement contracts. This law directs that procurement projects need to be divided in parts with suitable size not only for bigger companies.¹⁴¹

¹³⁸ BMVBS: Erfahrungsbericht ÖPP in Deutschland. Berlin, 2007.

¹³⁹ EBST: Vejledning om OPP til bekendtgørelse om OPP, partnering og nøgletal, Copenhagen, p. 9.

¹⁴⁰ Jensen, Jesper Ole: Development of PPP in Germany. Draft, Copenhagen, 2005, 2007, p.15.

¹⁴¹ BECK, Benedikt : PPP in Sweden and Germany: A comparison. Bachelor thesis, Department of Real Estate and Construction Management, Real Estate Economics, 2010.

		I. PPP-Erwerbermodell	II. PPP-FMLeasingmodell	III. PPP-Vermietungsmodell	PPP-Inhabermodell
Elements		Design, Build, Operate, Transfer and Finance	Design, Build, Operate, Transfer/Own and Finance	Design, Build, Operate, Transfer/Own and Finance	Design, Build, Transfer, Operate and Finance
Contract time		20-30 years	20-30 years	20-30 years	15-20 years (or longer)
Remuneration		("Purchase price"-) Rates for investment cost, facility management and purchase of the facility	("Leasing"-) Rates for (part of) the investment costs and for the facility management	("Rent"-) Rates for using the facility (rent) and for facility management	Rates for the investment costs and facility management
Special characteristics		The private part owns and operates the facility. An obligatory transfer is part of the contract	Leasing conditions. The remuneration is calculated based on partial amortisation of the investment costs	Renting conditions. The remuneration is calculated based on the usual market rent of similar facilities and on the operating costs	Similar to the Erwerbermodell, but with the public part as owner. Possibility of "sale and lease back"
Transfer		Private part obligated to transfer the facility to the public part	No obligation of transferring. The public part is presented with a buying option to an ex ante calculated residual value	The public part is presented with a buying option to the current market value	The public part owns the facility during the contract period. In case of new build, the transfer takes place with the completion
Risks	Private part	Risk of the D, B, and O phases (Risk of destruction or deterioration and of price variation)	Risk of the D, B, and O phases, risk of destruction or deterioration and of price variation, (Transfer risk)	Risk of the D, B, and O phases, risk of destruction or deterioration and of price variation, (Transfer risk)	Similar to Erwerbermodell. Besides the building risk also the sanitation risk
	Public part	(Risk of destruction or deterioration and of price variation), Transfer risk	(Transfer risk)	(Transfer risk)	Similar to Erwerbermodell.

Table 2-8: Description of PPP-models in Germany¹⁴²

¹⁴² On the basis of BMVBS: PPP im öffentlichen Hochbau, Band II, Berlin , 2003, P. 20

Because of the difficulties of dividing PPP contracts which would be against the basic sense of this kind of contracts. "Mittelstandinitiative" has been launched in order to improve the financing possibilities for SME's. However, there is a special bank, KfW-Mittelstandbank, which provides economical support for middle-sized projects with a contract volume up till 6.7 Million Euro. These means can also be applied for by both the municipality and the private part in a PPP project. Other initiatives like involvement of local SME in the start-up, provision of information through workshops or the like or contractual adjustments are suggested. In Bavaria region a special guide is developed considering main aspects concerning "real" PPP and SME's. Possibilities for establishment of information memorandum, modification of the weighting in the evaluation tool (PSC), exit clauses, appropriate financial safety requirements and adjustment of corporate structure to the life-cycle approach of PPP are pointed out.¹⁴³

On November 2008, the ÖPP Deutschland AG ("Partnerschaften Deutschland" or Partnerships Germany) was founded as an independent advisory undertaking with a unique pool of public and private PPP know-how. ÖPP Deutschland AG exclusively advising the public sector on projects which can be implemented efficiently within the PPP framework. The main target of the unit is to significantly extend the market for PPP in Germany. Moreover, ÖPP Deutschland AG itself is set up as a PPP project as seen in Figure 2-21.

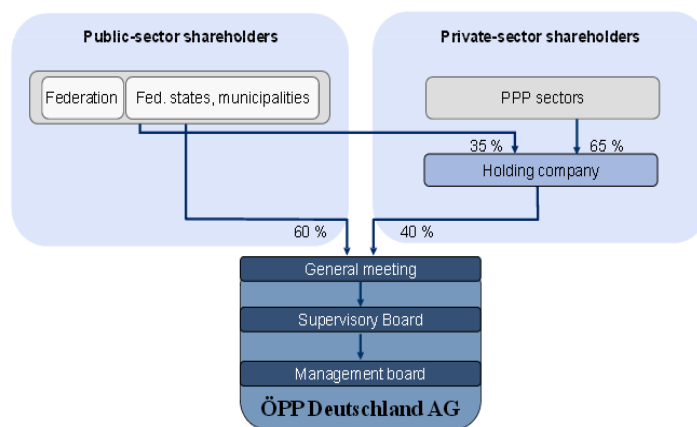

Figure 2-21: Organization and ownership structure of ÖPP Deutschland AG¹⁴⁴

ÖPP Deutschland particular advisory approach is based on implementing experience in foundation work gained from projects (e.g. further development of standards, distribution of market recommendations for the simplification of PPP processes). The business activities of ÖPP Deutschland are focused on advice in the early phases (financial adviser) of actual PPP projects. The spectrum of ÖPP Deutschland's services will extend beyond these as business adviser during the whole life cycle of a project.¹⁴⁵ The German experiences show that PPP primarily is used in larger cities and municipals with more than 100.000 citizens, whereas municipalities with 10.000-20.000 citizens have very little experience with PPP.¹⁴⁶ Moreover, market structure of PPP in Germany is shown in Figure 2-22.

¹⁴³ OBB: PPP zur Realisierung öffentlicher Baumaßnahmen in Bayern. kleine mittelstandsfreundliche PPP-projekte, München, 2007.

¹⁴⁴ Federal Ministry of Finance Germany

¹⁴⁵ ÖPP Deutschland AG : The market for Public-Private Partnerships in Germany, 2008.

¹⁴⁶ Deutsches Institut für Urbanistik (Difu): PPP – eine aktuelle Bestandaufnahme in Bund, Ländern und Kommunen, Berlin, 2005, P. 37

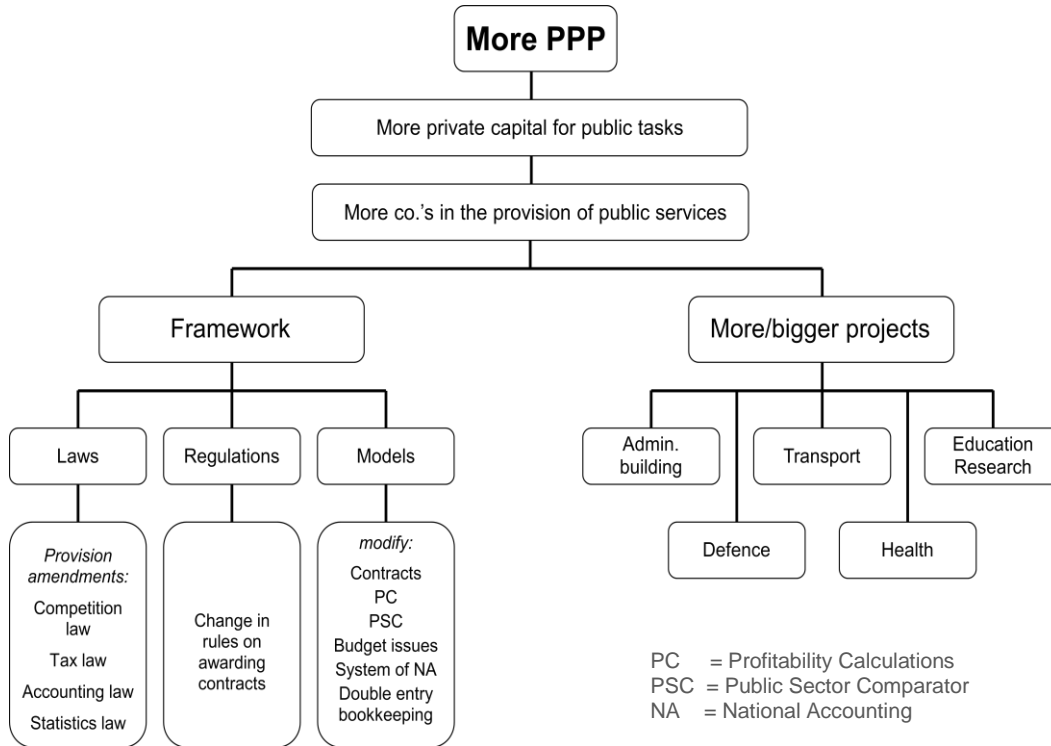

Figure 2-22: Market structure of PPP in Germany¹⁴⁷

In Germany, In spite of the focus on and interest in PPP there is still skepticism towards the PPP model. Some of the barriers towards PPP are listed in Figure 2-23.

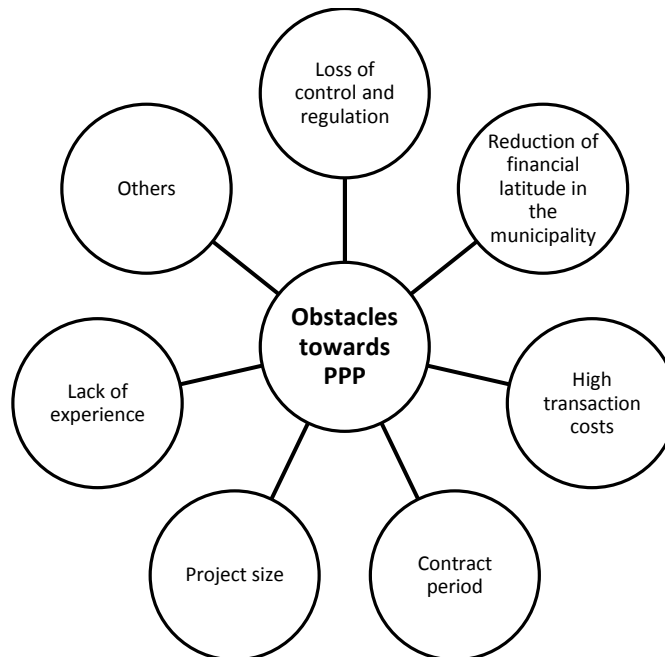

Figure 2-23: Obstacles towards PPP in Germany

¹⁴⁷ ÖPP Deutschland AG : The market for Public-Private Partnerships in Germany, 2008.

The fear originates in the transferring of competence in connection with the risk transfer and in the lack of experience with contract controlling. The obligation of payment is by some politicians seen as a reduction of political prioritizing possibilities in the financial latitude. According to a German consultant on PPP, PPP merely sets the public part under compulsion, because they in PPP don't have the right to let a building dilapidate and instead use the money elsewhere. It is under all circumstances necessary for the municipality to clarify whether or not it is able to pay for the services throughout the contract period. It is also a question if the municipality is willing to hand over the responsibility for the completion, operation and maintenance of a building to a private part and trust them to make the right decisions and vice-versa.¹⁴⁸

The design phase with awarding procedure and the preceding phase with preliminary investigations are extensive and because of lacking standards and experiences it is leading to higher transaction costs. If the project is financed through project financing the due diligence for the entire project contributes to the transaction costs. But through a thorough development phase the needs and requirements are determined and that can finally lead to a better facility and a better operation and facility management. By focusing on the out-put instead of a lot of other things, it is possible to modernize the public sector. As mentioned earlier it can be discussed how the transaction costs are interpreted and how parts of what generally are seen as transaction costs can be characterized as risk costs. A clear risk transfer is costly as it is also costly to have the risk portfolio verified by a bank through the due diligence. These are all risk costs, costs that in traditional projects are not exposed until later in or at the end of project. Moreover, the size of the transaction costs relative to the project size makes the municipalities sceptical towards the PPP model.¹⁴⁹

However, most of the problems in Germany with PPP projects occurred through late changes in the contract and the plans, partly after the construction phase. This kind of flexibility costs money, of course, and enables the intention of output specification for PPP-projects to gain desired efficiency advantages. Accordingly such interventions cause discussions in the public about efficiency of PPP projects. As well detailed analysis and planning are essential. For example, at the Herrentunnel project in the city of Lübeck (2005), there was average utilization of only 20,000 cars a day; while the planed was 37,000 cars a day. This description of course affects the profitability of the private partner. Often in this situation former partners, the public sector and the private consortium, become opponents.¹⁵⁰

Generally the arguments can be seen both ways. The transfer of responsibility and control to the private part makes the public part focus on the needs and the outcome from the start. Thereby the building is not delayed because of many adjustments during the building process, but at the same time it will reduce the freedom for the public part. The same is in evidence with the financial binding and the long contract period. It is therefore to be evaluated in each case which arguments win. In Germany some of the barriers are overcome because of more experience on the area, especially with smaller projects using the forfeiting model of financing. Some of the barriers are though still present. It is therefore vital to learn from experiences, good as bad.

¹⁴⁸ Ulf Gjendal: Public Private Partnerships in Denmark and Germany. Master thesis, Lehrstuhl für Bauprozessmanagement der TU München, 2008.

¹⁴⁹ Previous reference.

¹⁵⁰ BECK, Benedikt: PPP in Sweden and Germany: A comparison. Bachelor thesis, Department of Real Estate and Construction Management, Real Estate Economics, 2010.

2.2.6.1 PPP Light

The concept of PPP light is arisen with projects containing elements of PPP, whereas the public part handles the operation. The financing part only concerns the investment costs as the operation phase is not included in the project. In Germany typically the transfer of certain risks to the private part in the development and building phase, but without the transfer of the long-termed operation phase with appertaining risks. Especially for municipalities it can be difficult to cope with the often big and complex “real” PPP models with full risk allocation, project financing and a long contract period.

In Germany the municipalities are intent on exploiting some of the advantages of a closer relationship with the private sector. It has led to the use of slimmer models, the PPP light models. As described previously, there are some obstacles and reservations against the full PPP model, the number of suitable projects and the fear among the politicians of losing control in particular. That makes politicians in Germany more interested in lighter versions of collaboration forms, at present the relatively new collaboration form combined offering. In Germany a broader spectrum of PPP models are considered and used. The term of PPP light is also used about much less comprehensive collaboration forms.

The PPP light model is in Germany also called the Aachener modell, named after the Nordrhein-Westfalen district Aachen, which was the first to use this type of model.¹⁵¹ This model is too far from the central idea of PPP in this thesis because of the missing life-cycle view of the project. The Aachener modell is rather a financing model than a partnership model in the sense of PPP.

2.2.6.2 Forfeiting Model

In Germany, the use of the so-called forfeiting model is the overriding financial model for PPP in Germany, where long-termed receivables of the operation phase are forfeited to the bank (financier), is also used. In the forfeiting model, there is made a “Forfaitierung mit Einrede-, Einwendungs- und Aufrechnungsverzichtserklä -rung”. With PPP projects it means that the private part sells parts of the receivables of the project to the bank.¹⁵²

Through the forfeiting the bank undertakes the economical risk of the forfeited receivables and carries thereby the risk in case of suspension of payment. Here, the private part is though still responsible in a legal point of view for the fulfillment of the contract. The public-like financing conditions, which are the main reason of using the forfeiting model, can then only be obtained if the public part signs a non-recourse forfeiting of installments. In this way the public part guarantees the loan. The non-recourse declaration can be one-sided, it can include the private part or the bank or it can be made through a third party.

To prevent a reduction of contract law and legal status of the bank and the private part, the public part ought to, at least for the sake of clarity, determine in the contract, which laws are still applicable to the private part. A third party including both the bank and the private part will secure the best legal rights of the public part.¹⁵³

¹⁵¹ Proll, R. Uwe; Drey, Franz: Die 20 Besten: PPP-Beispiele aus Deutschland, Köln, 2006, P. 19ff.

¹⁵² Dirk Daube, Susann Vollrath, Hans Wilhelm Alfen (2007): A comparison of Project Finance and the Forfeiting Model as financing forms for PPP projects in Germany, International Journal of Project Management 26 (2008) 376–387.

¹⁵³ Task Force NRW(2004): PPP im Hochbau, Finanzierungsleitfaden, Nordrhein-Westfalen, p. 50-51.

Because of the public guarantee towards the bank no equity investment is requested from the private part and a due diligence for the entire project is not made. The bank still carries out a credit assessment but it only concerns the building phase. The financial costs are considerable lower than with project financing since a loan with a public guarantee in 25-30 years is possible with a very low interest rate. As a result it is possible to finance small PPP projects.¹⁵⁴

The forfeiting model is in spite of that criticized for not transferring the financial risk fully to the private. The bank does not prove the risk structure and doesn't have the same controlling measures so the public part has to evaluate the economic viability in the project, through internal or external consultants¹⁵⁵. It is important when the public part signs the non-recourse declaration.

In the 1st generation model "Morgendorfermodell" the investment costs are also forfeited which means that the public part is economic liable for the building phase, for instance if the completion of the building is delayed. This model is, though, not advisable and it is recommended that the non-recourse declaration is not signed until after a successful trial period. That means that the private part is financial liable for the building until then. The result is a shorter building period and thereby lower costs. In PPP project with forfeiting only the receivables of the investment costs are forfeited and the public part still has financial sanction possibilities towards all other parts of the contract than the investment costs.¹⁵⁶

In the forfeiting model there can be made a distinction between two forms; "real" and "not-real" forfeiting. With "real" forfeiting the private part is only liable for the arise and constancy of the facility, but in a "not-real" forfeiting the private part is also at least partly liable for the commercial/profitable usability of the forfeited receivable.¹⁵⁷ The forfeiting can be used in connection with an "Inhabermodell" with the public part as owner of the facility also during the contract period or in an "Erwerbermodell" where the transfer is part of the contract. A private project company is not necessarily founded in PPP projects. From the public side it is also not important, as long as the same safeties can be offered.¹⁵⁸

Figure 2-24 shows the structure of financing in the forfeiting model. The dotted line shows the element of user payment. A project can include a concession, i.e. where the private part gets the right to collect charges or fees from a third party user (the citizens) and thereby also takes the risk of a profitable operation. It brings along other aspects and will not be treated further here. The grey boxes illustrate the private part in the design-build phases (D+B) and the operating phase (O) respectively.

¹⁵⁴ Jensen, Jesper Ole (2007): Development of PPP in Germany, Draft, Copenhagen, p. 14.

¹⁵⁵ OBB (2006): PPP zur Realisierung öffentlicher Baumassnahmen in Bayern, Teil 2, München, p.14

¹⁵⁶ Ulf Gjendal: Public Private Partnerships in Denmark and Germany. Master thesis, Lehrstuhl für Bauprozessmanagement der TU München, 2008.

¹⁵⁷ OBB: PPP zur Realisierung öffentlicher Baumassnahmen in Bayern, Teil 2, München 2006, p. 9.

¹⁵⁸ Ulf Gjendal: Public Private Partnerships in Denmark and Germany. Master thesis, Lehrstuhl für Bauprozessmanagement der TU München, 2008.

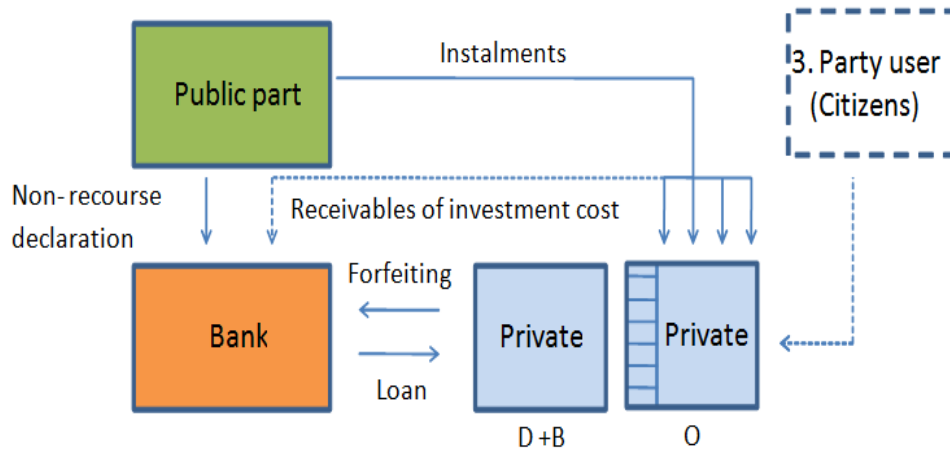

Figure 2-24: Financing in Forfeiting model¹⁵⁹

The payment of services starts when the building is set into use. In the forfeiting model, the bank lends the money for the investment costs to the private part, but the public part is through the non-recourse declaration obligated to pay it back during the contract period. The public part still pays the private part for the services, the covering of investments cost is simply not included in this payment.

In the forfeiting model, lower bank interest margins can be offered and financing banks can provide financing conditions at a reduced rate as can be seen in Figure 2-25 below.

	Project Finance	Forfeiting Model
Interest reference rate	<ul style="list-style-type: none"> The interest rate is base for each financing form and its height is equal for all 	
Risk-related financing costs	<ul style="list-style-type: none"> Substantial risk transfer Includes insolvency risk of the SPV Due Diligence costs because of the project's complexity 	<ul style="list-style-type: none"> Lower extent of risk transfer Does not include insolvency risk of the SPV No Due Diligence made

Figure 2-25: Composition of financing costs¹⁶⁰

¹⁵⁹ Previous reference.

¹⁶⁰ Dirk Daube, Susann Vollrath, Hans Wilhelm Alfen: A comparison of Project Finance and the Forfeiting Model as financing forms for PPP projects in Germany, International Journal of Project Management, Vol. 26, 2008, P.376–387.

Moreover, Figure 2-26 shows advantages and disadvantages of the two financing models project finance and the forfeiting model.

Project Finance	Forfeiting Model
Advantages	
<ul style="list-style-type: none"> • Adequate allocation of risks according to the risk management competence of the partners • Insolvency risk taken by the lender (Step-In-Rights) • Early evaluation of the projects' viability by the lender (due diligence) • Monitoring and controlling of the project by lenders during the whole contract period • Setting of additional incentives in case of bad performance of the private partner (relating to the construction works) • Equity as additional security and incentive for efficiency 	<ul style="list-style-type: none"> • Lower unitary payment because of lower financing costs • Faster procurement process – no time consuming Due Diligence processes
Disadvantages	
<ul style="list-style-type: none"> • Higher unitary payment because of higher financing costs • Longer procurement process due to time consuming • Due Diligence procedure by lenders 	<ul style="list-style-type: none"> • Intransparency of costs for not transferred risks • Insolvency risk taken by the public principal • No additional evaluation and controlling of the project neither in the forefront of the project nor in the course of the contract period • Less incentives in case of bad performance of the private partner (relating to the construction works) • No additional incentives because of low involvement of equity

Figure 2-26: Advantages and disadvantages of Project Finance and the Forfeiting Model from the public principal's point of view¹⁶¹

¹⁶¹ Dirk Daube, Susann Vollrath, Hans Wilhelm Alfen: A comparison of Project Finance and the Forfeiting Model as financing forms for PPP projects in Germany, International Journal of Project Management Vol.26, 2008, P.376–387.

2.3 Risk in PPP Projects

Risk has different meanings to different people, and the concept of risk varies according to viewpoint, attitudes, and experience. Engineers, designers, and contractors often view risk from a technical perspective, while owners and developers tend to view it from the economic and financial side. Similarly, safety and health professionals take a more hazard impact/mitigation perspective. Risk is therefore generally seen as an abstract concept where measurement is very difficult.¹⁶²

Since the objectives of construction projects are usually stated as targets established for function, cost, time, and quality, the most important risks in construction are the failure to meet these targets.¹⁶³ However, a myriad of risk and risk-related definitions are applied to construction projects, and no standard definitions or procedures exist for what constitutes a risk assessment.

Generally, risk is a concept that is used to express concerns about the probable effects of an uncertain environment and can be characterized by its probability of occurring and the magnitude, or effect, it would have on expected returns or outcomes should it occur as shown in Figure 2-27.¹⁶⁴

Zimmermann *et al.* (2008)¹⁶⁵ described risk as “*Function of knowledge and controllability*”.

With this context knowledge is refers to the definition of the construction plan with the required details of all risky issues and their characteristics in the implementation planning, controllability arises on the enforcement specified in the implementation planning standards.

Cooper, *et al.* (2005)¹⁶⁶ defined risk as “*Exposure to the consequences of uncertainty*”.

In a project context, it is the possibility of something happening that will have an impact upon project objectives. Such risks include the possibility of loss or gain, or variation from a desired or planned outcome. Moreover, risk can be defined as an uncertain event or condition that, if it occurs, has a positive or a negative effect on a project objective. A risk has a cause and, if it occurs, a consequence.¹⁶⁷

Jaffari (2001)¹⁶⁸ defined risk as “*The exposure to loss/gain, or the probability of occurrence of loss/gain multiplied by its respective magnitude*”.

Events are said to be certain if the probability of their occurrence is 100% or totally uncertain if the probability of occurrence is 0%. In between these extremes the uncertainty varies quite widely.

The Project Management Institute (1996)¹⁶⁹ introduced a simple definition for risk as “*Discrete occurrence that may affect the project for better or worse*”.

¹⁶² Raftery, J. :Risk Analysis in Project Management. London: E & FN Spon, 1994.

¹⁶³ Baloi, D. and Price, A.D.F.: Modeling Global Risk Factors Affecting Construction Cost Performance. International Journal of Project Management 21 ,2003, P. 261–9.

¹⁶⁴ UNESCAP: Public Private Partnerships- A Financier's perspective. 2009, p.33.

¹⁶⁵ Zimmermann, Josef, Eber, Wolfgang, Schieg, Martin, Nino, E.: Risk Evaluation in Construction Management, Conference Business and Management , Vilnius/Litauen, www.lbi.bv.tum.de, Veröffentlichungen, Artikel/Vorträge,2008, S.1.

¹⁶⁶ Cooper D., Grey, S., Raymond, G., & Walker, P.: Project Risk Management Guidelines: Managing Risk in Large Projects and Complex Procurements. England: John Wiley & Sons Ltd, 2005.

¹⁶⁷ Office of Project Management Process Improvement: Project Risk Management Handbook. 1st edition, 2003.

¹⁶⁸ Jaafari A.: Management of Risks Uncertainties and Opportunities on Projects- time for a fundamental shift. International Journal of Project Management, 19,2001, P.89-101.

¹⁶⁹ Project Management Institute PMI: Project Management Body of Knowledge. PMI, 1996.

Al-Bahar (1990)¹⁷⁰ defined risk as “*The exposure to the chance of occurrences of events adversely or favorably affecting project objectives as a consequence of uncertainty*”.

This research has adopted the more general and broad definition of risk as presented by Zimmermann *et al* (2008).

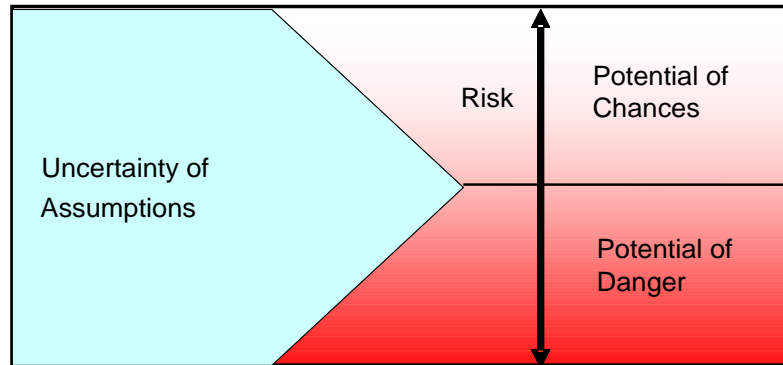

Figure 2-27: Definition of Risk¹⁷¹

2.3.1 Risks in Private Infrastructure

Generally, infrastructure projects have their own characteristics that differ to other sectors. Risk is inherent and difficult to deal with, and requires a proper management framework both theoretically and practically. This is more so for PPP implementation, due to the large project scale, huge capital (some of these projects are even considered megaprojects),¹⁷² long concession period (between 25 and 30 years or even more), complex risk profile and social affect usually associated with PPP projects.

PPP project have been adjudged to be risky. This risk in a PPP relates to uncertain outcomes which have a direct effect either on the provision of the services, or the financial viability of the project. Therefore, according to Zimmermann, development, bidding and construction costs in PPP projects are higher than with traditional public sector procurement. Zimmermann believes that it is controversy that the government is in the best position to act like a bank in providing the annual payment to the PPP, while at the same time plays a big role in helping the private company by providing a debt guarantee to the private investor at a slightly lower market rate or acts like an intermediary with different stakeholders to secure a favorable loan terms.¹⁷³ The advantage of technical or functional interactive ideal solution is in urgent need to compensate for this before generating any benefit. In particular any approach of financing infrastructure projects by the use of PPP contracts is doomed to fail, just shifting expenses on an increased basis to the future generation.¹⁷⁴

¹⁷⁰ Al-Bahar, J., and Crandall, K.: Systematic Risk Management Approach for Construction Projects. ASCE Journal of Construction Engineering and Management, Vol. 116, No 3, 1990, P. 533-546.

¹⁷¹ Zimmermann, Josef: Project Delivery Systems. Lecture Notes, Lehrstuhl für Bauprozessmanagement der TU München, 2013.

¹⁷² Flyvbjerg, B., Bruzelius, N., & Rothengatter W.: Megaprojects and Risk. Cambridge: Cambridge Press, 2008.

¹⁷³ Zimmermann, Josef: Kolloquium Investor - Hochschule - Bauindustrie. Lehrstuhl für Bauprozessmanagement der TU München, 2006.

¹⁷⁴ Zimmermann, Josef and Aljuboori, Omar: The challenges of governing public private partnership in Iraq infrastructure projects. Creative Construction Conference, Budapest, Hungary, 2013.

The main causes of uncertainty of PPP projects can be attributed to the following issues:¹⁷⁵

- Difficulty in achieving predictability of long-term future costs;
- Complexity of the procurement system and its ability to deal with rapid changes in product and process.

In either case the result is a loss or cost which has to be borne by the public or the private partners. Every aspect of a project has risks, and because the future cannot be predicted with certainty, all parties to a PPP must consider a range of possible events that could take place; each of these events potentially having a material effect on the project and its goals. However, it is important for both the public and private sectors to understand the various risks associated with PPP throughout the whole life cycle of the projects (See Figure 2-28). The identification, classification and presentation of a comprehensive list of these risks will provide prospective PPP practitioners with a useful tool during the setting up of successful PPP concession agreements.¹⁷⁶

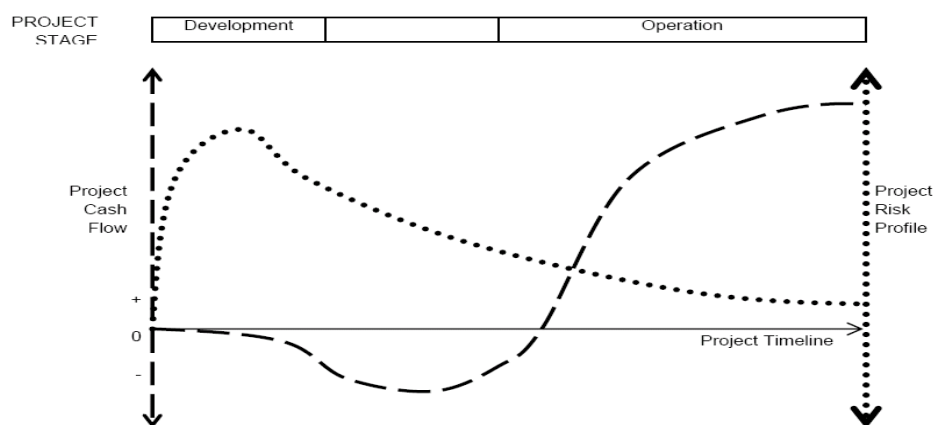

Figure 2-28: Typical risk and cash flow profile of the PPP project¹⁷⁷

On the other hand, Zimmermann and Eber (2014)¹⁷⁸ believed that the considered uncertainties are not risks. In some cases the situation is given and only the knowledge lacks but could be retrieved e.g. by appropriate investigation. In other cases objectively given probabilities are actually required but “true uncertainties” arise from subjectively acquired estimations. Deviations from these can principally not be quantified even if based on experts’ opinions as widely proposed. An inevitable precondition for any probability based risk analysis is the existence of sufficient information taken from the past and describing objects of adequate equivalence or at least similarity. In contrast to e.g. insurance business this is not possible in operative construction or real estate management, not to speak of the operation of infrastructure projects.

¹⁷⁵ Boussabaine, A.: Cost Planning of PFI and PPP Building Projects. 1st edition, Taylor & Francis, New York, 2007, P.261.

¹⁷⁶ A.D. Ibrahim, A.D.F. Price and A.R.J. Dainty: The Analysis and Allocation of Risks in Public Private Partnerships in Infrastructure Projects in Nigeria. Journal of Financial Management of Property and Construction, Vol.11 (3), 2006, P.149 - 163.

¹⁷⁷ Alfen, Hans-Wilhelm, *et al*: Public-Private Partnership in Infrastructure Development- Case Studies from Asia and Europe. Bauhaus-Universität Weimar, Faculty of Civil Engineering, Chair Construction Economics, 2009.

¹⁷⁸ Zimmermann Josef , Eber Wolfgang: Consideration of Risk in PPP- Projects. 8th International Scientific Conference “Business and Management 2014”. Vilnius, Lithuania, May 15-16, 2014.

Fairly heterogeneous circumstances would lead to a multitude of risk classes comprising only very few samples. Thus probabilities derived from such turn out to be highly imprecise and allow for no reliable prediction of results. In the case of PPP projects in fact there are no closed projects available. Due to the inherent long duration of such projects none of them can be analysed as successfully finished.

In principle, the main idea of PPPs is that risk can be minimised, shared, transferred, and managed by the private sector¹⁷⁹. But such a transfer and the degree to which the private sector is ready to assume it sometimes impairs the feasibility of projects. Due to that the lenders tend to be highly risk averse and will turn down even the most socially desirable project if they perceive it to have too many risks – a fact which disappoints and frustrates the public sector. In the UK analysis of Anderson and LSE Enterprise, Ball *et al.* (2003)¹⁸⁰ note that risk transfer accounted for 60 percent of the total cost saving for the PPP projects, and that for six of the 17 cases (i.e. 35 %), achieving value for money was entirely dependent on risk transfer.

2.3.2 Risk Management in PPP

Risk management is an integral part of the PPPs procurement processes and procedures. The whole concept of PPP arrangement is based on an appropriate and clear management of risks and responsibilities, thereby delivering value for money to the client through minimising the potential for future disputes and difficulties of cost overruns. Risk management will not remove all risk from a project, but is aimed at ensuring that risks are efficiently managed and consequently ensuring that the impact of risk is minimised. In this meaning, since risk is always present in PPP, risk management is an important aspect of PPP that should be emphasized during the whole life of the project.¹⁸¹ The risk management process in PPP projects is aimed at achieving the following objectives.^{182 183}

- To demonstrate value for money for decision-makers.
- To facilitate informed and systematic decision making.
- To minimise the consequences of risk.
- To identify all major risks relevant to PPP procurement systems.
- To increase understanding of risk allocation in PPP contracting systems (See Figure 2-29).
- To deliver a robust financial and contractual structure for the project.
- To create a risk management process during procurement and operation of the concession agreement.
- To give an improved understanding of the project through identifying the risks and its response.

¹⁷⁹ Akintoye, A. and Chinyio, E.: Private Finance Initiative in the Healthcare Sector- Trends and Risk Assessment. *Journal of Engineering Construction and Architectural Management*, Vol. 12(6), 2005, P. 601-616.

¹⁸⁰ Ball, R, M Heafey & D. King: Risk Transfer and Value for Money in PFI Projects. paper for Public Management Review, forthcoming, 2003.

¹⁸¹ Alfen, Hans-Wilhelm, *et al.*: Public-Private Partnership in Infrastructure Development- Case Studies from Asia and Europe. Bauhaus-Universität Weimar, Faculty of Civil Engineering, Chair Construction Economics, 2009. P. 35.

¹⁸² Infrastructure Australia: National PPP detailed guidance. Vol. 4, 2008, P.110.

¹⁸³ Boussabaine, A.: Cost Planning of PFI and PPP Building Projects. 1st edition, Taylor & Francis, New York, 2007, P.256.

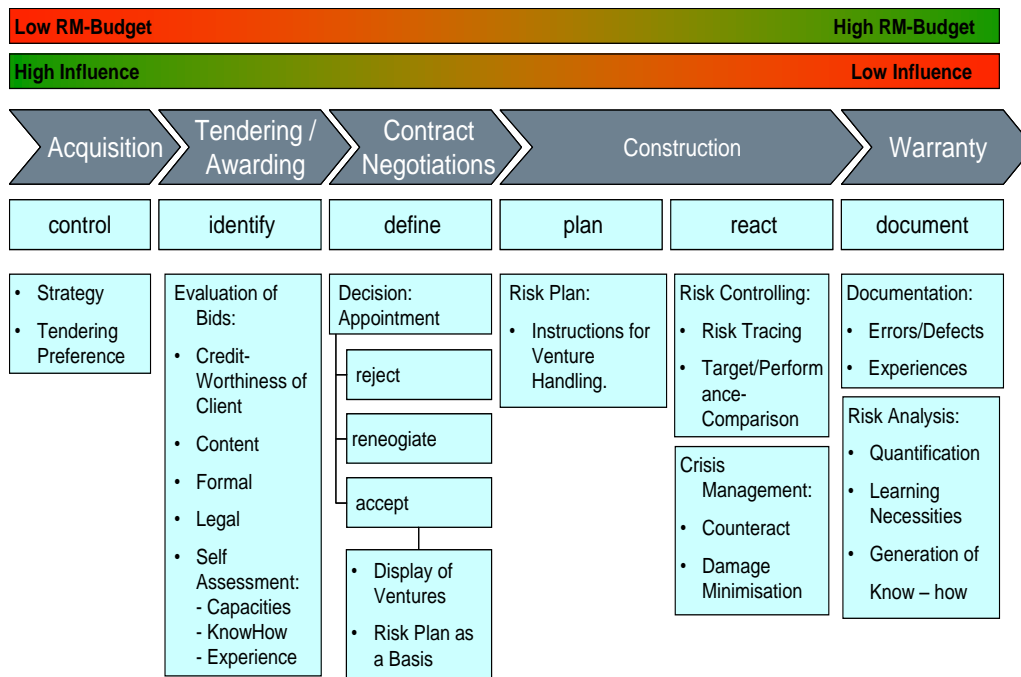

Figure 2-29: Risk Management in business processes¹⁸⁴

Also, an important point to be figured is that the risks ought to be assessed and divided at as early a stage as possible and sufficient resources should be set aside for a thorough risk management. Figure 2-30 visualizes the development of secureness of the construction costs for an infrastructure project. Without making use of any activities no effort is spent on risk management and the expected costs are not obtainable.¹⁸⁵

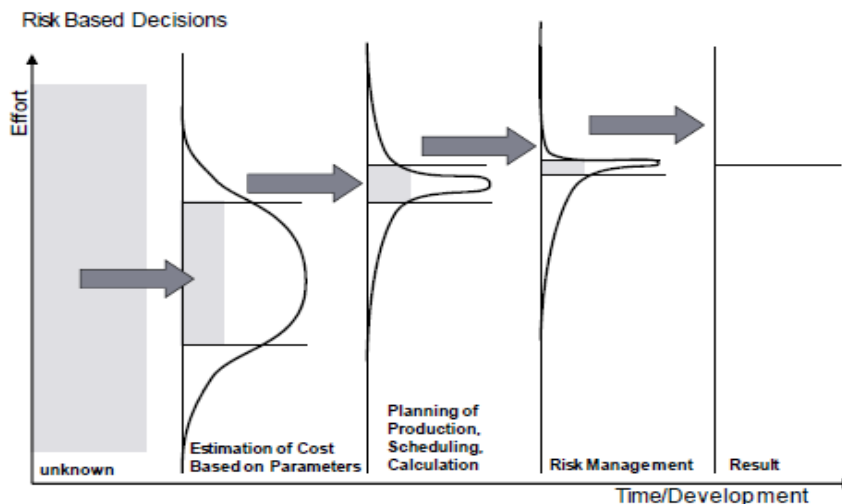

Figure 2-30: Development of Risk in Steps of Risk Management¹⁸⁶

¹⁸⁴ Zimmermann, Josef: Project Delivery Systems. Lecture Notes, Lehrstuhl für Bauprozessmanagement der TU München, 2013.

¹⁸⁵ Zimmermann, Josef, Eber, Wolfgang: Knowledge Based Risk Controlling. 3rd International Symposium on Geotechnical Safety and Risk (ISGSR2011), Munich, 2011, P. 259-268.

¹⁸⁶ Previous reference.

On the other hand, risks and the consequential costs discovered in a late stage of the project are difficult to manage and control as shown in Figure 2-31.

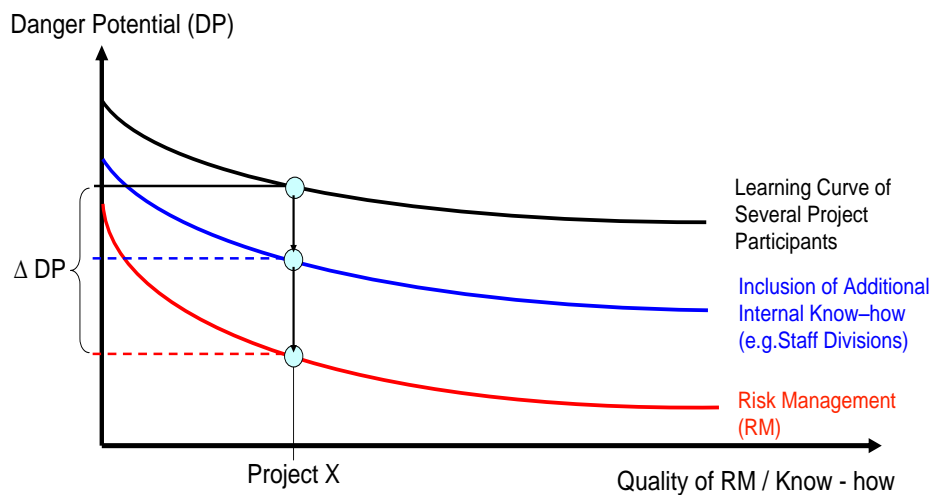

Figure 2-31: The effect of Risk Management¹⁸⁷

There are four guidelines for project risk management that are used extensively by professional organizations as listed below:¹⁸⁸

- Project Management Body of Knowledge (PMBOK): published by Project Management Institute (USA) (PMI, 2004).
- Project Risk Analysis and Management (PRAM): published by Association for Project Management (UK) (APM, 2000).
- Risk Management AS/NZS 4360 Standard: published by Standards Australia/ Standards New Zealand (Australia/New Zealand) (SA/SNZ, 2004).
- Management of Risk (MoR): published by UK Office of Government Commerce Management / HM Treasury (HM Treasury, 2004a).

The above resources for risk management guidance work relative to different versions of the project risk management process, but each has intrinsic value, and they do not conflict with each other.

A number of variations of risk management process have been proposed. Boehm (cited in Raz & Michael, 2001) suggested a process consisting of two main phases: risk assessment, which includes identification, analysis and prioritization, and risk control which includes risk management planning, risk resolution and risk monitoring planning, tracking and corrective

¹⁸⁷ Zimmermann, Josef: Project Delivery Systems. Lecture Notes, Lehrstuhl für Bauprozessmanagement der TU München, 2013.

¹⁸⁸ Cooper D., Grey, S., Raymond, G., & Walker, P.: Project Risk Management Guidelines-Managing risk in large projects and complex procurements. England: John Wiley & Sons Ltd, 2005.

action. Wirtsch and Alfen (2009)¹⁸⁹ have suggested four common features in the project risk management processes which last throughout the entirety of the whole life cycle of the project:

- **Risk Identification:** It is the process of identifying all the risks relevant to the project.
- **Risk Assessment:** It refers to determination of the degree of likelihood of the risks and the possible consequence if the risk occurs.
- **Risk Allocation:** Assigning the responsibility of the consequence of the risk to one or more of the parties to the contract.
- **Risk Mitigation:** The process of controlling the likelihood of occurrence of risk and/or the extent of the consequence of the risk.

Many techniques are available for each of these processes, the choice of technique being influenced by the nature of the risks involved and the amount of information available. Clearly, effective communication is a requirement for each of these processes.

2.3.2.1 Risk Identification

It is difficult to generalize the risks inherent in PPP projects as the risk profile of a PPP project varies with a number of factors, including the country in which the project is situated, the type of infrastructure sector, capital budget, construction time, construction cost, operation cost, politics and policies, market conditions, cooperation credibility, and economic environment surrounding the project¹⁹⁰.

Risk factors have to be determined before the risk being allocated, the uniqueness in the risk profile of PPP projects has led to use of risk identification techniques that are based on the knowledge of the experts in the related fields and experience with similar projects. Some of the other risk identification techniques in addition to experience and experts are intuition, checklists, site visits, case studies, brainstorming sessions, allied organizations, databases, and workshops.¹⁹¹

By early identification of potential risks according actions can be taken and the impact can be minimised. The probability of risk occurrence and the magnitude of its impact must be evaluated. The following Figure 2-32 shows the connection between probability of occurrence and risk impact as well as their impact on the company. Risks that are threatening for the existence of the company must not be taken under any circumstances. High risk impacts in connection with high probability of occurrence can have serious impacts on the company and must be avoided.¹⁹²

¹⁸⁹ Alfen, Hans-Wilhelm, *et al.*: Public-Private Partnership in Infrastructure Development- Case Studies from Asia and Europe. Bauhaus-Universität Weimar, Faculty of Civil Engineering, Chair Construction Economics, 2009. P. 35.

¹⁹⁰ Delmon, J.: BOO/BOT Projects- A Commercial and Contractual Guide. Sweet & Maxwell Limited, London, 2000, P. 40–62.

¹⁹¹ Akintoye, A., M. Beck, *et al.*: Framework for Risk Assessment and Management of PFI Projects. Glasgow, Glasgow Caledonian University, 2001.

¹⁹² Zimmermann, Josef: Project Delivery Systems. Lecture Notes, Lehrstuhl für Bauprozessmanagement der TU München, 2013, P.12.

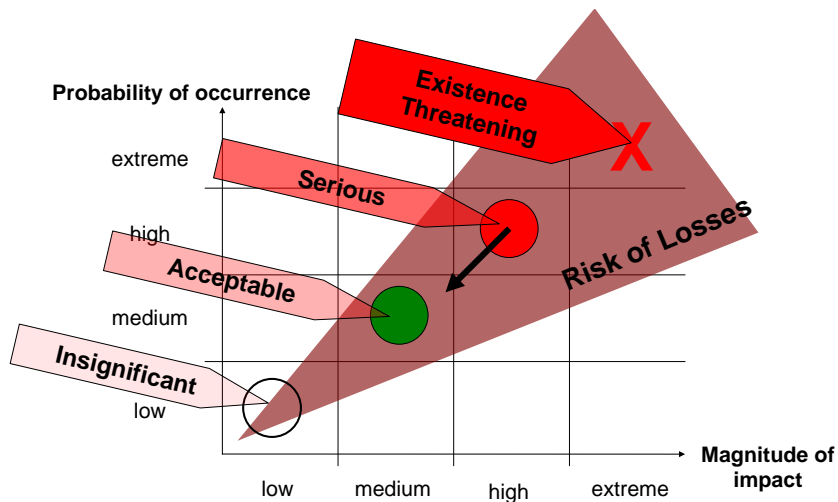

Figure 2-32: One possibility of risk classification¹⁹³

According to Wang *et al.* (2002)¹⁹⁴ risks must be identified in a rational systematic manner, otherwise some risks may be overlooked, and it is these unidentified risks that tend to be most disastrous and catastrophic. Much research has been carried out in the area of risk identification with particular regards to PPP projects, in developing countries, resulting in different categorizations of risks such as Gupta and Sravat (1998), Kumaraswamy and Morris (2002), Ozdoganm and Birgonul (2000), Salzman and Mohamed (1999), Wang *et al.* (2000), Aboki (2005); Akintoye *et al.* (1998); Ayeni (2005); Dixon *et al.* (2005); Ibrahim and Price (2006); Li *et al.* (2005); Sonuga *et al.* (2002); Xenidis and Angelides (2005); and Yusuf (2005).

In general, the most widely used risk categorisation methods are based on identifying risks according to their source, such as, cost risks, planning risks, etc. Various approaches have also been developed to classify risks according to the life cycle of building assets development and operation. In some projects, risks are categorised at a strategic level as political, economic/commercial, environmental and social risks.

In addition to, some literatures classify PPP project risks into: macro-level risks (risks external to the project), meso-level risks (risks that occur within the project organisation) and micro-level risks (risks that originate from stakeholders' relationships)¹⁹⁵. Others used global (independent of a project) versus project risks¹⁹⁶, systematic (market, not diversifiable) versus unsystematic risk (unique, diversifiable), measurable versus immeasurable (uncertainty) risk, qualitative versus quantitative risk. Hence in the PPP context, the risks that are being considered must be measurable, manageable, actionable and controllable.¹⁹⁷

¹⁹³ Previous reference.

¹⁹⁴ Wang, S.Q., Dulaimi, M.F., Aguria, M.Y.: Building the External Wing of Construction-Managing Risk in International Construction Project. Research Report, National University of Singapore, Singapore, 2013.

¹⁹⁵ Boussabaine, A.: Cost Planning of PFI and PPP Building Projects. 1st edition, Taylor & Francis, New York, 2007, P.303.

¹⁹⁶ A.D. Ibrahim, A.D.F. Price and A.R.J. Dainty: The Analysis and Allocation of Risks in Public Private Partnerships in Infrastructure Projects in Nigeria. Journal of Financial Management of Property and Construction, V-11, No.3, 2006, P.151.

¹⁹⁷ Hin Mun, Lee: Analysis of Public Private Partnership for Toll Road Projects. MSc thesis, Lehrstuhl für Bauprozessmanagement und Immobilienentwicklung der Technischen Universität München, 2009, P.23.

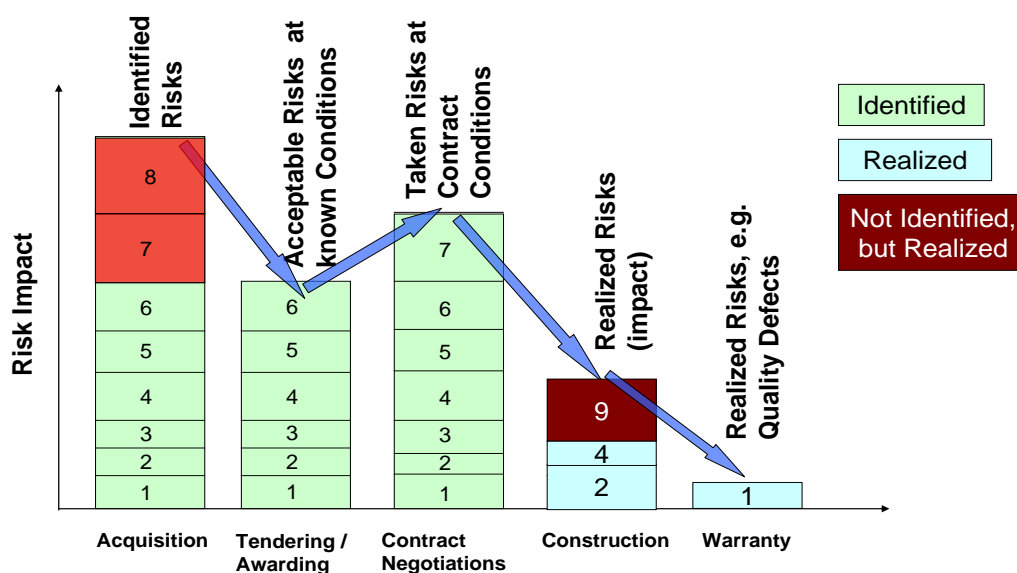

Figure 2-33: Schematic example of risk impact related to the business processes¹⁹⁸

According to another breakdown, risks can be divided into controllable risks (risks which a decision maker undertakes voluntarily and whose outcome is within control); and uncontrollable risks (risks which we cannot influence).¹⁹⁹ According to UNIDO (1996) the type of risks to which the PPP projects are typically exposed to can be broadly classified into two broad categories: general or country specific risks, these are the risks normally associated with the host country and over which the project promoter have no control, and project specific risks, These are the risks to which the project sponsors have control to a certain extent.²⁰⁰

Moreover, another popular classification, based on the lifecycle of PPP projects may be divided into three stages of development, construction, and operation and the project specific risks associated with these phases are:²⁰¹

- Development phase: The risks which are more prevalent during this phase are the bidding risk, delay in planning risk, and approval risk. Bidding risk refers to the likelihood of loss of tender to other competitor resulting in the loss of the expenditures associated with the bidding. These expenditures relating to preparation of detailed design, comprehensive planning, and preparation of extensive bid documents could be very large in case of large PPP projects.
- Construction phase: The major risks related with this phase are the risks that actual cost of construction is more than the budgeted cost of construction; time taken to complete the project is more than the projected time to completion; and failure to achieve completion.

¹⁹⁸ Zimmermann, Josef: Project Delivery Systems. Lecture Notes, Lehrstuhl für Bauprozessmanagement der TU München, 2013, P.13.

¹⁹⁹ Chege LW, Rwelamila PD: Risk Management and Procurement Systems – An Imperative Approach. Department of Construction Economics and Management, University of Cape Town, South Africa, 2000.

²⁰⁰ UNIDO: Guidelines for Infrastructure Development Through Build-Operate-Transfer. United Nations Industrial Development Organization, Vienna, 1996.

²⁰¹ Alfen, Hans-Wilhelm, *et al*: Public-Private Partnership in Infrastructure Development- Case Studies from Asia and Europe. Bauhaus-Universität Weimar, Faculty of Civil Engineering, Chair Construction Economics, 2009.

- Operating phase: The projects start generating revenues during this phase of the project. There are certain risks that can have a bearing on the project capacity to earn its projected revenue and in meeting the budgeted operating and maintenance expenses. Some of the risks that are normally associated with the operation phase are (1) technical risk; (2) demand risk; (3) force majeure risk; and (4) revenue risk.

Table 2-9 to Table 2-13 were created from information collected by the literature on PPP project risk factors published from 1997 to 2013.²⁰² The sources for empirical studies included journal articles and conference papers, research reports, textbooks, commercial or organizational documents, and so on. The sources for official publications included the practice guidance, records, reports or other documents published by the governmental organizations. This classification is adopted by this research to explain the process of risk allocation in PPP projects. These Tables show which risks are transferred to the private sector and which are retained by the public authority. All design and construction risks are allocated to the private sector with the exception of the delay events, force majeure and termination due to force majeure risk factors which are shared, and legislative/regulatory change and compensation events risks are taken by the procurer.

Risk heading	Risk type	Definition	Responsible party
Design Risks	Design failure	Failure to translate the requirements of the government into the design.	Private
	Change in scope by government	The government may require changes to the design, leading to additional design and construction costs.	Public
	Change in scope by Project Company	This is the risk that Project Company will require changes to the design, leading to additional design costs.	Private
	Change in design due to external influences specific conditions	There is a risk that the designs will need to change due to legislative or regulatory changes specific to the provision of specific conditions.	shared
	Failure to build to design	Misinterpretation of design or failure to build to specification during construction may lead to additional design and construction costs.	Private

Table 2-9: Design risks in PPP projects

Risk heading	Risk type	Definition	Responsible party
Construction and Development Risks	Construction time overrun	The time taken to complete the construction phase may be different from the estimated time.	Private
	Ground condition/ Environmental permits	Unforeseen ground/site conditions may lead to variations in the estimated cost.	Private
	Construction cost overrun	Estimated cost of receiving detailed planning permission is incorrect, including the cost of satisfying unforeseen planning requirements.	Private
	Delay in site acquisition	A delay in gaining access to the site may delay or impede the performance of the contract and cause additional expenses.	Public
	Third party claims	This risk refers to the cost associated with third party claims due to loss of amenity and ground subsidence on adjacent	Private

²⁰² See Appendix A

		properties.	
	Force majeure	In the event of force majeure, additional costs will be incurred. Facilities may also be unavailable.	shared
	Contractor or subcontractor default	In the case of contractor default, additional costs may be incurred in appointing a replacement, and may cause a delay.	Private
	Poor project management	There is a risk that poor project management will lead to additional costs. For example, if subcontractors are not well coordinated, one subcontractor could be delayed because the work of another is incomplete.	Private
	Contractor/subcontractor industrial action	Industrial action may cause the construction to be delayed, as well as incurring additional management costs.	Private
	Responsibility for maintaining on site security	Theft and/or damage to equipment and materials may lead to unforeseen costs in terms of replacing damaged items, and delay.	Private
	Delayed approvals	A delay in receiving permission may have broader cost implications for the project, as well as the loss of potential savings.	shared

Table 2-10: Construction and development risks in PPP projects

Risk heading	Risk type	Definition	Responsible party
Operating Risks	Operating cost overrun	The cost of providing these services may be different to those expected, because of unexpected changes in the cost of equipment, labour, utilities and other supplies.	Private
	High maintenance cost	The cost of building and engineering maintenance may be different to the expected costs.	Private
	Operation quality/Poor performance of services	The operator will incur deductions from the performance payment for the poor performance of services.	Private
	Unproven engineering technique	Unexpected changes in technology may lead to a need to re-scale or reconfigure the provision of services.	Public
	Project Company default	The risk that Project Company defaults and step-in rights are exercised by financiers but that they are unsuccessful, leading to contract termination.	Private
	Non-performance of services	Payment will only be made by the Tenant for services received.	Private
	Changes in the volume of market demand	The risk that demands for a service does not match the levels planned, projected or assumed.	Public
	Weak safety methods	Risk due to adverse in providing safety	Private
	Environmental	Where the nature of the project has a major impact on its adjacent area and there is a strong likelihood of objection from the general public.	Private

Table 2-11: Operating risks in PPP projects

Risk heading	Risk type	Definition	Responsible party
Financing Risk	Interest rate	The risk that prior to completion interest rates may move adversely by undermining bid pricing.	Private
	Foreign exchange	The possibility that exchange rate fluctuations will impact on the envisaged costs of imported inputs required for the construction or operations phase of the Project.	Private

	Inflation rate	Risk that value of payments received during the term is eroded by inflation.	Private
	Tariff change	This is the risk of adverse changes in tariff of PPP products or services, leading to the revenue of the project company lower than expected.	Shared
	Finance unavailable	The risk that when debt and/or equity are required by the private party for the project it is not available then and in the amounts and on the conditions anticipated.	Private

Table 2-12: Financing risk in PPP projects

Risk heading	Risk type	Definition	Responsible party
Project life cycle Risks	Less residual value	The risk relating to the uncertainty of the value of physical assets at the end of the contract.	Private
	Lack of commitment from public/private partner	The risks generated by the lack of commitment between public and private partners.	Shared
	Social/Cultural difference	The risk of costs and delays associated due to differences in social and cultural of the society.	Public
	Corruption	The behavior of the corruption of government officials will increase the cost of keeping the relationships between the government and the project company. Meanwhile, it will increase the risk of contract breaking by the government.	Public
	Labour /Material unavailability	The possibility of a failure or shortage in the supply of the labour or resources required for the operation of a project including deficiencies in the quality of available supplies.	Private
	Poor public decision-making process	Non standardized procedures, bureaucracy, lacking of PPP project experience and ability, insufficient preparation and information asymmetry, leading to poor decision making.	Public
	Expropriation/nationalization	This is the risk of taking of privately owned property by the government to be used for the benefit of the public.	Public
	Change in legal and regulatory framework	The risk of a change in law/policy of the government, which could not be anticipated at contract signing and which is directed specifically and exclusively at the project or the services and which has adverse capital expenditure or operating cost consequences for the private party.	Public
	Change in tax regulation	The risk that before or after completion the tax impost on the private party, its assets or on the project will change.	Public
	Government stability/Civil disturbance/ security	The possibility of (1) Unforeseeable Conduct by the by any government authority that materially and adversely affects the expected return on Equity, debt service or otherwise results in increased costs to the Private Party, or (2) Expropriating actions of the assets of the Private Party.	Public
	Utilities risk	The risks generated by the unavailability of the supporting facilities of the project.	Private
	Insolvency risk	The possibility of the insolvency of the Private Party.	Private
	Unforeseen weather	Because of the project site's bad natural conditions, for example, climate condition, special geographical environment, and poor site conditions, etc.	Private

Table 2-13: Project life cycle risks in PPP projects

2.3.2.2 Risk Assessment

In a PPP project, a risk may turn out to be difficult to assess for one of two reasons. First, there may be very little knowledge about a particular variable simply because the data has not been collected in a useable form. Second, there may be too many genuine uncertainties in the system, and therefore the environment is too complex to make any long term predictions.²⁰³

As well as identification of risk, risk assessment is also a very important aspect for the success of PPP because, assessing risk helps the decision makers to weigh the different risk and act upon it in a systematic and effective manner. The main aide of risk assessment is to explore how likely risks are to happen, what the consequences of their occurrence will be and the value of their impact in terms of time, cost or quality. Risk assessment is a complex stage, because, after any calculations, implies an attempt to predict the future, to assess possible risks, which could face an economic entity.

In principle, risk assessment is a systematic process to identify and compare that to consider the organization's key assets, threats and vulnerabilities that can occur, the likelihood and consequences and protective measures that can be counteracted. This activity is often the most complex of the risk management process because of such factors as:

- Opportunities and threats can interact in ways that cannot be anticipated (for example, behind the initial schedule may force consideration of a new strategy that ultimately leads to decrease the time allocated to project)
- A single risk can have multiple effects: additional costs, delays, penalties, reducing the quality of results;
- Events which are opportunities for a person or organization (cost savings) may be threats to other (reducing profits);
- Mathematical techniques used to quantify the risk may provide a time accuracy and safety unfounded.

In risk assessment, analysis and statistical calculations reported in frequency of occurrence of risks are designed to determine the likelihood of their occurrence. If there is relevant and reliable data available, subjective estimates may be used. To avoid confusion caused by subjectivism in the risk assessment can be consulted experts. Benefits of risk assessment phase are reflected in: provides the possibility to take comparisons with historical data or risk level in the field, can risk aggregation of several activities to provide a value for total risk, the knowledge level of uncertainty associated with results tracked and whether to be made when the decision risks. The techniques available for risk assessment can be classified into: qualitative and quantitative²⁰⁴. The amount of information and time available and the need for the assessment determine the type of evaluation to be utilized.

2.3.2.2.1 Qualitative Assessment

Qualitative approach is where the likelihood or the magnitude of the consequences of an event or occurrence is expressed in qualitative terms where the probability or frequency of the outcomes can be estimated and the magnitude of the consequences is quantified. The main aim of a qualitative risk analysis is to identify risks with "acceptable" or "unacceptable", or

²⁰³ Infrastructure Australia: National PPP Detailed Guidance. Vol. 4, 2008, P.111.

²⁰⁴ Tanaka, D. F., H. Ishida, *et al.*: Private Finance for Road Projects in Developing Countries-Improving Transparency Through VFM Risk Assessment. Journal of the Eastern Asia Society for Transportation Studies 6, 2005, P.3899 - 3914.

classifications such as "low", "medium", "high" for the given project and prepare information for the subsequent stage of the risk assessment process. It is often used as:²⁰⁵

- An initial screening or review of project risks.
- When a quick assessment is desired.
- The preferred approach for some simpler and smaller projects where robust and/or lengthy quantitative analysis is not necessary.

Qualitative approach does not use absolute values, but instead it qualitatively evaluates influence of each variable on the risk. The experience of the person doing the risk assessment is the most important in the qualitative approach. However, in order to interpret the results easier, variables, as well as numeric values are not absolute, but relative.

There are various qualitative risk assessment techniques available. Some of the commonly used techniques are:^{206 207 208 209}

- Risk registers, which compile all the risks relevant to the projects along with the information necessary for management of the risks.
- SWOT analysis.
- Brainstorming sessions, it involves a group of people, who are present ideas for a specific problem that needs to be solved. Finally, it needs to evaluate those ideas,
- Threat ranking by risk evaluation.
- Acceptable/unacceptable risk separation.
- Questionnaires, physical inspections.
- Scenario building, the scenarios method involves the construction of a number of scenarios, which describe the potential future risk in the project.
- Delphi forecasting, this method uses the knowledge and experience of experts to predict the risks.
- Data precision ranking, examine the extent to which a risk is understood, the data available about it, and the reliability of the data in order to evaluate the degree to which the data about risks are useful.
- Risk matrices and probability impact risk rating tables, which assign risk ratings (very low, low, moderate, and so on) to risks based on combining probability and impact qualitative scales. A simple example is shown in Figure 2-34.
- Cause and effect diagrams, also called Ishikawa or fishbone diagrams, to illustrate the interrelations between risks and their causes, including the domino effect.
- Flowcharts and influence diagrams, as pure graphs reflecting the interrelations between activities, risks, and responses,

²⁰⁵ Boussabaine, A.: Cost Planning of PFI and PPP Building Projects. 1st edition, Taylor & Francis, New York, 2007, P.258.

²⁰⁶ Previous reference.

²⁰⁷ Hrvoje Segudovic: Qualitative risk analysis method comparison. INFIGO-MD, 2006.

²⁰⁸ ISO 31000 of Risk Management Standard: Risk Management-Principles and Guidelines. 2009.

²⁰⁹ Simon, P. *et al.*: PRAM Project Risk Analysis and Management Guide-Association for Project Management. High Wycombe, UK, 1997.

- Event and fault trees, which are typically used in risk analysis of engineering system (unclear power and project management.

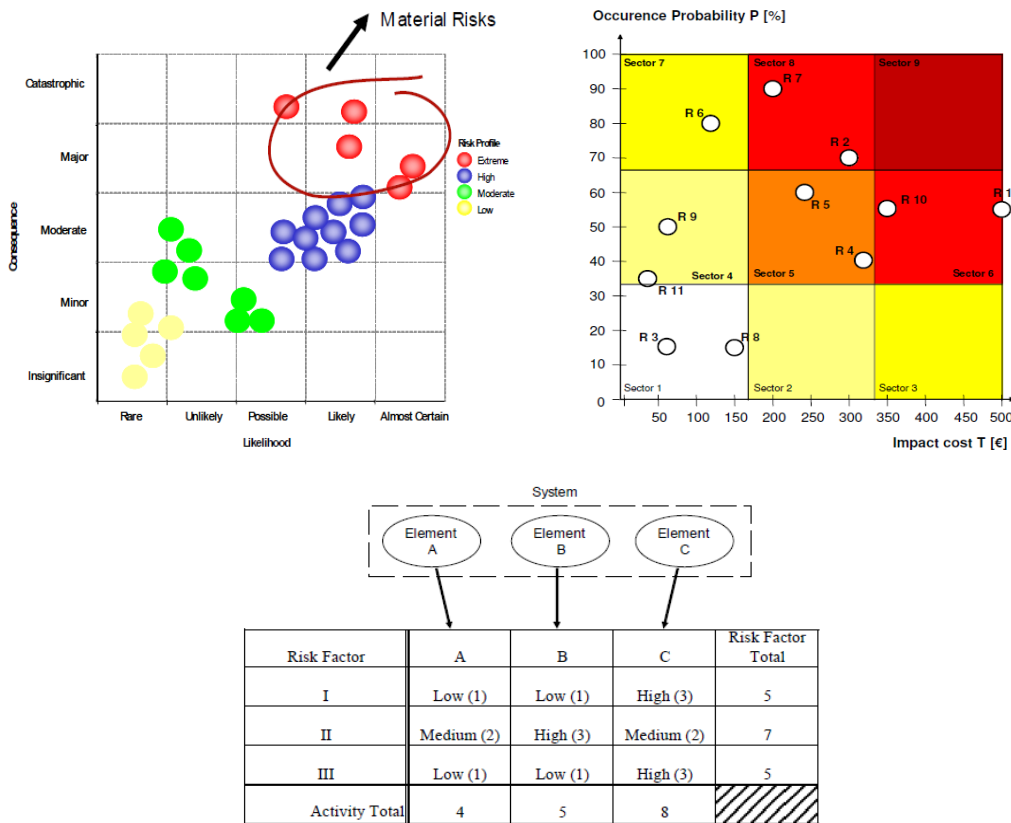

Figure 2-34: Examples of qualitative risk matrix²¹⁰

2.3.2.2.2 Quantitative Assessment

Quantitative approach is based upon quantitative (numeric) data. The idea of quantitative analysis is that if one can examine a problem from enough points of view and measure or estimate each of those elements, one can understand enough about it to make valid conclusions²¹¹. Another technique for the quantitative assessment is the deterministic approach which measures the impact on project outcomes of changing one uncertain key value or a combination of values at a time. Deterministic models compute prices and costs as a single-point estimate. Quantitative risk methods use the following techniques:^{212 213 214 215 216}

²¹⁰ Infrastructure Australia: National PPP Detailed Guidance, Vol. 4, 2008, P.29.
²¹¹ Thomas L. Norman: Risk Analysis and Security Countermeasure Selection. Taylor & Francis Group, 2010, P.53.
²¹² Boussabaine, A.: Cost Planning of PFI and PPP Building Projects. 1st edition, Taylor & Francis, New York, 2007, P.258.
²¹³ Hrvoje Segudovic: Qualitative Risk Analysis Method Comparison. INFIGO-MD, 2006.
²¹⁴ ISO 31000 of Risk Management Standard: Risk Management-Principles and Guidelines. 2009.
²¹⁵ Simon, P. *et al.*: PRAM Project Risk Analysis and Management Guide- Association for Project Management. High Wycombe, UK, 1997.
²¹⁶ De la Cruz, M. P.: Integrated Methodology for Project Risk Management, PhD thesis, Univ. of Madrid, Spain, 1998, in del Cano, A.: Journal of Construction Engineering and Management, ASCE, Vol. 128, NO. 6, 2002, P.473-85.

- Mean-variance criterion coefficient of variation.
- Artificial intelligence.
- Mathematical/analytical technique.
- Complexity tools.
- Conservative benefits and cost estimating.
- Breakeven analysis.
- Risk-adjusted discount rate.
- Certainty equivalent technique.
- Variance and standard deviation and net present value.
- Sensitivity analysis, to discover the criticality of various project parameters.
- Expected value tables, to compare expected values for different risk responses.
- Triple estimates and probabilistic sums applied to cost estimating.
- Monte Carlo, Latin hypercube simulation, to obtain the cumulative likelihood distributions of the project's objectives (net present value, cost, time) using probabilistic estimation of the input parameters.
- Decision trees to aid decision making when there are choices with uncertain outcomes.
- Probabilistic influence diagrams combining influence diagrams with probability and Monte Carlo theory to simulate aspects of project risk.
- Multi criteria decision-making support methods (MDMSMs) for making choices among alternatives with conflicting demands. Analytic hierarchy process (AHP), for example, is a type of MDMSM that can be used for multi criteria selection among different risk responses, mixing qualitative and quantitative criteria.
- Process simulation, using a variety of techniques to simulate specific project processes,
- Fuzzy logic, with potential applications to scheduling, cost control, and multi criteria selection among several alternatives. In addition to these, other support techniques such as brainstorming, Delphi, and interviewing can be used in risk analysis, estimations, and estimation refinement.
- System dynamics, combining influence diagrams with a more complex mathematical framework to dynamically simulate specific aspects of project parameters with feedback loops and the ability to simulate the selection among different alternative action.

The choice of which technique to use depends on the size of project, complexity, time available and the level of statistical accuracy demanded. In quantifying risk, the pricing framework and assumptions used must be defensible. The party responsible for a particular risk must be capable of managing it, subject to any statutory constraints and public interest considerations.²¹⁷ Quantitative analysis is always a part of qualitative analysis, even when the quantitative analysis is not applied. The analysis must perform some quantitative analysis in order to reach any conclusions about the assets, risks, and probabilities.

2.3.2.3 Risk Allocation

One of the criteria for success in PPP is risk allocation. Li *et al.* (2005)²¹⁸ suggested that risk allocation refers to a primary measure of assignment between the public and private sector.

²¹⁷ Infrastructure Australia (2008): National PPP Detailed Guidance, Vol. 4, 2008, P.15.

²¹⁸ Li, B., Akintoye, A. Edwards, P.J. Hardcastle C.: The Allocation of Risk in PPP/PFI Construction Projects in the UK. International Journal of Project Management, Vol.23 (1), 2005, P. 25-35.

Grimsey and Lewis (2002)²¹⁹ pointed out that the arrangements of PPP projects are founded on the transfer of risk from the public to the private sector under circumstances where the private sector is best placed to manage the risk. It is important that risk allocation is clearly communicated and understood between the parties.

Theoretically, risks associated with design, construction, finance, maintenance and operation of the scheme over the life of the project should be identified, quantified, priced and allocated to an agent who can best control the risky outcome and bear the risk at the lowest cost. Those agents are the least risk averse because they can most easily insure or hedge against the risk, or because they can spread the risk among many people.²²⁰

Risks arise due to uncertain future outcomes which may have direct effect on the project, and the commercial viability of the project. Therefore, the risk allocation is at the heart of a PPP design. This is also an important element in establishing the business case for a PPP project. The aim of risk allocation in PPP projects is to determine whether the risk is retained by the government, transferred to the private sector or shared by both parties. The process of risk allocation plays a vital role in this process. Conventional risk allocation practices advocate that risks ought to be transferred to the party who can best control them (See Figure 2-35).

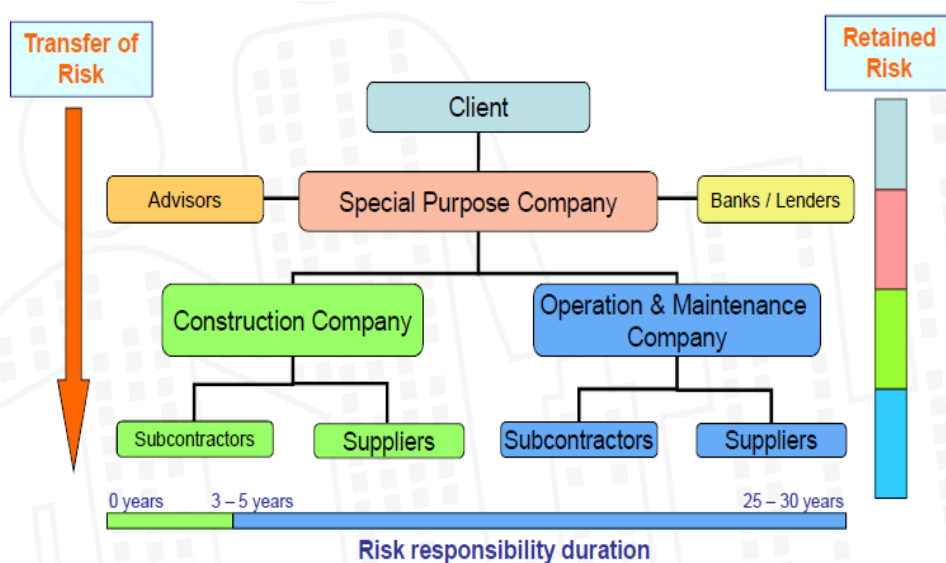

Figure 2-35: Risk in PPP projects²²¹

Risk transfer to the private sector is important in the demonstration of value for money and determining the balance sheet treatment in PPP schemes. However, this party, in practice, may not be sufficiently financially robust to absorb the cost of the allocated risks. Inappropriate risk allocation can damage the VFM proposition because the measures of the whole-of-life project cost are highly sensitive to the allocation of risks.²²² Risk allocation produces highest value for money once the optimal risk transfer point is identified (See Figure 2-36).

²¹⁹ Grimsey, D., and Lewis, M.: Evaluating the Risks of Public Private Partnerships for Infrastructure Projects. *International Journal for Project Management*, Vol. 20(2), 2002, P. 107–118.

²²⁰ Irwin, T., Klein, M., E. Perry, E.G., and Thobani M.: *Managing Government Exposure to Private Infrastructure Risks*. The World Bank research observer, Vol. 14(2), 1999, P.229-45.

²²¹ Gavin M.H.: *Risk Transfer –Critical For Privately Financed Projects*. Conference for Trans European Promotion of Public-Private Partnership, Warsaw University of Technology, Warsaw, Poland, 2010.

²²² DFA *Public Private Partnerships: Guideline-Commonwealth Policy Principles for the Use of Private Financing*. Introductory Guide. Financial Management Guidance, Australian Department of Finance and Administration (DFA), Canberra, Australia, 2005c.

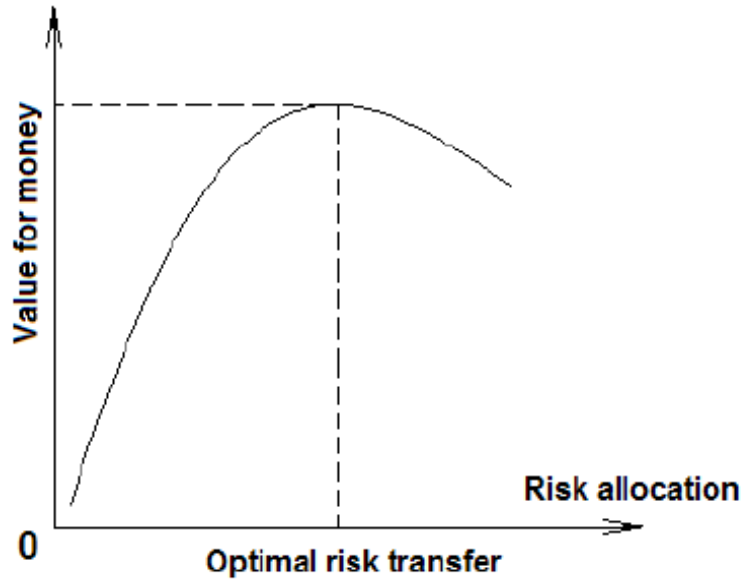

Figure 2-36: Optimal risk allocation point²²³

In case that both of the partners were unable to control certain risk, it should be then determine who is responsible for managing the risk based on the following factors:²²⁴

- The cost of addressing the private sector to take the risk and whether it was possible that these costs are covered by the public sector.
- Cost incurred by the public sector in the case of keeping him on the risk and the extent of its ability to mitigate the effects of it.

If risks rest inappropriately with the public sector, government would raise taxes or reduce services to pay for its obligations when the risks materialize. In contrast, if risks rest inappropriately with the private sector, excess premiums would be charged to the government or even directly to the end users.²²⁵ Figure 2-37 shows the variation degree of risk sharing with the different PPP type.

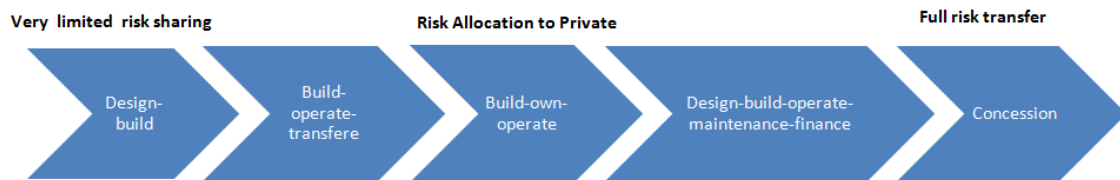

Figure 2-37: Degree of risk transfer by PPP types²²⁶

²²³ Partnerships Victoria: Public Sector Comparator Technical Note. Victoria, Australia, Department of Treasury Finance.2001, P.52.

²²⁴ E-Government Program: Guide of the Partnership Between the Public and Private Sectors. Kingdom of Saudi Arabia, 2004, P.102.

²²⁵ Thompson, P., and Perry, J.G. (eds): Engineering Construction Risks. A Guide to Project Risk Analysis and Risk Management, Implications for Project Clients and Project Managers, An SERC Project Report, Thomas Telford, London, 1992.

²²⁶ OECD: Public-Private Partnerships in Pursuit of Risk Sharing and Value for Money, 2008, P.51.

2.3.2.4 Risk Mitigation

Risk mitigation refers to the practice that can reduce either the likelihood of occurrence of risk or the impact of the consequence in case the risk occurs.²²⁷ Usually the flow process of risk management is as follows: risks that are able to avoid are avoided, the non-avoidable risk are either reduced or transferred to another party and finally the remainder of the risk are then accepted, priced and assumed by the risk taking party fully aware of its potential consequences. This does not mean that accepted risks are not being actively managed. The action plans for such accepted risks when it materialises are in place which means that the risk has already been accounted for. After a full circle of risk management, the risk is controlled to a manageable level. The impact of the risk only happens when the risk materialises not when it is actively managed.²²⁸ Methods used for risk mitigation include:²²⁹

- Risk elimination / avoidance,
- Risk reduction,
- Risk transfer,
- Risk retention/absorption.

The degree of significance given to any particular risk varies from project to project and from stakeholder to stakeholder.

Risk elimination is also often referred to as risk avoidance or aborting. It is synonymous with refusal to accept risks. Actions to avoid the risk can involve the complete elimination of risk. Project Company can make changes in the project plan to eliminate the risk or to protect the project objectives from its impact. The project company might achieve this by changing scope, adding time, or adding resources (thus relaxing the so-called triple constraint).

If not eliminated, risk can be reduced, by acquiring more information. In view of their adverse consequences, and given that risks are inevitable, attempts should be made to minimise their affects. Actions that could be taken to minimise some risks concern the redesign of facilities to reduce risks, interacting with unions to minimise disruptions to work, etc.

Risk transfer is important for the Public Authority, in principle; all risks can be transferred to the private part, but in the transfer lays also an economical compensation. The size of the compensation to the private part is influenced by occurrence probability of the risk and the extent of the related damages. The more precise the private part can estimate and quantify these factors the lower is the size of the compensation for the transfer of the risk.²³⁰

It is important to note that risks do not disappear when transferred to a private party through a contractual mechanism. The risks are merely shifted to the private party which will now assume the risks. From government's perspective, the PPP approach provides a means for government to mitigate the financial effects of risks to which it would otherwise be exposed. However, risks are only mitigated to the extent of the private party's ability to control risks, private party's ability to accept risks and jurisdiction's ability to rely on the private party.²³¹

²²⁷ Alfen, Hans-Wilhelm, *et al*: Public-Private Partnership in Infrastructure Development- Case Studies from Asia and Europe. Bauhaus-Universität Weimar, Faculty of Civil Engineering, Chair Construction Economics, 2009.

²²⁸ Infrastructure Australia (2008): National PPP Detailed Guidance, Vol. 4, 2008, P.110.

²²⁹ Akintoye, A., M. Beck and Hardcastle, C.: Public Private Partnerships-Managing Risks and Opportunities. Glasgow, Glasgow Caledonian University, 2003, P.114.

²³⁰ OBB: PPP zur Realisierung öffentlicher Baumassnahmen in Bayern, Teil 3, München, 2006, S.13.

²³¹ Infrastructure Australia: National PPP Detailed Guidance, Vol. 4, 2008, P.110.

From private's sector perspective, risks can be reallocated and reduced perhaps by passing them on a back-to-back basis to subcontractors, network of contractual relationships is used to achieve this. Project Company transfer the risks related with the construction and design of the facility to the EPC contractor, the operation and maintenance of the facility to the O&M contractor. The risks will be further reduced if the Project Company selects parties which are experienced and qualified.²³²

In the case of concessions, risks can be transferred to end-users through the project company having a right to impose higher service fees. However, in the long run controlling the risks will involve discipline and effective management. The approach or strategies that are being used to mitigate the particular risk should be properly documented by both private and public sector.

Moreover, risk retention is also known as risk absorption and risk pooling. After reducing the potential impact of risks, those that cannot be eliminated or transferred away are absorbed by the organization. The risks that are suitable for retention by any organization are those with minimal consequences.

The retained risk assumed by the government can also be mitigated using commercial insurance. The value of the retained risk may be estimated by calculating a notional insurance premium based on past losses or the applicable commercial premium for a similar insurable item. Third-party insurance should be considered for economically insurable retained risks.

Alternatively, government could self-insure. Self-insurance, which has been traditionally used by government, is the preferred approach where the cost of it is less than commercial insurance. Ideally, self-insurance should involve setting aside the premiums in a fund or dedicated reserve. Where government uses commercial insurance (e.g. construction or contractor insurance), the cost of the insured risk to government is no longer included as a Retained Risk, since it has been passed at a cost to a third party.²³³

Similarly the retained risk assumed by the private company can be also mitigated using insurance, with insurance, in addition to transfer of the risk; the implication of the consequence of the risk is also capped at the risk premium, or having them guaranteed by Sponsors. Project sponsors can select from a wide range of insurance instruments to mitigate various risks such as owner's liability, some of the force majeure events, business interruption, and legislative and government policy risks such as convertibility of currency and, to a limited extent, change of law.²³⁴ For the private company the retained risks will be priced according to its willingness to assume the responsibility of the risk.

The success of PPP projects is also hinges on strategies selected by decision makers for treating risk. Typically, sponsors may consider the following types of risk or uncertainty treatment strategies:²³⁵

- **Guarantees:** these are issued on behalf of contractors by banks, governments, or their agencies to ensure that the client has recourse to compensation, in case of the contractor's

²³² Boussabaine, A.: Cost Planning of PFI and PPP Building Projects. 1st edition, Taylor & Francis, New York, 2007, P.243.

²³³ Infrastructure Australia: National PPP Detailed Guidance, Vol. 4, 2008, P.47.

²³⁴ Alfen, Hans-Wilhelm, *et al*: Public-Private Partnership in Infrastructure Development- Case Studies from Asia and Europe. Bauhaus-Universität Weimar, Faculty of Civil Engineering, Chair Construction Economics, 2009.

²³⁵ Akintoye, A., M. Beck and Hardcastle, C.: Public Private Partnerships-Managing Risks and Opportunities. Glasgow, Glasgow Caledonian University, 2003, P.116.

default. For example the World Bank through International Bank for Reconstruction and Development (IBRD) and International Development Association (IDA), serving middle income countries and poorer countries respectively by issued guarantees and structured new financial instruments to cover different risks,

- **A Letter of Credit' (LOC):** is a form of guarantee, issued by a bank on behalf of a contractor that is operating overseas. The LOC entitles the client to withdraw cash on production of certain documents or upon fulfilling certain conditions. Usually the exercise of such right is associated with the non-performance of the contractor.
- **Bid Bonds:** are issued to safeguard the client, such that if and when a contractor's bid was accepted by the client, that contractor would not renege on entering into a contract with the client.
- **Surety Bonds:** are a form of guarantee that other forms of resolution would be sought, in the face of non-performance, before the cash withdrawal penalty is applied.
- **Risk Premium:** the equivalent of this term in construction is the contingency sum, which is usually added to an estimate to account for unforeseen eventualities that cannot be fully priced when an estimate is prepared.
- **Adjusted Discount Rate:** is mostly used in banking and business to adjust a risk-free discount rate by accounting for future inflation and extraordinary risks.
- **Tariff Adjustment:** The main objective of the tariff design is to offer the concessionaire incentives for efficient productivity and to enable it to earn reasonable rate of return, in reality it is a sort of risk allocation in which it is decided which risks should be allocated to the concessionaire, which to the government, and which to some other party. Tariff has to be adjusted only when they reflect events unmanageable by the concessionaire.
- **Hedging and Insurance:** Hedging and insurance can be used to mitigate risks that cannot be managed in any other way. A Project Company can hedge and insure the impacts of risk, especially those originating from investment climate, through financial markets, if such markets for PPP ventures exist in reality. However, they are normally costly since a Project Company has to pay insurance premiums and other transaction costs. Therefore, insurance and hedging eventually increase the cost of capital.²³⁶
- **Government Support:** To relieve the impact of risk, sponsors may seek various forms of government support (See Section 2.13.6).
- **Self-financial Support:** Project Company may accommodate the effects of different risks on expected financial outcomes of PPP projects within its own management capability, provided they are able to endure it. Within the framework of self-financial support, sponsors acknowledge the impact of different risks, based on projected revenues and project funding mechanisms.

²³⁶ Senbet, L., and Triantis, A.: Strategies for Risk Management and Financial Contract Design. Prepared for the World Bank Institute's "Building Knowledge and Expertise in Infrastructure Finance" Program, The World Bank, Washington, D.C, 1997.

- **Performance Bonds:** are issued by a surety company to cover the aspect of non-performance on the part of a contractor.

Due to that the cost of insurance and hedging is often higher than the government support; most PPP projects choose to seek government support to some extent. However, governments may not deem government support to be an effective risk treatment strategy, especially when the issue of designing competitive contracts prevails. Sponsors will indeed gain competitive advantages from governments if they are able to formulate financial solutions without government support.

On the other hand, a security bond is a form of collateral given by the private sector to the public sector. In the event of noncompliance with the agreed upon obligation, the public sector have the rights to use the bond to cover the cost to make up for the difference in delivery. The duration and type of security bond pre and post completion of the infrastructure project are normally different since the risks involved before and after completion are different. This is shown in Figure 2-38 below.

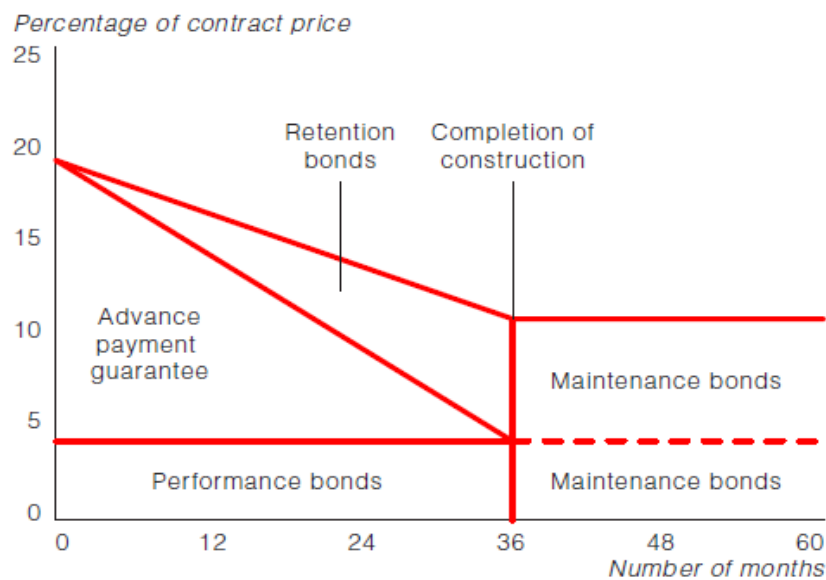

Figure 2-38: Amount and duration of security bond in a concession²³⁷

The risk of losing the bond might act as a powerful deterrent in preventing the private sector from "walking away" from a given project if disputes arise.²³⁸ In order for the security bond to be an effective instrument, the quantum of the bond must be significant (peg as a percentage of the total contract price) but not excessively prohibitive to the private sector. The public sector also reserves the rights to demand an increase or fresh bond in lieu of the lost bond from noncompliance.

²³⁷ Nevitt, Peter K. (1989): Project financing, in World Bank: Concessions for infrastructure, A guide to their design and award, p.78.

²³⁸ World Bank (1998): Concessions for infrastructure A guide to their design and award, p.77.

Commonly, four types of performance security are used namely:²³⁹

- **Performance Bonds:** As mentioned previously, the purpose of performance bonds is to provide additional funds in case the contractor fails to perform for any reason.
- **Advance Payment Guarantee:** Typically, the contractor will receive advance payment from the authorities to assist in purchasing and assembling the materials, equipment, and personnel necessary to start construction. The contractor must then provide a guarantee to the authorities as a security for the contractor promise to fulfil its obligations. As construction proceeds, the value of the guarantee can be reduced.
- **Retention Bonds:** These bonds represent a portion of progress payment held back by the authorities in order to provide a fund to cover unforeseen expenses caused by a contractor's mistake in construction.
- **Maintenance Bonds:** These bonds provide a source of funds for correcting defects in the construction or performance of the project that are discovered after construction is completed. Typically, the performance bonds and the retention bonds are converted to maintenance bonds upon completion. Sometimes a sinking fund built up on a yearly basis is used in lieu of maintenance bonds based on future expenditure needs. A sinking fund has the flexibility of size increase should the need for a larger maintenance expenditure arises.

²³⁹ World Bank (1998): Concessions for infrastructure A guide to their design and award, p.78.

3 Iraq Infrastructure

3.1 Status of Iraq Infrastructure

Iraq is one of the countries in the Middle East and North Africa region (MENA) which has a land area of 432,162 square kilometers. It composed of 18 governorates or provinces; it is considered a lower middle income country with GDP per capita of 3,900 USD. It has the fourth largest population in the Middle East, after Iran, Egypt, and Turkey; about 32 Million inhabitant in 2013, with a yearly population growth rate of 2.6 %.²⁴⁰

Its economy and financial performance is dominated by the performance of the oil sector which is the major driving force of the economy. The growth in oil output combined with high oil prices enables the Gol to increase its capital in the reconstruction infrastructure of the country and also helps to sustain the balance of payments for the imported commodities that the country needed for reconstruction and domestic needs of its people.

Over the last three decades, Iraq suffered from the adverse consequences of three devastating wars which left behind major damage to the economy and country's basic infrastructure (e.g. public facilities). This situation was compounded by 13 years of international economic sanctions (1990-2003) which were perhaps the toughest and most comprehensive sanction in human history. During these periods, there are power shortages, lack of spare parts and migration of qualified personnel which led to the breakdown of infrastructures.

In the 1980s up to the 1990s, Iraq made significant infrastructure investments. However, with few exceptions, these were poorly maintained and have been further damaged due to the wars in 1980, 1991 and 2003. Moreover, conflicts, looting, and sabotage that occur during this period have also resulted to indirect damage to buildings, pipelines, communication equipment and transportation links. Billing systems and associated revenues that maintain operations also collapsed.

Although, substantial reconstruction expenditures have been made since 2003, most of infrastructure services have not restored to their pre-2003 levels and much still remains to be undertaken. In view of the situation of the construction industry in Iraq, it is still lagging behind in the desired capacity that could meet the requirements of the development.

For Iraq; like other developing countries; an essential requirement for economic growth and sustainable development is the provision of efficient infrastructure services. However, in Iraq the potential contribution of infrastructure to economic growth and poverty reduction has not been fully realized and existing infrastructure stock and services fall far short of the requirements. This is illustrated in Figure 3-1, which shows the deprivation and standard of living, adopted by the National Report on the State of Human Development in 2009. It depicts the deprivation in general in education, infrastructure, housing and its surroundings and economic situation. It can be noted that the infrastructure has a deprivation of 52.8 %. Thus, it depicts where basic human needs are not met.

In general, Iraq infrastructure capital spending is by Gol and government business enterprises and sub enterprises such as ministries and other agencies as shown in Figure 3-2.

²⁴⁰ International labor organization (ILO): World Employment Report 2004-05- Employment, Productivity and Poverty Reduction, 2004.

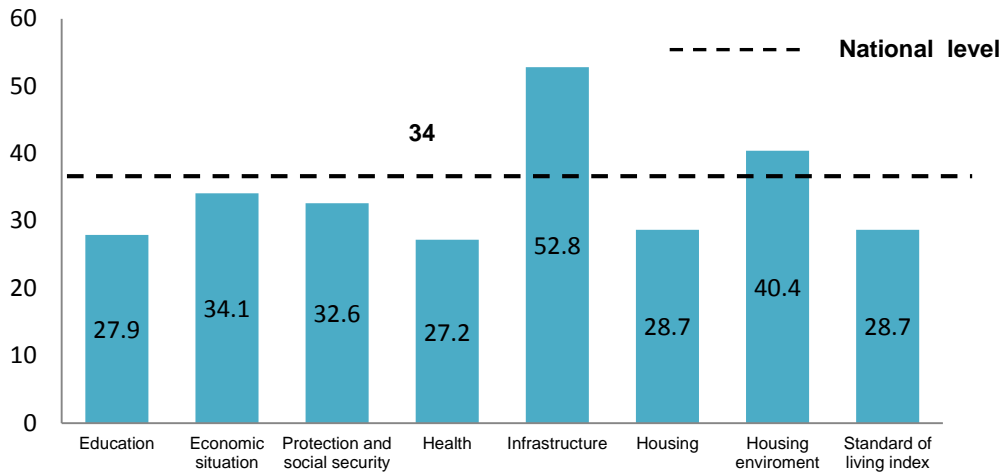

Figure 3-1: Percentage of deprived families by different fields – Iraq (%)²⁴¹

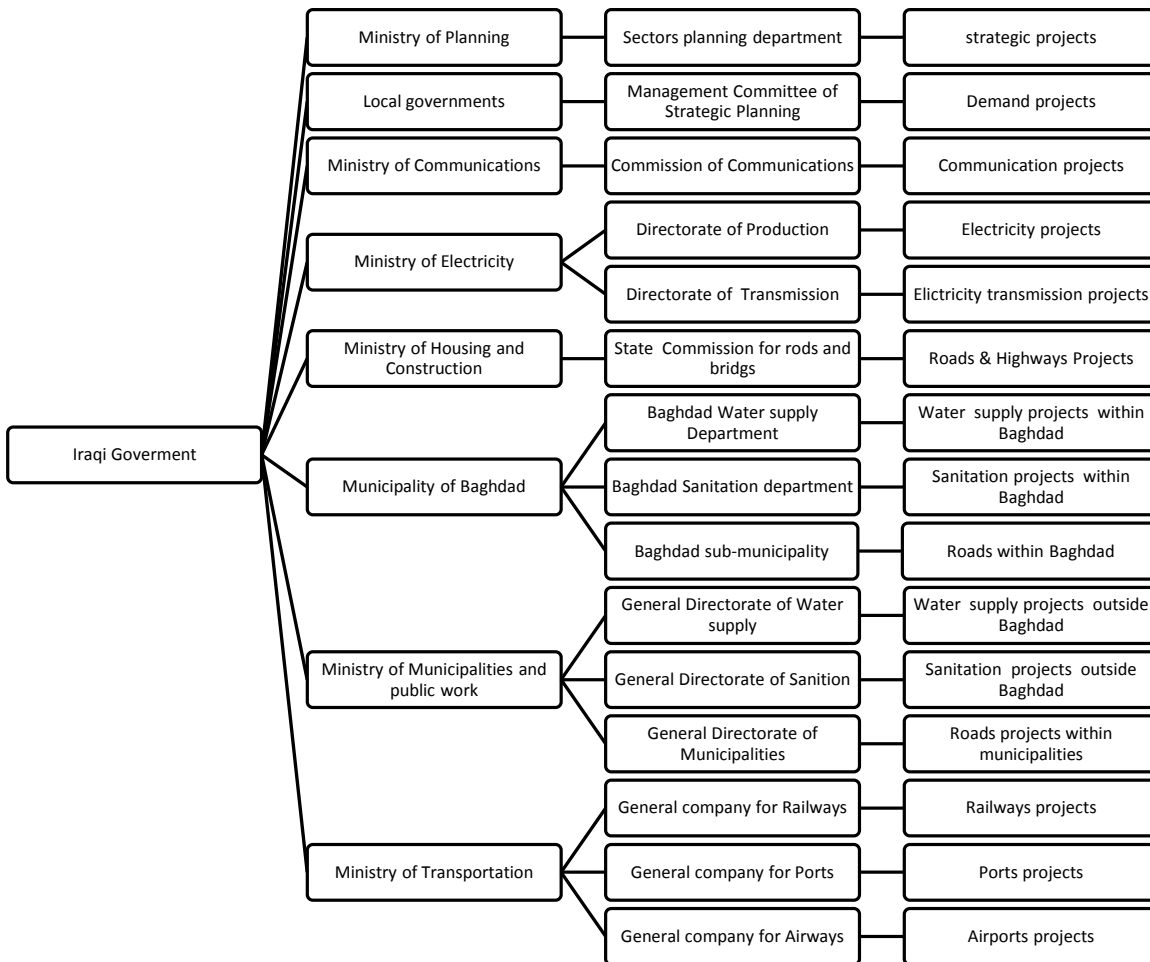

Figure 3-2: Government agencies responsible for the implementation of infrastructure projects²⁴²

²⁴¹ Ministry of Planning: Unsatisfied Basic Needs Mapping and Living Standards in Iraq, 2010, P. 11.
²⁴² Prepared by the author

As mentioned previously, the major source for revenues for the GoI is oil sales. Currently Iraq has the world's third-largest petroleum reserves and the lowest reserve to production ratio of all major oil-producing countries. The country's oil output is well below its production capacity. This is hampered by a lack of a skilled workforce and technical know-how, creaking infrastructure and political instability²⁴³, which had affected government revenues negatively and reduces its finance allocation for the infrastructure projects. Figure 3-3 shows the GoI revenue and expenditure for the period 2007-2014.

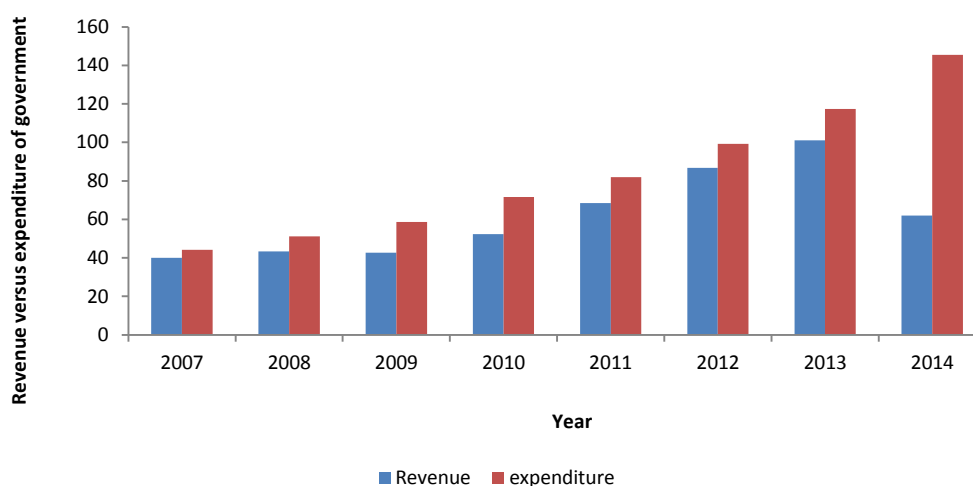

Figure 3-3: Revenue versus expenditure of Iraq government (2007-2014)²⁴⁴

As a result of the previous point, massive gap between the existing infrastructure investment and the projected requirement in Iraq, this has come into sharper focus. The four year plan projection on the total investment required for infrastructure (2007-2010) is over 187 Billion USD. The actual amount of the investment in the same period was amounted to 66 Billion USD, this shows that the deficit in investment is about 65 %. Besides, in 2010-2014 plan the deficit in the financing budget is about 20 Billion USD, as shown in Table 3-1 below.²⁴⁵

Years	Oil barrel price \$	Exports Million barrels per day	Revenues Billion \$	Revenues (Non-oil) Billion \$	Total Revenue Billion \$	Investment ratio	Available investment allocations Billion \$	Required investments Billion \$	Deficit in investment allocations Billion \$
2011	76.5	2.30	63,342	4,000	67,342	0.40	26,937	30,000	3,063
2012	78.5	2.70	76,302	4,400	80,702	0.42	33,895	40,000	6,105
2013	80.5	3.30	95,634	4,840	100,474	0.44	44,209	50,000	5,791
2014	84.5	4.00	121,680	5,324	127,004	0.48	60,962	67,000	6,038
Total							166,002	187,000	20,998

Table 3-1: Iraq's expected overall revenues 2010 – 2014²⁴⁶

²⁴³ Mazhar Mohammed Saleh: Dialectic of Iraq's Infrastructure- Financing and Guarantees. Central Bank of Iraq, 2012.

²⁴⁴ Ministry of Finance: Iraq Budget Reports. Iraq, 2014.

²⁴⁵ Basri, Kamal: The Strategic Choice of the Iraqi Economy. Iraqi Institute for Economic Reform, Baghdad University, 2011, P. 6.

²⁴⁶ Previous reference.

In an inside look to Iraq situation, despite massive reconstruction efforts after war in 2003; it continues to face large gaps in the demand and supply of essential social, economic infrastructure and services. Due to rapidly growing economy, increased industrial activity, burgeoning population pressure and all-round economic and social development had led to greater demand for better quality and coverage of water and sanitation services, sewerage and drainage systems, solid-waste management, roads and seaports and power supply. Increased demand has put the existing infrastructure under tremendous pressure and far outstripped its supply. The Iraqi economy is in a phase of reconstructing damaged infrastructure and providing the basic social services needed by the citizens. This is enabled by the growth of oil revenues, public investment that accounts for nearly 30 % of GDP.

Now, Gol is prioritizing housing, electricity, water, sanitation and transport infrastructure. But in recent years, Iraq has seen significant improvements in security and economic growth. Its economic policy has focused on opening markets and fostering a business-friendly environment to attract private investment and facilitate trade. Also, the Gol intends to involve foreign and national private investors. Plans are elaborated to rebuild the country's infrastructure, including major infrastructure projects estimated to require an investment of 250 Billion USD²⁴⁷ in which the situation is discussed in detail in the next sections.

3.1.1 Status of Railways & Logistics

Iraq's transport and logistics sectors have great potential and are already attracting domestic and international investors to rehabilitate and expand transport infrastructure. The economic reconstruction of the country depends on a reliable transport network. Iraq's strategic location between Asia and Europe gives it a competitive advantage over neighboring countries in terms of trade, and navigation links, and has strong potential for development as both a freight and passenger transport hub.

Construction of Iraq's railway network which is one of the most extensive work carried out in the region was first began by the Germans under the Ottoman Empire in 1912.²⁴⁸ In 2012, the overall length constructed was around 2,370 km of which 1,922 km main lines and 448 km were secondary lines.²⁴⁹ In the CIA Fact book, this was the 66th largest national network. The network length of other national railway networks listed indicates the expansion potential of Iraqi railways: Germany has 41,981 km (6th); Bolivia has 3,652 km (46th); Egypt has 5,083 km (34th) and Cuba has 8,598 km (24th). It is clear that there is potential for vast expansion of the railway network in Iraq to serve its reconstruction and economic advancement. Figure 3-4 shows Iraq railways roads.

²⁴⁷ Mazhar Mohammed Saleh: Dialectic of Iraq's Infrastructure-Financing and Guarantees, Central Bank of Iraq, 2012.

²⁴⁸ Hesham Mohsen: Spatial Analysis of Iraqi Railways, Journal of Literature Faculty, Iraq, Vol. 100, 2012, P. 490.

²⁴⁹ Ministry of Planning: Railways Activity Statistics Report, Iraq, 2010, P.3.



Figure 3-4: Iraq main railways roads²⁵⁰

The system consists of five principal lines from: (1) Baghdad to Basra and Umm Qasr, constructed about 40 years ago and can accommodate 24 trains daily; (2) Baghdad to Mosul and the Syrian border, built about 80 years ago and has a design capacity of 18 trains per day; (3) Baghdad to Al Qaim via Ramadi; (4) Al Qaim to Akashat; and (5) Kirkuk to Baiji and Haditha. The last three lines were built in the mid-1980s. Table 3-2 below provides some characteristics of Iraq's principal rail lines:

Track	Total length Km	Length of tracks/km		No. of operating stations	State
		Sub	Main		
Baghdad - Basrah- Um qasir	802	194	608	41	Working
Baghdad- AL-Kaim - Husaiba- Ukashat	612	92	520	21	Not Working
Baghdad - Mosul- Rabiah	665	148	517	21	Not Working
Kirkuk -beygee – Haklaniya	266	14	252	0	Not Working
Al-Mussyab – Kerbela	25	0	25	1	Working
Total	2,370	448	1,922	84	

Table 3-2: Principal railway lines 2012²⁵¹

²⁵⁰ Ministry of Transportation and Communications.

²⁵¹ Ministry of Transportation and Communications: Report of Railways Activity Statistics, Iraq, 2011.

In 2012 and after many reconstruction and rehabilitation efforts by the Gol, there are 84 stations throughout the system which comprises of 107 stations before 2003 war, with 283 Main locomotives out of 500 locomotives, 1,000 operating wagons of 11,000 different wagons.²⁵²

Moreover, 11 regional offices, 7 maintenance facilities and workshops, a plant for producing concrete sleepers and training institute. However, most equipment and machinery at the workshops, sleeper plant, and training institute were lost due to damage caused by war in 2003 and the looting which followed it.

Prior to the war, there were 30 trains per day. Today, the operation is about one-third of pre-war levels with just 10 daily trains operating on the system. The actual need of the Iraqi railways is about 365 locomotives per day to assure a minimum standard of transportation services. (Previous reference)

Table 3-3 shows the total activity of the Iraqi railroad system for the period 1979–2012.²⁵³ It should be noted that despite increasing the length of railroad lines during this period, railroad transportation activity fell down from millions of passengers and millions of tons of cargo annually to hundreds of thousands. This resulted in a decline in the activity's economic and financial performance. This is primarily due to that large portions of the current railroad network are old, outdated, about 47 %, or 1,130 km of the railway network, are considered to be in poor condition, and have defective signaling and communications systems. This leads to lower operating speeds as low as 30- km/hour because of the poor condition of the tracks, and the deterioration condition of the 25 year old diesel trains which endangers the safety of passengers and loss of cargo.

Year	Length of railroad lines (km)	Number of passengers (1000 passenger)	Transported cargo (1000 Tone)	Income (Million ID)	
				Passengers	Cargo
1979	1645	3,351	6,493	2,286	20,609
1988	2,389	3,865	6,109	8,124	18,990
2002	2,272	1,248	5,227	1,131	22,687
2004	2,272	63	439	57	4,977
2006	2,272	4	165	15	1,049
2008	2,295	107	257	-	-
2010	2,607	212	995	2,394	11,606
2012	2,370	148	850	1,589	10,096

Table 3-3: Total activity of the Iraqi railroad system 1979-2012²⁵⁴

Accordingly, some lines are being renovated for upgrading in order to improve their condition and increase their operating speeds. Work is also being done to double up single railways to increase capacity and ensure a higher level of safety. This is done but at a low level due to the lack of financial allocations and efficiency. Table 3-4 shows that despite the increase in financial

²⁵² United State Department of State: The Future of Iraq Projects. Economy and Infrastructure, Working Group. USA, 2003.

²⁵³ Ministry of Transportation and Communications: Report of Railways Activity Statistics, Iraq, 2011.

²⁵⁴ Ministry of Transportation and Communications.

allocations in the last two years, it is not measuring up to the plan due to lack of financial allocations to the railway sector by Gol for the period 2007-2013.

Year	Planned budget	Actual budget	Percentage
2007	11340	306	3 %
2008	10620	852	8 %
2009	10620	739	7 %
2010	4733	193	4%
2011	4738	263	6%
2012	5028	757	15%
2013	5028	757	15%

Table 3-4: Lack of financial allocations of railways (Million USD)²⁵⁵

The Ministry of Transport (MoT) is responsible for the management, planning and policy of the country's transport system, except for highways, which are the responsibility of the Ministry of Construction and Housing (MoCH). There are fourteen State Owned Enterprises (SOE's) which manage the domestic and international transportation of passengers, goods, and cargo through the General Company of Iraqi Railways (IRR). IRR which was corporatized in 1998 and is an independent entity under the MoT, has overall responsibility for planning, managing, and operating rail services in Iraq.

According to the MoT, the current staffs represented by the Projects Department at the headquarters of the IRR does not have the required experience, skills and executive management to implement the future large-scale projects in Iraq that shown in Table 3-5. (Previous reference)

Agency	No. of employers						Total
	Managers	Engineering	Technical	Administration	Others		
General Company for Iraq Railways (IRR)	1	310	2930	1025	3935		8,201
	PhD	Master	High Diploma	Bachelor	Diploma	others	
	0	3	3	600	648	6947	

Table 3-5: Number of workers by specializing and education level of State Company for railways 2013²⁵⁶

There are about 8,201 employees located at headquarters and in the regional offices of IRR, comparing with about 300,000 employees in the Germans railway(of which about 194,000 are located in Germany), and about 86,000 employees in Egypt. Staffs are technically skilled, but have limited exposure to managerial techniques and the discipline of commercially run

²⁵⁵ Ministry of Transport and Communication: Transport and Communication Sector Report, Iraq, 2011.

²⁵⁶ Iraqi Ministry of Transportation.

organizations.²⁵⁷ At the management level, there are a clear weakness as there are only one high management level (general director of IRR) which highlight the leadership problems faced by the this sector.

In 2005, the MoT completed its Iraq Transport Master Plan after two years of consultations and support from international firms. The Master Plan includes all projects required for transportation activities for the next 20 years. According to the National Investment Commission (NIC) and the Ministry of Transport (MoT), 60 to 100 Billion USD investment is required over the next few years to develop an integrated railways transport network. There are also opportunities to address the ever increasing needs of several sub-sectors, namely storage, road transport haulage, railways, and the maritime and aviation industries.²⁵⁸

According to the Transport Master Plan, it is estimated that between 35 Million and 60 Million tons of cargo will pass through Iraqi ports, and will require the construction of a double railway and a cargo railway network, especially from major cargo-handling ports like al-Faw port at the Arabian Gulf. Table 3-6 shows the quantitative goals for the railroad activity over the five-year plans 2012-2017.²⁵⁹ It details the increase in railroad line lengths, primary and secondary railroad line lengths, stations, as well as passenger and cargo transport capacities.

Year	Increase in line length (km)		Increase in primary, secondary and station line length (km)			Increase in passengers transport capacity (Million passenger)		Increase in cargo transport capacity (Million tone)	
	Yearly	Cumulative total	Yearly	Cumulative total	Cost Million USD	Yearly	Cumulative total	Yearly	Cumulative total
2012	-	1931	-	2915	-	-	1	-	4
2013	-	1931	369	3284	1107	0.5	1.5	1	5
2014	-	1931	200	3484	620	1	2.5	1	6
2015	400	2331	1400	4884	4200	4.2	6.7	38	44
2016	1000	3331	2400	7284	7200	23	29.7	58	102
2017	1500	4831	3375	10659	10125	35	64.7	233	335

Table 3-6: Proposed development plan for the Iraq railway network 2012-2017²⁶⁰

Moreover, to strengthen Iraq's geographical presence as a link between east and west regions, and meet the demand for transit cargo transportation, Transport Master Plan MoT intend to extend the railway network by establishing new railroads in order to connect other cities inside Iraq as shown in Table 3-7, and at the same time also to connect Iraq with neighboring countries to build an efficient and effective infrastructure capable of meeting that demand that will promote railroad links. Most of these projects are delayed or stopped due to lack of financial allocations as mentioned before.

²⁵⁷ World Bank: Iraq Joint Needs Assessment-Transportation & Telecommunications. working paper,2003, P.17.

²⁵⁸ UNIDO: Investment Map for Iraq. Private Sector Development Programme for Iraq, 2011, P.26.

²⁵⁹ Ministry of planning: National Development Plan 2013-2017, 2013.

²⁶⁰ Iraqi Ministry of Transport.

Provincial interconnection routes	Estimated No. of years to complete	Annual allocation (Million US\$)						Estimated cost (Million US \$)
		2010	2011	2012	2013	2014	2015	
Musaiyab- Karbala- Najaf- Samawah	4	270	270	182.5	182.5	-	-	905
Baghdad circular rail link	4	-	603.4	301.7	301.7	301.7	-	1508.5
Baghdad-Baquba- Kirkuk-Irbil-Musul	5	-	905.55	601.7	601.7	601.7	297.85	3008.5
Baghdad-Kut-Amarah- Basra	6	751.5	751.5	751.5	751.5	751.5	751.5	4509
Musul-Dohuk-Zakho- Turkey border	3	-	-	600	600	606.5	-	1806.5
Basra-al Faw peninsula	3	229	172	172.3	-	-	-	573.3
Kirkuk-Sulimaniyah	3	160	160	209.15	-	-	-	529.15
Kerbala-Ramadi	3	-	-	453	453	389.8	-	1295.8
Total		1410.5	2862.45	3272.55	3271.85	2651.2	1049.35	

Table 3-7: New Provincial interconnection railways plan routes in Iraq's²⁶¹

Moreover, the projects meant to connect Iraq with neighboring countries were delayed due to lack of financial allocations and might be continued until reliable feasibility studies for these types of linkage is ready which will also allow to further study the railway infrastructure of Iraq. The current work of the IIR just limited to the routine maintenance and upgrade of some existing lines.²⁶² Table 3-8 shows the proposed links with Iraq neighboring countries.

Interconnection routes	Country connection	Estimated number of years to complete	Estimated cost (Million USD)
Basra-Shalmaja	Iraq-Iran	3	111
Khanakin-Munyiriya	Iraq-Iran	2	40.34
Musul-Zakho-Turkey	Iraq-Turkey	2	133
Baghdad-Amman	Iraq-Jordan	5	1916
Basra-Kuwait city	Iraq-Kuwait	1	30

Table 3-8: Future investment of international links in Iraq's railways²⁶³

²⁶¹ Ministry of Planning: National Development Plan 2010-2014, Iraq, 2010.

²⁶² Ministry of Transport and Communication: Transport and Communication Sector Report, Iraq, 2011.

²⁶³ Ministry of Planning: National Development Plan 2010-2014, Iraq, 2010.

3.1.2 Status of Road Sector

Most of Iraq's road network was developed during the 1970s and 1980s and were designed with a 20 year lifespan. After this period, no significant construction work occurred during the last decade. Total length of the external road network (outside the boundaries of municipalities and the Municipality of Baghdad) is about 48,284 km. The network includes an expressway system of 1,084 km, which consists of one six-lane highway (Highway No. 1 and by Abu Ghraib Highway) connecting Basra in the south with the Jordanian border in the west via Baghdad, and 11,000 km of border roads, which were developed as part of Iraq's military build-up in the 1980s.

Iraq's roads are classified in the following five categories: (1) expressways, with controlled access, grade separated six-lane divided carriageways; (2) primary roads, which are mostly four-lane divided carriageways connecting the Governorates with Baghdad; (3) secondary roads linking towns with the Governorates; (4) Rural or village roads, which provide villages and towns with access to the secondary network; and (5) military/border roads that accommodate the movements of troops and facilitate the protection of borders. Roads accommodate 70 % of all traffic volume in Iraq, and the expressway network alone accounts for 20 % of all traffic.²⁶⁴ In addition, there are 1247 concrete and steel bridges on the Tigris and Euphrates rivers and their branches and valleys and railway lines, and 35 floating bridges scattered throughout the country's provinces. Approximately 85 % of the overall network is paved. Most of the unpaved network consists of secondary and village roads.

Before 2003, Iraq's external road network was relatively good in terms of efficiency and capacity. However, most of it suffered extensive deterioration, destruction, and damage during the war in 2003 and its aftermath. Also, the result of military operations and sabotage, as well as the lack and scarcity of emergency and periodic maintenance operations contribute to its presence condition while reduction of the road network's efficiency and capacity was compounded by loss and damage to instructional signs, warning signs and directional signs on the outer roads and highways.

It is estimated that about 50 % of the expressway system is considered to be in good condition. The percentages of primary and secondary roads in good condition are between 30 % and 20 %. Just 10 percent of village roads are considered to be in good condition as shown in Table 3-9 below. Repair of the existing road network is accordingly one of the priorities in the area of road and bridge activities of Iraq. (Previous reference)

Classification	Length (km)	Condition of Roads (%)		
		Good	Fair	Poor
Expressway	1,084	50	40	10
Primary Roads	11,000	30	65	5
Secondary Roads	15,200	20	70	10
Rural Roads	10,000	10	30	60
Military/Border Roads	11,000	na	na	na
Total	48,284			

Table 3-9: Iraq roads, length, and condition²⁶⁵

²⁶⁴ World Bank: Iraq Joint Needs Assessment-Transportation & Telecommunications, working Paper, 2003.

²⁶⁵ Previous reference.



Figure 3-5: Iraq main roads and highways²⁶⁶

Near total cessation of railroad activities after 2003 war, along with reliance on the road network to transport cargo, put further pressure on the road network, as did lack of control over allowable axle and vehicle weights-which contributed to destroying and devastating large portions of the network. In addition, there was an increase in the number of vehicles entering the country after 2003. This led to increased vehicle circulation among safe provinces, thereby adding pressure on the outer roads, particularly single-lane roads. This was exacerbated by poor traffic control, all of which led to an increase in the number of accidents, particularly fatal ones.²⁶⁷

Moreover, the change in the situation and the absence of authority after 2003, and the deterioration of the security situation in many areas has helped a lot of people, especially farmers to object on the acquisition of their land and to object on the paths of roads and bridges are planned to be located within their land, which caused many problems in the implementation of the work and obstructed paths drawn originally for these roads. This network does not meet the country's needs, particularly with respect to rural roads, which are a fundamental cornerstone of rural community development. According to international standards, each 100 inhabitants/km² needs 1 km/km² of roads; road density in Iraq stands at 0.18 km/km². which refers that this rate need to be increased to 0.75 km/km², that is, the road network needs to be 240,000 km to properly serve Iraq's population of 57 inhabitants/km² (per 1997 statistics). If one

²⁶⁶ Iraqi State Commission for Roads and Bridges.

²⁶⁷ Ministry of Planning: National Development Plan 2010-2014, Iraq, 2010.

excludes uninhabited desert areas, the same criterion would require the addition of 20,000 km of new roads.²⁶⁸

The State Commission for Roads and Bridges (SCRB), which is a Department within the Ministry of Housing and Construction (MOHC), is responsible for all national roads and bridges, including segments of the expressway network located within municipal limits. Municipalities are responsible for all other urban roads within their jurisdiction. SCRB is headquartered in Baghdad and has offices in each of the country's 18 Governorates (including the northern Governorates). Countrywide, SCRB employs about 1,307 staff, of which 217 are engineers. About 25 % of staff is located at headquarters in Baghdad, and the majority of women, which make up around 20 percent of SCRB's overall workforce, hold middle-managerial positions, Table 3-10 below shows Number of workers by Specializing of State Commission for Roads and Bridges in 2013.

Agency	No. of employers				Total
	Managers	Engineering	Technical	Administration	
State Commission for Roads and Bridges (SCRB)	10	217	436	654	1,307

Table 3-10: Number of workers by specializing of State Commission for roads and bridges 2013²⁶⁹

The low level of performance for the road sector is due to the lack of financial allocations and efficiency. Table 3-11 shows the lack of financial allocations of the road sector by Gol for the period 2009-2013, and the total cost the routine and periodic road maintenance for the period

Category	2009	2010	2011	2012	2013
Roads and bridges maintenance	209,250	197,760	226,413	25,918	-
Main bridges maintenance	40,492	8,049	8,543	10,431	-
Highway maintenance	15,553	1,419	1,428	1,452	-
Total	265,296	207,229	236,384	37,802	-
Planned Finance of roads sector	2,221,487	2,221,487	2,616,398	481,321	5,082,363
Actual Finance of roads sector	273,931	273,901	418,924	180,846	588,483
Percentage of financial deficit	12.33 %	12%	16%	38%	12%

Table 3-11: Road maintenance cost and annual financial allocation for the period 2009-2013 in Million USD²⁷⁰

²⁶⁸ Ministry of Planning: National Development Plan 2010-2014, Iraq, 2010.

²⁶⁹ Ministry of Planning, 2013.

²⁷⁰ Previous reference.

The Master Plan of transport included all projects required for transportation activities for the next 20 years. According to the NIC, over 40 Billion USD is required to rehabilitate and to develop an integrated transport network over the country (1 Million USD per Kilometer). Table 3-12 shows the quantitative goals for the road network activity over 2012-2017 plan.

Details	2012	2013	2014	2015	2016	2017	Total
Expressway (km)	-	116	40	282	248	600	1286
Arterial Roads (km)	75	93	146	291	161	175	941
Primary Roads (km)	485	807	775	541	788	1108	4504
Secondary Roads (km)	115	246	104	273	225	185	1148
Concrete Bridges (No.)	8	25	20	16	11	13	93
Other Bridges (No.)	-	8	6	7	4	4	29
Steel Bridges (No.)	-	-	-	-	-	2	2

Table 3-12: Roads length and number of bridges required for 2012-2017²⁷¹

3.1.3 Status of Water Supply Sector

By the early 1990s, the population of Iraq enjoyed a relatively high level of water supply and sanitation services. The sector operated efficiently, utilizing then-current technologies. Water quality was generally good as there were 229 and 1,332 water treatment plants and water treatment units, respectively, operating throughout the country. Urban access to drinkable water was at 95% with an average of 330 liters per person per day (lppd) in Baghdad, and 300-330 lppd in other cities and towns. Even rural area coverage was approximately 75% with an average supply of 250 lppd. Public health indicators confirmed the quantity and quality of the water with minimal water related diseases.²⁷² After 1991 war, As a result, water production immediately fell by 40%.²⁷³

Aging infrastructure, poorly maintained equipment, leaking water networks and low technical capacity and morale are some of the key problems of the sector. The lack of funding led to insufficient imports, lack of maintenance, and curtailment of needed expansion. These services were surpassed by other national priorities, which resulted in a serious degradation of the quality and extent of services delivered. Many Iraqi cities do not have adequate water treatment plants. Even in cities and communities where there are treatment systems, many have fallen into disrepair after years of neglect. At the same time, water systems, with their intricate network of pumps, are constantly strained by regular and frequent power outages.²⁷⁴

²⁷¹ Previous reference.

²⁷² Special Inspector General for Iraq Reconstruction: Review of Major U.S. Government Infrastructure Projects in Iraq-Nassiriya and Ifrac Water Treatment Plants. SIGIR, 2010.

²⁷³ World Bank: Iraq Country Water Resource Assistance Strategy-Addressing Major Threats to People's Livelihoods. 2006.

²⁷⁴ World Bank: Emergency Water Supply. Sanitation and Urban Reconstruction Projects, Technical Annex, Iraq, 2004.

According to the 2010 UNICEF report,²⁷⁵ Population general access to drinkable water has reached 78.7% compared to 98% in Jordan and 85% in Turkey, urban access to potable water fell from 95% to 86.1 %; and rural area fell from 75% to 30 %. However, quantities of water in Baghdad fell from 330 lppd to 218 lppd and in other cities and towns from 250 lppd to 171 lppd. Rural quantities of water fell from 180 lppd to 91 lppd. (Previous reference)

Moreover, it is estimated that 40-50% of the country's water distribution networks, amounting to 40,000 km of pipes and valves, required replacement because of severe corrosion, damage, or old age. The estimated efficiency of the existing drinking water production facilities ranged between 30% and 60% of the design capacity, with water losses amounting to 35% of all water produced, Table 3-13 below shows the average efficiency of the existing drinking water production facilities for the period 2004-2008.

Capacity (lppd)	2004	2005	2006	2007	2008
Design capacity	7,589,324	7,704,633	7,759,250	9,455,905	10,125,560
Actual capacity (Average)	2,441,544	2,443,531	2,524,652	3,335,267	3,459,807
Available capacity Percentage	32 %	32 %	33 %	35 %	34 %

Table 3-13: Design and actual capacity of the existing water production facilities for 2004-2008²⁷⁶

Much of the groundwater along the developed central plain is unusable due to high salinity and pollution. Despite this, 8% of the rural population use saline shallow village wells as a main drinking source. A result of polluted drinking water and poor hygiene practices, 57% of which were among children aged < 5 years old. 41 of every 1,000 children in Iraq die before reaching their fifth birthday. Improved water supply systems are an important part of Iraq's efforts to reduce this figure to 21 by 2015.²⁷⁷

Moreover, the shortfall in the capacity of the raw water network and its absence altogether in most areas has resulted in the use of drinking water to water public and private gardens. In addition to the aforementioned, the lack of use of modern techniques and equipment in filtering and pumping water and the old equipment is being used in laboratories and poor qualifications of those working on them. Statistics compiled by the Iraqi Ministry of Planning and Development Cooperation indicate that the inadequate number of employees of management, specialized and workers have resulted in poor water quality. Moreover, the limited capabilities of workers, their poor quality led to poor quality of accomplished projects.²⁷⁸ In addition, during the 2003 war, the water sector experienced significant personnel losses from foreign experts who leave Iraq. Specifically, 55% of the water sector staff, primarily high-level managers, experienced engineers, and high-level operations and maintenance staff left the country and the positions were never filled.²⁷⁹

²⁷⁵ Special Inspector General for Iraq Reconstruction: Review of Major U.S. Government Infrastructure Projects in Iraq: Nassiriya and Ifrac Water Treatment Plants, SIGIR, 2010.

²⁷⁶ Ministry of Municipalities and Public Works: Report of Water and Sanitation Sector. Iraq, 2011.

²⁷⁷ UN Iraq: Water in Iraq Factsheet. Iraq Joint Analysis and Policy Unit, 2013.

²⁷⁸ Baghdad Provincial Council: 2008-2012 Strategic Plan Report, Iraq, 2007.

²⁷⁹ Doyle, Brendan: Iraq Watching Briefs – Water and Environmental Sanitation, UNICEF, 2006.

From Table 3-14 (a) below it can be note that despite of the lack of the government allocations that allocated to this sector, as well as the expenditure ratio is low as a result of the low rates of implementation, which indicate weakness of staff implementing projects. Moreover, Table 3-14 (b) shows the lack of the financial allocation by the government for the water supply sector for the period 2010-2013.

Year	Annual allocation M \$	Expenditure M \$	Percentage of Expenditure
2004	56,410	39,370	70%
2005	38,461	6,121	16%
2006	118,803	81,196	68%
2007	128,204	47,862	37.3 %
2008	445,652	270,853	60%

(a) Annual allocations and expense of water supply projects during the period 2004-2008 in Million USD

Year	Planned budget M \$	Actual budget M \$	Percentage
2010	7,731	1,293	17%
2011	7,753	0.892	12%
2012	8,348	0.978	12%
2013	8,289	0.987	12%

(b) Lack of the financial allocation by the government for the period 2010-2013 in Million USD

Table 3-14: Annual allocations and expense of water supply projects²⁸⁰

The shortfall of the electricity is considered as one of the important factors that affecting the water supply services. The necessary electrical power for operating all the water supply system is about (550) MW. The total number of existing generators is (825) generators distributed on the projects and water compact units with different capacities, and generally sufficient to insure (20%) of the production quantity for one project. The total electrical power that has been produced by these generators is 125 MW – 12 hour operation per day.²⁸¹

Water supply in Iraq is produced and processed by three parts:(1) Ministry of Municipalities and Public Works (MoMPW) by the for 14 provinces; (2) Municipality of Baghdad by Baghdad Water Directorate, (3) Ministry of Municipalities and Public Works of Kurdistan region . Table 3-15 shows the workers number in the management of the Iraqi water sector, of which only 16 at the management level, which highlights the leadership problems faced by the whole sector.

Agency	No. of employers						Total
	Managers	Engineering	Technical	Administration	Services	Others	
Water Sector employers	16	4,122	7,182	210	13,292	10,253	35,712

Table 3-15: Number of management and technical employers of Iraq water sector 2012²⁸²

²⁸⁰ Ministry of Municipalities and Public Works: Report of Water and Sanitation Sector, Iraq, 2011.

²⁸¹ General Directorate for Water: Water Demand and Supply in Iraq-Vision. Approach and Efforts, Ministry of Municipalities and Public Works, Iraq, 2011.

²⁸² Ministry of Planning: Water Sector Report. Central Organization for Statistics, Iraq, 2011

In 2012 and after many reconstruction and rehabilitation efforts by the GoI, the number of projects is 271 projects, in addition to 3,155 water units with different production capacities distributed across all provinces and rural areas. The quantity of water production for all Iraq except Kurdistan region is (11,564,064 m³/day) and the actual demand of which (13,967,417 m³/day), the shortage is about (2,403,353 m³/day) or 18 % of the water demand level, the percentage of the served population is 68 % as noted in Table 3-16.

Governorate	Number of active projects (m ³ /day)	Actual capacity (m ³ /day)	Number of collect water units (m ³ /day)	Capacity (m ³ /day)	Total capacities (m ³ /day)	Population 2012	Total demand (m ³ /day)	Shortage %
Ninawa province	41	727,591	98	184,254	911,845	3,353,875	1,039,701	12%
Kirkuk province	16	393,876	215	265,936	659,812	1,432,747	802,338	18%
Salahadin province	20	336,200	189	311,907	648,107	1,441,266	720,633	10%
Diyala province	25	237,043	147	219,366	456,409	1,477,685	664,958	31%
Alanbar province	21	372,418	485	706,655	1,079,073	1,598,822	1,151,152	6%
Area Surrounding Baghdad province	11	416,080	258	477,171	893,251	2,726,715	1,390,625	36%
Babil province	18	245,920	266	531,555	777,475	1,864,124	894,780	13%
Karbala province	7	242,620	124	215,283	457,903	1,094,281	503,369	9%
Najaf province	13	248,960	118	233,270	482,230	1,319,608	527,843	9%
Qadisiyyah province	15	198,773	175	188,531	387,304	1,162,485	464,994	17%
Wasit province	21	185,500	255	376,499	561,999	1,240,935	645,286	13%
Muthana province	8	157,017	69	120,701	277,718	735,905	331,157	16%
Dhi Qar province	18	109,140	204	324,456	433,596	1,883,160	621,443	30%
Maysan province	14	108,600	230	383,222	491,822	997,410	558,550	12%
Basrah province	15	237,000	278	949,520	1,186,520	2,601,790	1,300,895	9%
Baghdad province	8	1,071,000	44	788,000	1,859,000	4,699,386	2,349,693	21%
Total	271	5,287,738	3,155	6,276,326	11,564,064	29,630,194	13,967,417	

Table 3-16: Supply and demand data of water for 15 Iraqi provinces except Kurdistan region 2010²⁸³

²⁸³ Ministry of Planning: Water Sector Report, Central Organization for Statistics, Iraq, 2012.

Our assumption is that Iraq's demand on water will continue to grow into the coming years, by calculating the growth rate of Iraq for the last years (which is 2.6%), it can be estimate that Iraq population will reach 40 million by 2020, and the water demand will reach (14,000,000 m³/day), comparing with the 2012 demand of which (13,967,417 m³/day), this indicate the importance of getting solutions by spending to improve the water supply services in Iraq.

Water tariffs in Iraq are extremely low compared to other countries. Data available from 2010 show that for domestic users a block tariff is applied that includes water services, with a lower limit of 2 ID (0.0017 USD), and an upper limit of 7.5 ID (0.0064 USD) for consumption rates below 90M³ per month, and 20 ID (0.017 USD) if above that. These tariff levels are very low. Clearly, these tariffs are purely symbolic and have no relation to the actual cost of service provision. As a consequence of low tariffs, revenues are insufficient to cover the cost of water supply and sanitation, as they cover only 2-5 % of the costs of operation and maintenance. It could be argued, therefore, that the tariff structures and levels not only are conducive to abusive use of potable water but also cannot be justified on the grounds of affordability. According to the National Development Plan of 2013-2017 the Gol intend to construct 140 new water supply projects as shown in Table 3-17.

3.1.4 Status of Wastewater Sector

Prior to the Gulf War in 1991, the sanitation services in Iraq were covering about 75% of the urban population (25% related to sewage systems and 50% with septic tanks on-site), and about 50% in rural areas.²⁸⁴ After 1991, the sanitation sector has declined considerably; this percent has decreased due to the 2003 conflicts and sanction, the actual capacities were no more than one-third of the design capacities. In 2005, the Iraq environmental survey showed that 31.6 % of the processing stations were operational, and 31.6 % of the stations were partially operational and 36.8 % were idle. According to the 2010 UNICEF report,²⁸⁵ 24 % of the people were served by the sewer systems, and 60 % with septic tanks on-site and 16 % were not served by either,²⁸⁶ compared with 61% in Jordan and 73% in Turkey. Moreover, 89.5% of the Iraqi provinces suffer from the rash of sewage in the case of rainfall.

These systems of sanitation were either suffering from bad planning and design, or had been operated without adequate maintenance, as well as the end of operational life for many of the components of sanitary institutions, of which Iraq sanitary network was implemented by concrete pipes since the beginning of the sixties, leading to low rates of waste water treatment and often of poor quality.²⁸⁷ The damaged sewers estimated to be about 75 % of the existing sewers.²⁸⁸

However, Sewage network consists of sub-networks with diameters of (250-600) mm and major networks, including the main sewage lines with diameters of (700 mm - 3m) and a total length of approximately 993,840 km. They are of two types:

²⁸⁴ UNICEF: Iraq Watching Briefs-Water and environmental sanitation. 7/2003, P. 2, 7-8.

²⁸⁵ Special Inspector General for Iraq Reconstruction: Review of Major U.S. Government Infrastructure Projects in Iraq: Nassiriya and Ibrah Water Treatment Plants, SIGIR, 2010.

²⁸⁶ Ministry of Planning: National Development Plan 2010-2014, Iraq, 2010, P.110.

²⁸⁷ Bakir, H. A.: Sustainable Wastewater Management for Small Communities in the Middle East and North Africa. Journal of Environmental Management, Vol. 61(4), 2001, P. 319-328.

²⁸⁸ Ministry of Planning: National Development Plan 2010-2014, Iraq, 2010, P. 90.

Seq.	Governorate	Projects No.	Estimated Cost (x1000 US \$)	Estimated Duration (year)	Capacity (m3/hr.)	Annual allocation (x1000 US\$)				
						2013	2014	2015	2016	2017
1	Ninawa	12	1,287,924,786	1-5	72000	54356410	13931624	303418803	210256410	183760684
2	kirkuk	11	739,316,239	2-3	34000	2606838	9401709	188461538	136752137	30769231
3	Salah al-Din	11	941,780,342	1-5	123000	40192308	76495726	264786325	202136752	152136752
4	Diyala	12	1,051,282,051	3-4	50000	55606838	26068376	292307692	193162393	182905983
5	Anbar	24	1,604,813,675	2-5	77000	32808547	80341880	394700855	320512821	258974359
6	Baghdad	8	658,119,658	1-4	61000	65278632	14102564	85470085	68376068	68376068
7	Babil	6	551,282,051	3-4	32000	70952137	36752137	175213675	111111111	61111111
8	Wasit	12	721,342,735	1-4	93500	65319658	30769231	234188034	179487179	82051282
9	Dhi Qar	5	351,282,051	2-4	21000	113730769	29914530	38461538	8547009	8547009
10	Karbala	4	418,849,573	2-3	18000	5375214	13247863	29914530	25641026	4273504
11	Najaf	7	578,938,462	1-3	37500	3418803	4273504	179487179	123931624	85470085
12	Qadisiyyah	8	399,005,983	1-4	22000	15755043	30769231	92307692	45726496	29059829
13	Muthana	5	367,990,598	3-4	18000	19518803	8547009	94017094	94017094	68376068
14	Maysan	10	743,589,744	1-4	44000	125651282	11111111	166666667	98290598	85470085
15	Basrah	5	912,134,188	3-5	43000	18376068	170940171	275228205	81196581	307692308
Total			11,327,652,137			688,947,350	556,666,667	2,814,629,915	1,899,145,299	1,608,974,359

Table 3-17: Number of new water projects in 2013-2017 plan²⁸⁹²⁸⁹ Ministry of Planning.

- Separated sewage network: It consists of a sanitary network and network of rain water. Sanitary network was implemented by concrete pipes since the beginning of the sixties. They have been end-of-design, and suggesting the need to renew the sanitary sewage networks in different regions. Moreover, rain water sewage network consists of the old - rain water sewage network, and was usually carried out for the main streets and lead to a set of sewage lines connecting to the pumping stations where their water is drained to the river directly. In the early eighties, the major lines of rain water, of (3 m) in diameter were implemented and connected with the main pumping stations, and their water drained directly to the river.
- Common sewage network: serve most areas of the districts of Iraq, and have been implemented in the early eighties.

In Baghdad, the Sewage Directorate has prepared a (Master Plan) since eighties. This Master plan includes the implementation of many projects. The caused circumstances which faced Iraq at that time prevented the implementation of the above projects which impact negatively on the sewage service in the city of Baghdad. This led to the emergence of problems faced the city's sewage system and since many years.

There are many factors which impede Iraq's progress towards improving the sanitation sector, including technical issues, funding problems and the existence of appropriate institutions to provide services, these problems can be summarized as follows:²⁹⁰

- Expiration of the design age of the old concrete networks implemented in the early sixties of the last century and the emergence of a number of soil collapse locations in the overlying soil.
- Inadequacy of the main carrier lines as a result of expansion in the implementation of sewage networks during the last period.
- Lack of design capacity for the sewage treatment projects, in compare to the expected incoming of waste water.
- The aging of sewage pumping stations and the need to increase their capacity due to increase of population. This requires long-term solutions to solve the problem of unserved areas by implementing a range of projects including the expansion projects of purification, the implementation of the main lines carrier with major pumping stations.
- The use of technologies suited to the environment, is one of the factors limit the efforts to increase sustainable access to sanitation in Iraq.
- In addition, of the major challenges facing the sanitation sector is the capacity building, including development of human resources. It has been reported widely in Iraq that most of the institutions working in the sanitation sector have collapsed, and many professionals have left the country.²⁹¹ Thus, the need for institution building and capacity-building in various forms and at all levels of decision-making is essential for the implementation of the sanitation strategy. In addition, the fact that most of the country's higher education and research institutions responsible for developing appropriate solutions and provide training associated with it, are not work at full capacity.²⁹²

²⁹⁰ Abdul Jabbar Khalaf: Status of Waste Water in Iraq. Pare Submitted to Ministry of Water Resources (MoWR). Iraq, 2011.

²⁹¹ UNDP: Iraq: Country Programme Performance Summary, 2009.

²⁹² UNICEF: Iraq Watching Briefs- Water and Environmental Sanitation. 7/2003, P. 2, 7–8.

- Finally, the importance of technical capacity for providing services, and can adapt innovative technologies and of services delivery systems to meet the needs of families. This is one of the major problems in Iraq, as there is a shortage of technical experts.

From the Table 3-18 below, it is clear that there is a lack of the governmental allocations allocated to sanitation projects in Iraq, by comparing the allocated finance for the period 2004-2012 with the required allocation cannot be promoting this sector which reflected negatively on the level of services offered to citizens, as well as the expenditure ratio is low as a result of the low rates of implementation, which indicate weakness of staff implementing projects.

Sanitation projects operation are almost entirely financed from the central government budget and are managed by three parts: (1) Ministry of Municipalities and Public Works (MoMPW) by the for 14 provinces; (2) Municipality of Baghdad by Baghdad Sanitation Directorate,(3) Ministry of Municipalities and Public Works of Kurdistan region.

Year	Required Annual allocation Million \$	Actual Annual allocation Million \$	Percentage1 *	Percentage 2 **
2004	233,974	46,794	20 %	69 %
2005	236,119	59,029	25 %	64 %
2006	258,720	47,863	18 %	32 %
2007	433,212	113,675	26 %	100 %
2008	1,535,904	376,296	24 %	89.5 %
2010	3,902,475	545,259	14%	60 %
2011	4,436,572	614,533	14%	72 %
2012	5,953,652	947,312	16%	68 %
2013	6,890,273	956,840	14%	79 %

* Between required annual allocation and the actual Annual allocation

** This percentage represents the actual expenditure from the actual annual allocation

Table 3-18: An annual financial allocation of wastewater projects during the period 2004-2013 in Million USD²⁹³

The national General Directorates of MoMPW provide administrative, financial and technical support to each Governorate and municipality. Moreover, they are responsible for overseeing water distribution systems, sewerage, and other municipal services, and to oversee installation and maintenance of water facilities. They also set and oversee the standards for design and operation for all municipal services. Table 3-19 shows the workers number in the management of the Iraqi sewage sector, of which only 15 at the management level, which highlight the leadership problems faced by the whole sector.

In 2013 and after many reconstruction and rehabilitation efforts by the GoI there are 197 waste water treatment plants (STPs), and 369 waste water pumping stations treating 1,527,325 cubic

²⁹³ Ministry of Municipalities and Public Works: Report of Water and Sanitation Sector, Iraq, 2011.

meters per day , or 557,473,625 cubic meters per year across the country.²⁹⁴ The proportion of the population served by sewage services is (30%), as shown in the Table 3-20.²⁹⁵

Agency	No. of employers						Total
	Managers	Engineering	Technical	Administration	Services	Others	
Sewage Sector employers	15	506	1473	1116	3149	1120	7366

Table 3-19: Number of employers in the sewage sector²⁹⁶

Seq.	Governorate	Design capacity (m3/day)	Population 2012	No. of people served	% served people	The No. of sewage stations	The No. of pumps	Length of networks (km)
1	Ninawa province	17820	3513215	686713	19.5%	5	14	51
2	Kirkuk province	3500	1376053	313905	22.8%	2	5	26
3	Salahadin province	59000	1380216	262000	19.0%	16	62	345
4	Diyala province	21600	1490452	522610	35.1%	1	0	74691
5	Alanbar province	7000	1587114	435500	27.4%	6	12	125
6	Area Surrounding Baghdad province	3000	2897474	2346953	81.0%	13	10	7500
7	Babil province	12000	1846326	455000	24.6%	4	22	128
8	Karbala province	41000	1084362	165000	15.2%	7	14	224
9	Najaf province	42000	1342269	380000	28.3%	19	17	125
10	Qadisiyyah province	12000	1203127	150000	12.5%	0	31	175
11	Wasit province	11966	1234084	251000	20.3%	6	0	-
12	Muthana province	5000	782874	120000	15.3%	5	5	16277
13	Dhi Qar province	18000	1979388	395000	20.0%	14	11	13617
14	Maysan province	36000	1025862	440000	42.9%	31	68	120
15	Basrah province	118100	2647754	450000	17.0%	65	98	866436
16	Baghdad province	680000	4699386	3699570	78.7%	3	0	14000
Total		1,087,986	30,089,956	11,073,251	30.0%	197	369	993,840

Table 3-20: Sewage projects present in the Governorates except provinces of Kurdistan²⁹⁷

²⁹⁴ Dunia Frontier Consultants: Water and Sewage Sectors in Iraq-Sector Report. Washington DC, 2013.

²⁹⁵ Abdul Jabbar Khalaf: Status of Waste Water in Iraq. Paper Submitted to Ministry of Water Resources (MoWR), Iraq, 2011.

²⁹⁶ Ministry of Municipalities and Public Works, 2012.

²⁹⁷ Iraqi Ministry of Municipalities and Public Works, 2013.

The Ministry of Municipalities and Public Works have developed a strategic plan for the implementation of giant sanitation projects, in the centers of cities and Kadaa (sub Governorate), while in Al Nahiya (sub Kadaa) and rural areas, a treatment units will be supplied and set up . One of the main goals of the plan is to raise up the sanitation services from 25.3 % to 53 % by 2017. Table 3-21 shows the sanitation projects for the period 2010-2015.

Sanitation tariffs in Iraq are extremely low compared to other countries. Data available from 2010 show that for domestic users a block tariff is applied as a part of water tariff which reflect on the negatively on revenue (See section 3.1.3).

Seq.	Project	Governorate	Estimated cost (x1000 USD)	Estimated duration (year)	Annual allocation (x1000 US\$)					
					2010	2011	2012	2013	2014	2015
1	Mosel sewage project/1 st stg.	Ninawa	750,000	4	300000	150000	150000	150000	-	-
2	Kirkuk sewage project/1 st stg.	kirkuk	735,000	4	235000	200000	150000	150000	-	-
3	Hawijah sewage project	kirkuk	53000	3	25000	14000	14000	-	-	-
4	Daquk sewage project	Kirkuk	12000	3	-	-	4000	4000	4000	-
5	Baiji sewage project	Salah al-Din	74000	3	34000	20000	20000	-	-	-
6	Tuz sewage project	Salah al-Din	105000	3	-	45000	30000	30000	-	-
7	Shirgat sewage project	Salah al-Din	41000	3	-	-	21000	10000	10000	-
8	Dour sewage project	Salah al-Din	18000	3	-	-	8000	5000	5000	-
9	Hit sewage project	Al-Anbar	74000	3	-	34000	20000	20000	-	-
10	Haditha sewage project	Al-Anbar	60000	3	-	25000	25000	10000	-	-
11	Rawa sewage project	Al-Anbar	14000	3	-	4000	5000	5000	-	-
12	Al khalis sewage project	Diyala	74000	3	-	34000	20000	20000	-	-
13	Mugdadiyah sewage project	Diyala	60000	3	-	30000	15000	15000	-	-
14	Khan Beni Saad sewage project	Diyala	25000	3	-	10000	7000	8000	-	-
15	Kanaan sewage project	Diyala	15000	3	-	5000	5000	5000	-	-
16	Al Medayn sewage project	Baghdad	24000	3	-	14000	5000	5000	-	-
17	Al Tarmiya sewage project	Baghdad	20000	3	-	5000	10000	5000	-	-
18	Al Hai sewage project	Wasit	88000	3	48000	20000	20000	-	-	-
19	Al Zubaidiya sewage project	Wasit	11000	3	-	-	-	5000	4000	-
20	Al Hilla sewage project /2nd stg.	Babil	420000	3	200000	110000	110000	-	-	-
21	Al Mussiab sewage project	Babil	76000	3	36000	20000	20000	-	-	-
22	Al Kasim sewage project	Babil	53000	3	-	-	-	23000	15000	-
23	Iskandariya sewage project	Babil	85000	3	-	-	-	35000	25000	-
24	Mahaweel sewage project	Babil	26000	3	-	-	-	16000	5000	-
25	Al Hussianiya Asewage project	Najaf	16000	3	6000	5000	5000	-	-	-

26	Al Mishkhab sewage project	Najaf	48000	3	24000	12000	12000	-	-	-
27	Manathira sewage project	Najaf	48000	3	24000	12000	12000	-	-	-
28	Al Abassiya sewage project	Al-Qadisiyah	5000	2	-	-	-	3000	2000	-
29	Al Hamza sewage project	Al-Qadisiyah	60000	3	25000	20000	15000	-	-	-
30	Ifach sewage project	Al-Qadisiyah	31000	3	11000	10000	10000	-	-	-
31	Dagharra sewage project	Al-Qadisiyah	11000	3	-	-	-	6000	3000	-
32	Ghammas sewage project	Al-Qadisiyah	22000	3	-	-	-	12000	6000	4000
33	Al Khidhir sewage project	Muthnah	34000	3	14000	10000	10000	-	-	-
34	Ali Al Gharbi sewage project	Maysan	10000	3	5000	2500	2500	-	-	-
35	Kalat Salih sewage project	Maysan	10000	3	5000	2500	2500	-	-	-
36	Kumait sewage project	Maysan	6000	3	-	-	-	3000	2000	-
37	Ali Al Sharqi sewage project	Maysan	5000	2	-	-	-	3000	2000	-
38	Al Kahlaa sewage project	Maysan	14000	3	-	-	-	8000	3000	3000
39	Al Shatra sewage project	Dhi Qar	168000	3	68000	50000	50000	-	-	-
40	Suq Al shiyookh sewage project	Dhi Qar	109000	3	49000	30000	30000	-	-	-
41	Al Chibayish sewage project	Dhi Qar	24000	3	-	-	-	14000	5000	-
42	Al Basrah sewage project/ 4th ,5th Stg.	Muthnah	609000	4	234000	125000	125000	125000	-	-
43	Al Qurna sewage project	Basrah	74000	3	25000	25000	25000	-	-	-
44	Al Mdiana sewage project	Basrah	34000	3	-	12000	12000	10000	-	-
45	Abu Al khasib sewage project	Basrah	170000	3	50000	50000	70000	-	-	-
46	Shatt Al Arab sewage project	Basrah	87000	3	-	30000	30000	27000	-	-
Total			4,508,000		1,367,000	1,136,000	1,050,000	802,000	91,000	7,000

Table 3-21: Proposed plan for the new sewage projects for years (2010-2015)²⁹⁸

3.1.5 Statuses of Electricity Sector

Electricity is one of the most critical issues in Iraq, as being one of the most important public services to be provided, the performance of the public sector deteriorated due to physical damage after 2003 war, lack of government supervision, and scarcity of resources. Repeated pledges for administrative reforms did not materialize and the performance of the public sector did not improve. The government considered restructuring and reforming public enterprises, which required significant financial resources that were lacking. No doubt the epileptic performance of the energy sector, in terms of matching supply with demand expectations, has

²⁹⁸ Previous reference.

led to a decline in the living standard of the population and hampered sustainable development in the country. Despite a significant increase in grid-based electricity capacity in recent years, it is still far from being sufficient to meet demand.

Electricity generation is dominated by thermal power plants that use oil and natural gas as fuel, a small proportion is produced by hydroelectric power plants.²⁹⁹ The hydropower stations normally covered 19% of the total production as shown in

Figure 3-6; however, this figure is now less due to drought and added upstream usage by other countries.³⁰⁰

Iraq’s electricity infrastructure consists of a network of (1) Power Plants that produce power; (2) transmission stations and lines that transmit power from power Plants to distribution networks; (3) distribution stations and lines that move power to the end users; and (4) monitoring and control system, under development, which is a centralized communications and control system under development, designed to monitor system performance and control distribution of power.

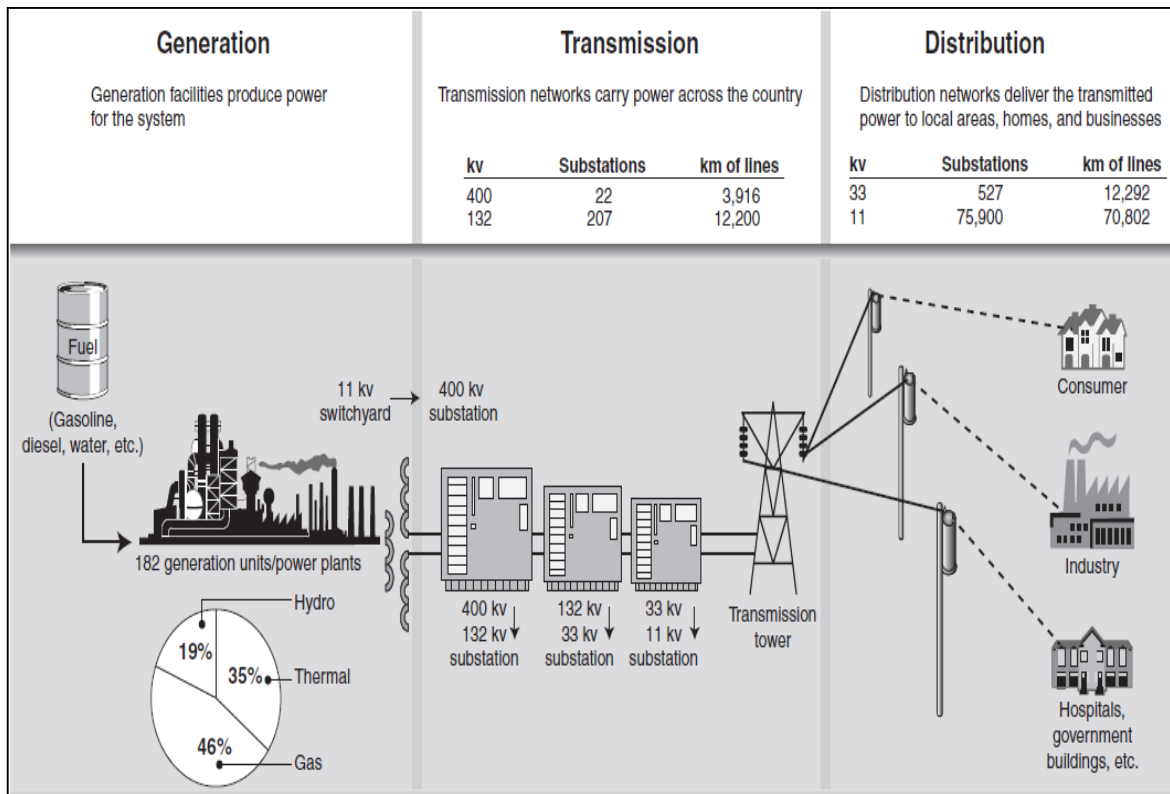

Figure 3-6: Electricity system in Iraq³⁰¹

²⁹⁹ Austin, C., Borja, R., & Phillips, J.: Operation Solar Eagle-A Study Examining Photovoltaic (PV) Solar Power as an Alternative for the Rebuilding of the Iraqi Electrical Power Generation Infrastructure. Monterey, California, Naval Postgraduate School, 2005.

³⁰⁰ UNAMI: Overview of Iraq’s Electricity. UNDP Iraq, Baghdad, Iraq, October 2008.

³⁰¹ GAO. : Integrated Strategic Plan Needed to Help Restore Iraq’s Oil and Electricity Sectors. Washington, United States Government Accountability Office, 2007.

Since the end of the 1990s the electricity sector has suffered from a severe shortage in electricity generation capacity (around 85-90% of Iraq national power grid and 20 power stations was damaged or destroyed in the 1990 Gulf war),³⁰² resulting in reduction in performance of transmission and distribution to the households, commercial and industrial sectors. The per capita electricity consumption in Iraq reached a very low level due to lack of supply of reliable electricity.

The per capita consumption of electricity averages was reduced to 1100 kWh annually compared to 16,122 kWh in Kuwait and 8,161 kWh in Saudi Arabia and 2,709 kWh in Turkey.³⁰³ It is in a striking contrast to the consumption recorded in advanced industrialized countries, which is in the amount 7000 kWh per person per year. The insufficient electricity production in Iraq has had a detrimental adverse effect on the economic and social development, and the overall well-being of the population. Not being able to meet the demand for power generation has impeded the development of the economy, affecting adversely, in particular the industrial, agricultural, commercial and educational activities in the country.³⁰⁴

3.1.5.1 Iraq Power Sector: Past and Present

In 1990, the Installed power capacity was 9,295 megawatts (MW), about 90 percent of it was damaged during the 1991 Gulf War and full recovery never occurred. In 2003, Iraq had a generating capacity of around 3,300 MW, with a consumption rate of a 4,650 MW which is enough to supply power to satisfy only a portion of the total peak demand which estimated to be on the order of 6,500 to 7,000 MW, as shown in Figure 3-7.³⁰⁵

Beginning in 2004 with the end of military acts, the Coalition Provisional Authority CPA was formed to prevent the state of chaos and to start rebuilding Iraq. CPA worked with different organizations and agencies to start rebuilding the electricity sector. The United States Army Corps of Engineers USACE was responsible for the Restore Iraqi Electricity (RIE) Program which included 66 projects and beginning from September 2003. It was funded with 1.4 Billion USD, 59 out of 66 projects were completed by end of 2004. At the end, the project added 1,348-MW of power to electrical grid; however, the intermediate goal of 6,000-MW was not achieved.³⁰⁶ However, demand grew much faster. So, throughout the 2003 till 2011, Iraqi households received only about an average of 8-15 hours' per day supply of electricity from the public network. The country experienced a serious shortage of power that led to power outages for households and business.

³⁰² United State Department of State: The Future of Iraq Projects. Economy and Infrastructure, Working Group. USA, 2003.

³⁰³ World Bank: Electrical Power Consumption kWh Per Capita, 2011.

³⁰⁴ UNDP: Opportunities for IPP Investment in Iraq-Partnership for Power Generation. Dead Sea, Jordan, 2008.

³⁰⁵ USAID: Audit of USAID/Iraq's Electrical Power Sector Activities. Report No. E-267-05-003-P., 2005.

³⁰⁶ Austin, C., Borja, R., & Phillips, J.: Operation Solar Eagle-A Study Examining Photovoltaic (PV) Solar Power as an Alternative for the Rebuilding of the Iraqi Electrical Power Generation Infrastructure. Monterey, California: Naval Postgraduate School, 2005.

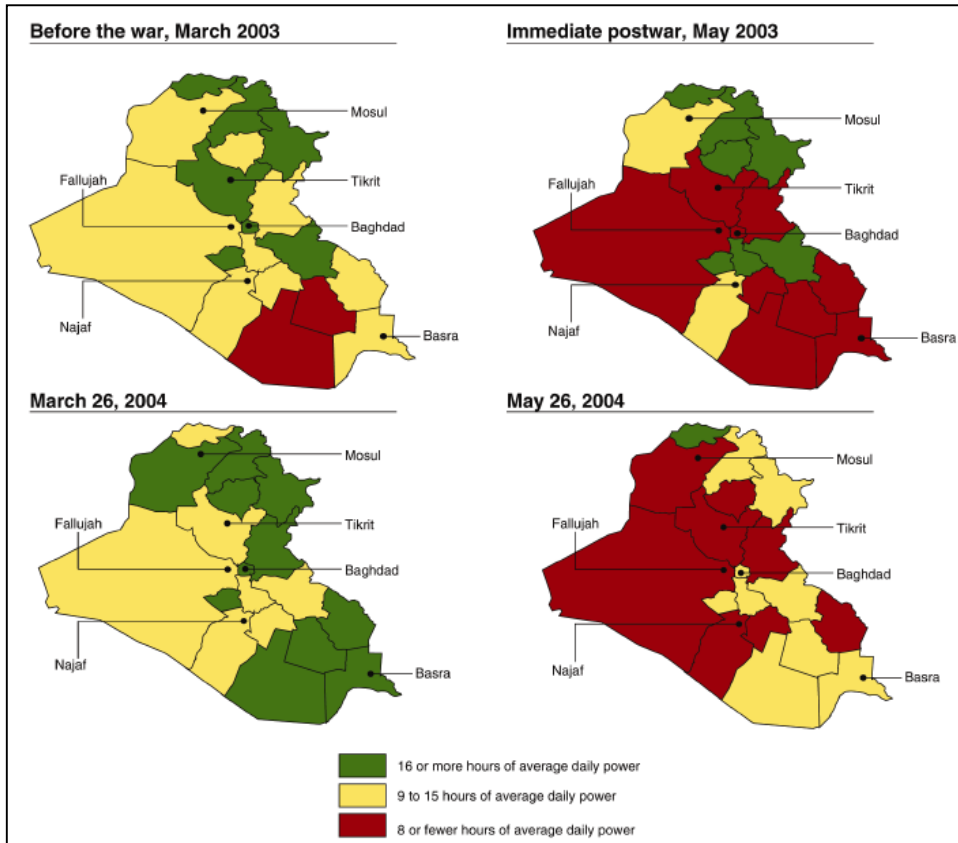

Figure 3-7: Electricity Distribution Pre- and Post-war³⁰⁷

As of 2008, households were the largest consumers of electricity at 58%, with the government and industrial sectors at 16% and 14% respectively. Agriculture remains a small consumer at 4%, as shown in Figure 3-8. The proportion of consumption by households has increased significantly since 2003 due to two key reasons: i) households’ purchasing power has increased as a result of increased salaries for public servants and strong remittances from abroad; and ii) foreign imports of relatively inexpensive electrical appliances and air conditioning has helped to boost household demand.

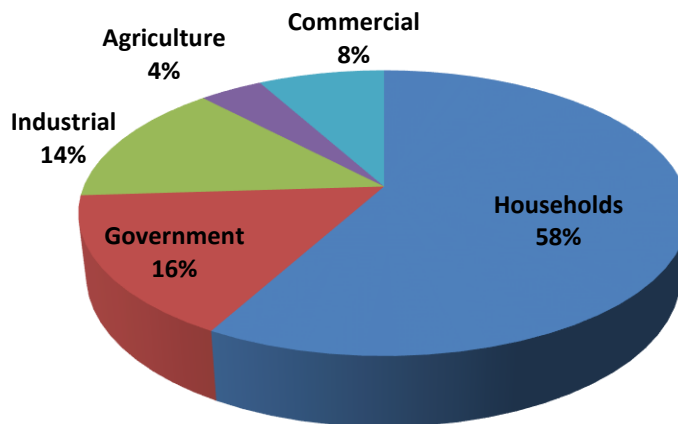

Figure 3-8: Supplied energy by sector in Iraq³⁰⁸

³⁰⁷ Previous reference.

³⁰⁸ Ministry of Electricity 2008.

In 2009, the electrical consumption was about 11,248 MW. Moreover, according to the Ministry of Electricity the average electrical consumption in 2011 was about 12,000 MW (four times what it was in 2003). In 2013 the peak demand goes to 15,000 MW while the generation capacity to about 6000. Given all the above, the conclusion would be that less than 50% of energy demand is met. In spite of some additions to capacity over the past decade, the demand was going much higher due to the increase in purchase power of Iraqi households together with more affordable electric appliances especially air conditioning units.³⁰⁹ The figure 3-9 below shows the gap between production and demand in the last 14 years.

In 2012, cumulative supply on Iraq's grid, drawn from all sources averaged about 8,400 MW, which was 3,225 MW higher than the total output from government power plants. Two-thirds of the increase from 2004 to 2012 came from these other sources:

- **Private Power Plants in the Kurdistan Region:** These facilities collectively produced 1,950 MW in the late government turned to independent power producers to build and operate power plants in the region's 2012, almost all of which the region consumed.
- **Power ships in Basrah City:** In 2010, the first of two floating "power ships" owned by a Turkish company docked in Basrah city at the Arab Gulf. By 2012, they produced an average of about 220 MW. (The two Basrah power ships and the Kurdish private power plants provided about one-fourth of the country's electricity in 2012).
- **Imports:** In 2004, Iraq imported 136 MW of electricity. By 2012, imports increased to about 1,000 MW (12% of Iraq's total supply), almost all of which came from Iran.

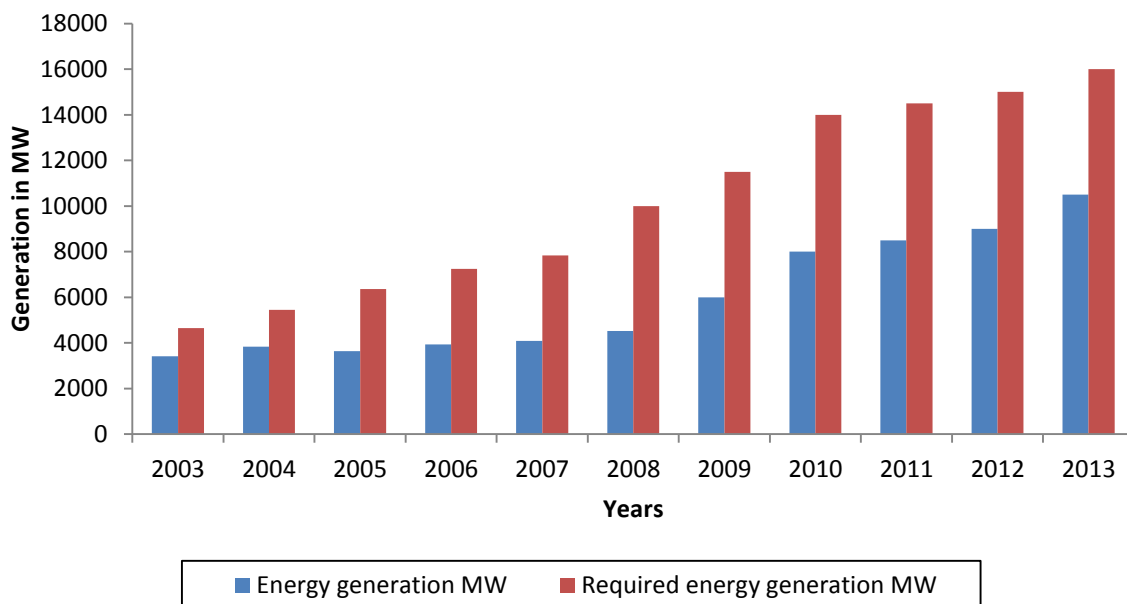

Figure 3-9: Average electricity Supply on Grid VS. Demand, 2000–2013 in Megawatts³¹⁰

³⁰⁹ Sachs, J., Asad, S., & Qaragholi, H.: Iraq's Power Crisis and the need to re-engage the private sector – smartly, Washington-Baghdad, MEES, 2011.

³¹⁰ SIGIR, the Special Inspector General for Iraq Reconstruction report: Learning from Iraq. Washington DC., USA, 2013.

With the poor electricity service and heat of Iraqi summers exceeding 40-50°C, around 90% of Iraqis have to pay to get extra electricity generated by small private diesel generators placed in the neighborhood.³¹¹ The map below (Figure 3-10) displays the electricity sources-national grid or private generators- in different governorates. However, it shows that there's not a single governorate where all the people rely on the national grid as a source for electricity, although 98% of the household are connected to the national grid.³¹²

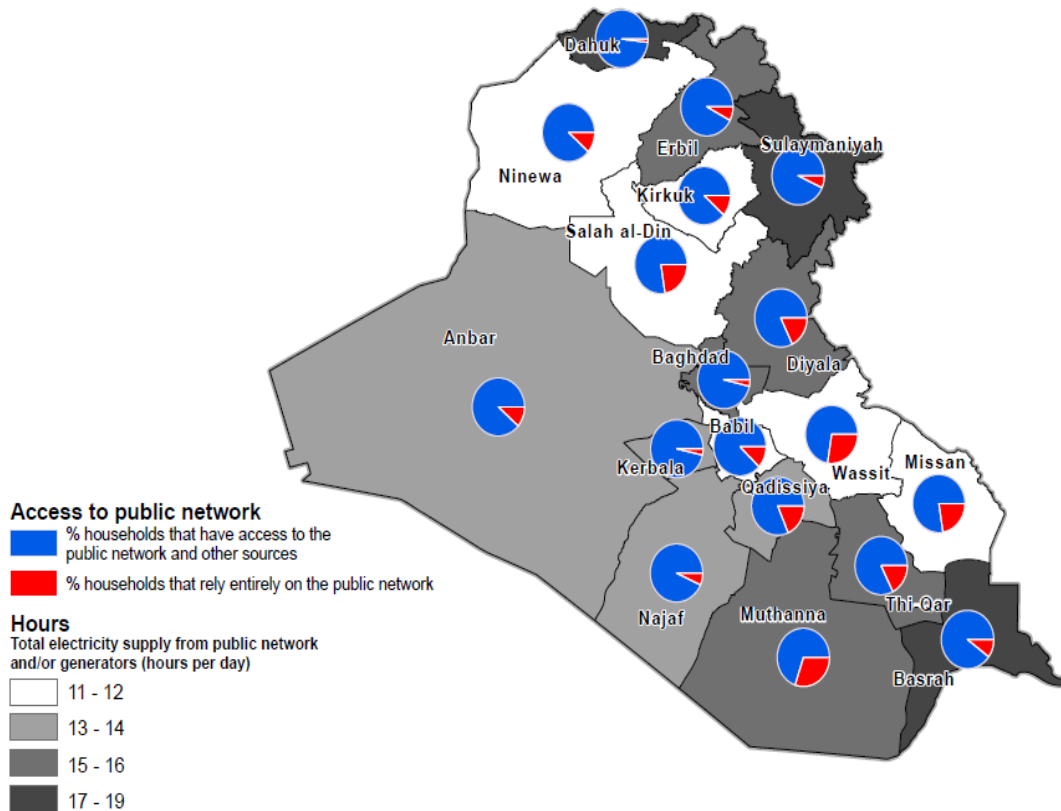

Figure 3-10: Access to public and private electricity in different provinces³¹³

The electricity supply system in Iraq has suffered from decades of neglect, the lack of spare parts, insufficient operation and maintenance (O&M), lack of new investment, and looting since the outbreak of the past wars. Caused major power-generation facilities to deteriorate and function at a fraction of their designed operating capacity. In general, Iraq power plants are 10 to 25 years old and have suffered substantial deterioration over the years. Currently, the system is operated at lower than 50 Hz frequency to reduce demand, causing detrimental effect on turbine blades, which lower system efficiencies even further. Table 3-22 below shows the gap between the design and the actual system capacity.³¹⁴

³¹¹ UNAMI; UNDP Iraq: Overview of Iraq's Electricity. Baghdad, Iraq, October 2008.

³¹² IAU Iraq: IKN 2011 Essential Services Factsheet, Baghdad, Iraq, 2011.

³¹³ Previous reference.

³¹⁴ Ministry of Electricity: Electricity Demand. Baghdad, Iraq, 2010.

Moreover, a recent estimate shows that the costs imposed on the Iraqi economy from the electricity supply defect reaches the sum of 40 Billion USD.³¹⁵ The MOE management depends wholly on the government budget allocated by the Ministry of Finance (MOF). The destiny of a new project fully depends on the availability of budget, which will be allocated to each directorate and department. At present, the MOE has the status of an industrial ministry. The entire project management as well as accounting is performed and administrated in accordance with the governmental budget-control system.

Stations	No. of Stations	Design MW	Actual MW
Steam	8	5,415	1,600
Gas Turbines	14	2,181	800
Hydro	7	2,518	650
Diesel Plant	3	87	87
Total	32	10,206	3,137

Table 3-22: Gap between the design and the actual system capacity³¹⁶

The MOE has a project-management system. As regards investment projects, while the Planning and Studies Department compiles initial plans, the Project Directorates manage project implementation, which consists of design, tendering, procurement, construction, and inspection. In this way, the organization in charge of the project management exists in the MOE. In the project implementation stage, an official from the Project Directorates is assigned to the project to serve as its manager. The problem is that their management system is obsolete. In particular, the system has not been computerized to a sufficient degree; In addition, budget shortages seriously affect the implementation of investment projects, and lack of training for workers and obsolete technology.

3.1.5.2 Expectations of Electricity Demand

In 2011, Gol announced the master plan of Iraq's electricity infrastructure and its future requirements. According to the master plan of electricity, Iraq will need to invest more than 77 Billion USD in its power sector, in order to satisfy the projected demand over the next 20 years which is estimated to have grown at around 15% p.a., around 4.5 Billion USD per year.³¹⁷ As shown in Figure 3-11.³¹⁸

³¹⁵ Ministry of Electricity: Electricity Master Plan, Baghdad, Iraq, 2011.

³¹⁶ Previous reference.

³¹⁷ Sachs, J., Asad, S., & Qaragholi, H.: Iraq's Power Crisis and the Need to Re-engage the Private Sector – Smartly. Washington-Baghdad, MEES, 2011.

³¹⁸ Ministry of Electricity: Electricity Master Plan, Baghdad, Iraq, 2011.

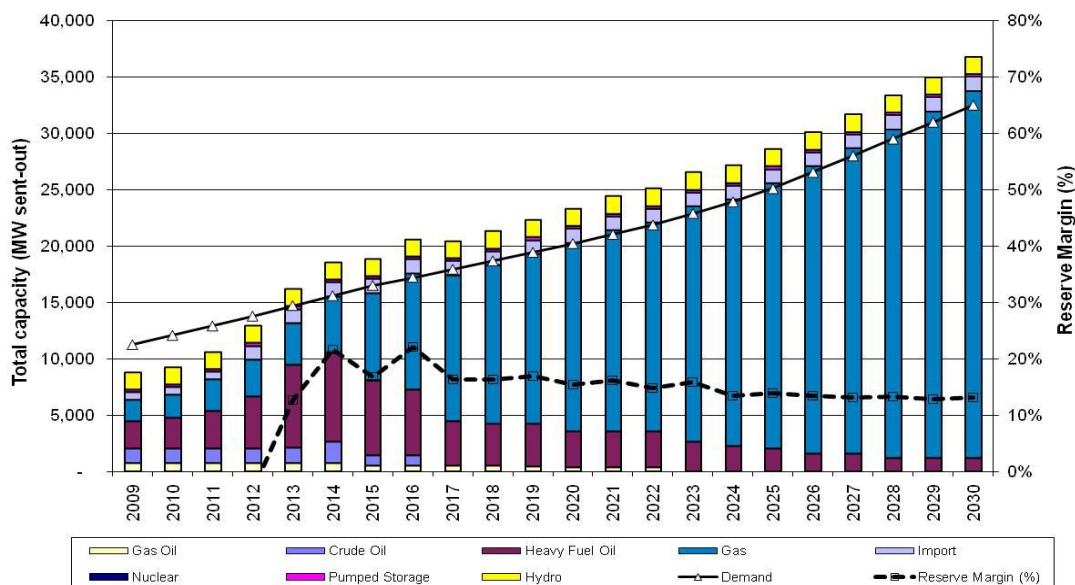

Figure 3-11: Forecasted electricity demand³¹⁹

According to the master plan, Table 3-23 below shows the cost for enforce and develop the current power generation plant and the cost for the required new power plant for the period 2010-2030.

Year	Required investment cost		
	Cost of required enforcement M (USD)	Cost of new generation M (USD)	Total
2010	261	0	261
2011	0	135	135
2012	1,362	998	2,360
2013	0	552	552
2014	152	175	327
2015	351	432	432
2016	-	1,487	1,487
2017	-	1,693	1,693
2018	-	2,343	2,343
2019	-	2,552	2,552
2020	-	1,703	1,703
2021	-	1,657	1,657
2022	-	1,602	1,602
2023	-	1,872	1,872
2024	-	1,907	1,907
2025	-	2,305	2,305
2026	-	1,890	1,890
2027	-	2,156	2,156
2028	-	1,806	1,806
2029	-	1,022	1,022
2030	-	-	-
Total			30,462

Table 3-23: Long term generation investment - Millions USD³²⁰

³¹⁹ Ministry of Electricity, Master plan.

³²⁰ Previous reference.

According to the plan in Figure 3-11 it would be sufficient capacity by 2013 to meet demand. But this did not happen due to lack of management and the failure of the Ministry of Electricity in the implementation of plans to expand production. In spite of Iraq's huge endowment in energy and the enormous investment in the provision of energy infrastructure, the performance of the power sector remained poor, in comparison with other developing economies. For the past ten years, inadequate quantity, quality and access to electricity services have been a routine feature in Iraq. One of the main reasons for this electricity services weakness is the lack of the financial allocation from the government for this sector, as shown in Table 3-24 below.

Year	Required Annual allocation Billion \$	Actual Annual allocation Billion \$	Percentage
2010	18,830	3,629	19%
2011	19,944	4,458	22%
2012	24,983	8,385	34%
2013	33,539	5,809	17%

Table 3-24: Annual financial allocations of electricity sector for the period 2010-2013 in Billion USD³²¹

Beside, the performance of electricity management system in Iraq occupies the lowest position when compared with any electricity management system in the region. They are less efficient in terms of management (there are more than ten persons per MW of electricity generation versus 1.4 persons in Saudi Arabia to do the same work), and the least in the professional of operation and maintenance.

An assertion confirmed by a World Bank assessment study conducted on energy development in Iraq which shows the country's performance in the power sector and other developing countries revealed that the sector had a percentage of system losses in transmission and distribution network to the total electricity production at 48% in 2008; and was about 37% in 2010, and about 35% in 2011, compared to 12% in Kuwait and 9% in Saudi Arabia and 15% in Turkey and 14.6% in Iran for the same year.³²² Moreover, the ratio available to generate electricity accounts about 41% of the installed capacity (Table 3-25).

In addition to, for the last ten years, MoE have spent about 27 Billion USD to achieve an increase in the actual production capacity by 3550 MW only (about 7600000 USD per MW). Note that the cost of generating 1 MW is approximately 350000 USD- 440000 USD for the Gas-fired CCGT.³²³ These all reflect the low operational efficiency and the lack of electricity projects management.

³²¹ Iraqi Ministry of Electricity.

³²² www.worldbank.org.

³²³ The Royal Academy of Engineering: The Costs of Generating Electricity. London, 2004.

Country	Power station efficiency (%)	Electricity energy losses (%)
Iraq	19.9	40
Jordan	39.9	16.5
Kuwait	35	25
The Yemen	31.5	35
Bahrain	27.8	25.2
Algeria	39	26
Libya	32	19
Sudan	44.4	21
Egypt	40.4	13.7

Table 3-25: Comparisons of the Iraqi electricity sector with some Arab countries 2013³²⁴

3.1.6 Iraq Labour Force and Capacity Building

The total labor force in Iraq was estimated to be 8.5 Million in 2010. Moreover, an estimated 450,000 workers enter the labor force each year. As for the working age (15-64 years) population group gradually reached 56 % in 2012.³²⁵

Year	2002-2008	Population	Working age population	Economically active population	Economically active of working age	% of working age population	Economic activity rates	Active of working age/ working age population
2002	Males	12,814,121	6,789,847	5,724,359	5,520,812	52.99	44.67	81.31
	Females	12,750,714	6,670,880	1,201,175	1,173,210	52.32	9.42	17.59
	Total	25,564,835	13,660,784	6,925,534	6,694,022	53.44	27.09	49.00
2004	Males	13,629,337	7,269,084	6,154,288	5,948,151	53.33	45.15	81.83
	Females	13,510,248	7,113,984	1,351,909	1,322,989	52.66	10.01	18.60
	Total	27,139,585	14,596,762	7,506,197	7,271,141	53.78	27.66	49.81
2008	Males	15,394,248	8,274,241	7,129,446	6,916,433	53.75	46.31	83.59
	Females	15,183,550	8,052,637	1,717,759	1,686,677	53.04	11.31	20.95
	Total	30,577,798	16,571,888	8,847,205	8,603,110	54.20	28.93	51.91

Table 3-26: Iraq population working age³²⁶

Reports on unemployment rates ranging between 23–28% of the total population, with unemployment for males aged 15–29 is 28%, a statistic generated by few job opportunities as well as low levels of education and skills. According to 2011 COSIT labor market statistics, more than 38% of the Iraqi labor force has no education, and only 11% of the Iraqi population has

³²⁴ www.world bank.org

³²⁵ Inger Andersen, Loïc Chiquier, Hedi Larbi: Iraq Investment Climate Assessment. World Bank, 2012.

³²⁶ Iraqi Ministry of Planning.

diplomas or higher degrees. The role of vocational training centers in training the Iraqi labor force is important, with reported satisfactory performance of the vocational training centers operated by the Ministry of Labor and Social Affairs. (Previous reference) Moreover, only about 26% of Iraqi public firms consider an inadequately educated labor force as a major or severe obstacle. There is clear evidence that the market rewards higher levels of education and that investment in labor skills enhances productivity.

Iraq complain from lack of technology and the know-how concept especially in the infrastructure management, where the exodus of well qualified professionals from the country in additional to Iraq's isolation from the rest of the world for over a decade have severely depleted the infrastructure authorities' capacity to maintain best practices in the infrastructure sector, trainings conducted in the past by UNICEF and other partners for the infrastructure authority Engineers address just a fraction of the enormous capacity gap that still exists, especially at the government levels.³²⁷

Moreover, despite the country's rich resource endowment, Iraq's human development indicators are now among the lowest in the region. The Iraqi population faces serious challenges re-working fundamental aspects of its governance and economic development. Iraq needs to upgrade the skills of officials and civil servants working in local, public administration(See Figure 3-12).³²⁸

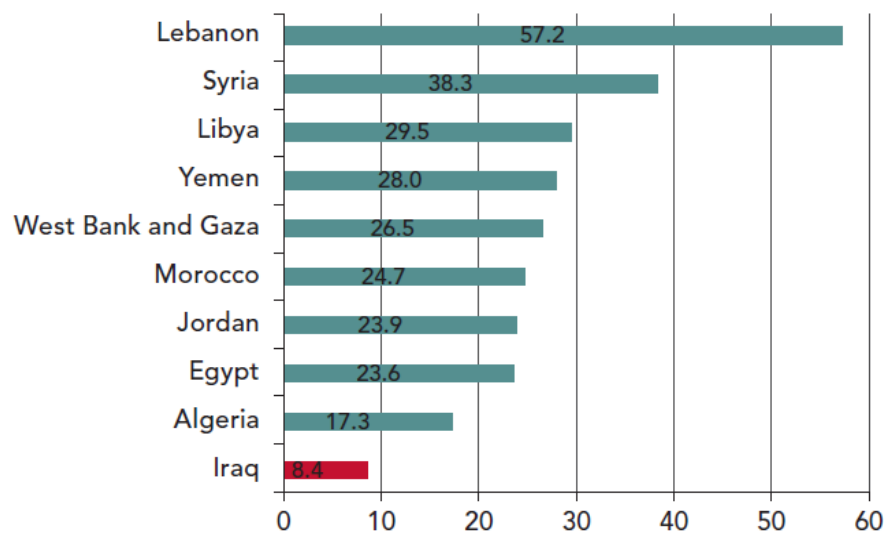

Figure 3-12: Provision of training to workers³²⁹

Under Law No. 11 of 1996, urban planning is managed by the General Directorate for Physical Planning within the Ministry of Municipalities and Public Works (MoMPW). The exception is Baghdad, which operates with a greater level of independence. Iraq does have some districts which have the authority to create their own plans but in practice this is rarely exercised. In general the Directorate drafts master plans which outline infrastructure requirements, land use

³²⁷ Master Planning and Capacity Building Program: Report of United Nations Development Group. Iraq trust fund, 2010.

³²⁸ Ministry of Construction and Housing: Report of Institutional and Training Needs Assessment for Establishment of Iraq Housing Information and Training Center, 2012.

³²⁹ Previous reference.

and other projects, but usually do not include further details on timeframes, contractors or stage planning. Once development planning has been completed by the Directorate, the responsibility of implementation is delegated to the municipality. Often individual municipalities lack the finances to complete developments, a factor that has led to disparities in urban growth between districts in Iraq. Land registration and titling in Iraq is conducted by Real Estate Registration Directorates which are a part of the Land Administration Department, Ministry of Finance. Each governorate in Iraq has at least one Registration Directorate and more densely populated areas have more.

Besides, building standards and quality control have been delegated to several agencies including: the Central Organization for Standardization and Quality Control, the MoCH, the Ministry of Defence (for fire protection and intelligent signaling), local governments, and other relevant ministries and agencies. Municipal governments are responsible for development control and issue building permits. Governorate or central officials will often also be involved in approving major development projects.³³⁰

Existing systems of urban planning and management are unable to cope with the massive problems that confront all urban areas. Iraq has limited land-use planning policies and strategies.³³¹ City physical master plans are badly outdated and do not provide the information required for decisions on rehabilitation priorities, infrastructure investments or future development. In addition, municipal staff has received little or no training in over 2 decades and there is no clear division of responsibility between municipalities and governorates. In addition, local governments rely almost exclusively on limited central government funding. The result is that demands for local services are not being met, existing infrastructure is not being rehabilitated, new infrastructure is not being built and urban living conditions are steadily worsening.³³²

According to the report of Stabilizing and Rebuilding of Iraq issued by the US Government Accountability Office in August 2008, Gol ownership, commitment and project management arrangements are generally affected by set of factors. These obstacles are summarized in to the following six areas:³³³

- Unsatisfactory project supervision and contract management arrangements.
- Lack of support for and recognition of Project Management Teams.
- Insufficient or inappropriate incentives to promote the Government's PFM reform agenda;
- Inadequate consultative, coordination and co-financing arrangements.
- Poor project design and more specifically the planning process to set the implementation strategy.
- An absence of a medium-term PFM reform program that informs the prioritization and sequencing of specific PFM reform measures.
- Limited availability of critical equipment and tools for existing infrastructure projects caused by a combination of a lack of supply and increased demand, and
- Limited capacity to develop sector strategies, project feasibility studies, credible project costing and realistic project appraisals.

³³⁰ UNIDO: Investment Map for Iraq. Private Sector Development Programme for Iraq, 2011.

³³¹ UNEP/DEPI/Post-Conflict Assessment Unit: Needs Assessment for Identification of Environmental Priorities in Iraq, 2003.

³³² UN and World Bank: Strengthening the Urban Sector through Building Capacities in Municipal Planning and Management, 2009.

³³³ World Bank: Public Financial Management in a Conflict- Affected Environment, Iraq Public Expenditure and Institutional Assessment, Vol.1, 2008.

In a study conducted in 2009 on the Iraqi public companies about approaches used to execution infrastructure projects (electricity, roads, water and sewage), shows that most of the public companies lack the experience in the field of project management, in addition to, weakness of the used execution methods and the lack of quality for the implemented projects.³³⁴

3.1.7 Change from Public to Private Finance in Iraq

In general, secure infrastructure financing can be done by the state (public sector) by:

- The state budget.
- Foreign loans.
- Grants and foreign aid.
- Investment instruments of government bonds.
- Partial funding of users except for fees, or through a joint program with the private sector.
- It can also be funded infrastructure services through the private sector through the contract (PPP).

To cover the budget deficiency, Iraq used foreign loans, grants and foreign aid to renovate infrastructure projects after 2003 war, such as the World Bank loans, the European Union (EU) grant of 230 Million USD, and Madrid Donors Conference grant of 37.5 Billion USD. Moreover, in 2010, Gol issued treasury bonds with a total value of 2.7 Billion USD and interest rate of 5.8%. Iraq bonds are classified (informal classification) within the class of - B. Currently Iraq is negotiating to enter the international classifications within the official after UN Security Council decisions of Iraq release from Chapter VII in 2013.

Since the beginning of 2011, Iraq managed to attract private investments worth about 6 Billion USD for projects in the housing sector and infrastructure which have been licensed and it attract investments worth 23 Billion USD since 2009. Nonetheless, the immense potential of Iraqi economy is steadily attracting foreign investors, despite shaky security situation and political uncertainties, over 45 countries active in Iraq in 2011, in the fields of investments, service contracts and other commercial activities into the country. Foreign investments have gone into top sectors such as residential real estate, oil and gas, electricity, water and sanitation, defence, medicine, commercial real estate and telecommunications (See Table 3-27).

Despite the financing that come from Foreign Direct Investment (FDI), foreign loans, grants and treasury bonds were used to renovate and reconstruct Iraq infrastructure since 2003, most of the infrastructure services have not restored to their pre-2003 levels, and much still needs to be carried out.

Regarding previous explored circumstances of the Iraqi's economy and the cumulative negative effects of operational, financial and institutional problems in infrastructure services, show a substantial gap, signifying the urgent need for alternative solutions to increase availability of the capital other than traditional public funding and to improve technology and the know-how. Owing to this, the Iraqi government is left with a choice not between a PPP and a traditional public procurement project but with a choice between a project and no project at all as the Iraqi government lacks skills, finance and the modern technology.

³³⁴ Mhmed Abdul Elah M.: The Influence of Civil Project Management Methods on Implementation of Cities Infrastructure Project, Master thesis, Higher Institution of Urban & Regional planning, Baghdad University, 2009.

Foreign Direct Investment	2007	2008	2009	2010	2011	2012	2013
FDI Inflows (\$ Million)	972	1,856	1,598	1,396	2,082	2,376	2,852
FDI Outflows (\$ Million)	8	34	72	125	366	448	538

Table 3-27: Foreign Direct Investment in Iraq in Million USD for years 2007 – 2013³³⁵

To date, different methods have been considered in Iraq for achieving this goal. PPPs in the form of contracts such as BOO and BOT were proposed as a possible solution to leverage needed technical and managerial expertise, secure capital injections and greater efficiency, most this projects were in the education and electricity sectors. Iraq does not have a comprehensive database of PPP projects, although a list of PPP projects undertaken, Figure 3-13 shows current PPP projects in Iraq according to data from MoE and Kurdistan region. Here it can be seen that by 2012 PPP projects in power generation comprise about 27% of the total generated electricity in Iraq.

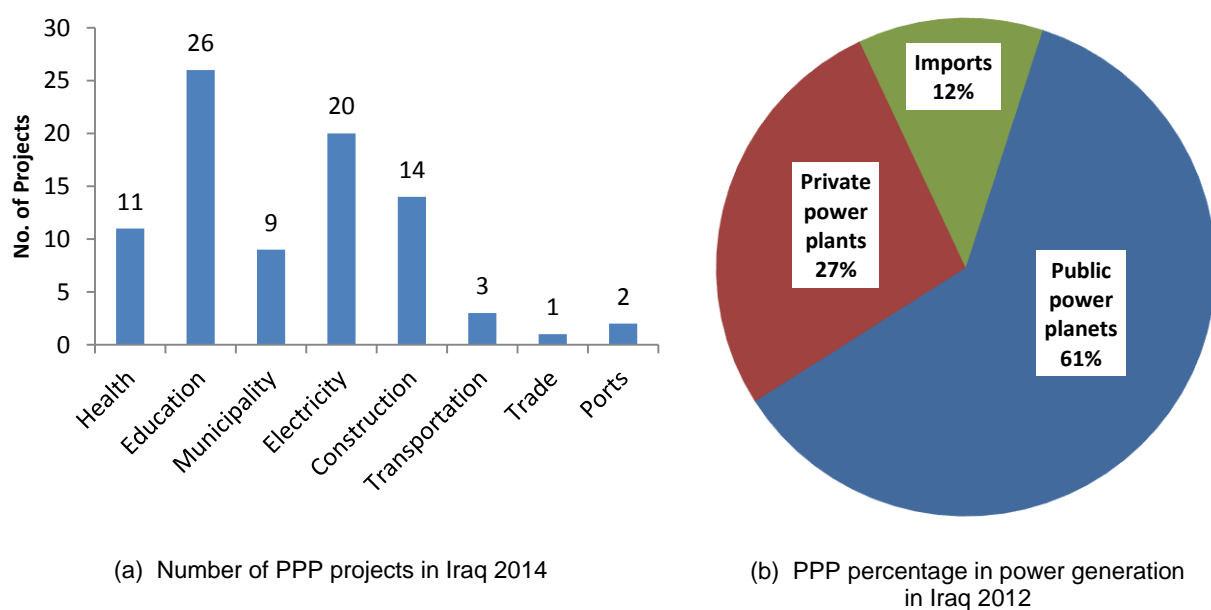

Figure 3-13: PPP projects in Iraq^{336 337}

In most countries, the provision of infrastructure services is responsibility of the public sector. Depending on the political and administrative structure of the country, legislations at different levels of government may govern the infrastructure sectors. Generally, some form of legal authority is required to permit private involvement in infrastructure development. Legal provisions may also be required to process, promote and facilitate private involvement. With this context, the Iraqi government has attempted to increase private sector participation in the

³³⁵ United Nations Conference on Trade And Development (UNCTAD):World Investment Report, 2013.

³³⁶ Kurdistan Investment Committee: Gateway to Iraq. Kurdistan Region Government, 2014.

³³⁷ SIGIR, the Special Inspector General for Iraq Reconstruction report: Learning from Iraq. Washington DC., USA, 2013.

country's infrastructure and stimulate private investment through Public-Private Partnerships with a total budget of 150 Billion USD by 2025, in addition to the budgetary funds,³³⁸ and establishing a regulatory framework that follows international practices as well as amending and modifying laws and regulations related to private investment in Iraq.

The traditional procurement approach for the delivery of public services and facilities has been practiced in Iraq for decades already. The new rising trend, however, is the use of public-private partnerships. Despite the fact that PPPs may bring additional value for money, the PPP option is not always the best solution to the provision of the public service. However, whether or not a service should be delivered by means of a PPP project depends on the answer to three basic questions:³³⁹

- Which (if any) part or parts of the proposed service is a service which government itself should deliver to its citizens? (the core services question);
- For all other aspects of the service and supporting physical infrastructure, what is the project model that delivers the best value for money? (the value for money question); and
- Do the outcomes of the value for money question satisfy the public interest criteria articulated in the policy and, if not, can the public interest be satisfied either by building safeguards into the contract or through regulatory measures? (The public interest question).

Infrastructure projects are often having significant social and environmental impacts arising from their construction and operation, which can be both positive and negative. The impacts may include flow-on effects beyond the immediate project area and beyond the people directly associated with the project as secondary impacts. The PPP social impact on Iraq can be represented by³⁴⁰:

- Solving the government's financial deficiency problem in infrastructure investment: The governments can then devote more budgets to meeting citizen's basic needs, e.g. developing science, education, healthy and conquer poverty.
- Promoting investment in infrastructure: PPP can encourage investment of all sorts of capital, foreign or private, in infrastructure development. This is especially significant for Iraq, which has great needs for infrastructures to support the rapid development of economy and society.
- Promote efficiency of investment, management, knowhow and operation of project life cycle: Compared with government invested projects, the PPP arrangements which bring in foreign and private expertise has mostly the advantages of achieving higher quality, shorter duration and less cost of projects.

The final assessment of environmental and social costs and benefits is an input to the economic assessment of the project. Therefore, the social and environmental analysis is an important part of the assessment of the project's overall impact.

³³⁸ MENA-OECD Investment Program: A Methodology for Infrastructure Prioritization in Iraq, 2010.

³³⁹ Grimsey, D. and Lewis, M.K.: Public Private Partnerships: The Worldwide Revolution in Infrastructure Provision and Project Finance. Edward Elgar, Cheltenham, United Kingdom, 2004, P.93.

³⁴⁰ Zhao, Guofu and Wang, Shou Qing: Indicators of Social Impact Assessment for BOT/PPP Projects. Tsinghua University of Beijing, 2010.

3.1.8 Power Purchase Agreement

Power purchase agreement (PPA) is typically a long-term agreement for the sale of power (usually on the basis of "available capacity" and "net electrical output") between the utility and the project SPV. This structure serves two important functions:

- It guarantees a market, a cost basis for the power plant and corresponding predictable revenue stream for the power to be produced by the project (thereby allowing the facility to be financed on affordable payment terms and with a reasonable tariff).
- It defines in reasonable detail the rights, responsibilities and obligations of the project SPV and the purchasing utility through the financing, construction and operational phases of the project.

Under the PPA, the project SPV agrees to make the contracted level of electricity generation capacity available to the utility (subject to a certain amount of annual outage time for maintenance or other outages) by an agreed date and for an agreed period of time, and the purchaser agrees to pay the agreed tariff for capacity made available to it and the net electrical output dispatched to it. The PPA includes provisions related to the arrangements and mechanics of payments. Indeed, most of independent power producers IPP prefer to conclude such agreements because here they sell their production to only one off-taker and because PPAs distribute and allocate the project' risks.

Although there are only two parties to the PPA, the responsibilities and obligations of each party under this umbrella agreement must be acceptable to the utility, sponsor(s), investors and lenders to the project and interface properly with other project agreements. In particular, provisions therein related to the allocation of risk must be acceptable to the fuel supplier, construction contractor and the O&M parties. This broader consensus is important because the lenders will require that the risks assumed by the project vehicle under the PPA, which potentially affect its cash flow adversely, be passed through the other project agreements to the appropriate parties.³⁴¹

In theory, a PPA is supposed to allocate risks to the parties which can best control or mitigate them. The financial benefits should be commensurate with the distribution of risks between the sponsor and the state. In practice, both parties will try to minimize their risks and maximize their benefits. Corruption, experiences with negotiating similar deals, resources to hire legal advisors and other factors relating to the bargaining power of the different parties may also impact their negotiating positions.

Recently, international experience shows that in the absence of the transparency, competitive bidding, accountability, good governance, and rational planning, PPAs become an aggressive tool in the hands of private investors and corrupted governmental officials.

Bacon and John (2001)³⁴² sees that "in countries with little record of sound regulation, the government s have to carry an unduly high proportion of investment risks through performance and payment guarantees ".

Government has to give the priority to the merchant power plants. When a government designs a PPA, it should insist that private investor assume a fair portion of the project risk, it should not

³⁴¹ M. Fouzul Kabir Khan, Robert J. Parra: Financing Large Projects-Using Project Finance Techniques and Practices, Pearson Education Asia Pte Ltd, 2003.

³⁴² Bacon R.W. and J. Besant-Jones, Global Electric Power Reform, Privatization and Liberalization of the Electric Power Industry in Developing Countries, in: Annual Rev. Energy Environ, Vol. 26, 2001, P.331-359

accept the article of capacity sale. If the private investor has an access to the international exchange rate insurance market, the investor should assume the foreign exchange rate risk. If not, the risk might be allocated among all parties.

Main issues addressed in a typical PPA of a private power project due to World Bank (1998) might include the following articles:

- **Definitions:** It defines all terms used in the PPA.
- **Sale of Capacity and Energy:** The main issue included in this article usually is that the purchaser will be required to pay a monthly tariff for the available capacity and the electrical output generated by the plant.
- **Conditions Precedents:** It often set out conditions precedent to the effectiveness to each party's obligations. Conditions to the investor's obligations may include receipt of good, enforceable leasehold interest to the site, receipt of certain governmental authorizations, execution of the construction contract and certain others agreements. Conditions precedents to purchaser's obligations may include corporate documents, evidence of investor's receipt o necessary governmental approvals.
- **Pre-operation Period:** Pre-operating obligations frequently include a "reasonable efforts" obligation by the investor to obtain necessary consents and approvals and by the purchaser to provide reasonable assistance to the investor in obtaining the consents and approvals.
- **Term and Termination:** Term define the date on which the agreement becomes effective and the period after which it will terminate. The article also provides extensions for specified force majeure events. Lenders often insist that the PPA's term to be few years beyond the period, permitting the investor to generate sufficient cash flow to retire the project's debt.
- **Representations and Warranties:** It typically includes the organization and valid existence of the purchaser and the investor, the legal and binding nature of the obligations constituted by the PPA, and etc.
- **Undertakings Investor's:** Undertakings may include obligations to to use reasonable effort to obtain financing for the projects, to operate the plant in accordance with the purchaser's dispatch instructions and prudent utility practice, and so on. Typical covenants of the purchaser may include by or before the commercial date interconnection and transmission facilities, to assist in identifying and preparing applications for government authorizations, and so on.
- **Project Operation:** It typically includes scheduled outage, maintenance outage, operation and maintenance, emergencies and record keeping.
- **Payment:** This specifies procedures for invoicing, the methods and amount of payments, resolving disputes relating to invoices, security for payments, and rights to set off.

- **Liability and Indemnification:** This article states that neither party shall be liable to the other for damages, except as specified. It also requires for each party to indemnify the other for losses resulting from negligent acts of the indemnifying party.
- **Force Majeure:** A PPA should clearly classify force majeure events, specifying the impact of each event on the obligations of the parties, particularly on the payment obligations of the purchaser and the construction completion.
- **Taxes:** Taxes are generally passed through to the purchaser under the tariff. In addition, the article usually includes requirements from the purchaser to minimize or exempt the investor from the domestic taxes.
- **Change in Law:** This article addresses the impact on the tariff in the event of a change of applicable law or its interpretations that affects the investor. Usually, lenders require that the cash flows of a project required for debt services be protected against such changes through tariff adjustment.
- **Dispute Resolution:** This article specifies the applicable rules, the number of arbitrators, the place of arbitration, the language of the arbitration proceedings the nature and enforceability of the award.

3.1.9 Tendering Systems and PPAs in Iraq

This part describes the tendering systems according to the Iraqi Public Contracts Law 2008. The project sponsor procurement can be implemented under a simplified competitive tendering system, a single -stage system, or a two-stage system, depending on investment value and complexity. A simplified competitive system is applied to a project worth less than 50 Million Iraqi Dinar (ID). In this case, all matters associated with tender procedure rest with the related ministry, agency, or the local government. A single-stage system is applied to a project in which full engineering study and design have been available. A two-stage system is applied to a project whereby:

- Available technical specification is insufficient and incomplete for the purpose of a competitive tendering. Nevertheless, a clear technical criterion used to evaluate technical proposals must be available;
- There is more than one technical criterion, or complex technical specifications.

The decision on the system selection rests with the tender committee after consulting with the related Ministry, MoP and MoF. This consultation must take place before the issue of an invitation to pre-qualification proceedings and after the pre-feasibility study. The invitation must be made public and contains information about the name and location of the project; the name, address and telephone and fax numbers of the tender committee; contact persons and where to obtain pre-qualification documents; the deadline, location and procedures of submission of tender documents; and the tendering system to use. Prospective bidders are required to supply information about their experiences in the sector; their performance in pursuing similar projects, including references from previous clients; their experience in pursuing projects with similar geographical, topographical and climate conditions; and their financial, human resources and equipment capabilities. Within fourteen days after the deadline for document submission, the Minister / Head of Institution acting as the tender committee must complete the pre-qualification

evaluation. Both successful and unsuccessful bidders must receive evaluation results simultaneously. A disqualified bidder is permitted to appeal over the decision to the tender evaluator within seven days after the notification date. The tender evaluator will then make a final, binding, decision to accept or reject the appeal.³⁴³ If a two-stage system is used, the tender committee is required to:

- Define technical criteria and specifications demonstrating minimum requirements of operation and performance
- Discuss with pre-qualified bidders their technical proposals
- Request pre-qualified bidders to resubmit technical proposals based on agreed technical parameters and standards.

According to the Iraqi public contracts law 2008, the request for proposals prepared and distributed to all prequalified bidders by the tender committee must contain the following:

- Invitation for bids,
- General information about the project, including a clear statement of objectives, scope of work, expected output, targeted customers, minimum applicable designs, performance standards, and appropriate environmental standards;
- Deadline, place, submission procedures for tender documents, and validity period of offers;
- Proposed opening date of proposals;
- Principles for the setting and adjustments of tariffs, expenses, costs and fees;
- Guarantees provided by the tender committee;
- Requirement of establishment of a limited legal entity, if any;
- Supports provided by the tender committee;
- Table indicating risk allocation among parties;
- Degree to which the tender committee or other related entities are involved in the project financing;
- Bid forms;
- General and specific conditions of contract;
- A copy of pre-feasibility studies;
- A copy of a project agreement draft;
- The required bid bond;
- The required performance bond;
- Supplementary materials, including additional relevant information (e.g., economical, social, demographical, or environmental data);
- Other related documents potentially beneficial to bidders.

The proposal must be written in both English and Arabic versions. If a dispute arises, however, the Arabic version of document is referred to. If a modification is made by the tender committee, all bidders may be granted additional time by extending the deadline for submission of proposals. Typically, a bid bond is sought from the bidders so as to cover a potential loss resulting from withdrawal of proposals or failure by the selected bidder to conclude a project agreement. A bidder can ask for clarification about the request for proposals in writing. The clarification by the tender committee has to be communicated to all bidders in writing. Once the proposals are opened, the bidders are not allowed to refine, revise or modify their proposals.

³⁴³ According to the Iraqi Public Contracts Law 2008, the tender evaluation team should make the decision within 1-60 days.

3.1.9.1 Bidding Evaluation

The term "evaluation" describes the procedure for the assessment of tender bids submitted by prequalified contractors. The procedures in the Iraq broadly follow the justification of the lowest priced bid. Several clients however also emphasize the significance of timely completion in the selection of the successful proposal.

Although, multi-criteria bidding system are used for bid evaluation in some cases, under a multi-criteria system, the state agency's evaluates proposals of bidders against a set of pre-defined financial and technical criteria. Sometimes the State agency's using scoring systems for the evaluation. A bidder who achieves the overall highest rating is recommended to win the contract. Most likely, scoring systems resemble simple weighting averages. A score is computed by multiplying the rating achieved for each criterion by its weight and summing these products over all bidders; the bidder who receives the highest overall score will win the contract. This scoring system was applied by MoE for PPAs, in which six variables, including the concession level and payments offered to the State are average weighted. A combination of the simple scoring system and the multi-criteria system is also possible, as was applied in four toll road projects in California of the United States.

All submitted proposals must be evaluated to ensure that they conform to the following technical criteria and performance. For the PPA, the MoE demand the following:

- Basic designs should be in accordance with the technical and environmental standards set forth in the tender documents.
- A bidder needs to provide a project organizational structure and operation and maintenance methods to ensure that delivered performance conforms to performance standards
- A bidder needs to provide a detailed project-financing plan, including construction costs, initial operating costs and contingency funds to cover cost overruns, delays or negative cash flows during early operation.

According to Article 4 of the MoE PPA, a two-stage bid evaluation process will be adopted by the MoE. In the first stage, Bidders' Technical Proposals will be reviewed according to the criteria and weights set out in Table 3-28 below.³⁴⁴

Technical Proposal Evaluation Criteria	Weight
• Bidder's financial strength, including its ability to raise debt and equity	15%
• Bidder's experience of power project development, construction and operation, and their experience in the region	15%
• Quality of bidder's detailed plans for the project development, implementation (construction and procurement) and operation, including guaranteed implementation period from financial close to first commercial operation for each unit	25%
• Proposed organization for the development, implementation and operation of the project, including identities of any subcontractors to be used (where known) – e.g. for EPC or O&M and curricula vitae of key staff	10%
• Quality of Bidder's financing plan, including the sources of funds and the time required to reach financial close.	25%
• Number and materiality of comments on the Transaction Documents	10%
Total	100%

Table 3-28: MoE evaluation criteria for the technical proposals of PPP proposals³⁴⁵

³⁴⁴ Ministry of Electricity: Tender Rules of Power Purchase Contract, Baghdad, Iraq, 2010.

Only after passing the technical evaluation stage with score at least 75%, a proposal is eligible for the financial evaluation. . Those Bidders whose Technical Proposals meet this benchmark shall be ranked in order of their financial offer, with the offer that implies the lowest cost to the MoE being ranked highest, and so on. The procedures in the financial evaluation stage are depending on:

- Comparison and evaluation of the financial proposals are based on the present value of financial discounting method. The discounting rate used in the analysis is approved by the tender committee.
- Evaluation of proposed cash flows is based on fixed concession duration. A proposal that applies concession duration other than that pre-specified in the tender documents will be rejected. US dollar currency is used in the analysis. A proposal must follow the tariff adjustment formula that will be agreed with MoE.
- The proposed project schedule should be consistent with anticipated cash flows.

3.1.9.2 Governmental Approvals of Investment Projects

There are three procurement approval bodies that are required to assess justifications and processes followed for less competitive methods:

- Executing Ministries and Provinces have “Tender Analysis and Recommendation Committee (TARC)”, which analyze tenders; and “Central Committees” chaired by Governors, deputies, and members of the concerned directorates.
- Ministry of Planning (MoP) and Development Coordination promulgate procurement, contracting and investment budget execution regulations.
- The High Contracting Committee reviews and approves proposed contracts above a certain threshold amount. Inspector Generals and the Board of Supreme audit also undertake procurement audits. Information on the number and types of justification issued is not yet available, although MoP has indicated that the security situation is often cited for justification of project delays and procurement method selection.

Additionally, as a result of article 4 of investment law, a dedicated investment agency the National Investment Commission (NIC) was created in August 2007. This authority is responsible for advocacy and drafting of the country’s national investment policy and guidelines, and for monitoring their implementation. In 2008, Provincial Investment Commissions (PICs) were established in every province³⁴⁶. The chairman of NIC has the rank of Minister, the board includes in addition to the chairman, his deputy, and 4 public sector officials, three representatives from the private sector chosen by the prime minister.

The NIC will oversee the implementation of the projects throughout Iraq by coordinating its development through its various phases, including the granting of land to the developers. The Trade Bank of Iraq (TBI), as a leading financial arranger of the program, will coordinate the financial packages related to the various developments throughout Iraq.³⁴⁷

³⁴⁵ Previous reference.

³⁴⁶ Iraq Investment Law No. 13 (2006), Article 4, Iraq.

³⁴⁷ Al-Araji, Sami: Commencement of Housing Program. National Investment Commission, Iraq, 2010.

Both the NIC and the PICs has established a “One-Stop-Shop” (OSS) department (See Figure 3-14) to provide services to the new foreign and domestic investors, including help with signing contracts and facilitating registration ,obtain investment licenses through the procedure shown in below:³⁴⁸

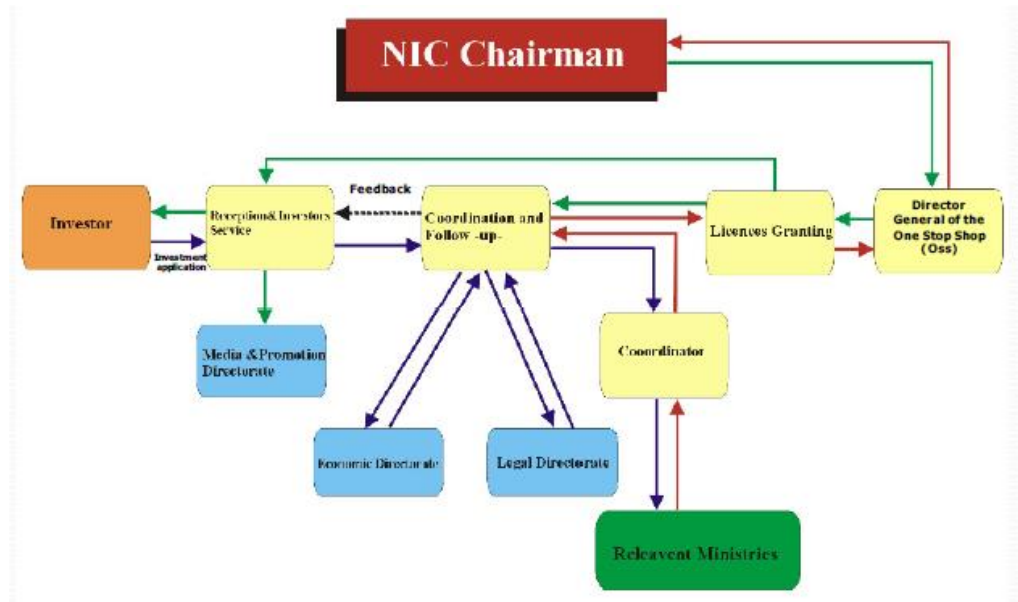

Figure 3-14: One-Stop-Shop work mechanism³⁴⁹

- Investors submit a request to the NIC indicating a desire to invest, including the proposed investment sector and geographic area. This request shall be made via a standard form which is available from the NIC website.
- Investors must include a certificate of good standing from a certified bank.
- Investors may include a list of projects completed both inside and outside Iraq.
- Investors must provide details of the investment project, including an economic and technical feasibility study.
- Investors must provide a timetable for executing the project.

In order to obtain an investment license investors need to submit an investment proposal with all the required details to the NIC there will be a first evaluation for the submitted proposal, after that the NIC board will make the second evaluation for the proposal and it will ask the related ministry/ministries for the their evaluation (third evaluation) and getting the approval, Once these approvals are received, the NIC shall execute the investment license in a period of time not exceeding 45 days from the date of submittal as shown in Figure 3-15.

³⁴⁸ National Investment Commission: Investor Guide to Iraq, Iraq, 2009.

³⁴⁹ National Investment Commission: Iraqi Investment Map. 2012.

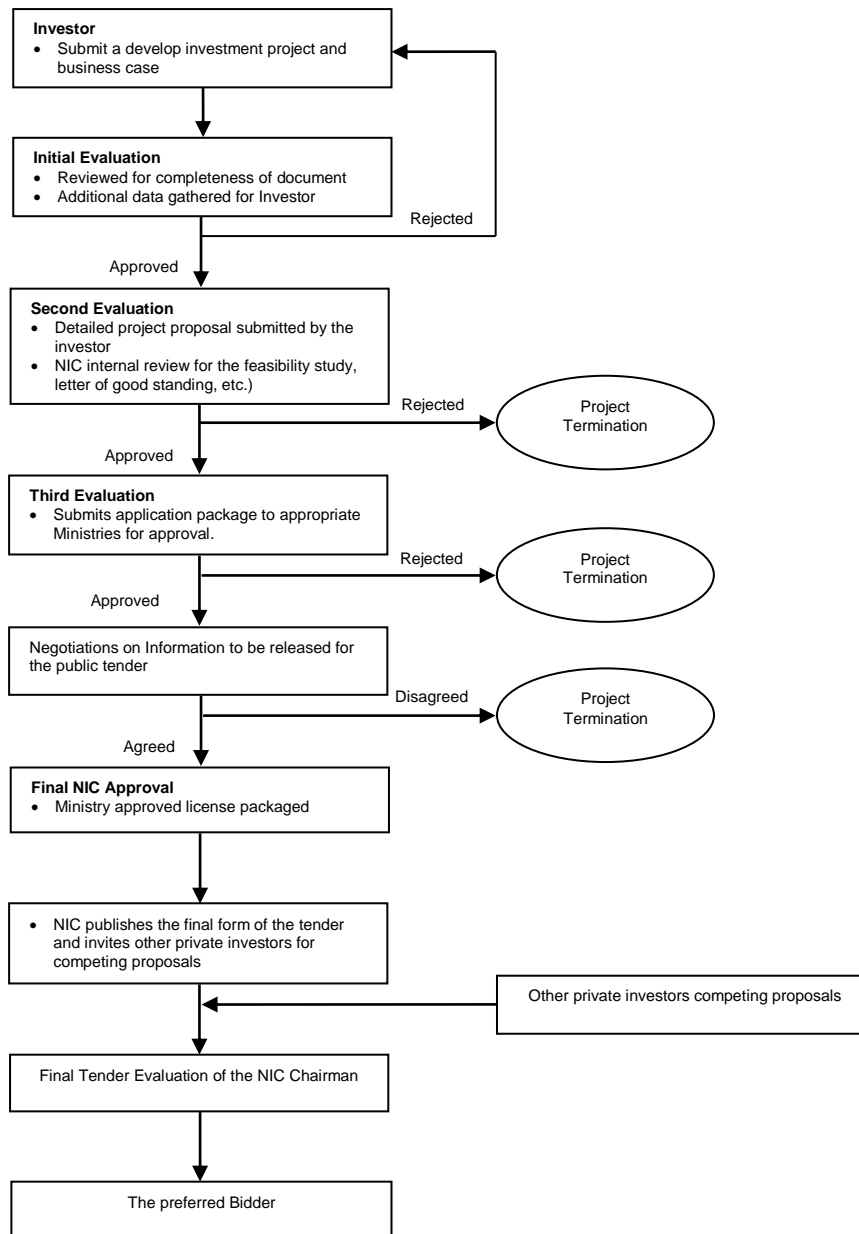

Figure 3-15: Procedure of obtaining an investment license³⁵⁰

The criteria of the evaluation of the investment projects are:

- Needs of the strategic projects as regards infrastructure and basic services needed.
- The priorities of the government investments plan.
- Convincing feasibility and technical studies.
- The compatibility of the project with the priorities of investment in strategic fields.
- Needs of project of manpower and the specialized one to be procured from abroad.
- The achieved projects of the investment plans through the approved and proposed investment projects.

In 2008, the Iraqi Council of Ministers has approved new regulations to improve the Gol's execution of its capital budget. Now the responsibilities of the bid evaluation committee are very

³⁵⁰ Prepared by the author.

specifically set out in the 2008 Regulation (Article 7). While specific details do guarantee that the committee treats all bidding companies equally - especially as regards the strict application of conditions for accepting or rejecting submitted offers - they do not guarantee that all candidates are assessed against the same yardsticks. According to the legal framework, control and authorization procedures are also stipulated by the regulations. As an important step in managing conflict of interest, there is a ban on government and public sector employees responsible for managing the procurement tender³⁵¹.

3.1.10 Contract System in Iraq

The majority of capital spending by GoI and government business enterprises uses traditional contracts, a tender-based procurement method based on comprehensive input specification and an adversarial contractual framework. Traditional procurement incorporates all or several of the following features:³⁵²

- A tender evaluation process weighted in favor of lowest contract cost.
- A project specification issued by GoI agencies and their advisers that provides a definitive requirement of goods and services to be supplied by the contractor. In the case of buildings, this will generally refer to the design, the method of construction, the finishes and equipment levels.
- The contract will be required to comply with Iraqi standard procurement policies and protocols.
- An adversarial contractual framework.
- Separation of the design, project management and construction tasks.

According to the Iraqi Commercial Law No. 30 of 1984, there are three categories of contractors in Iraq construction market: public contractors, private contractors, and foreign contractors.³⁵³ Public contracting represents firms which are owned and controlled by the government; a big number of them are supervised by the Ministry of Housing and Construction which are 9 firms. The remaining firms are the more specialized ones and are supervised by other government ministries. About 50% of the remaining firms are specializing in building construction, while the other 50% specializes in non-building work.

Generally the selection of a contract type depends on factors such as the nature of the construction to be procured, the uncertainties which may be involved in contract performance, and the extent to which the contractor is to assume the risk of the cost of performance of the contract. Contract types differ in the degree of responsibility assumed by the contractor for the costs of performance and the amount and kind of profit incentive offered the contractor to achieve specified standards or goals.³⁵⁴ It can broadly falls into one of the following categories depicted in figure 5.15:³⁵⁵

- Fixed price contract (Traditional contracts).

³⁵¹ OECD Benchmark Report: Improving Transparency within Government Procurement Procedures in Iraq. 2008, P.7.

³⁵² Abbas M.: Risk Management in Construction Projects. PhD. thesis, Baghdad University, Iraq, 2003.

³⁵³ Iraqi Commercial Law No. 30 of 1984: Ministry of Planning, Baghdad, Iraq.

³⁵⁴ Iraqi Public Contracts Law of 2008: Ministry of Planning, Baghdad, Iraq.

³⁵⁵ Harris, F., McCaffer, R.: Modern Construction Management. 5th Edition Black well Science Ltd, Malden USA, 2001.

- Management contracts.
- Integrated (Design - Build contracts).
- Discretionary (Partnering and Joint venture).

In Iraq, there are many standard form of contract available for use on construction projects. The most common contract type in Iraq is the unit price contract which is used in private business, in a unit price contract, the work to be performed is broken into various parts, and a fixed price is established for each unit of work. Unit price contracts are seldom used in Iraq for an entire major construction project; they do not determine the total sum of money paid to the contractor until the work is completed. They are used for maintenance and repair work.

A lump sum contract, sometimes called stipulated sum contract, is the most basic form of agreement between a contractor and an owner. The contractor agrees to provide specified services for a specific price. The owner agrees to pay the price upon completion of the work or according to a negotiated payment schedule. These contracts are used in Iraq particularly for renovate and reconstruction projects and especially with the sup contractors work.³⁵⁶

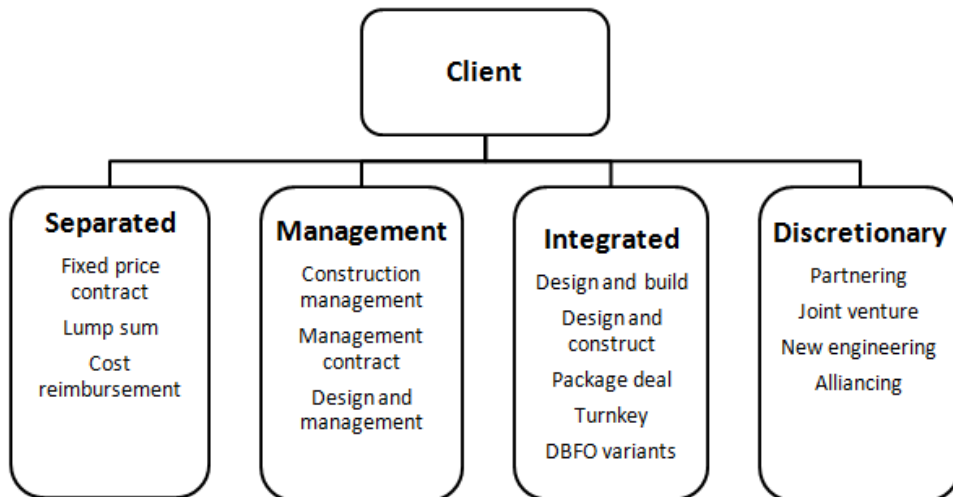

Figure 3-16: Contract procurement categories³⁵⁷

Another type of contracts we can see in Iraq which is Cost-Reimbursement Contracts, which is the cost of work plus fee (or plus fee with guaranteed maximum price) contracts. This is a rather open-ended type contract that simply states that the contractor will be directed to perform the work as specified by the owner and will be paid on the basis of the costs plus a preset fee, usually a percentage of the costs.³⁵⁸ This contract type is appropriate when the uncertainties involved in the contract performance are of such magnitude that the cost of contract performance cannot be estimated with sufficient reasonableness to permit use of any type of fixed-price contract. Iraq used this type of contracts in many reconstruction projects after 2003 war, to minimize the risk in the projects.

³⁵⁶ Zimmermann, Josef: Project Delivery Systems. Lecture Notes, Lehrstuhl für Bauprozessmanagement der TU München, 2012, P.1.

³⁵⁷ Harris, Frank, and McCaffer, Ronald: Modern Construction Management, 5th Edition, Wiley, 2001.

³⁵⁸ Levy, S.: Construction Process Planning and Management-An Owner's Guide to Successful Projects. Elsevier Inc., 2010, P.73.

The management procurement contracts can take a variety of forms. With management contracts, the client/builder appoints a full professional team and a management contractor who is responsible for managing the carrying out of the works. The management contractor does not directly undertake any of the construction work, which is broken down into packages and carried out by works contractors.³⁵⁹ This system has been widely used in Iraq, where agencies have used consultants and contractors for parts of their work. This approach was and still justified on large work that extends over long periods of time.

Design and build procurement is an approach where the contractor is responsible for undertaking both the design and the construction of the work as a general contractor in return for a lump sum price.³⁶⁰ The client may take a standard design from a manufacturer, sometimes called a “package deal”, or enter into a turnkey contract. The client may decide to place the design decision making with the contractor. In general, design and construction can be proceeding in parallel, this will short the overall project-time, and effect on reducing construction cost.

3.1.11 Iraq’s Regulatory System

For the propose of explain the ability of Iraq's construction market to finance investment requirements, it is of importance to overview the structure of the present banking and financing system, as well as the legal framework and monetary policy affecting the investment environment in Iraq. Iraq’s legal system goes back generations and has deep rooted conventions. The Iraqi legal system is essentially based on codified European legal systems. This is particularly in the case of the civil and commercial laws. However, carrying-out business in Iraq is subject to Iraq laws. The principal laws affecting these companies are as follows:³⁶¹

3.1.11.1 PPP Legal Framework Development in Iraq

Iraq's economy has suffered from an unstable phase in the relationship between the government and the private sector, began in the end of 1963, with the decisions of the nationalization of economic enterprises, which led to the weakness of private sector investment and control of public sector of all sectors of national economy.

Later in the end of 1964, the mixed sector (mixed companies) has emerged as the beginning of the concept of partnership between public and private sectors, where the law No. 103 of 1964, defines the mixed sector companies, “companies that contribute to the public sector by 51% of the capital of the company”. Little private sector investment was possible due to restricted investment rules and virtually no formal Foreign Direct Investment (FDI)³⁶². Currently there were 37 such mixed companies operating in various sectors of the Iraqi economy.

Furthermore in 1997, the companies’ law No. 21 was passed. This law permitted the establishment of joint stock companies, where the public contributes through one or more configurations of at least (25%) of the capital of the company. It states that any company doing business in Iraq must be registered with the Companies Registrar Office at the Ministry of

³⁵⁹ Barrie D. and B Paulson: Professional Construction Management. 1st. ed., McGraw-Hill, New York, 1978.

³⁶⁰ Levy, S.: Construction Process Planning and Management-An Owner’s Guide to Successful Projects. Elsevier Inc., 2010, P.75.

³⁶¹ National Investment Commission and UK trade & investment: The New Iraq Discovering Business. 2011. www.invest.promo.gov.iq.

³⁶² Zaidi, Baidaa: The Role of the Private Sector in the Iraqi Economy. MSc. thesis, University of Basra, Iraq, 2011.

Trade. According to Registration Instructions law No.196 of 2004 companies can have one of three types of registration³⁶³ :

- Representative office: a company can establish a representative office in either Iraq or the Kurdistan Region. The process is relatively simple, although it may take some time to complete. The activities of a representative office are limited to marketing and support services and it cannot transact business or enter into contracts.
- Establishment of a subsidiary: a foreign company can establish an Iraqi subsidiary in both Federal Iraq or in the Kurdistan Region. There are usually capital requirements depending on the type of business the subsidiary is conducting as well as requirements for renting space and hiring legal representatives and accountants. A subsidiary would be a standalone entity with limited liability and could transact the businesses it was incorporated to carry out.
- Establishment of a branch of the parent: a foreign company can establish a branch in either Federal Iraq or in the Kurdistan Region. Currently, the requirements for establishing a branch differ between Iraq, where the key requirement is that a company has a contract with the Iraqi Government or an instrumentality thereof, whereas in the Kurdistan Region there is no such requirement. A branch would be able to carry out the business activities of its parent, yet there would not be any limitation on the parent's liabilities in Iraq.

Moreover in 1997, the State companies' law No. 22 was issued, article 15 of these law shows that the State companies' have the right to participate with Arab and foreign companies carrying out work in Iraq. This law led to establish many joint ventures between the public and private in many sectors³⁶⁴.

After the 2003 war, several laws that went into effect improved Iraq's business environment and changed the legal regime with the aim to attract foreign investment, giving foreign investors national treatment with regard to their investments.

In 2005 and based on the State Companies' law No. 22, Ministry of Industry and Minerals of Iraq (MIM) launched an ambitious licensing program and started to promote joint ventures (minimum of 51% of total project ownership) and production sharing agreements to encourage private investment in the mineral sector. MIM selected 36 public owned companies and factories based as investment opportunities to the private sector to participate in the management and operation for 15 years. These investment opportunities worded on the principle of partnership in production, where the investors are responsible for the rehabilitation and management, operation and maintenance as well as the project financing for a limited period. The public keeps a share of the production until the end of the contract which is for 15 years, were the ownership goes back to the public sector. (Previous reference)

The Multilateral Investment Guarantee Agency (MIGA), and the World Bank Group were the responsible side of insurance of the political risk of Iraq with guarantees for companies that invest in the country. MIGA's commitment in Iraq (the first contract guarantee was entered in October 2010) contributes to confidence building in the sustainability and viability of investing in the country's industries. Moreover, this considered as the first successful public private partnership in Iraq.

³⁶³ National Investment Commission and UK trade & investment: The New Iraq Discovering Business. 2011. www.investpromo.gov.iq.

³⁶⁴ Zaidi, Baidaa: The Role of the Private Sector in the Iraqi Economy, MSc. thesis, University of Basra, Iraq, 2011, P.113.

In 2006, the Gol embarked on a new policy reform, a new investment law No. 13 was issued.³⁶⁵ This law has clarified the basic rules for the investor, besides the provision of many guarantees. Moreover, the Gol is concentrating an improving by a new law for PPP, to support the investment law. Both laws will be detailed in next sections.

The investment law No. 13 did not refer to any mechanism or model of PPP. Moreover, according to the law the right to own land is restricted only to investors of residential projects. Any application of PPP models where typically a project company takes ownership of the project at least temporarily, like build-operate-transfer (BOO) or build-own-operate-transfer (BOOT) schemes are becoming impossible. Furthermore, the law also permits long-term leases, restricting to fifty (50) years. Thus other project models like build-lease-operate-transfer (BLOT) and build-transfer-operate (BTO) become more promising.

In a (BLOT) scheme, the private company organization designs, finances and builds a facility on leased public land. The private organization operates the facility for the duration of the lease and then transfers ownership to the public organization. The lease would be registered with the local land registration authorities to provide public notice and gain more certainty concerning validity and enforceability. E.g. this scheme is applied at the north of Iraq since 2006 by the Kurdish Regional Government (KRG), for a project of 1000 MW power plant contract to produce electricity. KRG leased the real estate to the private company as a long-term agreement (25 year according to the investment law). The private company builds, operates, finances and maintains the power plant for the specified and then transfers ownership to the KRG. With the help of this project the local government raised the electricity supply hours from 8 hours to 23 hours per day. That equates to 14% of the current Iraqi network and 36% of the electricity needs of the northern region.

A (BTO) scheme may be required for projects that Iraqi public authorities deem to be too important to the national interest to be leased to private contractors, where infrastructure projects are typical candidates. In such case, a (BTO) scheme would allow the project to be transferred to the public authority upon its completion, and then operated pursuant to a management agreement. This scheme is not applied in Iraq yet.

Following the successful completion of PPP projects by the Kurdish Regional Government (KRG), through the National Investment Commission (NIC), Gol has asked international investors to submit proposals to set up gas or oil-fuelled energy plants under BOO contracts. At least 43 international investors, some in partnership with Iraqi companies, have submitted proposals to the NIC. Although, the MoE 2015–2030 Master Plan further confirms that power demand in Iraq will average 32 GW by 2030 with approximately USD 28 billion of investment necessary between 2015 and 2030. Of this total, approximately USD 21.13 billion is intended to be funded by private investors.

3.1.11.2 Investment Law No. 13 of 2006

In 2006, the Gol embarked on a new policy reform, a new investment law³⁶⁶ was issued. The new investment law covers all sectors of the economy with the exception of banking, insurance, oil and gas extraction and production. The law set out the basic rules and guidelines applicable to all types of investment by local and foreign private sector investors, co-operative, mixed, and public sector. Investors may do this through investment in construction and operation of

³⁶⁵ Iraq Investment Law No. 13 (2006): Iraq.

³⁶⁶ Iraq Investment Law No. 13 (2006): Iraq.

new project, investment in expansion and technical upgrading of existing projects, or purchase of equity in existing projects. Besides the provision of many guarantees and protection such as:

- Iraq has start to formally adopt the PPP schemes to develop basic infrastructure, With the exception of banking, insurance, oil and gas extraction and production.
- The provision of guarantees to protect private investors from project risks related to the Gol's responsibilities or payment obligations, political risks and market demands.
- The exemption from certain taxes is granted. If projects are at least 50 % Iraqi owned, a 15-year exemption from taxes is granted; otherwise, a 10 year tax exemption applies.
- Article 2 of the first amendment of the law (approved on the 13 October 2009) has given investors the right to own 100% of the operating company and the land, in the context of residential projects.
- Gol may grant that the necessary land for the strategic project is free of charge.
- Gol clarified the leasing rights. Gol now offers 50-year leases for projects and secured privileges for PPPs.
- Investors shall enjoy the protection from nationalization.
- Investors can hire non-Iraqi workers.

Article 11	Article 12
<p>The investor shall enjoy the following benefits:</p> <p>First: The investor shall have the right to take out the capital he brought into Iraq and its proceeds in accordance with the provisions of this law and pursuant to the instructions of the Central Bank of Iraq in an exchangeable currency after paying all his taxes and debts to the Iraqi Government and all other authorities.</p> <p>Second: The foreign investor shall have the right to:</p> <p>A. Exchange shares and bonds listed in the Iraqi Stock Exchange.</p> <p>B. Form investment portfolios in shares and bonds.</p> <p>Third: Renting or leasing lands needed for the project for the term of the investment project, provided that it does not exceed 50 years renewable with the agreement of the Commission, and provided that the nature of the project and its benefit for the national economy is taken into consideration when determining the period.</p> <p>Fourth: Insuring the investment project with any foreign or national insurance company it deems suitable.</p> <p>Fifth: Opening accounts in Iraqi or foreign currency or both at a bank inside or outside Iraq for the licensed project.</p>	<p>This law shall guarantee the following for the investor:</p> <p>First: Priority in recruitment and employment shall be given to Iraqi workers. The right to employ and use non-Iraqi workers in case it is not possible to employ an Iraqi with the required qualifications and capable of performing the same task in accordance with guidelines issued by the Commission.</p> <p>Second: Granting the foreign investor and non-Iraqis working in the investment projects the right of residency in Iraq and facilitating his/her entry and exit to and from Iraq.</p> <p>Third: Non-seizure or nationalization of the investment project covered by the provisions of this law in whole or in part, except for projects on which a final judicial judgment was issued.</p> <p>Fourth: Non-Iraqi technicians and administration employees working in any project shall have the right to transfer their salaries and compensations outside Iraq in accordance with the law after paying their dues and debts to the Iraqi government and all other entities.</p>

Figure 3-17: Excerpt of the Iraq investment law No. 13 of 2006³⁶⁷

³⁶⁷ Ministry of Planning (2006): Iraq Investment law No. 13, Iraq.

- Investors can invest in the Iraqi stock exchange and creating stock portfolios.
- Investors shall have the right to insure the projects internationally, opening of a bank account in Iraq.
- Assets and materials imported for the project will not be subject to taxes or fees within three years of the date that the project.

The new investment law has made a big qualitative change in the Iraqi economy by means of incoming capital and foreign experience, which will contribute to establishing the basic infrastructure of the Iraqi economy. The investment law establishes the basic rules for the investor with guarantees and protection to establish a secure environment for investment. Furthermore, the guarantee provision has not been hitherto experimented in practice because the guarantee program is still at its infancy stage, the initiative to provide guarantees should be deemed as, at least, a stepping-stone on the way to making the investment environment friendlier.

3.1.11.3 The Private Investment Law in the Refining of Crude Oil No. 64 for 2007

This law aims at encouraging the private sector to participate in the economical development in Iraq and contributing in building the free crude industrial base through entering in the activity of refining oil. The project obtaining the investment license according to provisions of this law enjoys the privileges determined for the projects established in the districts.

3.1.11.4 The Public-Private Partnership Law

Recently the Gol is concentrating an improving by a new law for PPP, to support the investment law and to establish a favorable legal framework. This law is at the drafting stage now. The major PPP models defined by the PPP law are: build-operate-transfer (BOT), build-own-operate-transfer (BOOT), build-own-operate (BOO), build-transfer (BT), build-transfer-operate (BTO), management contract (MC), build-lease-transfer (BLT), expand-operate-transfer (EOT), rehabilitate-operate-transfer (ROT), leasing contract (LC). Thirteen legal core areas were identified that the new law will organize it: ³⁶⁸

- Basic legal framework.
- Commercial status.
- Investment regime.
- Public procurement.
- Economic reform.
- Public Private Partnerships.
- Litigation, jurisdiction and international treaties on investment protection.
- Labor code.
- Agriculture regime.
- Intellectual property rights.
- Property rights (related to land regime).
- Tax and customs.
- Banking.

³⁶⁸ UNDO: Draft Law on Public Private Partnership, Program for Iraq, 2011.

Article 15, provides the Gol's support and guarantees to a PPP project, which it includes: (previous reference)

- Gol support to the investors in land acquisition and the use of Infrastructure, public service facilities owned by the Gol.
- Gol Participation in the registered capital of the special purpose company established by the private party.
- Gol guarantee for the purchase, of the product or services generated by the PPP project.
- Investors shall enjoy the extension of public loans to the private party to lower the project's financing cost.
- Gol guarantees or risk-sharing arrangements against certain project risks outside the control of the private party, such as political risks, demand risks, currency risk and the risk of default by a contracting authority.
- Investors shall get financial assistance through the Viability Gap Fund for PPP projects, which are economically and socially viable but not financially attractive if constrained by affordable tariffs, rents or user's fees.

The establishment of the PPP law will give more administrative power to government officials, The new Policy Board will concentrate the entire PPP topics at one government agency, the main responsibilities of the Policy Board would be to approve, reject or send back for reconsideration PPP project proposals, develop standard documents, procedures and guidelines for the efficient implementation of the PPP, evaluating the impact of PPP proposals, review and analyze the budgetary implications of all requests for government support. The PPP law will play a significant role in Iraq PPP development, guides the implementation by various relevant project parties. By this law the Policy Board is the government agency in charge of PPP projects.

3.1.11.5 Other Laws Affecting doing Business in Iraq

- State Companies law, No. 22 of 1997.
- Companies Law 21 of 1997.
- Commercial Agencies Law, No. 51 of 2000.
- Law on Registration Agents, No. 4 of 1991.
- Iraq's Commercial Law, No. 30 of 1984.
- Insurance Law No. 10 of 2005.
- Income Tax Law, No. 113 of 1982.
- Sales Tax Law, No. 36 of 1997.
- Real Estate Lease Tax Law, No. 162 of 1959.
- Real Estate Transfer Tax Law, No. 120 of 2002.
- Property Tax law (Vacant Land Tax Law), No 26 of 1962.
- Customs Law, No. 23 of 1984: Companies that are carrying out business in Iraq generally paying taxes to the Ministry of Finance; the general rate is 15% of net income. However, exemptions can be made according to the agreement with the Gol.
- Employment Law No. 71 of 1987: Iraqi Employment law allows the use of foreign labor to work on projects in Iraq. However, where a foreign investor seeks to obtain an investment license, the National Investment Commission will look for 50% of the labor force comprising Iraqi labor, provided that such labor has the requisite skills. It is also important to note that a

foreign business entity in Iraq must enter into a contract, governed by Iraqi Law with its employees and the contract must be in the Arabic language. It must contain certain provisions relating to health and safety and training, as well as termination provisions.

- Registration Instructions, No.196 of 2004: Under the company law, Limited Liability Companies and Joint Stock Companies are the main types of companies in Iraq. In addition, partnerships Companies are also companies that regularly but are less common for foreign investors. In addition, there exist special provisions for companies in which the state holds.
- Public Contracts Law 2008: For the contracts with the government, a new government contracts' execution law was passed in 2008, it suspended the application of the previous 2007, 2001 tender instructions for state agencies and the 1988 instructions for implementation. The new government contracts' law contains several sections, including details on the principles for government procurement in general, as well as for open competition and negotiated procedures in particular; description of the contracting authority; the standard public contract provisions and contract specifications; the financial requirements and the dispute resolution system and procurement integrity and conflict of interest principles.³⁶⁹
- The Law of Insurance Business No. 10 for the year 2005: According to this law the insurance board was founded which undertakes according to the provisions of article 6 of this law regulating the insurance sector and supervising it in what ensures developing it and providing financially open, transparent and safe market.

The provision of a good legal framework is essential for a good investment environment. This development in the Iraqi legal framework is a forward step to establish a favorable legal framework, to expand and improve the private sector resources for financing, construction, maintenance and operation of infrastructure and public services facility projects in Iraq.

3.1.12 Structure of the Financial System of Iraq

The structure of the financial system consists of the public sector, which includes public finance and government debt, the government securities market, the private sector, which includes the stock exchange market, the banking sector, and the foreign exchange market. Generally, In any economy, there should be a strong relationship between all elements of the financial sector in order for there to be more efficiency in the economy and to assist in pushing economic growth forward.³⁷⁰

As the country which contains the world's second largest reserves of oil, estimated at between 115 and 143 billion barrels, it is not surprising that Iraq's economy and financial performance depends on the performance of the oil sector. Revenues from oil account for about two-thirds of Iraq's GDP and for almost all export and fiscal revenues. Figure 3-18 shows that in 2008, 56% of GDP came from oil.

³⁶⁹ OECD Benchmark Report: Improving Transparency within Government Procurement Procedures in Iraq. 2008, P.18.

³⁷⁰ Abdullatif, E.: Development of Government Bond Market in Iraq. Institute of Developing Economies, Japan External Trade Organization, 2009, P. 47.

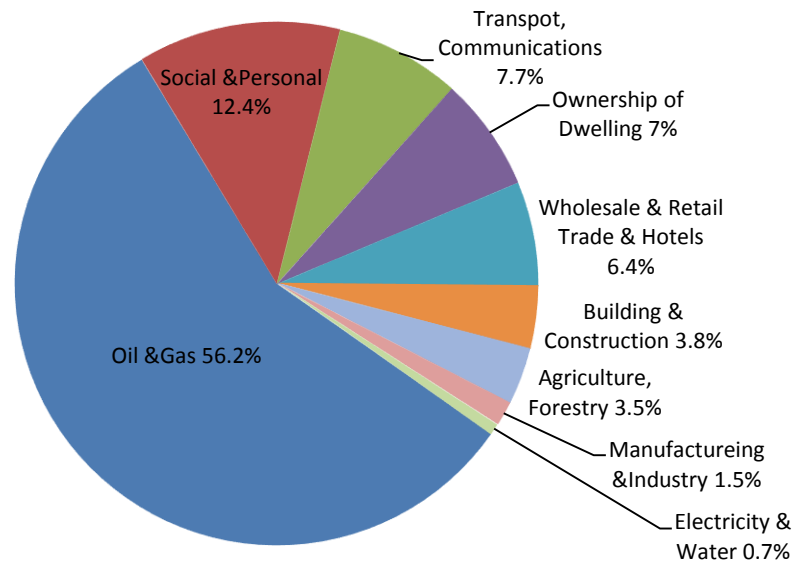

Figure 3-18: Structure of the Iraq economy 2008³⁷¹

As a result, oil plays a pivotal role in the economy, not only contributing the majority of GDP and hence determining growth, but it also accounts for nearly 90% of government revenue and nearly all its exports. Overall GDP growth is vulnerable to oil price and volume shocks. Financial sector deepening is required to support growth of the non-oil sector.³⁷² The Central Bank of Iraq (CBI) is responsible for conducting monetary policy in Iraq. The CBI has brought inflation down from a peak of more than 70 % in 2006, to 4.3 % in 2013, primarily through appreciating the currency, as shown in table 3-29 below.³⁷³

Economic indicators	2007	2008	2009	2010	2011	2012	2013	2014
GDP (US\$ bn)	88.8	131.61	111.66	135.49	180.61	212.5	233.3	253.74
GDP PPP (US\$ bn)	156.26	170.28	181.74	194.96	216.20	238.61	264.47	292.52
GDP per capita (US \$)	3,003	4,328	3,575	4,278	5,529	6,306	6,708	7,074
GDP per capita PPP (US \$)	5,282	5,599	5,819	6,156	6,619	7,080	7,605	8,155
Annual GDP growth %	1.4	6.6	5.8	5.9	8.6	8.4	9	8.4
Current account balance (US \$m)	6.9	16.8	-9.3	4.1	22.5	14.9	8.4	7.3
Current account balance (% GDP)	7.7	12.8	-8.3	3.0	12.5	7.0	3.6	2.9
Inflation %	30.8	2.7	-2.2	2.4	5.6	6.1	4.3	5.5

Table 3-29: Resent Iraq economic indicators³⁷⁴

³⁷¹ www.worldbank.org.

³⁷² Naser , Sahar: Financial Sector Review. World Bank, 2009.

³⁷³ Australian Government: Iraq Fact Sheet. Department of Foreign Affairs and Trade. 2013, <http://knoema.com/atlas/Iraq/CPI-inflation>.

³⁷⁴ www.worldbank.org.

3.1.12.1 Banking System of Iraq

The financial sector in Iraq is composed of the banking system and financing institutions. The Central bank of Iraq (CBI) is the main implemented of the government policy and plays a dominant role in directing and orienting the Iraq economy. The Iraqi banking system includes 51 banks, and classified as follows:

- 7 state-owned banks which are; Rafidain, Rasheed, and Trade bank of Iraq (TBI), bank of Iraq, and 3 special-purpose banks. Which control over 85 percent of banking assets, they had a large network of more than 530 branches around Iraq.
- There are also 44 privately owned commercial banks licensed by (CBI), 10 foreign banks either have licensed branches in Iraq or have strategic investments in Iraqi banks, and 11 private commercial Islamic banks.

The TBI is a specially established in (2003) as a state bank set up to facilitate Iraq's international trade and the reconstruction, TBI provides direct finance for major infrastructure projects in Iraq and arranges larger loans via groups of banks through letters of credit LCs. In 2009, the Iraqi Ministry of Finance (MOF) opened the government LC business by granting private banks permission to issue LCs below 4 Million USD in size.³⁷⁵ Moreover, there were 7 insurance companies, including 3 public companies and 4 private companies, as well as 9 private companies in financial investment.³⁷⁶

The special-purpose banks (The Real Estate bank; the Agriculture bank; Iraq bank; and the Industrial bank) are established to meet financing needs in particular fields:

- The Real Estate bank was established in 1949 to provide financing for housing and construction projects, the bank has 25 branches.
- The Agricultural bank was founded in 1936 and traditionally has lent to private sector agriculturalists, the bank has 40 branches.
- The Industrial bank was split off from the Agricultural bank in 1940. Clients are both public- and private-sector companies, the bank has 9 branches.

The financial sector in Iraq is relatively small and its contribution to GDP is limited. The banking system dominates the Iraqi financial system, accounting for more than 75% of its assets. The banking system is small, assets-to-GDP ratio is equivalent to 73% of GDP compared to 130% for the MENA region. The banking sector is dominated by public ownership (See Figure 3-19).

Private Banks compete on an unlevelled playing field with state-owned banks. Based on instructions from the government, state-owned enterprises and government agencies are not permitted to do business with the private banks, which is a major impediment to the development of a viable private banking sector. Government agencies and state-owned enterprises are not allowed to place deposits with private banks, nor can state-owned enterprises receive loans from private banks.

³⁷⁵ National Investment Commission: Investment Overview of Iraq-Banking and Finance Guide. Iraq, 2009.

³⁷⁶ Central Bank of Iraq: Annual Report. Ministry of Financing, Baghdad, Iraq, 2013.

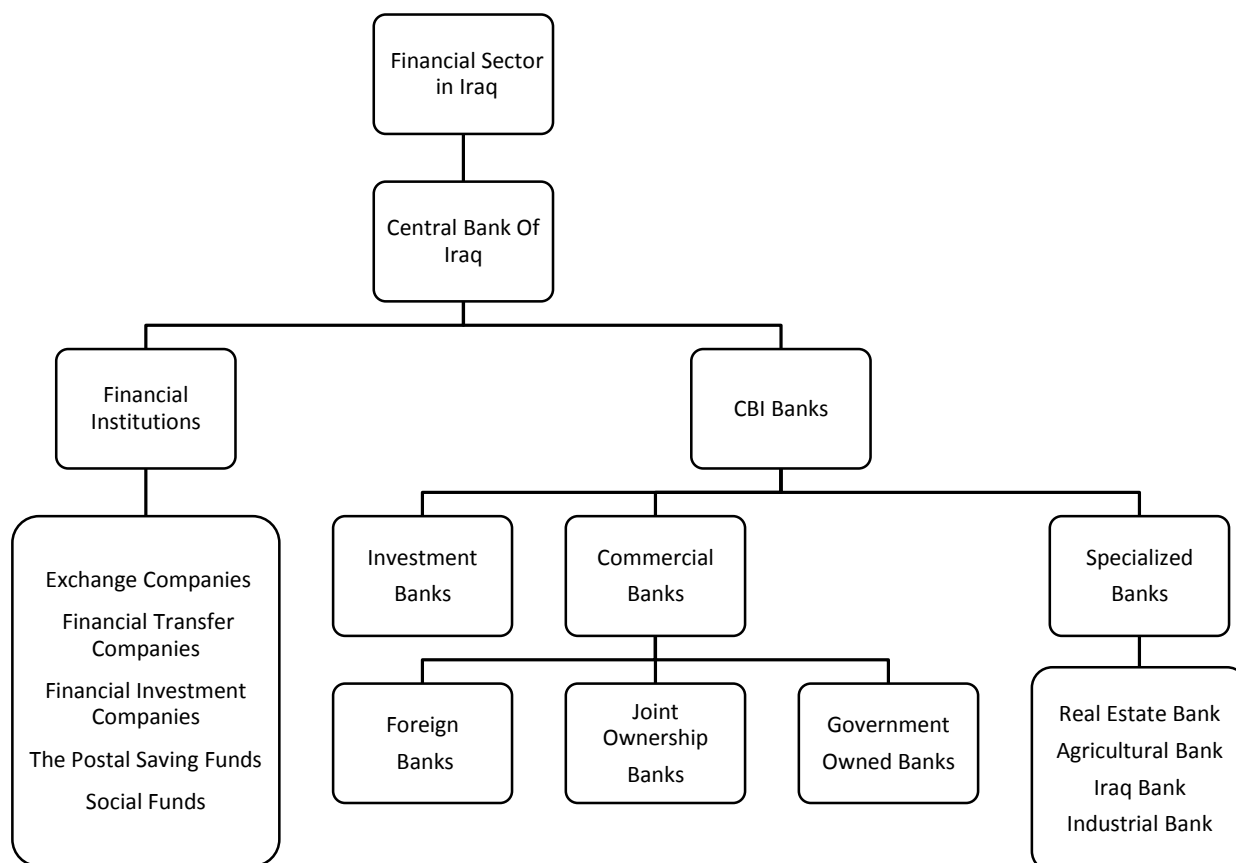

Figure 3-19: Financial sector structure in Iraq³⁷⁷

Moreover, payments to the government (taxes and other payments) cannot be made by checks drawn on a private bank. The large state-owned banks benefit from an implicit government guarantee on deposits. In contrast, depositors in the private banks are not protected. Moreover, private banks have very little access to the lucrative business of issuing letters of credit for imports by the government and state-owned enterprises. Several banks are now able to issue such letters of credit. Overall, the financial system is dominated by public ownership, lacks competition and plays a limited role in the overall economy.³⁷⁸

Recently, Gol has adopted a Financial Sector Reform Strategy, which was developed with the support of the World Bank. The strategy focuses on the restructuring of state-owned banks, the dominant financial institutions. It also flags the importance of attaining a level playing field. Strengthening the regulatory and supervisory framework is one of the key pillars, as well as modernizing the financial institutional infrastructure. (previous reference)

Both governmentally owned and joint ownership commercial banks provide the public and private sectors with their working capital requirement as well as the finance of international trade in general. The main objective of financing institutions is to help the domestic banking

³⁷⁷ Prepared by the author.

³⁷⁸ Inger Andersen, Loïc Chiquier, Hedi Larbi, Simon C. Bell, Hooman Dabidian: Iraq Investment Climate Assessment. World Bank, 2012.

system in catching up with the technique evaluation of projects, as well as to contribute to the assessment of a capital market capable of funding development requirements.³⁷⁹

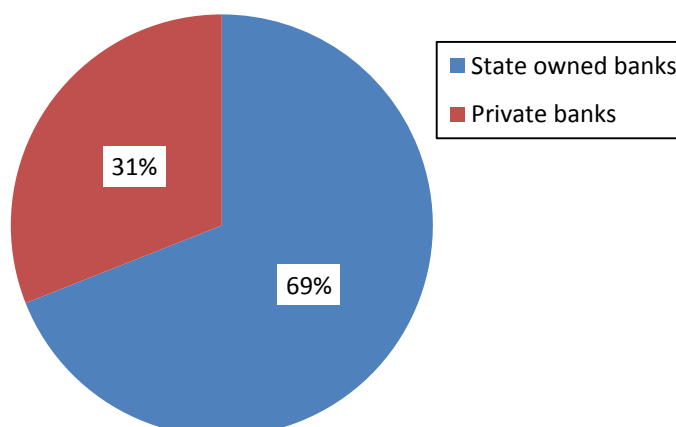

Figure 3-20: Structure of the Iraqi banking system (share in credits to the economy)³⁸⁰

Services offered by Iraqi commercial banks include current accounts, savings accounts and time deposits, short-term overdraft and bills discounted facilities, as well as short-term loans and advances. Banks also offer bid, advance payment and performance bonds (but the maximum tenor is 12 months). A few banks offer loans over one year in tenor.³⁸¹

3.1.12.2 Iraqi Insurance Market

The size of the insurance market cannot be properly assessed because of the lack of reliable data. In addition to the three state-owned insurance companies (the National Insurance Company, the Iraqi Insurance Company, and the Iraqi Re-insurance Company), there are about 18 private sector companies.

The state-owned insurance companies dominate the market. The reason for the domination of the state owned insurance companies due to that almost all government contracts for insurance services are given to the state owned insurance companies. Although article 81 in the Insurance Business Regulation Law 2005 requires that government contract for insurance shall be procured through a public tender where all licensed insurance companies are allowed to participate, the common perception is that the state-owned insurance companies always are awarded the contracts with the government.³⁸²

Under the Insurance Business Regulation law No. 10 of 2005, foreign investors are allowed to invest in the market as long as they comply with the laws and the capital requirement, and as the new investment law only allows foreign insurance companies in Iraq but not to invest in the insurance sector of Iraq, the private insurance market turns out to be of small size in comparison to the public side. The total aggregate annual amount of gross written premium for the 18 privately owned insurance companies in Iraq are 60 – 80 Million USD, while the three

³⁷⁹ Central Bank of Iraq: Annual Report. Ministry of Financing, Baghdad, Iraq, 2012.

³⁸⁰ Central Bank of Iraq: Annual Report. Ministry of Financing, Baghdad, Iraq, 2013.

³⁸¹ Munro, David: Overview of the Iraqi Banking System-The State Owned Banks. U.S. Agency for International, 2007, P.4.

³⁸² Sahar Naser: Financial Sector Review. Iraq, World Bank, 2009.

public owned insurance companies value four or five times of that. Moreover, reinsurance is not much used and it is thought that the total amount of reinsurance premium is equal to maybe 15–25 percent of the gross premium written.

On the other hand, the government has taken some measures to improve the legal and supervisory framework for the insurance sector. A new insurance law The Insurance Business Regulation Act from 2005 has been passed and a supervisor has been established.³⁸³

³⁸³ <http://misbahkamal.blogspot.de/2012/03/world-bank-iraqs-insurance-sector.html>

3.2 The BOT Financial Model: Al-Quds-Gas Power Plant Project

The most effective way to analyze the financial feasibility of a prospective project is to use a specially designed financial feasibility assessment model. Many different scenarios have to be studied in the process of analyzing the financial feasibility of a project, and assumptions and project conditions often change during the decision-making process. Using a model for the calculations saves both time and money, and reduces the probability of calculation errors.

A financial feasibility assessment model can be designed and built in many different ways. The clearest and most effective way is to use a modular architecture, i.e. to build the model from several modular components. Each module represents a specific model function and modules interact by receiving and delivering data from one another. Modules make the model development and maintenance more focused and transparent, and also make it easier for the user to understand and visualize the functionality of the model.

Most financial feasibility models are custom made, as there are no standard model solutions on the market. The main reason is that investment projects are very diverse in nature, and appropriate model attributes vary from one project to another. It is therefore very complex to develop a model that can accurately estimate the financial feasibility of every project type.

This chapter presents a detailed methodological framework for the evaluation of the financial viability of BOT power plant concession projects. These projects form a significant part of the overall number of projects that are developed as PPPs and enjoy worldwide interest.

In infrastructure projects, public sector are considering the best options for long-term asset management, hence public sector will have a multitude of parameters to evaluate as part of the decision making process. They will need to decide whether to choose PPP as an option and if so what type of service would be appropriate. In this context, decision managers look to utilise some form of systematic approach to organise and evaluate the information and inputs to determine the best outcome. In the context, this chapter will apply a financial model of a BOT project in order to help decision makers in MoE to assessing cash flows and, Moreover, showing the project financial performance from different perspectives of key stakeholders.

3.2.1 Model Selection

The evaluation of long-term contracts in assets such as infrastructure projects has been implemented through a variety of methods, such as the Payback Period (PBP), the Net Present Value (NPV), the Profitability Index (Benefit-Cost ratio) (PI/BCR) and the Internal Rate of Return (IRR). Among these methods the NPV and IRR are the most popular and widely used to date, with PBP used also but in a secondary level of analysis³⁸⁴.

The financial model and the subsequent quantitative models presented in this chapter draw elements from various similar seminal analyses, namely from Kakimoto & Seneviratne (2000), Seneviratne & Ranasinghe (1997) and Javid & Seneviratne (2000), and to a lesser extend from Vassalo & Izquierdo (2002) and Abdel Aziz & Russell (2006) and Mainul (2008)³⁸⁵.

³⁸⁴ Keown, A.J. *et al.*: Financial Management-Principles and Applications, 10th Edition, Pearson Prentice Hall, Upper Saddle River, NJ, 2005.

³⁸⁵ Islam, Md. Mainul: Optimizing Concessionary Items' Values for Procuring Privately Financed Infrastructure Projects. PhD thesis, Griffith School of Engineering Science, Environment, Engineering and Technology, Griffith University, 2008.

In fact the basic components of the formulation are exactly the same, with the difference that in the detailed framework specific revenue and cost models are presented for one specific type of infrastructure projects (power plant). It provides a useful mechanism to both concessionaire and government, with easy input of parameters and variables, the model can come up with useful financial reports and graphs to help concessionaires know more about the project viability by estimate the project' cash flows over the life of the project.

In these studies the parameters that affect the infrastructure-generated net operating income come after the analysis of the various sources of risk that such projects are subject to, as presented in detail in the literature review of this dissertation. In these studies the parameters are assumed to be the following: infrastructure demand (power generation), user-charges (fees), growth factors, initial construction, operating, maintenance and O&M cost estimates, and price escalation rates. These variables are also considered to be the basis of the models presented in this dissertation (with departures made through extensions and modification where deemed necessary). The proposed models are described in detail and the various variables are identified in the following sections.

3.2.2 Key Definitions

To facilitate definitions, Figure 6.1 illustrates cash flows over the economic life of a typical BOT project from different perspectives of key stakeholders. The symbols representing different periods are defined herein, while the symbols representing cash flows will be detailed in Section 3.2.4.

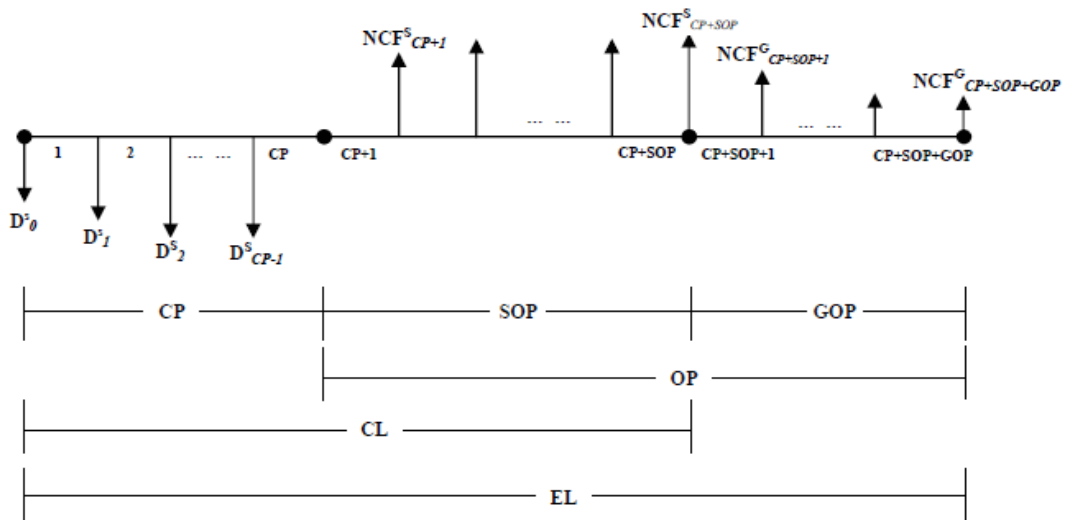

Figure 3-21: Cash flows for a typical BOT project³⁸⁶

Construction Period (CP): The duration within which construction activities of a BOT project are supposed to be completed (according to contractual agreement) is referred to the construction period. The construction period virtually experiences very negligible or zero financial receipts.

³⁸⁶ Previous reference.

Operation Period (OP): Following the construction period, the duration of a BOT project within which it is capable of earning revenue is referred to the operation period.

Sponsor Operation Period (SOP): The duration of the operation period available to sponsors immediately following the construction period, in which to recoup the investment costs with a reasonable profit, is the sponsor operation period.

Concession Length (CL): The duration comprising the construction period and the sponsor operation period is termed the concession length of a BOT project.

Economic Life (EL): The construction period and the operation period comprise the economic life of a BOT project.

Government Operation Period (GOP): The operation period available to the government immediately following the sponsor operation period until the end of its economic life is termed the government operation period.

Base Cost (BC): Base cost is the outlay in constant-dollar value, which represents development costs including the construction cost of a BOT project. Depending on project characteristics, other costs such as land expropriation and upfront and commitment fees involved in loan processing may be included in the base cost. Decision makers often estimate base cost at market prices of a predetermined year.

Base Demand: The projected demand of a product (such as annual energy production) at the beginning of the operation period of a PPP project is defined as base demand. Base demand is often termed initial demand.

Base Price: The sale price (at the beginning of the operation period of a BOT project) per unit quantity of a product is referred to base price. The generic term base price, in fact, is analogous to initial tariff or initial toll.

Equity Level: Equity level is the percentage of equity contribution to the base cost, both after considering the effect of inflation.

Debt/Equity Ratio: This constructs the capital structure. With it, the concessionaire can decide how much of the required capital should be borrowed from banks and how much of the capital is to be raised from the public

Interest Rates: Long-medium-term loans are usually the main capital sources. However, to meet the capital requirement in a short period (less than one year), short-term loans may be needed, especially during the construction period. Reasonable interest rates of both long-medium-term loans should be estimated.

Grace Period: The grace period, usually accompanying long-medium-term loans, indicates the period during which the loan borrower (the concessionaire in this case) only has to pay the interest, not the principle. This is significant to the concessionaire in the construction period,

because in a BOT project revenues start in the operating period. The flexibility of the grace period could release much of the concessionaire's financial load during the construction period.

Debt Repayment Period: The debt repayment period refers to the time needed for the loan borrower to pay off all the interest and principal. It comes after the grace period.

Payback Period: The payback period is "defined as the expected number of years required to recover the original investment".³⁸⁷ It takes account of all cash flow regarding debt, stocks, revenues, etc.

Tax Rates: These affect the net income and the outcome of the financial reports in a project. In this work, both the business income tax and the value-added tax are considered. The business income tax comes with the income of a business entity (a company, a store, etc.), while value-added tax accompanies the sales of goods or products.

Return on Equity (ROE): Equity is mostly raised by issuing stocks. Thus, the rate of return on the stockholder's investment becomes crucial, for it influences the willingness of the public to invest on the project.

Inflation Rate: In general, longer-term projects have more to gain from inflation than shorter-term ones.³⁸⁸ Therefore, the inflation should be taken into account.

Net present value (NPV): Cash flows are to discount back to the present year (or a specific year). A zero value of NPV represents the breakeven point of a project. If the value of NPV is positive, the project is worth investing, profitable and adds monetary value to the firm, thus increasing the wealth of the owners. In case that the value of NPV is zero, the project repays the original investment plus the required rate of return. The decision makers should choose whether to accept or reject the project since the project neither gains nor loses monetary value. Conversely, if the value of NPV is negative, it is better to decline the project since it does not yield any benefits.

Discount Rate: In the real world, the currency value usually depreciates year by year. Accordingly, the value of time should not be neglected. In context with Ye and Tiong (2000) and Zhang (2005), the discount rate adopted in this work is the weighted average cost of capital (WACC) discount rate using the interest rate of the long-/medium-term loan, the return on equity, and the debt/equity ratio.³⁸⁹ It can be presented as the following equation:

Discount rate = Interest rate of long-medium-term loan × Debt percentage + Return on equity × Equity percentage

However, the discount rate used in this model appraisal is calculated according to the above mentioned formula, and it is 12.4 % for the base case(case A).

³⁸⁷ Brigham, E., and Gapenski, L.: Financial Management-Theory and Practice. 8th. Edition, Dryden Press, Fort Worth, Texas, 1997.

³⁸⁸ Harvey, Charles: Analysis of Project Finance in Developing Countries, London,1983, P.171.

³⁸⁹ Chen, T.: Brief Description and Operation of Financial Planning and Modelling. Conference on Private Investment on Transport Construction, Ministry of Transportation and Communication of Taiwan, 1998.

Internal rate of return (IRR): IRR is the rate of return that assumes the NPV value of a project to be zero. To evaluate a project with IRR, just compare it to the estimated cost of capital (plus several percentage points to compensate for the risk, time, and trouble associated with the investment). If IRR is greater than the required rate of return, the project is acceptable and it means that the project will be financially feasible. Otherwise, it is a better idea to reject the project.

3.2.3 Assumptions for the Financial Model

The following are the basic assumptions in derivation of the financial model. The assumptions are made in light of the extant literature and are listed as follows:

- The project is procured through a BOT scheme,
- All cash flows as well as inflation rates are discrete.
- Base cost is pre-estimated immediately before the start of the construction period.
- Both construction and operation periods embrace the project's economic life.
- Length of the construction period is pre-fixed.
- The major debt source comes from the long-/medium-term loans, and fixed interest rate.
- No interest is paid on the debt during construction and the interest rate will remain constant throughout the construction period.
- A grace period equal to the length of the construction period is available.
- Construction cost and construction duration are independent.
- Base demand and base price are not correlated.
- Foreign currency is considered in project capital.
- All the financial instruments available in the project are broadly divided into equity and debt. Equity and debt will be drawn annually according to the equity level.
- Debt will be repaid in annual equal instalments.
- Equity and debt will be drawn at the beginning of a specific year of the construction period, while cash flows during the operation period will be realized at the end of a particular year of the operation period.
- Only income tax and value-added tax are considered.
- Annual operation and maintenance cost are consisting of the flowing costs: staff cost, fuel cost, fixed operation and maintenance cost, variable operation and maintenance cost, Insurance cost.
- Finally, the financial modeling assumed the transaction costs is a part of the initial project cost.

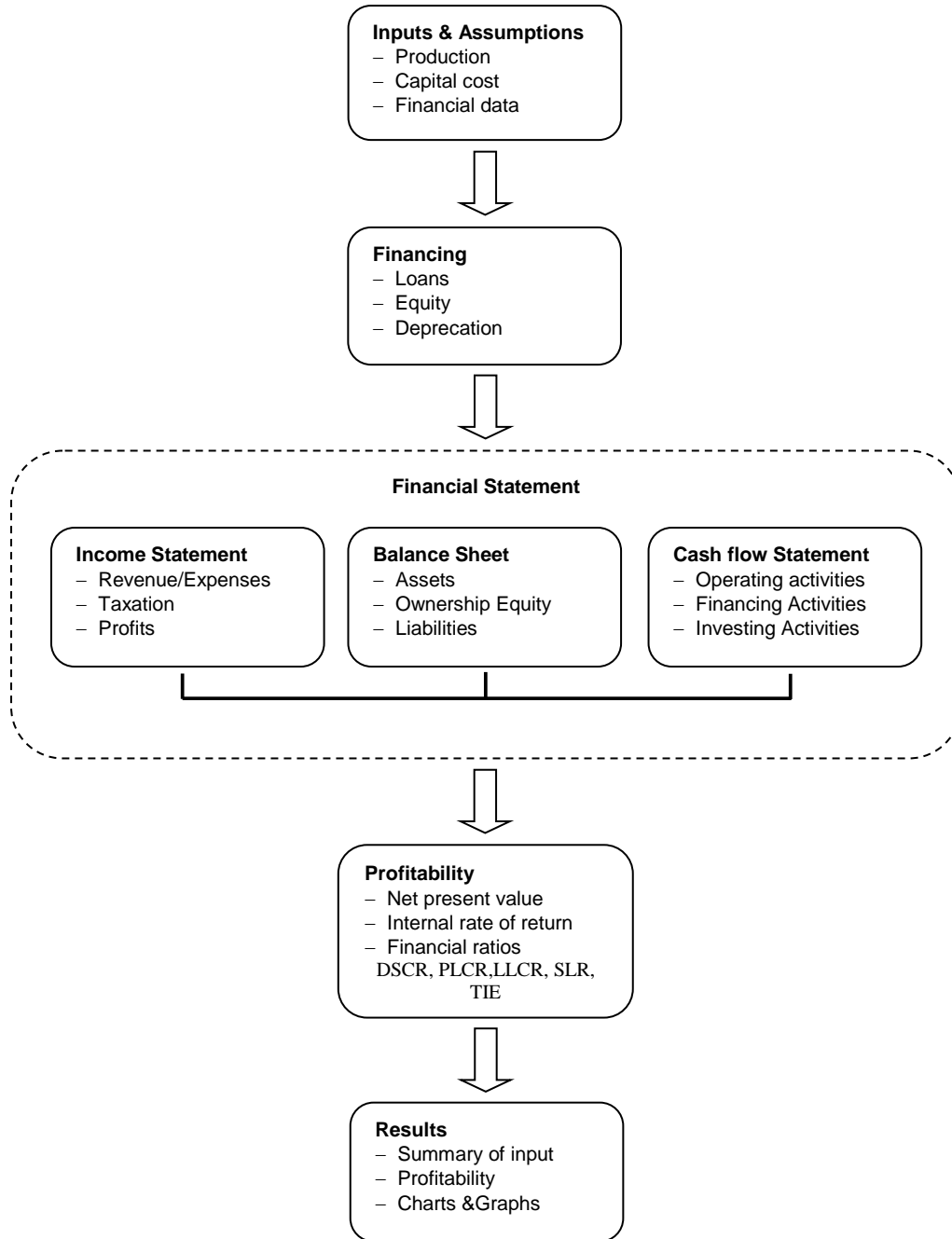

Figure 3-22: Structure of the financial model³⁹⁰

3.2.4 Derivation of the Financial Model

The well-known discounted cash flow techniques are used to derive the financial model as below:

- a) **Total Project Cost:** According to Ranasinghe (1996)³⁹¹, the total project cost consists of the sum of annual base cost (initial construction cost), additional cost owing to inflation of

³⁹⁰ Prepared by the author.

annual base cost, and annual debt interest during the construction period, which is to be accumulated at the end of the construction period.³⁹² Therefore, the TC is represented by the following function:

$$TC = \sum_{i=1}^{CP} BC_i + EC_i + IC_i$$

Where

TC = Total project cost from sponsors' perspective.

Equation 3-1: Total project cost from sponsors' perspective

b) Annual Base Cost: The estimated percentage of construction works to be completed in a specific year of the construction period is calculated as:

$$BC_i = \delta_i \times BC$$

Where

BC = Base cost stipulated at beginning of the construction period in constant- dollar value;
 BC_i = Portion of base cost at the beginning of the i th year;
 i = Index for the construction period, $i \in [1, CP]$;
 δ_i = Percentage of base cost in the i th year; and
 CP = Length of the construction period (year).

Equation 3-2: Base cost at beginning of the construction period

c) Inflation of Annual Base Cost: Additional cost owing to inflation of annual base cost, calculated at the beginning of the construction period is calculated as:

$$EC_i = BC_i \times \left\{ \left(\prod_{h=0}^i (1 + r_h) \right) - 1 \right\}$$

Where

EC_i = Additional cost owing to inflation of BC_i for the i th year; and
 r_h = Discrete inflation rate in the h th year, $r_{h=0} = 0$

Equation 3-3: Inflation cost

d) Interest on Debt during the Construction Period: Debt interest accrued at the end of the construction period is calculated as:

³⁹¹ Ranasinghe, M.: Private Sector Participation in Infrastructure Projects- A methodology to analyze viability of BOT. *Construction Management and Economics*, 17(5), 1999, P.613-623.

³⁹² Ranasinghe, M.: Total Project Cost. A Simplified Model for Decision Makers, *Journal of Construction Management and Economics*, Vol.14(6), 1996, P.497-505.

$$IC_i = (1 - \vartheta) \times \{BC_i \times \prod_{h=0}^i (1 + r_h)\} \times \{(1 + r_b)^{CP-i+1} - 1\}$$

Where

- IC_i = Accrued interest on debt for the i th year;
 r_b = Interest rate of debt borrowed;
 ϑ = Equity level

Equation 3-4: Debt interest

e) Gross Revenue: Gross revenue is resultant upon product price, and it is calculated as:

$$REV_j = \{P_j \times \prod_{k=CP}^{j-1} (1 + g_k^P)\} \times \{Q_j \times \prod_{k=0}^{j-1} (1 + g_k^Q)\}$$

Where

- P_j = Unite price of a product (such as tariff/toll) at the start of the j th year;
 P_{j-1} = base price;
 Q_j = Product's demand at the start of the j th year, $Q_{j=0}$ = base demand;
 REV_j = Gross revenue in the j th year;
 g_k^P = Annual growth rate of base price in the k th year; $g_{k=CP}^P = 0$;
 g_k^Q = Annual growth rate of base demand in the k th year; $g_{k=CP}^Q = 0$; and
 j = Index for the operation period, $j = [CP+1, OP]$.

Equation 3-5: Gross revenue

f) Annual Operation and Maintenance Cost: In the original model of Mainul (2008), the operation and maintenance cost are considered as a percentage from the project cost, and it is calculated as in Eq. 3-6:

$$OMC_j = \lambda \times BC \times \left\{ \prod_{k=CP}^{j-1} (1 + g_k^O) \right\} \times \left\{ \prod_{h=0}^{CP+j} (1 + r_h) \right\}$$

Where

- g_k^O = Annual growth rate of operation and maintenance cost in the k th year; $g_k^O = 0$;
 OMC_j = Operation and maintenance cost for the i th year in current-dollar value;
 λ = A fixed percentage of base cost

Equation 3-6: Annual operation and maintenance cost as a percentage

In line with Mercer (2009)³⁹³, our model operation and maintenance costs for the power plants projects will be calculated from their main components which are: staff cost, fuel cost, fixed operation and maintenance cost, variable operation and maintenance cost, Insurance cost. Some of these costs are fixed costs (e.g. wages and salaries, insurance and other fees), while others have fixed and variable components. The variable costs depend on the number of operating hours (e.g. consumable and maintenance materials, repair costs and maintenance services performed by off-site plant staff), as in Eq. 3-7:

$$OMC_j = \{S_j \times \prod_{k=CP}^{j-1}(1 + e_s^0)\} + \{Fu_j \times \prod_{k=CP}^{j-1}(1 + e_{fu}^0)\} + \{FO_j \times \prod_{k=CP}^{j-1}(1 + e_{fo}^0)\} + \{VO_j \times \prod_{k=CP}^{j-1}(1 + e_{vo}^0)\} + \{I_j \times \prod_{k=CP}^{j-1}(1 + e_i^0)\}$$

Where

- e_s^0 = Annual inflation rate of staff cost in the k th year; $g_s^0 = 0$;
- OMC_j = Operation and maintenance cost for the i th year in current-dollar value; and
- e_{fu}^0 = Annual escalation rate of fuel cost in the k th year; $g_{fu}^0 = 0$;
- e_{fo}^0 = Annual escalation rate of fixed operation and maintenance cost in the k th year; $g_{fo}^0 = 0$;
- e_{vo}^0 = Annual escalation rate of variable operation and maintenance cost in the k th year; $g_{vo}^0=0$;
- e_i^0 = Annual escalation rate of Insurance cost in the k th year; $g_i^0 = 0$;
- S_j = Annual staff cost of the j th year per kwh;
- Fu_j = Annual fuel cost of the j th year per kwh;
- FO_j = Annual fixed operation and maintenance cost of the j th year per kwh;
- I_j = Annual insurance cost of the j th year per kwh; and
- VO_j = Annual variable operation and maintenance cost of the j th year per kwh.

Equation 3-7: f) Annual operation and maintenance cost from main components

g) Accumulated Debt: The accumulated debt is calculated as:

$$ADT = \sum_{i=1}^{CP} \{(1 - \vartheta) \times BC_i \times (\prod_{h=0}^i(1 + r_h)) \times (1 + r_b)^{CP-i+1}\}$$

Where

- ADT = Accumulated debt at the end of the construction period.

Equation 3-8: Accumulated debt

h) Debt Repayment: There are several ways to calculate the debt repayment, the most common methods used to compute debt repayment on long-term investments are, the annual equal debt installments method and annual equal principal debt installments method.

³⁹³ Mercer, William: Evaluation of the Outsourcing Decisions for Power Station Operations and Maintenance Services. Athabasca University Centre for Innovative Management MBA Applied Project, 2005.

- **Annual Equal Debt Installments Method:** Annual equal debt installments method is calculated as:

$$ADI_j = ADT \left\{ \frac{r_b \times (1 + r_b)^{LRP}}{(1 + r_b)^{LRP} - 1} \right\}$$

Where

ADI_j = Annual equal debt instalment in the j th year; and
 LRP = Loan repayment period (year).

Equation 3-9: Annual equal debt instalments method

In order to determine the payable debt interest during the debt repayment period, it needs to calculate the debt principal contained in annual equal debt instalments, as in Eq.3-10.

$$DPR_j = ADI_j \left\{ \frac{1}{(1 + r_b)^{LRP-j+1}} \right\} \quad \forall j \in [CP + 1, LRP]$$

Where

DPR_j = Principal of debt to be paid in the j th year.

Equation 3-10: the debt principal in annual equal debt instalments

Therefore, the annual interests contained in annual equal debt instalments in the j th year are calculated as:

$$INT_j = ADI_j \left\{ 1 - \frac{1}{(1 + r_b)^{LRP-j+1}} \right\} \quad \forall j \in [CP + 1, LRP]$$

Where

INT_j = Interest on debt to be paid in the j th year.

Equation 3-11: annual interests contained in annual equal debt instalments

- **Annual Equal Principal Debt Instalments Method:** This method provides for payment of accrued interest on the unpaid balance, plus an equal amount of the principal. As the remaining principal balance declines, the amount of interest accrued also declines. The principal debt of the total payment is calculated as:

$$DPR_j = \left\{ \frac{ADI_j}{LRP} \right\} \quad \forall j \in [CP + 1, LRP]$$

Equation 3-12: Annual equal principal debt instalments method

The annual interests are calculated as:

$$INT_j = r_b \{ADI_j - DPR_j\} \quad \forall j \in [CP + 1, LRP]$$

Equation 3-13: Annual interest in the equal principal debt instalments method

i) Depreciation: Complete depreciation of the total project cost over sponsor operation period is calculated as:

$$DEP_j = \frac{TC}{SOP}$$

Where

DEP_j = Depreciation in the j th year; and

SOP = Sponsor operation period (year).

Equation 3-14: Depreciation

j) Tax: Tax is an expense to sponsors, while it is an income to host governments. This research will consider only the income tax which is calculated as:

$$TAX_j = \max[0, \{r_t \times (REV_j - OMC_j - INT_j - DEP_j)\}]$$

Where

TAX_j = Tax payable to the government in the j th year; and

r_t = Annual tax rate.

Equation 3-15: Tax calculation

k) Profit before Interests and Tax: is calculated as:

$$PBIT_j = (REV_j - OMC_j - DEP_j)$$

Where

$PBIT_j$ = Profit before interests and tax

Equation 3-16: Profit before interests and tax

3.2.5 Cash flows from Different Perspectives of PPP Projects

- a) Annual Net Cash Flows: from sponsors' perspectives during the construction period: is calculated as:

$$D_i^S = \vartheta \times BC_i \times \left(\prod_{h=0}^i (1 + r_h) \right)$$

Where

D_i^S = Cash flow in the j th year from sponsors' perspective

Equation 3-17: Sponsors' annual cash flow during construction

- b) Annual Net Cash Flows Available: to sponsors during the sponsor operation period: is calculated as:

$$NCF_j^S = (REV_j - OMC_j - ADI_j - TAX_j) \quad \forall j \in [CP + 1, SOP]$$

Where

NCF_j^S = Net cash flows available to sponsor in the j th year.

Equation 3-18: Sponsors' annual cash flow during operation period

- c) Annual Net Cash Flows Available: to the government during the government operation period: is calculated as:

$$NCF_j^G = (REV_j - OMC_j) \quad \forall j \in [SOP + 1, OP]$$

Where

NCF_j^G = Net cash flows available to government in the j th year ;

OMC_j = Operating and maintenance cost in the j th year; and

REV_j = Gross revenue in the j th year.

Equation 3-19: Government annual cash flow during government period

3.2.6 Financial Performance Measures

To calculate the financial performance measures (i.e., NPV and IRR) we will employ the techniques of discounted cash flow analysis.

- a) **NPV of Sponsor's Cash Flow:** NPV of sponsor's is calculated as:

$$NPV^S = - \sum_{i=1}^{CP} \left\{ \frac{\vartheta \times (BC_i + EC_i) + IC_{i1}}{(1 + R)^{i-1}} \right\} + \sum_{j=CP+1}^{SOP} \left\{ \frac{NCF_j^S}{(1 + R)^j} \right\}$$

Where

NPV^S = Net present value of sponsor's cash flow; and
 R = Discount rate stipulated by sponsors.

Equation 3-20: NPV of sponsor's cash flow

According to Chen (1998)³⁹⁴, by using the weighted average cost of capital (WACC) discount rate can be calculated as follows:

$$R = ROE^S \times \text{Equity ratio} + \text{Debt interest rate} \times \text{Debt ratio}$$

Where

ROE^S = Return on equity of sponsor's

Equation 3-21: Weighted average cost of capital (WACC) discount rate

b) IRR of Sponsor's Cash Flow: From sponsors' viewpoints, the internal rate of return is the discount rate that makes the net present value of sponsor's cash flow zero, IRR is calculated as:

$$\sum_{i=1}^{CP} \left\{ \frac{\vartheta \times (BC_{i-1} \times \prod_{h=0}^i (1 + r_h)) + IC_{i-1}}{(1 + IRR^S)^{i-1}} \right\} = \sum_{j=CP+1}^{SOP} \left\{ \frac{NCF_j^S}{(1 + IRR^S)^j} \right\}$$

Where

IRR^S = Internal rate of return from sponsors' viewpoints.

Equation 3-22: Internal rate of return

c) Debt Servicing to Lenders: The project's debt-servicing capability to lenders is usually expressed through annual debt-service coverage ratio (DSCR). DSCR is the ratio of the annual cash available (after tax) to annual total debt service.³⁹⁵ A project should have DSCR at least 1.0x to be acceptable; it is regarded as bankable when DSCR is in the range of

³⁹⁴ Chen, T.: Brief Description and Operation of Financial Planning and Modelling. Conference on Private Investment on Transport Construction, Ministry of Transportation and Communication of Taiwan, 1998.

³⁹⁵ Zhang, X.: Paving the Way for Public-Private Partnerships in Infrastructure Development, Journal of Construction Engineering and Management, Vol. 131(1), 2005, P.71-80.

1.10x-1.25x, satisfactory and comfortable when DSCR is between 1.30x and 1.50x and above 1.50x is preferable.³⁹⁶

$$DSCR_j = \left(\frac{REV_j - OMC_j - TAX_j}{ADI_j} \right)$$

Where

$DSCR_j$ = Debt- coverage ratio in the j th year.

Equation 3-23: Debt-service coverage ratio

d) Loan Life Coverage Ratio: LLCR is a ratio of net present value of future income over the debt maturity period against outstanding debt. It is a useful measure for the initial assessment of a project to service debt over the whole term but clearly is not useful if there are likely to be significant cash flow fluctuations from year to year. The minimum initial LLCR requirement is 10% higher than minimum annual DSCR (Previous reference). LLCR is calculated as:

$$LLCR_j = \frac{\sum_{j=k}^{LRP} \left\{ \frac{PBIT_j + DEP_j - TAX_j}{(1+r_b)^{j-k}} \right\}}{\sum_{j=k}^{LRP} \left\{ \frac{ADI_j}{(1+r_b)^{j-k}} \right\}}$$

Where

$LLCR_j$ = Loan life coverage ratio in the j th year.

Equation 3-24: Loan life coverage ratio

e) Project Life Coverage Ratio: PLCR is used to measure the project capacity to service its debt; it is a ratio of net present value of future income over the whole life of the project to outstanding debt. The PLCR measures how much “tail” the project has from cash flows after the loan is re-paid. The minimum initial PLCR requirement is 20% higher than minimum annual DSCR (Previous reference). PLCR is calculated as:

$$PLCR_j = \frac{\sum_{j=k}^{SOP} \left\{ \frac{PBIT_j + DEP_j - TAX_j}{(1+r_b)^{j-k}} \right\}}{\sum_{j=k}^{LRP} \left\{ \frac{ADI_j}{(1+r_b)^{j-k}} \right\}}$$

Where

$PLCR_j$ = Project life coverage ratio in the j th year.

Equation 3-25: Project life coverage ratio

³⁹⁶ Yescombe, E.R.: Public-Private Partnerships – Principles of Policy and Finance, Elsevier Ltd, UK, 2007.

f) **NPV of Government's Cash Flows:** the net present value of government cash flow discounted at the beginning of the construction period is defined in Eq. 3-26:

$$NPV^G = \sum_{l=CP+SOP+1}^{OP} \left\{ \frac{NCF_j^G}{(1+R)^j} \right\}$$

Where

NPV^G = net present value of government's cash flow.

Equation 3-26: net present value of government cash flow

3.2.7 Numerical Example

By 2014, there are about 4 BOT power plant projects in Iraq which form about 24% of all Iraqi electricity production. Due to the difficulties in getting financial data from the working projects, we will apply a financial model. The proposed financial model is going to be applied to a real-life electric power plant project. The project called Al-Quds Gas power plant project (AQPP) is now being constructed in northeast of the capital Baghdad. The project is designed to generate 500 MW with a basic construction cost of 660 Million USD, the total cost is detailed in Table 3 in Million USD. The permanent fuel of power station is natural gas and the back-up fuel is gas-oil (back-up fuel for every power station is used for testing the equipment and turbines and for the emergency cases like repairing gas transformation line).

The power plant uses a binary cycle for combined heat and power production, i.e. it produces both electricity and hot water.

The combined cycle in the combined power plant consist of Topping cycle which produced power (gas turbine cycle) and the heat rejected from this cycle is used in a lower bottoming cycle (steam turbine cycle) which also produced power the main goal of this combination is to achieved increasing in work which produced from the heat addition to the plant (fuel energy) Always the Topping cycle is a gas turbine unit when the temperature reaches more than 1100 C and the Bottoming cycle is a steam turbine unit. The plant will have high efficiency; the power produced will be more over flexibility, fast starting at the partial load and high efficiency for wide loads.

The project is now being implemented on the basis of traditional construction procurement methods, but for the sake of the objectives of this research we will treat the project hypothetically as if it is implemented on BOT basis so as to try study the applicability of BOT projects to the middle and south region of Iraqi's construction market. Table 3-30 display the main data of the project.

Main Data	
Installed capacity	500 MW
Annual energy production	4.249 billion kWh
Design load	4x125 MW
Efficiency	90 %
Construction period	2 Years
Project consultant	Nahrain University/ Consulting Office, Iraq
Civil work contractor	Hyundai Engineering & Construction Co., South Korea
Electromechanical works	General Electric (GE), USA
Tender process	Open competitive
Starting work date	April ,2011
Target completion date	April ,2013
Fuel	Light distillate Oil (LDO) & Natural Gas (NG)

Table 3-30: Main data for AQPP

3.2.8 Basic Assumptions of Iraq

The following are the basic assumptions in applying the financial model on Iraq. For the purpose of validating of the proposed methodology, all parameters and variables used in this model are taken either directly from the Iraqi Ministry of Electricity records (construction cost, duration, etc.), or assumed depending on the indicators of Iraq economy, construction market, and consumer indexes (interest rates, discount rates, etc.). The assumptions are made in light of the extant literature, Iraqi laws and the MoE power purchase agreement. International experience of implementing BOT projects in the developing countries is also regarded.

- Equity/ loan ratio is 30/70 for the base case (case A).
- Base cost is about 660 Million USD, cost details are shown in Table 3-31 below.

Item	Total (Million \$)	1 st-year (Million \$)	2 nd-year (Million \$)
Phasing percentage cost	100%	40%	60%
Civil works	300	120	180
Electromechanical works	150	60	90
Connection to the grid	10	0	10
Design and supervision	10	4	6
Additional cost	20	7	13
Land acquisition (leasing)	170	70	100
Total cost M \$	660	261	399

Table 3-31: Cost requirement of AQPP

- The debt source comes from the long-term loans. It is estimated at 10% in this model with a grace period equal to the design/build period of two years. In this project, the concessionaire is granted a concession period of 25 years, which comes right from the construction period. The operation period 23 years, this period coincides with the concession period.
- Loan repayment period is 10 years starting from the project operation.

- The discount rate used in this model is calculated according to the formula below, and it is 12.4 % for the base case (case A).

Discount rate = Interest rate of long-medium-term loan × Debt percentage + Return on equity × Equity percentage

- Annual operation and maintenance cost are consisting of the flowing costs: staff cost, fuel cost, fixed operation and maintenance cost, variable operation and maintenance cost, Insurance cost.
- Staff cost is to be escalated at a rate of 3.5% per year, while the Insurance cost, variable O&M cost, fixed O& M cost are escalated at a rate of 2.5% per year. See Table 3-32.
- Inflation rate is 2.5% according to Iraq indicators and the Central Bank of Iraq.
- According to the power purchase agreement with the Iraqi MoE base electricity price (Tariff) is not correlated and it is 0.067 USD/kwh for the base case (case A), and the tariff to be reviewed and modified every 4 years..
- Fuel price is not fixed and there is a fuel purchase agreement with the Iraqi MoE to be reviewed and modified every 4 years.
- According to the Iraqi Customs law, No. 23 of 1984, there is a tax rate of 15% of net income.
- According to the Iraqi investment law No. 13, there is a 10 years tax free starting from the project operation time.
- According to the Iraqi investment law No. 13, there is a 10 years tax free on the import equipment and materials that is related to the project.

Item	Cost	Annual inflation rate
Investment cost (Million \$)	660	
Generation (GWH)	3942	0.00%
Construction period (years)	2	
Tariff (\$)	0.067	0.00%
Fuel cost (\$/KWH)	0.03	0.00%
Fixed Operation & Management cost (\$/KWH)	0.0025	2.50%
Variable O&M cost (\$/KWH)	0.0004	2.50%
Insurance cost (\$/KWH)	0.0014	2.50%
Staff cost (\$/KWH)	0.0012	3.50%
Tax rate (%)	15.00%	
Contract period (years)	25	
Tax hold (years)	10	
Return on equity estimated (%)	18.00%	
Discount rate/ Base case (%)	12.40%	
Inflation rate (%)	2.50%	
Loan interest rate (%)	10 %	
Loan repayment period (years)	10	
Grace period (years)	2	

Table 3-32: Costs and investment ratios on different items of AQPP

- According to the power purchase agreement, there is a guarantee of a 100 % power purchase by the Gol.

- Moreover, it is assumed that the power generation is to be escalated at a rate of -1% every four (4) years.
- According to the Iraqi investment law No. 13, the project land will be leased to the project company for the project period.

Furthermore, the concession contract was created between MASS GLOBAL Company and ITB bank, Mass Global was the consortium leader (Project Company) and had received licensed agreement from MoE to finance, construct and operate this power project.

Finally, it should be noted that in times or cases where the economic and business environment is significantly altered from current operating conditions, such assumptions should be revisited in order to assess their validity under these new conditions.

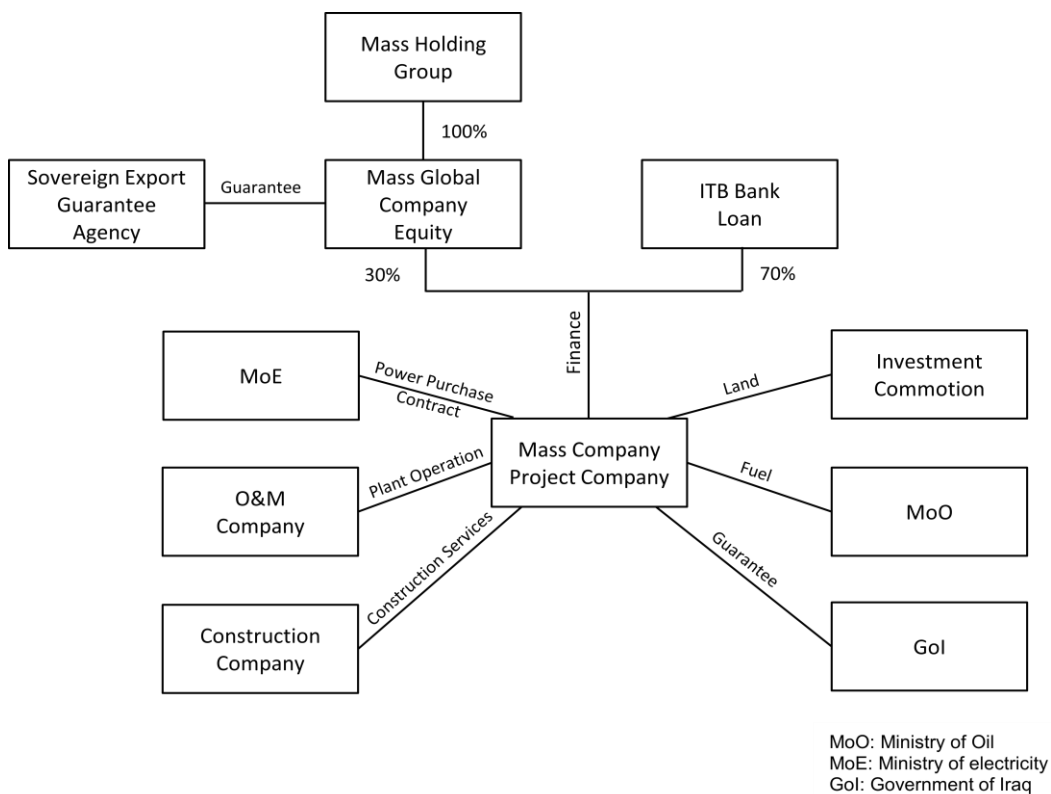

Figure 3-23: Concession structure³⁹⁷

3.2.9 Basic Financial Concepts

Most values in this section are based on the rates of Iraq.

- **Private Capital Structure**

Private capital structure relates to the equity percentage and debt percentage of the concessionaire’s capital.

³⁹⁷ This structure is based on Ministry of Electricity

- **Private Debt Arrangement**

The major debt source comes from the long-medium-term loans, and the corresponding interest rate should be estimated for computation. It is estimated at 10% in this model. In the AQPP project, the grace period is two years. In this project, the concessionaire is granted a concession period of 25 years, which comes right from the construction period. The concessionaire is responsible for the operation and maintenance of the AQPP during the concession period. At the end of the concession period, the AQPP will be transferred to the government. The total design/build period is assumed to be 2 years. The operation period 23 years, this period coincides with the concession period.

- **Income Statement**

The income statement is focused on the revenues and costs from the main business in the operating period. Additionally, the taxes are also taken into account. This statement shows the net income after tax and the effectiveness of management in the operating period. High after-tax net income is favorable.

- **Statement of Equity**

This statement relates much to the stockholders' interest. It also comprises part of the balance sheet.

- **Balance Sheet**

The balance sheet focuses on the assets, liabilities, and equity conditions of a project. The amount of the assets should equal the sum of the liabilities and the equity. If the amounts are not equal, measures should be taken (i.e., taking either more assets or more debts) to balance the sheet.

- **Assets**

Assets include liquid assets and fixed assets. Cash and receivables are considered liquid assets, while fixed assets contain all the construction and engineering costs mentioned before, minus depreciation.

- **Liabilities**

Liabilities include liquid liabilities and long-term liabilities. Liquid liabilities have two components: loans and payables.

- **Equity**

Equity refers to the retained earnings and the equity.

- **Statement of Cash Flow**

This statement deals with all cash inflows and cash outflows throughout the project. Cash flows in three different kinds of activities are calculated. The three different activities are the business activity, the investment activity, and the financing activity. The purpose of this statement is to know the cash requirement and/or surplus at each different point in time. If the cash on hand is not enough, some financing measures are needed to meet the financial needs.

- **Business Activity Cash Flows**

The operating revenues are the positive items in this group. Negative items here are the operating/maintenance costs, the interest costs, and the business income tax. The sum of all the items is the net cash inflow in the business activity.

- **Investment Activity Cash Flows**

The investment activity includes almost all cash outflows. They are the construction costs and the financing costs (the capitalized interest) in the construction period. Again, the net cash flow can be acquired by adding all of these items together.

- **Financing Activity Cash Flows**

The financing activity net cash flows can be obtained by adding the long term loans, the short-term loans, and the equity, then subtracting the issued dividends.

3.2.10 Model Results and Scenario Analysis

Financial statements for the project are projected in the model. Model inputs and calculations are used to generate an income statement, a balance sheet and a cash flow statement. Financial ratios that are relevant for investment projects are calculated from the financial statements. These ratios are: return on investment (ROI), return on equity (ROE), internal rate of return (IRR), debt service coverage ratio (DSCR), Project life coverage ratio (PLCR), and loan life coverage ratio (LLCR).

Moreover, Six representative scenarios have been demonstrated, most of those cases were taken from the Iraqi Ministry of electricity. The purpose of the scenario analysis is to find the relationship between the change of parameters and the result of evaluation. Case A is the base scenario and all other scenarios are slightly changed based on Case A (variables are kept constant, but parameters are slightly changed).

3.2.10.1 Case A

Case A is the base case of the financial modeling. The other five cases are slightly different from Case A in either the parameters (debt/equity ratio) or the way of paying debt. The input data are based on the taxes and rates of Iraq. In this case, fuel is assumed to be bought from the Iraqi government under an agreement. The cash flow showing corresponding costs and benefits are depicted in Table 3-33.

From the sponsors' point view, the concessionaire can take back the amount of equity invested in the construction period in the year 9. In case A, the debt coverage ratio (DCR), loan life coverage ratio (LLCR), and project life coverage ratio (PLCR) are all acceptable (see earlier definitions of these ratios), where (DCR min of 1.26) is higher than 1.0. The minimum initial (LLCR of 1.55) and (PLCR of 3.19) are respectively 10% and 20% higher than minimum annual (DCR min).³⁹⁸ Moreover, project statutory liquidity ratio (SLR of 1.18), time interest earned (TIE of 5.37) are respectively over 1.0 and 2.0. Case A data are represented in Figures 3-24 to 3-30.

³⁹⁸ Yescombe, E.R.: Public-Private Partnerships – Principles of Policy and Finance, Elsevier Ltd, UK, 2007.

3.2.10.2 Case B

In this case the debt/equity ratio is changed from 70/30 to 75/25. Due to the decrease in equity and the fact that the return on equity ROE (18%) is greater than the debt interest rate (10%), the discount rate is decreased from 12.4% to 12%. As a result, the decrease in discount rate makes the net present value larger, from 54.68 in case A to 61.43.

In case B, DCR min of 1.17 is acceptable, higher than 1.0. (LLCR of 1.17) is fall below the minimum requirement of 10 % higher than (DCR min). This would indicate to the senior lenders that the project financing plan is reasonably robust to support the level of funding anticipated, the project may needs to increase the loan repayment period. (PLCR of 2.80) are acceptable, 20% higher than (DCR min). From the sponsors' point view, the concessionaire can take back the amount of equity invested in the construction period after the year 9. Moreover, project statutory liquidity ratio (SLR of 1.17), time interest earned (TIE of 5.0) are respectively over 1.0 and 2.0. Table 3-34 shows cash flow from viewpoint of equity.

3.2.10.3 Case C

For case C the debt/equity ratio is changed from 70/30 to 80/20. As in case B, this results in decrease the discount rate from 12.4% to 11.6%. Moreover, the Net Present Value (NPV) with the discount rate of 11.6% of case C 67.85, is higher than the NPV of case A 54.68, but it is not represent the optimal capital structure in this case. The concessionaire, from the sponsors' point view, can take back the amount of equity invested in the construction period in the year 10.

In case C, DCR min of 1.10 is acceptable, higher than 1.0. (LLCR of 0.84) is fall below the minimum requirement of 10 % higher than (DCR min). This would indicate to the senior lenders a default under the loan agreement. (PLCR of 2.46) are acceptable, 20% higher than (DCSR min). Moreover, project statutory liquidity ratio (SLR of 1.15), time interest earned (TIE of 4.67) are respectively over 1.0 and 2.0. Table 3-35 shows cash flow from viewpoint of equity.

For the cases A, B and C, debt coverage ratio (DCR) is an ascending function of equity. As equity decreases, debt obligations increase, hence DCR decreases. Thus, a high DCR requirement by lenders results in high equity in the project.

3.2.10.4 Case D

High fuel price is assumed in case D, where the fuel price is increasing by 30% from the base case price. In case D, (DCR min of 0.92), (SLR of 1.09), (TIE of 4.15), (LLCR of 0.64), and (PLCR of 1.25) are the lowest values among all cases. The Net Present Value (NPV) with the discount rate of 12.4% of case D is negative, which refer that the project does not yield any profits and the project should be rejected. Table 3-36 shows cash flow from viewpoint of equity.

3.2.10.5 Case E

In case E, international fuel price is assumed. The fuel price is increasing by 10% from the base case price. This decreases the net present value from 54.68 to 53.36. Although, increase the payback period from the sponsors' point view from 8 years to 9 years. In case E, DCR, LLCR, and PLCR are all acceptable, where DCSR min of 1.25, higher than 1.0. (LLCR of 1.54) and (PLCR of 3.17) are respectively 10% and 20% higher than minimum annual (DCR min).³⁹⁹

³⁹⁹ Yescombe, E.R.: Public-Private Partnerships – Principles of Policy and Finance, Elsevier Ltd, UK, 2007.

Moreover, project statutory liquidity ratio (SLR of 1.17), time interest earned (TIE of 5.34) are respectively over 1.0 and 2.0. Table 3-37 shows cash flow from viewpoint of equity.

3.2.10.6 Case F

For case F, the period of paying debt (including both the principal and interest) is extending from 10 years to 15 years. Moreover, the Net Present Value (NPV) with the discount rate of 12.4% of case F 68.97, which is higher than the NPV of case A 54.68. Due to this change in case F, DCR, LLCR and PLCR, are the higher among all other cases, where (DCR min of 1.56) higher than 1.0. (LLCR 2.96) and (PLCR of 4.15) requirement are 10% and 20% respectively higher than minimum annual (DCR min) (previous reference). Moreover, project statutory liquidity ratio (SLR of 1.14), time interest earned (TIE of 3.46) are respectively over 1.0 and 2.0.

This can be explained as follows: the extend of the period of paying debt makes large amount of the debt paid at later points in times and devaluates the cost of the payment. Thus, the concessionaire has more net income available in the first few years of the operating period. This explains why the debt coverage ratio (DCR) in case F is higher than in case A. Moreover, the payback periods are calculated from the viewpoint of equity is 6 years. Table 3-38 shows cash flow from viewpoint of equity.

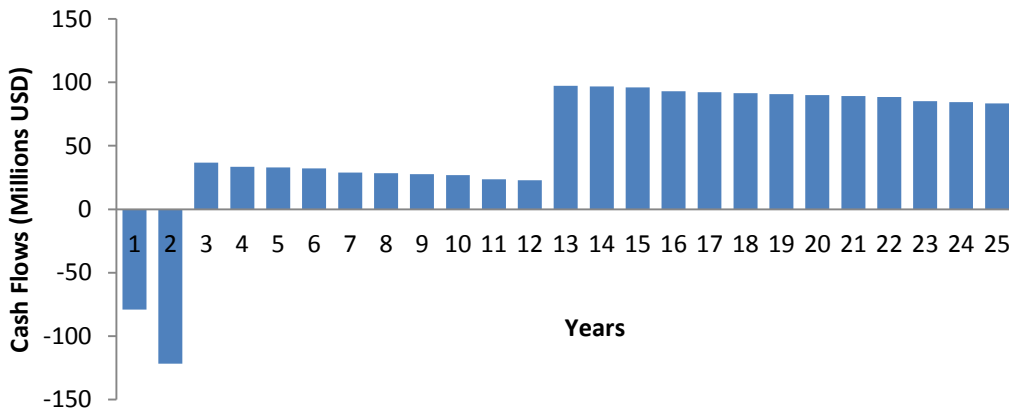

Figure 3-24: Equity cash flow - Case A

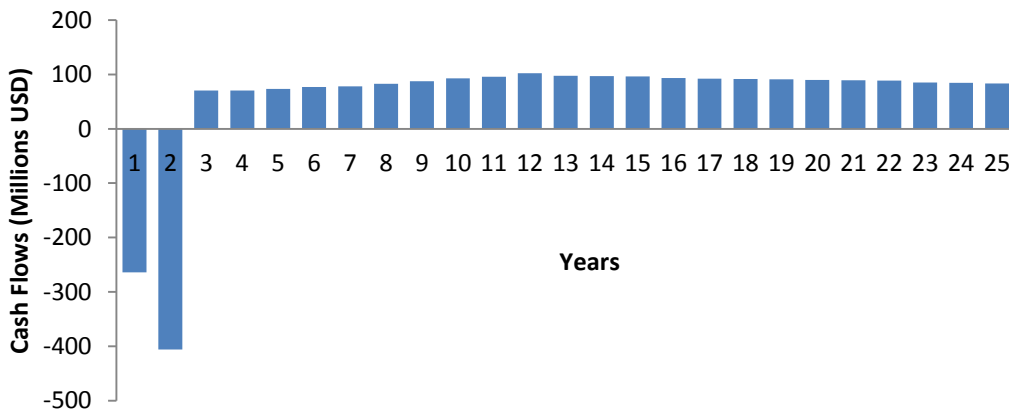

Figure 3-25: Project cash flow - Case A

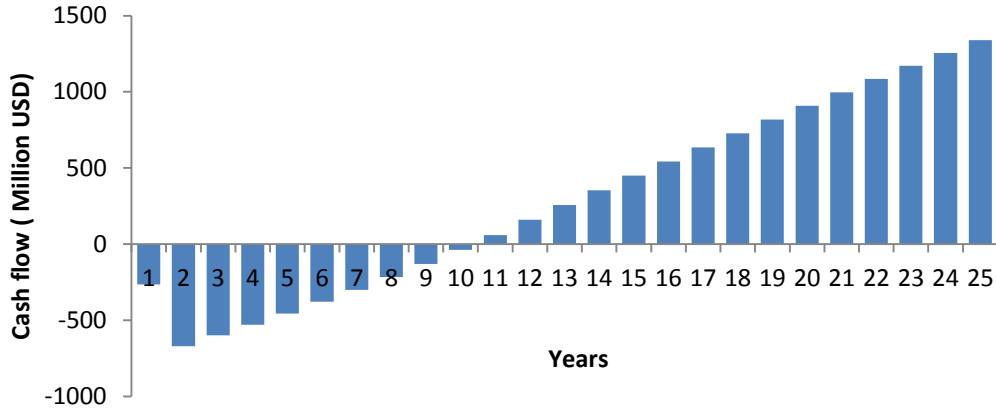

Figure 3-26: Project cumulative cash flow - Case A

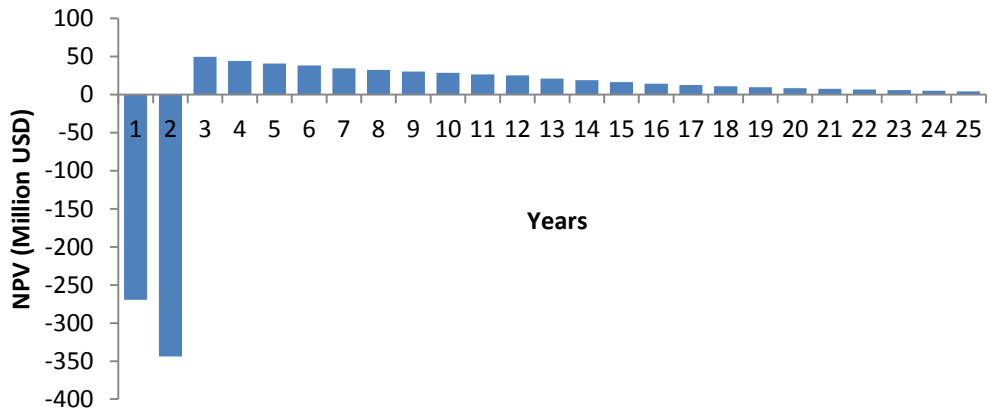

Figure 3-27: Project net present value (NPV) - Case A

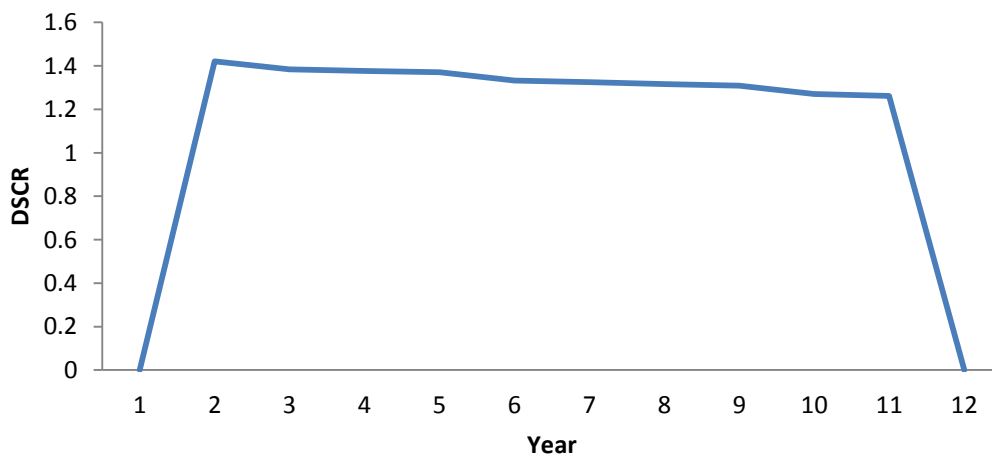
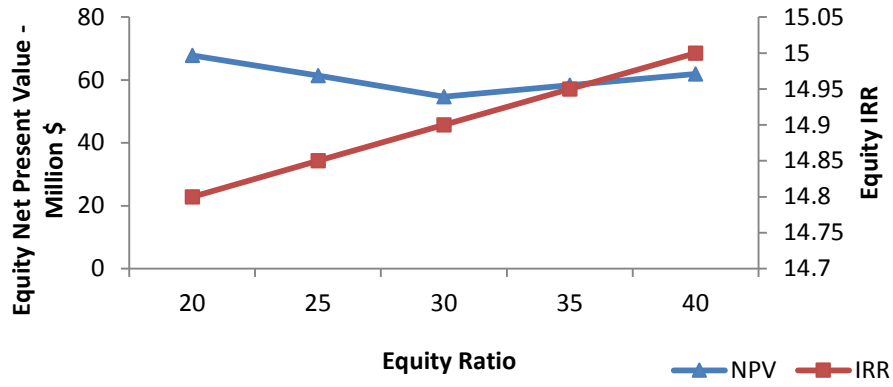
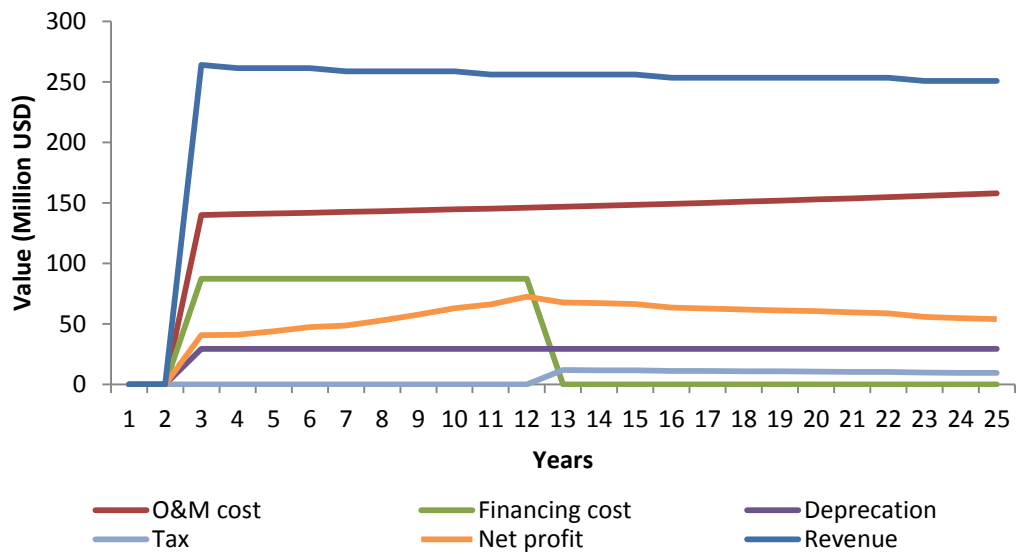

Figure 3-28: Project debt servicing coverage ratio (DSCR)



3-29: Relation between equity, IRR and NPV



(A)

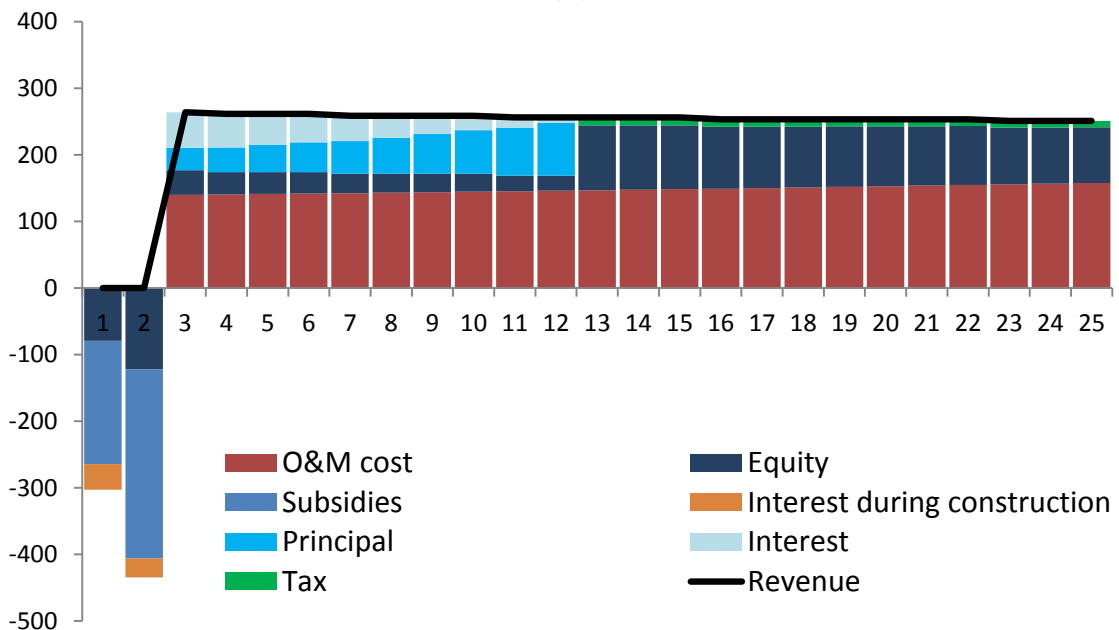

(B)

Figure 3-30: Project financing structure

YEAR	Equity	Gross revenue (REV)	O & M cost (OMC)	Deprecation (DEP)	Profit before interest & tax	Debt interest (INT)	Profit before tax	Tax	Net profit	Deprecation (DEP)	Cash flow	Debt principal (DPR)	Debt repayment (ADI)	Available Cash flow
1	79.2	0.000	0.000	0.000	0.000	0.000	0.000	0.000	0.000	0.000	0.000	0.000	0.000	0.000
2	121.77	0.000	0.000	0.000	0.000	0.000	0.000	0.000	0.000	0.000	0.000	0.000	0.000	0.000
3	0.000	264.114	140.107	29.4848	94.523	53.615	40.907	0.000	40.907	29.4848	70.392	33.6410	87.256	36.751
4	0.000	261.47286	140.702	29.4848	91.286	50.251	41.035	0.000	41.035	29.4848	70.520	37.0051	87.256	33.515
5	0.000	261.47286	141.313	29.4848	90.675	46.550	44.124	0.000	44.124	29.4848	73.609	40.7056	87.256	32.903
6	0.000	261.47286	141.942	29.4848	90.046	42.480	47.566	0.000	47.566	29.4848	77.051	44.7762	87.256	32.275
7	0.000	258.83172	142.589	29.4848	86.758	38.002	48.756	0.000	48.756	29.4848	78.241	49.2538	87.256	28.987
8	0.000	258.83172	143.253	29.4848	86.094	33.077	53.017	0.000	53.017	29.4848	82.502	54.1792	87.256	28.323
9	0.000	258.83172	143.936	29.4848	85.411	27.659	57.752	0.000	57.752	29.4848	87.237	59.5971	87.256	27.640
10	0.000	258.83172	144.638	29.4848	84.709	21.699	63.010	0.000	63.010	29.4848	92.494	65.5568	87.256	26.938
11	0.000	256.19058	145.360	29.4848	81.346	15.144	66.202	0.000	66.202	29.4848	95.687	72.1125	87.256	23.575
12	0.000	256.19058	146.102	29.4848	80.604	7.932	72.672	0.000	72.672	29.4848	102.157	79.3237	87.256	22.833
13	0.000	256.19058	146.864	29.4848	79.841	0.000	79.841	11.9762	67.865	29.4848	97.350	0.000	0.000	97.350
14	0.000	256.19058	147.649	29.4848	79.057	0.000	79.057	11.8586	67.199	29.4848	96.683	0.000	0.000	96.683
15	0.000	256.19058	148.455	29.4848	78.251	0.000	78.251	11.7376	66.513	29.4848	95.998	0.000	0.000	95.998
16	0.000	253.54944	149.284	29.4848	74.781	0.000	74.781	11.2171	63.564	29.4848	93.049	0.000	0.000	93.049
17	0.000	253.54944	150.136	29.4848	73.929	0.000	73.929	11.0893	62.839	29.4848	92.324	0.000	0.000	92.324
18	0.000	253.54944	151.012	29.4848	73.053	0.000	73.053	10.9579	62.095	29.4848	91.580	0.000	0.000	91.580
19	0.000	253.54944	151.913	29.4848	72.152	0.000	72.152	10.8228	61.329	29.4848	90.814	0.000	0.000	90.814
20	0.000	253.54944	152.839	29.4848	71.226	0.000	71.226	10.6838	60.542	29.4848	90.027	0.000	0.000	90.027
21	0.000	253.54944	153.791	29.4848	70.273	0.000	70.273	10.5410	59.732	29.4848	89.217	0.000	0.000	89.217
22	0.000	253.54944	154.771	29.4848	69.294	0.000	69.294	10.3941	58.900	29.4848	88.385	0.000	0.000	88.385
23	0.000	250.9083	155.777	29.4848	65.646	0.000	65.646	9.8469	55.799	29.4848	85.284	0.000	0.000	85.284
24	0.000	250.9083	156.813	29.4848	64.611	0.000	64.611	9.6916	54.919	29.4848	84.404	0.000	0.000	84.404
25	0.000	250.9083	157.877	29.4848	63.546	0.000	63.546	9.5319	54.014	29.4848	83.499	0.000	0.000	83.499

Table 3-33: Cash flow concept in Million USD -viewpoint of equity Case A

YEAR	Equity	Gross revenue (REV)	O & M cost (OMC)	Deprecation (DEP)	Profit before interest & tax	Debt interest (INT)	Profit before tax	Tax	Net profit	Deprecation (DEP)	Cash flow	Debt principal (DPR)	Debt repayment (ADI)	Available Cash flow
1	66	0.000	0.000	0.000	0.000	0.000	0.000	0.000	0.000	0.000	0.000	0.000	0.000	0.000
2	101.475	0.000	0.000	0.000	0.000	0.000	0.000	0.000	0.000	0.000	0.000	0.000	0.000	0.000
3	0.000	264.114	140.107	29.6769	94.331	57.445	36.886	0.000	36.886	29.6769	66.563	36.0439	93.489	30.519
4	0.000	261.473	140.702	29.6769	91.094	53.840	37.254	0.000	37.254	29.6769	66.931	39.6483	93.489	27.282
5	0.000	261.473	141.313	29.6769	90.483	49.876	40.607	0.000	40.607	29.6769	70.284	43.6132	93.489	26.671
6	0.000	261.473	141.942	29.6769	89.854	45.514	44.340	0.000	44.340	29.6769	74.016	47.9745	93.489	26.042
7	0.000	258.832	142.589	29.6769	86.566	40.717	45.850	0.000	45.850	29.6769	75.526	52.7719	93.489	22.755
8	0.000	258.832	143.253	29.6769	85.902	35.440	50.462	0.000	50.462	29.6769	80.139	58.0491	93.489	22.090
9	0.000	258.832	143.936	29.6769	85.219	29.635	55.584	0.000	55.584	29.6769	85.261	63.8540	93.489	21.407
10	0.000	258.832	144.638	29.6769	84.517	23.249	61.268	0.000	61.268	29.6769	90.944	70.2394	93.489	20.705
11	0.000	256.191	145.360	29.6769	81.154	16.225	64.929	0.000	64.929	29.6769	94.606	77.2634	93.489	17.342
12	0.000	256.191	146.102	29.6769	80.412	8.499	71.913	0.000	71.913	29.6769	101.590	84.9897	93.489	16.600
13	0.000	256.191	146.864	29.6769	79.649	0.000	79.649	11.9474	67.702	29.6769	97.379	0.000	0.000	97.379
14	0.000	256.191	147.649	29.6769	78.865	0.000	78.865	11.8298	67.035	29.6769	96.712	0.000	0.000	96.712
15	0.000	256.191	148.455	29.6769	78.059	0.000	78.059	11.7088	66.350	29.6769	96.027	0.000	0.000	96.027
16	0.000	253.549	149.284	29.6769	74.589	0.000	74.589	11.1883	63.401	29.6769	93.077	0.000	0.000	93.077
17	0.000	253.549	150.136	29.6769	73.737	0.000	73.737	11.0605	62.676	29.6769	92.353	0.000	0.000	92.353
18	0.000	253.549	151.012	29.6769	72.861	0.000	72.861	10.9291	61.931	29.6769	91.608	0.000	0.000	91.608
19	0.000	253.549	151.913	29.6769	71.960	0.000	71.960	10.7940	61.166	29.6769	90.843	0.000	0.000	90.843
20	0.000	253.549	152.839	29.6769	71.034	0.000	71.034	10.6550	60.379	29.6769	90.055	0.000	0.000	90.055
21	0.000	253.549	153.791	29.6769	70.081	0.000	70.081	10.5122	59.569	29.6769	89.246	0.000	0.000	89.246
22	0.000	253.549	154.771	29.6769	69.102	0.000	69.102	10.3653	58.737	29.6769	88.414	0.000	0.000	88.414
23	0.000	250.908	155.777	29.6769	65.454	0.000	65.454	9.8181	55.636	29.6769	85.313	0.000	0.000	85.313
24	0.000	250.908	156.813	29.6769	64.419	0.000	64.419	9.6628	54.756	29.6769	84.433	0.000	0.000	84.433
25	0.000	250.908	157.877	29.6769	63.354	0.000	63.354	9.5031	53.851	29.6769	83.528	0.000	0.000	83.528

Table 3-34: Cash flow concept in Million USD-viewpoint of equity Case B

YEAR	Equity	Gross revenue (REV)	O & M cost (OMC)	Deprecation (DEP)	Profit before interest & tax	Debt interest (INT)	Profit before tax	Tax	Net profit	Deprecation (DEP)	Cash flow	Debt principal (DPR)	Debt repayment (ADI)	Available Cash flow
1	52.8	0.000	0.000	0.000	0.000	0.000	0.000	0.000	0.000	0.000	0.000	0.000	0.000	0.000
2	81.18	0.000	0.000	0.000	0.000	0.000	0.000	0.000	0.000	0.000	0.000	0.000	0.000	0.000
3	0.000	264.114	140.107	29.8690	94.138	61.274	32.864	0.000	32.864	29.8690	62.733	38.4469	99.721	24.286
4	0.000	261.473	140.702	29.8690	90.902	57.430	33.472	0.000	33.472	29.8690	63.341	42.2916	99.721	21.050
5	0.000	261.473	141.313	29.8690	90.290	53.201	37.090	0.000	37.090	29.8690	66.959	46.5207	99.721	20.438
6	0.000	261.473	141.942	29.8690	89.662	48.548	41.113	0.000	41.113	29.8690	70.982	51.1728	99.721	19.809
7	0.000	258.832	142.589	29.8690	86.374	43.431	42.943	0.000	42.943	29.8690	72.812	56.2901	99.721	16.522
8	0.000	258.832	143.253	29.8690	85.710	37.802	47.908	0.000	47.908	29.8690	77.777	61.9191	99.721	15.858
9	0.000	258.832	143.936	29.8690	85.027	31.610	53.417	0.000	53.417	29.8690	83.286	68.1110	99.721	15.175
10	0.000	258.832	144.638	29.8690	84.325	24.799	59.526	0.000	59.526	29.8690	89.395	74.9221	99.721	14.472
11	0.000	256.191	145.360	29.8690	80.962	17.307	63.655	0.000	63.655	29.8690	93.524	82.4143	99.721	11.110
12	0.000	256.191	146.102	29.8690	80.220	9.066	71.154	0.000	71.154	29.8690	101.023	90.6557	99.721	10.368
13	0.000	256.191	146.864	29.8690	79.457	0.000	79.457	11.9186	67.539	29.8690	97.408	0.000	0.000	97.408
14	0.000	256.191	147.649	29.8690	78.673	0.000	78.673	11.8010	66.872	29.8690	96.741	0.000	0.000	96.741
15	0.000	256.191	148.455	29.8690	77.867	0.000	77.867	11.6800	66.187	29.8690	96.056	0.000	0.000	96.056
16	0.000	253.549	149.284	29.8690	74.397	0.000	74.397	11.1595	63.237	29.8690	93.106	0.000	0.000	93.106
17	0.000	253.549	150.136	29.8690	73.545	0.000	73.545	11.0317	62.513	29.8690	92.382	0.000	0.000	92.382
18	0.000	253.549	151.012	29.8690	72.669	0.000	72.669	10.9003	61.768	29.8690	91.637	0.000	0.000	91.637
19	0.000	253.549	151.913	29.8690	71.768	0.000	71.768	10.7652	61.003	29.8690	90.871	0.000	0.000	90.871
20	0.000	253.549	152.839	29.8690	70.841	0.000	70.841	10.6262	60.215	29.8690	90.084	0.000	0.000	90.084
21	0.000	253.549	153.791	29.8690	69.889	0.000	69.889	10.4834	59.406	29.8690	89.275	0.000	0.000	89.275
22	0.000	253.549	154.771	29.8690	68.910	0.000	68.910	10.3365	58.573	29.8690	88.442	0.000	0.000	88.442
23	0.000	250.908	155.777	29.8690	65.262	0.000	65.262	9.7893	55.473	29.8690	85.342	0.000	0.000	85.342
24	0.000	250.908	156.813	29.8690	64.227	0.000	64.227	9.6340	54.593	29.8690	84.461	0.000	0.000	84.461
25	0.000	250.908	157.877	29.8690	63.162	0.000	63.162	9.4743	53.688	29.8690	83.557	0.000	0.000	83.557

Table 3-35: Cash flow concept in Million USD-viewpoint of equity Case C

YEAR	Equity	Gross revenue (REV)	O & M cost (OMC)	Deprecation (DEP)	Profit before interest & tax	Debt interest (INT)	Profit before tax	Tax	Net profit	Deprecation (DEP)	Cash flow	Debt principal (DPR)	Debt repayment (ADI)	Available Cash flow
1	79.2	0.000	0.000	0.000	0.000	0.000	0.000	0.000	0.000	0.000	0.000	0.000	0.000	0.000
2	121.77	0.000	0.000	0.000	0.000	0.000	0.000	0.000	0.000	0.000	0.000	0.000	0.000	0.000
3	0.000	275.940	169.672	29.4848	76.784	53.615	23.168	0.000	23.168	29.4848	52.653	33.6410	87.256	19.012
4	0.000	273.181	170.267	29.4848	73.429	50.251	23.178	0.000	23.178	29.4848	52.663	37.0051	87.256	15.658
5	0.000	273.181	170.878	29.4848	72.817	46.550	26.267	0.000	26.267	29.4848	55.752	40.7056	87.256	15.046
6	0.000	273.181	171.507	29.4848	72.189	42.480	29.709	0.000	29.709	29.4848	59.193	44.7762	87.256	14.417
7	0.000	270.421	172.154	29.4848	68.783	38.002	30.781	0.000	30.781	29.4848	60.265	49.2538	87.256	11.012
8	0.000	270.421	172.818	29.4848	68.118	33.077	35.042	0.000	35.042	29.4848	64.526	54.1792	87.256	10.347
9	0.000	270.421	173.501	29.4848	67.435	27.659	39.776	0.000	39.776	29.4848	69.261	59.5971	87.256	9.664
10	0.000	270.421	174.203	29.4848	66.733	21.699	45.034	0.000	45.034	29.4848	74.519	65.5568	87.256	8.962
11	0.000	267.662	174.925	29.4848	63.252	15.144	48.109	0.000	48.109	29.4848	77.593	72.1125	87.256	5.481
12	0.000	267.662	175.667	29.4848	62.510	7.932	54.578	0.000	54.578	29.4848	84.063	79.3237	87.256	4.739
13	0.000	267.662	176.429	29.4848	61.748	0.000	61.748	9.2621	52.485	29.4848	81.970	0.000	0.000	81.970
14	0.000	267.662	177.214	29.4848	60.963	0.000	60.963	9.1445	51.819	29.4848	81.304	0.000	0.000	81.304
15	0.000	267.662	178.020	29.4848	60.157	0.000	60.157	9.0236	51.134	29.4848	80.618	0.000	0.000	80.618
16	0.000	264.902	178.849	29.4848	56.569	0.000	56.569	8.4853	48.084	29.4848	77.568	0.000	0.000	77.568
17	0.000	264.902	179.701	29.4848	55.717	0.000	55.717	8.3575	47.359	29.4848	76.844	0.000	0.000	76.844
18	0.000	264.902	180.577	29.4848	54.841	0.000	54.841	8.2261	46.615	29.4848	76.099	0.000	0.000	76.099
19	0.000	264.902	181.478	29.4848	53.940	0.000	53.940	8.0910	45.849	29.4848	75.334	0.000	0.000	75.334
20	0.000	264.902	182.404	29.4848	53.014	0.000	53.014	7.9520	45.062	29.4848	74.546	0.000	0.000	74.546
21	0.000	264.902	183.356	29.4848	52.061	0.000	52.061	7.8092	44.252	29.4848	73.737	0.000	0.000	73.737
22	0.000	264.902	184.336	29.4848	51.082	0.000	51.082	7.6623	43.420	29.4848	72.905	0.000	0.000	72.905
23	0.000	262.143	185.342	29.4848	47.316	0.000	47.316	7.0974	40.218	29.4848	69.703	0.000	0.000	69.703
24	0.000	262.143	186.378	29.4848	46.280	0.000	46.280	6.9421	39.338	29.4848	68.823	0.000	0.000	68.823
25	0.000	262.143	187.442	29.4848	45.216	0.000	45.216	6.7824	38.433	29.4848	67.918	0.000	0.000	67.918

Table 3-36: Cash flow concept in Million USD-viewpoint of equity Case D

YEAR	Equity	Gross revenue (REV)	O & M cost (OMC)	Deprecation (DEP)	Profit before interest & tax	Debt interest (INT)	Profit before tax	Tax	Net profit	Deprecation (DEP)	Cash flow	Debt principal (DPR)	Debt repayment (ADI)	Available Cash flow
1	79.2	0.000	0.000	0.000	0.000	0.000	0.000	0.000	0.000	0.000	0.000	0.000	0.000	0.000
2	121.77	0.000	0.000	0.000	0.000	0.000	0.000	0.000	0.000	0.000	0.000	0.000	0.000	0.000
3	0.000	275.940	151.933	29.4848	94.523	53.615	40.907	0.000	40.907	29.4848	70.392	33.6410	87.256	36.751
4	0.000	273.181	152.528	29.4848	91.168	50.251	40.917	0.000	40.917	29.4848	70.402	37.0051	87.256	33.397
5	0.000	273.181	153.139	29.4848	90.556	46.550	44.006	0.000	44.006	29.4848	73.491	40.7056	87.256	32.785
6	0.000	273.181	153.768	29.4848	89.928	42.480	47.448	0.000	47.448	29.4848	76.932	44.7762	87.256	32.156
7	0.000	270.421	154.415	29.4848	86.522	38.002	48.520	0.000	48.520	29.4848	78.004	49.2538	87.256	28.751
8	0.000	270.421	155.079	29.4848	85.857	33.077	52.781	0.000	52.781	29.4848	82.265	54.1792	87.256	28.086
9	0.000	270.421	155.762	29.4848	85.174	27.659	57.515	0.000	57.515	29.4848	87.000	59.5971	87.256	27.403
10	0.000	270.421	156.464	29.4848	84.472	21.699	62.773	0.000	62.773	29.4848	92.258	65.5568	87.256	26.701
11	0.000	267.662	157.186	29.4848	80.991	15.144	65.848	0.000	65.848	29.4848	95.332	72.1125	87.256	23.220
12	0.000	267.662	157.928	29.4848	80.249	7.932	72.317	0.000	72.317	29.4848	101.802	79.3237	87.256	22.478
13	0.000	267.662	158.690	29.4848	79.487	0.000	79.487	11.9230	67.564	29.4848	97.048	0.000	0.000	97.048
14	0.000	267.662	159.475	29.4848	78.702	0.000	78.702	11.8054	66.897	29.4848	96.382	0.000	0.000	96.382
15	0.000	267.662	160.281	29.4848	77.896	0.000	77.896	11.6844	66.212	29.4848	95.697	0.000	0.000	95.697
16	0.000	264.902	161.110	29.4848	74.308	0.000	74.308	11.1462	63.162	29.4848	92.647	0.000	0.000	92.647
17	0.000	264.902	161.962	29.4848	73.456	0.000	73.456	11.0184	62.437	29.4848	91.922	0.000	0.000	91.922
18	0.000	264.902	162.838	29.4848	72.580	0.000	72.580	10.8869	61.693	29.4848	91.177	0.000	0.000	91.177
19	0.000	264.902	163.739	29.4848	71.679	0.000	71.679	10.7518	60.927	29.4848	90.412	0.000	0.000	90.412
20	0.000	264.902	164.665	29.4848	70.753	0.000	70.753	10.6129	60.140	29.4848	89.625	0.000	0.000	89.625
21	0.000	264.902	165.617	29.4848	69.800	0.000	69.800	10.4700	59.330	29.4848	88.815	0.000	0.000	88.815
22	0.000	264.902	166.597	29.4848	68.821	0.000	68.821	10.3231	58.498	29.4848	87.983	0.000	0.000	87.983
23	0.000	262.143	167.603	29.4848	65.055	0.000	65.055	9.7582	55.296	29.4848	84.781	0.000	0.000	84.781
24	0.000	262.143	168.639	29.4848	64.019	0.000	64.019	9.6029	54.416	29.4848	83.901	0.000	0.000	83.901
25	0.000	262.143	169.703	29.4848	62.955	0.000	62.955	9.4432	53.511	29.4848	82.996	0.000	0.000	82.996

Table 3-37: Cash flow concept in Million USD-viewpoint of equity Case E

YEAR	Equity	Gross revenue (REV)	O & M cost (OMC)	Deprecation (DEP)	Profit before interest & tax	Debt interest (INT)	Profit before tax	Tax	Net profit	Deprecation (DEP)	Cash flow	Debt principal (DPR)	Debt repayment (ADI)	Available Cash flow
1	79.2	0.000	0.000	0.000	0.000	0.000	0.000	0.000	0.000	0.000	0.000	0.000	0.000	0.000
2	121.77	0.000	0.000	0.000	0.000	0.000	0.000	0.000	0.000	0.000	0.000	0.000	0.000	0.000
3	0.000	264.114	140.107	29.4848	94.523	53.615	40.907	0.000	40.907	29.4848	70.392	16.8747	70.490	53.518
4	0.000	261.473	140.702	29.4848	91.286	51.928	39.359	0.000	39.359	29.4848	68.844	18.5622	70.490	50.281
5	0.000	261.473	141.313	29.4848	90.675	50.071	40.603	0.000	40.603	29.4848	70.088	20.4184	70.490	49.670
6	0.000	261.473	141.942	29.4848	90.046	48.030	42.016	0.000	42.016	29.4848	71.501	22.4602	70.490	49.041
7	0.000	258.832	142.589	29.4848	86.758	45.784	40.975	0.000	40.975	29.4848	70.460	24.7062	70.490	45.753
8	0.000	258.832	143.253	29.4848	86.094	43.313	42.781	0.000	42.781	29.4848	72.266	27.1769	70.490	45.089
9	0.000	258.832	143.936	29.4848	85.411	40.595	44.816	0.000	44.816	29.4848	74.301	29.8946	70.490	44.406
10	0.000	258.832	144.638	29.4848	84.709	37.606	47.103	0.000	47.103	29.4848	76.588	32.8840	70.490	43.704
11	0.000	256.191	145.360	29.4848	81.346	34.317	47.029	0.000	47.029	29.4848	76.513	36.1724	70.490	40.341
12	0.000	256.191	146.102	29.4848	80.604	30.700	49.904	0.000	49.904	29.4848	79.389	39.7897	70.490	39.599
13	0.000	256.191	146.864	29.4848	79.841	26.721	53.120	7.9680	53.120	29.4848	82.605	43.769	70.490	38.836
14	0.000	256.191	147.649	29.4848	79.057	22.344	56.713	8.5069	56.713	29.4848	86.198	48.145	70.490	38.052
15	0.000	256.191	148.455	29.4848	78.251	17.530	60.721	9.1082	60.721	29.4848	90.206	52.960	70.490	37.246
16	0.000	253.549	149.284	29.4848	74.781	12.234	62.547	9.3821	62.547	29.4848	92.032	58.256	70.490	33.776
17	0.000	253.549	150.136	29.4848	73.929	6.408	67.521	10.1281	67.521	29.4848	97.005	64.082	70.490	32.924
18	0.000	253.549	151.012	29.4848	73.053	0.000	73.053	10.9579	73.053	29.4848	102.537	0.000	0.000	102.537
19	0.000	253.549	151.913	29.4848	72.152	0.000	72.152	10.8228	72.152	29.4848	101.637	0.000	0.000	101.637
20	0.000	253.549	152.839	29.4848	71.226	0.000	71.226	10.6838	71.226	29.4848	100.710	0.000	0.000	100.710
21	0.000	253.549	153.791	29.4848	70.273	0.000	70.273	10.5410	70.273	29.4848	99.758	0.000	0.000	99.758
22	0.000	253.549	154.771	29.4848	69.294	0.000	69.294	10.3941	69.294	29.4848	98.779	0.000	0.000	98.779
23	0.000	250.908	155.777	29.4848	65.646	0.000	65.646	9.8469	65.646	29.4848	95.131	0.000	0.000	95.131
24	0.000	250.908	156.813	29.4848	64.611	0.000	64.611	9.6916	64.611	29.4848	94.095	0.000	0.000	94.095
25	0.000	250.908	157.877	29.4848	63.546	0.000	63.546	9.5319	63.546	29.4848	93.031	0.000	0.000	93.031

Table 3-38: Cash flow concept in Million USD-viewpoint of equity Case F

3.2.11 Summary Results

Several graphs and charts were illustrated in the previous section. Revenue and expense breakdown is illustrated, as well as the cash flows of the project. Financial ratios are also shown graphically, which can be useful when analyzing how the financials of the project change throughout the lifetime of the project. However, The parameters and results of the all cases are summarized in Table 3-39.

Item	Case A	Case B	Case C	Case D	Case E	Case F
	Base Case	Sub.	Sub.	High fuel price	International fuel price	E. Debt period
Input data						
Debt / Equity ratio	70/30	75/25	80/20	70/30	70/30	70/30
Debt Interest rate	10%	10%	10%	10%	10%	10%
Grace period (year)	2	2	2	2	2	2
Debt repayment period	10	10	10	10	10	15
Return on equity	18	18	18	18	18	18
Discount rate	12.40	12	11.6	12.4	12.4	12.4
Concession period (year)	25	25	25	25	25	25
Fuel price \$/kwh	0.03	0.03	0.03	0.0375	0.033	0.03
Business income tax	15 %	15 %	15 %	15 %	15 %	15 %
Tax holiday (year)	10	10	10	10	10	10
Results						
Debt coverage ratio (DCR)	1.26 ~ 1.42	1.17 ~ 1.32	1.1 ~ 1.24	1.05 ~ 1.21	1.25 ~ 1.42	1.56 ~ 1.76
Internal rate of return (IRR)	14.90	14.85	14.80	~	14.85	20.20
Payback period (view of equity)	9	9	10	~	8	6
Net present value (NPV)	54.68	61.43	67.85	- 48.05	53.36	68.97
Statutory liquidity ratio (SLR) > 1	1.18	1.17	1.15	1.09	1.17	1.14
Time interest earned (TIE) >2	5.37	5.00	4.67	4.15	5.34	3.46
Loan life coverage ratio (LLCR) >1	1.55	1.17	0.84	0.64	1.54	2.96
Project life coverage ratio (PLCR) >1	3.19	2.80	2.46	2	3.17	4.15

Table 3-39: Summary table of parameters and results

The above result summary is designed to be handed out to potential investors, lenders and other related parties to give them a compact overview of the project. The assumptions that the assessment is based on are listed in the summary, along with the results from the profitability calculations, i.e. NPV, IRR and MIRR for both project and equity.

The main project important factor to the equity holders are the net present value of equity cash flow (NPV) and internal rate of return on equity (IRR). For the lenders to the project, a project is bankable if the project revenues are sufficient to service the future debt. The project metric that captures this lenders' concern is the DCR, LLCR and PLCR.

In this context, the results of the analysis indicate that all the cases; except case D; are acceptable as the value of DCR in each case is greater than 1.0. And in case that the project company could extend the period of paying debt for 15 years, case F can be chosen as the best alternative that has relatively grater DCR, LLCR, PLCR, IRR and NPV. Apart from this, case A (base case) is the next best alternative that has grater DCR, LLCR and PLCR (See Table 3-39).

The financial model is used to summarizing a complex set of technical and economic factors into easy input of parameters and variables, the financial model that developed for evaluation for the BOT, can come up with useful financial reports and graphs to help users know more about the result of the scenario according to the input data. With different scenarios analysis, the concessionaire or the government can easily find out a better scenario with merely a little change in parameters or variables.

4 Methodology for Data Collection

4.1 Introduction

This chapter analyzes the methodology which was employed by the researcher in collecting data for the study. As many methods of collecting data are used worldwide such as case study, questionnaire, interview, focus group interview, observation, critical incident and portfolio, and due to the non-availability of organized information related to the PPP projects and their management in Iraq, the questionnaire survey with face to face interview techniques are chosen based on their workability and the availability of time in data collection.

This research project involved PPP project participants in both the private and public sectors spanning major groups such as Public Officials in Ministries, Departments and Agencies, Researchers, Project Managers/Consultants/Contractors and Operators of Special Purpose Vehicles for PPPs. This chapter commences with the rationale for the research method, design and procedures, including the population, sample, and instruments.

4.2 Questionnaire Survey

In general, the questionnaire investigates the present trend of Iraq's PPP, the real understanding of construction players on PPP in Iraq; evaluate industry perceptions of Iraq's current experience in managing PPP projects, and indicate main risk factors in Iraq PPP.

Various studies aiming at obtaining responses from the intended population have successfully achieved their objectives via questionnaire survey which encourage this study to use questionnaire survey as the method of data collection. These studies include Zhang (2006)⁴⁰⁰ who defines the public best value perspectives of public-private partnerships in infrastructure development via questionnaire survey, Chen and Chen (2007)⁴⁰¹ who undertake the prioritization of critical success factors (CSFs) in partnering arrangement to minimize construction conflicts via questionnaire survey as well as Yuan, *et al* (2012)⁴⁰² who forecast the key performance indicators for PPP via questionnaire survey.

The survey was done between April 2014 and August 2014. To ensure that the survey was free from bias the questionnaires were given to management staff in all echelons of the organizational structure of the public and private sectors.

The collected data assimilate both qualitative and quantitative data where the questions are developed in qualitative nature whilst the answers by the respondents are in the form of qualitative for instance suggestion as well as quantitative as outlined in numeric form for example "1 = strongly

⁴⁰⁰ Zhang, X. : Public Clients' Best Value Perspectives of Public-Private Partnerships in Infrastructure Development. *Journal of Construction Engineering and Management*, Vol.132 (2), 2006, P.107-114.

⁴⁰¹ Chen, W.T. and Chen, T.T.: Critical success factors for construction partnering in Taiwan. *International Journal of Project Management*, Vol. 25(5),2007, P. 475–84.

⁴⁰² Yuan, J., Wang, C., Skibniewski, M., and Li, Q. : Developing Key Performance Indicators for Public-Private Partnership Projects: Questionnaire Survey and Analysis." *Journal of Management in Engineering*. Vol.28 (3), 2012, P.252-264.

disagreed". Yet, as the nature of data collection, validity, reliability and analysis are predominantly formed in numbers, this data is considered as quantitative.

4.2.1 Questionnaire Objectives and Structure

The objectives of this questionnaire outline the division of this questionnaire which is divided into six parts:

<u>Section No.</u>	<u>Title</u>
Section 1	General questions about respondents
Section 2	General experience with PPP
Section 3	Criteria and performance of PPP in Iraq
Section 4	Major risk factors in Iraq PPP infrastructure projects
Section 5	Prospects for public-private partnership in infrastructure projects in Iraq

As their titles imply, the objectives of those parts are as the following:

<u>Section No.</u>	<u>Objectives</u>
Section 1	Obtain the respondents particular
Section 2	Evaluate, the present trend and information, experience, involvement and preparedness level for PPP in Iraq,
Section 3	To assess how does decision-makers comparing PPP with traditional methods, the current legal framework of PPP, the main reasons for adopting PPP projects in Iraq, whether PPP is the right choice, and which type of project is the best suited to use PPP.
Section 4	To assess the importance of several major risks associated with Iraq's PPP projects and their allocation.
Section 5	Examine whether or not Iraq has been suitable to promote PPP especially in the infrastructure sector in a general sense and the future of the PPP implementation.

The questionnaire survey based on the preliminary literature review of this study , books, articles, journals, proceeding papers, working papers, websites,...etc in developing the questions and designing the answers, as well as the types of the questionnaire suited with the aim of this study. Questions designed in sections 2,3 and 4 are in line with literature review in Chapter 2: Basics of Public Private Partnership.⁴⁰³ Nevertheless, questions given to the respondent are highly structured in providing sufficient time for the respondents to answer the questions.

In terms of the preparation of the questionnaire form, the title selected for this questionnaire is “Developing Iraq Infrastructure: Using Public-Private Partnership”.

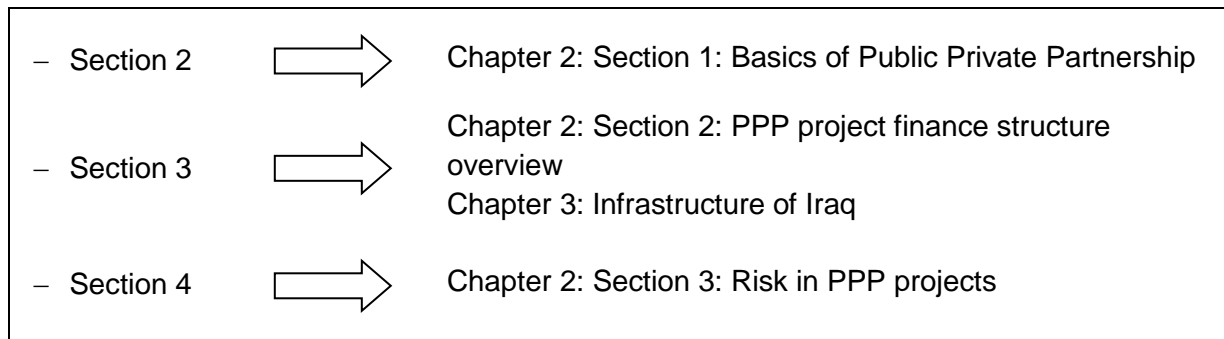

Figure 4-1: Questionnaire sections relation with chapters

Likert scaling is a scaling method. It is the most widely used approach to scaling responses in survey research, measuring either positive or negative response to a statement. It is normally with odd points (midpoint) or with even points. Sometimes an even-point scale is used, where the middle option of "Neither agree nor disagree" is not available. This is sometimes called a "forced choice" method; in a mid-point Likert scale each respondent may have a different interpretation of the mid-point even when it is labeled. In a recent study⁴⁰⁴ it was shown that possible interpretations of the mid-point can be: Do not know, Unsure, No opinion, Neither, Neutral, Both equal parts of agree and disagree, Undecided, Not applicable, or Unwilling to answer. As it is obviously from this long list, the mid-point can be confusing to respondents which may introduce measurement error, which is when a survey question is ambiguous or unclear.

In Likert scale, some people do not like taking extreme choices as this may make them appear as if they are totally sure when they realize that there are always valid opposing views to many questions. They may also prefer to be thought of as moderate rather than extremist. They thus are much less likely to choose the extreme options.

In line with the above context, this research will use even-point Likert scale (without midpoint), accompanied with not applicable/do not know (N/A) option, and an equal number of positive and negative statements; this will obviate the problem of acquiescence and central tendency bias, since

⁴⁰³ The scopes of questions are indicated in Appendix B.

⁴⁰⁴ Raaijmakers, Q. A. W., Hoof, A. v., Hart, H. t., Verbogt, T. F. M. A., & Wollebergh, W., A. M.: Adolescents' Midpoint Response on Likert-Tyep Scale Items-Neutral or missing values?. International Journal of Public Opinion Research, Vol. 12(2), 2000, P. 208-216.

acquiescence on positively keyed items will balance acquiescence on negatively keyed items. Moreover, some researchers argue that sometimes there are things asked that the respondent legitimately lacks the knowledge about it. The further the topic is from the immediate experience of the respondent, the more plausible that some respondents would have inadequate knowledge or sufficient familiarity to have formed an opinion about the topic.⁴⁰⁵ Since the N/A doesn't fit into the ordering, this would result in a two-part analysis - one where people decide if they can give an answer on the scale (or give N/A) and the other one is where people who do give an answer on the scale then decide which one to give.

Furthermore, questions and answers are outlined as simple as possible given that the subject matter of the questionnaire is in fact quite complex. Respondents are required to write information and mark in appropriate boxes of multiple choice questions as following:

1. Respondent's Particular: each respondent is to be asked to select the most appropriate option that expresses his profile.
2. General Experience with PPP: with given answers options, respondents are asked to express their experience in PPP projects.
3. Criteria and performance of PPP in Iraq, the respondents need to select the most appropriate number of a Likert scale from "1 = Strongly disagreed" to "6 = Strongly agreed; 0= Do not know/not applicable".
4. Major Risk Factors in Iraq PPP Infrastructure Projects, the respondents need to select the most appropriate number of a Likert scale from "1 = Least important" to "6 = Most important; 0= Do not know/ not applicable".
5. Prospects for Public-Private Partnership in Infrastructure Projects in Iraq: the respondents need to select the most appropriate number of a Likert scale from "1 = Strongly disagreed" to "6 = Strongly agreed; 0= Do not know/ not applicable".

The questionnaire form is written in two copies English and Arabic language and distributed directly to the respondents to provide the opportunities for both respondent and researcher to know each other in fostering the relationship network within the construction industry players for future research undertaking. Figure 4-2 shows the questionnaire structure.

⁴⁰⁵ Douglas Ducharme: Survey Response Categories: Guide for Using Neutral or N/A Options. War Gaming Department, United State Naval College, 2014.

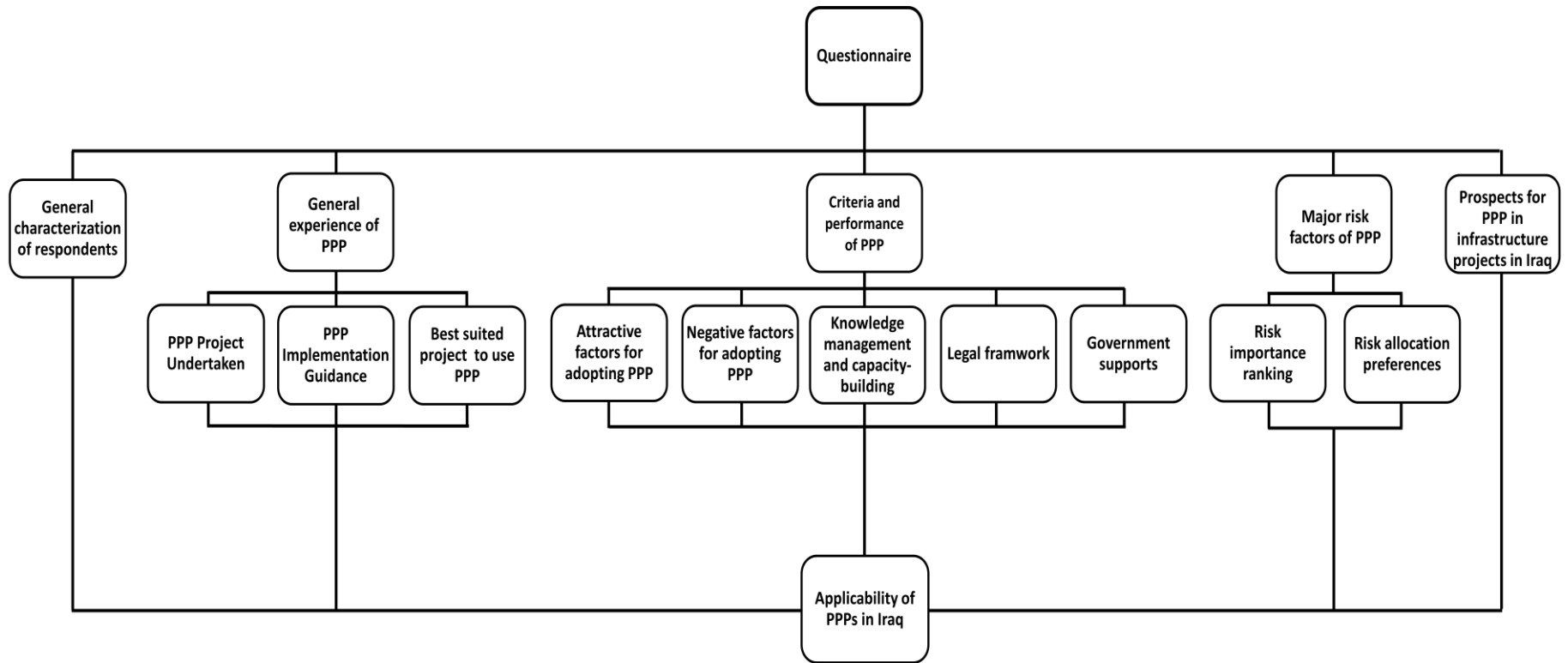

Figure 4-2: Questionnaire structure

4.2.2 Questionnaire Types

As for the types of questionnaire, closed questionnaire is useful to obtain factual information namely age, academic degree, qualification...etc. Despite selecting the most appropriate answer, the respondent is also given an alternative of answering more than one if applicable. On the other hand, open questionnaire is a part of closed questionnaire where the respondent can specify other answers in the “Others” category as not all possible response is included in the answers list.

As previously discussed, the questionnaire is divided into five parts where it is not necessary for all respondents to answer every part. All sections are compulsory to be answered by all respondents, except section 4 which is designed for respondents who involved directly in PPP project. For those who have not directly practiced PPP, they are only required to answer other sections.

4.2.3 Questionnaire Test

Pilot questionnaire survey is conducted prior to the distribution of survey to test the feasibility of intended questionnaire to be undertaken, as well as to perfect the questionnaire concepts and wording.⁴⁰⁶ Pilot questionnaire survey ensures the reliability and workability of the questions, choices of answers, offers feedback on whether the questions are interpreted in the same way for respondents, whether the response categories mean the same thing to everyone as well as the format in the questionnaire survey by questioning a small group of respondents before the actual questionnaire survey is conducted.

A pilot survey was conducted on 26 respondents at the (PWG) Project Working Group Conference 2014: “Improving the business and investment climate in Iraq - policy dialogue and capacity building for key factors” on 19 – 21 April 2014 at The NIC National Investment Commission - Baghdad.

A reliability analysis was conducted to test the internal consistency of the survey variable data using the Cronbach’s alpha method based on internal consistency.⁴⁰⁷ Despite the data reliability, Cronbach’s alpha method is also vital for internal validity in correctly interpreting the relationships between variables.⁴⁰⁸ Based on standard coefficient of Cronbach’s alpha, the maximum value of reliability coefficient is 1.00 where for the output with reliability coefficient of less than 0.6; the questionnaire in data collection is considered as not reliable and thus should be corrected or eliminated from the data collection. The statistic can be defined as below:⁴⁰⁹

$$\text{Cronbach's alpha, } \alpha = \frac{K}{K-1} \left(1 - \frac{\sum_{i=1}^K \sigma^2_{Y_i}}{\sigma^2_X} \right)$$

Where:

K = Number of factors

σ^2_X = Variance of the total scores for the respondents

⁴⁰⁶ Scheuren, F.: What is a Survey? Booklet. United States of America-American Statistical Association (ASA), 2004.

⁴⁰⁷ Mohamed Barakat: Statistical Analysis Using the SPSS Program. Islamic University, Department of Economics and Applied Statistics, Gaza, Palestine, 2007.

⁴⁰⁸ Punch, K. F.: Introduction to Social Research: Quantitative and Qualitative Approaches. 2nd Edition. London: SAGE Publications Ltd, 2005.

⁴⁰⁹ Develles, R.F.: Scale Development. Sage Publications, 1991, P. 24- 33.

$\sigma^2_{Y_i}$ = Variance of component i for the respondents

Equation 4-1: Cronbach's alpha

Furthermore, Table 4-1 below demonstrates the range of coefficient of Cronbach's alpha and its reliability level.

Coefficient of Cronbach's alpha	Reliability level
1.00	Very high
0.80 – 0.99	High
0.60 - .079	Moderate
Less than 0.59	Low

Table 4-1: Rang of reliability and its coefficient for Cronbach's alpha⁴¹⁰

Via the pilot survey, it is found that the questionnaire coefficient of Cronbach's alpha is 0.874 as shown in Table 4-2, which is considered as reliable for the data collection. As the data reliability and internal validity have been ensured, the succeeding step is to defining the population and sampling.

Cronbach's Alpha	Cronbach's Alpha Based on Standardized Items	N of Items
0.874	0.870	177

Table 4-2: Survey coefficient for Cronbach's alpha

4.2.4 Sample Selection

The respondents have to meet three criteria before being invited to participate in the survey, which include (1) having extensive working experience within the construction industry of Iraq infrastructure projects, (2) having been involved in the management of PPP projects in Iraq or have gained in-depth knowledge in the area of PPP, and (3) experience in conducting PPP research or have followed very closely with the development of PPP projects.

The populations considered to be defined for the analysis as follows:

⁴¹⁰ Previous reference.

- The population of the "Public sector" includes all persons in the decision making level of the public agencies that responsible of infrastructure projects in Iraq.
- The population of the "Private sector" includes all persons in the industrial practitioners who have been involved in PPP projects in Iraq.
- The population of the "Academic researchers" includes all persons who have been involved in the research of PPP projects in Iraq.

It was anticipated that some of these target respondents would have colleagues and personal connections knowledgeable in the area of PPP to participate in this research study as well; hence some of the respondents were dispatched four blank copies of the survey form.

The survey respondents were first presented with the purpose of the questionnaire, some background information, instructions for the exercise, and the process for implementing PPP projects in Iraq. At the end of the exercise, the respondents were asked to rate their extent of satisfaction for each part of the survey.

There were certain challenges that the researcher encountered in the administration of the questionnaires. Among the problems encountered was the misplacement of questionnaires by some respondents. New ones had to be given out to replace the misplaced ones. Some of the respondents were demanding some incentives before responding to the questionnaires. In such a situation the researcher had to convince them that the study was only an academic exercise.

Concerning respondents of public sector, respondents were sampled from Iraqi public agencies that are responsible for planning, developing and implementing infrastructure projects in Iraq, which are: Ministry of Planning (MoP), National Investment Commission (NIC), Iraqi Railways Company (IRC), General Authority of Roads & Bridges (GARB), General Authority of Sewage (GAS); General Authority of Water supply (GAWS), and Ministry of Electricity (MoI). In addition, some respondents were also sampled from Baghdad Municipality, Ministry of industrial (MoI).

Whilst, respondents of private sector were sampled from the local and international companies doing PPP projects in Iraq, or interested in developing PPP projects in Iraq. Contact information of these companies was given to the researcher by the public agencies. Moreover, based on the assumption that most companies are now represented on the internet or other media, numerous internet searches in relevant search engines⁴¹¹ were done.

Academic researchers' respondents were sampled from the Iraqi universities and institutes which are: Baghdad University/Faculty of Engineering, Mustansiriyah University/Faculty of Engineering, Alnahrain University/Faculty of Engineering-, University of Technology/Faculty of Engineering-, Basra University/Faculty of Business and Economics. In addition, some respondents were also sampled from Institute of Urban Planning, Department of Public contracts, and Iraqi Institute for Economic Reform (IIER).

4.2.5 Questionnaire Distribution Methods

The used method of distributing and collecting the questionnaire encompasses is via hand. Nevertheless, because of geographic constraints many were done by electronic mail distribution through a written online survey with as-necessary follow-up telephone calls to the respondent.

⁴¹¹ Search engines used: Google (www.google.de), Yahoo (www.yahoo.com).

These methods of questionnaire distribution provide direct access to the respondent to ensure that the respondents comprehend the requirements of the questionnaire as well as demonstrate the researcher's endeavor in individually approaching the respondents. Direct approach is important in enhancing the respondent's interest of answering the detailed questionnaire.

Each potential respondent received a cover letter and a copy of the questionnaire. The cover letter explained the purpose of the study and assured the confidentiality of answers given by respondents.

History proves that questionnaire usually produces low response rate. In avoiding this, phone calls and sequential visits are conducted to the respondents after the questionnaire submission. Phone calls correspondence were used only when the response to the questionnaire was behind scheduled due dates, or when the respondents contacted the researchers with questions or requests for further information.

4.3 Interviews

In addition to gathering the information via the data from books, articles, journals, working papers, websites in developing the questions and designing the answers, informal face-to face interview is also carried out, despite requiring the respondent to write the answer. As in line with carefully worded interview, the questions of this interview are sourced from the content of questionnaire.

The interview is selected as there are many questions needing short answers to be ticked off in the questionnaire survey that is also suitable to be questioned via interview. For the particular cases, the interview is carried out on a personal one-to-one basis if the respondent is time deficient, cannot understand questions because of either it is written completely in English, words used are highly technical or sentences used are confusing; or in rare situation lazy to read through questions. The poor proficiency of comprehending English is usually faced by member of the public and end-user who are not exposed to the English-spoken environment due to their nature of work. Besides, interview demonstrates a serious approach by the researcher in obtaining accurate information where the researcher is in control and available in assisting if there is any problem or misunderstanding. Thus, interview completes the questionnaire survey where this mode of collecting data is proven to be less time consuming, yet it is dependent on the cooperation given by the respondents. The suggestion from those parties is attained within this study.

This informal interview involved PhD supervisors, other academician from Baghdad University, and construction player directly involved in PPP in materialized for the purpose of internal validity of the research to ensure that the internal logic and consistency of the research to which the relations between variables are correctly interpreted.⁴¹²

⁴¹² Punch, K. F.: Introduction to Social Research-Quantitative and Qualitative Approaches. 2nd Edition. London: SAGE Publications Ltd, 2005.

4.4 Frequency Analysis

Frequency analysis measures the data central tendency and the data dispersion around this tendency. Frequency analysis describes multiple choice data of “1 = Completely disagree” to “6 = Completely agree”. It records the number of scores within each response category. Various measures are used in this frequency analysis of which include:

$$\text{Mean, } \bar{x} = \frac{\sum_{i=1}^n (f_i x_i)}{n}, \quad (1 \leq \bar{x} \leq 6)$$

Where:

- x_i = Score given to each variable by the respondents
- f = Frequency of response; and
- n = Total number of responses concerning that variable.

Equation 4-2: Mean of sample

$$\begin{aligned} \text{Median, } M_e &= x_{(n+1)/2}, && \text{if } n \text{ is odd} \\ \text{Median, } M_e &= x_{n/2} + x_{(n/2+1)}, && \text{if } n \text{ is even.} \end{aligned}$$

Equation 4-3: Median of sample

$$\text{Variance, } s^2 = \frac{\sum_{i=1}^n (x_i - \bar{x})^2}{n - 1}$$

$$\text{Standard deviation, } s = \sqrt{\left[\frac{\sum_{i=1}^n (x_i - \bar{x})^2}{n - 1} \right]}$$

Equation 4-4: Variance and standard deviation of sample

4.5 Statistical Tool for Data Reliability

The data analysis in this study is being used in the Statistical Package of Social Science (SPSS), as SPSS is presently the most reliable in data processing and graphical output presentation. Five statistical tools are used: General descriptive statistic; Normality test; Kendall's Coefficient of Concordance; Kruskal Wallis H test; Mann-Whitney U test; Effect size index and Center of Mass.

4.5.1 General Descriptive Statistics

General descriptive statistics summarize the numerical data to the interpretable output: mean standard deviation, minimum, maximum, range, sum and standard error of the mean.

4.5.2 Normality Test

Normality test is used to determine if a data set is well-modeled by a normal distribution and to compute how likely it is for a random variable underlying the data set to be normally distributed. An assessment of the normality of data is a prerequisite for many statistical tests because normal data is an underlying assumption in parametric testing. This can be done via the following approaches:

- Review the distribution graphically (via histograms, box plots, QQ plots).
- Analyze the skewness and kurtosis.
- Employ statistical tests (esp. Chi-square, Kolmogorov-Smirnov, Shapiro-Wilk... etc.).

If data is normally distributed, it can be expected to follow a certain pattern in which the data tend to be around a central value with no bias left or right (Figure 4-3). Non-normal data, on the other hand, does not tend toward a central value. It can be skewed left or right or follow no particular pattern.

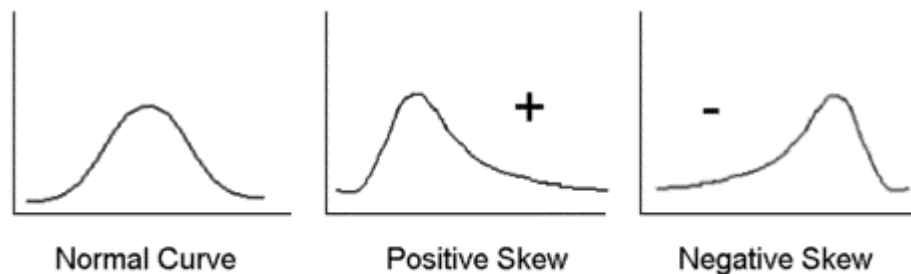

Figure 4-3: Normal distribution and distribution Skew

The null hypothesis is that “sample distribution is normal.” If the test is significant at a predefined allowable significance level of, such as $\alpha=0.05$, the distribution is non-normal. Moreover, this research will depend on Kolmogorov-Smirnov (K-S) test for normality assessment. The Kolmogorov-Smirnov test statistic D_n is defined by:

$$df = n - 1$$

$$F_n(x) = \frac{1}{n} \sum_{i=1}^n I_{X_i \leq x}$$

$$D_n = \sup_x |F_n(x) - F(x)|$$

Where:

- df = Degree of freedom, which is number of values in calculation of statistic that are independent to vary;⁴¹³
- n = Sample size;
- $I_{X_i \leq x}$ = Indicator function, equal to 1 if $X_i \leq x$ and equal to 0 otherwise; and
- $F(x)$ = Cumulative distribution function.

Equation 4-5: Kolmogorov-Smirnov (K-S) test

The hypothesis regarding the normal distributional is accepted if the critical value $D_{n,\alpha}$; obtained from the Kolmogorov-Smirnov table; is greater than the critical D_n . Otherwise, the hypothesis is rejected. With this line, in SPSS calculations $D_{n,\alpha}$ is simplified into p-value, which is labelled as "Asymp. Sig." In the SPSS output.⁴¹⁴

The p-value, in contrast to fixed α values, is calculated based on the test statistic, and denotes the threshold value of the significance level in the sense that the null hypothesis (H_0) will be accepted for all values of α less than the p-value. For example, if $p=0.025$, the null hypothesis will be accepted at all significance levels less than p (i.e. 0.01 and 0.02), and rejected at higher levels, including 0.05 and 0.1. The p-value can be useful, in particular, when the null hypothesis is rejected at all predefined significance levels, and you need to know at which level it could be accepted.⁴¹⁵

However, the p-value presented is (almost always) for a two-tailed test. a two-tailed test allots half of your alpha to testing the statistical significance in one direction and half of your alpha to testing statistical significance in the other direction. This means if alpha equal to 0.05, that 0.025 is in each tail of the distribution of the test statistic. When using a two-tailed test, regardless of the direction of the relationship of hypothesize, it is testing for the possibility of the relationship in both directions.

4.5.3 Kendall's Coefficient of Concordance (W)

Kendall's Coefficient of Concordance is a non-parametric statistic. It is used to measure the agreement of different respondents on their rankings of factors based on mean values within a particular group. Kendall's W ranges from 0 (no agreement) to 1 (complete agreement). If the Kendall's coefficient of concordance (W) is significant at a predefined allowable significance level of, such as 0.05, a reasonable degree of consensus amongst the respondents within the group on the rankings of factors was indicated. W can be calculated by the following formula:⁴¹⁶

$$W = \frac{\sum_{i=1}^n (\bar{R}_i - \bar{R})^2}{n(n^2 - 1)/12}$$

⁴¹³ For more information, See (Toothaker & Miller, 1996).

⁴¹⁴ See Appendix C.

⁴¹⁵ For excellent discussion, See (Berenson *et al.* 2009), P. 222.

⁴¹⁶ Siegel, S. and Castellan, N. J.: Nonparametric Statistics for the Behavioral Sciences. McGraw-Hill Inc, 1988.

Where:

- n = Number of factors being ranked;
 \bar{R}_i = Average of the ranks assigned to the i th factor; and
 \bar{R} = Average of the ranks assigned across all factors.

Equation 4-6: Kendall's coefficient of concordance (W)

According to Siegel and Castellan (1988),⁴¹⁷ W is only suitable when the number of attributes is less than or equal to 7. If the number of attributes is greater than 7, Chi-square is used as a near approximation instead. The critical value of Chi-square is obtained by referring to the table of critical values of Chi-square distribution, which can be found in Siegel and Castellan (1988).

4.5.4 Kruskal Wallis H Test

Kruskal Wallis H test is a rank-based non-parametric equivalent of the the one-way analysis of variance (ANOVA). This test used to compare medians between two or more groups that may have different sample sizes as shown in Eq. 4-7.

The first step is to rank all of the scores, ignoring which group they belong to. The lowest score gets the lowest rank. If two or more scores are the same then they are "tied". "Tied" scores get the average of the ranks that they would have obtained, had they not been tied. After that calculate the sum of the ranks for each group, then the test statistic, H.

The statistic H of the test is then compared to a table of critical values based on the sample size of each group.⁴¹⁸ It is used to test the null hypothesis that all populations have identical distribution functions against the alternative hypothesis that at least two of the samples differ only with respect to location (median), if at all. Moreover, the test does not identify where this stochastic dominance occurs or for how many pairs of groups stochastic dominance obtains, it only tells you that at least two groups were different. Using post hoc test would help analyze the specific sample pairs for stochastic dominance. Three assumptions that are required for a Kruskal-Wallis H test to give valid results which are:

- The dependent variable should be measured at the ordinal or continuous level (i.e., interval or ratio).
- The cases represent random samples from the populations, and the scores on the test variable are independent of each other.
- The continuous distributions for the test variable are exactly the same (except their medians) for the different populations.

$$df = n - 1$$

⁴¹⁷ Previous reference.

⁴¹⁸ For more details, See (Berenson *et al.* 2009).

$$H = \left[\frac{12}{N(N+1)} \times \sum \frac{T_c^2}{n_c} \right] - 3 \times (N+1)$$

Where:

- df = Degree of freedom
 N = Total number of participants (all groups combined),
 T_c = The rank total for each group,
 n_c = Size of each group.

Equation 4-7: Kruskal Wallis H Test for independent samples

As the sample sizes in each group get large (i.e., at least 5), H is equal to chi-square distributed, meaning that the probability of getting a particular value of H is the p-value corresponding to a chi-square; with (n-1) degrees of freedom (df).⁴¹⁹

4.5.5 Mann-Whitney U Test

Mann-Whitney U test is a non-parametric equivalent of the independent samples t-test which analyses unequal size of scores of sample. It used when the data do not meet the requirements for a parametric test (i.e. if the data are not normally distributed; if the variances for the two conditions are markedly different; or if the data are measurements on an ordinal scale). Moreover, The Mann-Whitney U-test can examine the level of agreement between stakeholders in the rating of the significances of the performance objectives to determine whether the mean significance of each objective is equal between the groups.⁴²⁰ The null hypothesis (H_0) of this test stipulates that the two independent groups are homogeneous and have the same distribution. The alternative hypothesis (H_1) against which the null hypothesis is tested stipulates that the first group data distribution differs from the second group data distribution.

This test determines the significance of differences between two samples of scores that represent at least ordinal measurement by calculating the absolute values of the differences between two variables for each case, ranking these differences from the smallest to the largest and finally computing the test statistic U from the sums of ranks for negative and positive differences as shown in Eq. 4-8. The smaller value of U_1 and U_2 is the one used when consulting significance tables. The statistic U of the Mann-Whitney U-test is then compared to a table of critical values based on the sample size of each group.⁴²¹ If the value of U-value exceeds its critical p-value at (0.05) significance level, there is evidence to reject the null hypothesis, which means there is a significant differences between the two groups.

To use the Wilcoxon Mann Whitney test:

- It must be reasonable to regard the data as a random sample from their respective populations,
- Observations within each group must be independent of one another,

⁴¹⁹ For excellent discussion, See (Berenson *et al.* 2009).

⁴²⁰ Zhang, X.Q.: Factor Analysis of Public Clients' Best Value Objective in Public-Privately Partnered Infrastructure Projects. *Journal of Construction Engineering and Management*, Vol.132 (9), 2006b, P. 956-65.

⁴²¹ See (Berenson *et al.* 2009).

- The two groups must be independent of one another.

$$U_1 = n_1 n_2 + \frac{n_1(n_1 + 1)}{2} - R_1$$

$$U_2 = n_1 n_2 + \frac{n_2(n_2 + 1)}{2} - R_2$$

Where:

n_1 = Population size for group 1,

n_2 = Population size for group 2,

R_1 = The sum of the ranks in group 1,

R_2 = The sum of the ranks in group 2.

Equation 4-8: Mann-Whitney U Test for independent samples

4.5.6 Effect Size Index

Effect size is the difference between the means divided by the standard deviation for the population.⁴²² There are many different measures of effect size, depending on the design of the study. One use of effect-size is as a standardized index that is independent of sample size and quantifies the magnitude of the difference between populations or the relationship between explanatory and response variables.⁴²³ Another use of effect size is its use in performing power analysis. There is a wide array of formulas used to measure effect size. Effect size is defined by Cohen's d as shown below:

$$\text{Cohen's } d = \frac{|\bar{X}_1 - \bar{X}_2|}{\hat{\sigma}}$$

Where:

d = Effect size,

\bar{X}_1 = Mean of group 1,

\bar{X}_2 = Mean of group 2,

$\hat{\sigma}$ = Estimated standard deviation for the total population from the sample.

Equation 4-9: Effect size for independent samples (Cohen)

⁴²² Cohen, J.: Statistical power analysis for the behavioral sciences. Hillsdale, NJ. Erlbaum, 1988.

⁴²³ http://www.ats.ucla.edu/stat/mult_pkg/faq/general/effect_size_power/effect_size_power.htm.

There are several different ways to estimate σ from sample data which leads to multiple variants within the Cohen's d , some of them are:

- **Using the root mean square standard deviation:** as shown below.

$$\text{Cohen's } d = \frac{|\bar{X}_1 - \bar{X}_2|}{\sqrt{\frac{S_1^2 + S_2^2}{2}}}$$

Where:

S_1 = Standard deviation of group 1,

S_2 = Standard deviation of group 2.

Equation 4-10: Effect size for independent samples (Cohen) using mean square standard deviation

- **Using the pooled standard deviation (Hedges' g):** In case of two different sizes of the samples, Cohen's d uses the pooled standard deviation (See Eq. 4-11) and is also known as Hedges' g .

$$g = \frac{\bar{X}_1 - \bar{X}_2}{\sqrt{\frac{(n_1 - 1)S_1^2 + (n_2 - 1)S_2^2}{n_1 + n_2 - 2}}}$$

Where:

g = Hedges' g

n_1 = Size of group 1,

n_2 = Size of group 2,

Equation 4-11: Effect size for independent samples (Cohen) using pooled standard deviation

- **When there are more than two groups:** the difference between the largest and smallest means is used, divided by the square root of the mean square error as shown below.⁴²⁴

$$\text{Cohen's } d = \frac{\bar{X}_{\text{largest}} - \bar{X}_{\text{smallest}}}{\sqrt{mse}}$$

Where:

mse = Mean square error.

⁴²⁴ Cohen, J.: Statistical power analysis for the behavioral sciences. Hillsdale, NJ. Erlbaum, 1988.

Equation 4-12: Effect size for independent samples (Cohen) for more than two groups

Moreover, the conventional values proposed by Cohen (1969)⁴²⁵ for d values are:

- Small effect $d = 0.2$
- Medium effect $d = 0.5$
- Large effect $d = 0.8$

4.5.7 Center of Mass Theory

Center of Mass is defined as the average position of the mass/ weights of the system.⁴²⁶ Let the weight of the particles are m_1, m_2, \dots, m_n , and let them be located at x_1, x_2, \dots, x_n respectively. Then the center of weight is defined by the following integral:

$$R = \frac{1}{M} \sum_{i=1}^n m_i x_i$$

Where:

- m_i = The mass/ weight in the system
 x_i = Mass location
 M = $m_1 + m_2 + m_3 \dots + m_n$
 n = Number of weights

Equation 4-13: Center of mass

In other words, the center of weight is sum of the weight fraction of each point in the system multiplied by its position. In this case M is the total weight of the system. The previous equations describe the position of the center of weight in the x direction, but the same equations apply for the y and z directions as well.

4.6 Summary

Overall this chapter articulated the rationale for the research method and the framework for this study, the research design and sampling procedures, including the population and instruments. It also presented the procedures for data collection and analysis. It equally showed the validity and reliability considerations of the study.

⁴²⁵ Cohen, J.: Statistical power analysis for the behavioral sciences. New York, Academic Press, 1969.

⁴²⁶ Hans C. Ohanian, John T. Markert : Physics for Engineers and Scientists. Third Edition, Vol. 1, 2006

5 Data Analysis and Results

This chapter deals with the findings of the questionnaire survey administered to PPP stakeholder groups in Iraq. As well as a recommendation policy based of research result. Furthermore, quantitative data in the raw form convey very little meaning to most people. The data therefore have been processed to make them meaningful, that is, to turn them into information. The researcher therefore used quantitative analysis techniques such as graphs, charts, and statistics to turn the data into meaningful information. This has helped to explore, present, describe and examine relationships and trends within the data. Figures have been rounded to the nearest whole numbers.

This chapter is divided into two sections, first section deals with the questionnaire survey results, in turn this section is divided into five sub sections according to the questionnaire survey framework. The first section deals with the general characterization of respondents, while the second section presents the general experience with PPP in Iraq. The third section examines the criteria and performance of PPP in Iraq. The fourth section considers main risk factors of PPP in Iraq and their allocation preferences. The fifth section shows prospects for public-private partnership in infrastructure projects in Iraq. The second section of this chapter presents; based on research results; recommendations policy to help Gol to implement a good PPP project.

5.1 Questionnaire Survey Analysis

Analysis is an interactive process by which answers to be examined to see whether these results support the hypothesis underlying each question.⁴²⁷ Quantitative statistical analysis for questionnaire was done by using Statistical Package for Social Sciences v20 (SPSS). All percentage figures have been rounded to the nearest whole numbers. Where appropriate, findings have been illustrated with the aid of graphs and tables.

The questionnaire survey was conducted through a written online survey⁴²⁸. There was a separate questionnaire distribution for public sector organizations operating in developing infrastructure projects, private sector companies and Academic researchers. A general summary of statistical indicators of test carried out are shown in Table 5-1.

In line with Table 5-1, 133 questionnaires survey are returned from 209 questionnaires distributed where this contributes to (63.60%) of the total distribution. The high percentage of answered questionnaire is probably caused by the method of direct questionnaire survey distribution to the respondents, which fosters the respondent's cooperation in the survey. Besides, cooperation by respondents' organizations in reminding their participants to respond to the questionnaire survey is also one of the milestones escalating the number of returned questionnaire.

Yet, only 107 returned questionnaires are answered whilst 26 returned questionnaire are disqualified due to blank, illegible, response behavior (processing time and plausibility), wrong survey sample (target group), invalid or multiple answers. These 107 returned and valid questionnaires are deemed as adequate and reliable for the purpose of this research as it falls

⁴²⁷ Hallaq, K.: Causes of Contractors' failure in Gaza Strip. MSc thesis, Islamic University of Gaza Strip, 2003.

⁴²⁸ The Survey was Created Using the Online Tools "Quest Back Unipark".

within the range of 100 to 300 samples projected by the binomial percentage distribution table in achieving (95%) confidence level and (5%) confidence interval.

Besides, (51.20%) of the valid response rate are also perceived as adequate for analysis and reporting purpose based on Table 5-2 of the valid response rate adequacy for analysis and reporting.⁴²⁹

Description	Public sector	Private sector	Academic researchers	Overall
Questionnaire distributed	70	90	49	209
Questionnaire returned	59	39	35	133
Missing	11	51	14	76
Questionnaire returned percentage	84.2%	43.3 %	71.4 %	63.60 %
Questionnaire returned and valid	48	30	29	107
Questionnaire returned but invalid because: Demolition the answer, Response behavior (processing time and plausibility), Wrong survey sample (target group)	11	9	6	26
Valid percentage	68.5 %	33.3 %	59.2 %	51.20 %

Table 5-1: Comparison among the distributed, returned, valid and invalid questionnaires by sector

Valid Response Rate (%)	Adequacy for Analysis and Reporting
< 50	Not adequate
50 - 59	Adequate
60 - 69	Good
70 - 100	Very Good

Table 5-2: Adequacy of valid response rate for analysis and reporting⁴³⁰

⁴²⁹ Miller, D.: Handbook of Research Design and Social Measurement. California: SAGE Publications Ltd, 1991.

⁴³⁰ Previous reference.

5.1.1 General Characterization of Respondents

Regarding respondents distribution by sector, findings show that (45%) of the respondents came from the public sector, which is the largest percentage of respondents, (28%) from the private sector, and the remaining respondents mainly comprised researchers and academics by (27%). Furthermore, Figure 5-1 shows the percentages of the three groups of the survey sample.

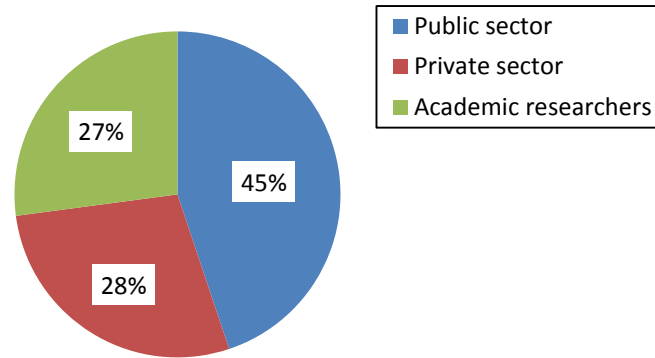

Figure 5-1: Distribution of respondents by sector (n=107)

Age serves as perceptual indicator of abilities, skills and experience. Findings in Figure 5-2 show that majority of the overall respondents (61.7%) aged between 41-60 years old. Besides, (24.3%) of respondents were aged between 31-40 years old, whilst respondents aged 60 years old and above possess about (7.5%), respondents aged 20-30 years old possess about (7.5%) which is the lowest percentage of respondents. Furthermore, findings show that majority of respondents from the public sector about one-half (56.3%) and Academics about (69%) aged between 41-60 years old, two-third (63.3%) of the private sector respondents aged between 31-40 years old.

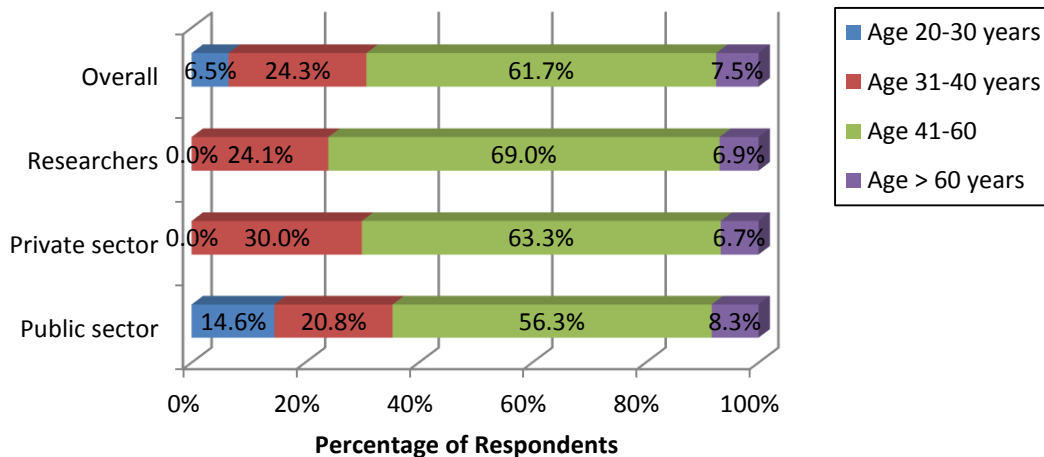

Figure 5-2: Distribution of respondents by age (n=48/30/29)⁴³¹

⁴³¹ n= number of respondents, from now and later on the “n” of the three groups will be represented as public/private/Academic.

Regarding the Academic degree, respondents are also grouped into their academic qualification. It can be notes from the Figure 5-3, and with respect to the overall qualifications of the respondents, the highest percentage was for those with a Bachelor Degree, where this ratio was (58.9%), which is the largest percentage of respondents, followed by a PhD Degree by (26.2%), and then the Master's Degree with (10.3%). Moreover, the lowest percentage was for those with a High Diploma Degree by (4.7%).

In addition to, survey results in Figure 5-3 show that majority of public and private sectors respondents were Bachelor Degree holders by (87.5%) and (60%) respectively, whilst the majority of Academic researchers were PhD Degree by (72.4%).

The variation in the Academic Degree of the survey sample, can explained by the desire of the Bachelor Degree holders to enter the labor market directly after graduation, and to gain practical experience, while the Master's Degree and PhD Degree holders keen to increasing their education degree to get more job opportunities in labor markets.

This questionnaire result is considered as reliable and valid since majority of the respondents possess the Bachelor Degree as their academic qualification, yet the response given is still considered as dependable given that the academic qualification is Professional Certificate in Civil Engineering which is directly related to construction practices. Moreover, as a part of the survey target was the academics from Iraqi Universities and Institutions who involved in educating the future construction players, this explains the high percentage of the PhD Degree holders, and reinforces this survey reliability.

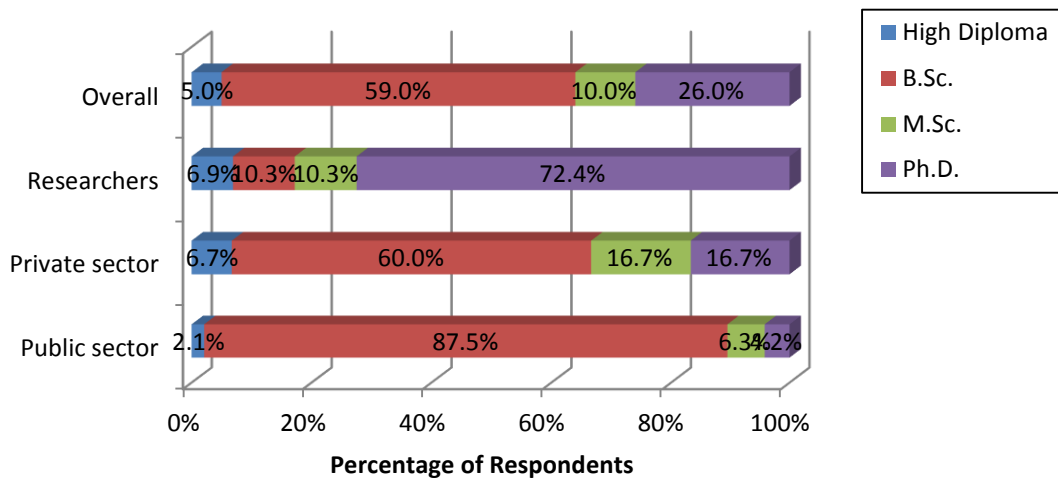

Figure 5-3: Distribution of respondents by academic degree (n=48/30/29)

Furthermore, Figure 5-4 shows that nearly one-half (56.1%) of overall respondents had at least 21 years of working experience. (16.8%) of respondents had 11-15 years of working experience. (13.1%) of respondents had 6-10 years of working experience. Besides, one-tenth (9.3%) of respondents had 16-20 years of working experience, whilst respondents with 5 years or below of working experience possess about (4.7%) which is the lowest percentage of respondents.

Furthermore, survey results show that half of the public and private sectors as well as Academics respondents had at least 21 years of working experience by (58.3%) (53.3%) (55.2%) respectively, the variation in the working experience of the survey sample, can explained due to that part of the questionnaire target respondents was the decision makers and persons at the management level and advisors that have long experience. This hands-on working experience and relevant organizations of the selected experts uphold the validity and provided a balanced view of this study.

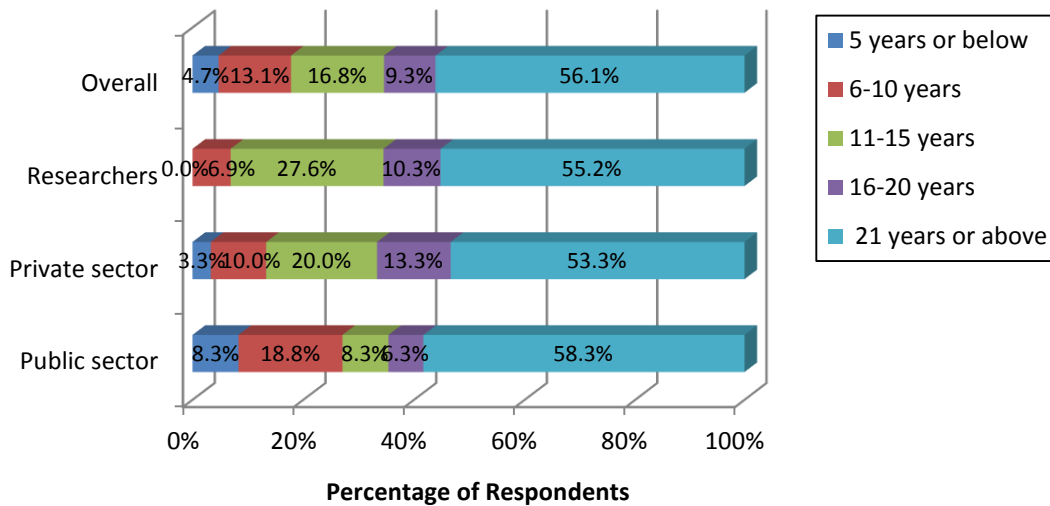

Figure 5-4: Distribution of respondents by experience in construction industry (n=48/30/29)

In terms of designation of respondents in the company/organisation; as shown in Figure 5-5; the survey shows that majority of the overall respondents hold Construction Executive position either high or middle level, about one-fourth (26.2%) of respondents were at Consultant position, (16.8%) hold a Director position, respondents with General director and Senior level positions possess (14%), followed with respondents who hold other than positions stated in the list, such as Engineering position by (13.1%), Contractor position by (10.3%), and Financer position by (5.6%).

Moreover, survey results show that the largest percentage of public sector respondents hold Director Position by about one-fourth (25%), whilst the largest percentage of private sector respondents hold Contract position by (26.7%). Beside the largest percentage of Academics respondents hold Consultant position by about one half (44.8%).

Answers to the question about the organization name are divided according to main public agencies that working in develop infrastructure projects in Iraq.

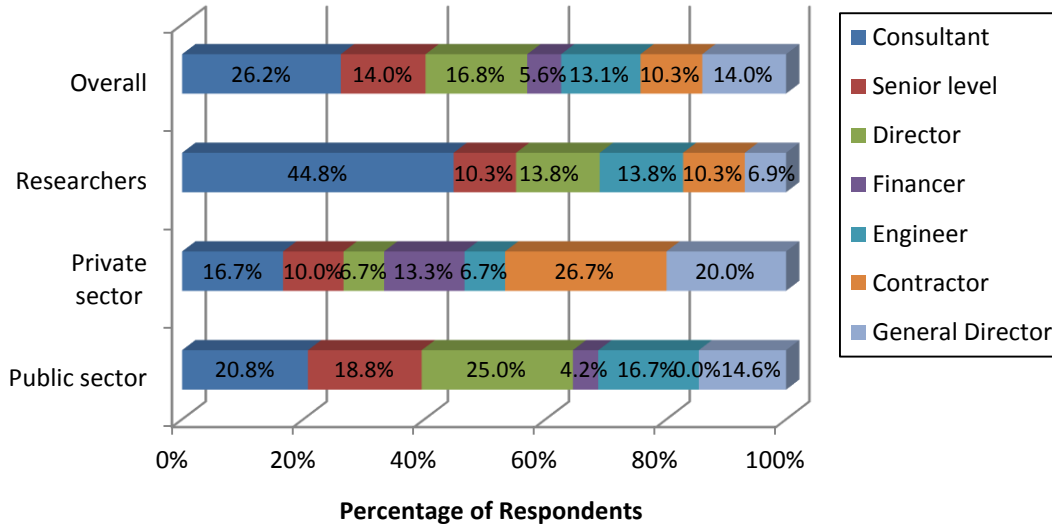

Figure 5-5: Distribution of respondents by job title (n=48/30/29)

Findings from Figure 5-6 show that public sector organizations that involved in the questionnaire were: respondents of Iraqi Railway Company possess (18.75%); respondents of the General Authority of Water Supply (16.67%), respondents of the General Authority of Sewage Work (14.58%), Ministry of Electricity (MoE) possess (16.67%). Moreover, General Authority of Road with (10.42%), Ministry of Industrial with (8.33%), Ministry of Planning with (8.33%), and the lowest percentage of respondents was with National Investment Commission with (6.25%).

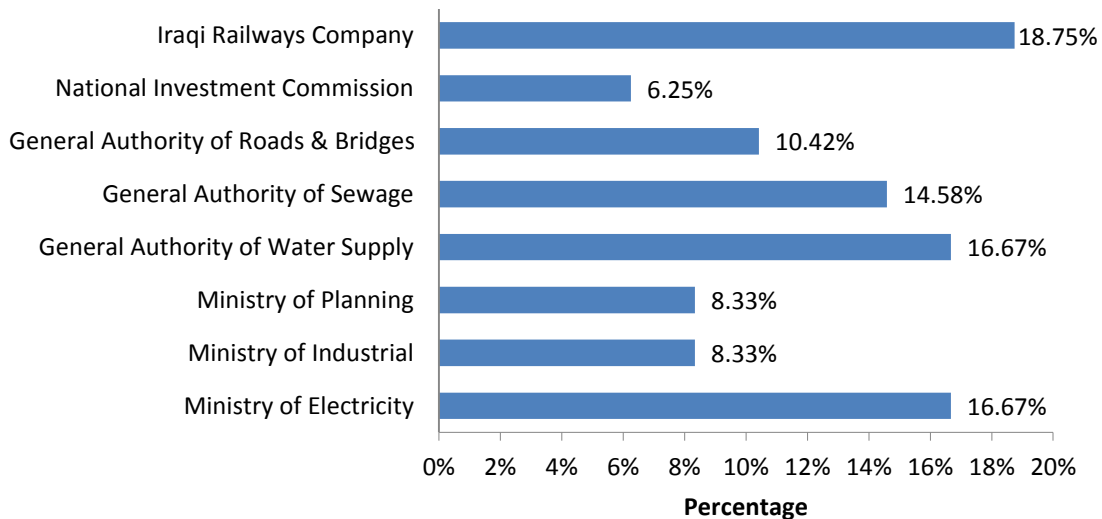

Figure 5-6: Distribution of public sector respondents by Ministries (n=48)

Regarding private sector, majority of the private sector did not answer this question; this is probably due to that they try to protect themselves against public sector agencies. Figure 5-7 shows the private sector companies categorize by project types.

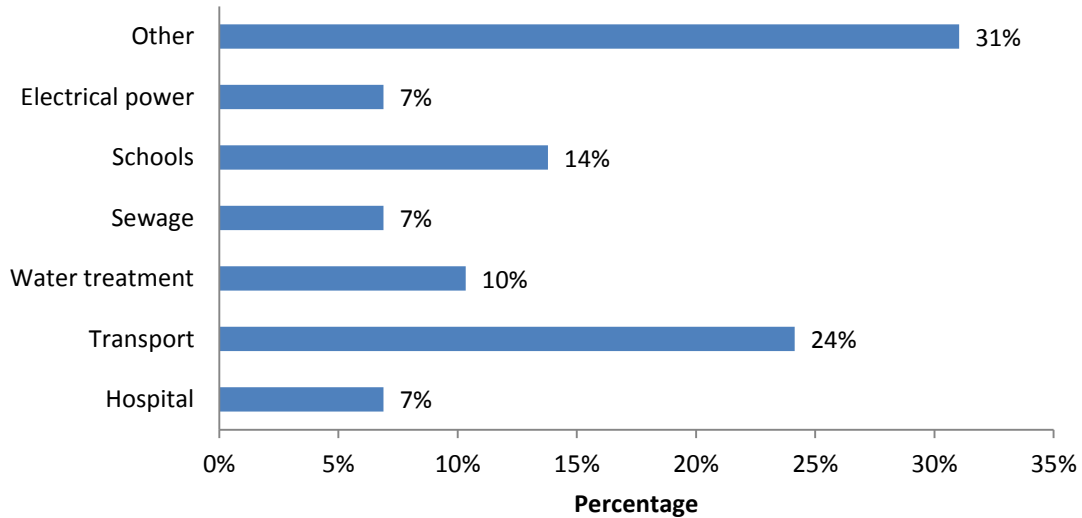

Figure 5-7: : Distribution of private sector respondents by project types (n=29)

5.1.2 General Experience with PPP (Survey-Section 2)

5.1.2.1 PPP experience (Question 1)

Given the few PPP projects conducted in Iraq, it was unsurprising to find that about two-third (62.5%) of the public sector respondents gained no previous experience in PPP, which is the largest percentage of respondents. followed with Academic researchers respondents with approximately one-half (48.3%). Whilst the private sector respondents possess (26.7%). Besides, (14.6%) of the public sector respondents were with at least 6 years experience, (14.6%) of the public sector respondents were with 3-5 years experience. Moreover, the lowest percentage of the public sector respondents was for those with 1-2 years experience by (8.3%).

The high percentage of no experience with PPP of the public sector and Academic researchers respondents, indicates the lack of experience and capacity in the public sector and Academic researchers (who are serve as advisors for the public sector), which is one of the major problems in implementing PPP projects in Iraq. As PPP projects are typically large-scale and complex. Lack of experience or appropriate skills” increases the likelihood of suffering losses and thus makes PPP projects less attractive to the private sector in Iraq.

Moreover, the high percentage of the no experience with PPP of the private sector respondents by (26.7%) can be explained due to that some private sector respondents without hands on PPP experience (but interested or wishing to invest in PPP) were included in the survey (the same case by the public sector and Academics sometimes too). Regarding the one-half (51%) of overall respondents with PPP experience as shown in Figure 5-8, without doubt some of these may have had experience with local PPP projects, but still the experience of these respondents confirmed the quality of the responses from the survey conducted.

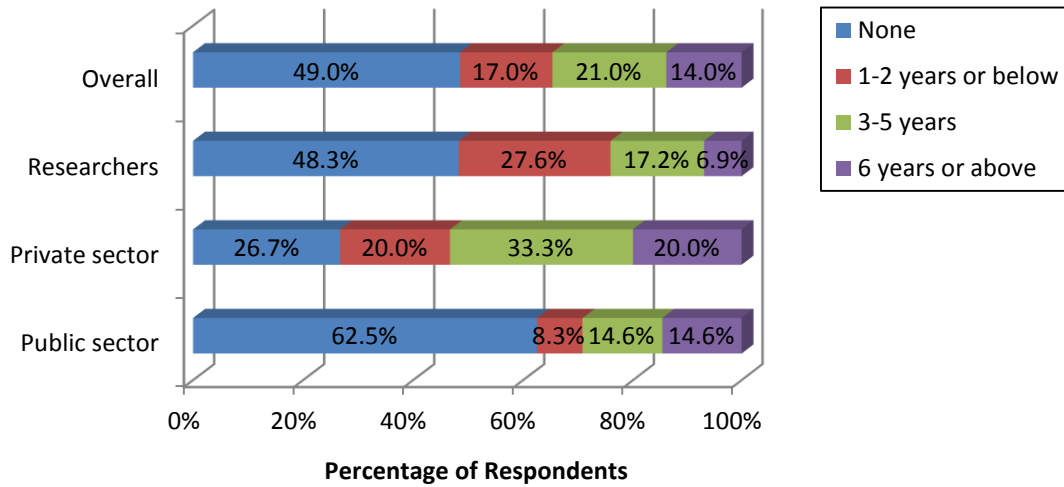

Figure 5-8: Distribution of respondents by PPP experience (n=48/30/29)

5.1.2.2 PPP Project Undertaken by the Organization/ Company (Question 2)

Regarding the PPP projects that undertaken by respondent organizations/ or companies, it was unsurprising to find that approximately (76.7%) of the private sector respondents have participated in PPP projects currently or before. On the other hand, due to the fact that there is a few projects of PPP in Iraq, findings indicate that near one-fifth (21.3%) of the public sector respondents, and (17.2%) of Academic researchers respondents have participated in PPP projects currently as shown in Figure 5-9. Findings showed that the majority of private sector respondents had participated in projects both locally and abroad, whereas most of the public sector and Academic researchers' respondents had participated in local projects only.

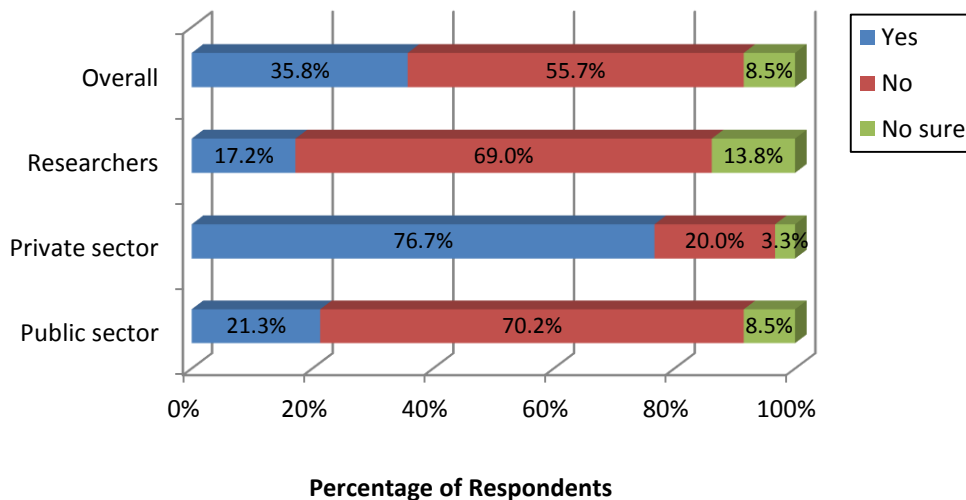

Figure 5-9: Availability of PPP project undertaken by the organization (n=47/30/29)

5.1.2.3 Type of PPP Project Undertaken (Question 3)

Furthermore, survey respondents were asked to identify the PPP project type that they are involved within. Figure 5-10 shows main PPP projects types that undertaken by the respondents' company/organization. It can be figured that (28%) of projects are with the power and energy sector, followed with (17%) of the housing sector which is reflect the Gol needs and their priorities in implementing PPP projects.

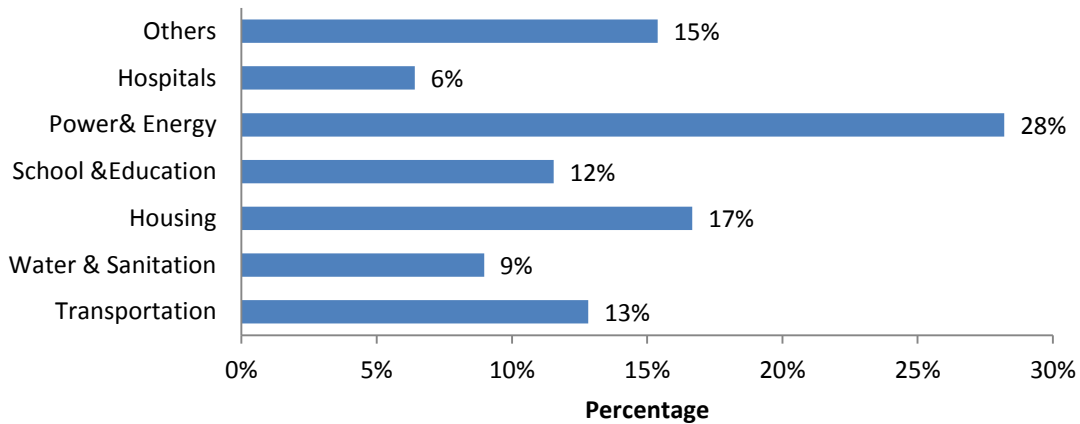

Figure 5-10: Main PPP project types undertaken by the organization (n=78)

5.1.2.4 Type of PPP Contract Undertaken (Question 4)

The questionnaire survey successfully proves that majority of PPP projects are undertaken through Build-Operate-Own (BOO) and Lease Contract (LC) by (30%) for both. Nonetheless, the second highest percentage on the type of procurement for PPP project undertaken is through Build-Operate-Transfer (BOT) by (22%). This is followed with O&M contracts and Rehabilitate-Operate-Transfer ROT by (10%) and (9%) respectively, as shown in Figure 5-11.

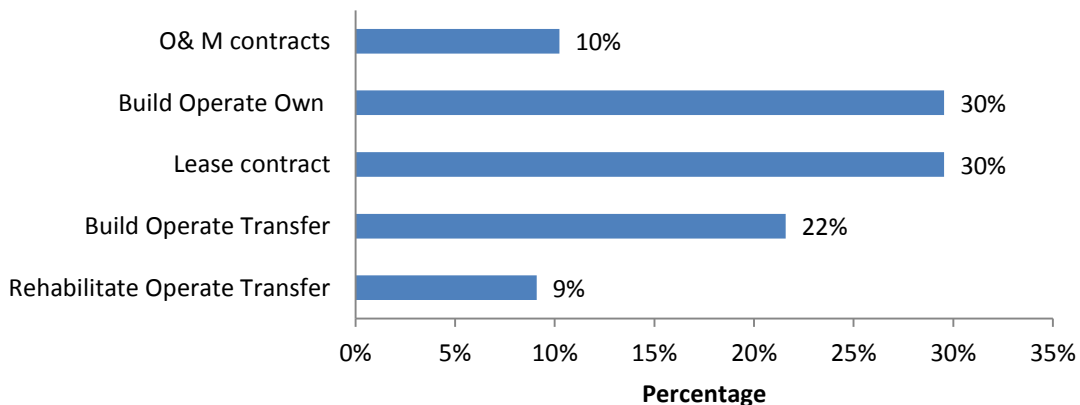

Figure 5-11: Contract type of PPP project undertaken by the organization (n=88)

5.1.2.5 PPP Implementation Guidance (Question 5)

Figure 5-12 below presents questionnaire survey findings that were mentioned by the respondents regarding PPP guidance, it was found that about one-fifth (22.9%) of the respondents in the public sector replied “Yes”, about two-third (70%) of the respondents in the private sector replied “Yes”, whereas about one-fifth (20.7%) of the respondents in the Academic researchers replied “Yes”.

This finding has shown that the private sector were much more likely to have their own guidance materials, whereas for the public sector the responses varied due to the few number of PPP projects conducted in Iraq. Furthermore, majority of the public sector respondents (77.1%) replied “No” or “No sure”, whereas (79.3%) of the Academic researchers respondents replied “No” or “No sure”.

This high percentage of respondents from the public sector and Academic researchers with “No” or “No sure”, can be explained that the public sector respondents illustrate that there are no governmental guidelines concerning PPP implementation, and they are using the Iraqi General Conditions of Contracting (which are dealing with the traditional procurement of projects) as base guidelines to organize PPP contracts. This explains the variation in responses and shows the confused opinions of them.

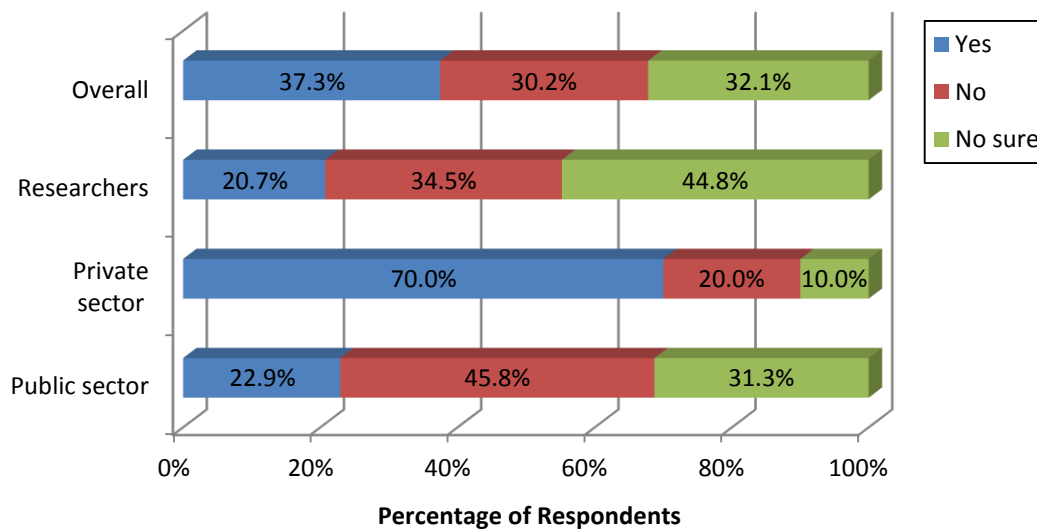

Figure 5-12: Availability of guidance on PPP implementation (n=47/30/29)

5.1.2.6 Viability of PPP for Public Projects (Question 6)

Regarding the PPP viability, the survey sample was asked to identify “if PPP is a viable solution for an accelerated public infrastructure projects in Iraq”. Findings from Figure 5-13 show that (87.5%) of respondents in the public sector responded “Yes”, and (90%) of respondents in the private sector responded “Yes”, whereas (72.4%) of respondents in the Academic researchers responded “Yes”. This shows that respondents believe in PPP as a solution for Iraq infrastructure projects.

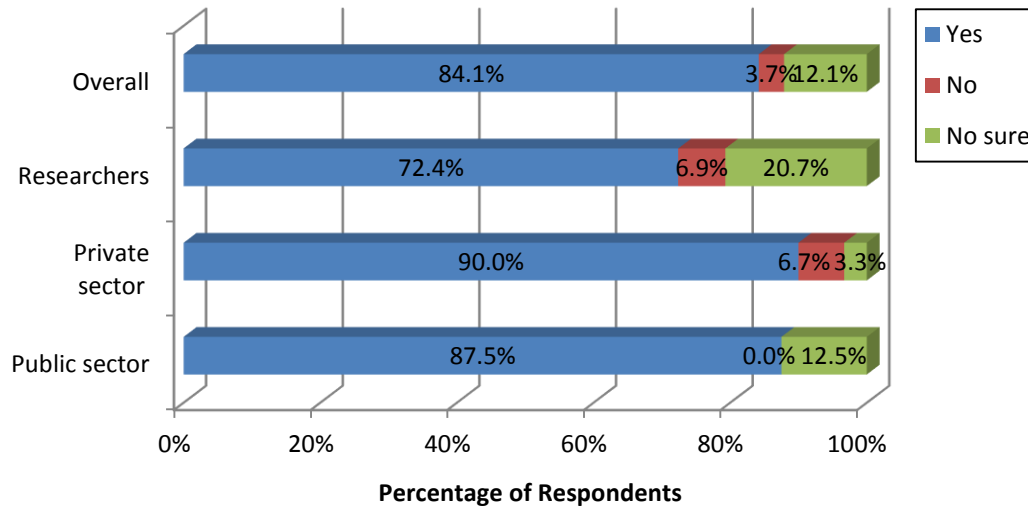

Figure 5-13: Viability of PPP for acceleration of public infrastructure projects (n=48/30/29)

5.1.2.7 Projects Best Suited to Use PPP in Iraq (Question 7)

Public works projects normally comprise of either economic or social infrastructure. Economic projects are normally those where the income is collected directly from the end-user, such as toll roads, railways etc. On the other hand social infrastructure projects are normally supported by a regular fee paid by the government, such as schools, hospitals etc. In line with this concept, respondents were asked to answer “Which type of project do you feel is best suited to use PPP in Iraq?” Figure 5-14 shows that respondents suggested that an “economic viable” project would be crucial. This was mentioned by about one-half (47.2%) of respondents from private sector, about one-third (36.6%) of respondents from Academic researchers, and only (22.6%) respondents from public sector.

Another important feature according to the public sector respondents is “Project depend” option with about one-third (28.3%), comparing with (16.7%) of private sector respondents, and (9.8%) of Academic researchers. Furthermore, “All projects” option was chosen by (20.8%) of public sector respondents, and by (16.7%) of private sector respondents, and with (9.8%) of Academic researchers. Although “Social projects” option, respondents did not rank it as the top of best suited project to use.

It can be seen that the “High risk projects” option was the lowest percentage of the entire survey sample which indicate the unwilling of respondents to deal with risky projects. Furthermore, the agreement of private sector on the economically viable project option is due to that most of private sector parties are businessmen, so for them to participate in PPP projects there must be reasonable financial benefits foreseeable for them.

There is a clear variation in the public sector responds, probably due to the lack of experience in PPP projects which reflect on their choices.

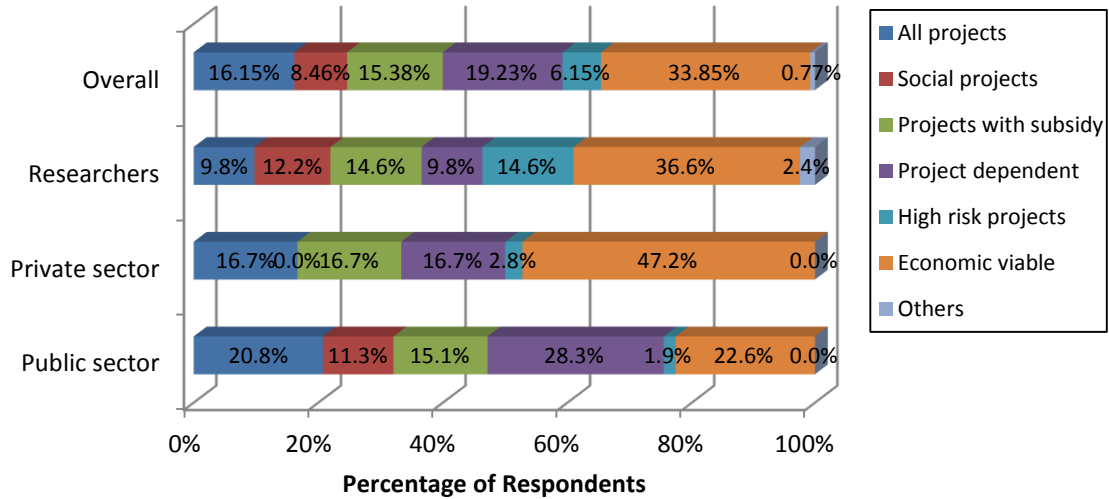

Figure 5-14: Best suited projects for PPP projects in Iraq (n=48/30/29)

5.1.3 Criteria and performance of PPP in Iraq (Survey-Section 3)

This part aims to study and evaluate the level of awareness and knowledge and current condition of Iraq public sector.

5.1.3.1 Attractive Factors for Adopting PPP (Question 8)

The financing of public sector projects has been recognized as one of the key initial driving forces for implementing PPP schemes internationally. Many experienced practitioners in PPP such as Zimmermann⁴³² and Alfen⁴³³ believe that PPP brings about many other attractions besides financing, and that financial motivations should not be taken as the sole reason for adopting PPP. However, Table 5-3 illustrates the mean scores, standard deviation and the rank of the relative importance of each of main factors for adopting PPP based on the overall respondents, as well as based on sector (i.e. public and private sectors as well as Academics). As respondents were asked to rate factors for adopting PPP according to a Likert scale from 1 to 6 (1 = Completely Disagree, 6 = Completely Agree and 0= Not Applicable), a value above “3.5” would represent that the attractive factor is of importance. Based on the overall respondents’ results the top three reasons ranked in Iraq included:

1. Solve the problem of public sector budget shortage
2. Technology transfer to local enterprise through the private sector's Know How;
3. Social pressure of poor public facilities.

⁴³² Zimmermann, Josef: Public Private Partnership. Wirtschaftlichkeitsuntersuchung, Seminar Immobilienwirtschaft, Lehrstuhl für Bauprozessmanagement der TU München, 2013.

⁴³³ Hans-Wilhelm Alfen, et al: PPP-Lösungen für Deutschlands Autobahnen: Empfehlungen für eine erfolgreiche Umsetzung. Bauhaus-Universität Weimar, Germany. 2004.

The top reason for implementing PPP projects ranked by respondents from public as well as private sectors were “Solve the problem of public sector budget shortage”. Academics also ranked this factor relatively high at second place. One of the main reasons for the rise of PPP projects is due to financial resources from the private sector.

The high rank of this factor across the three survey groups represents that the importance of this reason for implementing PPP projects is applicable irrespective of group’s differences. Also this indicates that respondents probably notice that by involving the private sector the government will be able to continue delivering public infrastructure as well as doing good investments.

The second reason for implementing PPP projects ranked by respondents from public and private sectors were “Technology transfer”. This indicates that respondents of both groups believe that PPP brings about many other attractions besides financing, and that financial motivations are not the main reason for adopting PPP. Moreover, the private sector can add value to these projects by transferring knowledge and know-How to local enterprises. Academics respondents ranked this reason higher than public and private sectors at first place.

Ranked thirdly by respondents of public sector was “Social pressure”. This could be a reflection of the real life situation that the public sector respondents have observed. As they are part of the government, they may feel that the government has been under pressure from the society. Contrastingly, by the private sector and Academics respondents this reason was ranked lower at fourth place for both groups, indicating that those respondents did not feel the society pressure on the government.

Factors	Code	Public sector			Private sector			Researchers			Overall		
		Mean	SD	Rank	Mean	SD	Rank	Mean	SD	Rank	Mean	SD	Rank
Solve the problem of public sector budget shortage	A1	5.32	1.125	1	5.41	0.907	1	4.90	1.291	2	5.23	1.129	1
Social pressure of poor public facilities	A2	4.94	1.450	3	4.67	1.539	4	4.46	1.384	4	4.71	1.450	3
Technology transfer to local enterprise through the private sector's Know How	A3	5.21	1.031	2	5.17	1.490	2	5.21	1.346	1	5.20	1.245	2
Efficient allocation of project risks between the public and private partner	A4	4.40	1.498	4	5.07	1.223	3	4.66	1.495	3	4.66	1.441	4
Reduce the total project cost	A5	4.28	1.598	5	4.27	1.617	5	4.07	1.585	5	4.07	1.587	5

Table 5-3: Attractive factor for PPP projects

Mean values for attractive factors as rated by public sector respondents ranged from 4.28 to 5.32. This observation has reflected that the variation in their responses are relatively small, only 1.04 by public sector. In private sector and Academic researchers means ranged from 4.27 to 5.41 and 4.07 to 5.21 respectively. Corresponding differences in means were 1.14 and 1.14 respectively.

Differences in means were shown to be much lower for the survey groups. This finding shows that survey respondents rated attractive factors much more consistently.

In order to test the internal agreement within the same group of respondents on the rankings of attractive factors for adopting PPP. On this line and before starting the implementation of the statistical analysis procedures, the researcher checks the availability of the normal distribution of the data, by using Kolmogorov - Smirnov (KS) test; it was found that the collected data are not following a normal distribution.⁴³⁴ The null hypothesis for the test of normality is that data are normally distributed. As the p-value is less than 0.05, the null hypothesis is rejected and the data are not normally distributed.⁴³⁵

The values of Kendall's coefficient of concordance was calculated to measure the internal agreement within the same group of respondents on the rankings of attractive factors for adopting PPP in Iraq. The null hypothesis for this test is ($H_0 : W = 0$), and the alternative hypothesis is ($H_0 : W \neq 0$).⁴³⁶ The Kendall's coefficient of concordance (W) for the three groups (public and private sectors as well as researchers) was 0.097, 0.084 and 0.095 respectively. The computed value of the W was statistically significant at 0.01, 0.05 and 0.03 significance level. It can be conclude that there is significant agreement among the respondents on the ratings of attractive factors for adopting PPP in Iraq.

In addition to, Figure 5-15 below shows means and standard deviations for each factor among survey groups, it is not surprising that the entire respondents have rated these factors highly which reflect the small value of the standard deviations, where most of factors ranked at the upper and middle third of the importance scale.

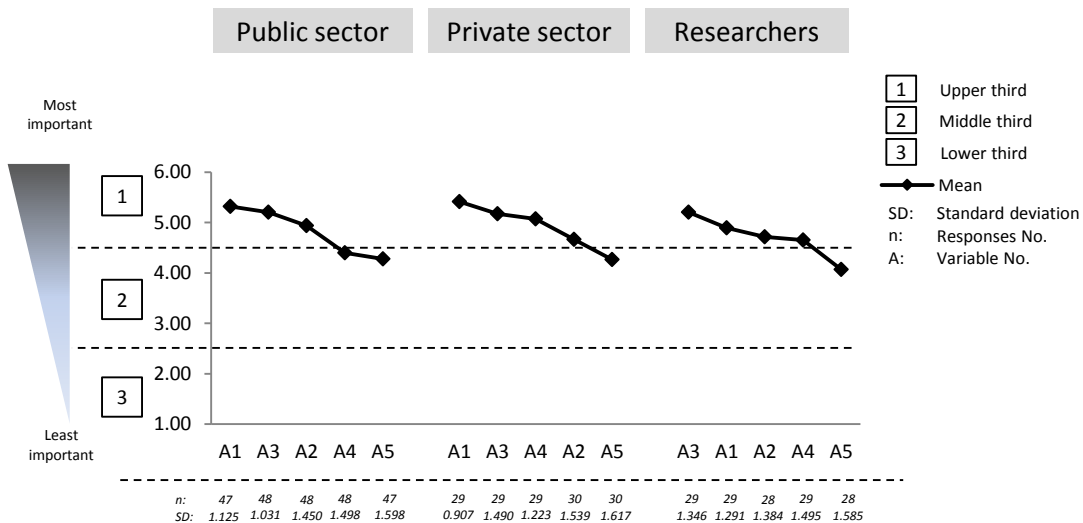

Figure 5-15: Attractive factors for PPP projects among survey groups

In order to test the agreement among survey groups respondents on the rankings of attractive factors for adopting PPP, the non-parametric statistical Kruskal Wallis test is performed. The null

⁴³⁴ See Appendix C.

⁴³⁵ See Section 4.5.2.

⁴³⁶ See Section 4.5.3.

hypothesis for the test is that the medians significance of each factor is equal among the three groups. Findings indicate that as the p-value is greater than 0.05 for all factors, the null hypothesis is accepted, indicating that there is a agreement and there is no significant difference among the survey groups for all the attractive factors for adopting PPP in Iraq. Table 5-4 shows the test results. As the sample size in each group is larger than 5,⁴³⁷ H is represented by Chi-square value, and p- value is labelled as “Asymp Sig.” as shown in the SPSS output, meaning that the probability of getting a particular value of H is the p- value corresponding to a Chi-square; with (n-1) degrees of freedom (df).⁴³⁸

	Solve the problem of public sector budget shortage	Social pressure of poor public facilities	Technology transfer to local enterprise through the private sector's Know How	Efficient allocation of project risks between the public and private partner	Reduce the total project cost
Chi-Square (H)	3.483	1.258	2.187	3.600	0.678
Degree of freedom (df)	2	2	2	2	2
Asymp. Sig. (p- value)	0.175	0.533	0.335	0.165	0.712

Table 5-4: Kruskal Wallis test results of attractive factor for PPP projects

5.1.3.2 Negative Factors for Adopting PPP (Question 9)

Negative factors for adopting PPP were rated by the survey respondents in Table 5-5. The top three negative factors ranked by overall respondents included:

1. Very large tendering, contracting and re-negotiation costs;
2. Difficulties of ensuring future good performance (Bankruptcy ...etc.); and
3. Higher capital cost.

Similarly to the rating of the attractive factors, respondents were also asked to rate negative factors according to a Likert scale from 1 to 6 (1 = Completely Disagree, 6 = Completely Agree; 0= Not Applicable), therefore a value above “3.5” would represent that the negative factor is of importance. The results show that all negative factors above a score of “3.5”.

The first rank by respondents from public sector was “The difficulties of ensuring future good”. Academics respondents also ranked this factor relatively high at second place. The high rank of this factor by the public sector and Academics respondents is could be because the complex structure of the PPP and multiple parties involved which may affect the future performance of PPP project, if the private partner goes bankrupt, solely the government has to deal with the consequences and try to find other expedients how to keep delivering the service to the public. Private sector respondents

⁴³⁷ See Section 4.5.4.

⁴³⁸ For excellent discussion, See (Berenson *et al.* 2009).

ranked this factor lower at fourth place, indicating that the experience of the private sector in conducting PPP projects is much more plentiful. Without doubt they are much more experienced and hence more confident in conducting future good performance in PPP projects.

Ranked second by respondents from public sector was “Very large tendering, contracting and re-negotiation costs”. Likewise, both private sector and Academics respondents also ranked this factor highly at first place. This finding has shown that “Very large tendering” is typical for PPP projects irrespective of the different groups. Due to the size and complexity of PPP projects, the re-negotiation and contractual process has been known to be lengthy and costly. This can be said to be a typical feature of PPP projects. Moreover, large bidding costs of the PPP projects act as a rejecting force for the private parties as they are unwilling to invest heavily in the bidding process just to be rejected later. Therefore, only projects that are of appropriate value and worthiness should consider PPP.

The third negative factor as ranked by the public sector respondents was “Public budget restrain by the annual payment to the private partner”. This finding shows that the public sector respondents probably afraid that the advantages of the PPP can turn into disadvantages. In other words, taking the PPP route allows a government to initiate the same amount of investments in one year while recording less expenditure for that same year. On the other hand, the commitment to pay an annual fee will increase expenditures in the future, reducing the scope for new public investment in coming years. Government spending might also be affected if the government provides stated guarantees to the PPP Project Company and thus incurs possible liabilities. Contrastingly, private sector respondents rank it lower at fifth place. Academics tend to seek a balance between the public and private sectors by appropriately choices, they rank it at fourth place.

Factors		Public sector			Private sector			Researchers			Overall		
		Mean	SD	Rank	Mean	SD	Rank	Mean	SD	Rank	Mean	SD	Rank
Very large tendering, contracting and re-negotiation costs	NE1	4.72	1.186	2	4.37	1.608	1	4.85	1.134	1	4.65	1.311	1
Difficulties of ensuring future good performance (Bankruptcy,....etc)	NE2	4.91	1.349	1	4.03	1.273	4	4.48	1.405	2	4.55	1.381	2
Public budget restrain by the annual payment to the private partner (which is work as a debt borne by future generations)	NE3	4.62	1.497	3	3.67	1.373	5	4.38	1.321	4	4.28	1.459	4
Higher capital cost	NE4	4.51	1.381	4	4.17	1.365	2	4.45	1.270	3	4.40	1.342	3
High risk relying on private sector	NE5	4.36	1.569	5	4.10	1.561	3	4.25	1.404	5	4.25	1.513	5

Table 5-5: Negative factors of PPP projects

Here the Kolmogorov - Smirnov (KS) test was used too; it was found that the collected data are not following a normal distribution.⁴³⁹ Furthermore, the values of Kendall's coefficient of concordance were calculated to measure the internal agreement within the same group of respondents on the rankings of negative factors for adopting PPP in Iraq. The null hypothesis for this test is ($H_0 : W = 0$), and the alternative hypothesis is ($H_0 : W \neq 0$). The Kendall's coefficient of concordance (W) for the three groups (public and private sectors as well as researchers) was 0.031, 0.038 and 0.029 respectively. The computed value of the W was statistically not significant at 0.25, 0.35 and 0.53 significance level. It can be conclude that there is no agreement among the respondents on the ratings of negative factors for adopting PPP in Iraq.

Her also, it is not surprising that the entire respondents have rated these factors highly, where most of factors ranked at the upper and middle third of the importance scale as shown in Figure 5-16 below.

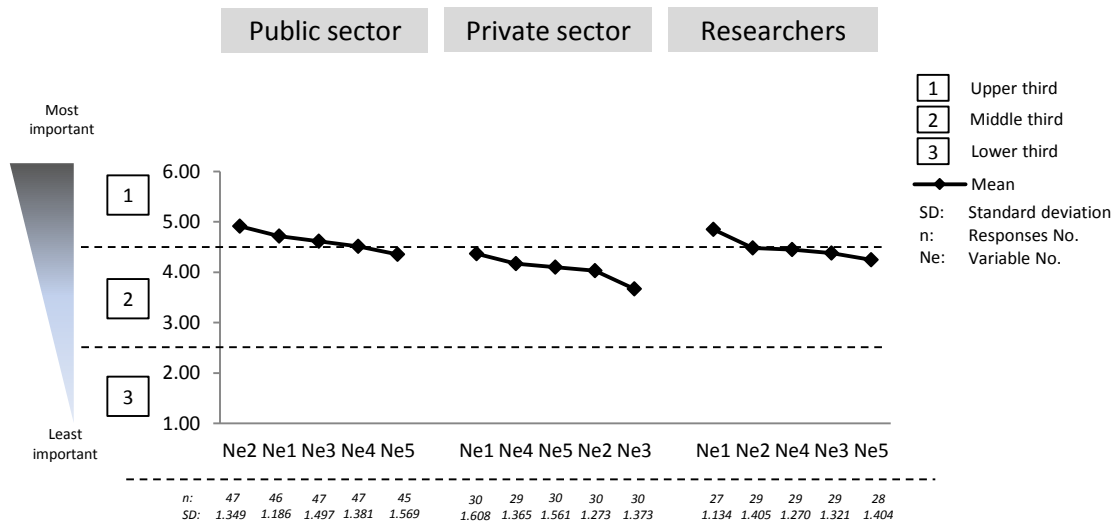

Figure 5-16: Negative factors for PPP projects among survey groups

To test the agreement among survey groups respondents on the negative factors for adopting PPP, the non-parametric statistical Kruskal Wallis test is performed. The null hypothesis is that the medians significance of each factor is equal among the three groups. Findings indicate that there is a significant agreement ($p\text{-value} > 0.05$) among the survey groups for three negative factors for adopting PPP in Iraq; these are “Very large tendering, and re-negotiation costs”, “Higher capital cost” and “High risk relying on private sector”.

Furthermore, there is disagreement ($p\text{-value} < 0.05$) at two factors, these are “The difficulties of ensuring future good performance” and “Public budget restrain by the annual payment to the private partner”. Table 5-6 shows the test results.

⁴³⁹ See Appendix C.

Again, as the sample sizes in each group is larger than 5, ⁴⁴⁰ H is represented by Chi-square value and p- value is labelled as “Asymp Sig.” as shown in the SPSS output, meaning that the probability of getting a particular value of H is the p- value corresponding to a Chi-square; with (n-1) degrees of freedom (df).⁴⁴¹

	Very large tendering, contracting and re-negotiation costs	The difficulties of ensuring future good performance (Bankruptcy,....etc)	Public budget restrain by the annual payment to the private partner	Higher capital cost	High risk relying on private sector
Chi-Square (H)	1.063	8.147	8.334	1.263	0.474
Degree of freedom (df)	2	2	2	2	2
Asymp. Sig. (p- value)	0.588	0.017	0.015	0.532	0.789

Table 5-6: Kruskal Wallis test results for negative factors of PPP projects

In addition to, a comparison of the mean score between positive and negative factors can assess the suitability of adopting PPP projects.⁴⁴² The identification of attractive and negative factors of PPP could be used as checklists for evaluate the suitability/feasibility of using PPP in Iraq. In case that attractive factors are prevailing in a given project scenario, the use of PPP will be more positive. Conversely, if the negative factors are dominant PPP might be considered as unsuitable.

In this line, the mean score of overall positive factors (mean= 4.67) was little higher than that of overall negative factors (mean=4.42), which may imply that the positive factors were more affirmative than the negative factors and that PPP projects were well accepted in the Iraq construction industry. Hence, more efforts should be made by the Gol to strengthen the positive factors and weaken the negative factors. The negative factors are also related to risk factors in PPP projects.

5.1.3.3 Knowledge Management and Capacity-Building (Question 10)

Knowledge management and capacity-building are another challenging and daunting task which is critical for the success of public projects in Iraq. With a given statement, survey respondents were requested to express their agreements about if they consider their organization has the required capacity-building and if their organizations are prepared to get involved in a PPP project. Figure 5-17 shows means and standard deviations of survey groups' respondents. It can be seen that there is an agreement by each group respondents on their answers mean.

⁴⁴⁰ See Section 4.5.4.

⁴⁴¹ For excellent discussion, See (Berenson *et al.* 2009).

⁴⁴² Cheung, E., Chan, A.P.C., Kajewski, S.: Suitability of Procuring Large Public Works by PPP in Hong Kong. *Journal of Engineering Construction and Architectural Management*, Vol.17 (3), 2010, P.292–308.

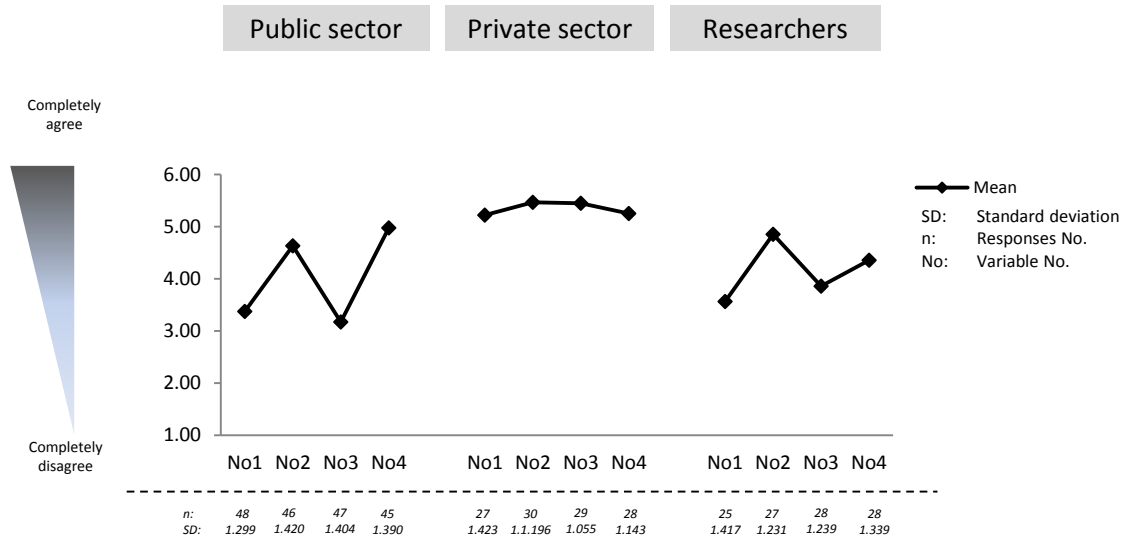

Figure 5-17: Availability of knowledge and capacity-building for PPP project among survey groups

5.1.3.3.1 The Availability of Knowledge and Capacity-Building (No1)

The research analyzed the level of know-how regarding the availability of knowledge and capacity-building to obtain private financing for a PPP project. In general, (37.5%) public sector respondents slightly disagree on this matter, as shown in Figure 5-18, which indicate that the public sector demonstrate some lack of knowledge and capacity-building at their organization, this lack of knowledge is can be explained due to that public sector gained no previous experience in PPP projects as proved in this research previous findings.

In addition to, this can be explained as in most cases public sector expertises are limited to specific areas related with their work, and very few of them make the effort of acquiring new knowledge and skill sets. They depend on the private partner to bring in the domain knowledge and expertise. Findings show that over (60%) disagree on this question by answering "completely disagree", "mostly disagree" or "slightly disagree".

On the other hand, private sector answers showing high level of knowledge and capacity-building with about two-third (70.4%) completely agree to this question. Also her we can conclude that the majority of private sector demonstrates the availability of knowledge at their organization, about (81.5%) answering with "completely agree", "mostly agree" or "slightly agree". As the private sector gained previous experience in PPP projects as proved in these research findings, it can be argued that the private partner has the ability to build the capacity of the public bodies by imparting training and make the public partner competent and self-dependent to sustain the operations.

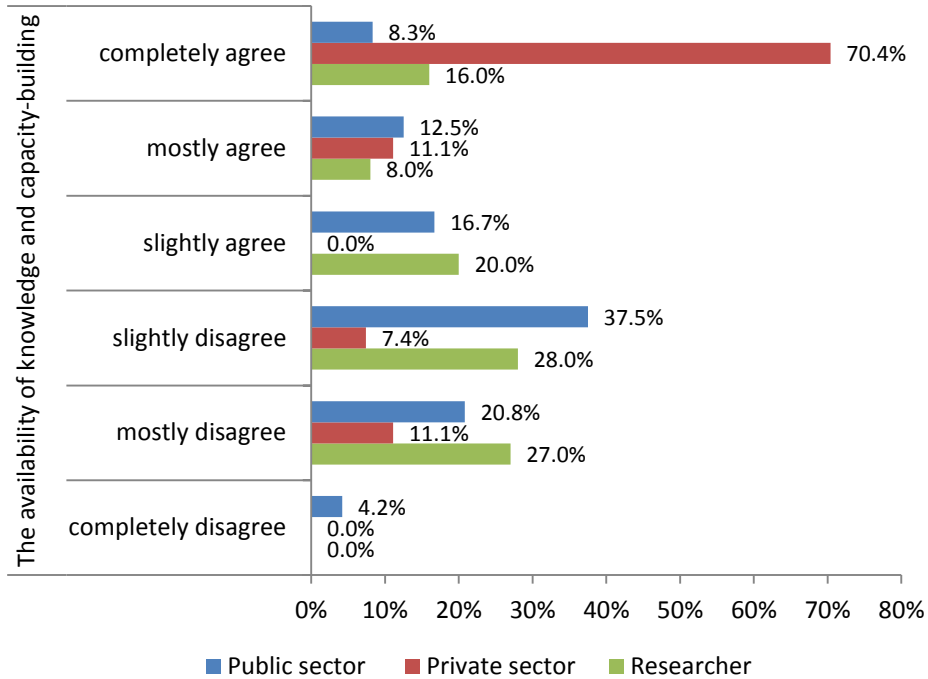

Figure 5-18: Availability of knowledge and capacity-building for PPP project (n: 48/27/25)

Furthermore, near one-third (27%) of respondents of Academic researchers mostly disagree to this question, indicating that Academics agree with the public sector perspective, and there is a huge need to make effort for acquiring new knowledge on PPP. A significant increase of knowledge and the know-how regarding the conditions to obtain private funding, among the public organizations interested to participate in PPP projects, is essential in order to increase the capacity to implement PPP projects in Iraq. Basically, we can conclude that Academics demonstrate lack of knowledge in PPP, about (55%) answering with "mostly disagree" or "slightly disagree".

5.1.3.3.2 Knowledge for Planning and Participation in PPP Project (No2)

Regarding the planning and participation in PPP project, Figure 5-19 below shows the survey groups' answers.

Findings illustrate that near one-half (41.3%) of public sector respondents completely agree on this matter, as shown in Figure 5-19. This can be indicates that there is a serious willing in the public sector to participate in PPP projects. As mentioned previously, the Gol has planned to increase private sector participation in the country's infrastructure through PPPs.⁴⁴³ In general, majority about (76.1%) of the public sector agreed by answering "completely agree", "mostly agree" or "slightly agree".

⁴⁴³ MENA-OECD Investment program: A Methodology for Infrastructure Prioritization in Iraq, 2010.

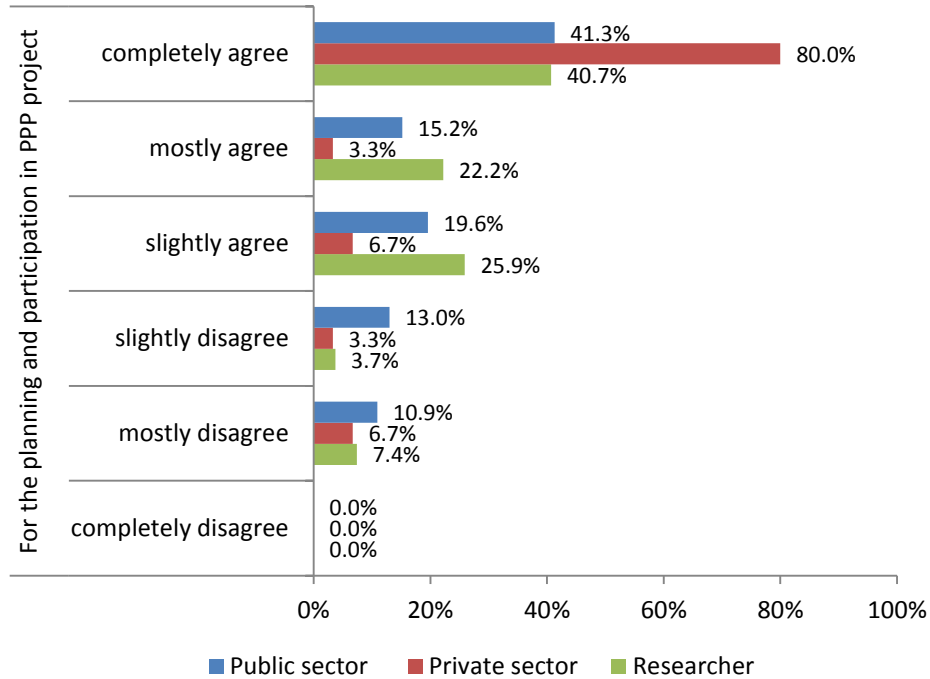

Figure 5-19: Knowledge for planning and participation in PPP project (n: 46/30/27)

Furthermore, findings indicate that (80%) of private sector as well as (40.7%) of Academic respondents are completely agree on this question, and they consider themselves prepared to participation in PPP project. In general, it can be concluded that (90%) of private sector and over (88%) of Academics are agreed that they are prepared for planning and participation in PPP project by answering with "completely agree", "mostly agree" or "slightly agree".

5.1.3.3.3 Knowledge for Tendering and Negotiation of a PPP Project (No3)

The key to successfully PPP contract is the development of sound negotiating strategies. Negotiation in PPP contracts is a vital point for partnership, not only because the long-term agreement between parties is binding regulated, but also because the complexity and the punctuality of items to be agreed among parties that should be mentioned in the PPP contract. In this context, respondents were requested to express their agreements on the level of knowledge for tendering and negotiation in a PPP project. Respondent's answers are shown in Figure 5-20 below.

About one-half (44.7%) of public sector respondents mostly disagree on this question. This indicates that public sector lack the required knowledge for tendering and negotiation. This result seems to in line with previous results of this research, lack of knowledge and no experience in PPP projects will lead to a weak negotiation by the public sector. In fact, first step to a successful negotiation is thorough tender documentation preparation. The more issues that are appropriately covered in the tender documentation means fewer items will be subject to negotiations after bids have been received. In a closer examination of Figure 5-20, it can be concluded that near one-half

(63.8%) of the public sector respondents disagree on this question, by answering "completely disagree", "mostly disagree" or "slightly disagree".

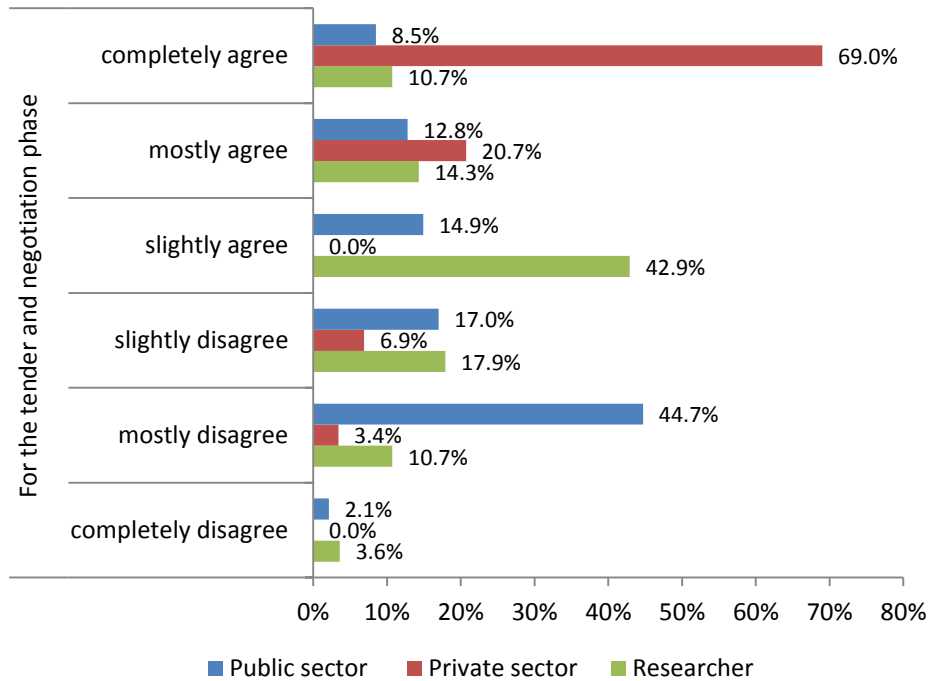

Figure 5-20: Knowledge for tendering and negotiation in PPP project (n: 47/29/28)

Moreover, (69%) of private sector respondents completely agree on this question, this indicates that private sector has the required knowledge for tendering and negotiation due to the previous experience in PPP projects.

Add to this, (42.9%) of Academic respondents slightly agree on this matter, It can be seen that Academic respondents have more knowledge for PPP tendering and negotiation than public sector, this may be due to that Academic deal with PPP theme in their lectures as well as most of the Academic working as a consultant for the public side. Findings illustrates that near two-third (67.9%) of Academic respondents agree on this question, by answering "completely agree", "mostly agree" or "slightly agree".

5.1.3.3.4 Commitment with Private Financing (No4)

Due to the structure and nature of PPP, involves both public and private sectors for a long-term contractual period; which spans through many regulatory regimes; construction of infrastructure projects through the public private partnership requires high commitment from both parties. In most cases, the length of the long-term binding partnership is greater than the political mandate of the regime that entered into the partnership. In that case, if there are differences in the objectives or preferences of the incumbent and the successive regimes, the successive regimes will have the

incentive to renege on the commitment of by previous regime. Chan *et al.* (2004)⁴⁴⁴ and Li *et al.* (2005)⁴⁴⁵ claimed that commitment in PPP is one of the fundamental principles in partnership. Hence, to secure a successful PPP, all parties have to commit their best resources to the project.

As a part of the respondent’s knowledge and capacity-building measurement, respondents were requested to express their agreements on the level of commitment with the other parties in a PPP project. Respondent’s answers are shown in Figure 5-21.

Near one-half (55.6 %) of public sector respondents completely agree on this question. The emphasis of respondents on this factor revealed that the public sector in Iraq aware the purpose of adopting PPP procurement and that commitment is essential to ensure goals of the PPP projects.

For PPP to take place, it is important for the private investors to believe that government is committed to fulfilling the incentives that are finally adopted for the partnership. If governments are able to alter their commitments unilaterally; at the detriment of the private investors; the private investors would end up with an unfavorable payoff.⁴⁴⁶

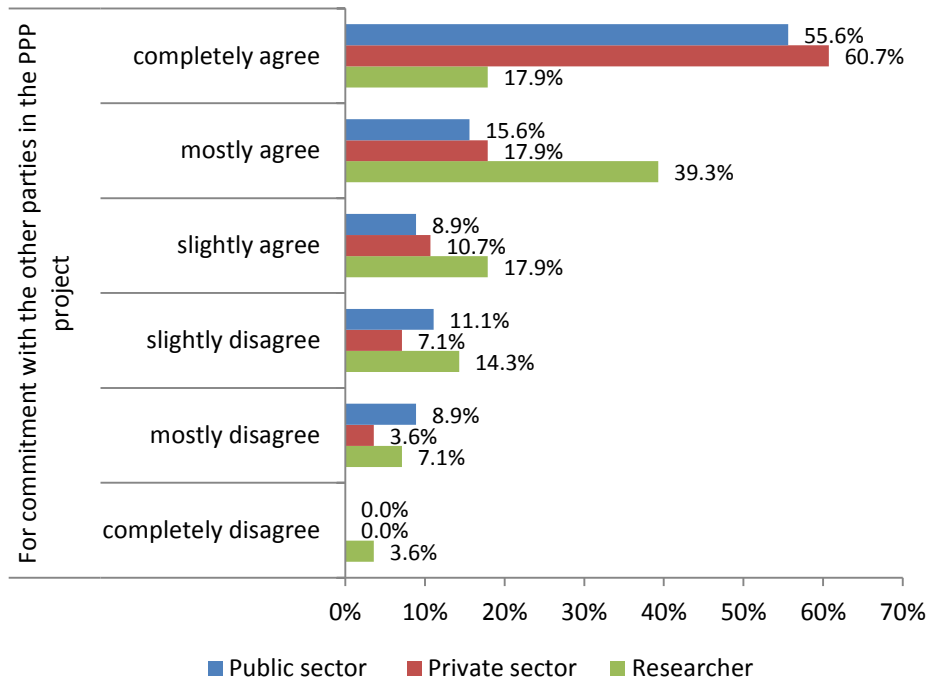

Figure 5-21: Commitment with the other parties in PPP project (n: 45/28/28)

⁴⁴⁴ Chan, K. C., Chen, C. R. and Steiner, T. L.: Research Productivity of the Finance Profession in the European Region. *Journal of Business Finance and Accounting*, Vol. 31 (3 & 4), 2004, P. 177–213.

⁴⁴⁵ Li, B., Akintoye, A., Edwards, P. J., and Hardcastle, C.: Perceptions of Positive and Negative Factors Influencing the Attractiveness of PPP/PFI Procurement for Construction Projects in the UK- Findings from a Questionnaire Survey. *Journal of Engineering Construction and Architectural Management*, Vol.12 (2), 2005, P.125–148.

⁴⁴⁶ Anthony T, Odoemena and Masahide Horita: Government Commitment and Dynamic Inconsistency in Public-Private Partnership for Infrastructure.10th Conference on Applied Infrastructure Research, University of TOKYO, 2011.

Furthermore, private sector shows high commitment level, about two-third (60.7%) of private sector respondents completely agree on this question. For the private party, commitment fees are paid on the available but undrawn portion of the debt during the construction period (*i.e.* so long as drawings may be made on the loan). As most project finance loans are drawn very slowly (during, say, a 2-3 year construction period) banks need the commitment fee to give them a reasonable rate of return on their risk during the construction of the project when they are not earning the full loan margin. Commitment fees are usually around half of the credit margin in project-finance loans.⁴⁴⁷

By contrast, near one-third (39.3%) of Academics respondents mostly agree on this matter, this differences between groups answers may be due to the respondents different background and the way of understanding the commitment concept.

5.1.3.4 Comparing PPP with Traditional Procurement Methods (Question 11)

Table 5-7 shows responses of question “How would you compare PPP with traditional procurement methods?”. Overall survey respondent found that the main difference between PPP and traditional projects is that in a PPP project there is the added advantage of the private sector’s efficiency/expertise/ skills involved. From previous literatures^{448 449 450} it has also been recorded that one of the main advantages of involving the private sector is to add value to public projects in terms of their efficiency, expertise and management skills when compared to those of the public sector. Therefore Gol could consider whether this added advantage is required from the private sector when they consider whether or not to opt for the PPP model in their public work projects.

Factors	Code	Public			Private			Researchers			Overall		
		N	Mean	Rank	N	Mean	Rank	N	Mean	Rank	N	Mean	Rank
Using a Public Sector Comparator (PSC)	C1	45	2.44	5	24	3.79	5	22	3.63	5	98	3.13	5
Tendering and negotiation for PPP are longer	C2	47	4.17	4	29	5.14	2	27	4.07	4	103	4.42	4
PPP projects utilize private sector finance/difference in finance structure	C3	48	5.35	2	30	5.13	3	26	4.88	2	104	5.17	2
Difference in risk profile	C4	47	4.70	3	30	5.27	1	28	4.86	3	105	4.9	3
PPP projects utilize private sector expertise and skills	C5	48	5.5	1	30	4.93	4	28	5.25	1	106	5.27	1

Table 5-7: Methods of comparing PPP with traditional procurement

⁴⁴⁷ Yescombe, E.R.: Public-Private Partnerships – Principles of Policy and Finance. Elsevier Ltd, UK, 2008.

⁴⁴⁸ Previous reference.

⁴⁴⁹ Carrillo, P., Robinson, H., Foale, P., Anumba, C., Bouchlaghem, D.: Participation, Barriers and Opportunities in PFI-The United Kingdom Experience. Journal of Management in Engineering, ASCE, Vol. 24(3), July 2008, P.138-145.

⁴⁵⁰ Leiringer, R.: Technological Innovation in PPPs- Incentives Opportunities and Actions. Journal of Construction Management and Economics, Vol. 24, March 2006, P. 301-308.

This was flowed by answers that PPP projects utilize private sector finance/ difference in finance structure. This finding shows the importance of the different financing structure provided by PPP projects. Although finance should not be the main reason for adopting PPP projects, undoubtedly, financial drive is still an attractive factor to governments, hence this response was unsurprising. The third method according to overall responses included “Difference in risk profile”, as mentioned previously in this research one of the main reasons for implementing public projects by PPP is also for risk transfer. The preferred methods of comparing PPP with traditional procurement for each survey group are shown in Figure 5-22. Again these could be used as indications to which method to opt for.

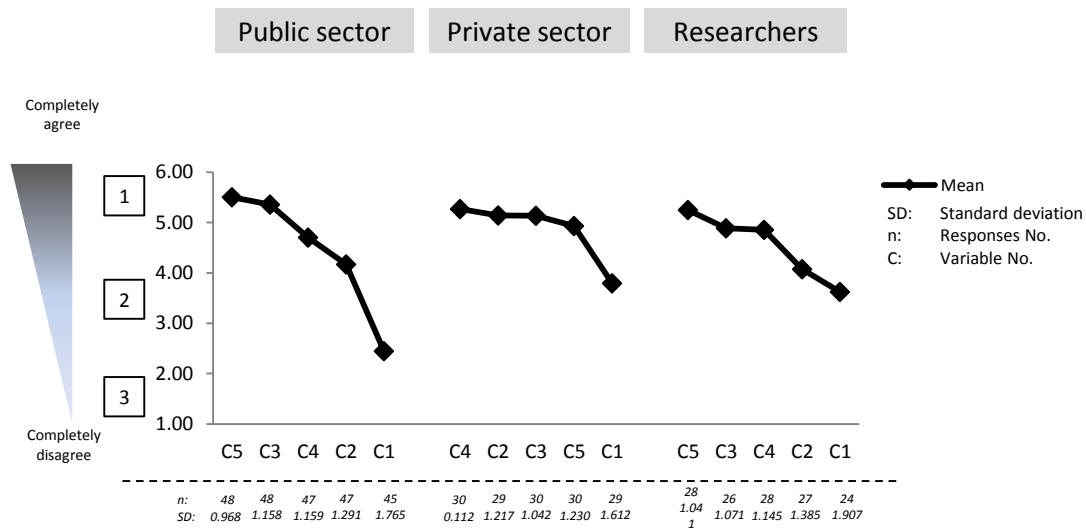

Figure 5-22: Comparing PPP with traditional procurement among survey groups

To test the agreement among survey groups respondents on methods of comparing PPP with traditional procurement, Kolmogorov - Smirnov (KS) test is used; it is found that the collected data are not following a normal distribution.⁴⁵¹ With this line the non-parametric Kruskal Wallis test is performed. The null hypothesis is that the medians significance of each factor is equal among the three groups. Findings indicate that there is a significant agreement among the survey groups for two methods of comparing PPP with traditional procurement; these are “PPP projects utilize private sector finance/difference in finance structure” and “Difference in risk profile”. Furthermore, there is disagreement at three factors, these are “Using a Public Sector Comparator (PSC)”, “Tendering and negotiation for PPP are longer “ and “PPP projects utilize private sector expertise and skills”. Table 5-8 shows the test results.

⁴⁵¹ See Appendix C.

Again, as the sample sizes in each group is larger than 5, ⁴⁵² H is represented by chi-square and p-value is labelled as “Asymp Sig.” as shown in the SPSS output, explaining that the probability of getting a particular value of H is the p-value corresponding to a chi-square; with degrees of freedom (df) of n-1.⁴⁵³

	Using a Public Sector Comparator (PSC)	Tendering and negotiation for PPP are longer	PPP projects utilize private sector finance/difference in finance structure	Difference in risk profile	PPP projects utilize private sector expertise and skills
Chi-Square (H)	11.483	12.151	5.274	5.432	6.473
degree of freedom (df)	2	2	2	2	2
Asymp. Sig.(p- value)	0.003	0.002	0.072	0.066	0.039

Table 5-8: Kruskal Wallis test results for methods of comparing PPP with traditional procurement

5.1.3.5 Availability of PPP Legal Framework (Question 12)

According to the European Bank for Reconstruction and Development (EBRD), PPP projects tend to work best when a good legal framework exists. Bennett (1998)⁴⁵⁴ noted that an enabling regulatory and legal environment is the cornerstone of sustainable private sector participation in urban infrastructure services. For the past thirty years Iraq was a largely state-run economy with minimal private sector participation. Centralized decision making and a state with a dominant position in the direct production of goods and services have resulted in a business environment that severely disadvantages private sector development across the country. With a given statement, the survey groups were asked to express their agreements level about if they consider the current Iraqi legal framework suitable for PPP projects.

Figure 5-23 shows means and standard deviations of respondent’s answers.

⁴⁵² See Section 4.5.4.

⁴⁵³ For excellent discussion, See (Berenson *et al.* 2009).

⁴⁵⁴ Bennett, E.: Public-private Cooperation in the Delivery of Urban Infrastructure Services (Water and Waste). Background paper- Public Private Partnerships for Urban Environment Programme (PPPUE), United Nations Development Programme, UNDP, New York, 1998.

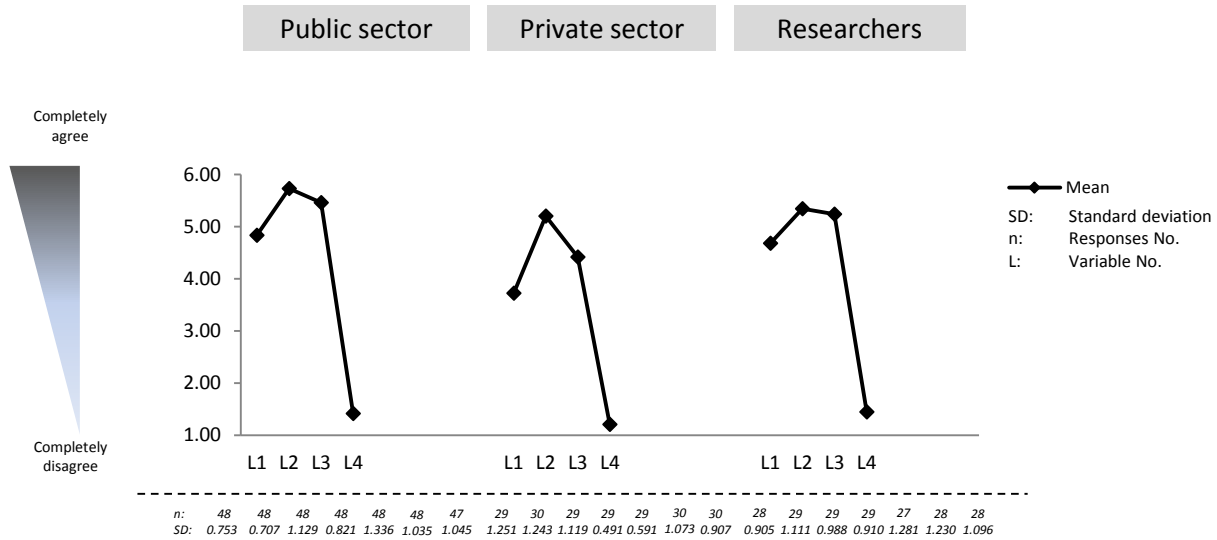

Figure 5-23: Suitability of current legal frame work

5.1.3.5.1 Regulation clearly defining the rights and obligations of private investors (L1)

In general, one-half (51%) of overall respondents mostly agreed that the current existing regulation in Iraq is clearly defining the rights and obligations of private investors, as shown in Figure 5-24. This indicates that, despite the substantial progress that already have been made by the Gol to develop a good legal framework, there is still a further need to improve the Iraqi regulation and legal framework. The private sector in Iraq is still suffering from a set of problems and impediments to its development including, but not limited to, inappropriate legislative and regulatory framework and lack of enforcement of the existing framework.

Furthermore, about (71%) of public sector respondents mostly agree on this matter. From the perspective of the public sector, several laws that went into effect since 2003 improved some of Iraq's legal environment and changed the legal regime with respect to attracting investment, giving investors national treatment with regard to their investments, such as:

- Trade Liberalization Policy Law No. 54 of 2004;
- The Central Bank Law No. 56 of 2004;
- Law No. 64 of 2004, Amending Company Law No. 21 of 1997;
- Interim Law on Securities Market No. 74 of 2004;
- Law No. 80 of 2004, Amending Trademarks and Descriptions Law no. 21 of 1957;
- Patent, Industrial Design, Undisclosed Information, Integrated Circuits And Plant Variety Law No. 81 of 2004;
- The Banking Law No. 94 of 2004; and Insurance Regulatory Law No. 10 of 2005;
- Investment Law No. 13 of 2006; and Kurdistan Investment Law No. 4 of 2006;
- Private Investment In Crude Oil Refining Law No. 64 of 2007.

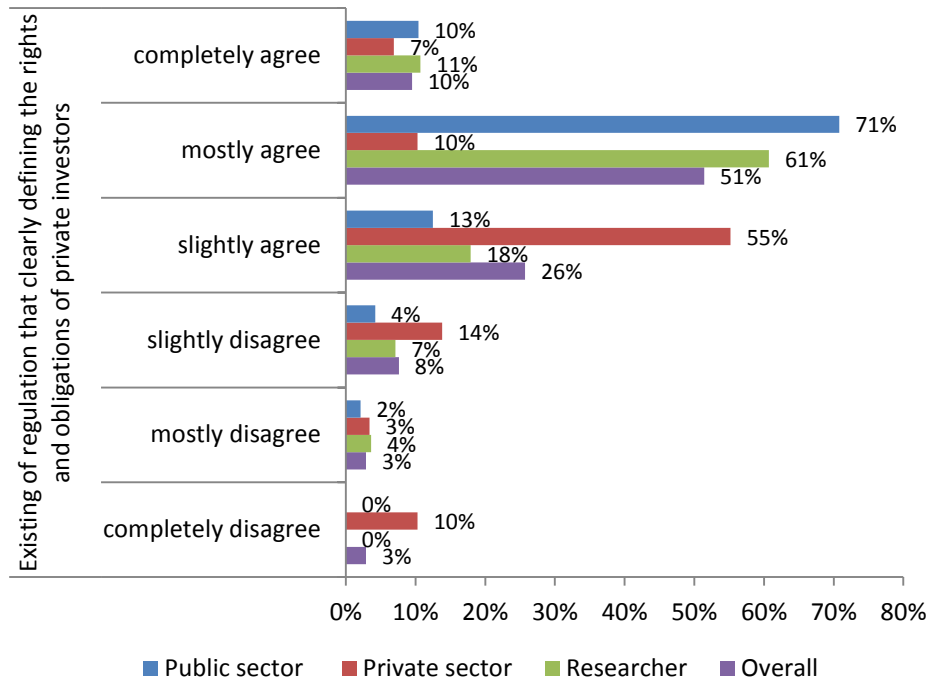

Figure 5-24: Existing legal framework for a PPP project (n: 48/29/28)

In addition to, in February 2010 Iraq concluded a Stand-By Arrangement (SBA) with the International Monetary Fund (IMF) that details further economic reforms. This legislation includes the establishment of a modern legal framework to allow Iraq to develop its resources.

the other hand, Iraq is signatory to a number of international investment agreements (IIAs), including 32 bilateral investment-related treaties and nine multilateral agreements further to the Investment Promotion and Protection Agreement promulgated by the Arab League's Council of Arab Economic Unity. Several of these agreements contain provisions for promoting and protecting investments that include the treatment of investments and investors (most-favored-nation (MFN) and national treatment clauses), fair and equitable treatment, repatriation of profits, dispute settlement (State-State and investor-State), protection against expropriation, and compensation of losses. Iraq also negotiated bilateral investment agreements in 2009, including with France, Germany and Italy. It is also negotiating a framework agreement with the European Union (EU).⁴⁵⁵

Furthermore, about one-half (55%) of private sector respondents slightly agree on this question, this may be indicate that the current existing regulation in Iraq; despite current reform; do not meet their ambitions, where investors in Iraq; still facing complex procedures under various laws, regulations and administrative requirements, which effect on their rights and obligations. as well as, the unclear and excessive regulations. The result is not only bureaucratic inertia, but also increased costs and time delays for business that ultimately are hurting the economy. Add to this, (61%) of Academic respondents mostly agree on this matter, which indicate that they agree with the public sector perspective.

⁴⁵⁵ OECD: Private Sector Development in the Middle East and North Africa- Supporting Investment Policy and Governance Reforms in Iraq. 2010 . www.oecd.org/publishing/corrigenda.

5.1.3.5.2 Judicial independence from government influence (L2)

In general, judicial independence means that judges are not subject to improper pressure and influence, and are free to make impartial decisions based solely on facts and law. In other words, judicial independence is the public's guarantee that a judge will be impartial. In line with this context, survey respondents were asked to show their agreement level about the judicial independence from government influence. Figure 5-25 shows respondents' answers.

More than two-third (74%) of overall survey respondents were completely agree that the judges are not subject to the direction or control of either the executive or legislative branch of the Iraqi government. As perceived by the survey respondents, majority of public, private sectors and Academics respondents were completely agree on the judicial independence from government influence with (85%), (63%) and (66%) respectively.

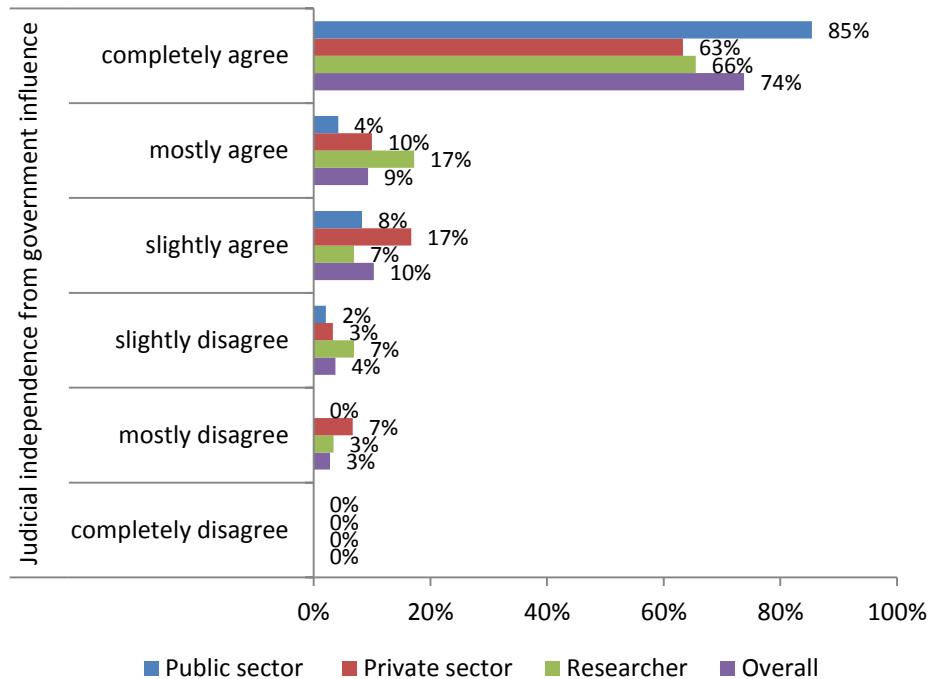

Figure 5-25: Judicial independence from government influence (n: 48/30/29)

5.1.3.5.3 Regulatory commitment sustained through long-term contract (L3)

A commitment legal and regulatory framework is essential to the proper implementation level of PPP project. Governments that interested in conduct PPP, can not only formulate policies, supports and legal framework for PPPs, but also translate these policies and supports into an sustained commitment in legal and regulatory framework through long-term, to enhance PPPs in their countries. Figure 5-26 below shows the survey respondents' answers about the Iraqi regulatory commitment in PPP.

Near one-half (55%) of overall respondents completely agree that the Iraqi regulatory commitment is sustained through long-term PPP contract. This again indicates that in order to encourage investors to participate in PPP contracts, more commitment is expected from the GoI. For the private investment, the best of a good legal framework is its clarity, the enforceability of contracts as well as regulatory sustainability, particularly contracts with government agencies.

Add to this, majority of public sector respondents about (73%) completely agree on this question, whilst (55%) of private sector respondents slightly agree on this question. This, once again, reflects the deep concerns held by the private sector regarding the commitment and sustainability of regulation in Iraq. This probably because that many of the laws and reforms in Iraq are new or experimental and are expected to be refined or changed. This leads to a factor of risk playing a major role in Iraq. In particular, investors base long-term investment decisions on the reliability, applicability, and enforceability of laws and contracts. To have some assurance that these investments will succeed, investors want to see that the regulatory commitment is sustained through the long-time span of the PPP contract, and that applicable laws and contracts are enforced.

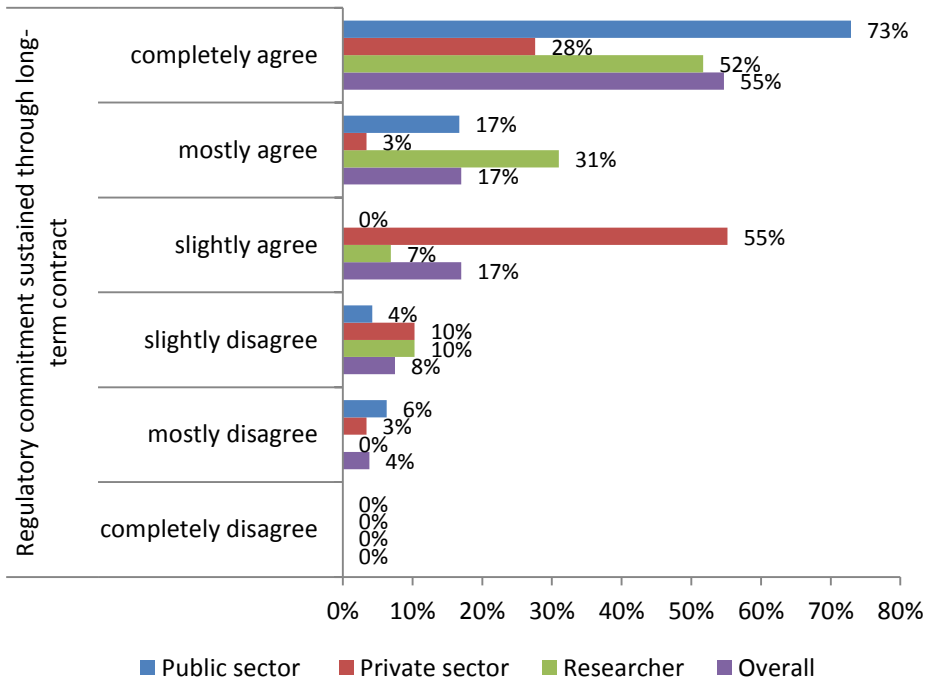

Figure 5-26: Regulatory commitment sustained through long-term PPP contract (n: 48/29/29)

Based on the results in Figure 5-26, one-half (52%) of Academics responses were completely agree on this question, it can be concluded that Academics also consider commitment and sustainability of regulation in Iraq is not at a good level.

5.1.3.5.4 Existence of regulation defining PPP contracts (L4)

In many cases a PPP project agreement; no matter how well drafted; may be unenforceable and irrelevant if it is inconsistent with the country's laws and regulations. The existing laws and regulations may prohibit or impede the proposed PPP project and so the project may need to be adapted to fit within them. In this case, it may be appropriate to embark on more fundamental reforms of the institutions in the country such as reform of the judiciary/ establishment of a regulatory regime. In this context, survey groups were asked to express their agreements level about if there is an existence of regulation that clearly defining PPP contracts, forms and requirements. Respondents' answers are shown in Figure 5-27.

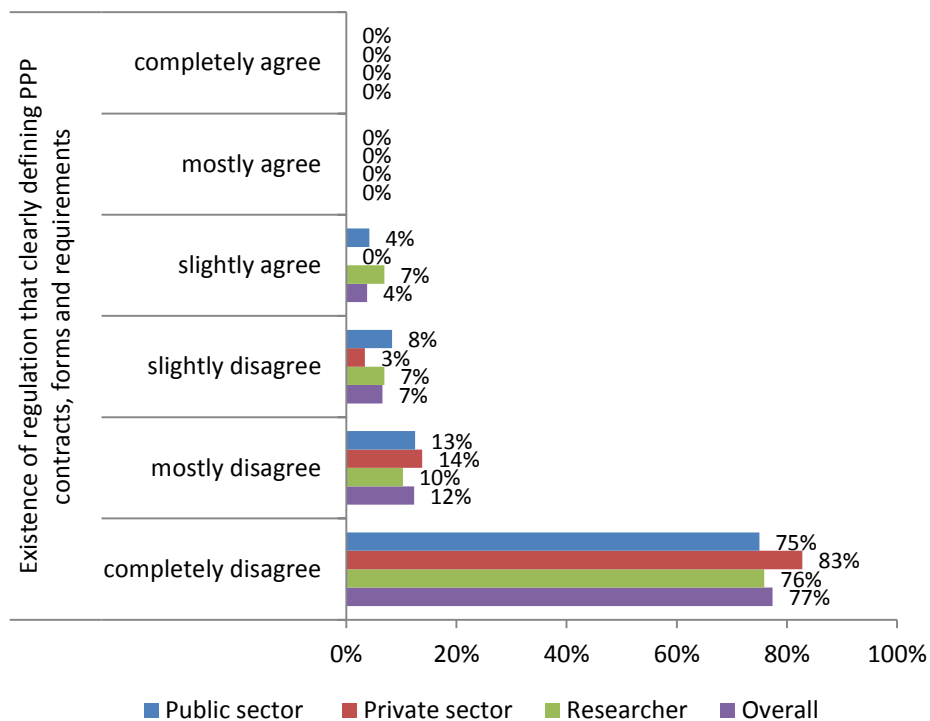

Figure 5-27: Existence of regulation defining PPP contracts, forms and requirements (n: 48/28/28)

(77%) of overall respondents were completely disagree on this question, indicating that despite the importance of a legal framework for PPP implementation, there is no specific legal framework serve as a fundament for PPP contracts between the public and the private sectors for PPP projects in Iraq. And the current legal framework is only supposed to deal with the traditional command and control model. Projects procured under PPP are based on a wide variety of law blended together, including legislation relating to planning and the environment, employment, health and safety, corporate and commercial law, construction, finance and insurance.⁴⁵⁶

⁴⁵⁶ Zimmermann Josef, Aljuboori Omar: The Challenges of Governing Public Private Partnerships in Iraq Infrastructure Projects. Creative Construction Conference, Budapest, Hungary, 2013.

Furthermore, while the current Iraqi Public Companies Law No. 22 of 1997 allows some forms of PPP (mixed companies, production sharing agreements etc); there is a need to establish a clear and comprehensive legislative and regulatory framework. For this purpose, a draft framework law applicable to all economic sectors, including infrastructure, along with specific regulations for public procurement, was prepared by UNIDO (with support by the World Bank) and is currently under review by the Working Group for Legislation of the Task Force for Economic Reforms (WGLTFER). Consultations with the private sector will be organized to receive feedback and recommendations.

As perceived by the survey respondents, majority of public, private sectors and Academics respondents were completely disagree on this question with (75%), (83%) and (76%), as shown in Figure 5-27. In general, a legal and regulatory framework that supports PPPs is meant to facilitate investments in complex and long-term PPP arrangements, reduce transaction costs, ensure appropriate regulatory controls, and provide legal and economic mechanisms to enable the resolution of contract disputes.

5.1.3.6 Government Support (Question 13)

To attract private sector investors, host governments often provide financial support packages. These supports may take on several forms from a comfort letter, capital contribution (equity/debt/subordinated debt participation), preferential tax treatment, grant/subsidy and guarantees. Legally, governments' obligation to provide support can be defined in laws, decrees, statues, licenses, concessions, contracts or other legally binding documents.⁴⁵⁷ Figure 5-28 illustrate survey groups' valuation on Gol supports in PPP projects.

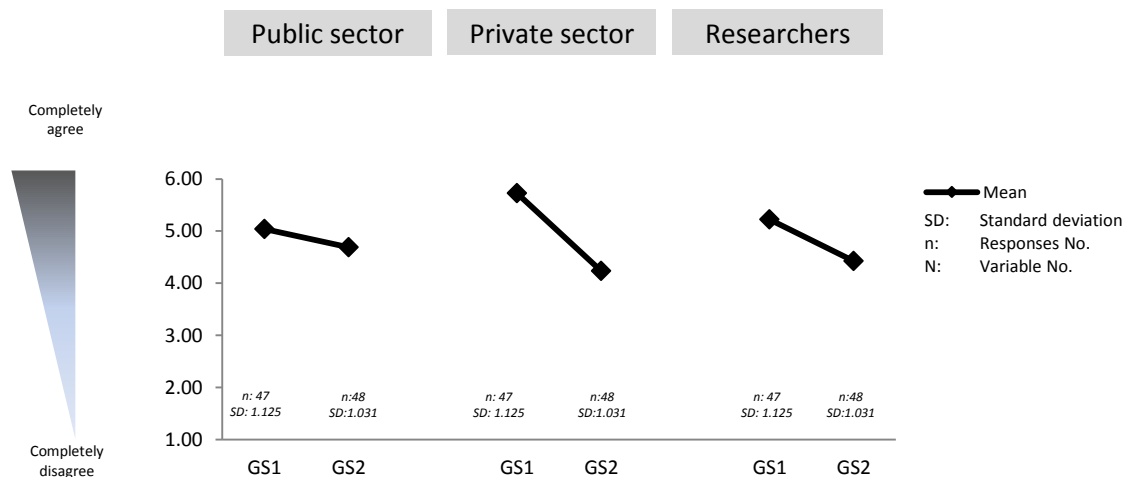

Figure 5-28: Valuation of Gol supports in PPP projects among survey groups

⁴⁵⁷ Dailami, M. and Leipziger, D.: Infrastructure Project Finance and Capital Flows- A New Perspective. Policy Research working paper No. 1861, World Bank, Washington, DC, 1997.

As indicated in Figure 5-29, (63%) of overall respondents reply that there is a very high need for the government support in conducting PPP project in Iraq. This is probably because of the unstable security situation and political problems in Iraq, which make the investors asking for more support from Gol. Moreover; as perceived by the public sector respondents; (52%) of public respondents reply that there is a very high need for the government support in PPP project in Iraq.

Although private sector respondents present more request than their public sector counterparts, with (79%) of private respondents reply that there is a very high need for the government support. From the Academics perspectives, (63%) of the Academics respondents seen that there is a very high need for the government support.

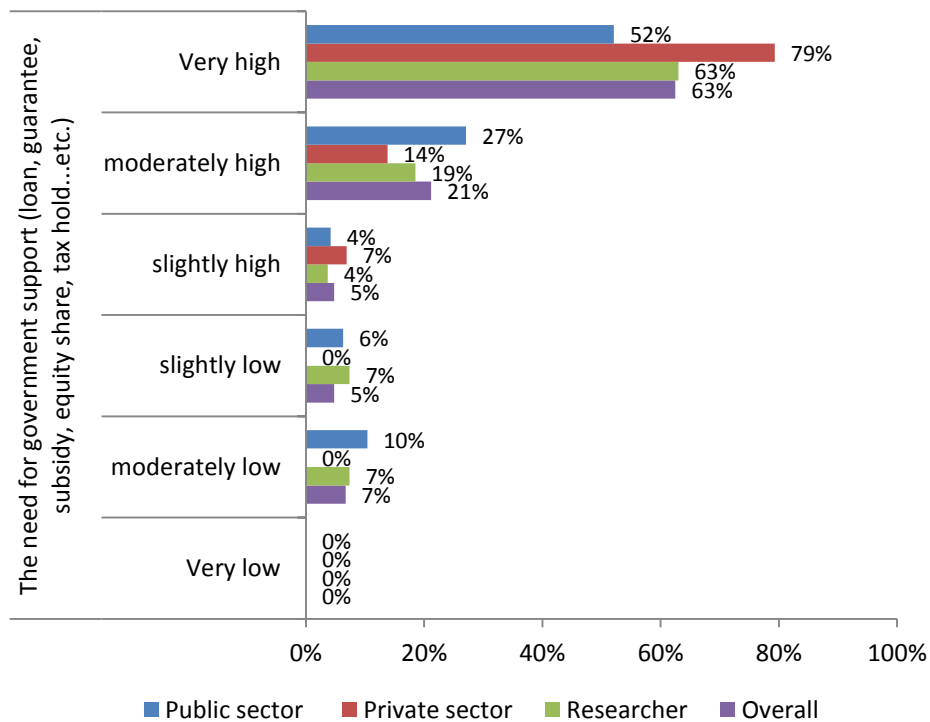

Figure 5-29: The need for government supports in PPP projects (n: 48/29/27)

Furthermore, as a part of the government support evaluation, survey groups were asked to evaluate current level of Gol supports in PPP projects. Respondents' answers are shown in Figure 5-30. In general terms, (50%) of overall respondent's replay that the Gol level of support is moderately high. This is probably due to the wide range of supports and guarantees that have been made in the investment law No.13 of 2006.

Moreover according to findings in, (65%) of public respondents reply that the current Gol support is moderately high, whilst private sector respondents present more disagreement than their public sector counterparts, (53%) of private sector respondents reply that the current Gol support is slightly high. So, the explanation that could be offered herein is that the private sector seeks more support from Gol and that the current level of support; according to private sector perspective; is

perceived inadequate. From Academics perspectives, (57%) of the Academics respondents seen that there is a moderately high need for the government support.

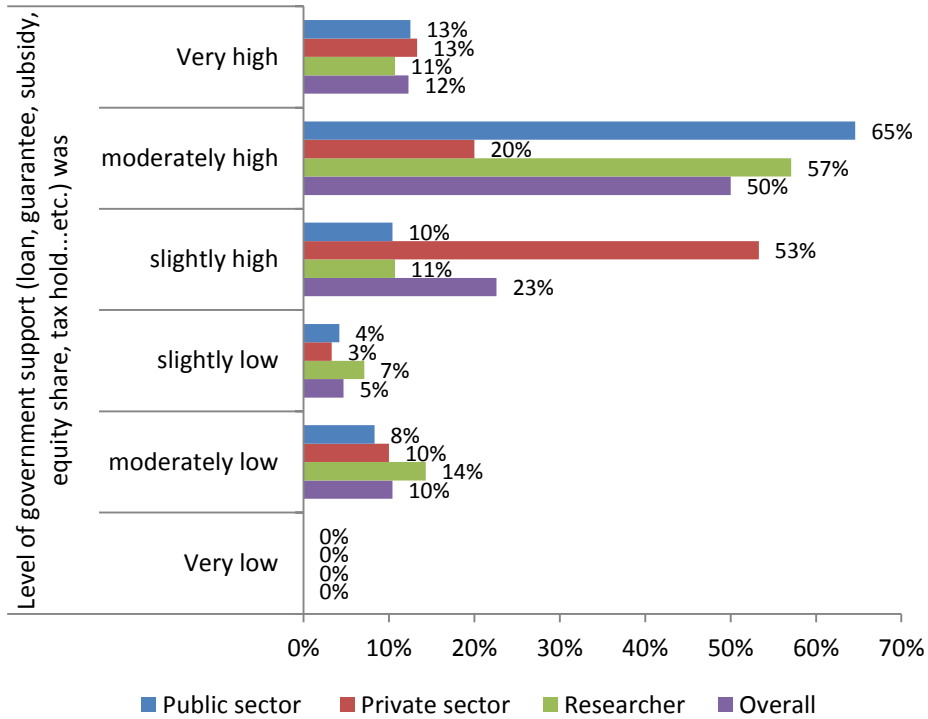

Figure 5-30: Level of government supports in PPP projects (n: 48/30/28)

5.1.4 Major risk Factors of PPP Projects in Iraq (Section 4-Q.13)

Redmill (2012)⁴⁵⁸ explained that the purpose of identifying the source of risk is to prevent the events that can go wrong and lead to breaches of safety. Shen (1997)⁴⁵⁹ argued that the purpose of risk identification is not only to identify a list of risk factors but also to identify the importance of those risk factors.

This part aims to assess the importance of several major risks associated with Iraq’s PPP projects. 30 risk factors of a PPP projects had been identified through the literature review performed for this study were presented in the questionnaire. These are classified by projects phases: development phase construction phase, operation phase, project life cycle. In this part, survey respondents were asked to rate the importance of these identified risks based on their perception and experience with Iraq PPP projects, on a likert scale from “1=Least Important”, to “6=Most Important” with an option of “0= Do not know/ Not applicable”.

⁴⁵⁸ Redmill F.: Risk Analysis- A Subjective Process. Journal of Engineering Management, Vol.12 (2), 2012, P. 91–6.

⁴⁵⁹ Shen YL.: Project risk management in Hong Kong. International Journal of Project Management, Vol. 15(2), 1997, P.101–5.

A three-level data analysis framework was adopted. At the first level, the individual risk factors are ranked in descending order of the mean scores on the perceived risk significance to identify the important risk factors. This indicates an overall picture of the perceptions of different respondents on the risk significance. At the second level, the agreement cum consistency of respondents' perceptions within a particular group is checked by the Kendall's concordance analysis. Finally, at the third level, the Kruskal Wallis and Mann–Whitney U tests are applied to enable groups comparisons to identify if there is any individual risk factor on which different perceptions between any two groups of respondents are placed.

As mentioned previously the data collected from the current questionnaire survey was analyzed using “mean score” (MS) technique to establish the relative importance of risk factors. The six-point Likert scale was used to calculate the mean score for each risk factor, which was then used to determine its relative ranking in descending order of importance. These rankings made it possible to triangulate the relative importance of the risk factors.

Table 5-9 exhibits the calculated mean scores and the corresponding standard deviation and ranks for each risk factor as viewed by the three groups of respondents. As the standard deviation is relatively small for all risk factors, it indicates that scores are close to the mean, and therefore, the mean is a good indicator of the "average" score. The results indicate that all 30 risk factors are perceived by respondents as either ‘very important’ or ‘important’ to ensure the success of PPP projects implementation since the mean scores for the risk factors range from 4.18 to 5.81.

It is worth noting that the respondents did not suggest any additional risk factors, thereby confirming that all relevant project risks have been identified.

5.1.4.1 Overall Respondents’ Perceptions Concerning the Importance of risk factors

Based on the overall respondents’ results, the top five most critical factors in Iraq, in descending order of importance are:

1. Government stability/ civil disturbance/ security,
2. Administrative efficiency/ delay of approvals,
3. Land acquisition/ compensation time and cost,
4. Poor public decision-making process, and;
5. Availability of financing.

The two factors that were ranked as a least important of risk factors are: “Changes in currency exchange rates”, and “Inflation rate”. This does not mean that “Changes in currency exchange rates”, and “Inflation rate” are not an important factors for implementation PPP in Iraq, as this could be due to the fact that project financing in Iraq’s PPP projects continues to be with foreign currency denominated (mostly with US dollar), which means these risk factors is being perceived as relatively less importance.

Project phases	Code	Risk Factors	Public sector (A)				Private sector (B)				Researchers (C)				Overall			
			N	Mean	SD	Rank	N	Mean	SD	Rank	N	Mean	SD	Rank	N	Mean	SD	Rank
Development phase	R1	Administrative efficiency/ delay of approvals	48	5.52	1.052	4	29	5.41	1.086	2	29	5.62	0.862	1	106	5.52	1.007	2
	R2	Non Competitive tender/ Inadequate competition	48	4.96	1.110	19	29	4.93	1.252	18	29	5.03	1.322	16	106	4.97	1.199	18
	R3	Land acquisition/ compensation time and cost	48	5.46	0.967	6	29	5.48	0.785	1	29	5.48	1.243	7	106	5.47	0.997	4
	R4	Social/Cultural acceptability of the project	47	4.81	1.362	22	29	4.59	1.119	26	28	4.93	1.331	17	104	4.78	1.284	22
	R5	Corruption/ transparency of public administrative	47	5.30	1.214	14	29	5.31	1.105	6	28	5.50	1.106	6	104	5.36	1.148	8
	R6	Availability of financing	48	5.52	0.945	3	29	5.34	1.233	4	28	5.43	0.997	10	105	5.45	1.038	5
	R7	High bidding cost	48	5.06	1.080	18	29	5.14	1.060	11	27	4.74	1.259	22	104	5.00	1.123	17
Construction phase	R8	Design and construction changes	48	5.35	1.041	12	28	4.86	1.353	19	28	5.25	1.110	14	104	5.19	1.158	14
	R9	Construction time and cost	48	5.46	0.824	7	28	5.29	0.976	7	28	5.29	0.937	13	104	5.37	0.893	7
	R10	Unproven engineering technique or technology	48	4.71	1.271	23	28	4.64	1.339	24	28	4.71	1.512	23	104	4.69	1.344	24
	R11	Geotechnical conditions	47	4.55	1.299	26	27	4.70	1.203	23	28	4.79	1.371	21	102	4.66	1.286	26
	R12	Labour /Material unavailability	48	4.92	1.302	20	27	5.11	1.155	13	27	4.85	1.512	19	102	4.95	1.315	20
Operation phase	R13	Operation quality /Low productivity	48	5.52	1.091	2	29	5.10	1.291	14	28	5.54	0.999	4	105	5.41	1.133	6
	R14	Market demand	48	5.40	1.144	9	29	5.00	1.000	16	28	5.46	1.201	9	105	5.30	1.128	11
	R15	Operation and maintenance time and cost	47	5.40	0.948	8	29	4.79	1.048	21	28	5.32	0.983	12	104	5.21	1.011	12
	R16	Tariff -setting uncertainty / revenue loss	47	5.26	1.224	16	29	5.17	0.658	10	28	4.82	1.467	20	104	5.12	1.177	15
	R17	Fuel availability	48	5.31	1.151	13	29	5.14	0.953	11	28	4.61	1.286	26	105	5.08	1.166	16

Project life cycle	R18	Environmental risk	47	4.40	1.570	29	29	4.62	1.015	25	28	4.50	1.291	28	104	4.49	1.351	28
	R19	Less residual value	48	4.81	1.249	21	28	4.46	1.347	28	28	4.68	1.389	24	104	4.68	1.309	25
	R20	Poor public decision-making process	48	5.48	0.799	5	29	5.38	1.147	3	28	5.61	0.737	2	105	5.49	0.889	3
	R21	Expropriation/nationalization	47	5.19	1.135	17	30	4.93	1.202	17	28	4.57	1.399	27	105	4.95	1.243	19
	R22	Change in legal and regulatory framework	47	5.36	1.187	11	30	5.20	0.997	9	28	5.50	0.793	5	105	5.35	1.038	9
	R23	Change in tax regulation	48	4.52	1.414	27	29	5.10	0.860	14	28	5.04	1.201	15	105	4.82	1.246	21
	R24	Non-political force majeure	47	5.26	1.170	15	29	5.28	1.066	8	28	5.46	1.138	8	104	5.32	1.126	10
	R25	Third party liability	46	4.57	1.377	25	30	4.83	1.037	20	28	4.89	1.343	18	103	4.73	1.277	23
	R26	Lack of commitment from public or private partner	47	5.38	0.990	10	30	4.73	1.461	22	28	5.39	0.994	11	105	5.20	1.172	13
	R27	Inflation rate	48	4.42	1.350	28	30	4.43	1.135	29	28	4.46	1.644	29	106	4.43	1.366	29
	R28	Changes in interest rate	48	4.71	1.383	24	30	4.57	0.971	27	28	4.64	1.569	25	106	4.65	1.324	27
	R29	Changes in currency exchange rates	48	4.33	1.389	30	30	4.33	1.348	30	28	4.18	1.492	30	106	4.29	1.394	30
	R30	Government political instability /Civil disturbance/ security	47	5.81	0.680	1	29	5.33	0.711	5	29	5.57	0.997	3	105	5.61	0.803	1

Table 5-9: Perception of survey respondents concerning the relative importance of risk factors in PPP Projects

“Government stability/ civil disturbance/ security” were ranked first as a necessary factor to ensure the success of PPP projects. Government stability measures the government’s ability to carry out its policies and to stay in office.⁴⁶⁰ Furthermore, interviews and surveys of executives of multinational corporations have found political events to be one of the most important factors in foreign investment decision.⁴⁶¹ ⁴⁶² In particular, executives cite the stability of the host government and the attitude of the host government toward to investment as most important considerations in the investment decision. According to the Asian Development Bank (ADB),⁴⁶³ the government, as a political decision maker, has to set out the case for PPP in a convincing and transparent manner and any political changes can hinder the PPP implementation. In other words, politics has a close relationship with the development and implementation of public policy.⁴⁶⁴

In Iraq, despite the improvements in the security and political situation at the last ten years, Iraq is still suffering from civil disturbance and security problems in different cities. Most investors consider the stability of Iraq is one of the most important determinants in investment decision making. Such concern is due to the belief that unpredictability and volatility in the political environment of Iraq market increases the perceived risk and uncertainty experienced by the firm. In turn, this disinclines firms from entering in contractual commitments.

The “Administrative efficiency/ delay of approvals” is the second most important risk factor, as perceived by the overall respondents. In general, inefficient organization can result in increased costs to the project, and a lack of definition and transparency in government processes can increase uncertainty for investors and developers and multiply costs or delay or halt projects.⁴⁶⁵

On the other hand, delay in approval means that the central or local government authority does not approve the project–related issues in time or even cancels the already approved ones. Obtaining approvals for a project from a complex web of government agencies and departments, from municipal to provincial to central government levels, can be a time-consuming process. In Iraq, the country’s institutional capacity, although improving, remains weak and uneven. This adds to business costs, hurts the quality of governance and increases inefficiency. Moreover, the lengthy approval process is related to the procedures and laws controlled by the GoI, and it is mostly due to several causes such as the unprofessional and incompetence of the government officials, complex and bureaucratic approval procedures, poor implementation of the law and regulations by the government, and decentralization with unclear responsibility provision which creates unnecessary requirements from many divisions and levels for just one simple problem in a project.

Starting a project in Iraq requires in average 11 procedures, takes 77 days, costs about 116% of income per capita and requires paid-in minimum capital of over 35% of income per capita.⁴⁶⁶ For comparison in the United Arab Emirates starting a project requires 7 procedures, takes 13 days, costs 5.6% of income per capita and requires no minimum paid-in capital.

⁴⁶⁰ www.prsgroup.com, Political Risk Services Group.

⁴⁶¹ Bass, B.M., McGregor, D.W. and Walter, J.L.: Selecting Foreign Plant Sites-Economic, Social and Political Considerations. *Academy of Management Journal*. Vol.20, 1977, P. 535-551.

⁴⁶² Schollhammer, H.: *Locational Strategies of Multinational Firms*. Los Angeles, Pepperdine University, 1974.

⁴⁶³ Asian Development Bank (ADB): *Public-Private Partnership Handbook*. Asian Development Bank, 2008.

⁴⁶⁴ Li, B., Akintoye, A., Edwards, P.J., & Hardcastle, C.: *Critical Success Factors for PPP/PFI Projects in the UK Construction Industry*. *Journal of Construction Management and Economics*, Vol. 23, 2005, P. 459-471.

⁴⁶⁵ World Bank: *PPP in Infrastructure*, Resource Center, www.Worldbank.com.

⁴⁶⁶ The World Bank: *Doing business in Iraq*. Washington, DC 20433, 2012. www.worldbank.org.

The third most important risk factor of PPP projects in Iraq, as perceived by the overall respondents, is the “Poor public decision-making process”, As it has been previously shown through this questionnaire results; there is no sufficient experience available at the Iraqi local authorities to support new business arrangement types as PPP. Therefore, most of these officials do not have the proper understanding regarding their post because their qualifications are mostly irrelevant and sometimes even under-qualified for their job positions. In addition to, Gol staffs who are involved in decision making of procurement are still “in the process of learning”. Now the evaluations depend solely on the opinion of the national investment commission (NIC) and the related ministry, who mostly don’t have the required technical experience in particular required for complex contracts like PPP.⁴⁶⁷ Recently, there are attempts to improve the Iraqi knowledge in PPP made by the World Bank and the United Nations Industrial Development Organization UNDO offering workshops to review other countries experiences.

The fourth most important risk factor of PPP projects in Iraq, as perceived by the overall respondents, is the “Land acquisition/ compensation time and cost”, Land acquisition risk has always been considered as one of the risk that could have a significant impact on the overall success of an infrastructure project. On-time land acquisition is very important since a slight delay in the acquisition of only a small area of the land that is a section of a project could affect the entire schedule and viability of the project.⁴⁶⁸

As argued by the World Bank, land and real estate typically account for between a half and three-quarters of Iraq’s asset value and constitute a major input to productive activities, whether in agriculture, industry or services. Where land is hard or excessively costly for investors to access, where land title is insecure, or where ownership rights are constrained by policy, a vital economic resource cannot yield its full benefit to citizens. For international investors in Iraq, delays associated with securing land access and obtaining building permits is a top concern and often a key deterrent to entering a market.⁴⁶⁹

The investment law No. 13; as mentioned previously in chapter three; did not refer to any mechanism or model of PPP. Moreover, according to the law the right to own land was restricted only to investors of residential projects.⁴⁷⁰ Furthermore, the law also permitted long-term leases, restricting to fifty (50) years. Thus project models like build-lease-operate-transfer (BLOT) and build-transfer-operate (BTO) became more appropriate. On the other hand, doing business report of World Bank 2012,⁴⁷¹ places Iraq at 98th of 183 countries rated on the “registering property” index. While property registration is not procedurally complex, it is time consuming (51 days) and costly compared to regional norms, consuming about 7% of property value. Insecurity of tenure or short-term rights can increase uncertainty and reduce incentives for investment. Furthermore, land and buildings are a primary form of collateral in Iraq, securing 42% of loans overall and 100% of loans for large enterprises.

⁴⁶⁷ Zimmermann Josef, Aljuboori Omar: The Challenges of Governing Public Private Partnerships in Iraq Infrastructure Projects. Creative Construction Conference, Budapest, Hungary, 2013.

⁴⁶⁸ Alfen, Hans-Wilhelm, *et al*: Public-Private Partnership in Infrastructure Development- Case Studies from Asia and Europe. Bauhaus-Universität Weimar, Faculty of Civil Engineering, Chair Construction Economics, 2009.

⁴⁶⁹ Inger Andersen, Loïc Chiquier, Hedi Larbi, Simon C. Bell, Hooman Dabidian: Iraq Investment Climate Assessment. World Bank, 2012.

⁴⁷⁰ The First Amendment of Investment law No. 13, 2006, Decision No. (2).

⁴⁷¹ World Bank: Doing business in Iraq. Washington, DC 20433,2013. www.worldbank.org.

The fifth most important risk factor of PPP projects in Iraq, according to overall respondents, is the “availability of financing”. In general, financial risks arise when there is a change in the cost of capital to the PPP utility. Unavailability of financial instrument, which leads to difficulty in financing, would engender project termination and loss of the funds invested. Since the average life of assets in PPP projects is long and the replacement need of different assets is highly variable, it is imperative to match the financing strategy with the asset management cycle to maximize financial efficiency and minimize risk exposure.

Due to the provision of a wide range of guarantees and protection in the Iraqi investment law No. 13, such as protection of private investors against project risks related to the Gol’s responsibilities or payment obligations, political risks and market demands as well as the exemption from certain taxes specifically, the reduction of the individual income tax rates from 10-40% to 3-15%. This argument explains the low rankings of “tariff -setting uncertainty / Revenue loss” R16, “Change in tax regulation” R23 and “Changes in currency exchange rates” R29.

Land Allocation in Iraq – A Snapshot

According to the 2010 US State Department Investment Climate Assessment for Iraq, “The land market is highly centralized and managed by the national government. The State Properties Directorate of the Ministry of Finance is responsible for the overall management, allocation, sale and/or lease of all state-owned land. The Directorate allocates land to the Ministry of Municipalities and Public Works (MMPW), which in turn is transferred to municipalities to be sold to private interests for residential development through an auction process. Various other ministries such as Housing and Construction and Agriculture, have major land management and land allocation responsibilities. Land in Baghdad is managed through the Mayoralty Properties Directorate. Allocation of state-owned land to public and private interests for major commercial and industrial projects is managed through national land allocation committees.” Under the National Investment Law, foreigners cannot own land in Iraq except to develop residential real estate projects. However, since late 2010, foreigners could obtain land through long-term leases of up to 50 years. Various terms apply depending on the location and use of the land. Iraq does not yet have a centralized and accessible database of land plots.

Figure 5-31: Land allocation in Iraq⁴⁷²

5.1.4.2 Perceptions of Survey Groups Respondents Concerning the Importance of Risk Factors

As illustrated in Table 5-9, the three most important project risks for public sector were: (1) government stability/civil disturbance/security, (2) operation quality /low productivity, and (3) availability of financing. Compared to traditional construction activity, operation quality and

⁴⁷² US Department of State: Investment Climate Statement. 2010. <http://www.state.gov/e/eb/rls/othr/ics/2010/>

availability of financing are still important to the public sector. In addition, providing quality service in a PPP project is especially important, which implies that the requirements of public sector respondents focus on long-term sustainable development of PPP projects.

Generally, the risk ranking according to the private sector concurs with the conventional wisdom of being investors concerned about the consequences of any government actions that may adversely affect project cash flows. It is, therefore, not surprising to see private sector ranking “Land acquisition/ compensation time and cost” in the first position, followed by “Administrative efficiency/delay of approvals and licenses” at the second position, and at the third position “Poor public decision-making process”. On other words, a closer examination of the mean score values for the identified three risk factors reveals that public sector have consistently rated them lower than how private sector had. This, once again, reflects the deep concerns held by the private sector regarding the uncertainty associated with risk factors which are outside their immediate control.

This is somewhat different for the third group Academics, the three most important project risks were: (1) Administrative efficiency/ delay of approvals, (2) Poor public decision-making process, and (3) Government stability/civil disturbance/security. The top five of the three survey sample groups are shown in Table 5-10.

Top five risk factors for each group	Public sector (A)	Private sector (B)	Researchers (C)	Overall
1	Government stability/ Civil disturbance/ Security	Land acquisition/ Compensation time and cost	Administrative efficiency/ delay of approvals	Government stability/ Civil disturbance/ Security
2	Operation quality /Low productivity	Administrative efficiency/ Delay of approvals	Poor public decision- making process	Administrative efficiency/ Delay of approvals
3	Availability of financing	Poor public decision- making process	Government stability/ Civil disturbance/ Security	Poor public decision- making process
4	Administrative efficiency/ delay of approvals	Availability of financing	Operation quality /Low productivity	Land acquisition/ Compensation time and cost
5	Poor public decision- making process	Government stability/ Civil disturbance/ Security	Change in legal and regulatory framework	Availability of financing

Table 5-10: Top five risk factors for different groups

At the other end of the scale of the three groups, however, changes in currency exchange rates were ranked bottom of the list. As mentioned before, this is mainly because project financing in Iraq’s PPP projects continues to be with foreign currency denominated thus making these risk factors less relevant. It is often argued that government is better able to bear foreign exchange risk

because it has an informational advantage (due to knowledge of its own future policy intentions and its ability to use policy instruments to influence the exchange rate).⁴⁷³

Historically speaking, and with the exception of the nationalization of foreign-owned companies in Iraq in the Sixties and Seventies of the last century, nationalization risk has rarely been associated with private ventures, not to mention the business of infrastructure provision in Iraq. A closer examination of the rankings reveals that public respondents, in general, rated the “Expropriation/nationalization risk” (R21) at the 30th position, lower than other categories of risk. This implies that they believe that the impact or probability of occurrence of such risk is low. This is may be due to the article 23 of the Iraqi Constitution prohibits expropriation in Iraq, except if it is for the purpose of public benefit in return for just compensation.” As well as, article 12 of the investment law No. 13 also guarantees non-seizure or nationalization of the investment project covered by the provisions of this law in whole or in part, except for a project on which a final judicial judgment was issued.

Private sector respondents have a different perspective, they rated the “Expropriation/nationalization risk” at the 17th position, this may be indicates that private sector thinks that despite the provision of guarantees to protect projects from nationalization in Iraq, it is; somewhat; not sufficient guarantees, especially using the term “an exception in guarantees” in the article 23 of the Iraqi Constitution, as shown above. The constitutional provision further stipulates that this provision shall be regulated by law, but specific legislation has yet to be considered, giving the Iraqi judiciary the right to freely decide for confiscation and nationalization.

The “Chang in taxes law” ranked by the private sector higher than the public sector at the 14th position. This indicates the importance of this factor for the private sector respondents. Despite the tax exemption granted in the investment law, there are a numerous fees and taxes imposed by the Iraqi laws such as: the income tax and machines tax in the Tax law No. 113 of 1982, sales tax law No. 36 of 1997, the income tax of the capital in the company law No. 21 of 1997, rent of real estate tax law No. 162 of 1959, real estate transfer tax law No. 120 of 2002, real estate tax law No. 26 of 1962, reconstruction tax law No. 38, the customs tariff law No. 23 of 1984. Moreover, in line with Articles 25 and 26 of the Constitution, the current approach of taxation and tax policy should be abandoned and a new approach should be adopted that considers tax as an economic instrument used to encourage domestic and foreign investment and the private sector in general. For a specific project this sums up to 13 taxes per year, takes 312 days a year, paying taxes amounting to 14.9% of profit and a total tax rate 28.4% of profit. In comparison the United Arab Emirates, have 14 taxes per year, needing 12 hours a year, paying a total tax rate 14.1%. Globally, United Arab Emirates is ranked 7 of 183 economies on the ease of paying taxes.⁴⁷⁴

As shown in Table 5-9, there are some disagreement reflected by the scores and rankings in different group. Herein, the rank of risk factor (R3) is more important in group B (Rank first) than in other two groups (group A Rank 5, and group C Rank 7). The score of risk factor (R7) also gets the highest score in group B (Rank 11) comparing with group A (Rank 18) and group C (Rank 22). The score of risk factor (R15) for group A (Rank 8) is higher than other two groups (group B Rank 21, and group Rank 12).

⁴⁷³ Tomoko M., Robert S., Joseph W.: Foreign Exchange Risk Mitigation for Power and Water Projects in Developing Countries. Energy and Mining Sector Board Discussion Paper No.9, December 2003

⁴⁷⁴ Zimmermann Josef, Aljuboori Omar: The Challenges of Governing Public Private Partnerships in Iraq Infrastructure Projects. Creative Construction Conference, Budapest, Hungary, 2013.

On the other hand, the ranking of risk factor (R17) in group C (Rank 20) is lower than in group A (Rank 16) and group B (Rank 10), which reflects different risk attitudes. The ranking of risk factor (R22) in group C (Rank 4) is higher than in group A (Rank 11) and group B (Rank 9).

The disagreement between survey sample groups can be further explained using appropriate statistical tests. On this line and before starting the implementation of the statistical analysis procedures, the researcher checks the availability of the most important condition for the application of this type of analysis which is the normal distribution of the data, by using Kolmogorov - Smirnov (KS) test; it was found that the collected data are not following a normal distribution.⁴⁷⁵ The null hypothesis for the test of normality is that data are normally distributed. As the p-value is less than 0.05 in the test for all risk factors, the null hypothesis is rejected and the data are not normally distributed.

5.1.4.3 Test for Internal Agreement of Risk Ranking

The values of Kendall's coefficient of concordance were calculated to measure the internal agreement within the same group of respondents on the rankings of different risk factors of PPP projects in Iraq. The hypotheses for this test are: null hypothesis, ($H_0 : W = 0$), Alternative hypothesis, ($H_0 : W \neq 0$). As shown in Table 5-11, the Kendall's coefficient of concordance (W) for the public and private sectors as well as researchers was 0.321, 0.385 and 0.430 respectively. The computed value of the W was statistically significant at 1% significance level. It can be interpreted that there is significant agreement among the respondents on the ratings of the risk significance of the PPP projects in Iraq.

Item	Public sector	Private sector	Researchers	Overall
Number of survey respondents	43	26	27	96
Kendall's coefficient of concordance (W)	0.321	0.385	0.430	0.325
Degree of freedom (df)	29	29	29	29
Asymptotic significance	0.000	0.000	0.000	0.000
Chi-square value	400.361	290.014	336.859	904.201
Critical value of Chi-square	39.087	39.087	39.087	39.087

Table 5-11: Risk ranking of PPP projects and Kendall's test

Moreover, as the number of attributes considered were above seven,⁴⁷⁶ as mentioned previously the Chi-square value would be referred to rather than the W value. According to the degree of

⁴⁷⁵ See Appendix C.

⁴⁷⁶ See Section 4.5.3.

freedom (df) equal to 29, the critical value of Chi-square⁴⁷⁷ was 39.087 for each group, the computed Chi-square values (taken from SPSS output) were all above the critical value of Chi-square (public: 400.361, private: 290.014 and researcher: 336.859) see Table 5-11. Therefore the assessment by the respondents within each group on their rankings of risk factors is proved to be consistent. This finding ensures that the completed questionnaires were valid for further analysis.

5.1.4.4 Agreement of the Survey Respondents on Risk Factors

As shown in Table 5-9, among the public sector, the private sector and academics groups, there are sufficient convergence on opinions on the level and degree of risk. To determine whether there were any statistical differences in the mean importance of each risk factor among the three groups of the survey respondents, and as the normality distribution of observations were not proved, a non-parametric statistical Kruskal Wallis test is performed. The null and research hypotheses for this test are stated as follows:

Null hypothesis, $H_0 : M_{ga} = M_{gb} = M_{gc}$

Alternative hypothesis, H_a : At least there is one difference among three groups medians.

Where M_{ga} , M_{gb} and M_{gc} are the median values for “group A”, “group B”, and “group C” respectively, the null hypothesis is that the medians significance of each factor is equal among the three groups, test results illustrated in Table 5-12 below.

Inspection of Table 5-12 shows that the median significance of each risk factor is different, which indicates that there are some different opinions within survey groups on risk factors: R14 (Market demand), R15 (Operation and maintenance time and cost), R17 (Fuel availability), and R30 (Government political instability /Civil disturbance/ security). These differences result from different risk preferences of survey respondents.

On other words, as only R14, R15, R17 and R30 were statistically different in terms of mean importance. This implies that the remaining 26 risk factors were somewhat similarly selected by the three groups with respect to their importance. Therefore, it can be inferred that the survey sample three groups considered the importance of the majority of risk factors similarly at the conventional 95% confidence level.

In addition to the presentation of evidence where there is some significant importance differences revealed in the assessments of survey respondent groups in Table 5-12, the measured effect size is given as a measure of the significance of the difference. It should be noted that the significance describes only on random differences in the sample, suggesting a difference in the studied population. However, it is always to exploratory investigations. The results shown are always interpreted in the context of the work in connection with the frequency distributions of responses, which forms the basis for the classification of the evidence into different category.

⁴⁷⁷ For excellent discussion, See (Berenson *et al.* 2009).

Risk factors	Chi-Square (H value)	Asymp. Sig. (p-value)	Significant	Effect size	
				d	Interpretation
R1	0.428	0.807	No	0.41	“Medium effect”
R2	0.652	0.722	No	0.62	“Medium effect”
R3	1.039	0.595	No	0.99	“Large effect”
R4	2.480	0.289	No	2.41	“Large effect”
R5	1.046	0.593	No	1.02	“Large effect”
R6	0.309	0.857	No	0.30	“Small effect”
R7	1.641	0.440	No	1.59	“Large effect”
R8	2.967	0.227	No	2.88	“Large effect”
R9	0.812	0.666	No	0.79	“Medium effect”
R10	0.233	0.890	No	0.23	“Small effect”
R11	0.847	0.655	No	0.84	“Large effect”
R12	0.220	0.896	No	0.22	“Small effect”
R13	3.801	0.149	No	3.66	“Large effect”
R14	7.845	0.020*	Yes	7.54	
R15	7.792	0.020*	Yes	7.56	
R16	4.231	0.121	No	4.11	“Large effect”
R17	8.643	0.013*	Yes	8.31	
R18	0.034	0.983	No	0.03	“Small effect”
R19	1.536	0.464	No	1.49	“Large effect”
R20	0.676	0.713	No	0.65	“Medium effect”
R21	4.401	0.111	No	4.23	“Large effect”
R22	3.312	0.191	No	3.18	“Large effect”
R23	3.700	0.157	No	3.56	“Large effect”
R24	1.694	0.429	No	1.64	“Large effect”
R25	1.679	0.432	No	1.65	“Large effect”
R26	5.680	0.058	No	5.4	“Large effect”
R27	0.310	0.857	No	0.29	“Small effect”
R28	1.270	0.530	No	1.21	“Large effect”
R29	0.181	0.913	No	0.17	“Small effect”
R30	15.755	0.000*	Yes	15.15	

Note: * Not corrected for ties

Table 5-12: Kruskal Wallis test for risk factors among survey groups

Despite that Kruskal Wallis test shows the overall difference between groups, it does not show which specific groups differed. Therefore, another non-parametric statistical test (Mann–Whitney–Wilcoxon) is performed. The following two hypotheses are used to assess if each two groups have varied significantly in their evaluation of a particular risk factor:

Null hypothesis, $H_0 : \mu_{g1} = \mu_{g2}$

Alternative hypothesis, $H_a : \mu_{g1} \neq \mu_{g2}$

Where μ_{g1} and μ_{g2} are the score values for “group one” and “group two”, respectively, The null hypothesis is that the mean significance of each factor is equal between any two groups. If p-value is less than 0.05, the null hypothesis can be rejected, indicating that there are significant differences between the two groups under study.

Two groups of survey respondents: Group A and Group B is compared first; Groups A and Group C next; and finally, Group B and C. To avoid type I error rate in alpha (confidence level), alpha level would need to be adjusted. This is simply done by dividing alpha (0.05) by the number of significance tests, which is in our case three, the significance level for the three tests is ($\alpha=0.0167$).

In this case, the mean significance of each risk factor is different, which indicates that there are some different opinions between groups on risk factors: R14 (Market demand), R15 (Operation and maintenance time and cost), R17 (Fuel availability), and R30 (Government political instability /Civil disturbance/ security).

For example, group A and B have significant differences on the objectives R15 and R30 with ($0.008 < 0.0167$) ($0.000 < 0.0167$) respectively, so do group B and C for risk factor R14 with ($0.004 < 0.0167$). Moreover, group A and C have different opinions on the objective R14 with ($0.015 < 0.0167$).

Since Mann–Whitney test has the same results of Kruskal Wallis test. Hence, no additional significance tests need to be conducted beyond the Mann–Whitney. Table 5-16 to 5-16 show the Mann-Whitney U test results of pairwise comparisons.

Risk factors	Groups	n	Mean Rank	Sum of Ranks	Mann-Whitney U	Asymp. Sig. (2-tailed)	Significant
R1	A	48	39.93	1916.50	651.500	0.527	No
	B	29	37.47	1086.50	684.000		
R2	A	48	38.75	1860.00	683.000	0.894	No
	B	29	39.41	1143.00	572.000		
R3	A	48	39.27	1885.00	663.500	0.870	No
	B	29	38.55	1118.00	661.000		
R4	A	47	40.83	1919.00	668.000	0.224	No
	B	29	34.72	1007.00	531.000		
R5	A	47	38.88	1827.50	618.000	0.821	No
	B	29	37.88	1098.50	660.000		
R6	A	48	39.73	1907.00	595.500	0.644	No
	B	29	37.79	1096.00	610.500		
R7	A	48	38.42	1844.00	557.000	0.753	No
	B	29	39.97	1159.00	503.500		
R8	A	48	41.44	1989.00	454.500	0.089	No
	B	28	33.46	937.00	526.000		
R9	A	48	39.63	1902.00	579.500	0.506	No
	B	28	36.57	1024.00	661.000		
R10	A	48	38.75	1860.00	561.000	0.893	No
	B	28	38.07	1066.00	682.000		
R11	A	47	36.67	1723.50	614.000	0.651	No
	B	27	38.94	1051.50	573.000		
R12	A	48	37.22	1786.50	557.500	0.653	No
	B	27	39.39	1063.50	673.500		
R13	A	48	41.90	2011.00	619.500	0.066	No
	B	29	34.21	992.00	523.000		
R14	A	48	43.01	2064.50	705.500	0.023	No
	B	29	32.36	938.50	616.000		
R15	A	47	43.33	2036.50	717.500	0.008	Yes
	B	29	30.67	889.50	412.000		
R16	A	47	41.81	1965.00	651.500	0.068	No
	B	29	33.14	961.00	684.000		
R17	A	48	41.43	1988.50	683.000	0.173	No
	B	29	34.98	1014.50	572.000		
R18	A	47	38.06	1789.00	663.500	0.821	No
	B	29	39.21	1137.00	661.000		
R19	A	48	40.81	1959.00	668.000	0.213	No
	B	28	34.54	967.00	531.000		
R20	A	48	38.71	1858.00	618.000	0.861	No
	B	29	39.48	1145.00	660.000		
R21	A	47	40.94	1924.00	595.500	0.305	No
	B	30	35.97	1079.00	610.500		
R22	A	47	41.81	1965.00	557.000	0.114	No
	B	30	34.60	1038.00	503.500		
R23	A	48	36.11	1733.50	454.500	0.128	No
	B	29	43.78	1269.50	526.000		
R24	A	47	38.67	1817.50	579.500	0.923	No
	B	29	38.22	1108.50	661.000		
R25	A	46	36.97	1700.50	561.000	0.587	No
	B	29	39.64	1149.50	682.000		
R26	A	47	42.87	2015.00	614.000	0.037	No
	B	30	32.93	988.00	573.000		
R27	A	48	39.80	1910.50	557.500	0.878	No
	B	30	39.02	1170.50	673.500		
R28	A	48	41.67	2000.00	619.500	0.269	No
	B	30	36.03	1081.00	523.000		
R29	A	48	39.55	1898.50	705.500	0.979	No
	B	30	39.42	1182.50	616.000		
R30	A	47	45.23	2126.00	717.500	0.000	Yes
	B	30	29.23	877.00	412.000		

n: Number of respondents

Table 5-13: Mann-Whitney U-test for risk factors between group A and group B

Risk factors	Groups	n	Mean Rank	Sum of Ranks	Mann-Whitney U	Asymp. Sig. (2-tailed)	Significant
R1	A	48	39.14	1878.50	689.500	0.925	No
	C	29	38.78	1124.50	633.000		
R2	A	48	37.69	1809.00	620.000	0.480	No
	C	29	41.17	1194.00	629.500		
R3	A	48	37.42	1796.00	596.500	0.494	No
	C	29	41.62	1207.00	637.500		
R4	A	47	37.39	1757.50	557.500	0.741	No
	C	28	39.02	1092.50	629.500		
R5	A	47	36.69	1724.50	605.000	0.408	No
	C	28	40.20	1125.50	637.000		
R6	A	48	39.22	1882.50	580.500	0.642	No
	C	28	37.27	1043.50	646.000		
R7	A	48	39.89	1914.50	651.000	0.290	No
	C	27	34.65	935.50	617.500		
R8	A	48	39.39	1890.50	625.000	0.598	No
	C	28	36.98	1035.50	523.500		
R9	A	48	39.90	1915.00	425.000	0.412	No
	C	28	36.11	1011.00	650.500		
R10	A	48	37.77	1813.00	642.000	0.694	No
	C	28	39.75	1113.00	609.500		
R11	A	47	36.35	1708.50	480.000	0.377	No
	C	28	40.77	1141.50	643.000		
R12	A	48	38.04	1826.00	527.000	0.981	No
	C	27	37.93	1024.00	566.500		
R13	A	48	38.94	1869.00	541.500	0.756	No
	C	28	37.75	1057.00	639.000		
R14	A	48	37.36	1793.50	623.500	0.455	No
	C	28	40.45	1132.50	662.000		
R15	A	47	38.70	1819.00	636.500	0.673	No
	C	28	36.82	1031.00	585.500		
R16	A	47	40.86	1920.50	689.500	0.102	No
	C	28	33.20	929.50	633.000		
R17	A	48	43.65	2095.00	620.000	0.004	Yes
	C	28	29.68	831.00	629.500		
R18	A	47	38.16	1793.50	596.500	0.933	No
	C	28	37.73	1056.50	637.500		
R19	A	48	39.13	1878.00	557.500	0.736	No
	C	28	37.43	1048.00	629.500		
R20	A	48	37.20	1785.50	605.000	0.412	No
	C	28	40.73	1140.50	637.000		
R21	A	47	41.79	1964.00	580.500	0.038	No
	C	28	31.64	886.00	646.000		
R22	A	47	38.32	1801.00	651.000	0.952	No
	C	28	37.46	1049.00	617.500		
R23	A	48	35.48	1703.00	625.000	0.104	No
	C	28	43.68	1223.00	523.500		
R24	A	47	36.05	1694.50	425.000	0.236	No
	C	28	41.27	1155.50	650.500		
R25	A	46	35.27	1622.50	642.000	0.234	No
	C	28	41.16	1152.50	609.500		
R26	A	47	37.60	1767.00	480.000	0.808	No
	C	28	38.68	1083.00	643.000		
R27	A	48	37.49	1799.50	527.000	0.591	No
	C	28	40.23	1126.50	566.500		
R28	A	48	38.29	1838.00	541.500	0.910	No
	C	28	38.86	1088.00	639.000		
R29	A	48	39.24	1883.50	623.500	0.695	No
	C	28	37.23	1042.50	662.000		
R30	A	47	39.54	1858.50	636.500	0.197	No
	C	28	35.41	991.50	585.500		

n: Number of respondents

Table 5-14: Mann-Whitney U-test for risk factors between group A and group C

Risk factors	Groups	n	Mean Rank	Sum of Ranks	Mann-Whitney U	Asymp. Sig. (2-tailed)	Significant
R1	B	29	28.69	832.00	397.000	0.634	No
	C	29	30.31	879.00	376.500		
R2	B	29	27.98	811.50	370.000	0.464	No
	C	29	31.02	899.50	313.500		
R3	B	29	27.76	805.00	355.000	0.317	No
	C	29	31.24	906.00	406.000		
R4	B	29	25.81	748.50	324.000	0.124	No
	C	28	32.30	904.50	332.000		
R5	B	29	27.24	790.00	386.000	0.321	No
	C	28	30.82	863.00	366.000		
R6	B	29	29.00	841.00	350.000	1.000	No
	C	28	29.00	812.00	345.000		
R7	B	29	30.83	894.00	333.000	0.241	No
	C	27	26.00	702.00	272.000		
R8	B	28	26.36	738.00	289.000	0.285	No
	C	28	30.64	858.00	406.000		
R9	B	28	28.71	804.00	312.500	0.913	No
	C	28	28.29	792.00	402.000		
R10	B	28	27.57	772.00	347.000	0.655	No
	C	28	29.43	824.00	378.000		
R11	B	27	26.96	728.00	358.500	0.624	No
	C	28	29.00	812.00	344.000		
R12	B	27	28.22	762.00	387.000	0.715	No
	C	27	26.78	723.00	345.500		
R13	B	29	26.48	768.00	352.500	0.163	No
	C	28	31.61	885.00	302.500		
R14	B	29	24.38	707.00	394.000	0.015	Yes
	C	28	33.79	946.00	369.000		
R15	B	29	24.97	724.00	397.500	0.045	No
	C	28	33.18	929.00	302.000		
R16	B	29	29.00	841.00	397.000	1.000	No
	C	28	29.00	812.00	376.500		
R17	B	29	32.22	934.50	370.000	0.118	No
	C	28	25.66	718.50	313.500		
R18	B	29	29.14	845.00	355.000	0.947	No
	C	28	28.86	808.00	406.000		
R19	B	28	26.89	753.00	324.000	0.444	No
	C	28	30.11	843.00	332.000		
R20	B	29	28.03	813.00	386.000	0.572	No
	C	28	30.00	840.00	366.000		
R21	B	30	31.55	946.50	350.000	0.318	No
	C	28	27.30	764.50	345.000		
R22	B	30	26.97	809.00	333.000	0.121	No
	C	28	32.21	902.00	272.000		
R23	B	29	28.34	822.00	289.000	0.746	No
	C	28	29.68	831.00	406.000		
R24	B	29	26.91	780.50	312.500	0.248	No
	C	28	31.16	872.50	402.000		
R25	B	29	27.16	787.50	347.000	0.361	No
	C	28	30.91	865.50	378.000		
R26	B	30	25.58	767.50	358.500	0.046	No
	C	28	33.70	943.50	344.000		
R27	B	30	28.63	859.00	387.000	0.676	No
	C	28	30.43	852.00	345.500		
R28	B	30	27.80	834.00	352.500	0.412	No
	C	28	31.32	877.00	302.500		
R29	B	30	30.25	907.50	394.000	0.719	No
	C	28	28.70	803.50	369.000		
R30	B	30	25.57	767.00	397.500	0.033	No
	C	28	33.71	944.00	302.000		

n: Number of respondents

Table 5-15: Mann-Whitney U-test for risk factors between group B and group C

Risk factors	Asymp. Sig. (2-tailed)/ p-value		
	A and B	A and C	B and C
R1	0.528	0.925	0.634
R2	0.894	0.480	0.464
R3	0.634	0.494	0.317
R4	0.224	0.741	0.124
R5	0.821	0.408	0.321
R6	0.644	0.642	1.000
R7	0.753	0.290	0.241
R8	0.089	0.598	0.285
R9	0.506	0.412	0.913
R10	0.893	0.694	0.655
R11	0.651	0.377	0.624
R12	0.653	0.981	0.715
R13	0.066	0.756	0.163
R14	0.023	0.455	0.015*
R15	0.008*	0.673	0.045
R16	0.068	0.102	1.000
R17	0.173	0.004*	0.118
R18	0.821	0.933	0.947
R19	0.213	0.736	0.444
R20	0.861	0.412	0.572
R21	0.305	0.038	0.318
R22	0.114	0.952	0.121
R23	0.128	0.104	0.746
R24	0.923	0.236	0.248
R25	0.587	0.234	0.361
R26	0.037	0.808	0.046
R27	0.878	0.591	0.676
R28	0.269	0.910	0.412
R29	0.979	0.695	0.719
R30	0.000*	0.197	0.033

Note: * Not corrected for ties

Table 5-16: Summary of Mann-Whitney U-test for risk factors among survey groups

5.1.5 Risk Allocation Preferences by Survey Respondents

Risk allocation refers to the determination of which party or parties should bear the consequence(s) of events identified as project risks. A general principle is that each risk should be allocated to the party best able to manage it and at the least cost.⁴⁷⁸ In other words, an optimal risk allocation is not to pass all risks to the private sector, but to seek a solution minimizing both the total management costs of the public and private sectors. How risk is shared or allocated between the parties involved is central to the PPP arrangement in terms of definition, contract negotiation, achievement of value for money, and overall project success.⁴⁷⁹ However, the principal aim for the public sector is to achieve value for money in the services provided while ensuring that the private sector entities meet their contractual obligations properly and efficiently.

Furthermore, Elbing and Devapriya (2004)⁴⁸⁰ stressed that in order to improve value for money during risk allocation on PPP projects, risk sharing between the public sector and special purpose company should be assessed and optimised by using guarantees and contracts including the output specification, service levels and appropriate payment mechanisms. On the other hand, Zimmermann and Eber (2014)⁴⁸¹ concluded that appropriately and seriously elaborated risk management for PPP-projects will principally assign only very minor risks to the private part. The main risk volume will always remain with the public side since no profitable risk limiting solution exists which would be obligatory for a private companies' offer.

Furthermore, Lam *et al.* (2007)⁴⁸² identified seven key risk allocation criteria:

- Whether the party is able to foresee the risk;
- Whether the party is able to assess the possible magnitude of consequences of the risk;
- Whether the party is able to control the chance of the risk occurring;
- Whether the party is able to manage the risk in case of occurring;
- Whether the party is able to sustain the consequences if the risk occurs;
- Whether the party will benefit from bearing the risk; and
- Whether the premium charged by the risk receiving party is considered reasonable and acceptable for the owner.

In the survey research, questions were asked to the respondents regarding their opinion about the party best capable of managing various risks in Iraq PPP projects. Three risk allocation categories are identified:

1. Risks that should be allocated to the public sector;
2. Risks that should be shared between the public and private sectors; and
3. Risks that should be allocated to the private sector.

⁴⁷⁸ Cooper, D.F., Grey, S., Raymond, G., Walker, P.: Project Risk Management Guidelines-Managing Risk in Large Projects and Complex Procurements. John Wiley & Sons, Ltd., England, 2005.

⁴⁷⁹ Rouboutsos, A., Anagnostopoulos, K. P.: Public-Private Partnership Projects in Greece-Risk Ranking and Preferred Risk Allocation. Journal of Construction Management and Economics, Vol. 26 (7), 2008, P. 751-763.

⁴⁸⁰ Elbing C. and Devapriya K.A.K.: Structured Risk Management Process to Achieve Value for Money in Public Private Partnerships. Journal of Financial Management of Property and Construction, Vol. 9(3), 2004, P.121-127.

⁴⁸¹ Zimmermann Josef, Eber Wolfgang: Consideration of Risk in PPP- Projects. 8th International Scientific Conference "Business and Management 2014". Vilnius, Lithuania, May 15-16, 2014.

⁴⁸² Lam, K. C., Wang, D., Lee, T. K., and Tsang, Y. T.: Modeling Risk Allocation Decision in Construction Contracts. International Journal for Project Management, Vol. 25(5), 2007, P.485-493.

The preferred risk allocation of PPP projects in Iraq between mainly the public and private sectors is analyzed based on the Center of Mass theory. By assuming previous three risk allocation options (Public, Shared and Private) as three weight points arranged as shown in the Figure 5-32. Here, answers of survey groups on risk allocation options will represent weight points, i.e., Weight 1= (M_1) = Mainly to the public sector, Weight 2= (M_2) = Equally shared between the public and private sectors, and Weight 3 =(M_3) = Mainly to the private sector.

By using the Momentum of forces at point (0,0) over x and y axis, the x and y cordenates of each risk factor were calculated. The center of weight of this 3-object system will define the risk allocation depending on the distance between the calculated center of risk and each of the three risk allocations M_1 , M_2 or M_3 .

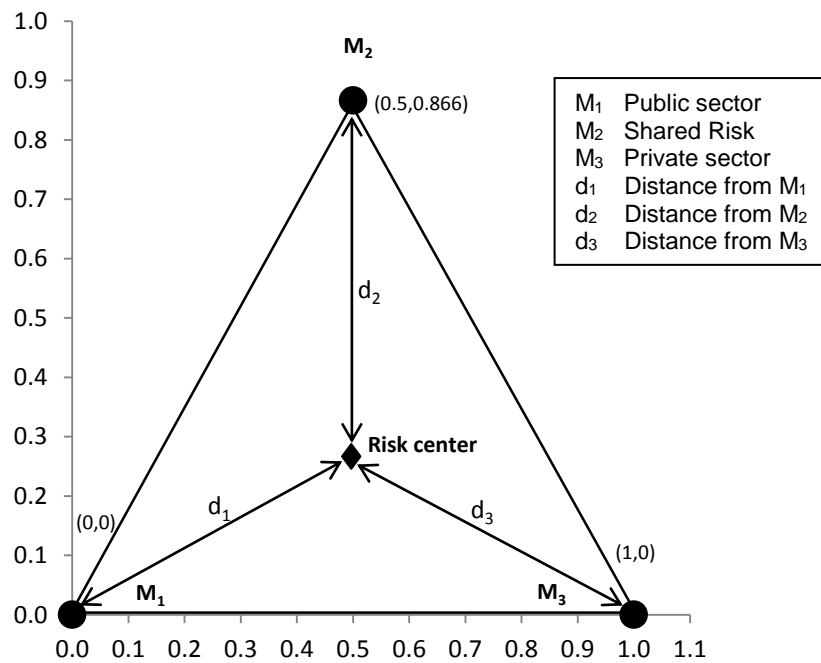

Figure 5-32: Calculating risk allocation according to center of mass theory

Furthermore, by applying this method the center of each risk of the 30 risk factors is calculated. Figure 5-33 and Table 5-17 below shows results of risk factors distribution for each group and overall.⁴⁸³

⁴⁸³ Appendix D shows risk distributions and risk allocation for all groups.

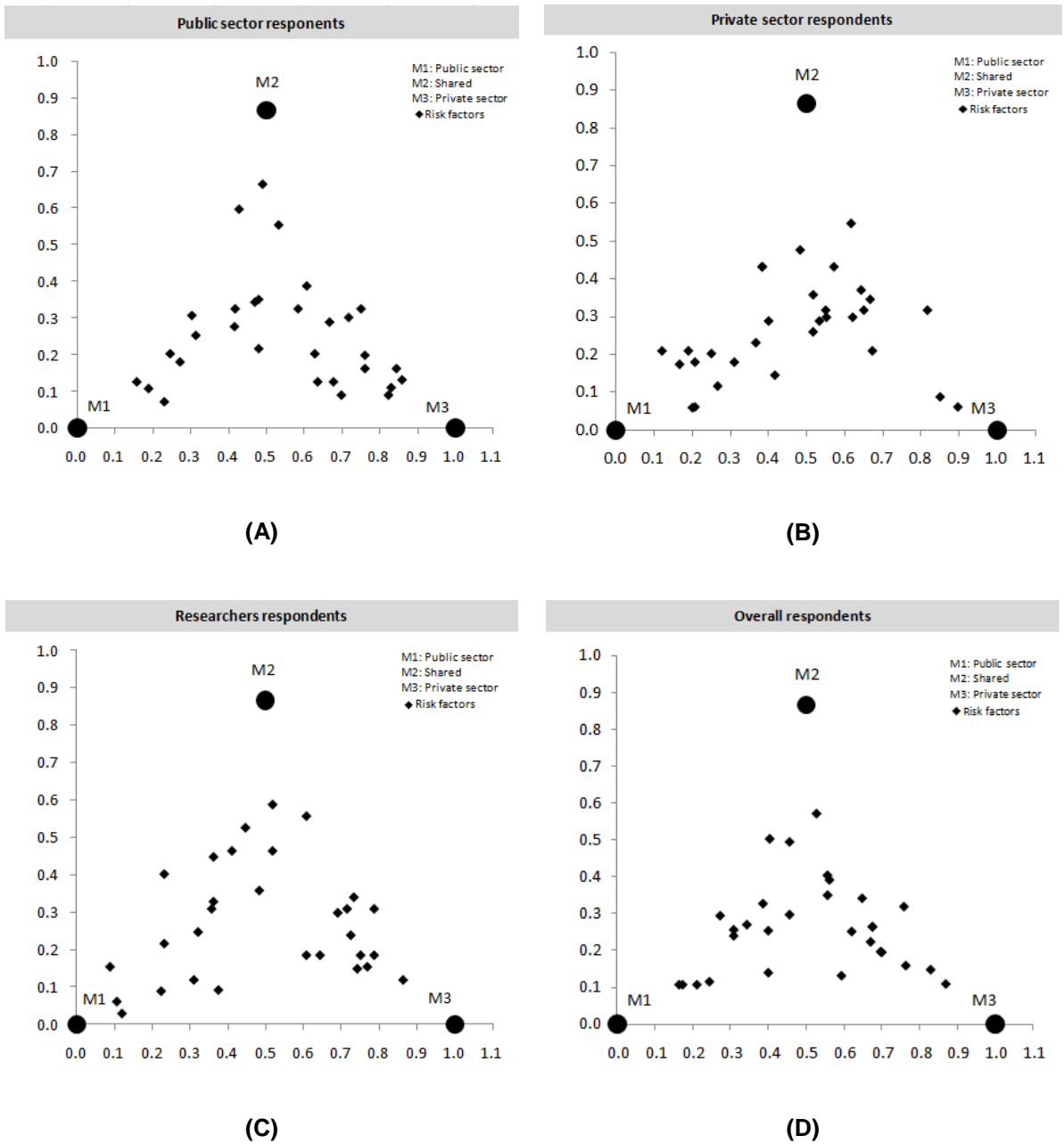

Figure 5-33: Preferred risk allocation of PPP projects in Iraq by survey groups

From Fig. 5-33 A it can be seen that the risks allocation based on the public sector respondents is showing that the public sector is trying to shift the risk towards the private sector. On the other hand, Fig. 5-33 B shows almost the same results but in the opposite direction, where private sector is trying to shift the risk towards the public sector.

To support risk allocation results, the researcher employed additional statistics; namely, Closeness Parameter (CP). This parameter is used to give a sign of the risk allocation results. It is simply calculated by dividing the standard deviation of the distances d_1 , d_2 and d_3 for each risk factor by the standard deviation of point M_1 , M_2 or M_3 (points M_1 , M_2 and M_3 have the same standard deviation, as they located equal distance from the center). Assume that point A is the point of equal distance to the M_1 , M_2 and M_3 . By calculate the value of \bar{d}_1 , \bar{d}_2 and \bar{d}_3 (See Figure 5-34), however the standard deviation is found to be equal to zero, which means that CP value at point A will be zero too. Furthermore, for points M_1 , M_2 and M_3 the CP values will be equal to one.

This range of CP from 0 to 1 will define the closeness of risk to M_1 , M_2 and M_3 . If the CP value of specific risk is equal to /or near to zero, there is a meaning that there is a weak risk allocation. On the other hand, if the CP value of specific risk is equal to /or near to one, there is a good sign that this risk attend to go in the direction of one of the M_1 , M_2 and M_3 , which will support our risk allocation results. Column 12 of Table 5-17 provides CP values of individual risk.

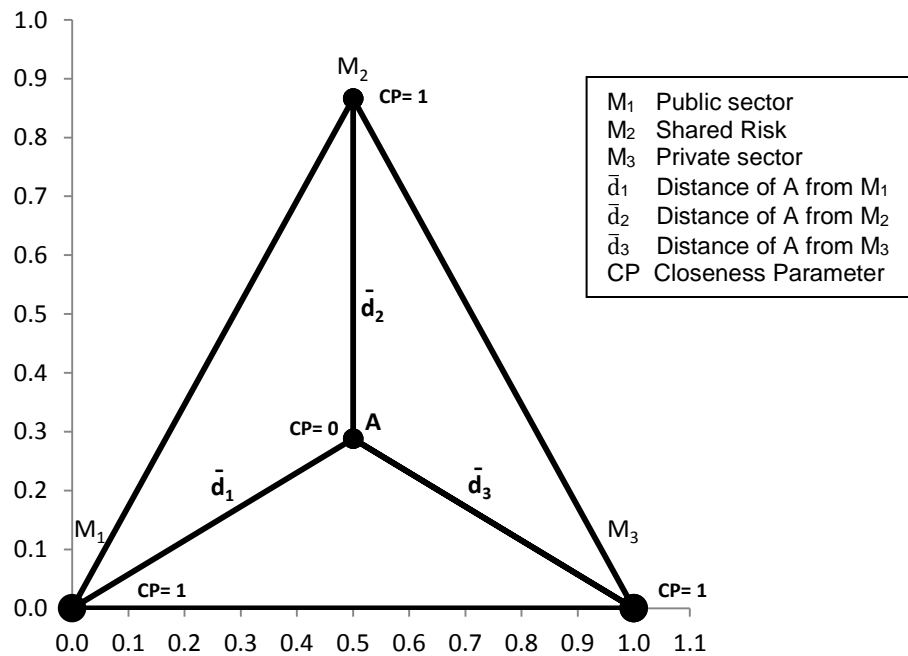

Figure 5-34: Closeness parameter calculation

Risk factors	Survey responses			n	Risk center coordinates		d 1 Distance from Pub.	d 2 Distance from Sh.	d 3 Distance from Pr.	SD	CP	Preferred risk allocation
	Risk allocated to the public	Risk is shared	Risk allocated to the private		X	y						
	Administrative efficiency/ delay of approvals and licenses	73	14		19	106						
Non Competitive tender/ Inadequate competition	77	13	16	106	0.212	0.106	0.237	0.812	0.795	0.327	0.567	Public
Land acquisition/ compensation time and cost	59	36	11	106	0.274	0.294	0.402	0.615	0.784	0.191	0.332	Public
Social/Cultural acceptability of the project	55	17	34	106	0.401	0.139	0.424	0.734	0.615	0.156	0.270	Public
Corruption/ transparency of public administrative	57	31	17	105	0.310	0.256	0.401	0.639	0.736	0.172	0.298	Public
Availability of financing	20	24	62	106	0.698	0.196	0.725	0.699	0.360	0.204	0.353	Private
High bidding cost	22	47	35	104	0.563	0.391	0.685	0.479	0.587	0.103	0.179	Shared
Design and construction changes	35	16	55	106	0.594	0.131	0.609	0.741	0.426	0.158	0.274	Private
Construction time and cost	20	24	63	107	0.701	0.194	0.727	0.701	0.357	0.207	0.358	Private
Unproven engineering technique or technology	16	41	47	104	0.649	0.341	0.733	0.545	0.490	0.128	0.221	Private
Geotechnical conditions	22	49	34	105	0.557	0.404	0.688	0.465	0.600	0.112	0.194	Shared
Labour /Material unavailability/	15	19	70	104	0.764	0.158	0.781	0.756	0.284	0.280	0.485	Private
Operation quality /Low productivity	9	18	79	106	0.830	0.147	0.843	0.791	0.225	0.343	0.594	Private
Market demand	15	70	21	106	0.528	0.572	0.779	0.295	0.741	0.269	0.466	Shared
Operation and maintenance time and cost	7	13	84	104	0.870	0.108	0.877	0.843	0.169	0.399	0.692	Private
Tariff escalation/ revenue loss	39	36	30	105	0.457	0.297	0.545	0.571	0.619	0.037	0.065	Public

Fuel availability and Supporting utilities	18	32	55	105	0.676	0.264	0.726	0.627	0.418	0.157	0.273	Private
Environmental risk	21	27	57	105	0.671	0.223	0.707	0.666	0.397	0.169	0.292	Private
Less residual value	25	42	37	104	0.558	0.350	0.658	0.519	0.564	0.071	0.123	Shared
Poor public decision-making process	81	13	12	106	0.175	0.106	0.204	0.827	0.832	0.361	0.625	Public
Expropriation/nationalization	58	29	18	105	0.310	0.239	0.391	0.655	0.731	0.178	0.309	Public
Chance in legal and regulatory framework	48	31	27	106	0.401	0.253	0.474	0.621	0.650	0.094	0.163	Public
Change in tax regulation	45	40	21	106	0.387	0.327	0.506	0.551	0.695	0.099	0.171	Public
Non-political force majeure	32	61	12	105	0.405	0.503	0.646	0.375	0.779	0.206	0.357	Shared
Third party liability	6	39	61	106	0.759	0.319	0.824	0.606	0.399	0.212	0.368	Private
Lack of commitment from public/private partner	27	60	18	105	0.457	0.495	0.674	0.374	0.735	0.193	0.335	Shared
Inflation rate	25	31	51	107	0.621	0.251	0.670	0.627	0.454	0.114	0.198	Private
Changes in interest rate	18	32	55	105	0.676	0.264	0.726	0.627	0.418	0.157	0.273	Private
Changes in currency exchange rates	53	33	20	106	0.344	0.270	0.437	0.616	0.709	0.138	0.239	Public
Government stability/Civil disturbance/ security	82	13	11	106	0.165	0.106	0.196	0.830	0.842	0.369	0.640	Public

n: Number of respondents

Table 5-17: Preferred risk allocation of the overall groups

5.1.5.1 Risk Allocation by Overall Respondents

Figure 5-35 below shows that from the overall perspective, 40% of risk factors are to be allocated to the public sector, as well as 40% are to be allocated to the private sector; while 20% are to be equally shared between the private and public sectors.

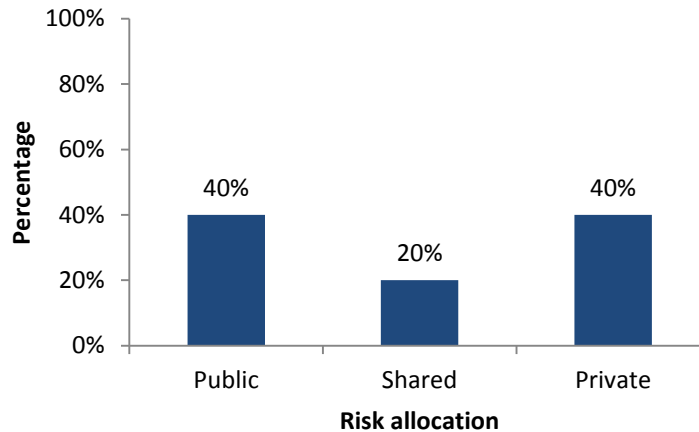

Figure 5-35: Risk allocation percentage by overall groups

5.1.5.2 Risks Allocated to the Public Sector (M1)

Overall, survey results show that there is an evidence to allocate twelve risk factors out of 30 (representing 40% of all risk factors identified) to the public sector, as illustrated in Table 5-17. These include, “Administrative efficiency/Delay of approvals and licenses”, “Non Competitive tender/Inadequate competition”, “Land acquisition/ Compensation time and cost”, “Social/Cultural acceptability of public administrative”, “Corruption/ Transparency of public administrative”, “Tariff escalation/ revenue loss”, “Poor public decision-making process”, “Expropriation/Nationalization”, “Chance in legal and regulatory framework”, “Change in tax regulation”, “Changes in currency exchange rates” and “Government stability/Civil disturbance/Security. It can be seen from the above that almost all the risk factors are related to government or government officers and their actions. Therefore, for private investors, the risk of creditworthiness of local governments is of their main concern,⁴⁸⁴ and they need to evaluate the liability of government officials’ decisions, especially their verbal promises.

⁴⁸⁴ Wang, S. Q., Tiong, R. L. K., Ting, S. K., and Ashley, D.: Evaluation and Management of Political Risks in China’s BOT Projects. *Journal of Construction Engineering Management*, Vol. 126(3), 2000, P.242–250.

5.1.5.3 Risks Shared between the Public and Private Sectors (M2)

Overall findings in Table 5-17 also show that there are six risk factors out of 30 (representing 20% of all risk factors identified) can be shared between the public and private sector partners. These include: “High bidding cost”, “Geotechnical conditions”, “Market demand”, “Less residual value”, “Non-political force majeure”, and “Lack of commitment from public/private partner”.

The nature of these risk factors is such that public and private sectors may not be able to deal with it alone. Hence, a shared mechanism would appear to be the best option.⁴⁸⁵ Some of these risks are generally recognized as being severe, but have a low probability of occurrence.

5.1.5.4 Risks Allocated to the Private Sector (M3)

Evidence from the survey overall results in Table 5-17 indicate that there is twelve risk factors out of 30 (representing 40% of all risk factors identified) can be assigned to the private sector partner. These, include: “Availability of financing”, “Design and construction changes”, “Construction time and cost”, “Unproven engineering technique or technology”, “Labour /Material unavailability”, “Operation quality /Low productivity”, “Operation and maintenance time and cost”, “Fuel availability and Supporting utilities”, “Environmental risk”, “Third party liability”, “Inflation rate” and “Changes in interest rate”.

The percentage of risk allocation to the private sector can be used to evaluate the extent to which the objective of risk transfer from the public sector to the private sector is achieved. According to Li *et al.* (2005)⁴⁸⁶ 70% of all the catalogued risks were allocated to the private sector in the UK, as well as, Chan *et al.* (2011)⁴⁸⁷ found the percentage to be 52% in PPP projects in China. Hwang *et al.* (2012)⁴⁸⁸ found the percentage to be 45% in PPP projects in Singapore, Hence, the analysis result at this study showed that the extent of transferring risks to the private sector in Iraq was much lower than that in the UK, China and Singapore (See Figure 5-35). This may be because of the good experience of these countries in PPP procurement. This also may suggest that PPP procurement in Iraq needs more knowledge and experience to achieve the objective of risk transfer from the public sector to the private sector such as in the UK.

5.1.5.5 Center of Overall Risk Factors

In order to determine the center of all risk factors, the mean and standard deviation of each of x and y coordinates for all the 30 risk factors were calculated. Figure 5-36 shows the results.

⁴⁸⁵ Li, B., Akintoye, A., Edwards, P., Hardcastle, C.: The Allocation of Risk in PPP/PFI Construction Projects in the UK. *International Journal of Project Management*, Vol. 23(1), 2005b, P. 25–35.

⁴⁸⁶ Li, B., Akintoye, A., Edwards, P., Hardcastle, C.: The Allocation of Risk in PPP/PFI Construction Projects in the UK. *International Journal of Project Management*, Vol. 23 (1), 2005b, P. 25–35.

⁴⁸⁷ Albert P. C. Chan, John F. Y. Yeung, Calvin C. P. Yu, Shou Qing Wang, Yongjian Ke: Empirical Study of Risk Assessment and Allocation of Public-Private Partnership Projects in China. *Journal of Management in Engineering*, Vol. 27(3), 2011, P. 36–148

⁴⁸⁸ Bon-Gang Hwang, Xianbo Zhao, Mindy Jiang Shu Gay: Public Private Partnership Projects in Singapore-Factors, Critical Risks and Preferred Risk Allocation from the Perspective of Contractors. *International Journal of Project Management*, Vol. 31(3), April 2013, P. 424–433.

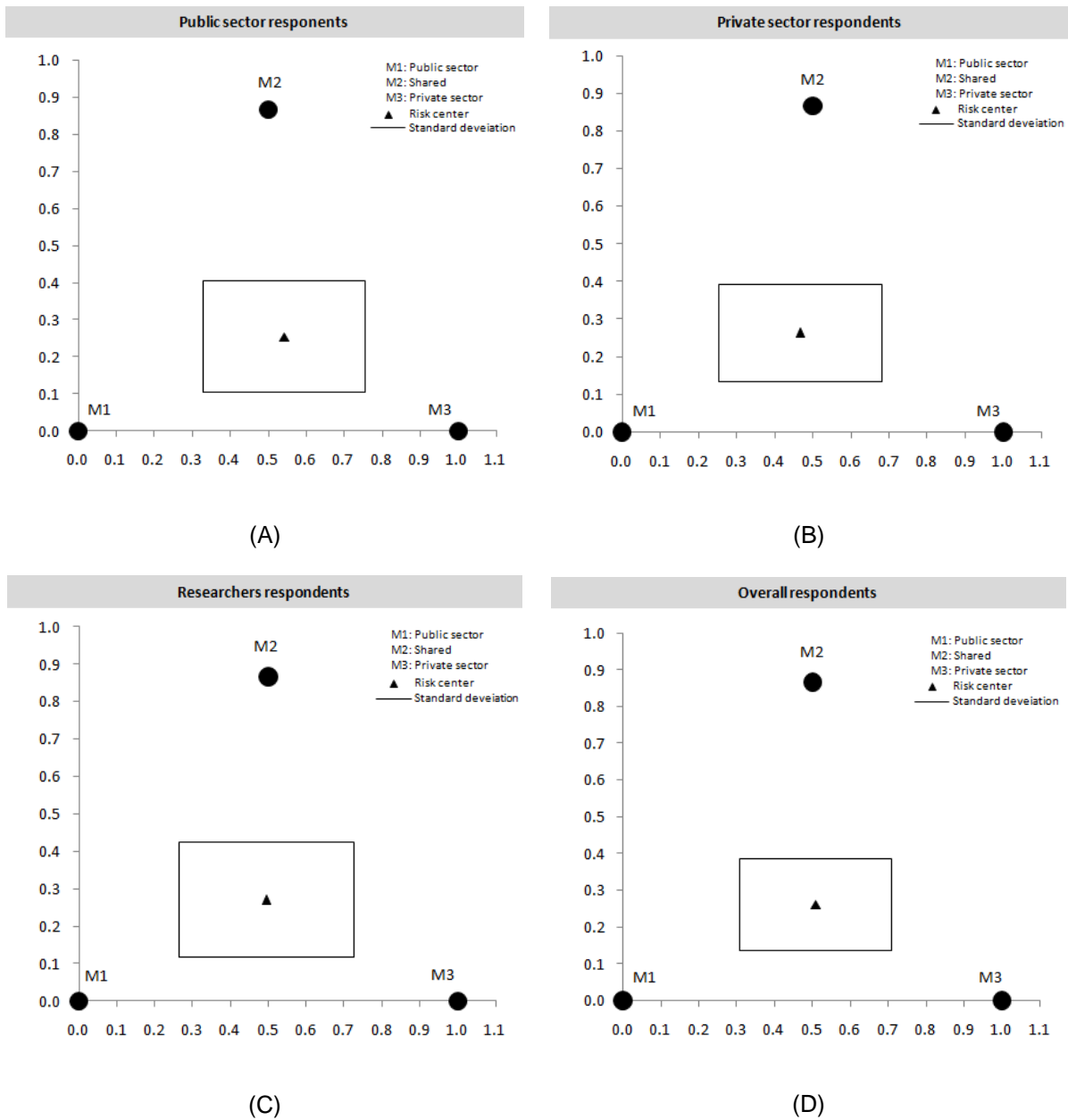

Figure 5-36: The center of all risk factors by survey groups

Findings show that for the public sector group, the risk center was allocated to the private sector. For the private sector group, the risk center was allocated to the public sector. For researchers group as well as overall groups, the risk center has almost the same distance from both public and private sectors. Table 5-18 shows the detailed results.

Groups	Risk center		SD.-x	SD.-y	d 1 Distance from Pub.	d 2 Distance from Sh.	d 3 Distance from Pr.	Conclusion
	x	y						
Public sector	0.542	0.253	0.212	0.150	0.598	0.614	0.524	Private
Private sector	0.467	0.263	0.213	0.129	0.537	0.603	0.594	Public
Researchers	0.496	0.271	0.232	0.153	0.565	0.595	0.572	Public-Private
Overall	0.509	0.261	0.201	0.125	0.572	0.605	0.556	Private-Public

Table 5-18: Center of overall risk by survey groups

5.1.6 Prospects of the Future of PPP in Infrastructure Projects in Iraq (Question 15)

The final part of the survey represent survey general conclusions, it evaluates the suitability of Iraq for PPPs implementation currently and in the recent future. Respondents were asked to express their opinions on statements about general Iraq's current conditions and the future of private sector participation in the PPP projects on a 1-6 Likert scale. Table 5-19 presents the survey results. As shown, the respondents slightly disagree with the statement that current conditions have been suitable for promoting private sector participation in PPP projects. Some optimism still remains, however. Survey group's respondents believe that PPP arrangements in the infrastructure projects have a promising future given that the existing conditions can be improved.

Statement	Public sector			Private sector			Researchers			Overall		
	n	Mean	SD	n	Mean	SD	n	Mean	SD	n	Mean	SD
Generally, do you agree that current Iraq conditions are suitable for private investment in infrastructure projects on basis of PPPs?	48	3.48	1.337	29	3.66	1.446	28	3.32	1.249	105	3.49	1.338
In the recent future, do you agree that PPP schemes in Iraq infrastructure projects are going to be extensively implemented if some criteria were improved?	48	5.67	0.724	29	5.31	0.806	28	4.93	1.489	105	5.37	1.040

Table 5-19: Survey general conclusions

No statistically significant difference among survey groups on the statements of Iraq's current conditions as shown in Table 5-20. While there is a statistical significant difference among survey groups on the statement of the future of private sector participation in the PPP projects in Iraq.

Statement	Chi-Square (H value)	df	Asymp. Sig. (p-value)
Generally, do you agree that current Iraq conditions are suitable for private investment in infrastructure projects on basis of PPPs?	0.720	2	0.698
In the recent future, do you agree that PPP schemes in Iraq infrastructure projects are going to be extensively implemented if some criteria were improved?	6.564	2	0.038

Table 5-20: Kruskal Wallis test for survey general conclusions

5.2 Policy Recommendations for GoI

This section demonstrates; in form of policy recommendations; “What” needs to be done by GoI in order to implement a successful PPP project in Iraq, taking the specific context of Iraq. These recommendations are formed from the research findings, from interviews and the questionnaire survey results, the international and local literature review. The proposed policy consists of four main points these are: Government role and responsibilities, Regulatory framework role, Economic conditions role, and PPP risks analysis role. Figure 5-35 shows the main items of this recommendations policy.

In general, adopting a PPP scheme is not easy. PPPs are not easy to apply to infrastructure projects due to their complexity in contractual arrangements and the high level of uncertainty that arises from the long concession period. The experience of the public sector with PPPs has not always been positive. Many PPP projects are either held up or terminated due to many different reasons such as wide gaps between public and private sector expectations; lack of clear government objectives and commitment; complex decision making... etc.⁴⁸⁹ Despite numerous negative experiences, many governments (e.g., Germany and UK) continue to view PPPs as one of the key strategies for delivering public services and infrastructure. Therefore, understanding of PPPs continues to be a matter of significance and importance. To ensure the success of a PPP project, both the government and the concessionaire must be competent to implement the partnerships. Next sections will define steps to improve government competent in PPP.

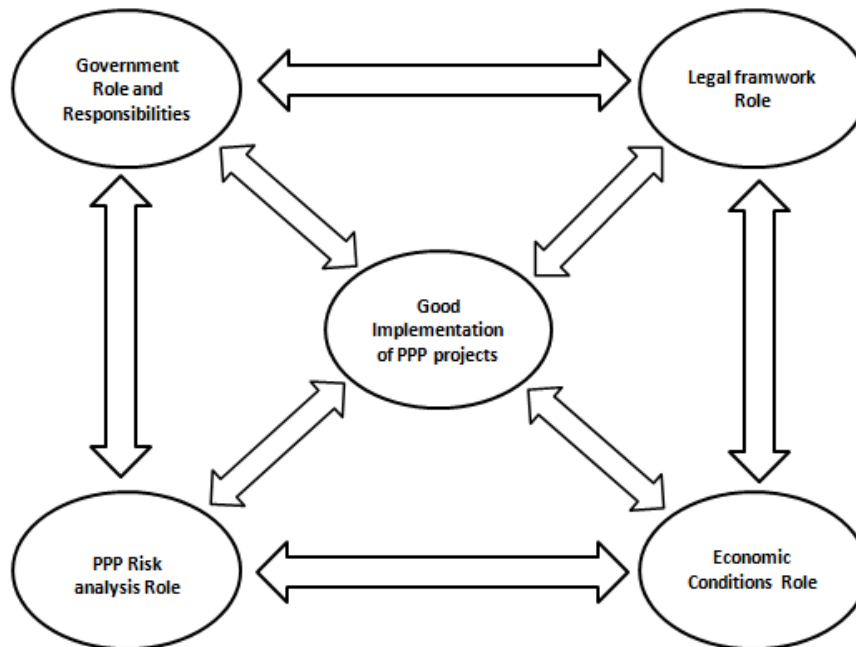

Figure 5-37: Proposed policy recommendation for GoI

⁴⁸⁹ Y.H. Kwak: Analyzing Asian Infrastructure Development Privatization Market. Journal of Construction Engineering and Management, Vol.12(2), 2002, P. 110-116.

5.2.1 Government Role and Responsibilities

The government plays a critical role in the development and management of a PPP project. The inappropriate involvement of government or the incapability of government to manage PPP projects may lead to project failure.⁴⁹⁰ Governments role can be represented by:

5.2.1.1 Government Stability

A strong political will from the government, can only promote the commissioning of PPP projects by overcoming resistance and giving a clear signal of the government's intention to meet its contractual commitments. The political stability of government interacts most significantly with the economic and technological components. Government stability would be a necessary precursor to the private sector lending money for the PPP projects and also for the Special Purpose Vehicles (SPVs) being prepared to risk significant bidding costs in preparing a project proposal. This means managing the pressures and expectations of elected bodies, the media, and other stakeholders, which often push implementing agencies for faster delivery. While political commitment is welcome and necessary, pressures for overly optimistic timelines need to be dealt with appropriately.

5.2.1.2 Establishing a Coordinating and Supportive Authority (PPP Unite)

The use of PPPs for infrastructure development would be efficiently introduced if a unit was created to streamline the implementation within a government. PPPs can succeed only if they are structured and planned in detail and are managed by expert dedicated teams - preferably, a single, centralized unit servicing as a 'one-stop' shop for investors and a nodal point for facilitating cooperation among the different government agencies. The unit could be central to all departments, which would be more efficient for:

1. Centralization of the PPPs experience, where the experience of different types of projects would help foster the procurement skills for other projects as well as future projects; and
2. Optimization of resources that would have to be spent by the different departments for acquiring the PPP knowledge.

A PPP unit would have to take a number of leading roles including: 1. policy development, e.g., through guidelines, approaches, and advice; 2. implementation and procurement management, e.g., assistance in the identification/assessment of PPP projects, selection of a PPP delivery system, development of project documents, selection of PPP contractors, and evaluation of proposals; and 3. PPP project approvals.⁴⁹¹

5.2.1.3 Develop a Clear PPP Policy, Prioritize and Assessment for PPP Projects

A clear policy is an important basis for a successful PPP framework. To develop a PPP Projects, government agencies need to understand PPPs and how they may be able to use them to achieve their policy ends. PPPs need to have detailed policy to install confidence and attract the

⁴⁹⁰ Previous reference.

⁴⁹¹ Ahmed M. Abdel Aziz: Successful Delivery of Public-Private Partnerships for Infrastructure Development. Journal of Construction Engineering and Management, ASCE, 2007, P. 918-931.

participation of private investors and commercial lenders. Equally, clear information on the PPP program reduces the cost to potential investors of considering opportunities in the country.

Additionally, the public sector should be aware that a PPP is not a panacea and may not be appropriate for all infrastructure projects. Appraise options should be taken (e.g., PPP or traditional route). The government should conduct a comprehensive feasibility study to examine the applicability and suitability (attractive and negative factors) of the PPP approach to a specific infrastructure project before it is implemented. Additionally, when several projects are intended to be developed under PPP, the government should also prioritize these projects by considering their financial strengths and weaknesses. Government of Iraq must have an explicit policy for transparency on all aspects of PPP projects. All the process leading to contractual agreement should be open to public participation and scrutiny.

5.2.1.4 Maintain Experience and Knowledge of the Government Staff

Successful implementation of PPP requires its participants to possess diverse skills and expertise in procurement, legal, and financial management. Therefore, the government should provide training in these areas to its employees, especially those at the regional and local level agencies. This training can be done by an established central PPP unit, or by professional training institutions. The government should also hire advisors who have actual experience in PPP projects to assist in their development. The acquisition of such expertise is generally beneficial in improving project delivery for PPPs, streamlining the implementation of PPPs within government, reducing bidding time and transaction costs for both public and private partners, and standardizing bidding procedures.

5.2.1.5 Maintain Competition

Competition is an important factor for PPP projects to succeed. Information asymmetry is reduced through competition. Higher the level of competition, greater is the incentive for operator to divulge all private information. When competition is lacking, whether in private monopoly or public, services deteriorate, customers do not have alternative choices and they are at the mercy of an unresponsive service provider. It is possible to induce competition through appropriate institutional arrangements.

5.2.1.6 Government Support and Guaranties

Respondents identified the availability of guarantees as an important factor in their decisions on whether to invest in a country. On the other hand, to increase the attractiveness of a PPP project to private investors, government may need to provide project-specific assistances and/or guarantees, such as the guaranteed minimum revenue, tax reduction for a certain time period and ensure adequate cash flow. The GoI is required to adopt robust studies before deciding to provide a support, particularly in the form of guarantees. The GOI needs to understand a guarantee's financial impact on the project sponsor and creditor and the full extent of contingent liabilities when providing a guarantee. A contingent liability analysis allows a government to measure the

effectiveness of a guarantee, based on which the government can determine which guarantee is most suitable for a given project.

5.2.1.7 Improve Responsiveness to the Needs of Investors

Respondents identified government unresponsiveness to their needs and time frames as one of the most important factor in the failure of PPP projects. And they considered the administrative efficiency of a host government one of the important factors in their decisions to invest in a country. Completing better preparation of transactions before inviting investors to participate can help reduce processing delays and the related opportunity costs for investors.

5.2.2 Regulatory Framework Role

5.2.2.1 Maintain the Stability and Enforcement of Laws through Long-Term Contract

The comprehensive and credible legal and regulatory framework is the principal key because it provides private-sector investors with certainty and security in doing their business, especially in the infrastructure projects that often involves very different risk profiles. In general, investors base long-term investment decisions on the reliability, applicability, and enforceability of laws and contracts. To have some assurance that these investments will succeed, investors want to see that the rights and obligations of private investors are clearly defined and that applicable laws and contracts are enforced.

Furthermore, Ehrhardt, *et al.* (2007)⁴⁹² stated that good regulatory mechanisms possess five attributes: Coherence, Predictability, Credibility, Legitimacy and Accountability. Coherence is defined as the ability of a regulatory system to select the right combination of tariffs and service standards, such that providers can recover costs and people receive the services they are willing to pay for. Predictability results from regulatory decisions that are time consistent and made on clear precedents and rules. Credibility is the existence of credible protection against political opportunism which could prevent recovery of cost. It also implies ability to protect from market power of private operator. Legitimacy is the existence of decisions that are clear, widely accepted and publicly accessed. Accountability to the public and transparency in decision making are also important attributes.

5.2.2.2 Availability of PPP Legislation Define PPP Forms and Requirements

A PPP legal framework needs to be established within the government to institutionalize the implementation of a PPP into a structured program. For Gol, such a law is essential because government bodies are not aware of their legal and financial powers for entering into PPP contracts. PPP law should be broad enough in its language to give the authority (e.g., to PPP unit)

⁴⁹² Ehrhardt, D., Groom, E., Jonathan, H., & O'Connor, S.: Economic regulation of urban water and sanitation services: Some practical lessons. Feb 25, 2008.

to evaluate and judge the controversial issues such as quantification and cost allocation of changes in future scope/service, noncompeting clause, length of concessions, and the allocation of specific risks (e.g., cost of extra demand, and subsurface conditions). These would be part of the guidelines to be detailed by the PPP unit in guidance reports. The law, however, needs to be clear in explaining the noncontroversial issues such as: types of project ownership, PPP specific model (e.g.; BOT and BOO), projects types (e.g., pilot projects), methods used in the value-for-money analysis (e.g., public sector comparators, quantification of risks, life cycle cost analysis, revenue modelling, financial analysis), and evaluating any financing mechanism.

The law should clearly articulate government's intent and specify the powers, roles and responsibilities of the government bodies in respect to PPP contracts. Further, it should also specify fair protection to property rights of the private operator which may enter into PPP contracts. Furthermore, guidelines and policies would then be developed to interpret the initiative and to provide tools that standardize the implementation at the different government levels. Without guidelines, it would be difficult to institutionalize PPPs for infrastructure development.

5.2.3 Economic Conditions Role

5.2.3.1 Market Demand

A critical aspect of any PPP contract is the market demand between the government and the contractor. The means through which demand risk is allocated is the payment mechanism.

5.2.3.2 Financing Technique and Strategies

A sound financial plan is critical to the success of a PPP project. This importance is reflected in the higher weight assigned to the financial criteria in evaluating PPP proposals.

5.2.3.3 Economic Environment

The willingness of private investors to participate in PPP infrastructure projects depends greatly on the economic environment in which these projects are operated. Therefore, for PPP to work, the government should create a favourable investment with stable social, legal, economic, and financial conditions.

5.2.3.4 Ensure Adequate Cash Flow in the Project

One of the highest priorities identified by respondents was adequate tariff levels and collection discipline. Investors are unlikely to consider on investment if these conditions are not present.

5.2.4 PPP Risks Analysis Role

A striking characteristic of the PPP is its high level of risks, due mainly to the long concession period, and the diversity of participants involved in the partnership. Therefore, risk management is an integral part of the PPPs procurement processes and procedures. The whole concept of PPP arrangement is based on an appropriate and clear allocation of risks and responsibilities, thereby delivering value for money to the client through minimizing the potential for future disputes and difficulties of cost overruns. The risk management process in PPP projects is:⁴⁹³ (1) Risk identification, (2) Risk assessment, (3) Risk allocation, (4) Risk mitigation (for more information See chapter two).

⁴⁹³ Alfen, Hans-Wilhelm, *et al*: Public-Private Partnership in Infrastructure Development- Case Studies from Asia and Europe. Bauhaus-Universität Weimar, Faculty of Civil Engineering, Chair Construction Economics, 2009. p. 35.

6 Conclusions

This chapter completes the discussion of the PPP development in Iraq by presenting research conclusions. It also highlights recommendations and suggestion for future studies regarding the infrastructure privatization decisions. Body of knowledge contributions and potential areas for further study are identified.

6.1 Summary of Research Findings

Due to the impacts of financial difficulties, technical inefficiency, and poor quality of services under traditional public procurement, Government of Iraq began turning to the private sector in power generation since 2006. At present, the PPP projects in the power sector comprise about 27% of the total generated electricity in Iraq. The government invited foreign and local investors and IPP to be approached to invest in the electricity sector in negotiable form which may include: (BOT), (BOO).

This study initially explores the concepts and philosophies of PPP and illustrated what PPP is, and what advantages and disadvantages this kind of partnership delivers. In addition, the reasons for PPP implementation were reviewed and circumstances surrounding them were explored. Current Iraq infrastructure projects situations and needs were studied, as well as, some aspects relating to the Iraq's construction market, Iraqi legal, financial and contract systems were discussed.

Due to difficulties in getting data from a real case study, a financial model was carried out and applied to a real-life case study project to obtain the distribution of net present value NPV of the project from the view point of equity. Six representative scenarios have been demonstrated, most of those cases where taken from the Iraqi Ministry of Electricity. Based on generated cumulative distribution of NPV, it can be computed that the entire equity can expectedly be back paid in year 9 of the operation period in the best scenario case (case A). Results showed that NPVs are different according to the case scenario. The project sponsor (equity holder) is exposed to the greatest degree of risk, equity investment cannot be back paid unless all other obligations (debt, O/M costs, and etc.) are paid but can enjoy great returns as risk premium if the project runs successfully. The output indicated that the equity investor's return increases significantly after the paying of all other obligations.

In fulfilling the study aims, this thesis not only provides the literature on PPPs, but also assesses the responds from the construction players on the study matters of this thesis. Due to lack of knowledge, comprehensive database on PPPs in Iraq, international resources are used in obtaining the relevant information where significantly the key variables of the PPP are successfully developed with the assistance of the responses of a questionnaire survey targeted at industry experts and professionals from researchers, public-and private-sector organizations.

Findings from the questionnaire survey at Chapter 5 showed that the private sector participants tended to have experience in projects both locally and overseas. Practitioners in public sector may not have the necessary talents to conduct PPP projects due to the minimal PPP project experience in Iraq. Therefore, gaining experience or importing expertise has been a solution. Instead Iraq should consider training their own people in the public and private sector to involve in PPP projects.

PPP in Iraq is a relatively new approach to procurement and lessons could be drawn from the experiences of developed and developing countries on the conditions for the success of PPP. As a relatively late entrant in the PPP development process, Iraq can learn and benefit from these lessons.

Projects best suited for PPP; from the survey respondent perspectives; include ones that are economically viable. Often the success of a project is measured by the economics, especially for the private sector. Furthermore, the top three attractive factors of PPP in Iraq were, solve the problem of public sector budget shortage, followed by technology transfer to local enterprise through the private sector's Know-How, and social pressure of poor public facilities. The negative factors in adopting PPP projects were also derived. The results found that the top three negative factors in Iraq were: very large tendering-contracting and re-negotiation costs, and, difficulties of ensuring future good performance, and higher capital cost.

There are several differences between the PPP method and the traditional practice. Results highlight that main differences include PPP projects utilize private sector expertise and skills, PPP projects utilize private sector finance, and difference in risk profile for each party involved. It is likely that the PPP project will be supported fully by the private sector skills and know-how, as well as, supported by the financing from the private sector. And also in PPP projects the public sector tends to prefer letting the private sector take a share of the risks involved.

As highly expected, the survey respondents believe that risks under the GOI control require some kind of government supports in terms of guarantees. Near 63% recommend that guarantee are required to prepare the private sector to pursue an infrastructure project under a PPP concession.

There are no federal or state laws which explicitly specify government's intent of PPP in infrastructure projects, the process for PPP structuring and powers of authority competent to take decisions. Such a law is essential because municipal and urban local bodies are not aware of their legal and financial powers for entering into PPP contracts.

One of the most important aims of this study was to identify and allocation risks in public private partnerships and to propose a decision framework in the allocation of risks to the parties within these partnerships. The survey respondents concur that government stability and administrative efficiency rank high on the list of risks associated with infrastructure projects, followed by poor public decision-making process and land acquisition risks. Furthermore, a new method for risk allocation was applied, on risk allocation preferences, this research shows that (40%) of risk factors are preferred to be allocated to the private sector, as well as (40%) risk factors are to be allocated to the public sector and (20%) of the risk factors are to be equally shared between the private and public sectors.

The research finds that PPP in Iraq infrastructure projects is a possible reform option if institutions and regulations are well designed. But to successfully negotiate and manage PPP contracts, the government must possess certain basic capabilities. In other words, PPP does not imply that government ceases to play a role in infrastructure projects. Instead, there is a re-definition of the role of the government as that of an effective regulator and the new responsibility is often a greater challenge. The government must develop its capabilities before embarking on PPP. With contract design that reduces information asymmetry and provides right incentives, it is possible to vastly improve the quality of service through private sector participation.

In conclusion, Iraq has a bright future, and this will only be enhanced as the legal framework for project financing is more fully and consistently developed. The opportunities in Iraq, however, are not without their unique challenges. The region is volatile, but so is much of the developing world. Investing in any developing nation involves some risk. However, for those who go into it being aware of those risks, and with a plan for mitigating them, the outcome can be rewarding. Iraq is definitely not a place to enter lightly. It requires a serious approach, a long-term commitment, and a deep knowledge of the intricacies of doing business in what is truly rich and attractive part of the world.

In a general sense, the current situation has not been suitable to attract private sector participation in the infrastructure projects, but optimism remains provided that the situation can be improved.

6.2 Limitations of Research

There are a few limitations relating to this research study in terms of the methodology deployed, the results and findings. These limitations are highlighted as follows:

First, the results of this study reflected the perspectives of those who participated in the survey. Thus the generalization of the results is limited by the population used. However, to generalize the modest conclusions reached in this study, it may be necessary to plan and implement a research agenda that would require data to be drawn from participants in developing countries with comparable institutional conditions and PPP experience as Iraq's. Such an expedition may require some modifications to the main research work. Nevertheless, the results of this study could still help policy makers and PPP private sector players to better understand of what are needs for implementing PPP.

Second, this research dealt with the views of three major stakeholder groups: Researchers, private and public sectors. The limitation here is that some of the participants straddle more than one of these three groups in terms of classification. For instance, participants from researchers could be categorized as belonging to both the public and private sector stakeholder groups. Also the views of an important stakeholder group, such as end-users of projects/services, were not taken on board in this study. Although it is important to acknowledge that this group is highly dispersed depending on which infrastructure project one is focusing attention and risks may not be allocated directly to them in PPPs.

Lastly, this study considered the views and opinions of stakeholders selected mostly on a convenience sampling method due to the dearth of PPP practitioners in Iraq thus susceptible to selection bias. Also, this sampling method could limit the diversity of the information and data. Although, reasonable diligence was exercised to ensure that participants had some experience and/or knowledge of PPPs.

6.3 Suggested Areas of Future Research

Some recommendations for further research work are also proposed:

- 1) The questionnaire survey adopted for this research study could be repeated with other stakeholder players to whom risks may be allocated disproportionately: i.e. the end user, third party specialists such as the insurers, to enable an comparison with the results obtained.
- 2) This study also generally lumps all private sector players together- to whom risks may be allocated disproportionately: i.e. the sub-contractors, investors, third party specialists such as the insurers. It is assumed that risks are shared mainly between the public sector partner and a single private sector entity (Project Company) to fit the mould of the agency theoretic framework used in this study. It may be useful to examine this in the context of agency problems that could occur even among the multiple private sector participants e.g. between the concessionaire and a sub-contractor with assumption of goal congruence.
- 3) Analyze specifically the role of institutions in shaping the outcomes of PPPs (perhaps as a critical success factor), in the context of Iraq; specifically examining the impacts of weak institutions on projects using a case study approach. This is important as it is yet to be established that PPPs are indeed helping to address the problem of infrastructure in the country and indeed in other developing countries.
- 4) The relative weighting of the attractive and negative factors should be identified, so that the checklist for identifying suitable PPP projects could provide a more accurate assessment.

Bibliography

- Abdul Jabbar, Khalaf:** Status of Waste Water in Iraq. Pare Submitted to Ministry of Water Resources (MoWR), Iraq, 2011.
- Abbas M.:** Risk Management in Construction Projects. PhD. thesis, Baghdad University, Iraq, 2003.
- Abdullatif, E.:** Development of Government Bond Market in Iraq. Institute of Developing Economies, Japan External Trade Organization, 2009.
- A.D. Ibrahim, A.D.F. Price and A.R.J. Dainty:** The Analysis and Allocation of Risks in Public Private Partnerships in Infrastructure Projects in Nigeria. *Journal of Financial Management of Property and Construction*, Vol.11 (3), 2006.
- Ahmed M. Abdel Aziz:** Successful Delivery of Public-Private Partnerships for Infrastructure Development. *Journal of Construction Engineering and Management*, ASCE, 2007.
- Akintoye, A. and Chinyio, E.:** Private Finance Initiative in the Healthcare Sector- Trends and Risk Assessment. *Journal of Engineering Construction and Architectural Management*, Vol. 12(6), 2005.
- Akintoye, A., M. Beck, et al.:** Framework for Risk Assessment and Management of PFI Projects. Glasgow, Glasgow Caledonian University, 2001.
- Akintoye, A., M. Beck and Hardcastle, C.:** Public Private Partnerships-Managing Risks and Opportunities. Glasgow, Glasgow Caledonian University, 2003.
- Akintola A., Matthias B., Cliff H.:** Public-Private Partnerships, School of the Built and Natural Environment. Glasgow Caledonian University, 2003.
- Al-Araji, Sami:** Commencement of Housing Program. National Investment Commission, Iraq, 2010.
- Al-Bahar, J., and Crandall, K.:** Systematic Risk Management Approach for Construction Projects. *ASCE Journal of Construction Engineering and Management*, Vol. 116 (3), 1990.
- Albert P. C. Chan, John F. Y. Yeung, Calvin C. P. Yu, Shou Qing Wang, Yongjian Ke:** Empirical Study of Risk Assessment and Allocation of Public-Private Partnership Projects in China. *Journal of Management in Engineering*, Vol. 27(3), 2011.
- Alfen, Hans-Wilhelm, Mayrzedt, Hans, Tegner, Henning:** PPP-Lösungen für Deutschlands Autobahnen: Empfehlungen für eine erfolgreiche Umsetzung. Bauhaus-Universität Weimar, Germany. 2004.
- Alfen, Hans-Wilhelm, Kalidindi, Satyanarayana N., Ogunlana, Stephen, Wang, ShouQing, Abednego, Martinus P. , Jungbecker, Andrea Frank, Jan, Yu-Chien Amber, Ke, Yongjian,**

- Liu, YuWen, Singh, L. Boeing, Zhao, GuoFu:** Public-Private Partnership in Infrastructure Development- Case Studies from Asia and Europe. Bauhaus-Universität Weimar, Faculty of Civil Engineering, Chair Construction Economics, 2009.
- Allan, J. R.:** Public-Private Partnerships-A Review of Literature and Practice (Rep. No. 4), Saskatchewan Institute of Public Policy, 2001.
- Andersen, Inger, Chiquier, Loïc and Larbi, Hedi:** Iraq Investment Climate Assessment. World Bank, 2012.
- Anthony T, Odoemena and Masahide Horita:** Government Commitment and Dynamic Inconsistency in Public-Private Partnership for Infrastructure. 10th Conference on Applied Infrastructure Research, University of TOKYO, 2011.
- Asian Development Bank (ADB):** Public-Private Partnership Handbook, 2008.
- Asenova, D. and M. Beck.:** A Financial Perspective on Risk Management in Public-Private Partnership. Public-Private Partnerships-Managing Risks and Opportunities. Blackwell Science Ltd, Oxford, UK, 2003.
- Austin, C., Borja, R., & Phillips, J.:** Operation Solar Eagle-A Study Examining Photovoltaic (PV) Solar Power as an Alternative for the Rebuilding of the Iraqi Electrical Power Generation Infrastructure. Monterey, California, Naval Postgraduate School, 2005.
- Australian Government:** Iraq FactSheet. Department of Foreign Affairs and Trade. 2013, <http://knoema.com/atlas/Iraq/CPI-inflation>.
- Bacon R.W. and J. Besant-Jones:** Global Electric Power Reform-Privatization and Liberalization of the Electric Power Industry in Developing Countries. Annual Rev. Energy Environ, Vol. 26, 2001.
- Baghdad Provincial Council:** 2008-2012 Strategic Plan Report, Iraq, 2007.
- Barrie, D. and Paulson, B.:** Professional Construction Management. 1st. ed., McGraw-Hill, New York, 1978.
- Barnier, Michel:** Guidelines for Successful Public Private Partnerships, European Commission, Brussels, 2003.
- Basri, Kamal:** The Strategic Choice of the Iraqi Economy. Iraqi Institute for Economic Reform, Baghdad University, 2011.
- Bass, B.M., McGregor, D.W. and Walter, J.L.:** Selecting Foreign Plant Sites-Economic, Social and Political Considerations. Academy of Management Journal. Vol.20, 1977.
- Bakir, H. A.:** Sustainable Wastewater Management for Small Communities in the Middle East and North Africa. Journal of Environmental Management, Vol. 61(4), 2001, P. 319-328.

- Baloi, D. and Price, A.D.F.:** Modeling Global Risk Factors Affecting Construction Cost Performance. *International Journal of Project Management*, Vol. 21, 2003, P. 261–9.
- Ball, R, M Heafey & D. King:** Risk Transfer and Value for Money in PFI Projects. Paper for Public Management Review, forthcoming, 2003.
- BECK, Benedikt:** PPP in Sweden and Germany: A comparison, Bachelor thesis, Department of Real Estate and Construction Management, Real Estate Economics, 2010.
- Berg, S.V., Pollitt, M.G. and Tsuji, M.:** Private Initiatives in Infrastructure. Edward Elgar, Cheltenham, United Kingdom, 2002.
- Bennett, E.:** Public-private Cooperation in the Delivery of Urban Infrastructure Services (Water and Waste). Background paper- Public Private Partnerships for Urban Environment Programme (PPPUE), United Nations Development Programme, UNDP, New York, 1998.
- Berenson, Mark L., Levine, David M., Krehbiel, Timothy C.:** Basic Business Statistics: Concepts and Applications. 12th edition, Prentice Hall, 2009.
- BMVBS:** PPP im öffentlichen Hochbau, Band IV, Berlin, 2003.
- BMVBS:** PPP im öffentlichen Hochbau, Band II, Berlin, 2003.
- BMVBS:** Erfahrungsbericht ÖPP in Deutschland, Berlin, 2007.
- Boussabaine, Abdelhalim:** Cost Planning of PFI and PPP Building Projects. 1st edition, Taylor & Francis, New York, 2007.
- Brealey, R A and Myers, S C.:** Principles of corporate finance, 4th edition, Irwin McGraw Hill, New York, 1991.
- Brigham, E., and Gapenski, L.:** Financial Management-Theory and Practice. 8th. Edition, Dryden Press, Fort Worth, Texas, 1997.
- Carrillo, P., Robinson, H., Foale, P., Anumba, C., Bouchlaghem, D.:** Participation, Barriers and Opportunities in PFI-The United Kingdom Experience. *Journal of Management in Engineering*, ASCE, Vol. 24(3), July 2008.
- Central Bank of Iraq:** Annual Report. Ministry of Financing, Baghdad, Iraq, 2013.
- Central Bank of Iraq:** Annual Report. Ministry of Financing, Baghdad, Iraq, 2012.
- Chan, D.W.M., Chan, A.P.C. and Lam, P.T.I.:** A Feasibility Study of the Implementation of Public Private Partnership (PPP) in Hong Kong. Proceedings of the CIB W89 International Conference on Building Education and Research, April 10-13, 2006.
- Chan, K. C., Chen, C. R. and Steiner, T. L.:** Research Productivity of the Finance Profession in the European Region. *Journal of Business Finance and Accounting*, Vol. 31 (3 & 4), 2004.

- Chen, W.T. and Chen, T.T.:** Critical success factors for construction partnering in Taiwan. *International Journal of Project Management*, Vol. 25(5), 2007.
- Chen, T.:** Brief Description and Operation of Financial Planning and Modelling. Conference on Private Investment on Transport Construction, Ministry of Transportation and Communication of Taiwan, 1998.
- Chege LW, Rwelamila PD:** Risk Management and Procurement Systems – An Imperative Approach. Department of Construction Economics and Management, University of Cape Town, South Africa, 2000.
- Cheung, E., Chan, A.P.C., Kajewski, S.:** Suitability of Procuring Large Public Works by PPP in Hong Kong. *Journal of Engineering Construction and Architectural Management*, Vol.17 (3), 2010.
- Cohen, J.:** Statistical power analysis for the behavioral sciences. New York, Academic Press, 1969.
- Cohen, J.:** Statistical power analysis for the behavioral sciences. Hillsdale, NJ. Erlbaum, 1988.
- Construction Financial Management Association (CFMA):** Financial Management and Accounting for the Construction Industry. Vol. 1, No. 14, 2002.
- Cooper D., Grey, S., Raymond, G., & Walker, P.:** Project Risk Management Guidelines-Managing Risk in Large Projects and Complex Procurements. John Wiley & Sons Ltd, England, 2005.
- COWI:** Rammekontrakt om tjenesteydelser til brug for OPP-forundersøgelser. Copenhagen, 2007.
- Dailami, M. and Leipziger, D.:** Infrastructure Project Finance and Capital Flows- A New Perspective. Policy Research working paper No. 1861, World Bank, Washington, DC, 1997.
- Dawn Bidne, Amber Kirby, Lucombo J. Luvela, Benjamin Shattuck, Sean Standley., and Stephen W.:** The Value for Money Analysis-A Guide for More Effective PSC and PPP Evaluation, American University (presented at American University, Washington, District of Columbia, April 23, 2012),
<http://www.ncppp.org/resources/papers/Value%20for%20Money%20Analysis.5.10.12.docx>.
- De la Cruz, M. P.:** Integrated Methodology for Project Risk Management, PhD thesis, Univ. of Madrid, Spain, 1998, in del Cano, A.: *Journal of Construction Engineering and Management*, ASCE, Vol. 128(6), 2002.
- Delmon, J.:** BOO/BOT Projects- A Commercial and Contractual Guide. Sweet & Maxwell Limited, London, 2000.
- Department of Treasury:** Public Private Partnerships-Public Sector Comparator Policy, Additional Policy guidance, Government of Western Australia, 2011.
- Develles, R.F.:** Scale Development. Sage Publications, 1991.

- DFA Public Private Partnerships:** Guideline-Commonwealth Policy Principles for the Use of Private Financing. Introductory Guide. Financial Management Guidance, Australian Department of Finance and Administration (DFA), Canberra, Australia, 2005c.
- Deutsches Institut für Urbanistik (Difu):** PPP und Mittelstand, Berlin, 2008.
- Deutsches Institut für Urbanistik (Difu):** PPP – eine aktuelle Bestandaufnahme in Bund, Ländern und Kommunen, Berlin, 2005.
- Dias, A and Ioannou, P G:** Optimal Capital Structure for Privately Financed Infrastructure Projects – Valuation of Debt, Equity, and Guarantees. UMCEE Report No. 95-10, Department of Civil and Environmental Engineering, University of Michigan, 1995.
- Dirk Daube, Susann Vollrath, Hans Wilhelm Alfen:** A comparison of Project Finance and the Forfeiting Model as financing forms for PPP projects in Germany, International Journal of Project Management, Vol. 26 , 2007.
- Douglas Ducharme:** Survey Response Categories-Guide for Using Neutral or N/A Options. War Gaming Department United State Naval College, 2014.
- Doyle, Brendan:** Iraq Watching Briefs – Water and Environmental Sanitation, UNICEF, 2006.
- Dunia Frontier Consultants:** Water and Sewage Sectors in Iraq-Sector Report. Washington DC, 2013.
- EBST:** OPP – Vejledning til basiskontrakt. Copenhagen, 2005.
- EBST:** Vejledning om OPP til bekendtgørelse om OPP, partnering og nøgletal, Copenhagen, 2004.
- E-Government Program:** Guide of the Partnership between the Public and Private Sectors. Kingdom of Saudi Arabia, 2004.
- Ehrhardt, D., Groom, E., Jonathan, H., & O'Connor, S.:** Economic regulation of urban water and sanitation services: Some practical lessons. Feb 25, 2008.
- Elbing C. and Devapriya K.A.K.:** Structured Risk Management Process to Achieve Value for Money in Public Private Partnerships. Journal of Financial Management of Property and Construction, Vol. 9(3), 2004.
- Farrah, T.:** Brumby Wins Battle to Keep East Link Costs Secret, 2007.
<http://www.theage.com.au/news/national/brumby-wins-battle-to-keep-eastlink-costs-secret/2007/02/13/1171128974031.html>.
- Ferreira, D and Khatami, K:** Financing Private Infrastructure in Developing Countries. Paper No 343, World Bank, Washington, D.C, 1996.
- Finnerty, J.D.:** Project financing: asset-based financial engineering. 1st ed., USA: John Wiley & Sons, 1996.

- Flyvbjerg, B., Bruzelius, N., & Rothengatter W.:** Megaprojects and Risk. Cambridge-Cambridge Press, 2008.
- GAO. :** Integrated Strategic Plan Needed to Help Restore Iraq's Oil and Electricity Sectors. Washington, United States Government Accountability Office, 2007.
- Gavin M.H.:** Risk Transfer –Critical For Privately Financed Projects. Conference for Trans European Promotion of Public-Private Partnership, Warsaw University of Technology, Warsaw, Poland, 2010.
- General Directorate for Water:** Water Demand and Supply in Iraq-Vision. Approach and Efforts, Ministry of Municipalities and Public Works, Iraq, 2011.
- G, Fishbein and S, Babbar:** Private Financing of Toll Roads. RMC Discussion Paper Series No. 117. World Bank, Washington, D.C, 1996.
- Gramlich, E. M.:** Infrastructure Investment a Review Essay, Journal of Economic Literature, Vol.32, 1994.
- Goodman, Alvin S. and Hastak, Makarand:** Infrastructure Planning Handbook-Planning, Engineering and Economics. ASCE,2006.
- Grimsey, D., and Lewis, M.:** Evaluating the Risks of Public Private Partnerships for Infrastructure Projects. International Journal for Project Management, Vol. 20(2), 2002.
- Grimsey, D. and Lewis, M.K.:** Public Private Partnerships- The Worldwide Revolution in Infrastructure Provision and Project Finance. Edward Elgar, Cheltenham, The United Kingdom, 2004.
- Gunzon:** Financial Analysis for Public-Private Partnership. Government Finance Research Centre, Washington, D.C, 1998.
- Goldbach, Claire et al:** Public Cost Comparator for Public-Private Partnerships, National Council for Private-Public Partnerships, 2012.
- Harris, Frank und McCaffer, Ronald:** Moderne Baumanagement. 5th Edition Schwarz und Science Ltd, Wiley, Malden USA, 2001.
- Hallaq, K.:** Causes of Contractors' failure in Gaza Strip. MSc thesis, Islamic University of Gaza Strip, 2003.
- Hans C. Ohanian, John T. Markert :** Physics for Engineers and Scientists. Third Edition, Vol. 1, 2006
- Harvey, Charles:** Analysis of Project Finance in Developing Countries. 1st edition, Heinemann, London, 1983.

Hesham, Mohsen: Spatial Analysis of Iraqi Railways, Journal of Literature Faculty, Iraq, Vol. 100, 2012.

Hin Mun, Lee: Analysis of Public Private Partnership for Toll Road Projects. MSc thesis, Lehrstuhl für Bauprozessmanagement und Immobilienentwicklung der Technischen Universität München, 2009.

Hrvoje Segudovic: Qualitative Risk Analysis Method Comparison. INFIGO-MD, 2006.

Web Site :

<http://misbahkamal.blogspot.de/2012/03/world-bank-iraqs-insurance-sector.html>

Web Site :

http://www.ats.ucla.edu/stat/mult_pkg/faq/general/effect_size_power/effect_size_power.htm.

Web Site :

<http://www.ppp-bund.de/en/home.htm>.

Hwang, Bon-Gang, Zhao, Xianbo, Shu Gay, Mindy Jiang: Public Private Partnership Projects in Singapore-Factors, Critical Risks and Preferred Risk Allocation from the Perspective of Contractors. International Journal of Project Management, Vol. 31(3), April 2013.

IAU Iraq: IKN 2011 Essential Services Factsheet, Baghdad, Iraq, 2011.

Information Services Department: Shatin-Central link Construction Set for 2010. Hong Kong Special Administrative Region Government, Hong Kong, 2008b.

Infrastructure Australia: National Public Private Partnership Guidance. Vol. 4, 2008.

Initiative D21 et al.: Prozessleitfaden PPP, Berlin, 2003.

International labor organization (ILO): World Employment Report 2004-05- Employment, Productivity and Poverty Reduction, 2004.

Iraq Public Contracts Law 2008, Iraq.

Iraq Commercial Law No. 30 of 1984, Iraq.

Iraq Investment Law No. 13 of 2006, Iraq.

Irimescu, Gabriel: Bewertung von ÖPP- und konventioneller Beschaffungsvariante aus Sicht der öffentlichen Hand und der Privatwirtschaft. Masterarbeit am Lehrstuhl Bauprozessmanagement und Immobilienentwicklung an der TU München, München, 2012.

Irwii, Tinmotliy: Public Money for Private Infrastructure, Deciding When to Offer Guarantees, output-based subsidies, and other fiscal support, working paper No.10, the World Bank, Washington D.C, 2003.

- Irwin, T., Klein, M., E. Perry, E.G., and Thobani M.:** Managing Government Exposure to Private Infrastructure Risks. The World Bank research observer, Vol. 14(2), 1999.
- Islam, Md. Mainul:** Optimizing Concessionary Items' Values for Procuring Privately Financed Infrastructure Projects. PhD thesis, Griffith School of Engineering Science, Environment, Engineering and Technology, Griffith University, 2008.
- ISO 31000 of Risk Management Standard:** Risk Management-Principles and Guidelines. 2009.
- Izaguirre, A. K .and Geetha, R.:** Private Activity Fell by 30 Percent in 1999. Note no. 215, World Bank, Washington, D.C, 2000.
- Jaafari A.:** Management of Risks Uncertainties and Opportunities on Projects- time for a fundamental shift. International Journal of Project Management, Vol.19, 2001.
- Jensen, Jesper Ole:** Development of PPP in Germany, Draft, Copenhagen, 2007.
- Keown. A.J. et al.:** Financial Management-Principles and Applications, 10th Edition, Pearson Prentice Hall, Upper Saddle River, NJ, 2005.
- Khan, M. Fouzul Kabir and Parra, Robert J.:** Financing Large Projects- Using Project Finance Techniques and Practices. Pearson Education Asia Pte Ltd, 2003.
- Kohli, H et al.:** Making the Next Big Leap-Systemic Reform for Private Infrastructure in East Asia. World Bank, Washington, D.C., 1997.
- Kurdistan Investment Committee:** Gateway to Iraq. Kurdistan Region Government, 2014.
- Kwak, Y., Chih, Y. and William, C.:** Towards a Comprehensive Understanding of PPPs for Infrastructure Development. California Management Review. Vol. 51, No. 2, 2009.
- Kwan, Jenny:** Public Private Partnership a Guide for Local Government. British Columbia, Ministry of Municipal, 1999.
- Lam, K. C., Wang, D., Lee, T. K., and Tsang, Y. T.:** Modeling Risk Allocation Decision in Construction Contracts. International Journal for Project Management, Vol. 25(5), 2007.
- Leiringer, R.:** Technological Innovation in PPPs- Incentives Opportunities and Actions. Journal of Construction Management and Economics, Vol. 24, March 2006, P. 301-308.
- Levy, S.:** Construction Process Planning and Management-An Owner's Guide to Successful Projects. Elsevier Inc., 2010.
- Liddle, B.:** Privatization decision ad civil engineering projects. Journal of Construction Engineering and Management, ASCE, vol. 13(3), 1997, P. 73-78.
- Li, B.:** Risk Management of Construction Public Private Partnership Projects. PhD. Thesis, Glasgow Caledonian University, United Kingdom, 2003.

- Li, B., Akintoye, A. Edwards, P.J. Hardcastle C.:** The Allocation of Risk in PPP/PFI Construction Projects in the UK. *International Journal of Project Management*, Vol.23 (1), 2005.
- Mansour, A. and H. Nadji :** Performance Characteristics of Infrastructure Investments. RREEF Research 128 MIG (Macquarie Infrastructure Group), SR 125 South Financial Close, 2007.
- Maski, E., & Tirole, J.:** Public-private partnerships and government spending limits. *International Journal of Industrial Organization*, Vol. 26, 2008.
- Master Planning and Capacity Building Program:** Report of United Nations Development Group. Iraq trust fund, 2010.
- Matson, J.:** Cooperative Feasibility Study Guide. United States Department of Agriculture, Rural Business – Cooperative Service, Report 58, USA, 2000.
<http://www.rurdev.usda.gov/rbs/pub/sr58.pdf>.
- Mazhar Mohammed Saleh:** Dialectic of Iraq's Infrastructure- Financing and Guarantees. Central Bank of Iraq, 2012.
- Mercer, William:** Evaluation of the Outsourcing Decisions for Power Station Operations and Maintenance Services. Athabasca University Centre for Innovative Management MBA Applied Project, 2005.
- MENA-OECD Investment Program:** A Methodology for Infrastructure Prioritization in Iraq, 2010.
- Mhmed Abdul Elah M.:** The Influence of Civil Project Management Methods on Implementation of Cities Infrastructure Project, Master thesis, Higher Institution of Urban & Regional planning, Baghdad University, 2009.
- Miller, D.:** Handbook of Research Design and Social Measurement. California: SAGE Publications Ltd, 1991.
- Ministry of Electricity:** Tender Rules of Power Purchase Contract, Baghdad, Iraq, 2010.
- Ministry of Electricity:** Report, Iraq, 2008.
- Ministry of Electricity:** Electricity Demand Report. Baghdad, Iraq, 2010.
- Ministry of Electricity:** Electricity Master Plan, Baghdad, Iraq, 2011.
- Ministry of Construction and Housing:** Report of Institutional and Training Needs Assessment for Establishment of Iraq Housing Information and Training Center, 2012.
- Ministry of Finance:** Iraq Budget Reports. Iraq, 2014.
- Ministry of Transportation and Communications:** Report, Iraq, 2012.
- Ministry of Transportation and Communications:** Railways Activity Statistics Report, Iraq, 2011.

- Ministry of Transport and Communication:** Transport and Communication Sector Report, Iraq, 2011.
- Ministry of Municipalities and Public Works:** Report, Iraq, 2012.
- Ministry of Municipalities and Public Works:** Report, Iraq, 2013.
- Ministry of Municipalities and Public Works:** Report of Water and Sanitation Sector. Iraq, 2011.
- Ministry of Planning:** Railways Activity Statistics Report, Iraq, 2010.
- Ministry of Planning:** National Development Plan 2013-2017, Iraq, 2013.
- Ministry of Planning:** National Development Plan 2010-2014, Iraq, 2010.
- Ministry of Planning:** Report, Iraq, 2013.
- Ministry of Planning:** Water Sector Report. Central Organization for Statistics, Iraq, 2011
- Ministry of Planning:** Water Sector Report, Central Organization for Statistics, Iraq, 2012.
- Ministry of Planning:** Unsatisfied Basic Needs Mapping and Living Standards in Iraq, 2010.
- Mohamed Barakat:** Statistical Analysis Using the SPSS Program. Islamic University, Department of Economics and Applied Statistics, Gaza, Palestine, 2007.
- Munro, David:** Overview of the Iraqi Banking System-The State Owned Banks. U.S. Agency for International, 2007.
- Naser , Sahar:** Financial Sector Review. World Bank, 2009.
- National Investment Commission:** Investor Guide to Iraq, Iraq, 2009.
- National Investment Commission:** Iraqi Investment Map. 2012.
- National Investment Commission:** Investment Overview of Iraq-Banking and Finance Guide. Iraq, 2009.
- National Investment Commission and UK trade & investment:** The New Iraq Discovering Business. 2011. www.invest.promo.gov.iq.
- Nevitt, Peter K.:** Project Financing, in World Bank: Concessions for infrastructure, A guide to their design and award, 5th edition, Euromoney Institutional Investor, 1989.
- OBB:** PPP zur Realisierung öffentlicher Baumassnahmen in Bayern, Teil 1, München, 2006.
- OBB :** PPP zur Realisierung öffentlicher Baumassnahmen in Bayern, Teil 2, München, 2006.
- OBB:** PPP zur Realisierung öffentlicher Baumassnahmen in Bayern, Teil 3, München, 2006.

- OBB:** PPP zur Realisierung öffentlicher Baumaßnahmen in Bayern, kleine mittelstandsfreundliche PPP-projekte, München, 2007.
- OECD Benchmark Report:** Improving Transparency within Government Procurement Procedures in Iraq. 2008.
- OECD:** Private Sector Development in the Middle East and North Africa- Supporting Investment Policy and Governance Reforms in Iraq. 2010. www.oecd.org/publishing/corrigenda.
- OECD:** Public-Private Partnerships In Pursuit of Risk Sharing and Value for Money, 2008.
- Office of Project Management Process Improvement:** Project Risk Management Handbook. 1st edition, 2003.
- ÖPP-Projekt Datenbank:** ÖPP-Projekte mit Vertragsabschluss im Hoch- und Straßenbau – Investitionsvolumen Hoch- und Straßenbau, 2013.
- ÖPP Deutschland AG:** Überblick zu ÖPP-Projekten im Hoch- und Tiefbau in Deutschland, Partnerschaften Deutschland, 2013.
- ÖPP Deutschland AG :** The market for Public-Private Partnerships in Germany, 2008.
- Pantelias, A.:** A Methodological Framework for Probabilistic Evaluation of Financial Viability of Transportation Infrastructure under PPPs. PhD. thesis, University of Texas, Austin, 2009.
- Partnerships Victoria: Public Sector Comparator Technical Note. Department of Treasury Finance, Victoria, Australia, 2001.
- Pauly, L.:** Das neue Miteinander (the new cooperation), Public Private Partnership in Germany. Hoffmann and Campe, Hamburg, 2006.
- Peter K. Nevitt and Frank J. Fabozzi:** Project financing, 7th edition, Euromoney Institutional Investor PLC, 2000.
- Project Management Institute PMI:** Project Management Body of Knowledge. PMI, 1996.
- Proll, R. Uwe; Drey, Franz:** Die 20 Besten: PPP-Beispiele aus Deutschland, Köln, 2006.
- PPP Conference(2007): Führungskräfte PPP, München.
- Priyanka A. Shingore:** Organizational and Risk Characteristics of Emerging Public-Private Partnership Models. MSc. Thesis, Civil & Environmental Engineering, Virginia university, USA, 2009.
- Punch, K. F.:** Introduction to Social Research: Quantitative and Qualitative Approaches. 2nd Edition. London: SAGE Publications Ltd, 2005.

- Raaijmakers, Q. A. W., Hoof, A. v., Hart, H. t., Verbogt, T. F. M. A., & Wollebergh, W., A. M.:** Adolescents' Midpoint Response on Likert-Type Scale Items-Neutral or missing values?. *International Journal of Public Opinion Research*, Vol. 12(2), 2000.
- Raftery, J. :** Risk Analysis in Project Management. London: E & FN Spon, 1994.
- Ranasinghe, M.:** Private Sector Participation in Infrastructure Projects- A methodology to analyze viability of BOT. *Construction Management and Economics*, 17(5), 1999.
- Ranasinghe, M.:** Total Project Cost. A Simplified Model for Decision Makers, *Journal of Construction Management and Economics*, Vol. 14(6), 1996.
- Redmill F.:** Risk Analysis- A Subjective Process. *Journal of Engineering Management*, Vol.12 (2), 2012.
- Robinson, H., Carillo, P. , Anumba, C. and Patel, M.:** Governance & Knowledge Management for PPP, Department of Civil Engineering, Loughborough University, A John Wiley & Sons, Ltd, 2010.
- Rouboutsos, A., Anagnostopoulos, K. P.:** Public-Private Partnership Projects in Greece-Risk Ranking and Preferred Risk Allocation. *Journal of Construction Management and Economics*, Vol. 26 (7), 2008.
- Sachs, J., Asad, S., & Qaragholi, H.:** Iraq's Power Crisis and the need to re-engage the private sector – smartly, Washington-Baghdad, MEES, 2011.
- Sachs, Goldman:** Building the World- Mapping Infrastructure Demand. New York, NY: Goldman Sachs, 2008.
- Sapte, Wilde:** Project Finance- The Guide to Finance Build Operate Transfer projects uses in PPP. Euromoney Institutional Investor, 1997.
- Senbet, L., and Triantis, A.:** Strategies for Risk Management and Financial Contract Design. Prepared for the World Bank Institute's "Building Knowledge and Expertise in Infrastructure Finance" Program, World Bank, Washington, D.C, 1997.
- Scheuren, F.:** What is a Survey? Booklet. United States of America-American Statistical Association (ASA), 2004.
- Schollhammer, H.:** Locational Strategies of Multinational Firms. Los Angeles, Pepperdine University, 1974.
- Shen YL.:** Project risk management in Hong Kong. *International Journal of Project Management*, Vol. 15(2), 1997.
- Siegel, S. and Castellan, N. J.:** Nonparametric Statistics for the Behavioral Sciences. McGraw-Hill Inc, 1988.

- SIGIR, the Special Inspector General for Iraq Reconstruction report:** Learning from Iraq. Washington DC., USA, 2013.
- Simon, Peter, . et al.:** PRAM Project Risk Analysis and Management Guide-Association for Project Management. High Wycombe, UK, 1997.
- Skanska:** European Commission: Second International Workshop on PPPs European Commission, 2004.
- Stiglitz, J. E.:** Economics of the public sector. New York, W. W. Norton, 1999.
- State Commission for Roads and Bridges:** Report, Iraq, 2013.
- Special Inspector General for Iraq Reconstruction:** Review of Major U.S. Government Infrastructure Projects in Iraq-Nassiriya and Ifraz Water Treatment Plants. SIGIR, 2010.
- Tanaka, D. F., H. Ishida, et al.:** Private Finance for Road Projects in Developing Countries-Improving Transparency through VFM Risk Assessment. Journal of the Eastern Asia Society for Transportation Studies, Vol. 6, 2005.
- Task Force NRW:** PPP im Hochbau, Finanzierungsleitfaden, Nordrhein-Westfalen, 2004.
- The Official Department of Public Expenditure and Reform PPP:** Assessment of Projects for Procurement as Public private Partnership. Dublin, 2006, www.ppp.gov.ie .
- The Royal Academy of Engineering:** The Costs of Generating Electricity. London, 2004.
- Thomas L. Norman:** Risk Analysis and Security Countermeasure Selection. Taylor & Francis Group, 2010.
- Thompson, P., and Perry, J.G. (eds):** Engineering Construction Risks. A Guide to Project Risk Analysis and Risk Management, Implications for Project Clients and Project Managers, an SERC Project Report, Thomas Telford, London, 1992.
- Tomoko M., Robert S., Joseph W.:** Foreign Exchange Risk Mitigation for Power and Water Projects in Developing Countries. Energy and Mining Sector Board Discussion Paper No.9, December 2003
- TUM, Bauindustrie Bayern:** PPP-Know-How-Transfer. Kolloquium 2006 Investor-Hochschule-Bauindustrie, Potenzial Partnerschaft, München 2006.
- Ulf Gjendal:** Public Private Partnerships in Denmark and Germany, Master thesis, Lehrstuhl für Bauprozessmanagement der TU München, 2008.
- UNIDO:** Guidelines for Infrastructure Development through Build-Operate-Transfer. United Nations Industrial Development Organization, Vienna, 1996.

- United State Department of State:** The Future of Iraq Projects. Economy and Infrastructure, Working Group. USA, 2003.
- UNAMI:** Overview of Iraq's Electricity. UNDP Iraq, Baghdad, Iraq, October 2008.
- UNDP:** Iraq: Country Programme Performance Summary, 2009.
- UNDP:** Opportunities for IPP Investment in Iraq-Partnership for Power Generation. Dead Sea, Jordan, 2008.
- UNEP/DEPI/Post-Conflict Assessment Unit:** Needs Assessment for Identification of Environmental Priorities in Iraq, 2003.
- UNICEF:** Iraq Watching Briefs-Water and environmental sanitation. 7/2003.
- United Nations Conference on Trade And Development (UNCTAD):**World Investment Report, 2013.
- UN and World Bank:** Strengthening the Urban Sector through Building Capacities in Municipal Planning and Management, 2009.
- UNIDO:** Investment Map for Iraq. Private Sector Development Programme for Iraq, 2011.
- UN Iraq:** Water in Iraq Factsheet. Iraq Joint Analysis and Policy Unit, 2013.
- UNESCAP:** Public Private Partnerships- A Financier's Perspective. 2009.
- UNDO:** Draft Law on Public Private Partnership, Program for Iraq, 2011.
- USAID:** Audit of USAID/Iraq's Electrical Power Sector Activities. Report No. E-267-05-003-P., 2005.
- US Department of State:** Investment Climate Statement. 2010. <http://www.state.gov/e/eb/rls/othr/ics/2010/>
- Walker, C. and Smith, A. J.:** Privatized Infrastructure-The Build Operate Transfer approach. Thomas Telford, London, 1995.
- Wang, S.Q., Dulaimi, M.F., Aguria, M.Y.:** Building the External Wing of Construction-Managing Risk in International Construction Project. Research Report, National University of Singapore, Singapore, 2013.
- Wang, S. Q., Tiong, R. L. K., Ting, S. K., and Ashley, D.:** Evaluation and Management of Political Risks in China's BOT Projects. Journal of Construction Engineering Management, Vol. 126(3), 2000.
- World Bank:** Concessions for Infrastructure a Guide to Their Design and Award,1998.

- World Bank:** Iraq Country Water Resource Assistance Strategy-Addressing Major Threats to People's Livelihoods. 2006.
- World Bank:** Doing business in Iraq. Washington, DC 20433, 2012. www.worldbank.org.
- World Bank:** Doing business in Iraq. Washington, DC 20433, 2013. www.worldbank.org.
- World Bank:** Emergency Water Supply. Sanitation and Urban Reconstruction Projects, Technical Annex, Iraq, 2004.
- World Bank:** Electrical Power Consumption kWh per Capita, 2011.
- World Bank:** Iraq Joint Needs Assessment-Transportation & Telecommunications. Working Paper, 2003.
- World Bank:** Public Financial Management in a Conflict- Affected Environment, Iraq Public Expenditure and Institutional Assessment, Vol.1, 2008.
- World Bank:** PPP in Infrastructure, Resource Center, [www. Worldbank.com](http://www.Worldbank.com).
- Web Site:**
www.prsgroup.com, Political Risk Services Group.
- Web Site:**
www.ppp.gov.ie.
- Web Site:**
www.worldbank.org
- Yescombe, E. R.:** Public-Private Partnerships Principles of Policy and Finance. Yescombe Consulting Ltd., Elsevier Ltd, UK, 2007.
- Yescombe, E.R:** Principle of Project Finance.UK, 2002.
- Y.H. Kwak:** Analyzing Asian Infrastructure Development Privatization Market. Journal of Construction Engineering and Management, Vol. 12(2), 2002.
- Yuan, J., Wang, C., Skibniewski, M., and Li, Q. :** Developing Key Performance Indicators for Public-Private Partnership Projects: Questionnaire Survey and Analysis." Journal of Management in. Engineering. Vol. 28 (3), 2012.
- Zaidi, Baidaa:** The Role of the Private Sector in the Iraqi Economy. MSc. thesis, University of Basra, Iraq, 2011.
- Zimmermann, Josef, Eber, Wolfgang:** Knowledge Based Risk Controlling. 3rd International Symposium on Geotechnical Safety and Risk (ISGSR2011), Munich, 2011.

- Zimmermann, Josef:** Kolloquium Investor - Hochschule - Bauindustrie. Lehrstuhl für Bauprozessmanagement der TU München, 2006.
- Zimmermann Josef , Eber Wolfgang:** Consideration of Risk in PPP- Projects. 8th International Scientific Conference, Business and Management 2014. Vilnius, Lithuania, May 15-16, 2014.
- Zimmermann, Josef:** Project Delivery Systems. Lecture Notes, Lehrstuhl für Bauprozessmanagement der TU München, 2013.
- Zimmermann, Josef, Eber, Wolfgang, Schieg, Martin, Nino, E.:** Risk Evaluation in Construction Management, Conference Business and Management , Vilnius/Litauen, Veröffentlichungen, Artikel/Vorträge, 2008.
- Zimmermann, Josef:** Public Private Partnership. Wirtschaftlichkeitsuntersuchung, Seminar Immobilienwirtschaft, Lehrstuhl für Bauprozessmanagement der TU München, 2013.
- Zimmermann, Josef and Aljuboori, Omar:** The Challenges of Governing Public Private Partnership in Iraq Infrastructure Projects. Creative Construction Conference, Budapest, Hungary, 2013.
- Zimmermann, Josef:** Kybernetik der Planungsprozesse. Vorlesungsskriptum zur gleichnamigen Vorlesung am Lehrstuhl für Bauprozessmanagement und Immobilienentwicklung an der Technischen Universität München. Ausgabe 05/2009.
- Zhang, X. :** Public Clients' Best Value Perspectives of Public-Private Partnerships in Infrastructure Development. Journal of Construction Engineering and Management, Vol.132 (2), 2006.
- Zhang, X.Q.:** Factor Analysis of Public Clients' Best Value Objective in Public–Privately Partnered Infrastructure Projects. Journal of Construction Engineering and Management, Vol. 132 (9), 2006b.
- Zhang, X.:** Paving the Way for Public–Private Partnerships in Infrastructure Development, Journal of Construction Engineering and Management, Vol. 131(1), 2005.
- Zhao, Guofu and Wang, Shou Qing:** Indicators of Social Impact Assessment for BOT/PPP Projects. Tsinghua University of Beijing, 2010.
- Zhao, Zhirong (Jerry), Saunoi-Sandgren, Emily and Barnea, Avital:** Advancing Public Interest in Public-Private Partnership of State Highway Development, Humphrey Institute of Public Affairs, University of Minnesota, February 2011.

Appendices

Appendix A	Risk Factors Collected from Literature Survey
Appendix B	Presentation of the Questionnaire
Appendix C	Normality Test
Appendix D	Risk Allocation

Appendix A

Risk Factors Collected from Literature Survey

Risk factor	1	2	3	4	5	6	7	8	9	10	11	12	13	14	15	16	17	18	19	20	21	22	23	24	25	26	27	28	29	30	31	32	33	34	35	No		
1. Approval and permit	*		*		*		*		*	*			*	*	*	*		*						*	*			*	*	*	*		*			18		
2. Land availability	*				*		*		*	*			*	*		*			*			*			*	*			*			*		*			16	
3. Government influence				*							*				*			*		*					*	*					*			*			9	
4. Corruption/transparency			*	*							*	*				*	*				*	*				*	*				*				*			12
5. Political opposition		*				*	*		*							*			*		*	*			*	*		*	*	*		*	*	*	*		16	
6. Poor public decision-making									*							*					*			*	*		*	*		*		*	*	*	*		11	
7. Environmental risk	*	*				*	*		*				*			*	*				*			*	*		*	*		*		*	*	*	*		15	
8. Government policies										*			*			*					*			*		*											5	
9. Government reliability			*									*											*		*										*		5	
10. Government stability												*				*							*	*				*	*						*		7	
11. Force majeure		*	*	*	*	*	*		*	*			*	*		*		*	*		*	*		*	*	*	*	*	*	*		*		*			20	
12. Public credit									*								*			*			*	*	*	*	*	*	*	*		*		*			7	
13. Weather									*				*			*								*	*		*	*	*				*				8	
14. Imperfect law and supervision system														*		*							*							*							4	
15. Change in tax regulation	*			*					*	*			*			*		*	*	*					*	*		*	*					*			13	
16. Rate of returns restriction																*																					1	
17. Change in law	*		*	*	*	*	*		*	*		*		*	*	*	*	*	*	*		*		*	*	*	*	*	*	*	*	*	*	*	*	*	24	
18. Industrial regulatory change					*											*													*	*							4	
19. Import/export restrictions															*																						1	
20. Nationalization			*	*	*				*						*		*	*	*		*	*	*	*	*	*	*	*	*	*		*		*			13	
21. Labour-Material availability			*	*	*				*					*	*	*	*	*	*	*	*	*	*	*	*	*	*	*	*	*	*	*	*	*	*	*	15	
22. Foreign exchange / convertibility		*		*		*									*		*	*	*	*	*	*	*	*	*	*	*	*	*		*			*			16	
23. Inflation		*		*					*	*			*		*	*		*	*	*	*	*	*	*	*	*	*	*	*	*	*	*	*	*	*	*	16	
24. Market demand/economic conditions			*	*	*	*	*	*	*						*		*	*	*	*	*	*	*	*	*	*	*	*	*	*	*	*	*	*	*	*	20	
25. Tariff change			*	*	*	*	*		*			*	*		*		*						*	*	*	*	*	*	*	*	*	*	*	*	*	*	17	
26. Uncompetitive tender												*													*	*				*			*	*	*		6	
27. Conflicting / imperfect contract									*						*														*			*	*	*	*		5	
28. Competition																*				*				*	*				*							5		
29. Inadequate negotiation																*								*												2		

1. Gallimore, P., Williams, W., and Woodward, D.: Perceptions of Risk in the Private Finance Initiative. *Journal of Property Finance*, Vol. 8(2), 1997, P.164–176.
2. Salzmann, A., and Mohamed, S.: Risk Identification Frameworks for International BOOT Projects. *Profitable Partnering in Construction Procurement*, CIB W92 (Procurement Systems) and CIB TG 23 (Culture in Construction), S. O. Ogunlana, ed., E & FN Spon, London, 1999, P. 475–485
3. Shou Wang, Robert L. K. Tiong, S.K., Ting, and D. Ashley: Evaluation and Management of Political Risks in China's BOT Projects. *Journal of Construction Engineering Management*, Vol. 126(3), 2000, P. 242–250.
4. Kumaraswamy, M. M., and Zhang, X. Q.: Governmental role in BOT-led Infrastructure Development. *International Journal of Project Management*, Vol. 19(4), 2001, P.195–205.
5. Victorian Department of Treasury and Finance: *Partnerships Victoria-Risk Allocation and Contractual Issues*. Australia, 2001, P. 178–191.
6. Grimsey, D., and Lewis, M.: Evaluating the Risks of Public Private Partnerships for Infrastructure Projects. *International Journal of Project Management*, Vol. 20(2), 2002, P. 107–118.
7. V. Thomas, Satyanarayanan, Kalidindi, and K. Anathanarayanan: Risk Perception Analysis of BOT Road Project Participants in India. *Journal of Management and Economics*, Vol. 21(4), 2003, P. 393-407.
8. Aspin, R.: Public-Private Partnerships and Effective Risk Management for Local Government. Paper Presented to the 19th EAROPH World Planning and Housing Congress and Australian National Housing Conference, Melbourne, 19-22 September 2004, www.sisr.net/cah/publications.htm.
9. Li, B., Akintoye, A., Edwards, P. J., and Hardcastle, C.: The Allocation of Risk in PPP/PFI Construction Projects in the UK. *International Journal of Project Management*, Vol. 23(1), 2005, P. 25–35.
10. Diego F. T., Haruo I., Morito T., Naohisa O.: Private Finance for Road Projects In Developing Countries- Improving Transparency Through VFM Risk Assessment. *Journal of Eastern Asia Society for Transportation Studies*, Vol. 6, 2005, P. 3899 – 3914.
11. Warburton, W., and Baker, G.: Integrity Systems and Local Government. *Australian Journal of Public Administration*, Vol. 64, 2005, P.62–68.
12. Zhang, X.: Paving the Way for Public–Private Partnerships in Infrastructure Development. *Journal of Construction Engineering and Management*, January 2005. Vol. 131(1), P. 71-80.
13. Abednego, M.P., Ogunlana, S.O.: Good Project Governance for Proper Risk Allocation in Public-Private Partnership in Indonesia. *International Journal of Project Management*, Vol. 24, 2006, P. 622-634
14. Singh, L.B., Kalidindi, S.N.: Traffic Revenue Risk Management Through Annuity Model of PPP Road Projects in India. *International Journal of Project Management*, Vol. 24, 2006, P. 605–613.
15. Shen, L. Y., Platten, A., and Deng, X. P.: Role of Public Private Partnerships to Manage Risks in Public Sector Projects in Hong Kong. *International Journal of Project Management*, Vol. 24(7), 2006, P. 587–594.
16. Ibrahim, A.D., Price, A.D.F., Dainty, A.R.J.: The Analysis and Allocation of Risks in Public Private Partnerships in Infrastructure Projects in Nigeria. *Journal of Financial Management of Property and Construction*, Vol. 11(3), 2006, P.149 - 163.
17. Maslyukivska, O., and Sohail, M.: European Infrastructure Procurement Through PPP. *Proceedings of the ICE - Management, Procurement and Law, Institution of Civil Engineers Management*, Vol. 160(4), 2007, P.159–167.
18. Ng, A., and Loosemore, M.: Risk Allocation in the Private Provision of Public Infrastructure. *International Journal of Project Management*, Vol. 25(1), 2007, P. 66–76.
19. Estache, A., Juan, E., and Trujillo, L.: *Public-Private Partnerships in Transport*. Policy Research Working Paper 4436, World Bank, 2007.

20. Medda, F.: A Game Theory Approach for the Allocation of Risks in Transport Public Private Partnerships. *International Journal of Project Management*, Vol. 25(3), 2007, P.213–218.
21. Zou, X. W., Wang, S. Q., and Fang, D. P.: A Life-Cycle Risk Management Framework for PPP Infrastructure Projects. *Journal of Financial Management and Property Construction*, Vol. 13(2), 2008, P.123–142.
22. Yuan, J.F., Peng, X., Li, D.M.: Critical Risks Identification of Public Private Partnerships in China and the Analysis on Questionnaire Survey. *IEEE*, 2008.
23. Kumar Neeraj Jha and M. N. Devaya: Modelling the Risks Faced by Indian Construction Companies Assessing International Projects. *Journal of Construction Management and Economics*, Vol. 26, April 2008, P.37–348
24. Jin, X. H., and Doloi, H.: Interpreting Risk Allocation Mechanism in Public-Private Partnership Projects-An Empirical Study in a Transaction Cost Economics Perspective. *Journal of Construction Management and Economics*, Vol. 26(7), 2008, P. 707–721.
25. Yongjian, K., ShouQing, W., Albert P. C. Chan: Preferred Risk Allocation in China's Public Private Partnership (PPP) Projects. *Journal of Project Management*, Vol. 28, 2009, P. 482-492.
26. Yelin,X., Cheng, H., Chan, P.C.: Risk Factors for Running Public Private Partnerships (PPP) – An Empirical. *IEEE*, 2009.
27. Wibowo, A., Mohamed, S.: Risk Criticality and Allocation in Privatised Water Supply Projects in Indonesia. *International Journal of Project Management*, Vol. 28, 2010, P.504-513.
28. Ke, Y., Wang, S., and Chan, A.: Risk Allocation in Public-Private Partnership Infrastructure Projects: Comparative Study. *Journal of Infrastructure Systems*, Vol. 16(4), 2010, P.43–351.
29. Bing L., Akintola A., Cliff H.: VFM and Risk Allocation Models in Construction PPP Projects. School of Built and Natural Environment, Glasgow Caledonian University, Glasgow G4 0BA, 2010.
30. Xiao, H.J., Zhang, G.: Modelling Optimal Risk Allocation in PPP Projects Using Artificial Neural Networks. *International Journal of Project Management*, Vol. 29, 2011, P.591–603.
31. Cheung, E. and Chan, A.: Risk Factors of Public-Private Partnership Projects in China-Comparison between the Water, Power, and Transportation Sectors. *Journal of Urban Planning and Development*, Vol. 137(4), 2011, P.409–415.
32. Li, J. and Zou, P.: Fuzzy AHP-Based Risk Assessment Methodology for PPP Projects. *Journal of Construction Engineering and Management*, Vol. 137(12), 2011, P.1205–1209.
33. Tingting Liu, Suzanne Wilkinson: Adopting Innovative Procurement Techniques-Obstacles and Drivers for Adopting Public Private Partnerships in New Zealand. *Construction Innovation-Information, Process, Management*, Vol. 11(4), 2011, P. 452 – 469.
34. Chan, A. Yeung, J., Yu, C., Wang, S., and Ke, Y.: Empirical Study of Risk Assessment and Allocation of Public-Private Partnership Projects in China. *Journal of Management in Engineering*, Vol. 27 (3), 2011, P.136-148.
35. Yuan, J., Wang, C., Skibniewski, M., and Li, Q.: Developing Key Performance Indicators for Public-Private Partnership Projects-Questionnaire Survey and Analysis. *Journal of Management in Engineering*, Vol. 28 (3), 2012, P. 252-264.

Appendix B



A Survey on Developing Iraq Infrastructure: Using Public-Private Partnership

To the Respondent

Dear Madam / Sir,

This voluntary questionnaire survey is prepared to be a part of a doctoral thesis entitled “Developing of Iraq Infrastructure Using Public-Private Partnerships (PPP)”, undertaken at the Department of Construction Process Management and Real Estate Development, TU Munich, under the supervision of Prof. Univ. Dr.-Ing. Josef Zimmermann of TU Munich with full financial assistance from the German Academic Exchange Service (DAAD). The purpose of this study is to assess whether the use of PPP as a procurement method is a viable solution for developing infrastructure projects in Iraq.

PPP can be defined as “an agreement between a government and a private firm under which the private firm delivers an asset, a service, or both, in return for payments contingent to some extent on the long-term quality or other characteristics of outputs delivered”. PPPs in facilities development involve private companies in the design, financing, construction, ownership and operation of a public sector utility for long term contract (20-30) year. PPPs are known worldwide with various other alternative names such as Private Participations in Infrastructure (PPI), Private-Sector Participation (PSP), P3, Privately Financed Projects (PFP), and Private Finance Initiatives (PFI).

The survey contains 25 questions, and we estimate it will take an average of 20 minutes to be completed. Your completion of this survey is voluntary and questions are individual, subjective assessments. Your participation in this survey renders me a highly appreciated assistance. Please be sure that your personal data are going to be top confidential. I welcome your comments or questions relating to this survey, you can contact me at the bellow mentioned addresses.

Notice: It is important to note that there are definitely no “right” or “wrong” answers; the only “correct” answers are what you honestly think and feel.

Thank you in advance for your help, we do appreciate your time.

Omar Aljuboori
PhD. Student
Department of Construction Process Management and Real Estate Development
Faculty of Civil Engineering and Surveying
Technical university of Munich
Phone: (0049) 89 289 22591
E-mail: o.aljuboori@bv.tum.de

Section 1: About the Respondent

Age: 20-30 years 31-40 years 41-60 years Above 60 years

Academic degree: B.Sc. M.Sc. Ph.D. Others (please specify)

Name of company/
organization:

Your position in the
company/organization:

Email Address:

Phone Number:

Please select your primary role below:

- Consultant/ advisor Supplier Inspector Financer
- Engineer Contractor Subcontractor Academic Researcher
- General director Other (please specify)

How many years of industrial experience do you have?

- 5 years or below 6 – 10 years 11 – 15 years 16 – 20 years 21 years or above

Which sector do you have experience with?

- Public sector (State) Private sector Both

Section 2: General Experience with PPP

1. How many years of PPP experience do you have?

- None
 1-2 years or below
 3–5 years
 6 years or above

2. Was there or is there any PPP project undertaken by your company/organization?

- Yes
 No
 No sure

3. If yes, what is the type of the project that undertaken by your company/organization (you may tick more than one box)?

- Transportation
 Water and Sanitary
 Housing
 Hospital
 School and Education
 Power and Energy
 Other (please specify)

4. What is the contract type of the PPP project that undertaken by your company/organization (you may tick more than one box)?

- Design and build (DB)
 Build-Operate- Transfer (BOT)
 Concession model
 Lease contract (LC)
 Build-Own-Operate (BOO)
 Other (please specify)

5. Does your company/ organization has any guidance/practice notes on PPP implementation?

- Yes
 No
 No sure

6. Do you think that PPP is a viable solution for an accelerated public infrastructure projects in Iraq?

- Yes
 No
 No sure

7. Which of the following projects do you think are best suited for PPP projects in Iraq (you may tick more than one box)?

- All Projects
 Social infrastructure
 Projects with subsidy
 Project dependent
 High risk projects
 Economic viable
 Other (please specify)

Section 3: Criteria and Performance of PPP in Iraq

This part aims to study and evaluate the level of awareness and knowledge and current condition of Iraq public sector. Please rate the following statements based on a Likert scale from 1 – 6, where (1= completely disagree; 6 = completely agree; 0= not applicable).

8. What are the main reasons that encourage public sector for adopting PPP instead of traditional procurement?

	0	1	2	3	4	5	6
Solve the problem of public sector budget shortage	<input type="radio"/>	<input type="radio"/>	<input type="radio"/>	<input type="radio"/>	<input type="radio"/>	<input type="radio"/>	<input type="radio"/>
Social pressure of poor public facilities	<input type="radio"/>	<input type="radio"/>	<input type="radio"/>	<input type="radio"/>	<input type="radio"/>	<input type="radio"/>	<input type="radio"/>
Technology transfer to local enterprise through the private sector's Know How	<input type="radio"/>	<input type="radio"/>	<input type="radio"/>	<input type="radio"/>	<input type="radio"/>	<input type="radio"/>	<input type="radio"/>
Efficient allocation of project risks between the public and private partner	<input type="radio"/>	<input type="radio"/>	<input type="radio"/>	<input type="radio"/>	<input type="radio"/>	<input type="radio"/>	<input type="radio"/>
Reduce the total project cost	<input type="radio"/>	<input type="radio"/>	<input type="radio"/>	<input type="radio"/>	<input type="radio"/>	<input type="radio"/>	<input type="radio"/>

9. What are the main negative factors in adopting PPP instead of traditional procurement?

	0	1	2	3	4	5	6
Very large tendering, contracting and re-negotiation costs	<input type="radio"/>	<input type="radio"/>	<input type="radio"/>	<input type="radio"/>	<input type="radio"/>	<input type="radio"/>	<input type="radio"/>
The difficulties of ensuring future good performance(Bankruptcy,....etc)	<input type="radio"/>	<input type="radio"/>	<input type="radio"/>	<input type="radio"/>	<input type="radio"/>	<input type="radio"/>	<input type="radio"/>
Public budget restrain by the annual payment to the private partner (which is work as a debt borne by future generations)	<input type="radio"/>	<input type="radio"/>	<input type="radio"/>	<input type="radio"/>	<input type="radio"/>	<input type="radio"/>	<input type="radio"/>
Higher capital cost	<input type="radio"/>	<input type="radio"/>	<input type="radio"/>	<input type="radio"/>	<input type="radio"/>	<input type="radio"/>	<input type="radio"/>
High risk relying on private sector	<input type="radio"/>	<input type="radio"/>	<input type="radio"/>	<input type="radio"/>	<input type="radio"/>	<input type="radio"/>	<input type="radio"/>

10. In form of the following points, do you consider your organization is prepared to get involved in a PPP project?

	0	1	2	3	4	5	6
The availability of knowledge and capacity-building	<input type="radio"/>	<input type="radio"/>	<input type="radio"/>	<input type="radio"/>	<input type="radio"/>	<input type="radio"/>	<input type="radio"/>
For the planning and participation in PPP project	<input type="radio"/>	<input type="radio"/>	<input type="radio"/>	<input type="radio"/>	<input type="radio"/>	<input type="radio"/>	<input type="radio"/>
For the tender and negotiation phase of a PPP project	<input type="radio"/>	<input type="radio"/>	<input type="radio"/>	<input type="radio"/>	<input type="radio"/>	<input type="radio"/>	<input type="radio"/>
For commitment and bringing the private finance of the project	<input type="radio"/>	<input type="radio"/>	<input type="radio"/>	<input type="radio"/>	<input type="radio"/>	<input type="radio"/>	<input type="radio"/>

11. How would you compare PPP with traditional procurement methods?

	0	1	2	3	4	5	6
Using a Public Sector Comparator (PSC)	<input type="radio"/>	<input type="radio"/>	<input type="radio"/>	<input type="radio"/>	<input type="radio"/>	<input type="radio"/>	<input type="radio"/>
Tendering and negotiation for PPP are longer	<input type="radio"/>	<input type="radio"/>	<input type="radio"/>	<input type="radio"/>	<input type="radio"/>	<input type="radio"/>	<input type="radio"/>
PPP projects utilize private sector finance/difference in finance structure	<input type="radio"/>	<input type="radio"/>	<input type="radio"/>	<input type="radio"/>	<input type="radio"/>	<input type="radio"/>	<input type="radio"/>
Difference in risk profile	<input type="radio"/>	<input type="radio"/>	<input type="radio"/>	<input type="radio"/>	<input type="radio"/>	<input type="radio"/>	<input type="radio"/>
PPP projects utilize private sector expertise and skills	<input type="radio"/>	<input type="radio"/>	<input type="radio"/>	<input type="radio"/>	<input type="radio"/>	<input type="radio"/>	<input type="radio"/>

12. In form of the following points, do you think that the current legal framework suitable for PPP projects?

	0	1	2	3	4	5	6
Existing of regulation that clearly defining the rights and obligations of private investors	<input type="radio"/>	<input type="radio"/>	<input type="radio"/>	<input type="radio"/>	<input type="radio"/>	<input type="radio"/>	<input type="radio"/>
Judicial independence from government influence	<input type="radio"/>	<input type="radio"/>	<input type="radio"/>	<input type="radio"/>	<input type="radio"/>	<input type="radio"/>	<input type="radio"/>
Regulatory commitment sustained through long-term contract	<input type="radio"/>	<input type="radio"/>	<input type="radio"/>	<input type="radio"/>	<input type="radio"/>	<input type="radio"/>	<input type="radio"/>
Existence of regulation that clearly defining PPP contracts, forms and requirements	<input type="radio"/>	<input type="radio"/>	<input type="radio"/>	<input type="radio"/>	<input type="radio"/>	<input type="radio"/>	<input type="radio"/>

13. In form of the following points, how do you evaluate the government Support?

	0	1	2	3	4	5	6
The need for government support (loan, guarantee, subsidy, equity share, tax hold...etc.)	<input type="radio"/>	<input type="radio"/>	<input type="radio"/>	<input type="radio"/>	<input type="radio"/>	<input type="radio"/>	<input type="radio"/>
The need for government support (loan, guarantee, subsidy, equity share, tax hold...etc.)	<input type="radio"/>	<input type="radio"/>	<input type="radio"/>	<input type="radio"/>	<input type="radio"/>	<input type="radio"/>	<input type="radio"/>

Section 4: Risk Factors

14. Major Risk Factors in Iraq PPP Infrastructure Projects

This part aims to study and evaluate the importance of major perceived risks associated with Iraq's PPP projects. You are asked to circle the number indicating the importance index (1 = Least important; 6 = Most important; 0= not applicable) of each risk to be taken into account in the financial decision-making of a PPP projects investment. Regarding the risk allocation (1 = risk allocated to the public; 2 = risk shared by the government and private; 3= risk allocated to the private sector).

Risk factors in PPP projects	Importance							Risk allocation		
	0	1	2	3	4	5	6	1	2	3
Development phase										
Administrative efficiency/ delay of approvals	<input type="radio"/>	<input type="radio"/>	<input type="radio"/>	<input type="radio"/>	<input type="radio"/>	<input type="radio"/>	<input type="radio"/>	<input type="radio"/>	<input type="radio"/>	<input type="radio"/>
Non Competitive tender/ Inadequate competition	<input type="radio"/>	<input type="radio"/>	<input type="radio"/>	<input type="radio"/>	<input type="radio"/>	<input type="radio"/>	<input type="radio"/>	<input type="radio"/>	<input type="radio"/>	<input type="radio"/>
Land acquisition/ compensation time and cost	<input type="radio"/>	<input type="radio"/>	<input type="radio"/>	<input type="radio"/>	<input type="radio"/>	<input type="radio"/>	<input type="radio"/>	<input type="radio"/>	<input type="radio"/>	<input type="radio"/>
Social/Cultural acceptability of the project	<input type="radio"/>	<input type="radio"/>	<input type="radio"/>	<input type="radio"/>	<input type="radio"/>	<input type="radio"/>	<input type="radio"/>	<input type="radio"/>	<input type="radio"/>	<input type="radio"/>
Corruption/ transparency of public administrative	<input type="radio"/>	<input type="radio"/>	<input type="radio"/>	<input type="radio"/>	<input type="radio"/>	<input type="radio"/>	<input type="radio"/>	<input type="radio"/>	<input type="radio"/>	<input type="radio"/>
Availability of financing	<input type="radio"/>	<input type="radio"/>	<input type="radio"/>	<input type="radio"/>	<input type="radio"/>	<input type="radio"/>	<input type="radio"/>	<input type="radio"/>	<input type="radio"/>	<input type="radio"/>
High bidding cost	<input type="radio"/>	<input type="radio"/>	<input type="radio"/>	<input type="radio"/>	<input type="radio"/>	<input type="radio"/>	<input type="radio"/>	<input type="radio"/>	<input type="radio"/>	<input type="radio"/>
Construction phase										
Design and construction changes	<input type="radio"/>	<input type="radio"/>	<input type="radio"/>	<input type="radio"/>	<input type="radio"/>	<input type="radio"/>	<input type="radio"/>	<input type="radio"/>	<input type="radio"/>	<input type="radio"/>
Construction time and cost	<input type="radio"/>	<input type="radio"/>	<input type="radio"/>	<input type="radio"/>	<input type="radio"/>	<input type="radio"/>	<input type="radio"/>	<input type="radio"/>	<input type="radio"/>	<input type="radio"/>
Unproven engineering technique or technology	<input type="radio"/>	<input type="radio"/>	<input type="radio"/>	<input type="radio"/>	<input type="radio"/>	<input type="radio"/>	<input type="radio"/>	<input type="radio"/>	<input type="radio"/>	<input type="radio"/>
Geotechnical conditions	<input type="radio"/>	<input type="radio"/>	<input type="radio"/>	<input type="radio"/>	<input type="radio"/>	<input type="radio"/>	<input type="radio"/>	<input type="radio"/>	<input type="radio"/>	<input type="radio"/>
Labour /Material unavailability/Poor quality workmanship	<input type="radio"/>	<input type="radio"/>	<input type="radio"/>	<input type="radio"/>	<input type="radio"/>	<input type="radio"/>	<input type="radio"/>	<input type="radio"/>	<input type="radio"/>	<input type="radio"/>

Operation phase	0	1	2	3	4	5	6	1	2	3
Operation quality /Low productivity	0	0	0	0	0	0	0	0	0	0
Market demand	0	0	0	0	0	0	0	0	0	0
Operation and maintenance time and cost	0	0	0	0	0	0	0	0	0	0
Tariff escalation/ revenue loss	0	0	0	0	0	0	0	0	0	0
Fuel availability and Supporting utilities	0	0	0	0	0	0	0	0	0	0
Environmental risk	0	0	0	0	0	0	0	0	0	0
Less residual value	0	0	0	0	0	0	0	0	0	0
Project life cycle										
	0	1	2	3	4	5	6	1	2	3
Poor public decision-making process	0	0	0	0	0	0	0	0	0	0
Expropriation/nationalization	0	0	0	0	0	0	0	0	0	0
Change in legal and regulatory framework	0	0	0	0	0	0	0	0	0	0
Change in tax regulation	0	0	0	0	0	0	0	0	0	0
Non-political force majeure	0	0	0	0	0	0	0	0	0	0
Third party liability	0	0	0	0	0	0	0	0	0	0
Lack of commitment from public or private partner	0	0	0	0	0	0	0	0	0	0
Inflation rate	0	0	0	0	0	0	0	0	0	0
Changes in interest rate	0	0	0	0	0	0	0	0	0	0
Changes in currency exchange rates	0	0	0	0	0	0	0	0	0	0
Government stability/Civil disturbance/ security	0	0	0	0	0	0	0	0	0	0

Section 5 : Future Prospects

15. Prospects for Public-Private Partnership in Infrastructure Projects in Iraq

This part is the end of the survey and aims at evaluating whether or not Iraq has been suitable to promote PPP especially under BOT/BOO schemes in the infrastructure sector in a general sense and the future of the BOT/BOO implementation. You can express your agreement (or disagreement) on a given statement, using a 6-Likert scale, where (1 = completely disagree; 6 = completely agree; 0= not applicable).

	0	1	2	3	4	5	6
Generally, do you agree that current Iraq conditions are suitable for private investment in infrastructure projects on basis of PPPs?	<input type="radio"/>	<input type="radio"/>	<input type="radio"/>	<input type="radio"/>	<input type="radio"/>	<input type="radio"/>	<input type="radio"/>
In the recent future, do you agree that PPP schemes in Iraq infrastructure projects are going to be extensively implemented if some criteria were improved?	<input type="radio"/>	<input type="radio"/>	<input type="radio"/>	<input type="radio"/>	<input type="radio"/>	<input type="radio"/>	<input type="radio"/>

Other suggestions and comments on implementing PPP projects (please specify)

« End of the questionnaire »
« Thank you for your valuable cooperation»

Definitions

PPP definition

PPP is defined as cooperation between the public and private sectors to improve the implementation of public infrastructure. Several elements of the life cycle (design, construction, operation, financing and recycling) should be optimized in a holistic approach. PPP in practice comprises a variety of different contract models.

Organization and operation contract (M&O)

They are set up specifically for management contract or lease –operate contract for the long-term provision of a given public service by negotiating and contracting it with specialized private company, the private partner takes over the management and the operating part, but the public partner takes over the capital expenditure and the ownership, and for the operating expenditure it takes over by private or public.

Management and operation (M&O) with major private capital expenditure (Concession)

These contracts are cover: BTO (Build Transfer Operate), BLT (Build Lease or rent Transfer), ROT (Rehabilitate Operate Transfer), RLT (Rehabilitate Lease or rent Transfer), and BROT (Build Rehabilitate Operate Transfer). A private entity takes over the management, operate, capital expenditure and operating expenditure of a state – owned enterprise for a given period during which it also assumes significant investment risk.

Greenfield projects

These contracts are for: BLO (Build Lease Owen), BOT (Build Operate Transfer), BOO (Build Owen Operate). A private entity or a public private joint venture builds and operate a new facility for a given period specified in the project contract. The facility may return to the government at the end of the concession period, and for the Ownership, Operating, Capital expenditure and operating expenditure it takes over by the private or mixed.

Divestiture

These contracts were the government transfers 100% or less of the equity in the state-owned company to the private entities. A private consortium buys an equity stake in a state-owned enterprise through asset sale, public offering or mass privatization program, and for the Ownership, Capital expenditure and operating expenditure it takes over by the private or mixed, but the Operating can by private or mixed or public.

Appendix C

Normality Tests

Items	Kolmogorov-Smirnov ^a			Significant
	Statistic	df	Sig. (p-value)	
Solve the problem of public sector budget shortage	0.294	101	0.000	No
Social pressure of poor public facilities	0.282	101	0.000	No
Technology transfer to local enterprise through the private sector's Know How	0.375	101	0.000	No
Efficient allocation of project risks between the public and private partner	0.229	101	0.000	No
Reduce the total project cost	0.205	101	0.000	No

a. Lilliefors Significance Correction

Normality test of attractive factors of PPP

Items	Kolmogorov-Smirnov ^a			Significant
	Statistic	df	Sig. (p-value)	
Very large tendering, contracting and re-negotiation costs	0.202	99	0.000	No
The difficulties of ensuring future good performance (Bankruptcy,....etc)	0.201	99	0.000	No
Public budget restrain by the annual payment to the private partner (which is work as a debt borne by future generations)	0.192	99	0.000	No
Higher capital cost	0.189	99	0.000	No
High risk relying on private sector	0.214	99	0.000	No

a. Lilliefors Significance Correction

Normality test of negative factors of PPP

Items	Kolmogorov-Smirnov ^a			Significant
	Statistic	df	Sig. (p-value)	
Using a Public Sector Comparator (PSC)	0.199	93	0.000	No
Tendering and negotiation for PPP are longer	0.205	93	0.000	No
PPP projects utilize private sector finance/difference in finance structure	0.330	93	0.000	No
Difference in risk profile	0.258	93	0.000	No
PPP projects utilize private sector expertise and skills	0.353	93	0.000	No

a. Lilliefors Significance Correction

Normality test of for methods of comparing PPP with traditional procurement

Risk factors	Kolmogorov-Smirnov			Significant
	Statistic	df	Sig. (p-value)	
R1	0.450	94	0.00	No
R2	0.245	94	0.00	No
R3	0.413	94	0.00	No
R4	0.233	94	0.00	No
R5	0.379	94	0.00	No
R6	0.409	94	0.00	No
R7	0.275	94	0.00	No
R8	0.331	94	0.00	No
R9	0.358	94	0.00	No
R10	0.217	94	0.00	No
R11	0.200	94	0.00	No
R12	0.308	94	0.00	No
R13	0.427	94	0.00	No
R14	0.360	94	0.00	No
R15	0.337	94	0.00	No
R16	0.272	94	0.00	No
R17	0.275	94	0.00	No
R18	0.206	94	0.00	No
R19	0.245	94	0.00	No
R20	0.402	94	0.00	No
R21	0.257	94	0.00	No
R22	0.354	94	0.00	No
R23	0.245	94	0.00	No
R24	0.351	94	0.00	No
R25	0.269	94	0.00	No
R26	0.321	94	0.00	No
R27	0.216	94	0.00	No
R28	0.202	94	0.00	No
R29	0.186	94	0.00	No
R30	0.437	94	0.00	No

Normality test of risk factors in PPP projects

Appendix D

Risk Allocation

Risk factors	Survey responses			n	Risk center coordinates		d 1 Distance from Pub.	d 2 Distance from Sh.	d 3 Distance from Pr.	SD	C.P.	Preferred risk allocation
	Risk allocated to the public	Risk is shared	Risk allocated to the private		x	y						
	Administrative efficiency/ delay of approvals and licenses	35	4		9	48						
Non Competitive tender/ Inadequate competition	30	10	8	48	0.271	0.180	0.325	0.723	0.751	0.238	0.412	Public
Land acquisition/ compensation time and cost	26	14	8	48	0.313	0.253	0.402	0.641	0.732	0.171	0.296	Public
Social/Cultural acceptability of the project	14	7	27	48	0.635	0.126	0.648	0.752	0.386	0.189	0.327	Private
Corruption/ transparency of public administrative	25	17	6	48	0.302	0.307	0.430	0.593	0.762	0.166	0.287	Public
Availability of financing	12	7	29	48	0.677	0.126	0.689	0.761	0.347	0.221	0.383	Private
High bidding cost	11	18	19	48	0.583	0.325	0.668	0.548	0.528	0.075	0.131	Private
Design and construction changes	12	5	31	48	0.698	0.090	0.704	0.801	0.315	0.257	0.445	Private
Construction time and cost	6	5	37	48	0.823	0.090	0.828	0.840	0.199	0.367	0.635	Private
Unproven engineering technique or technology	8	21	18	47	0.606	0.387	0.719	0.491	0.552	0.118	0.205	Shared
Geotechnical conditions	8	16	24	48	0.667	0.289	0.726	0.601	0.441	0.143	0.248	Private
Labour /Material unavailability/Poor quality workmanship	5	6	36	47	0.830	0.111	0.837	0.824	0.203	0.362	0.628	Private
Operation quality /Low productivity	3	9	36	48	0.844	0.162	0.859	0.783	0.225	0.346	0.599	Private
Market demand	11	33	4	48	0.427	0.595	0.733	0.280	0.826	0.292	0.506	Shared
Operation and maintenance time and cost	3	7	36	46	0.859	0.132	0.869	0.817	0.193	0.376	0.651	Private
Tariff escalation/ revenue	20	15	12	47	0.415	0.276	0.499	0.596	0.647	0.075	0.131	Public

Appendix D Risk Allocation

loss												
Fuel availability and Supporting utilities	5	16	25	46	0.717	0.301	0.778	0.605	0.413	0.183	0.316	Private
Environmental risk	6	11	31	48	0.760	0.198	0.786	0.717	0.311	0.256	0.444	Private
Less residual value	15	19	13	47	0.479	0.350	0.593	0.516	0.628	0.057	0.099	Shared- Public
Poor public decision-making process	37	7	4	48	0.156	0.126	0.201	0.816	0.853	0.366	0.634	Public
Expropriation/nationalization	30	11	6	47	0.245	0.203	0.318	0.711	0.782	0.250	0.433	Public
Chance in legal and regulatory framework	19	18	11	48	0.417	0.325	0.528	0.548	0.668	0.075	0.131	Public- Shared
Change in tax regulation	19	12	17	48	0.479	0.217	0.526	0.650	0.564	0.064	0.110	Public- Private
Non-political force majeure	6	36	5	47	0.489	0.663	0.824	0.203	0.837	0.362	0.628	Shared
Third party liability	3	18	27	48	0.750	0.325	0.817	0.596	0.410	0.204	0.353	Private
Lack of commitment from public/private partner	7	30	10	47	0.532	0.553	0.767	0.315	0.724	0.250	0.432	Shared
Inflation rate	7	9	32	48	0.760	0.162	0.778	0.750	0.289	0.274	0.475	Private
Changes in interest rate	12	11	24	47	0.628	0.203	0.660	0.675	0.424	0.141	0.244	Private
Changes in currency exchange rates	16	19	13	48	0.469	0.343	0.581	0.524	0.632	0.054	0.094	Shared
Government stability/Civil disturbance/ security	36	6	6	48	0.188	0.108	0.217	0.820	0.820	0.348	0.603	Public

Preferred risk allocation and closeness parameter of the public sector group

Appendix D Risk Allocation

Risk factors	Survey responses			n	Risk center coordinates		d 1 Distance from Pub.	d 2 Distance from Sh.	d 3 Distance from Pr.	SD	C.P.	Preferred risk allocation
	Risk allocated to the public	Risk is shared	Risk allocated to the private		x	y						
	Administrative efficiency/ delay of approvals and licenses	20	6		3	29						
Non Competitive tender/ Inadequate competition	22	2	5	29	0.207	0.060	0.215	0.858	0.795	0.354	0.614	Public
Land acquisition/ compensation time and cost	22	7	0	29	0.121	0.209	0.241	0.759	0.904	0.348	0.603	Public
Social/Cultural acceptability of the project	20	7	2	29	0.190	0.209	0.282	0.727	0.837	0.294	0.509	Public
Corruption/ transparency of public administrative	17	6	6	29	0.310	0.179	0.358	0.713	0.713	0.204	0.354	Public
Availability of financing	4	12	14	30	0.667	0.346	0.751	0.546	0.481	0.141	0.245	Private
High bidding cost	5	14	9	28	0.571	0.433	0.717	0.439	0.609	0.140	0.243	Shared
Design and construction changes	15	5	10	30	0.417	0.144	0.441	0.726	0.601	0.143	0.248	Public
Construction time and cost	10	9	11	30	0.517	0.260	0.578	0.606	0.549	0.029	0.050	Private
Unproven engineering technique or technology	4	12	12	28	0.643	0.371	0.742	0.515	0.515	0.131	0.227	Shared-Private
Geotechnical conditions	7	16	6	29	0.483	0.478	0.679	0.389	0.704	0.175	0.304	Shared
Labour /Material unavailability	6	7	16	29	0.672	0.209	0.704	0.679	0.389	0.175	0.304	Private
Operation quality /Low productivity	3	3	24	30	0.850	0.087	0.854	0.854	0.173	0.393	0.681	Private
Market demand	2	19	9	30	0.617	0.548	0.825	0.338	0.669	0.249	0.431	Shared
Operation and maintenance time and cost	2	2	25	29	0.897	0.060	0.899	0.899	0.119	0.450	0.779	Private
Tariff escalation/ revenue loss	6	10	13	29	0.621	0.299	0.689	0.580	0.483	0.103	0.179	Private

Appendix D Risk Allocation

Fuel availability and Supporting utilities	8	11	11	30	0.550	0.318	0.635	0.551	0.551	0.049	0.084	Shared-Private
Environmental risk	8	10	11	29	0.552	0.299	0.627	0.570	0.539	0.045	0.078	Private
Less residual value	8	12	9	29	0.517	0.358	0.629	0.508	0.601	0.064	0.110	Shared
Poor public decision-making process	20	4	6	30	0.267	0.115	0.291	0.786	0.742	0.274	0.475	Public
Expropriation/nationalization	15	8	7	30	0.367	0.231	0.433	0.649	0.674	0.132	0.229	Public
Chance in legal and regulatory framework	13	10	7	30	0.400	0.289	0.493	0.586	0.666	0.086	0.150	Public
Change in tax regulation	11	15	4	30	0.383	0.433	0.578	0.448	0.754	0.153	0.265	Shared
Non-political force majeure	22	6	2	30	0.167	0.173	0.240	0.769	0.851	0.331	0.574	Public
Third party liability	0	11	19	30	0.817	0.318	0.876	0.633	0.367	0.255	0.441	Private
Lack of commitment from public/private partner	11	15	4	30	0.383	0.433	0.578	0.448	0.754	0.153	0.265	Shared
Inflation rate	9	10	11	30	0.533	0.289	0.606	0.578	0.549	0.029	0.050	Private
Changes in interest rate	5	11	14	30	0.650	0.318	0.723	0.569	0.473	0.127	0.219	Private
Changes in currency exchange rates	19	7	4	30	0.250	0.202	0.321	0.709	0.777	0.246	0.426	Public
Government stability/Civil disturbance/ security	23	2	5	30	0.200	0.058	0.208	0.862	0.802	0.361	0.626	Public

Preferred risk allocation and closeness parameter of the private sector group

Appendix D Risk Allocation

Risk factors	Survey responses			n	Risk center coordinates		d 1 Distance from Pub.	d 2 Distance from Sh.	d 3 Distance from Pr.	SD	C.P.	Preferred risk allocation
	risk allocated to the public	risk is shared	risk allocated to the private		x	y						
	Administrative efficiency/ delay of approvals and licenses	18	4		7	29						
Non Competitive tender/ Inadequate competition	25	1	3	29	0.121	0.030	0.124	0.918	0.880	0.448	0.775	Public
Land acquisition/ compensation time and cost	11	15	3	29	0.362	0.448	0.576	0.440	0.779	0.171	0.296	Shared
Social/Cultural acceptability of the project	21	3	5	29	0.224	0.090	0.241	0.824	0.781	0.325	0.562	Public
Corruption/ transparency of public administrative	15	8	5	28	0.321	0.247	0.406	0.644	0.722	0.165	0.286	Public
Availability of financing	4	5	19	28	0.768	0.155	0.783	0.760	0.279	0.285	0.493	Private
High bidding cost	6	15	7	28	0.518	0.464	0.695	0.402	0.669	0.162	0.281	Shared
Design and construction changes	8	6	14	28	0.607	0.186	0.635	0.689	0.434	0.134	0.232	Private
Construction time and cost	4	10	15	29	0.690	0.299	0.752	0.598	0.431	0.160	0.278	Private
Unproven engineering technique or technology	4	8	17	29	0.724	0.239	0.763	0.666	0.365	0.207	0.359	Private
Geotechnical conditions	7	17	4	28	0.446	0.526	0.690	0.344	0.763	0.224	0.388	Shared
Labour /Material unavailability	4	6	18	28	0.750	0.186	0.773	0.725	0.311	0.254	0.439	Private
Operation quality /Low productivity	3	6	19	28	0.786	0.186	0.807	0.738	0.283	0.285	0.493	Private
Market demand	2	18	8	28	0.607	0.557	0.824	0.327	0.681	0.256	0.443	Shared
Operation and maintenance time and cost	2	4	23	29	0.862	0.119	0.870	0.830	0.182	0.386	0.668	Private
Tariff escalation/ revenue loss	13	11	5	29	0.362	0.328	0.489	0.555	0.718	0.118	0.204	Public

Appendix D Risk Allocation

Fuel availability and Supporting utilities	5	5	19	29	0.741	0.149	0.756	0.756	0.299	0.264	0.458	Private
Environmental risk	7	6	15	28	0.643	0.186	0.669	0.695	0.402	0.162	0.281	Private
Less residual value	2	11	15	28	0.732	0.340	0.807	0.575	0.433	0.189	0.327	Private
Poor public decision-making process	24	2	2	28	0.107	0.062	0.124	0.895	0.895	0.445	0.771	Public
Expropriation/nationalization	13	10	5	28	0.357	0.309	0.472	0.575	0.713	0.121	0.209	Public
Chance in legal and regulatory framework	16	3	9	28	0.375	0.093	0.386	0.783	0.632	0.200	0.347	Public
Change in tax regulation	15	13	0	28	0.232	0.402	0.464	0.536	0.867	0.215	0.372	Public
Non-political force majeure	4	19	5	28	0.518	0.588	0.783	0.279	0.760	0.285	0.493	Shared
Third party liability	3	10	15	28	0.714	0.309	0.778	0.597	0.421	0.179	0.309	Private
Lack of commitment from public/private partner	9	15	4	28	0.411	0.464	0.620	0.412	0.750	0.171	0.295	Shared
Inflation rate	9	12	8	29	0.483	0.358	0.601	0.508	0.629	0.064	0.110	Shared
Changes in interest rate	1	10	17	28	0.786	0.309	0.844	0.626	0.376	0.234	0.406	Private
Changes in currency exchange rates	18	7	3	28	0.232	0.217	0.317	0.703	0.798	0.254	0.441	Public
Government stability/Civil disturbance/ security	23	5	0	28	0.089	0.155	0.179	0.821	0.924	0.404	0.700	Public

Preferred risk allocation and closeness parameter of researchers group

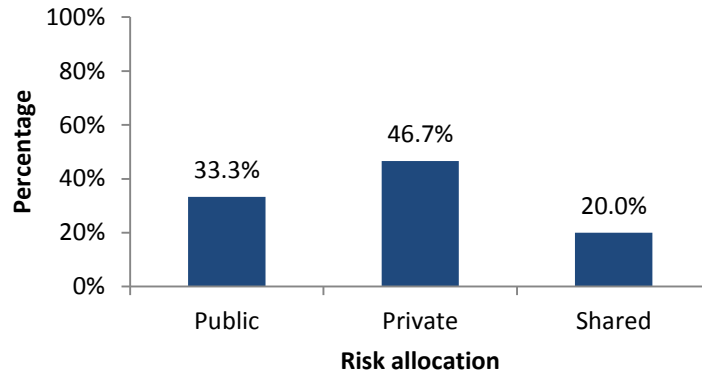

Risk allocation percentage between public and private sectors by public sector

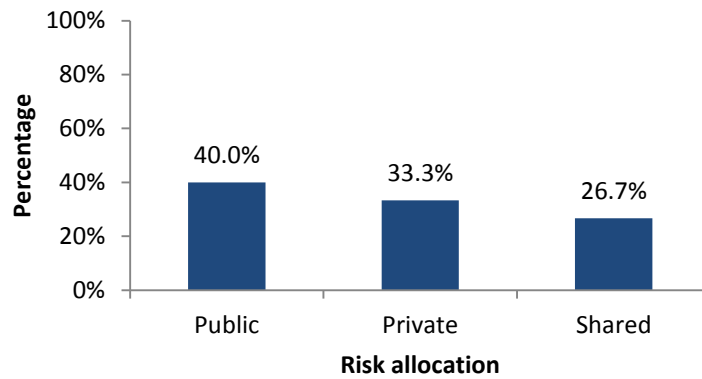

Risk allocation percentage between public and private sectors by private sector

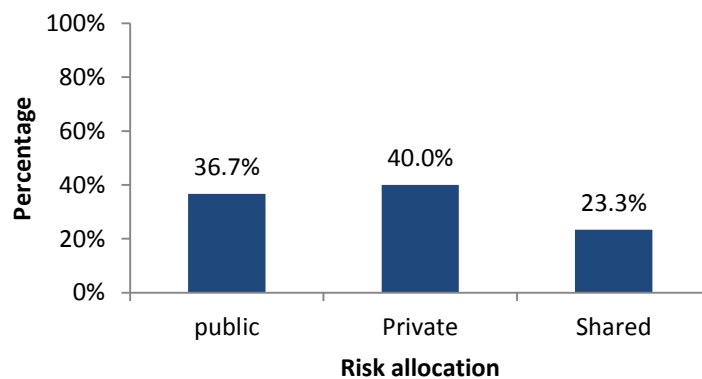

Risk allocation percentage between public and private sectors by researchers