

Publikationen der Deutschen
Gesellschaft für Photogrammetrie,
Fernerkundung und Geoinformation e.V.

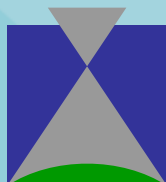

Band 25

2016

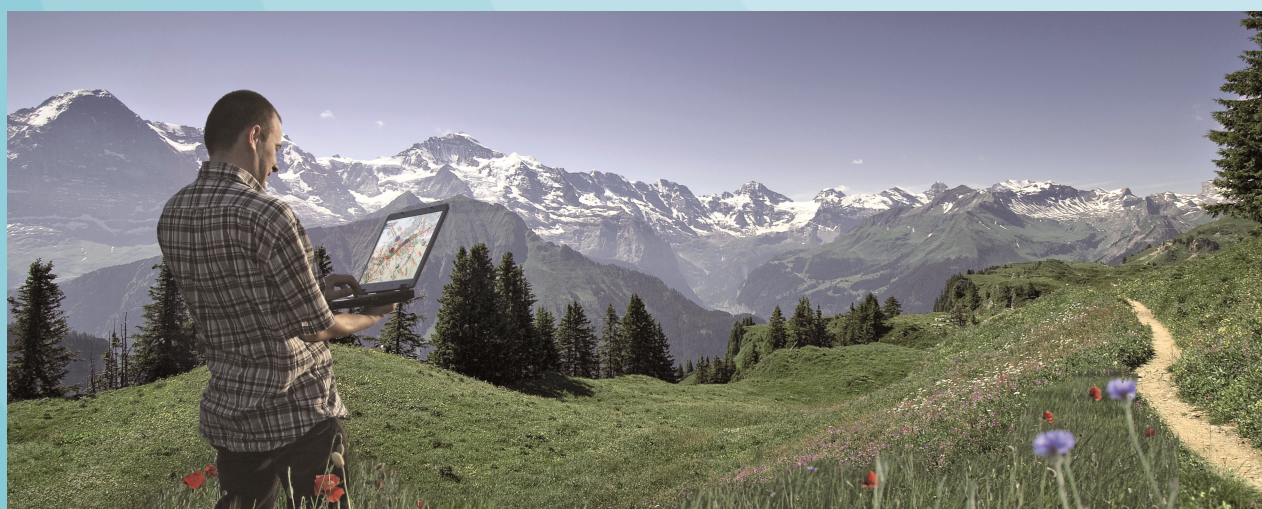

Beiträge

**36. Wissenschaftlich-Technische
Jahrestagung der DGPF**

7. – 9. Juni 2016
in Bern

***Dreiländertagung der SGPF, DGPF und OVG
Lösungen für eine Welt im Wandel***

ISSN 0942-2870

Thomas P. Kersten, Hrsg.

ISSN 0942-2870

Publikationen der
Deutschen Gesellschaft für Photogrammetrie, Fernerkundung
und Geoinformation (DGPF) e.V.
Band 25 421 S., Hamburg 2016
Hrsg.: Thomas P. Kersten

© Deutsche Gesellschaft für Photogrammetrie, Fernerkundung
und Geoinformation (DGPF) e.V.
München 2016

Zu beziehen durch:

Geschäftsstelle der DGPF
c/o Technische Universität München
Institut für Geodäsie, GIS und Landmanagement
Lehrstuhl für Geoinformatik
Arcisstraße 21
D-80333 München
Tel.: 089 289-22578, E-Mail: geschaeftsstelle@dgpf.de

Redaktion:

Thomas P. Kersten
HafenCity Universität Hamburg
Labor für Photogrammetrie & Laserscanning
Überseeallee 16, 20457 Hamburg
E-Mail: Thomas.Kersten@hcu-hamburg.de

Extending Semantic 3D City Models by Supply and Disposal Networks for Analysing the Urban Supply Situation

TATJANA KUTZNER¹ & THOMAS H. KOLBE¹

Abstract: For applications of 3D city models such as simulating the impact of failures in supply networks, information on the city objects as well as on the supply networks are required. The CityGML extension UtilityNetworkADE allows for modelling different types of networks, the focus currently being on the representation of topographical and topological aspects. However, for representing supply and disposal tasks, also functional aspects are of relevance, in particular, when no detailed modelling of supply networks is available, but the impact of a failure on a certain region is to be analysed nevertheless. This paper presents three methods complementing the CityGML UtilityNetworkADE by functional aspects regarding the modelling of supply areas, the characterisation of city objects and network features according to functional roles and the representation of the potential and current supply of commodities to city objects.

1 Introduction

Semantic 3D city models represent city objects such as buildings, bridges, tunnels, roads and vegetation. These city objects mainly constitute the visible part of a city, i.e. that part striking ones eye immediately when looking around a city. However, cities also exhibit a large number of city objects which are not apparent at first sight, but which are crucial to the functioning of the city as a system. These (often) hidden city objects – due to being below ground – contribute to the infrastructure of a city in the form of networks for water, electricity, sewage, telecommunication, and other public utilities.

In general, a network consists of a set of nodes which are connected by links (in graph theory usually referred to as vertices and edges). Networks can be classified according to various criteria. NEWMAN 2003, for instance, differentiates between social networks (i.e. networks dealing with social interactions between people), information networks (i.e. networks linking together knowledge), technological networks (i.e. networks distributing commodities or resources) and biological networks (i.e. networks representing biological systems).

In the context of our work, the focus is on technological networks, in particular on utility networks. Utility networks can also be considered as spatial networks, “i.e. networks whose nodes occupy a precise position in two or three-dimensional Euclidean space, and whose edges are real physical connections” (BOCCALETTI et al. 2006).

One well-known standard for representing 3D city models is the international OGC standard CityGML (GRÖGER et al. 2012). By means of so-called Application Domain Extensions (ADEs) the core model of CityGML can be extended systematically by application-specific attributes and object types. Specifically for applications dealing with supply and disposal networks, the *CityGML UtilityNetworkADE* (BECKER et al. 2011; BECKER et al. 2012) provides concepts which

¹ Technische Universität München, Lehrstuhl für Geoinformatik, Arcisstraße 21, D-80333 München, E-Mail: [kutzner, thomas.kolbe]@tum.de

allow for modelling different types of networks, such as electricity, freshwater, wastewater, gas or telecommunication networks.

So far, the CityGML UtilityNetworkADE focuses mainly on *topographical and structural* aspects. They allow for representing the position, the shape and the extent of networks including all individual network features such as switches, valves, pumps and pipes and for deriving spatial and computer-graphic-related answers therefrom.

However, when modelling supply and disposal networks, often *functional* aspects are of relevance as well. They are required for representing supply and disposal tasks, in particular when the available data do not reflect a detailed modelling of supply lines, but the impact of a network failure on a certain region and on the concrete city objects located in that region are to be analysed nevertheless. To be able to perform such analyses, it needs to be determined whether these city objects, e.g. buildings including their inhabitants, are supplied with the commodities in question. Furthermore, these analyses require information on the potential and actual supply of commodities to city objects and also the concrete flows and flow quantities need to be taken into account.

In the CityGML UtilityNetworkADE functional aspects can currently be represented through the topological connection of the network features which allows for simulating the propagation of failures across multi-network structures. This modelling, however, is not covering everything we need; the impact of failures on city objects and the population, for instance, cannot be simulated up to now. This paper presents three methods for how to complement the CityGML UtilityNetworkADE with these aspects. This includes the modelling of supply areas, a further characterisation of network features and city objects by the roles ‘source’ and ‘sink’ as well as complementing city objects with information on the supply of commodities to them. The UML diagrams presented in this paper are based on the ISO-compliant CityGML UML model (CITYGMLUMLMODEL 2016) which currently also serves as starting point for the further development of CityGML 3.0 (LÖWNER et al. 2014).

Section 2 provides a brief analysis of the CityGML UtilityNetworkADE and related network models regarding characteristics relevant to network modelling. Section 3 presents a refined definition of the concept of networks which includes aspects relevant to functional modelling as well. Section 4 introduces the new approaches for functional modelling to the CityGML UtilityNetworkADE and section 5 concludes this paper.

2 A brief review of related network models

Besides the CityGML UtilityNetworkADE, several other data models and formats for representing utility networks exist. The most relevant ones in the geospatial domain are the INSPIRE Utility Networks model (JRC 2013a) which is based on the INSPIRE Generic Network Model (JRC 2013b), the ISO standard Industry Foundation Classes (IFC) (ISO 16739:2013) which is predominantly used in Building Information Modeling and the ESRI Geometric Network model (ESRI 2016) based on which also distinct data models for gas, water and electricity for use with the ArcGIS software exist. For a detailed discussion of these data models please refer to BECKER et al. (2011) and BECKER et al. (2012).

Another ISO standard which allows for representing utility networks is SEDRIS (Synthetic Environment Data Representation and Interchange Specification) (SEDRIS 2016). SEDRIS focuses on the representation and exchange of synthetic environments and allows for modelling networks for electricity, water and wastewater as well as for oil, gas and chemicals. SEDRIS was developed for training simulation and is to date only applied in the military domain.

Under the umbrella of the OGC, PipelineML, a GML-based data interchange standard for the exchange of pipeline data focusing on the oil and gas industry, is currently under development (OGC 2016). In its current stage of development, the standard focuses on distribution components and 2D geometries only, terminal elements such as pump stations are not considered, neither is a topological representation of networks.

Data models for networks also exist in scientific literature. HALFAWY (2010), for instance, presents data models for water and wastewater networks, taking hereby also into account life-cycle aspects of network components such as maintenance operations or performance assessment.

The CityGML UtilityNetworkADE proposed by BECKER et al. (2011) and BECKER et al. (2012) aims, on the one hand, at providing “a common basis for the integration of the diverse models in order to facilitate joint analyses and visualization tasks” (BECKER et al. 2012), but, on the other hand, also intends to overcome shortcomings of existing network models with respect to the following characteristics: The data model should allow for the representation of heterogeneous networks, i.e. not only for specific types of networks, for a dual representation of network topography as well as topology and for a representation of topographic/graphic aspects

Tab. 1: Existence of characteristics relevant to network modelling in various data models

	INSPIRE Utility Networks	IFC	ArcGIS Utility Networks	SEDRIS	Pipeline ML	CityGML UtilityNetwork ADE
Representation of heterogeneous networks	+	•	•	+	•	++
Dual representation	+	++	+	++	–	++
Topographic/graphic aspects	++	++	++	++	++	++
3D geometries	–	++	–	+	–	+
Functional aspects	–	–	–	–	–	•
Hierarchical modelling						
• networks/ subnetworks	++	–	–	++	–	++
• components/ subcomponents	++	++	•	–	•	++
Interdependencies between						
• network features and city objects	–	•	–	•	–	++
• network features of different network types	–	++	–	–	–	++
– = no support, • = basic support, + = sophisticated support, ++ = comprehensive support						

(including 3D) as well as of functional aspects. Furthermore, the data model should allow for a hierarchical modelling of networks and subnetworks as well as of components and subcomponents and for modelling interdependencies between network features and city objects as well as between network features of different types of networks.

For the data models from INSPIRE, IFC and ArcGIS a detailed analysis regarding these characteristics is provided in BECKER et al. (2011) and BECKER et al. (2012). In the following, an overview based on this detailed analysis is provided in Table 1 which also takes into account the data models from SEDRIS and PipelineML and compares them to the CityGML UtilityNetworkADE.

The overview in table 1 and the detailed analysis show that the CityGML UtilityNetworkADE meets best the requirements for modelling utility networks regarding the characteristics in question. SEDRIS exhibits a similar good support; disadvantages, however, are the representational ambiguity of the format at runtime and the limited software support. Furthermore, CityGML can be extended more easily by the required functional aspects. Third-best support is offered by the INSPIRE Utility Networks data model, however, only 2D geometries are supported and its scope is limited to the EU. A disadvantage of IFC is its limitation to the building level. ArcGIS, in turn, is a proprietary software product, furthermore, no 3D solids are supported and its adaptation to other types of utility networks is difficult. PipelineML is currently still under development, the evaluation provided in the table is, thus, to be considered preliminary only.

3 The CityGML UtilityNetworkADE network concept

Central concept of the CityGML UtilityNetworkADE is the *network*, which can be represented in two ways: topographically as an aggregation of network features, i.e. of the individual components the network is constructed from, and topologically by means of a network graph, which is composed of the feature graphs of the individual network features. Regarding the topographical representation, the UtilityNetworkADE specifies in addition that a network can be decomposed into subnetworks and that it can be provided with information on what kind of commodity is transported by the network.

In reality, however, networks with more varied characteristics can occur. For this reason, we propose a more precise definition of the concept of a network together with a refined Core UML model of the CityGML UtilityNetworkADE. These refinements are also of importance to the further functional aspects to be introduced to the CityGML UtilityNetworkADE in section 4.

In its most general form, a network is simply a set of interconnected network features. From a semantic point of view, however, several other characteristics of what exactly constitutes a network need to be considered:

1. A network can represent a *subnetwork* of a more extensive network. Using the example of power supply, a transmission network operated by a certain transmission system operator represents one network. In the same way, a transmission network consisting of several interconnected individual transmission networks represents one network as well, the individual transmission networks being subnetworks of the interconnected network. An example are wide-area synchronous grids such as the European electricity transmission

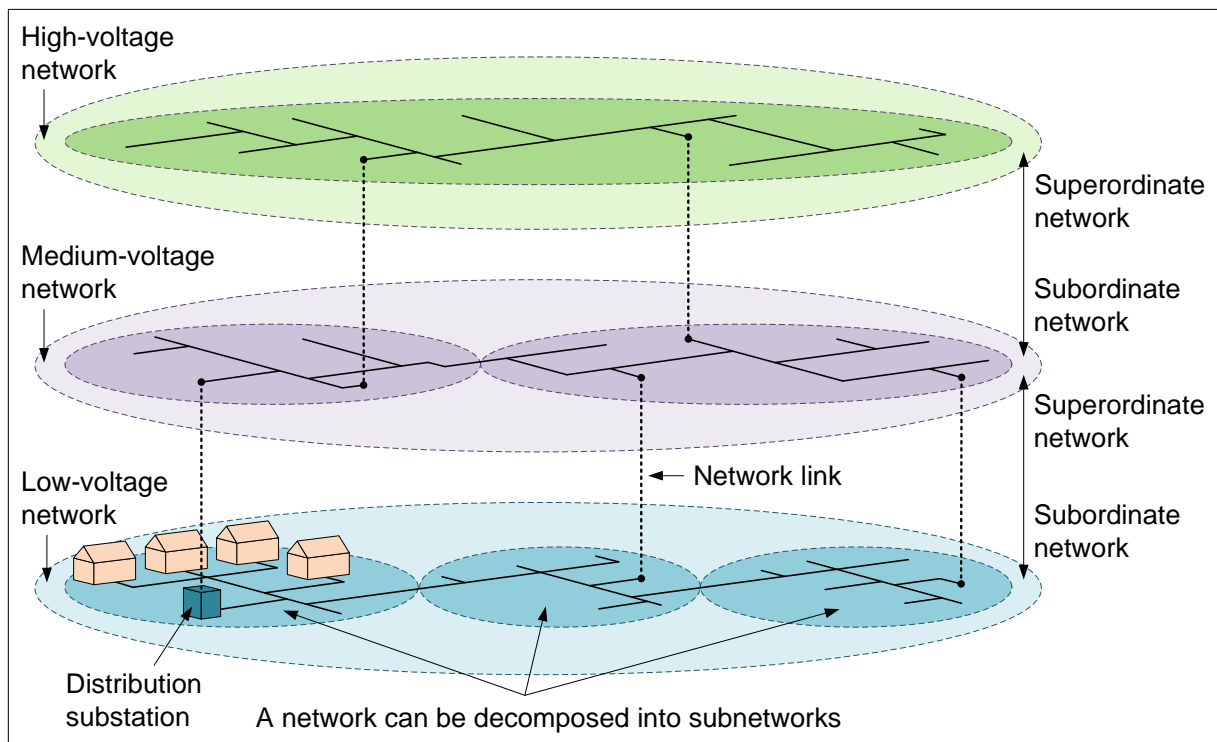

Fig. 1: Decomposition and hierarchical structuring of networks in the context of power supply

network (www.entsoe.eu) which interconnects the transmission networks of 42 electricity transmission system operators. Similarly, a distribution network operated by a certain distribution system operator represents one network. This distribution network could also be split up into several subnetworks, each subnetwork distributing power from a certain distribution substation to the connected end users (cf. Figure 1).

2. A network can represent a *subordinate network* to a *superordinate network* and vice versa. Using the example of power supply again, power is transmitted and distributed based on different voltage levels. High-voltage networks are used to transmit power across large distances, e.g. from power stations to supply regions. For distribution within a supply region to the end users, high voltage is first transformed to medium voltage and distributed via medium-voltage networks. Afterwards, medium voltage is transformed to low voltage by means of distribution substations and distributed via low-voltage networks to the end users (cf. Figure 1). From the point of view of the low-voltage network, the low-voltage network represents a subordinate network and the medium-voltage network its superordinate network. Similarly, the medium-voltage network is subordinate to the high-voltage network.
3. Although a network might initially have been constructed for transporting a certain type of commodity, it can in practice also be used for transporting other types of commodity, either simultaneously, alternately or replacing its intended usage. Power lines, for instance, cannot only distribute electricity, but they can also be used for transferring data simultaneously, which is referred to as powerline communication.

Based on these characteristics, the Core UML model of the CityGML UtilityNetworkADE is refined as follows (cf. Figure 2):

- Currently, the UML class *Network* supports the definition of subnetworks only in the sense of subordinate and superordinate networks. Since the concepts of subordinate and superordinate network are different from the concept of subnetwork, a new bidirectional association with the role names *subOrdinateNetwork* and *superOrdinateNetwork* is added to *Network* to be able to explicitly distinguish subordinate and superordinate networks from subnetworks which partition a larger network on the same network level.
- Following the attribution of feature classes in the CityGML specification, the attributes *class*, *function* and *usage* are added to *Network* as well. The attribute *class* allows for denoting the type of a network; possible values include *high-voltage network*, *medium-voltage network* and *low-voltage network* for power supply networks, as well as *high-pressure network*, *medium-pressure network* and *low-pressure network* for gas networks. The attribute *function* can be used to denote the intended usage of a network, whereas the attribute *usage* should be used to denote the actual usage of a network; possible values for these two attributes are *supply*, *disposal* and *communication*. The actual values for these attributes are, in compliance with the CityGML specification, to be provided as external code lists. More attributes as regards the specific types of commodity transported by a network are not required here; this information is already provided by the existing association *transportedMedium* between *Network* and the UML class *AbstractCommodityType* (cf. BECKER et al. 2012; CITYGMLWIKI 2016a). Since according to the third characteristic more than one commodity can be transported by the same network, only the multiplicity of the association needs to be changed from 0..1 to 0..* (not shown in Figure 2).
- Another refinement applied to *Network* is to extend it from the UML class *AbstractCityObject* instead of from *AbstractFeature*, since not only the individual network components (defined as UML subclasses of the UML class *AbstractNetworkFeature*; cf. BECKER et al. 2012 and CITYGMLWIKI 2016b) represent city objects, but also the networks themselves.
- Currently, a composition between *Network* and *NetworkLink* exists allowing for explicitly expressing links between networks of different network types, such as between a medium-voltage and a low-voltage network (cf. Figure 1). Since *NetworkLink* represents a topological concept, *Network*, however, a topographical concept, the composition should rather link the network topologies of the corresponding networks and, thus, be modelled between *NetworkGraph* and *NetworkLink*.

4 Integration of functional aspects into the CityGML UtilityNetworkADE

4.1 Representation of supply areas

The CityGML UtilityNetworkADE allows for representing in detail the structure of a network together with all the discrete network components the network is composed of and, thus, for following the route of a commodity from source to sink and for determining the whole area the commodity is supplied to by the network, i.e. the supply area. When a failure in one of the network components occurs, it is – due to the detailed modelling – easy to analyse which parts of the network itself and, in particular, which city objects within the supply area are affected by this

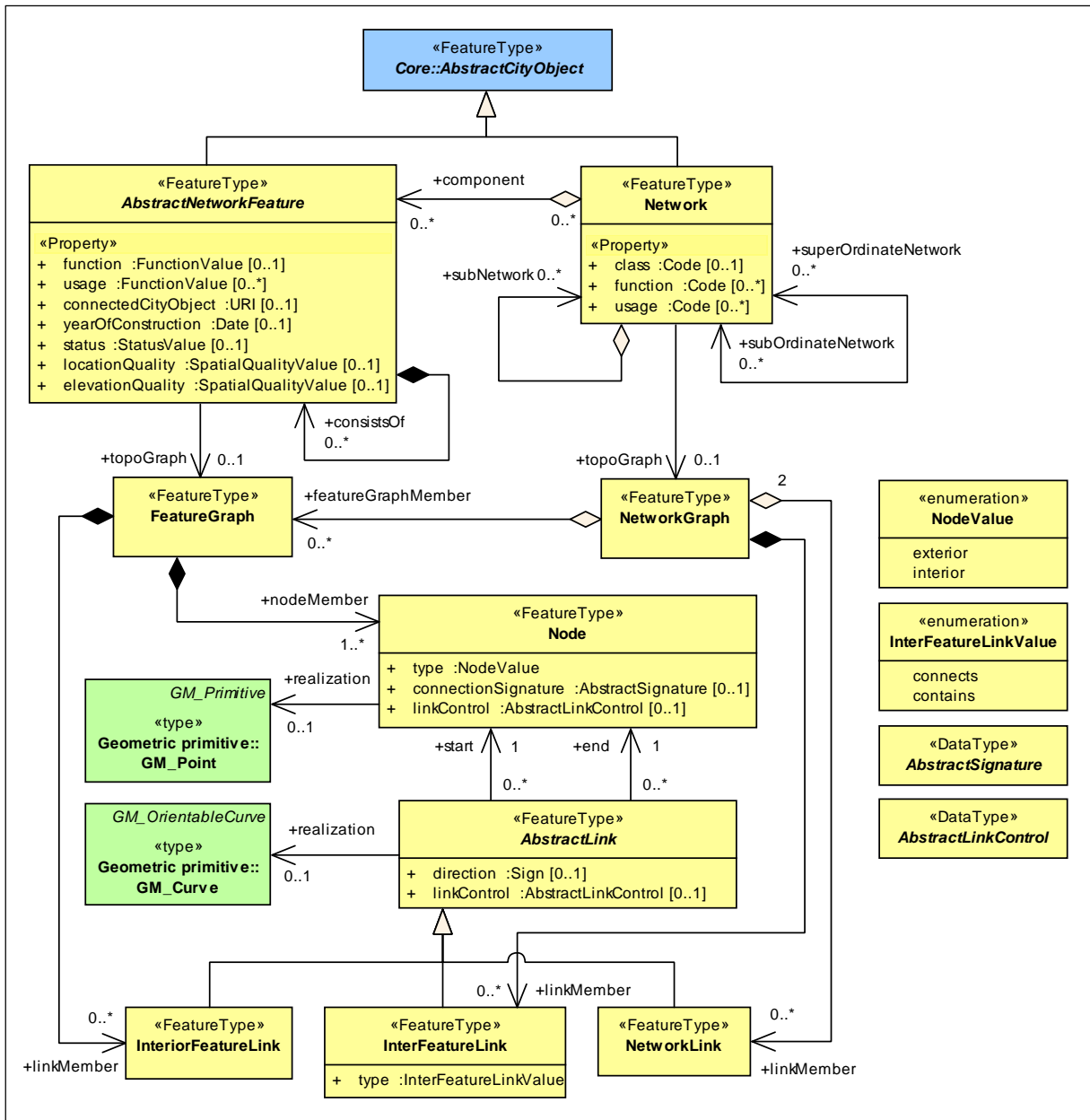

Fig. 2: CityGML UtilityNetworkADE – Refined Core UML model

failure. For certain reasons (e.g. data privacy issues), however, no information reflecting the detailed modelling of a network supplying a certain area with a commodity might be available; in that case it should still be possible to analyse which impact a failure of a source has on the corresponding supply area and on the concrete city objects located in that area.

To meet this demand, the concept of the supply area is to be introduced into the CityGML UtilityNetworkADE. We define a supply area as that geographic region a specific commodity is supplied to by a network. One could also say the supply area substitutes the network supplying that area, which, in turn, implies that the spatial extent of the supply area conforms to the spatial extent of the network it substitutes.

Furthermore, each supply area needs to be related to one or more sources supplying the commodity to that area. In the power supply context, for instance, a distribution substation transforming medium voltage to low voltage for distribution to city objects within a certain area could be regarded as such a source (cf. Figure 3). Above that, corresponding sinks need to be defined, in particular when the exact number of city objects a commodity is actually supplied to is of relevance to a certain application; otherwise it is assumed that the commodity is supplied to all city objects located within that region.

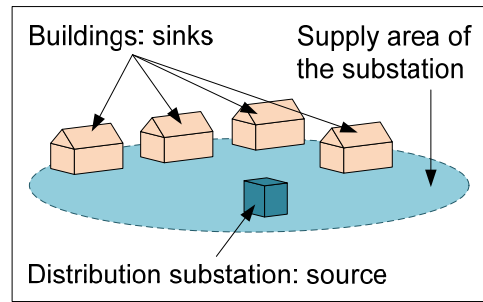

Fig. 3: The relationship between supply area, source and sink

In our new version of the CityGML UtilityNetworkADE the supply area is represented by the UML class *SupplyArea* (cf. Figure 4). By defining *SupplyArea* as a subclass of the UML class *CityObjectGroup*, each supply area can be provided with a geometry defining the spatial extent of the supply area (in particular the ISO 19107 geometry types *GM_Polygon* and *GM_MultiPolygon* are of relevance here). *CityObjectGroup* is associated with the UML class *AbstractCityObject* through the intermediate UML class *Role* which provides the attribute *role*. This association can be used to relate a supply area to the city objects located in that area. An OCL constraint is introduced which specifies that, when making use of the association, the attribute *role* needs to be set to the value *supplies*. The city objects located within a supply area can then be determined in two ways: Either explicitly through the above mentioned association between *SupplyArea* and *AbstractCityObject*, or implicitly by intersecting the geometry of the supply area with the geometries of the city objects.

Since the supply area is strongly related to the corresponding network supplying that area, a 1:1 association is defined between the UML classes *SupplyArea* and *Network*. The association is

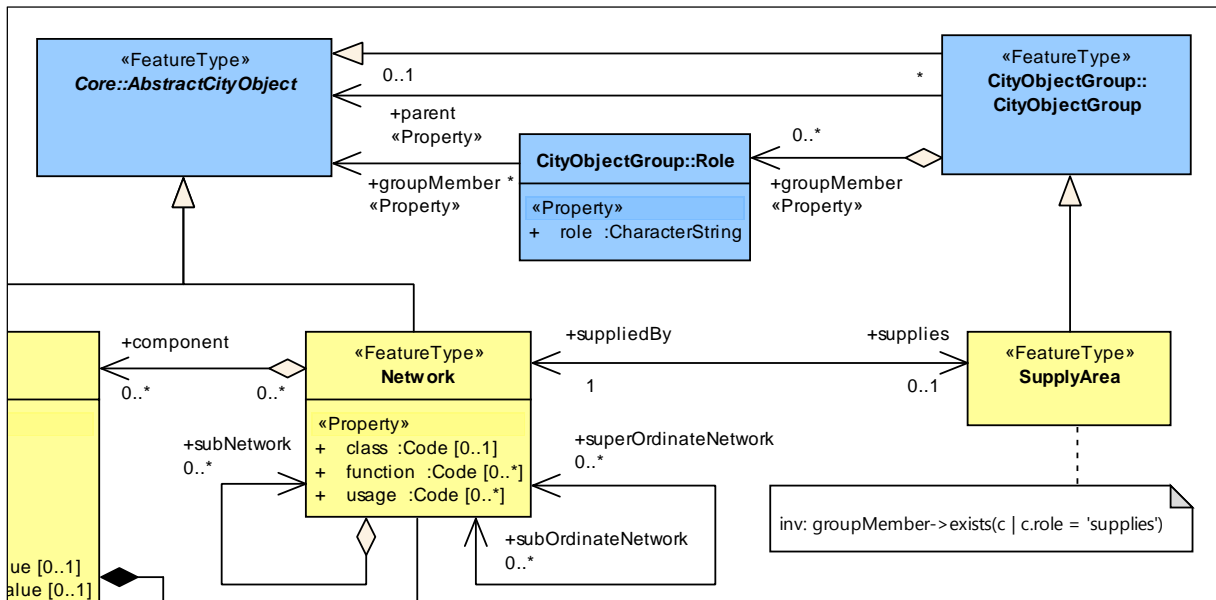

Fig. 4: Representation of supply areas in the CityGML UtilityNetworkADE. The blue classes are CityGML classes and the yellow ones are classes of the UtilityNetworkADE.

bidirectional to allow for navigating from the supply area to the corresponding network and vice versa. Thus, also the type of commodity supplied to an area can be specified by making use of the association *transportedMedium* between the UML classes *Network* and *AbstractCommodityType* (cf. BECKER et al. 2012; CITYGMLWIKI 2016b). The association between *SupplyArea* and *Network*, furthermore, allows for making use of the network characterisations provided in section 3 – subnetwork, subordinate and superordinate network. A network can now, for instance, not only be decomposed into subnetworks, but also a supply area into corresponding ‘sub’-supply areas.

The UML modelling for relating a supply area with sources and sinks will be presented as part of the next section.

4.2 Characterisation of infrastructure objects according to their functional role

Another important functional aspect is the possibility of representing the flow of commodities in a network by denoting network features and city objects with one of the roles source, sink, distribution, or storage. In particular in the context of supply areas this information is useful for relating a supply area with corresponding sources and sinks (cf. section 4.1).

The modelling of this aspect is already partially available in the existing UtilityNetworkADE (cf. Figure 5). The UML class *AbstractNetworkFeature* provides the attribute *function* of the type *FunctionValue* which contains, amongst others, the required roles (the values *feeding* and *draining* are representing the roles source and sink, respectively). This modelling states the intended role of a network feature; the role, however, might change when a network feature is used differently from its intended usage. Thus, the attribute *usage* is added to allow also for expressing the actual role of a network feature.

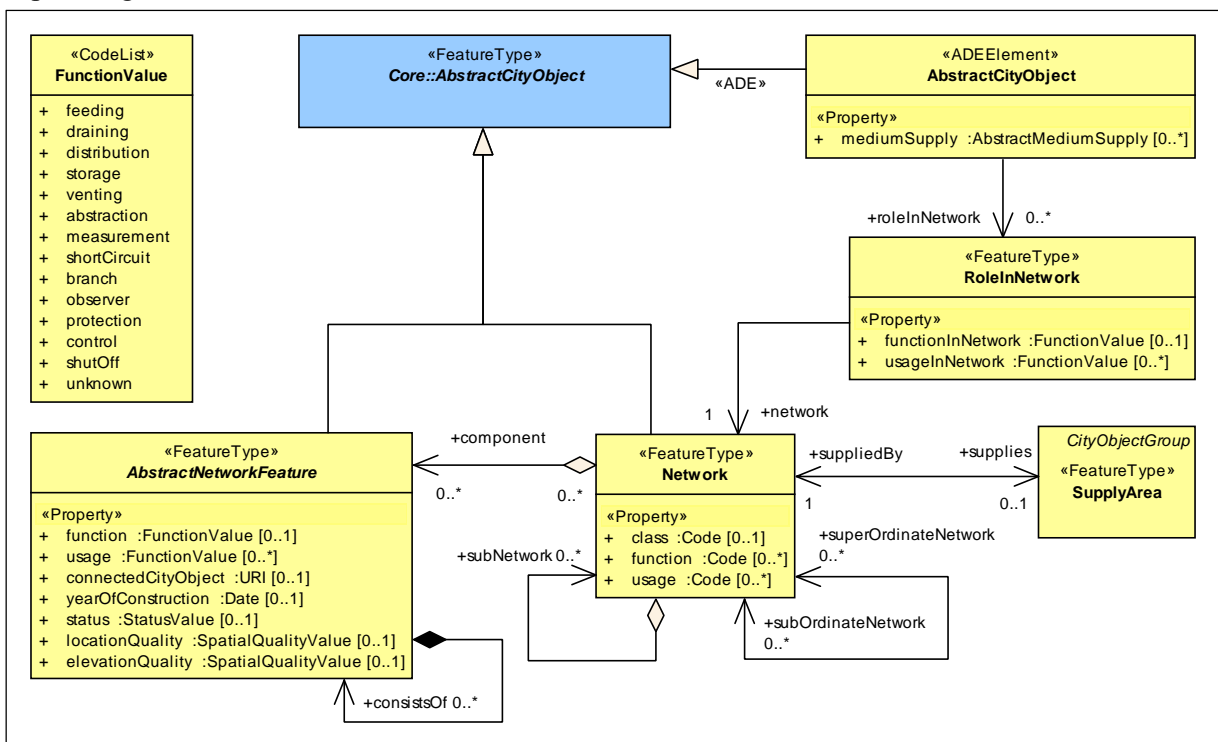

Fig. 5: Representation of functional roles in the CityGML UtilityNetworkADE

In addition, to be able to add these roles to city objects as well, a relationship between *AbstractCityObject* and *Network* is defined by means of the intermediate UML class *RoleInNetwork*. The class defines the attributes *functionInNetwork* and *usageInNetwork* which allow for denoting the intended and actual roles of a city object within a specific network. Each city object can be provided simultaneously with role information specific to different networks, i.e. a building can, for instance, at the same time be denoted as sink in a power network and as source in a wastewater network.

The relationship between *AbstractCityObject* and *Network* fulfils at the same time another important requirement; together with the relationship between *Network* and *SupplyArea* introduced in section 4.1 it yields a transitive relationship between *AbstractCityObject* and *SupplyArea* which allows for relating supply areas with the corresponding roles of city objects located in these areas. Similarly, a transitive relationship between *AbstractNetworkFeature* and *SupplyArea* via *Network* exists allowing for relating supply areas with the corresponding roles of network features located in these areas.

4.3 Representation of the potential and current supply of commodities to city objects

In particular in the context of simulations, and also in general when no information at all is available on networks, it can be useful to provide the city objects themselves with information on the potential and current supply of commodities to them. We introduce the following concepts to express this information:

- *Suppliability*: The suppliability of a city object defines the *potential supply* of a commodity to a city object, the reliability of the supply and whether storage is available allowing for autonomous supply with a commodity in case the supply via a network is interrupted, for instance due to a natural disaster.
- *Suppliedness*: The suppliedness of a city object defines the *actual supply* of a commodity to a city object at a specific point in time as well as the actual reliability of the supply and the actual state of the storage at that point in time.

In the new CityGML UtilityNetworkADE these concepts are represented by the UML class *AbstractMediumSupply* (cf. Figure 6). The class is specialised into the subclasses *ElectricalMediumSupply*, *GaseousMediumSupply*, *LiquidMediumSupply*, *OpticalMediumSupply* and *SolidMediumSupply* to be able to classify the suppliable commodities according to their physical condition. This classification conforms to the already existing classification of commodities transportable by networks used in the association *transportedMedium* between the UML classes *Network* and *AbstractCommodityType* (cf. BECKER et al. 2012; CITYGMLWIKI 2016a). The code lists indicating values for the specific commodity types can also be reused from there.

AbstractMediumSupply provides three attributes: *potentialSupply* and *currentSupply* for expressing the suppliability and suppliedness, respectively, as well as *storage* for providing information on possibly available storage. The attributes *potentialSupply* and *currentSupply* are of the type *Supply*, which, in turn, allows for explicitly stating the flow rate of a commodity (*flowRate*) as well as the supply reliability of that commodity (*status*), i.e. whether the supply is uninterrupted (*inUse*), intermittent (*tempOutOfService*), or unsupplied (*outOfService*), or

whether the supply line might even be *destroyed*. The attribute *storage* of the type *Storage* allows for providing detailed information on the type of a storage (*type*), on its potential and actual capacity (*maxCapacity*, *fillLevel*) as well as on the rate the commodity is flowing in and out of the storage (*inflowRate*, *outflowRate*). The enumeration *StatusValue* and the code list *StorageDeviceValue* are reused from the existing CityGML UtilityNetworkADE.

In order to be able to add all this information to a city object, the UML class *AbstractCityObject* is extended by the attribute *mediumSupply*, the multiplicity 0..* allowing for adding supply information of different commodities to each city object.

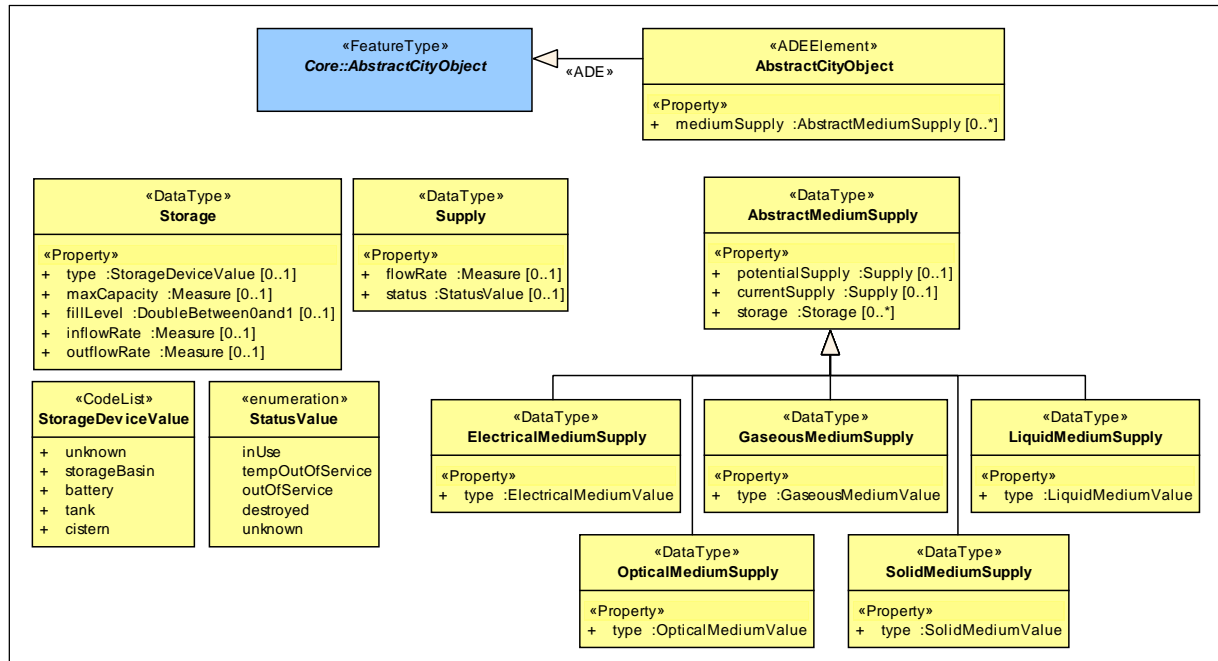

Fig. 6: Representation of the suppliability and suppliedness of city objects in the CityGML UtilityNetworkADE

5 Conclusion

The CityGML UtilityNetworkADE represents a suitable data model for modelling heterogeneous networks in the context of 3D city models. This paper introduces new concepts to the UtilityNetworkADE which add different functional aspects regarding the modelling of supply areas, the characterisation of city objects and network features according to functional roles and the representation of the potential and current supply of commodities to city objects. These functional aspects allow for representing supply and disposal tasks in cases when no detailed modelling of supply networks is available.

The CityGML UtilityNetworkADE as well as the newly introduced aspects were modelled using the software Enterprise Architect. By means of the software ShapeChange, corresponding XML schema files were successfully derived from the UML model and used in FME for testing the transformation of network information from Shape and dxf files to CityGML.

It is planned to include the CityGML UtilityNetworkADE together with the new functional aspects into the next version of CityGML (version 3.0). Another concept to be included in CityGML 3.0 is the so-called ‘Dynamizer’ concept which allows for modelling dynamic properties (CHATURVEDI & KOLBE 2015). This concept could then be used for making dynamic the functional properties introduced in this paper, i.e. the actual supply of commodities to city objects (including current flow rates, voltages, etc.) and the actual roles of city objects and network features.

6 References

- BECKER, T., NAGEL, C. & KOLBE, T.H., 2011: Integrated 3D Modeling of Multi-utility Networks and Their Interdependencies for Critical Infrastructure Analysis. *Advances in 3D Geo-Information Sciences, Lecture Notes in Geoinformation and Cartography*, Kolbe, T.H., König, G. & Nagel, C. (eds.), Springer, Berlin Heidelberg, 1-20.
- BECKER, T., NAGEL, C. & KOLBE, T.H., 2012: Semantic 3D Modeling of Multi-Utility Networks in Cities for Analysis and 3D Visualization. *Progress and New Trends in 3D Geoinformation Sciences, Lecture Notes in Geoinformation and Cartography*, Pouliot, J., Daniel, S., Hubert, F. & Zamyadi, A. (eds.), Springer, Berlin Heidelberg, 41-62.
- BOCCALETTI, S., LATORA, V., MORENO, Y., CHAVEZ, M. & HWANG D.-U., 2006: Complex networks: Structure and dynamics. *Physical Reports* **424** (4-5), 175-308.
- CHATURVEDI, K. & KOLBE, T.H., 2015: Dynamizers – Modeling and implementing dynamic properties for semantic 3D city models. 3rd Eurographics Workshop on Urban Data Modelling and Visualisation.
- CITYGMLUMLMODEL, 2016: ISO-compliant definition of the CityGML 2.0 UML model using Enterprise Architect. URL: <ftp://ftp.lrz.de/transfer/DidVfCGML/> (last access on 26/04/2016).
- CITYGMLWIKI, 2016a: NetworkComponents UML model. <http://www.citygmlwiki.org/> (last access on 26/04/2016).
- CITYGMLWIKI, 2016b: NetworkProperties UML model. <http://www.citygmlwiki.org/> (last access 26/04/2016).
- ESRI, 2016: What are geometric networks? <http://desktop.arcgis.com/en/arcmap/latest/manage-data/geometric-networks/what-are-geometric-networks-.htm> (visited on 26/04/2016).
- GRÖGER, G., KOLBE, T.H., NAGEL, C. & HÄFELE, K.-H., 2012: OGC City Geography Markup Language (CityGML) Encoding Standard, Version 2.0.0. OGC Document 12-019. Open Geospatial Consortium.
- HALFAWY, M.R., 2010: Municipal information models and federated software architecture for implementing integrated infrastructure management environments. *Automation in Construction* **19** (4), 433-446.
- ISO 16739:2013 Industry Foundation Classes (IFC) for data sharing in the construction and facility management industries.
- JRC, 2013a: D2.8.III.6 INSPIRE Data Specification on Utility and Governmental Services – Technical Guidelines. European Commission Joint Research Centre.

JRC, 2013b: D2.10.1: INSPIRE Data Specifications – Base Models – Generic Network Model, Version 1.0rc3. European Commission Joint Research Centre.

LÖWNER, M.-O., BENNER, J. & GRÖGER, G., 2014: Aktuelle Trends in der Entwicklung von CityGML3.0. Publikationen der Deutschen Gesellschaft für Photogrammetrie, Fernerkundung und Geoinformation e.V., Volume **23**, Seyfert, E., Gülch, E., Heipke, C., Schiewe, J. & Sester, M. (eds.), 34. Wissenschaftlich-Technische Jahrestagung der DGPF, March 26-28 in Hamburg.

NEWMAN, M.E.J., 2003: The structure and function of complex networks. *SIAM Review* **45** (2), 167-256.

OGC, 2016: PipelineML. URL: <http://www.pipelineml.org/> (visited on 26/04/2016)

SEDRIS, 2016: SEDRIS standards. URL: <http://standards.sedris.org/> (visited on 26/04/2016)