

Technische Universität München
Zentrum Mathematik
Mathematische Modellbildung

Well-Posedness for Flows in Porous Media with a Hysteretic Constitutive Relation

Elena El Behi-Gornostaeva

Vollständiger Abdruck der von der Fakultät für Mathematik der Technischen Universität München zur Erlangung des akademischen Grades eines
Doktors der Naturwissenschaften (Dr. rer. nat.)
genehmigten Dissertation.

Vorsitzender: Prof. Dr. Michael Ulbrich

Prüfer der Dissertation: 1. Prof. Dr. Martin Brokate

2. Prof. Dr. Pavel Krejčí,

Academy of Science, Prag, Tschechien

3. Prof. Augusto Visintin,

University of Trento, Povo di Trento, Italien

(schriftliche Beurteilung)

Die Dissertation wurde am 14.11.2016 bei der Technischen Universität München eingereicht und durch die Fakultät für Mathematik am 11.04.2017 angenommen.

ACKNOWLEDGMENTS

My first and biggest thanks goes to Prof. Dr. Martin Brokate for his constant support and advice during the last years. I sincerely thank him for trusting me and for encouraging me again and again.

I would further thank Prof. Augusto Visintin and Prof. Pavel Krejčí. They showed a deep interest in the topics developed in this thesis and provided very useful suggestions and comments.

I would like to thank all colleagues at the research unit M6 of the Technische Universität München for the nice and familiar working atmosphere. Thanks to Christina Kuttler, Kathrin Ruf, Karin Tichmann, Matthias Lang-Batsching and Carl-Friedrich Kreiner for proofreading the manuscript. Special thanks goes to Nikolai Botkin for his constant support and contribution with fruitful mathematical discussions.

During my Ph.D. I had the chance to participate into many conferences and workshops, to visit other universities and research groups. Each travel has been both a great personal experience and a contribution to my mathematical development. I am grateful for my membership in the IGDK1754 program, which made all these visits possible.

I would like to thank my family to whom this thesis is dedicated for their incalculable support and continuous encouragement. Thanks to my husband for standing by my side all the time, for trusting me, for listening and for enduring my (sometimes really) bad moods. Thanks to my mum and dad who have always told me to follow my dreams and to work hard to realize them.

Elena El Behi-Gornostaeva
Munich, 28th June, 2017

Fluid flow through porous media is a physical processes of considerable importance in science and engineering. In particular, fluid flow through porous media has attracted much attention due to its importance in several technological processes like for instance filtration, catalysis, chromatography, spread of hazardous wastes, and petroleum exploration.

Based of the one phase flow through a porous medium is the so called dam-problem, whose mathematical analysis stands in the center of this work. This problem consists of the investigation of water flow between several reservoirs of different height, which are separated by a porous medium. A simplified model leads to the following system, which was proposed and analyzed by Bagagiolo and Visintin in [4, 5]

$$\frac{\partial s}{\partial t} - \nabla \cdot k(\nabla p + \rho g \hat{z}) = 0, \quad (\text{P1})$$

$$s = \mathfrak{W}[p], \quad k = k(s), \quad (\text{P2})$$

coupled with appropriate initial and boundary conditions, including a seepage condition of Signorini-type. The saturation s and the pressure p are unknown. The quantity k represents the hydraulic conductivity, g the gravity acceleration and \hat{z} the upwards vertical unit vector.

The constitutive relationship - the dependence of the saturation s on the pressure p - plays a significant role in this context. Experimental results show that this relationship exhibits hysteresis and it is formally represented by a hysteresis operator \mathfrak{W} .

Problem (P1)-(P2) exhibits two interesting features, namely, as we already mentioned, that the s versus p relation displays hysteresis and that the coefficient k depends on s , thus also involves hysteresis. Problems with hysteresis in a coefficient tend to be rather resistant to classical analytic techniques. We are aware only of existence results for some modifications of problem (P1)-(P2). A model with no hysteresis relation has been studied by Alt, Luckhaus and Visintin [1] and Otto [55]. In [4], Bagagiolo and Visintin study the equation (P1) coupled with a constitutive relationship containing a general hysteresis operator and a rate-dependent component, and in [5] the

authors prove an existence result for problem (P1)-(P2), regularizing the k vs. s dependence by convoluting s in time with a smooth kernel. In [35], Kordulová analyzes the equation (P1) in two space dimensions coupled with a convexified Preisach operator and Neumann boundary conditions. An existence result is proved in the case when the hydraulic conductivity depends directly on the pressure and entails no occurrence of hysteresis.

In any of the mentioned cases, it is not clear how the applied techniques might be extended either to the case without a rate-dependent correction, or to the case of the direct dependence of k on the saturation s .

The aim of this work is the establishment of existence, regularity, and uniqueness of solutions to system (P1)-(P2) in three space dimensions, accounting for the direct dependence of the hydraulic conductivity k on the saturation s , and without convexifying the Preisach hysteresis operator. We apply techniques, though classical in the context of parabolic PDEs, but which - to our knowledge - were never used before in the presence of hysteresis.

In particular, this manuscript is structured in the following way.

In CHAPTER 1, we briefly present the physical background, which leads to the central equations of this work. The system is modeled with the help of a nonlinear diffusion equation, coupled with Signorini-boundary conditions. Moreover, we explain the reason for the occurrence of hysteresis in the context of fluid flows through porous media and present an appropriate hysteresis model to describe these phenomena.

Then, in CHAPTER 2, based on a simple example, we first outline what is hysteresis together with its main features and immediately after we introduce the concept of a hysteresis operator, pointing out its basic properties. We then present the play and Preisach hysteresis operators, together with their properties, and extend these definitions to the space dependent and to the time discrete case. Moreover, we prove some new inequalities for discretized Preisach operators, allowing for the application of the so called De Giorgi iteration scheme, and also for overcoming the lack of the Second Order Energy Inequality for Preisach operators whose loops are not necessarily convex.

In CHAPTER 3, we first introduce the weak formulation in the framework of Sobolev-spaces associated to the model problem (P1)-(P2). We then present the main results of this thesis, concerning existence, regularity, and - in a special case - also uniqueness of solutions of our central problem, together with their proofs. The proof of existence is based on approximation by implicit time discretization, appropriate a priori estimates of approximate solutions, and passing to the

limit by a compactness argument. After that, we prove that the partial derivatives of solutions of our problem are locally bounded. Due to the specific form of the boundary conditions, we are not able to prove a uniqueness result in the general case. Nevertheless, we will see that when the boundary conditions reduce to the case of Dirichlet boundary conditions, also uniqueness of solutions can be established. All the proofs are based on the results established in Chapters 4-7.

We start CHAPTER 4 by the introduction of the approximation of our main problem. Applying the implicit time discretization scheme, the original parabolic problem is transformed into a family of elliptic problems. The existence of a unique solution at each time step follows then by a classical existence result for operator inequalities. Moreover, we also establish the weak maximum principle for solutions of this family of equations.

In CHAPTER 5, we prove oscillation decay estimates for solutions of the approximate problem introduced in Chapter 4. These estimates are derived with the help of the De Giorgi iteration scheme. To our knowledge, this technique was never applied before in the presence of hysteresis. Our proof is similar to the one found in [34]. We will see how the techniques from [34] could be applied in presence of hysteresis and Signorini boundary conditions. As it turns out, the occurrence of the Preisach operator poses itself no obstacles to the derivation of the desired estimates, but we encounter problems due to the specific form of the boundary conditions. We refer to Section A.8 where we present how this particular situation can be handled.

The main estimate, that allows us to pass to the limit in the approximate problem as the approximation parameter tends to zero, is obtained in CHAPTER 6. This is an estimate of the incremental time ratio of solutions to the discretized problem from Chapter 4. During the estimation procedure we will encounter difficulties caused by the non-convexity of hysteresis loops on the one hand and by the dependence of the hydraulic conductivity on the saturation s on the other hand. We will handle these difficulties with the aid of oscillation decay estimates obtained in Chapter 5.

In CHAPTER 7, we deal with further regularity of solutions. In particular, we prove that all the partial derivatives of solutions to our central problem are locally bounded. These results are established via the Moser iteration scheme. In order to apply this technique we need a „good initial regularity“ of the gradient of solutions, which is obtained by application of a technique based on the Calderón-Zygmund decomposition and which, to our knowledge, is also applied for the first time in the presence of hysteresis. The key to the desired regularity is again the

Hölder continuity of solutions which follows from the results in Chapter 5.

Finally, APPENDIX A contains some complementary results, presented almost always without a proof, which have been used throughout the whole manuscript. We make an exception in section A.8, and prove in full detail why functions fulfilling certain integral inequalities also satisfy Hölder's condition.

LIST OF SYMBOLS

\emptyset	Empty set
\mathbb{N}	Set of natural numbers $\{1, 2, \dots\}$
\mathbb{R}	Set of real numbers
\mathbb{R}_0^+	Set of nonnegative real numbers
\mathbb{R}^n	Set of n-dimensional vectors over \mathbb{R}
\vec{e}_i	i-th unit vector in \mathbb{R}^n
\hat{z}	$\hat{z} := (0, 0, 1) \in \mathbb{R}^3$
$\text{int}S$	Interior of a set S
∂S	Boundary of a set S
\overline{S}	Closure of a set S
$ S $	Lebesgue measure of a set S
$B_\varrho(x_0)$	Ball centered at x_0 with radius ϱ
$Q(\varrho, \tau)$	Local parabolic cylinder of the form $Q(\varrho, \tau) = B_\varrho(x_0) \times (t_0 - \tau, t_0)$
$\chi_{[0, T]}$	Characteristic function of a set $[0, T]$, $T > 0$
$\frac{d}{dt}u, \dot{u}$	Derivative of $u : (0, T) \rightarrow \mathbb{R}$ with respect to t
$\frac{\partial}{\partial t}u, \dot{u}$	Partial derivative of $u : \Omega \times (0, T) \rightarrow \mathbb{R}$ with respect to the time variable t
$\frac{\partial^2}{\partial t^2}u, \ddot{u}$	Second partial derivative of $u : \Omega \times (0, T) \rightarrow \mathbb{R}$ with respect to the time variable t

$\frac{\partial}{\partial x_i} u, \partial_i u$ Partial derivative of $u : \Omega \times (0, T) \rightarrow \mathbb{R}$ with respect to the spatial variable x_i

∇u Jacobian matrix with respect to the spatial variable of $u : \Omega \times (0, T) \rightarrow \mathbb{R}^n$

$\nabla \cdot u$ Divergence with respect to the spatial variable of $u : \Omega \times (0, T) \rightarrow \mathbb{R}^n$

∇u Gradient with respect to the spatial variable of $u : \Omega \times (0, T) \rightarrow \mathbb{R}$

$\nabla \nabla u$ Hessian matrix with respect to the spatial variable of $u : \Omega \times (0, T) \rightarrow \mathbb{R}$

\dot{u}_m^n Incremental time ratio of a sequence $\{u_m^n\}_{n \in \{1, \dots, m\}}$, $m \in \mathbb{N}$ defined by $\dot{u}_m^n := \frac{u_m^n - u_m^{n-1}}{h}$ with $h = T/m$

\ddot{u}_m^n Second incremental time ratio of a sequence $\{u_m^n\}_{n \in \{1, \dots, m\}}$, $m \in \mathbb{N}$ defined by $\ddot{u}_m^n := \frac{\dot{u}_m^n - \dot{u}_m^{n-1}}{h}$ with $h = T/m$

$D_\tau^i u$ Difference quotient with respect to the spatial variable of $u : \Omega \times (0, T) \rightarrow \mathbb{R}$ in the direction i with $\tau > 0$

$\nabla_\tau u$ $\nabla_\tau u = (D_\tau^1 u, \dots, D_\tau^n u)$ for $u : \Omega \times (0, T) \rightarrow \mathbb{R}$

$\mathcal{F}(0, T)$ Set of all mappings $u : [0, T] \rightarrow \mathbb{R}$

$BV(0, T)$ Space of real-valued functions with bounded variation

$G_+(0, T)$ Space of real-valued right continuous regulated functions

$C^0(\overline{\Omega})$ Space of real-valued continuous functions on $\Omega \subset \mathbb{R}^n$

$C_0^1(\mathbb{R}^n)$ Space of real-valued continuously differentiable functions with compact support

$C_r^0([0, T])$ Space of real-valued functions which are continuous on the right in $[0, T]$

$C^{0, \alpha}(\overline{\Omega})$ Space of real-valued Hölder-continuous functions on $\Omega \subset \mathbb{R}^n$

$C^{\alpha, \beta}(\overline{Q})$ Parabolic space of real-valued Hölder-continuous functions on $\overline{Q} = \overline{\Omega} \times [0, T]$, $\Omega \subset \mathbb{R}^n$

$L^p(\Omega)$ Lebesgue space of real-valued functions on $\Omega \subset \mathbb{R}^n$

$L_{loc}^p(\Omega)$ Lebesgue space of real-valued local integrable functions on $\Omega \subset \mathbb{R}^n$

$W^{k, p}(\Omega)$ Sobolev space of real-valued functions on $\Omega \subset \mathbb{R}^n$

$H^1(\Omega)$ Sobolev space $H^1(\Omega) = W^{1, 2}(\Omega)$

$H^2(\Omega)$ Sobolev space $H^2(\Omega) = W^{2, 2}(\Omega)$

B^* Dual of a space B

$L^p(\Omega; B)$ Bochner- Lebesgue space of Banach space-valued functions

$W^{k,p}(\Omega; B)$ Bochner-Sobolev space of Banach space-valued functions on $\Omega \subset \mathbb{R}^n$

$\|u\|_{[0,T]}$ Norm on $G_+(0, T)$

$\|u\|_{[0,t]}$ Seminorm on $G_+(0, T)$

$\|u\|_{C^0(\bar{\Omega})}$ Norm on $C^0(\bar{\Omega})$

$\langle u \rangle_{\alpha, \Omega}$ Elliptic Hölder constant of a function $u \in C^{0,\alpha}(\bar{\Omega})$

$\langle u \rangle_{x,Q}^\alpha$ Parabolic Hölder constant w.r.t. the space variable of $u \in C^{\alpha,\beta}(\bar{Q})$

$\langle u \rangle_{t,Q}^\beta$ Parabolic Hölder constant w.r.t. the time variable of $u \in C^{\alpha,\beta}(\bar{Q})$

$\|u\|_{L^p(\Omega)}$ Norm on $L^p(\Omega)$

$\|u\|_{W^{k,p}(\Omega)}$ Norm on $W^{k,p}(\Omega)$

$\|u\|_{(H^1(\Omega))^*}$ Norm on $(H^1(\Omega))^*$

$\|u\|_{L^p(\Omega; B)}$ Norm on $L^p(\Omega; B)$

$\|u\|_{W^{k,p}(\Omega; B)}$ Norm on $W^{k,p}(\Omega; B)$

$\|u\|_{\Omega \times (0,T)}$ Norm on $L^\infty(0, T; L^2(\Omega)) \cap L^2(0, T; L^2(\Omega))$

γ_0 trace operator

$[r]$ $[r] := \max\{z \in \mathbb{Z} : z \leq r\}$

u^+ positive part of a function $u : \Omega \subset \mathbb{R}^n \rightarrow \mathbb{R}$

List of Symbols		ix
1	Mathematical Model of Flow in Porous Media	1
1.1	Basic Concepts	1
1.2	Capillarity	3
1.3	Capillarity in Porous Media and Hysteresis	5
1.4	Darcy's Equation	9
1.5	Governing Equations for Fluid Flow	10
1.6	Boundary Conditions	11
2	Hysteresis Operators	13
2.1	Basic Definitions and Properties	14
2.2	The Scalar Play Operator	15
2.3	The Preisach Operator	19
2.4	Space Dependent Hysteresis Operators	24
2.5	Time Discrete Hysteresis Operators	27
3	Model Problem and Main Results	43
3.1	Weak Formulation of the Problem	44
3.2	Assumptions on the Data, the Domain Ω , and the Preisach Operator	45
3.3	Main Results	49
4	Approximation and the Weak Maximum Principle	59
4.1	The Approximate Problem	59
4.2	The Weak Maximum Principle	64
4.3	Estimates of $h \sum_{n=1}^l \ \nabla p_m^n\ _{L^2(\Omega)}^2$	66

5 Oscillation Decay Estimates	69
5.1 First Estimate	70
5.2 Second Estimate	74
5.3 Third Estimate	80
5.4 Oscillation Decay Estimates for Approximate Solutions	81
6 Estimates of the Time Derivative	85
6.1 Some Preliminary Results	86
6.2 Estimate of Initial Values	100
6.3 Estimate of the Incremental Time Ratio	102
6.4 Estimate of $\ \nabla s_m^n\ _{L^2(\Omega)}^2$	112
7 Further Regularity of Solutions	115
7.1 Calderón-Zygmund Type Estimates	116
7.2 Local Boundedness of \dot{p} in the Interior	130
7.3 Local Boundedness of ∇p in the Interior	141
A General Analysis Results	153
A.1 Domains and their Boundaries	153
A.2 Function Spaces	156
A.3 Kurzweil Integral	159
A.4 Remarks on Monotone Operators	160
A.5 Cut-Offs, Difference Quotients, and Steklov-Approximates	161
A.6 Interpolation Inequalities	162
A.7 Additional Results	163
A.8 De Giorgi - Type Classes	165
A.8.1 An Elliptic De Giorgi Class	165
A.8.2 A Parabolic De Giorgi Class	181
A.8.3 Time Discrete De Giorgi Classes	200
A.9 The Heat Equation	201
A.10 Gronwall's Lemma	202
A.11 Parabolic Subdivision, a Calderón-Zygmund - Type Lemma, and the Hardy-Littlewood Maximal Function Operator	202
Bibliography	205

CHAPTER 1

MATHEMATICAL MODEL OF FLOW IN POROUS MEDIA

In this chapter we present a general model for fluid flow through porous media together with its simplified form, known as the Richards equation, which is applicable (under specific assumptions) to describe water flow in unsaturated media. The governing equations are formulated using the capillary pressure-saturation relationship and an empirical extension of Darcy's equation for multiphase flow. While the validity of these concepts, and the models based on them, is a subject of ongoing scientific debate, the models described here are used to simulate many practical cases of fluid flows with sufficient accuracy [26, 31].

First, we present basic concepts of multi-phase flow in porous media. Further, we address the specific question of capillarity, which is the ability of a liquid to flow in narrow spaces without the assistance of, or even in opposition to, external forces like gravity. We then show how this effect affects flows through porous media and outline where the hysteresis comes from. We then introduce the governing equations for the one-phase flow and finally present a set of boundary conditions widely applied in the unsaturated zone modeling. We refer to [14], and to [64], and for the references therein for the presentation of physical and modeling background.

1.1 Basic Concepts

Soil is a porous medium consisting of solid particles and „void“ spaces called pores. These pores are typically filled with liquid (water) and gaseous (air) phases. We assume that the pore network (also known as the PORE SPACE) is connected. This assumption allows the phases to move inside the porous medium.

For the flow model considered in this work we assume moreover that the gaseous and liquid phases are single-component fluids, that the solid skeleton is rigid, and that the solid phase is homogeneous, incompressible, and does not react with the fluids. Moreover, we assume that

both fluids are barotropic, i.e. each phase density depends only on the pressure in the respective phase, and we neglect mass transfers between the fluids, i.e. the dissolution of air in water and the evaporation of water.

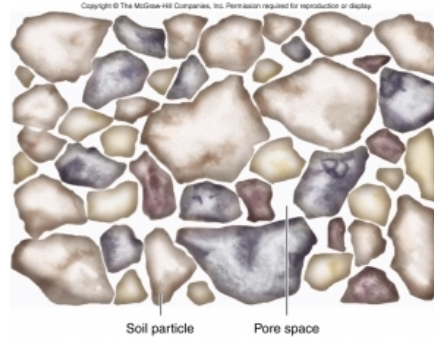

Figure 1.1: A microscopic view of soil. Source: [33].

The microscopic view of soil (c.f. Fig. 1.1) indicates that the pore space exhibits a highly complex, inhomogeneous geometric structure which we cannot describe in a precise way. Therefore we say that the relevant physical quantities defined at a point x represent averages taken over a representative elementary (small) volume element (REV) associated with that point (cf. Fig. 1.2).

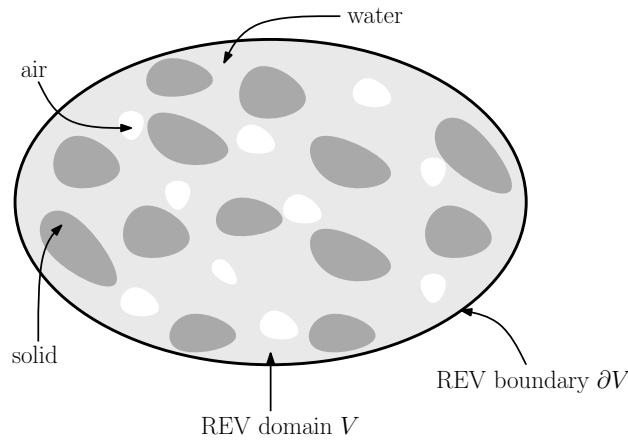

Figure 1.2: Representative Elementary Volume element - REV

In this setting, the same point can be occupied simultaneously by all three phases. This is represented by the concepts of volume fractions and saturations.

The VOLUME FRACTION θ_i of phase i is defined as the ratio of the volume of the part V_i of the REV occupied by phase i to the total volume V of the REV, i.e.

$$\theta_i := \frac{V_i}{V}. \quad (1.1.1)$$

POROSITY φ is defined as the volume fraction of pores, and it is equal to the sum of the volume fractions of the two pore fluids

$$\varphi := \frac{V_w + V_a}{V} = \theta_w + \theta_a, \quad (1.1.2)$$

where the index w stands for the *water*-phase and the index a stands for the *air*-phase. Moreover, it is convenient to define the SATURATION s_i of each phase i which is equal to the fraction of the pore space occupied by a given fluid

$$s_i := \frac{\theta_i}{\varphi}, \quad (1.1.3)$$

from which we follow, that the sum of the air and water saturations must be equal to one

$$s_a + s_w = 1. \quad (1.1.4)$$

In general, each saturation can vary from 0 to 1. However, in most practical situations the range of variability is smaller. For instance, if a fully water-saturated medium is drained, at some point the domain occupied with mobile water becomes disconnected and the liquid flow is no longer possible. The corresponding value of saturation is called RESIDUAL and is denoted by s_{rw} ¹. Similarly, during imbibition in a dry medium in natural conditions it is generally not possible to achieve full water saturation, as a part of the pores will be occupied by isolated air bubbles. The corresponding residual air saturation is denoted as s_{ra} ².

1.2 Capillarity

When two fluids are present in the pore space, one of them is preferentially attracted by the surface of the solid skeleton. We call this phase the WETTING PHASE, while the other is called NON-WETTING. In this work, we consider only porous media showing greater affinity to water than to air which are more widespread in nature [32].

Immiscible fluids are separated by a well defined interface which can be considered infinitely thin. As a consequence of the different degrees of attraction between molecules of different nature, a tension exists at the interface, which is called SURFACE TENSION and which is a measure of the forces that must be overcome to change its shape.

One consequence of the existence of the surface tension is that the pressures of air and water, which are separated by a curved interface as depicted in Fig. 1.3(a), are not equal due to unbalanced tangential forces at the dividing surface. The pressure drop between the pressure of the fluid at the higher pressure and the fluid at the lower pressure is called CAPILLARY PRESSURE, is usually denoted by the symbol p_c , and can be calculated from the Laplace equation as follows [58]

$$p_c = p_a - p_w = \sigma_{aw} \left(\frac{1}{R_1} + \frac{1}{R_2} \right), \quad (1.2.1)$$

¹However, the value of water saturation can be further decreased by natural evaporation or oven drying.

²Yet, the water saturation can decrease for instance, if the air is compressed or dissolves in water.

where the subscripts a and w again denote the air and water phases respectively, σ_{aw} stands for the surface tension of the air-water interface, and R_1 and R_2 are the main curvature radii of the interface. (see Fig. 1.3(a)).

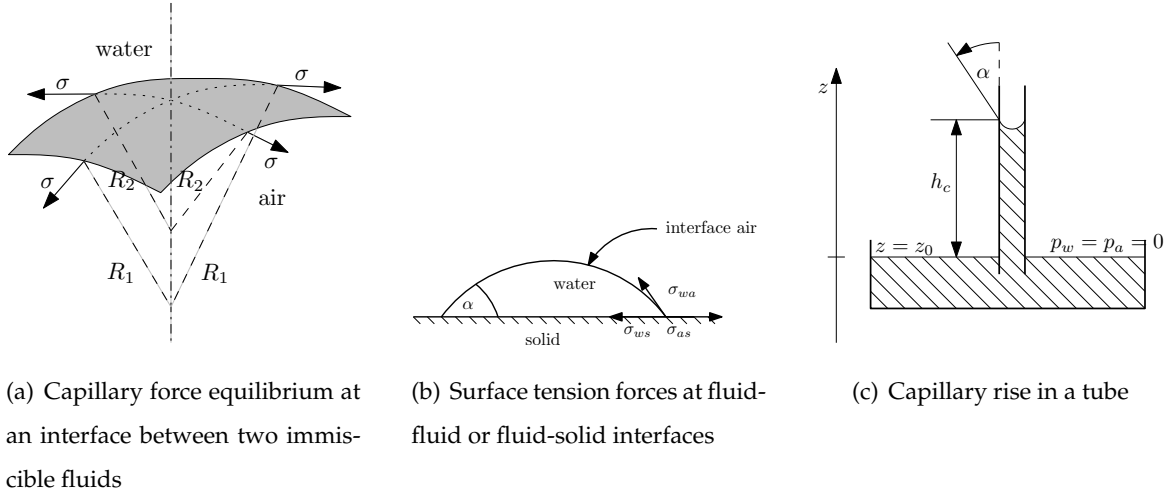

(a) Capillary force equilibrium at an interface between two immiscible fluids

(b) Surface tension forces at fluid-fluid or fluid-solid interfaces

(c) Capillary rise in a tube

Figure 1.3: Surface tension effects

Just as there exists a surface tension between immiscible fluids, there is a surface tension between a fluid and a solid. The surface tension between water and air σ_{aw} differs from that between water and solid material σ_{ws} . A water droplet on a glass plate tends to spread as shown in Fig. 1.3(b)). The contact angle α between the water-air interface with the solid at equilibrium fulfills the requirement of zero resultant force at the contact of the three phases and consequently

$$\cos \alpha = \frac{\sigma_{sa} - \sigma_{ws}}{\sigma_{aw}} \quad (1.2.2)$$

holds, where σ_{sa} denotes the surface tension between the solid phase and air. This equation is known as Dupré or Young's formula. Contact angles $\alpha < \frac{\pi}{2}$ correspond to the wetting phase and angles $\alpha > \frac{\pi}{2}$ correspond to the non-wetting phase.

Surface tension is also the origin of the capillary rise observed in small tubes (cf. Fig. 1.3(c)). The molecules of the wetting phase are attracted by the tube wall and a curved interface (meniscus) forms between water and air above the free surface of water. The pressure drop across the interface is denoted in this context as the capillary pressure and can be computed for a cylindrical tube as

$$p_c = \frac{2\sigma_{aw} \cos \alpha}{r_c}, \quad (1.2.3)$$

where r_c is the tube radius. If atmospheric pressure is used as the reference pressure, then the water pressure at the interface is negative, in other words the water is under suction. As a result of this imbalance, the water rises in the capillary tube up to an equilibrium level $h_c + z_0$ (c.f. Fig 1.3(c)). As the water pressure is zero at $z = z_0$ one must have

$$h_c = \frac{2\sigma_{aw} \cos \alpha}{\gamma_w r_c} = \frac{p_c}{\rho_w g}, \quad (1.2.4)$$

where ρ_w is the specific weight of water, g is the gravity acceleration, and $\gamma_w := \rho_w g$ is the specific weight of water.

1.3 Capillarity in Porous Media and Hysteresis

It is customary to view an unsaturated soil as consisting of capillary „pores“, in which menisci separate the two phases. At equilibrium it is assumed that for a given (macroscopically uniform) water content the air-water interfaces have the same constant total curvature throughout the porous medium. Soil scientists traditionally define this state by the CAPILLARY HEAD Ψ , which is defined as the ratio between the negative of the capillary pressure $-p_c$ and the specific weight of water γ_w , i.e.

$$\Psi := -\frac{p_c}{\gamma_w}. \quad (1.3.1)$$

One method to measure the capillary head in soil determines directly the pressure difference between air and water and the corresponding water content in the soil. An illustration of the experimental setup is shown in Fig.1.4.

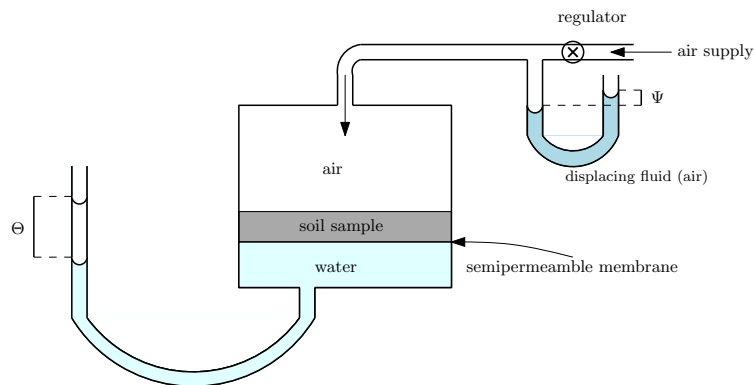

Figure 1.4: Experimental setup for measuring the capillary head in soil

A soil sample, completely saturated with water at atmospheric pressure, is placed in contact along a fraction of its surface with air. The measurement is performed as follows:

- ① Pressure in the air phase is increased and then kept constant. A certain volume of air penetrates the sample and expels a certain amount of water Θ which is measured.

The air is retained in the porous medium by a semipermeable membrane that transmits the displaced water but not the air.

On the other hand, the displacement h_c of a „displacing fluid“ for the air phase can be measured and the capillary head Ψ computed using formulae (1.2.4), and (1.3.1).

- ② Pressure in the air is increased again. When equilibrium is reached, a new and lower equilibrium water saturation prevails in the core. Ultimately, repeating the operation succes-

sively, a curve of capillary head versus water saturation or water content is obtained (cf. Fig 1.5(a)-„first drainage“curve). The experiment shows that a point is reached when even a tremendous increase in capillary pressure no longer induces a saturation change. The water saturation is said to have reached its residual value.

- ③ The wetting (or imbibition) curve can be obtained by letting the pressure drop stepwise and water imbibe back. However, a different curve is obtained (cf. Fig. 1.5(a)-„main wetting“curve), which implies that for a given water content several equilibrium states are possible depending on previous history. The capillary pressure curve is said to display HYSTERESIS.
- ④ If the sample is drained again, the main drying curve is described. If the process is reversed before the capillary head has reached the value Ψ_{\min} , the „primary wetting“curve is described. But if the process is reversed only after the value Ψ_{\min} has been reached, then the „main wetting“curve is described again.

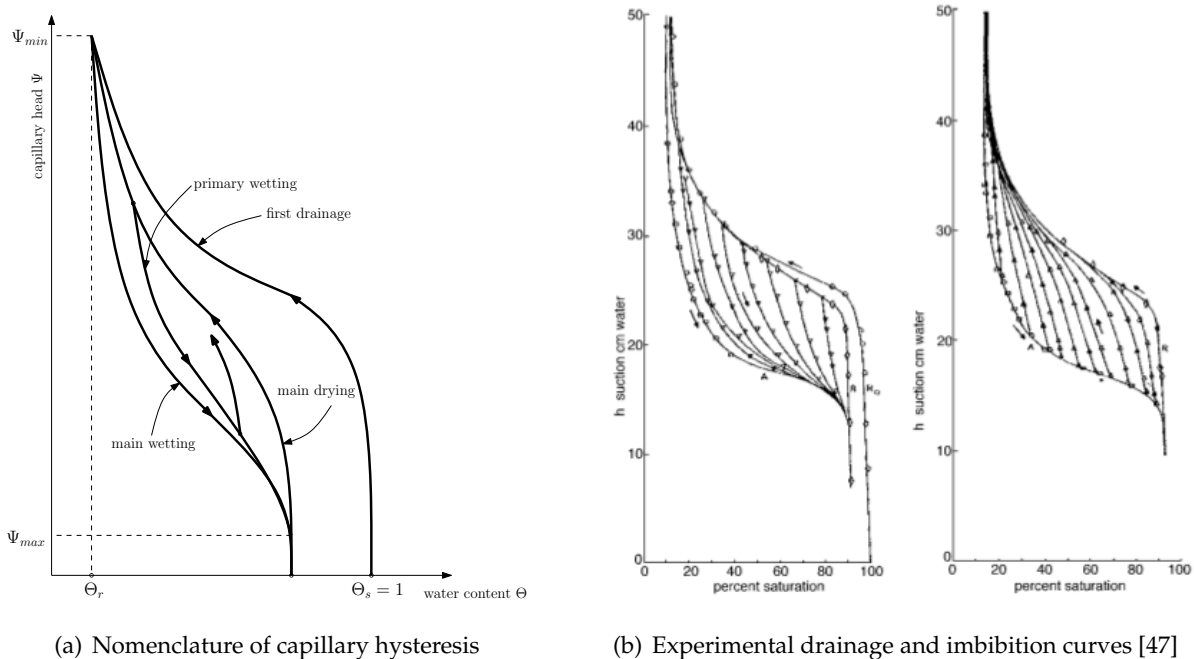

Figure 1.5: Capillary head - saturation relationship

In this setting, the phenomenon of hysteresis may be attributed to a number of causes. Probably the most important one is the GEOMETRY of the porous system. Assuming that the isolated pores are connected by narrow channels, one observes that this geometry permits different configurations of the interface at equilibrium for the same value of Ψ . Fig. 1.6(a) displays a pore with two different degrees of filling, yet with the same curvature radius for the interface and consequently the same capillary head.

Figure 1.6(b) displays another type of geometry that causes hysteresis, the so called „ink-bottle“ effect, as the same curvature can exist with various degrees of filling of the void space.

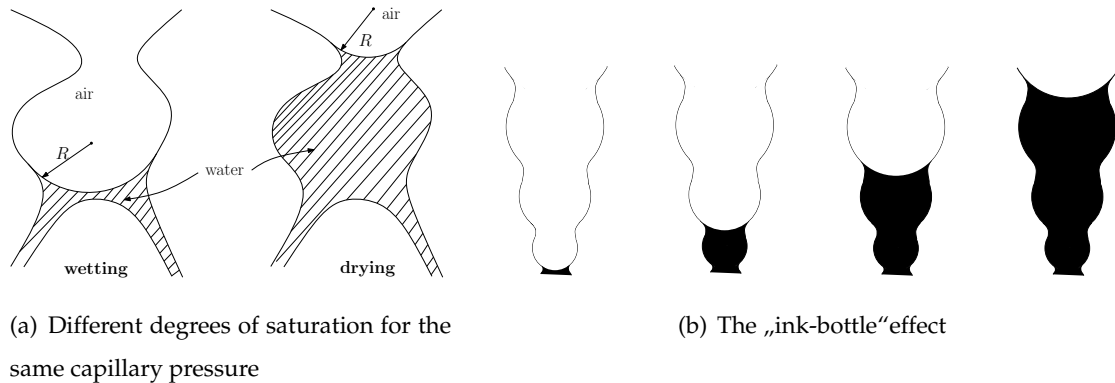

Figure 1.6: Different geometry effects

A second effect is the HYSTERESIS OF THE CONTACT ANGLE α . As stated in the discussion of the capillary rise in a tube, the capillary pressure depends on the contact angle α , which in general is not constant. It reaches its maximum value when the liquid moves toward a dry surface and takes its minimum value when it recedes. This phenomenon can be observed visually in the process of filling and emptying a capillary tube (cf. Fig. 1.7(a))

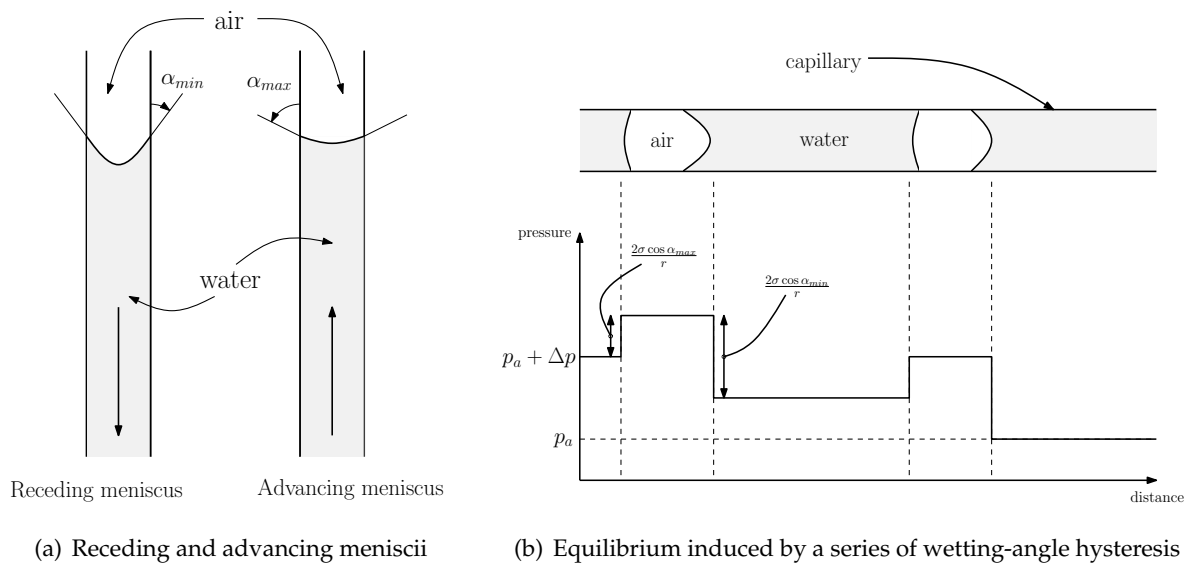

Figure 1.7: Hysteresis of the wetting angle

As a result of this wetting angle hysteresis, a row consisting alternately of air bubbles and of liquid drops can resist against a significant pressure drop between the two ends of a tube before changing its state (cf. Fig. 1.7(b)).

ENTRAPMENT OF AIR during the imbibition process is another important factor. The appreciable difference between the first drainage curve and the main drying curve displayed in Figure 1.5(a) is the direct result of this air entrapment. It may be explained in a simple way by the closing of narrow entrances of pores or groups of pores by the wetting fluid in a slow wetting process. The

air content in the sample varies with time as air dissolves in water and moves away by diffusion. It is a known fact, that if Ψ is kept constant for a long time, the water content increases as air disappears from the soil [8].

The fundamental theory of hysteresis based on the INDEPENDENT DOMAINS CONCEPT was initiated by Preisach [59] and Néel [53, 54] and thoroughly analyzed by Everett and his coworkers [25, 24, 21, 22] and Enderby [19].

According to this theory, a porous medium is viewed as a system consisting of independent elementary pore domains. Each domain is characterized by two length scales ρ and r which can be interpreted geometrically as the radius of the pore and the radius of its constricted connection with other pores respectively. Using the capillary law ($\Psi \propto 1/R$) the variables ρ and r can be uniquely related to the wetting and drying capillary head Ψ_w and Ψ_d . The pore domain has therefore only two stable states, either empty or full (cf. Fig. 1.8).

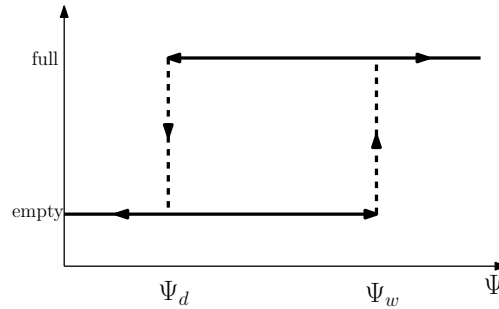

Figure 1.8: Hysteretical behavior of the isolated pore domain

In a wetting process, the pore is empty until Ψ reaches the value Ψ_w at which time it flips over to a filled state. There is no change in the water content of the pore when Ψ is increased further. In a drainage process, the pore remains filled with water until Ψ reaches the value of Ψ_d . At this instant the pore is totally drained. We will see in the next chapter that this behavior corresponds to the DELAYED-RELAY hysteresis operator.

It is assumed that for each pore its values Ψ_w and Ψ_d are independent of the state of the neighboring pores. Hence, denoting by ΔV the pore volume and taking Ψ_w, Ψ_d as independent variables, continuously distributed between Ψ_{min} and Ψ_{max} , one can define a pore-water density function

$$f(\Psi_w, \Psi_d) = \frac{\Delta V(\Psi_w, \Psi_d)}{V},$$

where V is the total volume of the sample. Superposing the behavior of all pores whose parameters Ψ_w and Ψ_d are distributed according to this density function then leads to the dynamics depicted in Fig. 1.5. In the next chapter we will see that this relationship can be represented by means of the PREISACH hysteresis operator. For further amendments of this model we refer to the works of Philip [57], Mualem [50, 51], Everett [23] and Topp[65], and the references therein.

1.4 Darcy's Equation

Inside the REV (c.f. Fig 1.2) the momentum conservation principle for each fluid phase is represented by the Navier-Stokes equations. In the case of steady, laminar flow of an incompressible Newtonian fluid i in a horizontal tube having a uniform circular cross-section, the Navier-Stokes equations reduce to the Poiseuille equation, which gives the following formula for the average fluid velocity v_i [6]:

$$v_i = -\frac{r_c^2}{8\mu_i} \frac{d}{dx} p_i, \quad (1.4.1)$$

where r_c is the tube radius and μ_i is the dynamic viscosity coefficient of the fluid i . An important feature of this relationship is that the average velocity is directly proportional to the pressure gradient and that the proportionality coefficient depends on the geometric parameters and the fluid viscosity.

In a more general case of three-dimensional single-phase flow in a medium characterized by arbitrary pore geometry homogenization of the Navier-Stokes equations yields the following result (cf. [3, 6, 30, 71]):

$$v_i = -\frac{k(s_i)}{\mu_i} (\nabla p_i + \rho_i g \hat{z}), \quad (1.4.2)$$

where k is the absolute permeability tensor, g is the gravity acceleration, and \hat{z} is the upward unit vector $\hat{z} = (0, 0, 1)$.

If two fluids flow within the pore space, it is often assumed, that their velocities can be expressed by the following extended form of the Darcy FORMULA, i.e. [58]:

$$v_i = -K_i(s_i) (\nabla p_i + \rho_i g \hat{z}), \quad (1.4.3)$$

where K_i is the conductivity tensor which depends on the saturation of the phase i . In the case of anisotropic porous media, the relationship between conductivity and saturation will be different for each component of the conductivity tensor. However, for practical purposes a simplified relationship in the following form was postulated by van Genuchten [66]

$$K_i(s_i) = \kappa_i(s_i), \quad (1.4.4)$$

where κ_i is a scalar function of the saturation s_i . According to the van Genuchten model one can assume that the dependence $\kappa_i(s_i)$ is of the form depicted in Fig. 1.9.

Hence, the extended Darcy formula can be rewritten in the following form:

$$v_i = -\kappa_i(s_i) (\nabla p_i + \rho_i g \hat{z}). \quad (1.4.5)$$

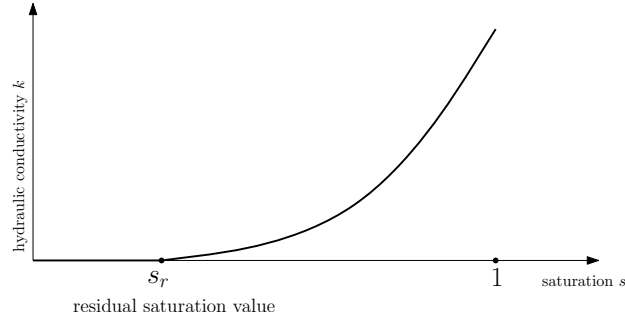

Figure 1.9: Hydraulic conductivity-saturation relationship according to van Genuchten [66]

1.5 Governing Equations for Fluid Flow

The governing equation for two-phase flow in a porous medium are derived from the mass conservation principle applied in the REV (cf. Fig. 1.2) associated to the point x .

In the absence of source or sink terms, mass conservation yields that the change in the total mass of a fluid phase i inside the REV must be equal to the total mass flux of the phase i through the REV boundary. Assuming that the solid phase is rigid, this can be written as:

$$\frac{\partial}{\partial t} \int_{\text{Volume of REV}} \varphi \rho_i s_i dx = \int_{\text{boundary of REV}} \rho_i v_i \cdot \vec{n} d\sigma, \quad (1.5.1)$$

where \vec{n} is the outward normal vector to the boundary of the REV. Using the Gauss-Ostrogradski theorem this equation can be transformed to the differential form

$$\frac{\partial}{\partial t} (\varphi \rho_i s_i) + \nabla \cdot (\rho_i v_i) = 0. \quad (1.5.2)$$

The velocity of each fluid phase with respect to the solid phase is given by the Darcy formula (1.4.5). If the compressibility of the fluids and of the porous medium can be neglected, substitution of the Darcy equation (1.4.5) into the mass balance equation (1.5.2) for each phase results in the following system of two coupled PDEs:

$$\frac{\partial}{\partial t} (\varphi s_w) - \nabla \cdot [\kappa_w(s_w)(\nabla p_w + \rho_w g \hat{z})] = 0, \quad (1.5.3a)$$

$$\frac{\partial}{\partial t} (\varphi s_a) - \nabla \cdot [\kappa_a(s_a)(\nabla p_a + \rho_a g \hat{z})] = 0, \quad (1.5.3b)$$

$$p_c = p_a - p_w. \quad (1.5.3c)$$

This two-phase flow model can be considerably simplified under specific conditions. Under natural conditions, the air viscosity is very small compared to the water viscosity, which means that the air mobility is much greater than the water mobility if the relative permeabilities of both fluids are similar. Therefore, it can be expected that any pressure difference in the air phase will be equilibrated much faster than that in the water phase.

Assuming that the air phase is connected in the pore space and that it is connected to the atmosphere one can consider the pore air to be essentially at a constant atmospheric pressure. Neglecting the variations in the atmospheric pressure allows then to eliminate the equation for the air flow from the system of governing equations (1.5.3). The capillary pressure is now uniquely defined by the water pressure. For convenience it is often assumed that the reference atmospheric pressure $p_{atm} \equiv 0$, so one can write:

$$\frac{\partial}{\partial t}(\varphi s_w) - \nabla \cdot [\kappa_w(s_w)(\nabla p_w - \rho_w g)] = 0, \quad (1.5.4a)$$

$$p_w = -p_c(s_w). \quad (1.5.4b)$$

Equation (1.5.4a) is referred to as the RICHARDS EQUATION and relationship (1.5.4b) exhibits hysteresis.

1.6 Boundary Conditions

We present now the following specific sets of boundary conditions widely applied in modeling flows in unsaturated porous media. They include an INFILTRATION condition, a DRAINAGE condition, the SEEPAGE FACE condition, and the SOIL-ATMOSPHERE INTERFACE condition.

The infiltration condition occurs on some part of the boundary and is one possibility to allow for inflow inside the medium.

The drainage condition represent a vertical flow of water through the bottom of the soil towards a distant groundwater table. In this work, we assume that there is no flow through the bottom, so the drainage condition becomes in fact an impermeability condition.

The seepage face is a part of the outer surface of the porous medium which is exposed to the atmosphere and through which water can flow freely out of the porous domain. It typically occurs above the water level in wells and at the bottom of the landward slopes of earth dams or embankments.

To transform these concepts into a mathematical framework we follow [4, 5]. Let Ω be a bounded domain, representing the region occupied with soil and let us distinguish three parts of $\partial\Omega$ as depicted in Fig. 1.10. We have:

- ① A time dependent surface $\Gamma_1'(t)$ in contact with time dependent aquifers and time-dependent reservoirs. Here, the pressure p_w is prescribed by some positive and time-dependent function $\tilde{P} > 0$.
- ② A time dependent surface $\Gamma_1''(t)$ in contact with the atmosphere. Here, at any instant t the pressure p_w is not greater than that of the atmosphere. If $p_w = p_{atm} = 0$, then water may flow out of the medium. If $p_w < 0$, then no outflow is allowed.

- ③ A time independent impervious part Γ_2 . Here, the flux through Γ_2 is assumed to be 0.

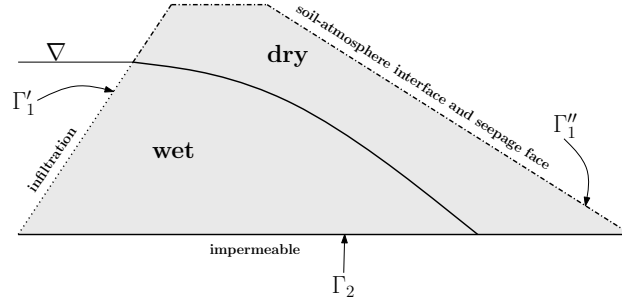

Figure 1.10: Illustrative boundary condition for a case of a two-dimensional flow in a dike

Let us denote by \vec{n} the outward normal unit vector to Ω , $\Gamma_1 := \Gamma_1'(t) \cup \Gamma_1''(t)$, and for $T > 0$ we set $\Sigma_i := \Gamma_i \times (0, T)$, $i = 1, 2$.

Moreover, let \tilde{P} be a nonnegative function defined on Σ_1 , representing the datum of the pressure p_w . \tilde{P} vanishes on those parts of Σ_1 in contact with air and coincides with the hydrostatic pressure of the reservoir on those parts of Σ_1 in contact with water. Then, on $\Sigma_1 \cup \Sigma_2$ we prescribe the following boundary conditions

$$p_w^+ = \tilde{P} \quad \text{on } \Sigma_1, \quad (1.6.1a)$$

$$k\nabla(p_w + \rho_w \vec{g}) \cdot \vec{n} \leq 0, \quad \text{on } \Sigma_1 \cap \{p_w = 0\}, \quad (1.6.1b)$$

$$k\nabla(p_w + \rho_w \vec{g}) \cdot \vec{n} = 0, \quad \text{on } \Sigma_1 \cap \{p_w < 0\}, \quad (1.6.1c)$$

$$k\nabla(p_w + \rho_w \vec{g}) \cdot \vec{n} = 0, \quad \text{on } \Sigma_2. \quad (1.6.1d)$$

Following [4, 5], we observe that conditions (1.6.1a), (1.6.1b), together with (1.6.1c) are equivalent to the following variational inequality of SIGNORI TYPE

$$k\nabla(p_w + \rho_w \vec{g}) \cdot \vec{n}(u - \varphi) \leq 0, \quad \forall \varphi : \Sigma_1 \rightarrow \mathbb{R}, \text{ such that } \varphi^+ = \tilde{P}. \quad (1.6.2)$$

Hysteresis is a phenomenon, that occurs in several and rather different situations: for instance in physics we find it in plasticity, in ferromagnetism, in phase transition, in filtration through porous media. Hysteresis is also encountered for in engineering, in chemistry, in biology and in several other settings. In the context of flows through porous media, as we have seen in Chapter 1, experimental results show a hysteretic behavior in the constitutive relation between pressure and saturation of the medium.

Even if hysteresis has been known and studied since the end of the eighteen century, it was only in the 1970ies that a small group of Russian mathematicians introduced the concept of a HYSTERESIS OPERATOR and started a systematic investigation of its properties. The pioneers in this new field were Krasnosel'skij and Pokrovskij with their monograph [38]. From that moment on many scientists coming from different areas have contributed to the mathematical study of hysteresis. We quote the following monographs devoted to this topic: Brokate and Sprekels [12], Krejčí [40], Mayergoyz [46] and Visintin [67], together with references therein.

In the first section of this chapter we introduce the basic concept of a hysteresis operator. Then, in Sections 2.2 and 2.3, we present examples of hysteresis operators which become important in our context. Moreover, we recall some well known results for these hysteresis operators.

In Section 2.4, we extend the concept of a hysteresis operator to space dependent systems and prove some additional regularity results.

Finally, in Section 2.5, we introduce a time discretized version of hysteresis operators in such a way that their basic properties remain preserved. We also prove certain properties for this operators which will become important in Chapters 4, 5, and 6.

2.1 Basic Definitions and Properties

According to [67], we can distinguish two main features of hysteresis phenomena: the MEMORY EFFECT and RATE INDEPENDENCE. Let us first briefly explain them on a simple example.

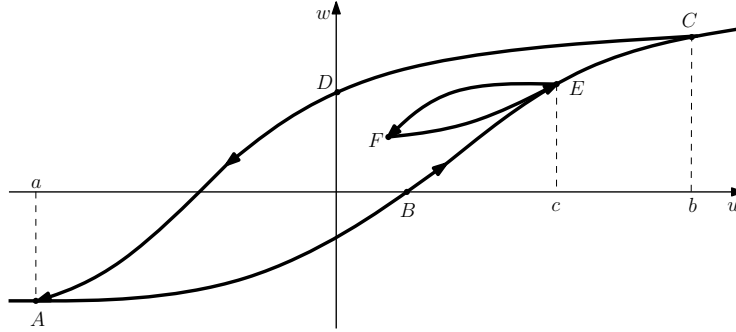

Figure 2.1: Continuous hysteresis loop

Fig. 2.1 describes the state of a system which is characterized by two scalar variables u and w depending continuously on time. We will call them INPUT and OUTPUT of the system. We have the following:

- If the input increases from a to b , then the couple (u, w) moves along the curve ABC .
- If, on the other hand, the input decreases from b to a , then the couple (u, w) stays on the curve CDA .
- If moreover at a certain instant t , such that $a < u(t) = c < b$, the input u inverts its movement, then (u, w) moves into the interior of the region bounded by the major loop $ABCD$ in a suitable way, described by the specific model used, for example along the curve EF as depicted in the picture.

We also require that the path of the couple $(u(t), w(t))$ is invariant with respect to any increasing homeomorphism, that is there is no dependence on the derivative of u . This property is named RATE INDEPENDENCE and allows us to draw the characteristic pictures of hysteresis in the (u, w) -plane.

In many cases the state of the system is not completely described by the couple (u, w) . At any instant t , the output $w(t)$ will depend on the evolution of the input until that time t and also on the initial state of the system. So the initial value $(u(0), w(0))$ or some equivalent information must be specified. As $u(0)$ is already contained in $u|_{[0,t]}$, we say that in these cases the state of the system can be described by an operator of the following type

$$\mathcal{H} : \text{Dom}(\mathcal{H}) \subset \mathcal{F}(0, T) \times \mathbb{R} \rightarrow \mathcal{F}(0, T), \quad (u, w^0) \mapsto w(\cdot) := \mathcal{H}[u, w^0](\cdot), \quad (2.1.1)$$

where w^0 represent the initial value of the output w , and $\mathcal{F}(0, T)$ stands for the set of all mappings $u : [0, T] \rightarrow \mathbb{R}$. This is the case, for example, of PLAY OPERATORS introduced in Definition 2.2.2.

However there are also cases in which the state of the system is not completely characterized by the couple (u, w^0) but there is also the presence of a variable $\eta^0 \in X$ containing all the information about the initial state, where X is some suitable metric space. In these situations the state of the system is described by an operator of the following type

$$\mathcal{H} : \text{Dom}(\mathcal{H}) \subset \mathcal{F}(0, T) \times X \rightarrow \mathcal{F}(0, T), \quad (u, \eta^0) \mapsto w(\cdot) := \mathcal{H}[u, \eta^0](\cdot). \quad (2.1.2)$$

This is the case for instance for PREISACH OPERATORS, introduced in Section 2.3.

An operator of type (2.1.1) or (2.1.2) is said to be a HYSTERESIS OPERATOR if it fulfills the CAUSALITY and the RATE INDEPENDENCE properties which respectively read:

✧ For all $(u_1, w^0), (u_2, w^0) \in \text{Dom}(\mathcal{H})$ and all $t \in [0, T]$,

$$u_1 = u_2 \text{ in } [0, t], \quad \text{implies} \quad \mathcal{H}[u_1, w^0](t) = \mathcal{H}[u_2, w^0](t), \quad (2.1.3)$$

✧ For all $(u, w^0) \in \text{Dom}(\mathcal{H})$, all $t \in (0, T]$ and any increasing homeomorphism $\phi : [0, T] \rightarrow [0, T]$

$$\mathcal{H}[u \circ \phi, w^0](t) = \mathcal{H}[u, w^0](\phi(t)). \quad (2.1.4)$$

holds.

2.2 The Scalar Play Operator

The first simple model of hysteresis we consider, is a mechanism known as MECHANICAL PLAY. More precisely, we have two elements **A** and **B** which move along a horizontal line with one degree of freedom (cf. Figure 2.2(a)).

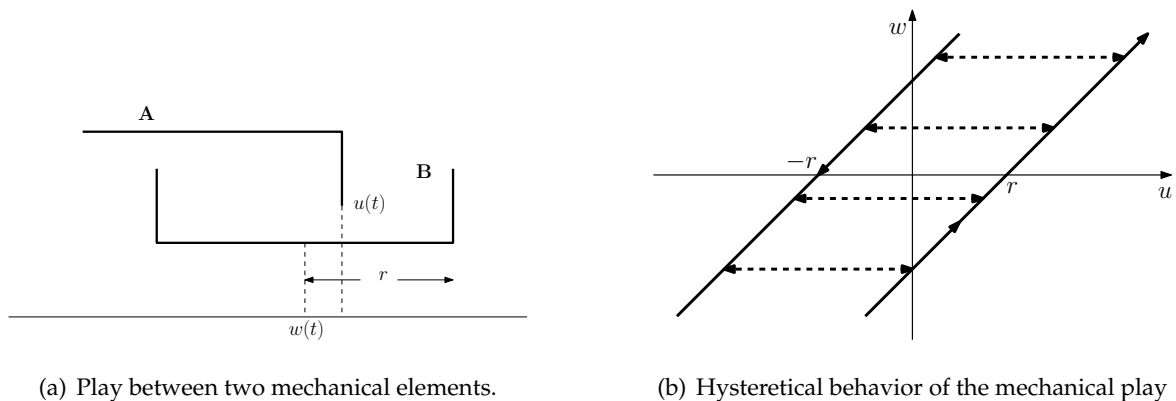

Figure 2.2: The mechanical play

The motion of such two elements can be described as follows: the position $w(t)$ of the middle point of element **B** remains constant as long as the element **A**, represented by its end-position

$u(t)$, moves in the interior region of width $2r$, which is the diameter of the element \mathbf{B} . When u hits the boundary of the element \mathbf{B} , then w moves with the velocity $\dot{w} = \dot{u}$, which is directed outwards. The input-output behavior is given by the hysteresis diagram shown in Fig. 2.2(b).

The relation $u \mapsto w$ can also be expressed by means of a hysteresis operator in the following way: For any initial value w^0 , and any piecewise monotone input function $u : [0, T] \rightarrow \mathbb{R}$ the output function $w(t) := \mathcal{P}_r[u, w^0]$ can be defined inductively using the following formula

$$w(0) = \max \{u(0) - r, \min \{u(0) + r, w^0\}\} \quad (2.2.1a)$$

$$w(t) = \max \{u(t) - r, \min \{u(t) + r, w(t_{n-1})\}\} \quad \text{for } t_{n-1} < t \leq t_n, \quad 1 \leq n \leq N, \quad (2.2.1b)$$

where N is chosen such that $t_N = T$. The operator \mathcal{P}_r is called **PLAY OPERATOR**. The following result, see [12, Example 2.2.13 and Theorem 2.3.2], holds.

Proposition 2.2.1. *For any $r \geq 0$ the operator \mathcal{P}_r can be extended to a unique Lipschitz continuous operator $\mathcal{P}_r : C^0([0, T]) \times \mathbb{R} \rightarrow C^0([0, T])$ (with Lipschitz constant 1). In addition this operator \mathcal{P}_r is causal and rate independent in the sense of (2.1.3) and (2.1.4), i.e. it is a hysteresis operator.*

The play operator can also be introduced in another way. According to [40, Section I.3] the following system

$$|u(t) - \xi_r(t)| \leq r \quad \forall t \in [0, T], \quad (2.2.2a)$$

$$\dot{\xi}_r(t)(u(t) - \xi_r(t) - z) \geq 0 \quad \text{a.e } \forall z \in [-r, r], \quad (2.2.2b)$$

$$\xi_r(0) = u(0) - x_r^0 \quad (2.2.2c)$$

admits a unique solution $\xi_r \in W^{1,1}(0, T)$ for any given input function $u \in W^{1,1}(0, T)$ and any given initial condition $x_r^0 \in [-r, r]$. Then the play operator \mathcal{P}_r can be introduced in the following way.

Definition 2.2.2. *The play operator $\mathcal{P}_r : [-r, r] \times W^{1,1}(0, T) \rightarrow W^{1,1}(0, T)$ is defined as solution operator of Problem (2.2.2) by the formula*

$$\mathcal{P}_r[x_r^0, u] := \xi_r. \quad (2.2.3)$$

It turns out that Theorem 2.2.1 is still valid also in this case.

The set $Z := [-r, r]$ is called **CHARACTERISTIC** of the operator \mathcal{P}_r . In the scalar case it is a symmetric one-dimensional set, but there are also other possibilities in which one considers tensorial extensions of the play operator, or situations in which one deals with more general closed convex sets as characteristics. We refer to for instance to [40] for more details on this topic.

Finally, we see (cf. [40, Section II.1, Remark 1.3]) that it is particularly easy to solve Problem (2.2.2) if the input is monotone in an interval $[t_1, t_2] \subset [0, T]$. What we get is nothing but formula (2.2.1), which provides therefore an equivalent definition for the operator \mathcal{P}_r .

We observe that for any given input function $u \in W^{1,1}(0, T)$ and any given initial condition $x_r^0 \in [-r, r]$ we have

$$\mathcal{P}_r[x_r^0, u](0) := u(0) - x_r^0$$

and notice that we can associate to any $r \in \mathbb{R}$ the corresponding value x_r^0 . This suggests the idea of making the initial configuration of the play system independent of the initial conditions $\{x_r^0\}_{r \in \mathbb{R}}$ for the output function by the introduction of some suitable function of r . More precisely, following [40, Section II.2] we introduce the so called CONFIGURATION SPACE and MEMORY CONFIGURATIONS.

Definition 2.2.3 (Configuration Space). *The space*

$$\Lambda := \left\{ \lambda \in W^{1,\infty}(0, \infty) : \left| \frac{d\lambda(r)}{dr} \right| \leq 1 \text{ a.e. in } [-r, r] \right\}$$

is called configuration space and the functions λ are called memory configurations.

We also introduce some useful subspaces of Λ , i.e.

$$\Lambda_R := \{ \lambda \in \Lambda : \lambda(r) = 0 \text{ for } r \geq R \} \quad \text{and} \quad \Lambda_0 := \bigcup_{R>0} \Lambda_R. \quad (2.2.4)$$

If $Q_r : \mathbb{R} \rightarrow [-r, r]$ is the projection

$$Q_r(x) := \text{sign}(x) \min \{r, |x|\} = \min \{r, \max \{-r, x\}\}, \quad (2.2.5)$$

then we set

$$x_r^0 := Q_r(u(0) - \lambda(r)). \quad (2.2.6)$$

This implies that the initial configuration of the play system only depends on λ and $u(0)$. We introduce the following more convenient definition of the play operator

Definition 2.2.4. *Let $r > 0$. The play operator $\wp_r : \Lambda \times W^{1,1}(0, T) \rightarrow W^{1,1}(0, T)$ is defined by*

$$\wp_r[\lambda, u] := \mathcal{P}_r[x_r^0, u] \quad (2.2.7)$$

where $\mathcal{P}_r[x_r^0, u]$ is as in Definition 2.2.2 and x_r^0 is defined by (2.2.6).

We then set for the sake of completeness $\wp_0[\lambda, u] = u$. It turns out, that the operator $\wp_r : \Lambda \times C^0([0, T]) \rightarrow C^0([0, T])$ is Lipschitz continuous in the following sense (cf. [40, Section II.2, Lemma 2.3]).

Proposition 2.2.5. *For every $u, v \in C^0([0, T])$, every $\lambda, \mu \in \Lambda$ and $r > 0$ we have*

$$\|\wp_r[\lambda, u] - \wp_r[\mu, v]\|_{C^0([0, T])} \leq \max \left\{ |\lambda(r) - \mu(r)|, \|u - v\|_{C^0([0, T])} \right\}.$$

Moreover, the play operator is locally monotone in the following sense (see [40, I. Proposition 3.9]).

Proposition 2.2.6. *For every $u \in W^{1,1}(0, T)$, every $\lambda \in \Lambda$, and $r > 0$ we have*

$$0 \leq \left(\frac{d}{dt} \wp_r[\lambda, u](t) \right)^2 \leq \frac{d}{dt} \wp_r[\lambda, u](t) \frac{d}{dt} u(t) \leq \left(\frac{d}{dt} u(t) \right)^2 \quad \text{for a.a. } t \in (0, T).$$

Let us now quote another interesting property of the play operator (see [40, II. Corollary 2.6]).

Proposition 2.2.7. *Let $R > 0$, $\lambda \in \Lambda_R$, and $u \in C([0, T])$ satisfying $\|u\|_{C([0, T])} \leq R$. Then for every $r > R$ we have*

$$\wp_r[\lambda, u] = 0 \quad \forall t \in [0, T].$$

Following [41, Section 2], we now extend Definition 2.2.4 to the space $G_+(0, T)$ of right-continuous regulated functions.

Definition 2.2.8. *For any $r > 0$ and $\lambda \in \Lambda$, the play operator $\wp_r : \Lambda \times G_+(0, T) \rightarrow G_+(0, T)$ is defined as $\wp_r[\lambda, u] = \xi_r$, where $\xi_r \in G_+(0, T)$ is the solution of the following system*

$$|u(t) - \xi_r(t)| \leq r \quad \forall t \in [0, T], \quad (2.2.8a)$$

$$\int_0^T \dot{\xi}_r(t)(u(t) - \xi_r(t) - z) d\xi(t) \geq 0 \quad \forall z \in [-r, r], \forall t \in [0, T] \quad (2.2.8b)$$

$$u(0) - \xi_r(0) = Q_r(u(0) - \lambda(r)), \quad (2.2.8c)$$

and where the integral is understood in the sense of Kurzweil (see Definition A.3.1).

By [41, Theorem 2.1 and Proposition 2.4] this extension is Lipschitz continuous in the following sense.

Proposition 2.2.9. *For every $u, v \in G_+(0, T)$, every $\lambda, \mu \in \Lambda$ and $r > 0$ we have*

$$|\wp_r[\lambda, u](t) - \wp_r[\mu, v](t)| \leq \max \left\{ |\lambda(r) - \mu(r)|, \|u - v\|_{[0, t]} \right\} \quad (2.2.9)$$

for every $t \in [0, T]$, where for a function $u : G_+(0, T)$ and $t \in [0, T]$

$$\|u\|_{[0, t]} := \sup_{\tau \in [0, t]} |u(\tau)|.$$

Moreover, as an analogue of Proposition 2.2.7 we have the following result.

Proposition 2.2.10. *Let $R > 0$, $\lambda \in \Lambda_R$, and $u \in G_+(0, T)$ satisfying $\|u\|_{[0, T]} \leq R$. Then for every $r > R$ we have*

$$\wp_r[\lambda, u] = 0 \quad \forall t \in [0, T].$$

2.3 The Preisach Operator

In 1935 Preisach (see [59]) proposed a model of ferromagnetism based on an idea of Weiss and de Freudenreich [70]. This construction gained much success and is now known as the PREISACH MODEL OF FERROMAGNETISM. Mathematical aspects of this model were dealt with by Krasnosel'skii and Pokrovskii [36, 37, 38]. The model has been also studied in connection with partial differential equations by Visintin for example in [67]. We also quote the contributions of Brokate and Sprekels [11, 12] and Krejčí [39, 40] and refer to the monograph of Mayergoyz [46] for the discussion of many generalizations of the Preisach model. We present the construction and the main properties of the Preisach operator following [40] and [67].

First, we introduce the so called DELAYED RELAY OPERATOR. It is the simplest example of a discontinuous hysteresis nonlinearity. It is characterized by two thresholds, ρ_1, ρ_2 , and two output values, which we assume to be equal to -1 and $+1$.

Definition 2.3.1 (Delayed Relay Operator). *For a given couple $(\rho_1, \rho_2) \in \mathbb{R}^2$ with $\rho_1 < \rho_2$, $u \in C^0([0, T])$, and any $\eta^0 \in \{-1, 1\}$ the delayed relay operator*

$$\mathcal{R}_{\rho_1, \rho_2} : C^0([0, T]) \times \{-1, 1\} \rightarrow BV(0, T) \cap C_r^0([0, T]), \quad (2.3.1)$$

is defined by $\mathcal{R}_{\rho_1, \rho_2}[u, \eta^0] = w$, where the function w is given by

$$w(0) := \begin{cases} -1 & \text{if } u(0) \leq \rho_1, \\ \eta^0 & \text{if } \rho_1 < u(0) < \rho_2, \\ 1 & \text{if } u(0) \geq \rho_2 \end{cases}$$

and for any $t \in (0, T]$, setting $W_t := \{\tau \in (0, t] : u(\tau) = \rho_1 \text{ or } \rho_2\}$ by

$$w(t) := \begin{cases} w(0) & \text{if } W_t = \emptyset, \\ -1 & \text{if } W_t \neq \emptyset \text{ and } u(\max W_t) = \rho_1, \\ 1 & \text{if } W_t \neq \emptyset \text{ and } u(\max W_t) = \rho_2, \end{cases}$$

where $BV(0, T)$ denotes the space of functions of bounded variation and $C_r^0([0, T])$ is the linear space of functions which are continuous on the right in $[0, T]$.

It turns out, that the operator $\mathcal{R}_{\rho_1, \rho_2}$ is causal and rate independent in the sense of (2.1.3) and (2.1.4).

Let us now present an interesting connection between the relay and the system of play operators $\{\wp_r[\lambda, u]\}_{r \geq 0}$ introduced in (2.2.7).

First of all, we give the following definition, which will be useful in the following.

Definition 2.3.2 (Preisach Plane). *The PREISACH PLANE*

$$\mathcal{P} := \{\rho = (\rho_1, \rho_2) \in \mathbb{R}^2 : \rho_1 < \rho_2\} \quad (2.3.2)$$

is the set of thresholds of the delayed relay operators $\mathcal{R}_{\rho_1, \rho_2}$.

In the following we will often use a different system of coordinates in order to describe \mathcal{P} .

For example we can consider the *half-width* $\sigma_1 = \frac{\rho_2 - \rho_1}{2}$ and the *mean value* $\sigma_2 = \frac{\rho_2 + \rho_1}{2}$ of (ρ_1, ρ_2) .

In this case the conditions on σ_1 and σ_2 in order to have admissible thresholds is $\sigma_1 > 0$ and so the Preisach plane can be written as

$$\mathcal{P} = \{(\sigma_1, \sigma_2) \in \mathbb{R}^2 : \sigma_1 > 0\}. \quad (2.3.3)$$

We will also set in the following $\sigma_1 := r$ and $\sigma_2 := v$ in order to establish a connection with the notations in the previous section. In this way we obtain

$$\mathcal{P} = \{(r, v) \in \mathbb{R}^2 : r > 0\}. \quad (2.3.4)$$

In this setting we recall a result, whose proof can be found in [40, Section II.3].

Lemma 2.3.3. *Let $\lambda \in \Lambda_0$ and $u \in C^0([0, T])$ be given. For any given $(r, v) \in \mathcal{P}$ we set*

$$\xi_\lambda(r, v) := \begin{cases} -1 & \text{if } v \geq \lambda(r), \\ +1 & \text{if } v < \lambda(r). \end{cases}$$

Then for every $t \in [0, T]$ and $(r, v) \in \mathcal{P}$ with $v \neq \wp_r[\lambda, u](t)$ we have

$$\mathcal{R}_{(r, v)}[u, \xi_\lambda(r, v)](t) = \begin{cases} +1 & \text{if } v < \wp_r[\lambda, u](t), \\ -1 & \text{if } v > \wp_r[\lambda, u](t). \end{cases}$$

Now, we introduce the PREISACH OPERATOR as follows.

Definition 2.3.4 (Preisach Operator). *Let \mathcal{P} be the Preisach plane introduced in one of the equivalent ways (2.3.2), (2.3.3) or (2.3.4), \mathcal{B} be the family of Borel measurable functions $\mathcal{P} \rightarrow \{-1, 1\}$, ξ_{ρ_1, ρ_2} be the image of $(\rho_1, \rho_2) \in \mathcal{P}$ by the function $\xi \in \mathcal{B}$, and μ be any (signed) Borel measure over \mathcal{P} .*

Then the Preisach Operator $\mathcal{W}_\mu : C^0([0, T]) \times \mathcal{B} \rightarrow L^\infty(0, t) \cap C_r^0([0, T])$ is defined for all $t \in [0, T]$ as follows

$$\mathcal{W}_\mu[u, \xi](t) := \int_{\mathcal{P}} \mathcal{R}_{\rho_1, \rho_2}[u, \xi_{\rho_1, \rho_2}](t) d\mu(\rho_1, \rho_2). \quad (2.3.5)$$

The Preisach model can be interpreted as the superposition of a family of delayed relays distributed with a certain density.

For the Preisach operator the following result holds (see [67, Section IV.1, Theorem 1.2 and Corollary 1.3]).

Proposition 2.3.5. *For any finite Borel measure μ over \mathcal{P} it turns out that the operator \mathcal{W}_μ is causal and rate independent, so it is a hysteresis operator.*

Suppose now that in (2.3.5) the measure μ is absolutely continuous with respect to the two-dimensional Lebesgue measure. This means, that there exists $\psi \in L^1_{loc}(\mathcal{P})$ such that

$$\mathcal{W}_\mu[u, \xi](t) := \int_0^\infty \int_{-\infty}^\infty \mathcal{R}_{(r,v)}[u, \xi_{(r,v)}] \psi(r, v) dv dr. \quad (2.3.6)$$

Let us pose the following technical assumption.

Assumption 2.3.6 (Assumption on the density function ψ).

- ① *The antisymmetric part ψ_a of the density function ψ stays in $L^1(\mathcal{P})$, i.e.*

$$\psi_a(r, v) := \frac{1}{2} (\psi(r, v) - \psi(r, -v)) \in L^1(\mathcal{P});$$

- ② *the integral in (2.3.6) is considered in the sense of principal value;*

- ③ *there exist $\beta_0, \beta \in L^1_{loc}(0, \infty)$, $\beta(r) \geq 0$ a.e., and*

$$\tilde{b} := \int_0^\infty \beta(r) dr < \infty, \quad (2.3.7)$$

such that

$$\beta_0(r) \leq \psi(r, v) \leq \beta(r) \quad \text{for a.e. } (r, v) \in \mathcal{P}.$$

We also put $\tilde{b}(R) := \int_0^R \beta(r) dr$ for $R > 0$.

As in [40, Section II.3], we propose the following definition of the Preisach operator which is equivalent to Definition 2.3.5 in the particular case when Assumption 2.3.6 holds (see [40, Section II.3, Definition 3.8]).

Definition 2.3.7. *Let $\psi \in L^1_{loc}(\mathcal{P})$ satisfy Assumption 2.3.6. Then the Preisach operator $\mathcal{W} : \Lambda_0 \times C^0([0, T]) \rightarrow C^0([0, T])$ generated by the function g ,*

$$g(r, v) := \int_0^v \psi(r, z) dz \quad \text{for } (r, v) \in \mathcal{P}, \quad (2.3.8)$$

is defined by the formula

$$\mathcal{W}[\lambda, u](t) := \int_0^\infty g(r, \wp_r[\lambda, u](t)) dr \quad (2.3.9)$$

for any given $\lambda \in \Lambda_0$, $u \in C^0([0, T])$ and $t \in [0, T]$.

Let us show how the Definition 2.3.7 can be extended to $G_+(0, T)$.

Definition 2.3.8. Let $\psi \in L^1_{loc}(\mathcal{P})$ satisfying Assumption 2.3.6 be given and let g be as in (2.3.8). Then the Preisach operator $\mathcal{W} : \Lambda_0 \times G_+(0, T) \mapsto G_+(0, T)$ generated by the function g is defined by the formula

$$\mathcal{W}[\lambda, u](t) := \int_0^\infty g(r, \wp_r[\lambda, u](t)) dr = \int_0^\infty \int_0^{\wp_r[\lambda, u](t)} \psi(r, z) dz dr$$

for any given $\lambda \in \Lambda_0$, $u \in G_+(0, t)$ and $t \in [0, T]$, where Λ_0 is introduced in (2.2.4), and $\wp_r[\lambda, u]$ is defined according to Definition 2.2.8.

As a counterpart of [40, Section II.3, Proposition 3.11] we quote the following result (see e.g. [18, Proposition 2.3].)

Proposition 2.3.9. Let Assumption 2.3.6 be satisfied and let $R > 0$ be given. Then for every $\lambda_1, \lambda_2 \in \Lambda_R$ and $u, v \in G_+(0, T)$ such that $\|u\|_{[0, T]}, \|v\|_{[0, T]} \leq R$, we have for all $t \in [0, T]$

$$|\mathcal{W}[\lambda_1, u](t) - \mathcal{W}[\lambda_2, v](t)| \leq \int_0^R |\lambda_1(r) - \lambda_2(r)| \beta(r) dr + \tilde{b}(R) \|u - v\|_{[0, t]}.$$

In the sequel we restrict the class of Preisach operators by requiring more regularity. In addition to Assumption 2.3.6, we assume

Assumption 2.3.10.

(i) $\frac{\partial \psi}{\partial v} \in L^\infty_{loc}(\mathcal{P})$,

(ii) $\psi(r, v) \geq 0$, a.e.

Then, we recover the following result (see [40, Proposition II.4.8]).

Proposition 2.3.11. Let Assumptions 2.3.6, and 2.3.10 (i) be satisfied and $R > 0$ be given. Suppose moreover that $a_0 \geq 0$, $\lambda \in \Lambda_R$, and $u \in W^{1,1}(0, T)$ be given such that $\|u\|_{C([0, T])} \leq R$. Put $w = a_0 u + \mathcal{W}[\lambda, u]$. Then for a.e. $t \in (0, T)$ we have

$$a_0 \dot{u}^2(t) \leq \dot{w}(t) \dot{u}(t) \leq (a_0 + \tilde{b}(R)) \dot{u}^2(t). \quad (2.3.10)$$

Before going on, we introduce the PREISACH POTENTIAL ENERGY \mathcal{U} as

$$\mathcal{U}[\lambda, u](t) := \int_0^\infty G(r, \wp_r[\lambda, u](t)) dr, \quad (2.3.11)$$

where

$$G(r, v) := v g(r, v) - \int_0^v g(r, z) dz = \int_0^v z \psi(r, z) dz, \quad (2.3.12)$$

with $\psi(r, z) = \partial_z g(r, z)$.

We moreover introduce the PREISACH DISSIPATION OPERATOR as

$$\mathcal{D}[\lambda, u](t) := \int_0^\infty r g(r, \wp_r[\lambda, u](t)) dr. \quad (2.3.13)$$

The following result can be found in [40, Section II.4, Theorem 4.3].

Proposition 2.3.12. *Let Assumptions 2.3.6 and 2.3.10 be satisfied and let $R > 0$ be given. For arbitrary $\lambda \in \Lambda_R$ and $u \in W^{1,1}(0, T)$ such that $\|u\|_{C^0([0, T])} \leq R$ we put*

$$w := \mathcal{W}[\lambda, u] \quad U := \mathcal{U}[\lambda, u] \quad D := \mathcal{D}[\lambda, u],$$

where \mathcal{U} and \mathcal{D} are the Preisach potential energy and the Preisach dissipation operator introduced in (2.3.11), and (2.3.13). Then we have

$$(i) \quad U(t) \geq \frac{1}{2\bar{b}(R)} w^2(t) \quad \forall t \in [0, T]$$

$$(ii) \quad \dot{w}(t)u(t) - \dot{U}(t) = \left| \dot{D}(t) \right| \quad a.e.$$

Finally, let us prove a generalization of [40, Proposition II.4.13].

Proposition 2.3.13. *(Hilpert-Type Inequality) Suppose that $\psi \in L^1_{loc}(\mathcal{P})$ satisfies Assumptions 2.3.6 and 2.3.10. Let \mathcal{W} be the Preisach operator as in Definition 2.3.7. For given $u_1, u_2 \in W^{1,1}(0, T)$, $\lambda_1, \lambda_2 \in \Lambda_0$, and $i = 1, 2$, put $\xi_r^i(t) := \wp_r[\lambda_i, u_i]$, $w_i = \mathcal{W}[\lambda_i, u_i]$ defined according to Definitions 2.2.4, and 2.3.7. Then for a.e. $t \in (0, T)$, and any $q \geq 0$ we have*

$$\begin{aligned} & (\dot{w}_1(t) - \dot{w}_2(t))(u_1(t) - u_2(t)) |u_1(t) - u_2(t)|^q \\ & \geq \int_0^\infty \frac{\partial}{\partial t} (g(r, \xi_r^1(t)) - g(r, \xi_r^2(t))) (\xi_r^1(t) - \xi_r^2(t)) |\xi_r^1(t) - \xi_r^2(t)|^q dr. \end{aligned} \quad (2.3.14)$$

Proof: As a consequence of (2.2.2) and (2.2.3) it follows that

$$\begin{aligned} \dot{\xi}_r^1(u_1 - \xi_r^1 - z_1) & \geq 0, \\ \dot{\xi}_r^2(u_2 - \xi_r^2 - z_2) & \geq 0 \end{aligned} \quad \text{hold for any } z_1, z_2 \in [-r, r], \text{ a.e. in } (0, T).$$

As by virtue of Assumption 2.3.10, the function $\psi(r, z) = \partial_z g(r, z)$ is non negative, the previous inequalities imply that

$$\begin{aligned} \frac{\partial}{\partial t} g(r, \xi_r^1)(u_1 - \xi_r^1 - z_1) & \geq 0, \\ \frac{\partial}{\partial t} g(r, \xi_r^2)(u_2 - \xi_r^2 - z_2) & \geq 0 \end{aligned} \quad \text{hold for any } z_1, z_2 \in [-r, r], \text{ a.e. in } (0, T).$$

Choosing in the previous inequalities $z_1 = u_2 - \xi_r^2$ and $z_2 = u_1 - \xi_r^1$ and summing the resulting inequalities, we obtain

$$\frac{\partial}{\partial t} [g(r, \xi_r^1) - g(r, \xi_r^2)] [(u_1 - u_2) - (\xi_r^1 - \xi_r^2)] \geq 0.$$

Moreover, we certainly notice that the previous inequality is equivalent to

$$\frac{\partial}{\partial t} [g(r, \xi_r^1) - g(r, \xi_r^2)] [f(u_1 - u_2) - f(\xi_r^1 - \xi_r^2)] \geq 0.$$

for any non-decreasing function f . With the choice $f(z) = z|z|^q$, $q \geq 0$ the claim follows. \square

2.4 Space Dependent Hysteresis Operators

The hysteresis operators introduced so far act on functions depending only on the time variable t . These operators are usually employed in problems, in which time is the only independent variable, like in the case of ODEs. When also the space variable appears, for example as in the case of PDEs (and so like the situation we deal through this thesis), then relationships of the form (2.1.1) or (2.1.2) cannot be directly applied, and it is necessary to extend the concept of hysteresis in a suitable way. We will address this in the following.

Definition 2.4.1 (Space Dependent Hysteresis Operator). *Let $\Omega \subset \mathbb{R}^n$ with $n \in \mathbb{N}$, X a suitable metric space, and $\mathcal{H} : X \times \mathcal{F}(0, T) \rightarrow \mathcal{F}(0, T)$ a hysteresis operator. For a function $u : \Omega \rightarrow \mathcal{F}(0, T)$, and an initial condition $\eta^0 : \Omega \rightarrow X$, we define the output of the space dependent hysteresis operator (corresponding to \mathcal{H} as follows)*

$$\mathfrak{H}[\eta^0, u](x, t) := \mathcal{H}[\eta^0(x), u(x, \cdot)](t) \quad \text{a.e. in } \Omega, \forall t \in [0, T]. \quad (2.4.1)$$

This definition implies that \mathcal{H} is applied at every point $x \in \Omega$ independently, in other words $\mathfrak{H}[\eta^0, u](x, t)$ depends only on $u(x, \cdot)|_{[0, t]}$ and is independent of $u(y, \cdot)|_{[0, t]}$, for $y \neq x$.

For these operators we have the following result (see [62, Korollar 2.7.5]).

Proposition 2.4.2. *Let $V \subset F(0, T)$ be a Banachspace, $\Omega \subset \mathbb{R}^n$ open, bounded, $p \in [1, \infty)$, X a suitable metric space, $\mathcal{H} : X \times V \rightarrow V$ a Lipschitz - continuous hysteresis operator, and \mathfrak{H} the corresponding space dependent hysteresis operator. For a fixed $\eta : \Omega \rightarrow X$ the operator \mathfrak{H}_η defined by*

$$\mathfrak{H}_\eta : L^p(0, T; V) \rightarrow L^p(0, T; V), \quad \mathfrak{H}_\eta[u] = \mathfrak{H}[\eta, u],$$

is continuous.

Let us now introduce the space dependent Preisach operator.

Definition 2.4.3 (Space Dependent Preisach Operator). *Let $\Omega \subset \mathbb{R}^n$ be an open and bounded domain, $\psi \in L^1_{loc}(\mathcal{P})$ satisfy Assumption 2.3.6, $\lambda(x, \cdot)$ belong to Λ_0 , and $u(x, \cdot)$ belongs to $G_+(0, T)$ for (almost) every $x \in \Omega$. Then we define*

$$\mathfrak{W}[\lambda, u](x, t) := \int_0^\infty g(r, \wp_r[\lambda(x, r), u(x, \cdot)](t)) dr := \int_0^\infty \int_0^{\wp_r[\lambda(x, r), u(x, \cdot)](t)} \psi(r, z) dz dr, \quad (2.4.2)$$

where \wp_r is as in Definition 2.2.8.

For the space dependent Preisach operator we have the following result.

Proposition 2.4.4. *Let $\Omega \subset \mathbb{R}^n$, $T > 0$, $R > 0$, $\psi \in L^1_{loc}(\mathcal{P})$ satisfy Assumptions 2.3.6 and 2.3.10, $\lambda : \Omega \rightarrow \Lambda_R$, $u \in L^2(\Omega; G_+(0, T))$ such that $\sup_{t \in [0, T]} \|u(\cdot, t)\|_{L^\infty(\Omega)} \leq R$, and \mathfrak{W} be the space dependent*

Preisach operator (by means of Definition 2.4.3) corresponding to the input u and the initial configuration λ . Then

$$|\mathfrak{W}[\lambda, u](x, t)| \leq R\tilde{b} + 3\tilde{b} \|u(x, \cdot)\|_{[0, t]} \quad (2.4.3)$$

holds for a.a. $(x, t) \in \Omega \times [0, T]$ with \tilde{b} as in Assumption 2.3.6.

Proof: Let λ and u be as above. We define the input $v \in L^2(\Omega; G_+(0, T))$ by $v(\cdot, t) = u(\cdot, 0)$ for a.a. $t \in [0, T]$, a.e. in Ω . Let $x \in \Omega$ and $t \in [0, T]$. Then, making use of formula (2.4.2), Assumptions 2.3.6 and 2.3.10, and Taylor's Theorem we obtain

$$\begin{aligned} & |\mathfrak{W}[\lambda, u](x, t) - \mathfrak{W}[\lambda, v](x, t)| \\ & \leq \int_0^\infty |g(r, \wp_r[\lambda(x, r), u(x, \cdot)])(t) - g(r, \wp_r[\lambda(x, r), u(x, \cdot)])(t)| dr \\ & \leq \int_0^\infty \beta(r) |\wp_r[\lambda(x, r), u(x, \cdot)](t) - \wp_r[\lambda(x, r), v(x, \cdot)](t)| dr. \end{aligned}$$

Moreover, by virtue of Proposition 2.2.9

$$\wp_r[\lambda(x, r), u(x, \cdot)](t) - \wp_r[\lambda(x, r), v(x, \cdot)](t) \leq \|u(x, \cdot) - v(x, \cdot)\|_{[0, t]} \leq \|u(x, \cdot)\|_{[0, t]} + |u(x, 0)|$$

holds for a.a. $x \in \Omega$. Bearing in mind that Assumption 2.3.6 yields

$$\tilde{b} = \int_0^\infty \beta(r) dr < \infty,$$

we find

$$\begin{aligned} |\mathfrak{W}[\lambda, u](x, t)| & \leq |\mathfrak{W}[\lambda, u](x, t) - \mathfrak{W}[\lambda, v](x, t)| + |\mathfrak{W}[\lambda, v](x, t)| \\ & \leq |\mathfrak{W}[\lambda, u](x, 0)| + \tilde{b} |u(x, 0)| + \tilde{b} \|u(x, \cdot)\|_{[0, t]}. \end{aligned} \quad (2.4.4)$$

Moreover, since $\lambda : \Omega \rightarrow \Lambda_R$ and $\|u(\cdot, 0)\|_{L^\infty(\Omega)} \leq R$, we clearly have by virtue of (2.4.2), Proposition 2.2.10, and the pointwise inequality

$$u(x, 0) - r \leq \wp_r[\lambda(x, r), u(x, 0)] \leq u(x, 0) + r \quad \text{for a.a. } x \in \Omega$$

the following estimate

$$|\mathfrak{W}[\lambda, u](x, 0)| \leq \int_0^R |\wp_r[\lambda(x, r), u(x, 0)]| \beta(r) dr \leq (R + |u(x, 0)|)\tilde{b}(R), \quad (2.4.5)$$

where $\tilde{b}(R)$ is as in Assumption 2.3.6. Thus, assembling (2.4.4) and (2.4.5) the claim follows. \square

The following result allows us to estimate the gradient of the space dependent Preisach operator (see for instance [18, inequality (2.23)]).

Proposition 2.4.5. Let $\psi \in L^1_{loc}(\mathcal{P})$ satisfy Assumptions 2.3.6 and 2.3.10, $R > 0$, and $u \in L^2(\Omega; G_+(0, T)) \cap L^\infty(\Omega \times (0, T))$. Suppose that $\|u\|_{L^\infty(\Omega \times (0, T))} \leq R$, $\nabla u \in L^2(\Omega; G_+(0, T))$, $\beta \in L^1_{loc}(0, \infty)$, and $\lambda : \Omega \rightarrow \Lambda_R$ such that

$$\int_0^R \int_\Omega \beta(r) |\nabla \lambda(x, r)| \, dx \, dr < \infty$$

holds, where ∇ denotes the gradient with respect to the spatial viable $x \in \Omega$. Then the function $w := \mathfrak{W}[\lambda, u]$ satisfies

$$|\nabla w(x, t)| \leq \int_0^R \beta(r) |\nabla \lambda(x, r)| \, dr + \tilde{b}(R) \sup_{\tau \in [0, t]} |\nabla u(x, \tau)| \quad (2.4.6)$$

all $t \in [0, T]$ a.e. in Ω , where $\tilde{b}(R)$ is as in Assumption 2.3.6.

Let us now prove a consequence of this result.

Proposition 2.4.6. Let $\psi \in L^1_{loc}(\mathcal{P})$ satisfy Assumptions 2.3.6 and 2.3.10, $R > 0$, $q \geq 0$, and $u \in L^2(\Omega; G_+(0, T)) \cap L^\infty(\Omega \times (0, T))$.

Moreover, suppose that $\|u\|_{L^\infty(\Omega \times (0, T))} \leq R$, $\nabla u \in L^{2q}(\Omega; G_+(0, T))$, $\nabla \dot{u} \in L^2(\Omega \times (0, T))$, $\nabla u(\cdot, 0) \in L^{q+1}(\Omega)$, $\beta \in L^{\frac{q+1}{q}}_{loc}(0, \infty)$, and that $\lambda : \Omega \rightarrow \Lambda_R$, $\nabla \lambda \in L^{q+1}(\Omega \times (0, R))$. Then the function $w := \mathfrak{W}[\lambda, u]$ satisfies

$$\sup_{0 \leq t \leq T} \|\nabla w(\cdot, t)\|_{L^{q+1}(\Omega)} \leq \hat{c}(q+1)^{\frac{1}{q+1}} \left[1 + \|\nabla u\|_{L^{2q}(\Omega \times (0, T))}^{\frac{q}{q+1}} \|\nabla \dot{u}\|_{L^2(\Omega \times (0, T))}^{\frac{1}{q+1}} \right], \quad (2.4.7)$$

where \hat{c} is defined by

$$\hat{c} := 2 \max \left\{ \|\beta\|_{L^{\frac{q+1}{q}}(0, R)} \|\nabla \lambda\|_{L^{q+1}(\Omega \times (0, R))}; \tilde{b}(R) \right\}^{\frac{1}{q+1}} \left(1 + \|\nabla u(\cdot, 0)\|_{L^{q+1}(\Omega)} \right),$$

with $\tilde{b}(R)$ as in Assumption 2.3.6.

Proof: The conditions of the Proposition imply that we can apply Proposition 2.4.5 and obtain

$$|\nabla w(x, t)| \leq \int_0^R \beta(r) |\nabla \lambda(x, r)| \, dr + \tilde{b}(R) \sup_{\tau \in [0, t]} |\nabla u(x, \tau)|$$

for all $t \in [0, T]$ a.e. in Ω . Let $q \geq 0$. Multiplying the preceding inequality by $|\nabla w(x, t)|^q$ and integrating the result over Ω , we find

$$\begin{aligned} & \int_\Omega |\nabla w(x, t)|^{q+1} \, dx \\ & \leq \int_\Omega \int_0^R \beta(r) |\nabla \lambda(x, r)| |\nabla w(x, t)|^q \, dr \, dx + \tilde{b}(R) \int_\Omega \sup_{\tau \in [0, t]} |\nabla u(x, \tau)| |\nabla w(x, t)|^q \, dx. \end{aligned}$$

By virtue of Fubini's Theorem, Hölder's and Young's inequalities the following estimate holds

$$\int_\Omega \int_0^R \beta(r) |\nabla \lambda(x, r)| |\nabla w(x, t)|^q \, dr \, dx$$

$$\begin{aligned}
&\leq \int_0^R \beta(r) \|\nabla \lambda(\cdot, r)\|_{L^{q+1}(\Omega)} \|\nabla w(x, t)\|_{L^{q+1}(\Omega)}^q dr \\
&\leq \|\beta\|_{L^{\frac{q+1}{q}}(0, R)} \|\nabla \lambda\|_{L^{q+1}(\Omega \times (0, R))} \|\nabla w(x, t)\|_{L^{q+1}(\Omega)}^q \\
&\leq \frac{2^q}{q+1} \|\beta\|_{L^{\frac{q+1}{q}}(0, R)}^{q+1} \|\nabla \lambda\|_{L^{q+1}(\Omega \times (0, R))}^{q+1} + \frac{q}{q+1} \frac{1}{2} \|\nabla w(x, t)\|_{L^{q+1}(\Omega)}^{q+1},
\end{aligned}$$

and similarly it follows

$$\begin{aligned}
&\tilde{b}(R) \int_{\Omega} \sup_{\tau \in [0, t]} |\nabla u(x, \tau)| |\nabla w(x, t)|^q dx \\
&\leq \frac{2^q \tilde{b}(R)^{q+1}}{q+1} \int_{\Omega} \sup_{\tau \in [0, t]} |\nabla u(x, \tau)|^{q+1} dx + \frac{q}{q+1} \frac{1}{2} \|\nabla w(x, t)\|_{L^{q+1}(\Omega)}^{q+1}.
\end{aligned}$$

Assembling the preceding estimates we conclude

$$\|\nabla w(x, t)\|_{L^{q+1}(\Omega)}^{q+1} \leq 2^q \left[\|\beta\|_{L^{\frac{q+1}{q}}(0, R)}^{q+1} \|\nabla \lambda\|_{L^{q+1}(\Omega \times (0, R))}^{q+1} + \tilde{b}(R)^{q+1} \int_{\Omega} \sup_{\tau \in [0, t]} |\nabla u(x, \tau)|^{q+1} dx \right]$$

and setting

$$\hat{c}_0 := 2 \max \left\{ \|\beta\|_{L^{\frac{q+1}{q}}(0, R)}^{q+1} \|\nabla \lambda\|_{L^{q+1}(\Omega \times (0, R))}^{q+1}; \tilde{b}(R)^{q+1} \right\},$$

the previous inequality transforms into

$$\|\nabla w(x, t)\|_{L^{q+1}(\Omega)}^{q+1} \leq \hat{c}_0^{q+1} \left[1 + \int_{\Omega} \sup_{\tau \in [0, t]} |\nabla u(x, \tau)|^{q+1} dx \right].$$

Finally, with the help of Hölder's inequality and Fubini's Theorem we obtain

$$\begin{aligned}
&\int_{\Omega} \sup_{\tau \in [0, t]} |\nabla u(x, \tau)|^{q+1} dx \\
&\leq \|\nabla u(\cdot, 0)\|_{L^{q+1}(\Omega)}^{q+1} + \int_0^t \int_{\Omega} \frac{\partial}{\partial \tau} |\nabla u|^{q+1} dx d\tau \\
&\leq \|\nabla u(\cdot, 0)\|_{L^{q+1}(\Omega)}^{q+1} + (q+1) \int_0^t \int_{\Omega} |\nabla u|^q |\nabla \dot{u}| dx d\tau \\
&\leq \|\nabla u(\cdot, 0)\|_{L^{q+1}(\Omega)}^{q+1} + (q+1) \|\nabla u\|_{L^{2q}(\Omega \times (0, T))}^q \|\nabla \dot{u}\|_{L^2(\Omega \times (0, T))} \quad (2.4.8)
\end{aligned}$$

and hence the claim follows. \square

2.5 Time Discrete Hysteresis Operators

Let us now present a way how the concept of space dependent Preisach operators from Definition 2.4.3 can be transferred to the time discrete setting. For this aim, we make use of the Preisach operator defined on the space $G_+(0, T)$ (see Definition 2.3.8), and extend this concept to the case of space dependent hysteresis operators acting on $L^2(\Omega; G_+(0, T))$.

Definition 2.5.1 (The Time Discrete Play and Preisach Operators). *Let $T > 0$, $m \in \mathbb{N}$ fixed and define the time step $h := T/m$. For a sequence $\{u_m^n\}_{n \in \{0, \dots, m\}} \subset L^2(\Omega)$ and a number $r > 0$ we define the sequence of the time discrete outputs of the play operator recursively by*

$$\xi_m^0(x, r) := P[\lambda(x, \cdot), u_m^0(x)](r), \quad \text{and} \quad \xi_m^n(x, r) := P[\xi_m^{n-1}(x, \cdot), u_m^n(x)](r) \quad (2.5.1)$$

for $n \in \{1, \dots, m\}$, with the projection operator $P : \Lambda \times \mathbb{R} \rightarrow \Lambda$

$$P[\lambda, v] := \max \{v - r, \min \{v + r, \lambda(r)\}\}. \quad (2.5.2)$$

Setting

$$u_m(x, t) := \sum_{n=1}^m u_m^{n-1}(x) \chi_{[(n-1)h, nh]}(t) + u_m^n(x) \chi_{\{T\}}(t),$$

and

$$\xi_m^r(x, t) := \sum_{n=1}^m \xi_m^{n-1}(x, r) \chi_{[(n-1)h, nh]}(t) + \xi_m^n(x, r) \chi_{\{T\}}(t)$$

we thus have

$$\xi_m^r(x, t) = \wp_r[\lambda, u_m](x, t)$$

in the sense of Definition 2.2.8. We set

$$w_m^n(x) := \int_0^\infty g(r, \xi_m^n(x, r)) dr \quad \text{with} \quad g(r, v) = \int_0^v \psi(r, z) dz \quad (2.5.3)$$

and ψ as in Assumption 2.3.6, to be the output of the time discrete Preisach operator.

Let us now recall some well known results for the time discrete play and Preisach operators. First, we observe, that the discretized play operator defined by (2.5.1) satisfies a discrete counterpart of (2.2.2), in fact we have the following result. (see e.g.[18, Section A.1]).

Proposition 2.5.2. *Let $m \in \mathbb{N}$, $\{u_m^n\}_{n \in \{0, \dots, m\}}$ be a sequence in $L^2(\Omega)$, $r > 0$, $\lambda : \Omega \rightarrow \Lambda$ and let $\{\xi_m^n(\cdot, r)\}_{n \in \{0, \dots, m\}}$ be defined by (2.5.1). Then inequality*

$$(\xi_m^n(x, r) - \xi_m^{n-1}(x, r))(u_m^n(x) - \xi_m^n(x, r) - z) \geq 0 \quad (2.5.4)$$

holds for all $n = 1, \dots, m$ a.e. in Ω .

As a consequence we have the following result.

Proposition 2.5.3. *Let $m \in \mathbb{N}$, let $\{u_m^n\}_{n \in \{0, \dots, m\}} \subset L^2(\Omega)$ be given, and $\{\xi_m^n(\cdot, r)\}_{n \in \{0, \dots, m\}}$ be the output of the discretized play operator, defined according to formula (2.5.1). Then for a.a. $x \in \Omega$, and all $n \in \{1, \dots, m\}$ we have*

$$(\xi_m^n(x, r) - \xi_m^{n-1}(x, r))^2 \leq (\xi_m^n(x, r) - \xi_m^{n-1}(x, r))(u_m^n(x) - u_m^{n-1}(x)) \leq (u_m^n - u_m^{n-1})^2. \quad (2.5.5)$$

Moreover, we have the discrete version of Proposition 2.2.7.

Proposition 2.5.4. Let $m \in \mathbb{N}$, $R > 0$, $\lambda : \Omega \rightarrow \Lambda_R$ and let $\{u_m^n\}_{n \in \{0, \dots, m\}} \subset L^\infty(\Omega)$, satisfying $\max_{n \in \{0, \dots, m\}} \|p_m^n\|_{L^\infty(\Omega)} \leq R$ be given. Moreover, let $\{\xi_m^n(\cdot, r)\}_{n \in \{0, \dots, m\}}$ be the output of the discretized play operator, defined according to formula (2.5.1). Then for a.a. $x \in \Omega$, all $n \in \{1, \dots, m\}$, and every $r > R$

$$\xi_m^n(x, r) = 0$$

holds.

Let us now quote a result (see [18, inequality (A.13)]), which is the discrete analogue of Proposition 2.3.11.

Proposition 2.5.5. Let $m \in \mathbb{N}$, $R > 0$, and $\psi \in L^1_{loc}(\mathcal{P})$ satisfy Assumptions 2.3.6 and 2.3.10. Suppose moreover that $a_0 \geq 0$, $\lambda : \Omega \rightarrow \Lambda_R$ and $\{u_m^n\}_{n \in \{0, \dots, m\}} \subset L^\infty(\Omega)$, such that $\max_{0 \leq n \leq m} \|u_m^n\|_{L^\infty(\Omega)} \leq R$ is satisfied. Put $s_m^n = a_0 u_m^n + w_m^n$, where $\{w_m^n\}_{n \in \{0, \dots, m\}}$ is defined according to formula (2.5.3). Then for all $n \in \{1, \dots, m\}$ we have

$$a_0 (u_m^n - u_m^{n-1})^2 \leq (s_m^n - s_m^{n-1})(u_m^n - u_m^{n-1}) \leq (a_0 + \tilde{b}(R)) (u_m^n - u_m^{n-1})^2. \quad (2.5.6)$$

Finally, let us now recover the discrete analogue of Proposition 2.3.12. For a detailed proof we refer e.g. to [18, Section A.1]

Proposition 2.5.6 (1st order Energy Inequality).

Let $\{u_m^n\}_{n \in \{0, \dots, m\}}$ be a sequence in $L^2(\Omega)$, $\lambda : \Omega \rightarrow \Lambda$ and the sequences $\{\xi_m^n(\cdot, r)\}_{n \in \{0, \dots, m\}}$ as well as $\{w_m^n(\cdot)\}_{n \in \{0, \dots, m\}}$ be defined according to (2.5.1) and 2.5.3. Let $\{\mathcal{U}_m^n\}_{n \in \{0, \dots, m\}}$ be the sequence of time discrete Preisach potential energies defined in the following way

$$\mathcal{U}_m^n(x) := \int_0^\infty G(r, \xi_m^n(x, r)) dr \quad \text{a.e. in } \Omega,$$

where G is given by (2.3.12). Then inequality

$$(w_m^n - w_m^{n-1})u_m^n \geq \mathcal{U}_m^n - \mathcal{U}_m^{n-1} \quad (2.5.7)$$

holds for all $n = 1, \dots, m$ a.e. in Ω .

In the following we will prove some very useful results for discretized play and Preisach operators. These results become important in Chapters 4 and 5, as they allow us to apply the De Giorgi iteration scheme to problems where Preisach hysteresis occurs under the (discrete) time derivative. We start with the following easy consequence of (2.2.2).

Lemma 2.5.7. Let $m \in \mathbb{N}$, $\{u_m^n\}_{n \in \{0, \dots, m\}} \subset L^2(\Omega)$, $\lambda : \Omega \rightarrow \Lambda$, $r > 0$ and let $k \in \mathbb{R}$.

Let the sequences $\{\xi_m^n\}_{n \in \{0, \dots, m\}}$, $\{\eta_m^n\}_{n \in \{0, \dots, m\}}$, $\{\nu_m^n\}_{n \in \{0, \dots, m\}} \subset L^2(\Omega)$ be the outputs to the discretized play operator (by means of Definition 2.5.1) corresponding to the input sequences

$\{u_m^n\}_{n \in \{0, \dots, m\}}$, $\{u_m^n + k\}_{n \in \{0, \dots, m\}}$, $\{-u_m^n\}_{n \in \{0, \dots, m\}}$, and the initial configurations $\lambda(\cdot, r)$, $\lambda(\cdot, r) + k$ and $-\lambda(\cdot, r)$ resp.

Then the following identities

$$\textcircled{1} \quad \eta_m^n(x, r) = \xi_m^n(x, r) + k \quad \text{a.e. in } \Omega \quad (2.5.8)$$

$$\textcircled{2} \quad \nu_m^n(x, r) = -\xi_m^n(x, r) \quad \text{a.e. in } \Omega \quad (2.5.9)$$

hold for all $n \in \{0, \dots, m\}$.

Proof: Let $\lambda : \Omega \rightarrow \Lambda$ and $r > 0$. According to Definition 2.5.1 we have for a.a. $x \in \Omega$

$$\xi_m^0(x, r) = \max \{u_m^0(x) - r, \min \{u_m^0(x) + r, \lambda(x, r)\}\}, \quad (2.5.10a)$$

$$\xi_m^n(x, r) = \max \{u_m^n(x) - r, \min \{u_m^n(x) + r, \xi_m^{n-1}(x, r)\}\}, \quad \forall n \in \{1, \dots, m\}, \quad (2.5.10b)$$

as well as

$$\eta_m^0(x, r) = \max \{u_m^0(x) + k - r, \min \{u_m^0(x) + k + r, \lambda(x, r) + k\}\}, \quad (2.5.11a)$$

$$\eta_m^n(x, r) = \max \{u_m^n(x) + k - r, \min \{u_m^n(x) + k + r, \eta_m^{n-1}(x, r)\}\}, \quad \forall n \in \{1, \dots, m\}, \quad (2.5.11b)$$

and

$$\nu_m^0(x, r) = \max \{-u_m^0(x) - r, \min \{-u_m^0(x) + r, -\lambda(x, r)\}\}, \quad (2.5.12a)$$

$$\nu_m^n(x, r) = \max \{-u_m^n(x) - r, \min \{-u_m^n(x) + r, \nu_m^{n-1}(x, r)\}\}, \quad \forall n \in \{1, \dots, m\}. \quad (2.5.12b)$$

Let $k \in \mathbb{R}$ be arbitrary. As a consequence of (2.5.10a) and of (2.5.11a) the following identity is satisfied for a.a. $x \in \Omega$

$$\begin{aligned} \eta_m^0(x, r) &= \max \{u_m^0(x) + k - r, \min \{u_m^0(x) + k + r, \lambda(x, r) + k\}\} \\ &= \max \{u_m^0(x) - r, \min \{u_m^0(x) + r, \lambda(x, r)\}\} + k \\ &= \xi_m^0(x, 0) + k. \end{aligned}$$

Let $n \geq 1$ and assume that $\eta_m^{n-1}(x, r) = \xi_m^{n-1}(x, r) + k$ holds. Hence, in a similar way, we obtain from (2.5.10b) and from (2.5.11b)

$$\begin{aligned} \eta_m^n(x, r) &= \max \{u_m^n(x) + k - r, \min \{u_m^n(x) + k + r, \xi_m^{n-1}(x, r) + k\}\} \\ &= \max \{u_m^n(x) - r, \min \{u_m^n(x) + r, \xi_m^{n-1}(x, r)\}\} + k \\ &= \xi_m^n(x, r) + k. \end{aligned}$$

Consequently, (2.5.8) follows by induction. Similarly we obtain from (2.5.10a) and from (2.5.12a)

$$\nu_m^0(x, r) = \max \{-u_m^0(x) - r, \min \{-u_m^0(x) + r, -\lambda(x, r)\}\}$$

$$\begin{aligned}
&= \max \{ -(u_m^0(x) + r), \min \{ -(u_m^0(x) - r), -(\lambda(r)) \} \} \\
&= -\min \{ u_m^0(x) + r, \max \{ u_m^0(x) - r, \lambda(r) \} \} \\
&= -\max \{ u_m^0(x) - r, \min \{ u_m^0(x) + r, \lambda(r) \} \} \\
&= -\xi_m^0(x, r).
\end{aligned}$$

Let $n \geq 1$ and suppose that $\nu_{n-1}^r = -\xi_{n-1}^r$ holds. With the same arguments as above we see that from (2.5.10b) and (2.5.12b)

$$\begin{aligned}
\nu_m^n(x, r) &= \max \{ -u_m^n(x) - r, \min \{ -u_m^n(x) + r, -\xi_m^{n-1}(x, r) \} \} \\
&= -\min \{ u_m^n(x) + r, \max \{ u_m^n(x) - r, \xi_m^{n-1}(x, r) \} \} \\
&= -\max \{ u_m^n(x) - r, \min \{ u_m^n(x) + r, \xi_m^{n-1}(x, r) \} \} \\
&= -\xi_m^n(x, r)
\end{aligned}$$

follows, thus (2.5.9) holds. \square

Let us denote for $\Omega \subset \mathbb{R}^n$, $n \in \mathbb{N}$ and a function $u \in L^p(\Omega)$, $1 \leq p \leq \infty$ the positive part $u^+ \in L^p(\Omega)$ by

$$u^+ := \max \{ u, 0 \}, \quad \text{a.e. in } \Omega,$$

and proceed with the proof of the following result.

Lemma 2.5.8. *Let $m \in \mathbb{N}$, $\{u_m^n\}_{n \in \{0, \dots, m\}} \subset L^2(\Omega)$, $\lambda : \Omega \rightarrow \Lambda$ and $r > 0$.*

Let the sequences $\{\xi_m^n\}_{n \in \{0, \dots, m\}}$, $\{\eta_m^n\}_{n \in \{0, \dots, m\}} \subset L^2(\Omega)$ be the outputs to the discretized play operator (by means of Definition 2.5.1) corresponding to the input sequences $\{u_m^n\}_{n \in \{0, \dots, m\}}$, $\{(u_m^n)^+\}_{n \in \{0, \dots, m\}} \subset L^2(\Omega)$ resp., and the initial configuration $\lambda(\cdot, r)$. Then

$$\eta_m^n(x, r) \geq \xi_m^n(x, r) \tag{2.5.13}$$

holds a.e. in Ω for all $n \in \{0, \dots, m\}$ and the following inequality is satisfied

$$(\xi_m^n(x, r) - \xi_m^{n-1}(x, r))(u_m^n)^+ \geq (\eta_m^n(x, r) - \eta_m^{n-1}(x, r))(u_m^n)^+ \tag{2.5.14}$$

a.e. in Ω for all $n \in \{1, \dots, m\}$.

Proof: Let $\lambda : \Omega \rightarrow \Lambda$ and $r > 0$. Recalling Definition 2.5.1 of the time discrete play operator, we obtain

$$\xi_m^0(x, r) = \max \{ u_m^0(x) - r, \min \{ u_m^0(x) + r, \lambda(x, r) \} \}, \tag{2.5.15a}$$

$$\xi_m^n(x, r) = \max \{ u_m^n(x) - r, \min \{ u_m^n(x) + r, \xi_m^{n-1}(x, r) \} \}, \quad \forall n \in \{1, \dots, m\}, \tag{2.5.15b}$$

as well as

$$\eta_m^0(x, r) = \max \{ (u_m^0(x))^+ - r, \min \{ (u_m^0(x))^+ + r, \lambda(x, r) \} \}, \tag{2.5.16a}$$

$$\eta_m^n(x, r) = \max \{ (u_m^n(x))^+ - r, \min \{ (u_m^n(x))^+ + r, \eta_m^{n-1}(x, r) \} \}, \quad \forall n \in \{1, \dots, m\}. \quad (2.5.16b)$$

Thus, from (2.5.15a) and from (2.5.16a) it follows

$$\begin{aligned} \xi_m^0(x, r) &= \max \{ u_m^0(x) - r, \min \{ u_m^0(x) + r, \lambda(x, r) \} \} \\ &\leq \max \{ (u_m^0(x))^+ - r, \min \{ (u_m^0(x))^+ + r, \lambda(x, r) \} \} \\ &= \eta_m^0(x, r) \end{aligned}$$

for a.e. $x \in \Omega$. Now, Let $n \geq 1$ and let us assume that $\eta_m^{n-1}(x, r) \geq \xi_m^{n-1}(x, r)$ for a.e. $x \in \Omega$.

Hence, (2.5.15b) together with (2.5.16b) imply

$$\begin{aligned} \xi_m^n(x, r) &= \max \{ u_m^n(x) - r, \min \{ u_m^n(x) + r, \xi_m^{n-1}(x, r) \} \} \\ &\leq \max \{ (u_m^n(x))^+ - r, \min \{ (u_m^n(x))^+ + r, \eta_m^{n-1}(x, r) \} \} \\ &= \eta_m^n(x, r) \end{aligned}$$

for a.e. $x \in \Omega$ for all $n \in \{1, \dots, m\}$ and therefore (2.5.13) follows.

We proceed with the proof of (2.5.14) and fix $n \in \{1, \dots, m\}$.

Let $x \in \Omega$, with $u_m^n(x) \leq 0$. Hence, we have that $(u_m^n(x))^+ = 0$ holds, and (2.5.14) is trivially satisfied.

Let now $x \in \Omega$ with $u_m^n(x) > 0$, thus clearly $(u_m^n(x))^+ = u_m^n(x)$. We distinguish the following cases.

- ① Suppose that $u_m^n(x) - (u_m^{n-1}(x))^+ \geq 0$ holds. Thus, in particular $u_m^n(x) \geq u_m^{n-1}(x)$ is satisfied as well and according to (2.5.15b) and to (2.5.16b) the following inequalities hold

$$\begin{aligned} \xi_m^{n-1}(x, r) &\leq u_m^{n-1}(x) + r \leq u_m^n(x) + r \\ \eta_m^{n-1}(x, r) &\leq (u_m^{n-1}(x))^+ + r \leq u_m^n(x) + r. \end{aligned}$$

Moreover, with the help of (2.5.15b) and of (2.5.15b) we compute $\xi_m^n(x, r)$ and $\eta_m^n(x, r)$ in the following way

$$\begin{aligned} \xi_m^n(x, r) &= \max \{ u_m^n(x) - r, \min \{ u_m^n(x) + r, \xi_m^{n-1}(x, r) \} \} \\ &= \max \{ u_m^n(x) - r, \xi_m^{n-1}(x, r) \}. \end{aligned}$$

And since by assumption $u_m^n(x) > 0$,

$$\begin{aligned} \eta_m^n(x, r) &= \max \{ u_m^n(x) - r, \min \{ u_m^n(x) + r, \eta_m^{n-1}(x, r) \} \} \\ &= \max \{ u_m^n(x) - r, \eta_m^{n-1}(x, r) \} \end{aligned}$$

follows.

Bearing (2.5.13) in mind, we see that $-\xi_m^{n-1}(x, r) \geq -\eta_m^{n-1}(x, r)$ holds a.e. in Ω for all $n \in \{1, \dots, m\}$ and consequently

$$\begin{aligned} \xi_m^n(x, r) - \xi_m^{n-1}(x, r) &= \max \{u_m^n(x) - r, \xi_m^{n-1}(x, r)\} - \xi_m^{n-1}(x, r) \\ &= \max \{u_m^n(x) - r - \xi_m^{n-1}(x, r), 0\} \\ &\geq \max \{u_m^n(x) - r - \eta_m^{n-1}(x, r), 0\} \\ &= \max \{u_m^n(x) - r, \eta_m^{n-1}(x, r)\} - \eta_m^{n-1}(x, r) \\ &= \eta_m^n(x, r) - \eta_m^{n-1}(x, r) \end{aligned}$$

is satisfied, which is the desired inequality (2.5.14).

- ② Assume now, that $u_m^n(x) - (u_m^{n-1}(x))^+ \leq 0$. Recalling that $u_m^n(x) > 0$ holds, we conclude $0 < (u_m^{n-1}(x))^+ = u_m^{n-1}(x)$ and therefore we obtain from (2.5.15b) and from (2.5.15b)

$$\begin{aligned} \xi_m^{n-1}(x, r) &\geq u_m^{n-1}(x) - r \geq u_m^n(x) - r \\ \eta_m^{n-1}(x, r) &\geq (u_m^{n-1}(x))^+ - r \geq u_m^n(x) - r. \end{aligned}$$

Consequently, (2.5.15b) together with (2.5.15b) yield

$$\begin{aligned} \xi_m^n(x, r) &= \max \{u_m^n(x) - r, \min \{u_m^n(x) + r, \xi_m^{n-1}(x, r)\}\} \\ &= \min \{u_m^n(x) + r, \xi_m^{n-1}(x, r)\}, \end{aligned}$$

as well as

$$\begin{aligned} \eta_m^n(x, r) &= \max \{u_m^n(x) - r, \min \{u_m^n(x) + r, \eta_m^{n-1}(x, r)\}\} \\ &= \min \{u_m^n(x) + r, \eta_m^{n-1}(x, r)\}. \end{aligned}$$

Therefore, we have by virtue of (2.5.13)

$$\begin{aligned} \xi_m^n(x, r) - \xi_m^{n-1}(x, r) &= \min \{u_m^n(x) + r, \xi_m^{n-1}(x, r)\} - \xi_m^{n-1}(x, r) \\ &= \min \{u_m^n(x) + r - \xi_m^{n-1}(x, r), 0\} \\ &\geq \min \{u_m^n(x) + r - \eta_m^{n-1}(x, r), 0\} \\ &= \min \{u_m^n(x) + r, \eta_m^{n-1}(x, r)\} - \eta_m^{n-1}(x, r) \\ &= \eta_m^n(x, r) - \eta_m^{n-1}(x, r); \end{aligned}$$

and (2.5.14) holds again. □

Let us proceed with the proof of the following consequence of Proposition 2.5.2.

Lemma 2.5.9. *Let $m \in \mathbb{N}$, $\{u_m^n\}_{n \in \{0, \dots, m\}} \subset L^2(\Omega)$, with $u_m^n \geq 0$ a.e. in Ω for all $n \in \{1, \dots, m\}$, $\lambda : \Omega \rightarrow \Lambda$ and $r > 0$.*

Let the sequence $\{\xi_m^n\}_{n \in \{0, \dots, m\}} \subset L^2(\Omega)$ be the output to the discretized play operator (by means of Definition 2.5.1) corresponding to the input sequence $\{u_m^n\}_{n \in \{0, \dots, m\}}$ and the initial configuration $\lambda(\cdot, r)$. Then inequality

$$(\xi_m^n(x, r) - \xi_m^{n-1}(x, r)) [u_m^n(x) - (\xi_m^n(x, r) - r)^+] \geq 0 \quad (2.5.17)$$

holds a.e. in Ω , for all $n \in \{1, \dots, m\}$.

Proof: Consider the difference $\xi_m^n(x, r) - (\xi_m^n(x, r) - r)^+$. A simple calculation yields

$$\xi_m^n(x, r) - (\xi_m^n(x, r) - r)^+ = \min \{\xi_m^n(x, r), r\} \leq r. \quad \text{a.e. in } \Omega.$$

On the other hand, since by assumption $u_m^n \geq 0$ a.e. in Ω , we always have by virtue of formula (2.5.1) the pointwise estimate $\xi_m^n(x, r) \geq u_m^n(x) - r \geq -r$ for a.a. $x \in \Omega$ and therefore $|\xi_m^n(x, r) - (\xi_m^n(x, r) - r)^+| \leq r$ holds for all $n \in \{1, \dots, m\}$.

Using the variational representation for the play system stated in Proposition 2.5.2 we find that $z = (\xi_m^n(x, r) - r)^+ - \xi_m^n(x, r)$ is an admissible test-function for (2.5.4), and obtain that

$$(\xi_m^n(x, r) - \xi_m^{n-1}(x, r)) [u_m^n(x) - \xi_m^n(x, r) - ((\xi_m^n(x, r) - r)^+ - \xi_m^n(x, r))] \geq 0$$

holds a.e in Ω for all $n \in \{1, \dots, m\}$. Consequently,

$$(\xi_m^n(x, r) - \xi_m^{n-1}(x, r)) [u_m^n(x) - (\xi_m^n(x, r) - r)^+] \geq 0$$

is satisfied a.e. in Ω for all $n \in \{1, \dots, m\}$. \square

With the help of the previous Lemmata we now prove a modified version of Proposition 2.3.12 stated in the following result.

Proposition 2.5.10. Assume that $\psi \in L^1_{loc}(\mathcal{P})$ satisfies Assumptions 2.3.6 and 2.3.10. Let $m \in \mathbb{N}$, $\{u_m^n\}_{n \in \{0, \dots, m\}} \subset L^2(\Omega)$, $\lambda : \Omega \rightarrow \Lambda$, and the sequences $\{\xi_m^n(\cdot, r)\}_{n \in \{0, \dots, m\}}$ as well as $\{w_m^n(\cdot)\}_{n \in \{0, \dots, m\}}$ be defined according to formulas (2.5.1) and (2.5.3).

For $r > 0$, let the sequences $\{\eta_m^n(\cdot, r)\}_{n \in \{0, \dots, m\}}$, $\{\nu_m^n(\cdot, r)\}_{n \in \{0, \dots, m\}}$ be defined by formula (2.5.1) corresponding to the the initial configurations $\lambda(\cdot, r) - k$, and $-\lambda(\cdot, r) - k$, and the input sequences $\{(u_m^n - k)^+\}_{n \in \{0, \dots, m\}}$, and $\{(-u_m^n - k)^+\}_{n \in \{0, \dots, m\}}$ respectively.

Let the nonnegative sequences $\{\mathcal{U}_m^{*n(k)}\}_{n \in \{0, \dots, m\}}$ and $\{\mathcal{Q}_m^{*n(k)}\}_{n \in \{0, \dots, m\}}$ be defined in the following way

$$\begin{aligned} \mathcal{U}_m^{*n(k)}(x) &= \int_0^\infty \int_0^{(\eta_m^n(x, r) - r)^+} z \psi(r, z + k + r) dz dr, \\ \mathcal{Q}_m^{*n(k)}(x) &= \int_0^\infty \int_0^{(\nu_m^n(x, r) - r)^+} z \psi(r, -z + k + r) dz dr, \end{aligned}$$

a.e. in Ω . Then

$$[w_m^n(x, r) - w_m^{n-1}(x, r)] (u_m^n - k)^+ \geq \mathcal{U}_m^{*n(k)} - \mathcal{U}_m^{*n-1(k)}, \quad (2.5.18)$$

$$- [w_m^n(x, r) - w_m^{n-1}(x, r)] (-u_m^n - k)^+ \geq \mathcal{U}_m^{*n(k)} - \mathcal{U}_m^{*(n-1)(k)} \quad (2.5.19)$$

hold for all $n \in \{1, \dots, m\}$, a.e. in Ω and we have the following bounds

$$\mathcal{U}_m^{*n(k)} \leq \frac{\tilde{b}}{2} (u_m^n - k)^+, \quad \mathcal{U}_m^{*(n-1)(k)} \leq \frac{\tilde{b}}{2} (-u_m^n - k)^+ \quad (2.5.20)$$

for all $n \in \{1, \dots, m\}$, a.e. in Ω , where \tilde{b} as in (2.3.7).

Proof: For $r > 0$, let the sequences $\{\xi_m^n(\cdot, r)\}_{n \in \{0, \dots, m\}}$, $\{\eta_m^n(\cdot, r)\}_{n \in \{0, \dots, m\}}$, and $\{\nu_m^n(\cdot, r)\}_{n \in \{0, \dots, m\}}$ be defined as above, and let the function g be as in (2.5.3). Let us fix $n \in \{1, \dots, m\}$ and distinguish the following cases:

- ① Let $x \in \Omega$ such that $\xi_m^{n-1}(x, r) = \xi_m^n(x, r)$ holds.

If $u_m^n(x) \leq 0$, formula (2.5.1) together with Proposition 2.5.3 yield $\eta_m^n(x, r) \leq \eta_m^{n-1}(x)$. On the other hand, if $u_m^n(x) > 0$, we find with the help of (2.5.14) of Lemma 2.5.8 that $\eta_m^n \leq \eta_m^{n-1}$. Thus, $(\eta_m^n - r)^+ \leq (\eta_m^{n-1} - r)^+$ is satisfied. Recalling that according to Assumption 2.3.10 ψ is nonnegative, we infer

$$[g(r, \xi_m^n(x, r)) - g(r, \xi_m^{n-1}(x, r))] (u_m^n - k)^+ = 0 \geq \int_{(\eta_m^{n-1}(x, r) - r)^+}^{(\eta_m^n(x, r) - r)^+} z \psi(r, z + k + r) dz.$$

- ② Let $x \in \Omega$ such that $\xi_m^{n-1}(x, r) < \xi_m^n(x, r)$, and $\eta_m^{n-1}(x, r) = \eta_m^n(x, r)$. Bearing in mind that $\partial_z g = \psi \geq 0$ by virtue of Assumption 2.3.10, we clearly have

$$[g(r, \xi_m^n(x, r)) - g(r, \xi_m^{n-1}(x, r))] (u_m^n - k)^+ \geq 0 = \int_{(\eta_m^{n-1}(x, r) - r)^+}^{(\eta_m^n(x, r) - r)^+} z \psi(r, z + k + r) dz.$$

- ③ Suppose now, that $x \in \Omega$ such that $\xi_m^{n-1}(x, r) > \xi_m^n(x, r)$, and $\eta_m^{n-1}(x, r) = \eta_m^n(x, r)$. Then either $(u_m^n - k)^+ = 0$ or by virtue of (2.5.14) $\xi_m^n(x, r) - \xi_m^{n-1}(x, r) \geq 0$ must hold. As the latter statement is a contradiction, and $\partial_z g = \psi \geq 0$ due to Assumption 2.3.10, we find

$$[g(r, \xi_m^n(x, r)) - g(r, \xi_m^{n-1}(x, r))] (u_m^n - k)^+ = 0 = \int_{(\eta_m^{n-1}(x, r) - r)^+}^{(\eta_m^n(x, r) - r)^+} z \psi(r, z + k + r) dz.$$

- ④ And finally, let $x \in \Omega$ with $\xi_m^{n-1}(x, r) \neq \xi_m^n(x, r)$ and $\eta_m^{n-1}(x, r) \neq \eta_m^n(x, r)$.

We denote by $\{\bar{\eta}_m^n(\cdot, r)\}_{n \in \{0, \dots, m\}}$ the output of the time discrete play operator defined by formula (2.5.1) corresponding to the the initial configuration $\lambda(\cdot, r) - k$ and the input sequence $\{u_m^n - k\}_{n \in \{0, \dots, m\}}$. Applying identity (2.5.8) of Lemma 2.5.7 we calculate

$$\begin{aligned} [g(r, \xi_m^n(x, r)) - g(r, \xi_m^{n-1}(x, r))] (u_m^n - k)^+ &= \int_{\xi_m^{n-1}(x, r)}^{\xi_m^n(x, r)} (u_m^n - k)^+ \psi(r, z) dz \\ &= \int_{\bar{\eta}_m^{n-1}(x, r) + k}^{\bar{\eta}_m^n(x, r) + k} (u_m^n - k)^+ \psi(r, z) dz = \int_{\bar{\eta}_m^{n-1}(x, r)}^{\bar{\eta}_m^n(x, r)} (u_m^n - k)^+ \psi(r, z + k) dz \end{aligned}$$

$$= \text{sign}(\bar{\eta}_m^n(x, r) - \bar{\eta}_m^{n-1}(x, r)) \int_{\min\{\bar{\eta}_m^{n-1}(x, r); \bar{\eta}_m^n(x, r)\}}^{\max\{\bar{\eta}_m^{n-1}(x, r); \bar{\eta}_m^n(x, r)\}} (u_m^n - k)^+ \psi(r, z + k) dz. \quad (2.5.21)$$

As Lemma 2.5.8 yields

$$\text{sign}(\bar{\eta}_m^n(x, r) - \bar{\eta}_m^{n-1}(x, r)) (u_m^n - k)^+ \geq \text{sign}(\eta_m^n(x, r) - \eta_m^{n-1}(x, r)) (u_m^n - k)^+,$$

and since $\psi \geq 0$, we obtain from (2.5.21)

$$\begin{aligned} & [g(r, \xi_m^n(x, r)) - g(r, \xi_m^{n-1}(x, r))] (u_m^n - k)^+ \\ & \geq \text{sign}(\eta_m^n(x, r) - \eta_m^{n-1}(x, r)) \int_{\min\{\bar{\eta}_m^{n-1}(x, r); \bar{\eta}_m^n(x, r)\}}^{\max\{\bar{\eta}_m^{n-1}(x, r); \bar{\eta}_m^n(x, r)\}} (u_m^n - k)^+ \psi(r, z + k) dz. \end{aligned} \quad (2.5.22)$$

Bearing in mind that $\psi \geq 0$ is nonnegative, we find with the help of Lemma 2.5.9

$$\begin{aligned} & \int_{\min\{\bar{\eta}_m^{n-1}(x, r); \bar{\eta}_m^n(x, r)\}}^{\max\{\bar{\eta}_m^{n-1}(x, r); \bar{\eta}_m^n(x, r)\}} (\eta_m^n(x, r) - \eta_m^{n-1}(x, r)) (u_m^n - k)^+ \psi(r, z + k) dz \\ & \geq \int_{\min\{\bar{\eta}_m^{n-1}(x, r); \bar{\eta}_m^n(x, r)\}}^{\max\{\bar{\eta}_m^{n-1}(x, r); \bar{\eta}_m^n(x, r)\}} (\eta_m^n(x, r) - \eta_m^{n-1}(x, r)) (\eta_m^n(x, r) - r)^+ \psi(r, z + k) dz. \end{aligned}$$

Clearly, either $(\eta_m^n(x, r) - r)^+ = 0$ and the whole integral on the right-hand side of this inequality turns 0, or $\eta_m^n(x, r) > r > 0$. In the latter case, the pointwise inequality

$$\eta_m^n(x, r) \leq (u_m^n(x) - k)^+ + r$$

implies $(u_m^n(x) - k)^+ > 0$.

Therefore, we by virtue of our assumption $\eta_m^n(x, r) \neq \eta_m^{n-1}(x, r)$ and the piecewise monotonicity property of the play operator stated in Lemma 2.5.3 we obtain $(u_m^n(x) - k)^+ \neq (u_m^{n-1}(x) - k)^+$. As a consequence $u_m^n(x) \neq u_m^{n-1}(x)$ must hold and $\bar{\eta}_m^{n-1}(x, r) \neq \bar{\eta}_m^n(x, r)$ follows.

Recalling that $(u_m^n(x) - k)^+ > 0$, we infer by virtue of formula (2.5.1)

$$\bar{\eta}_m^n(x, r) = (u_m^n(x) - k) \pm r = (u_m^n(x) - k)^+ \pm r = \eta_m^n(x, r).$$

If $\eta_m^n(x, r) - \eta_m^{n-1}(x, r) < 0$, then again by virtue of $(u_m^n(x) - k)^+ > 0$ and of Lemma 2.5.3 we have that $(u_m^n(x) - k)^+ < (u_m^{n-1}(x) - k)^+$ must hold, and consequently also

$$\bar{\eta}_m^{n-1}(x, r) = (u_m^{n-1}(x) - k) + r = (u_m^{n-1}(x) - k)^+ + r = \eta_m^{n-1}(x, r).$$

On the other hand, if $\eta_m^n(x, r) - \eta_m^{n-1}(x, r) > 0$, then $(u_m^n(x) - k)^+ > 0$ together with inequality (2.5.14) of Lemma 2.5.8 yields

$$\bar{\eta}_m^n(x, r) - \bar{\eta}_m^{n-1}(x, r) \geq \eta_m^n(x, r) - \eta_m^{n-1}(x, r) > 0$$

and therefore

$$\text{sign}(\bar{\eta}_m^n(x, r) - \bar{\eta}_m^{n-1}(x, r)) = \text{sign}(\eta_m^n(x, r) - \eta_m^{n-1}(x, r))$$

follows. Hence, we obtain the succeeding bound

$$\begin{aligned} & \int_{\min\{\bar{\eta}_m^{n-1}(x, r); \bar{\eta}_m^n(x, r)\}}^{\max\{\bar{\eta}_m^{n-1}(x, r); \bar{\eta}_m^n(x, r)\}} (\eta_m^n(x, r) - \eta_m^{n-1}(x, r)) (\eta_m^n(x, r) - r)^+ \psi(r, z + k) dz \\ &= \text{sign}(\bar{\eta}_m^n(x, r) - \bar{\eta}_m^{n-1}(x, r)) \times \\ & \quad \times \int_{\min\{\bar{\eta}_m^{n-1}(x, r); \bar{\eta}_m^n(x, r)\}}^{\max\{\bar{\eta}_m^{n-1}(x, r); \bar{\eta}_m^n(x, r)\}} |\eta_m^n(x, r) - \eta_m^{n-1}(x, r)| (\eta_m^n(x, r) - r)^+ \psi(r, z + k) dz \\ &= \int_{\bar{\eta}_m^{n-1}(x, r)}^{\eta_m^n(x, r)} |\eta_m^n(x, r) - \eta_m^{n-1}(x, r)| (\eta_m^n(x, r) - r)^+ \psi(r, z + k) dz \\ &\geq \int_{\eta_m^{n-1}(x, r)}^{\eta_m^n(x, r)} |\eta_m^n(x, r) - \eta_m^{n-1}(x, r)| (\eta_m^n(x, r) - r)^+ \psi(r, z + k) dz. \end{aligned}$$

This estimate, together with (2.5.22) implies

$$\begin{aligned} & [g(r, \xi_m^n(x, r)) - g(r, \xi_m^{n-1}(x, r))] (u_m^n - k)^+ \\ &\geq \frac{1}{|\eta_m^n(x, r) - \eta_m^{n-1}(x, r)|} \times \\ & \quad \times \int_{\min\{\bar{\eta}_m^{n-1}(x, r); \bar{\eta}_m^n(x, r)\}}^{\max\{\bar{\eta}_m^{n-1}(x, r); \bar{\eta}_m^n(x, r)\}} (\eta_m^n(x, r) - \eta_m^{n-1}(x, r)) (u_m^n - k)^+ \psi(r, z + k) dz \\ &\geq \frac{1}{|\eta_m^n(x, r) - \eta_m^{n-1}(x, r)|} \times \\ & \quad \times \int_{\eta_m^{n-1}(x, r)}^{\eta_m^n(x, r)} |\eta_m^n(x, r) - \eta_m^{n-1}(x, r)| (\eta_m^n(x, r) - r)^+ \psi(r, z + k) dz \\ &= \int_{\eta_m^{n-1}(x, r)}^{\eta_m^n(x, r)} (\eta_m^n(x, r) - r)^+ \psi(r, z + k) dz. \quad (2.5.23) \end{aligned}$$

As $\eta_m^{n-1}(x, r) - r \leq (\eta_m^{n-1}(x, r) - r)^+$ clearly holds, we infer

$$\begin{aligned} & \int_{\eta_m^{n-1}(x, r)}^{\eta_m^n(x, r)} (\eta_m^n(x, r) - r)^+ \psi(r, z + k) dz \\ &= \int_{\eta_m^{n-1}(x, r) - r}^{\eta_m^n(x, r) - r} (\eta_m^n(x, r) - r)^+ \psi(r, z + k + r) dz \\ &= \int_{\eta_m^{n-1}(x, r) - r}^{(\eta_m^n(x, r) - r)^+} (\eta_m^n(x, r) - r)^+ \psi(r, z + k + r) dz \\ &\geq \int_{(\eta_m^{n-1}(x, r) - r)^+}^{(\eta_m^n(x, r) - r)^+} (\eta_m^n(x, r) - r)^+ \psi(r, z + k + r) dz \\ &\geq \int_{(\eta_m^{n-1}(x, r) - r)^+}^{(\eta_m^n(x, r) - r)^+} z \psi(r, z + k + r) dz, \end{aligned}$$

and consequently (2.5.18) follows. Furthermore, recalling Definition 2.5.1 of the discrete play operator, we find that the pointwise estimate

$$(\eta_m^n(x, r) - r)^+ \leq ((u_m^n(x, r) - k)^+ + r - r)^+ = (u_m^n(x, r) - k)^+,$$

holds, and with the help of Assumptions 2.3.6 and 2.3.10

$$\begin{aligned} \mathcal{U}_m^{*n(k)} &= \int_0^\infty \int_0^{(\eta_m^n(x,r)-r)^+} z\psi(r, z+k+r) dz dr \\ &\leq \int_0^\infty \int_0^{(\eta_m^n(x,r)-r)^+} z\beta(r) dz dr \\ &= \int_0^\infty \frac{1}{2} ((\eta_m^n(x,r)-r)^+)^2 \beta(r) dr \leq \frac{\tilde{b}}{2} (p_m^n(x,r)-k)^+{}^2 \end{aligned}$$

follows, where \tilde{b} as in (2.3.7).

Finally,

$$-(g(r, \xi_m^n) - g(r, \xi_m^{n-1})) = - \int_{\xi_m^{n-1}}^{\xi_m^n} \psi(r, z) dz = \int_{-\xi_m^{n-1}}^{-\xi_m^n} \psi(r, -z) dz =: (\tilde{g}(r, \bar{\nu}_m^n) - \tilde{g}(r, \bar{\nu}_m^{n-1}))$$

is satisfied with the obvious notation of \tilde{g} .

We put $\{\tilde{w}_m^n\}_{n \in \{0, \dots, m\}}$ to be the output of the discretized Preisach operator according to formula (2.5.3), corresponding to the input sequence $\{-u_m^n\}_{n \in \{0, \dots, m\}}$, the initial configuration $-\lambda$, and the density function $\tilde{\psi}(r, z) := \psi(r, -z)$. Clearly, $\tilde{\psi}$ satisfies Assumptions 2.3.6 and 2.3.10. Moreover, as

$$-(w_m^n - w_m^{n-1}) = (\tilde{w}_m^n - \tilde{w}_m^{n-1})$$

holds a.e. in Ω for all $n \in \{1, \dots, m\}$, application of (2.5.18) to

$$(\tilde{w}_m^n - \tilde{w}_m^{n-1})(-u_m^n - k)^+$$

yields (2.5.19). Arguing as above we find

$$\begin{aligned} \mathcal{Q}_m^{*n(k)} &= \int_0^\infty \int_0^{(\nu_m^n(x,r)-r)^+} z\psi(r, -z+k+r) dz dr \\ &\leq \int_0^\infty \int_0^{(\nu_m^n(x,r)-r)^+} z\beta(r) dz dr \\ &= \int_0^\infty \frac{1}{2} ((\nu_m^n(x,r)-r)^+)^2 \beta(r) dr \leq \frac{\tilde{b}}{2} (-u_m^n(x,r)-k)^+{}^2. \end{aligned}$$

□

Remark 2.5.11. *The statement of Proposition 2.5.10 holds also in the case when the number $k \in \mathbb{R}$ is replaced by a function $k \in L^\infty(\Omega)$.*

*Then, with the same notation of the sequences $\{\eta_m^n(\cdot, r)\}_{n \in \{0, \dots, m\}}$ and $\{\nu_m^n(\cdot, r)\}_{n \in \{0, \dots, m\}}$ as in Proposition 2.5.10 the nonnegative sequences $\{\mathcal{U}_m^{*n(k)}\}_{n \in \{0, \dots, m\}}$ and $\{\mathcal{Q}_m^{*n(k)}\}_{n \in \{0, \dots, m\}}$ are defined by*

$$\begin{aligned} \mathcal{U}_m^{*n(k(x))}(x) &:= \int_0^\infty \int_0^{(\eta_m^n(x,r)-r)^+} z\psi(r, z+k(x)+r) dz dr, \\ \mathcal{Q}_m^{*n(k(x))}(x) &:= \int_0^\infty \int_0^{(\nu_m^n(x,r)-r)^+} z\psi(r, -z+k(x)+r) dz dr, \end{aligned}$$

for a.a. $x \in \Omega$, satisfy

$$[w_m^n(x, r) - w_m^{n-1}(x, r)] (u_m^n(x) - k(x))^+ \geq \mathcal{U}_m^{*n(k(x))}(x) - \mathcal{U}_m^{*(n-1)(k(x))}(x), \quad (2.5.24)$$

$$- [w_m^n(x, r) - w_m^{n-1}(x, r)] (-u_m^n(x) - k(x))^+ \geq \mathcal{Q}_m^{*n(k(x))}(x) - \mathcal{Q}_m^{*(n-1)(k(x))}(x) \quad (2.5.25)$$

for all $n \in \{1, \dots, m\}$, and a.a. $x \in \Omega$ and we have the following bounds

$$\mathcal{U}_m^{*n(k(x))} \leq \frac{\tilde{b}}{2} (u_m^n(x) - k(x))^+{}^2, \quad \mathcal{Q}_m^{*n(k(x))} \leq \frac{\tilde{b}}{2} (-u_m^n(x) - k(x))^+{}^2 \quad (2.5.26)$$

for all $n \in \{1, \dots, m\}$, a.e. in Ω , where \tilde{b} as in (2.3.7).

Let $T > 0$, $m \in \mathbb{N}$ and $h = T/m$. For a sequence $\{y_m^n\}_{n \in \{0, \dots, m\}}$ and h as above we set

$$\dot{y}_m^n := \frac{y_m^n - y_m^{n-1}}{h}, \quad \forall n \in \{1, \dots, m\}$$

and prove the following result, which allows us to overcome the lack of the Second Order Energy Inequality for Preisach operators.

Proposition 2.5.12. *Suppose that the density $\psi \in L^1_{loc}(\mathcal{P})$ satisfies Assumptions 2.3.6 and 2.3.10. Let $R > 0$, $\{u_m^n\}_{n \in \{0, \dots, m\}} \subset L^\infty(\Omega)$, $\max_{\{0, \dots, m\}} \|u_m^n\|_{L^\infty(\Omega)} \leq R$, and $\lambda : \Omega \rightarrow \Lambda_R$. Let $\{\xi_m^n(\cdot, r)\}_{m \in \{0, \dots, m\}}$ be the output of the discretized play operator (by means of formula (2.5.1)) corresponding to the input sequence $\{u_m^n\}_{n \in \{0, \dots, m\}}$ and the initial configuration λ , and let the function g be as in (2.5.3). Then for all $r \leq R$ the following inequality holds*

$$\begin{aligned} & \frac{\psi(\xi_m^n(x, r))}{2} \left| \dot{\xi}_m^n(x, r) \right|^2 - \frac{\psi(\xi_m^{n-1}(x, r))}{2} \left| \dot{\xi}_m^{n-1}(x, r) \right|^2 \\ & \leq \left[\frac{g(r, \xi_m^n(x, r)) - g(\xi_m^{n-1}(x, r), r)}{h} - \frac{g(r, \xi_m^{n-1}(x, r)) - g(r, \xi_m^{n-2}(x, r))}{h} \right] [(\dot{u}_m^n(x))] \\ & \quad + \frac{7}{6} \sup_{\substack{0 \leq r \leq R; \\ |z| \leq 2R}} |\partial_z \psi(r, z)| h \left| \dot{\xi}_m^n(x, r) \right|^3 + \frac{1}{6} \sup_{\substack{0 \leq r \leq R; \\ |z| \leq 2R}} |\partial_z \psi(r, z)| h \left| \dot{\xi}_m^n(x, r) \right|^3. \end{aligned}$$

for a.a. $x \in \Omega$, for all $n \in \{1, \dots, m\}$.

Proof: Let $m \in \mathbb{N}$, $h = \frac{T}{m}$, $r > 0$, and consider $\{u_m^n\}_{n \in \{1, \dots, m\}}$, $\{v_m^n\}_{n \in \{1, \dots, m\}} \subset L^\infty(\Omega)$.

Moreover, we put $\{\xi_m^n(\cdot, r)\}_{m \in \{0, \dots, m\}}$, $\{\eta_m^n(\cdot, r)\}_{m \in \{0, \dots, m\}} \subset L^2(\Omega)$ to be the outputs of the discretized play operator (by means of formula (2.5.1)) corresponding to the input sequences $\{u_m^n\}_{n \in \{1, \dots, m\}}$ and $\{v_m^n\}_{n \in \{1, \dots, m\}}$ resp., and the initial configuration λ .

For simplicity we omit the fixed index m and define

$$u_n(x) := u_m^n(x), \quad v_n(x) := v_m^n(x), \quad \xi_n^r(x) := \xi_m^n(x, r), \quad \eta_n^r(x) := \eta_m^n(x, r).$$

By virtue of Proposition 2.5.2 it follows that

$$\begin{aligned} (\xi_n^r - \xi_{n-1}^r)(u_n - \xi_n^r - z_1) & \geq 0, \\ (\eta_n^r - \eta_{n-1}^r)(v_n - \eta_n^r - z_2) & \geq 0 \end{aligned} \quad \text{hold for any } z_1, z_2 \in [-r, r], \text{ for all } n \in \{1, \dots, m\}.$$

a.e. in Ω . As the function $\psi(r, z) = \partial_z g(r, z)$ is nonnegative by virtue of Assumption 2.3.10, the previous inequality implies

$$\begin{aligned} [g(r, \xi_n^r) - g(\xi_{n-1}^r)] (u_n - \xi_n^r - z_1) &\geq 0, \\ [g(r, \eta_n^r) - g(\eta_{n-1}^r)] (v_n - \eta_n^r - z_2) &\geq 0 \end{aligned} \quad \text{for any } z_1, z_2 \in [-r, r], \text{ for all } n \in \{1, \dots, m\}$$

a.e in Ω . Choosing $z_1 = v_n - \eta_n^r$ and $z_2 = u_n - \xi_n^r$ and summing the resulting inequalities, we find

$$[g(r, \xi_n^r) - g(\xi_{n-1}^r) - g(r, \eta_n^r) + g(\eta_{n-1}^r)] [(u_n - v_n) - (\xi_n^r - \eta_n^r)] \geq 0. \quad (2.5.27)$$

By Taylor's theorem there exist for a.a. $x \in \Omega$ $\theta_1(x) \in [\xi_n^r(x), \eta_n^r(x)]$ and $\theta_2(x) \in [\xi_{n-1}^r(x), \eta_{n-1}^r(x)]$ such that

$$\begin{aligned} g(r, \xi_n^r) - g(r, \eta_n^r) &= \psi(r, \xi_n^r)(\xi_n^r - \eta_n^r) - \frac{1}{2} \partial_z \psi(r, \theta_1)(\xi_n^r - \eta_n^r)^2, \\ g(\xi_{n-1}^r) - g(\eta_{n-1}^r) &= \psi(r, \xi_{n-1}^r)(\xi_{n-1}^r - \eta_{n-1}^r) - \frac{1}{2} \partial_z \psi(r, \theta_2)(\xi_{n-1}^r - \eta_{n-1}^r)^2 \end{aligned}$$

a.e. in Ω . With the notation

$$g_n^r := g(r, \xi_n^r), \quad \gamma_n^r := g(r, \eta_n^r), \quad \psi_n^r := \psi(r, \xi_n^r), \quad \tilde{\psi}_n^r := \psi(r, \eta_n^r),$$

we obtain the succeeding identity

$$\begin{aligned} [(g_n^r - \gamma_n^r) - (g_{n-1}^r - \gamma_{n-1}^r)] (\xi_n^r - \eta_n^r) &= \psi_n^r |\xi_n^r - \eta_n^r|^2 - \psi_{n-1}^r (\xi_{n-1}^r - \eta_{n-1}^r)(\xi_n^r - \eta_n^r) \\ &\quad - \frac{1}{2} \partial_z \psi(r, \theta_1)(\xi_n^r - \eta_n^r) |\xi_n^r - \eta_n^r|^2 \\ &\quad + \frac{1}{2} \partial_z \psi(r, \theta_2)(\xi_{n-1}^r - \eta_{n-1}^r)^2 (\xi_n^r - \eta_n^r). \end{aligned} \quad (2.5.28)$$

We will estimate the terms of the right hand side of (2.5.28). First we observe, that the boundedness of the u_n and v_n and the pointwise inequalities

$$u_n - r(x) \leq \xi_n^r(x) \leq u_n(x) + r, \quad v_n - r(x) \leq \eta_n^r(x) \leq v_n(x) + r$$

imply, that $|\xi_n^r|, |\eta_n^r| \leq R + r$. Moreover, bearing in mind that by virtue of Assumption 2.3.10 $\partial_z \psi(r, z) \in L_{loc}^\infty(\mathbb{R}^2)$ holds, we find for all $r \leq R$ the following estimate

$$|\psi_n^r - \psi_{n-1}^r| \leq \sup_{\substack{0 \leq r \leq R; \\ |z| \leq 2R}} |\partial_z \psi(r, z)| |\xi_n^r - \xi_{n-1}^r|,$$

With the help of Young's inequality we see that

$$(\xi_{n-1}^r - \eta_{n-1}^r)(\xi_n^r - \eta_n^r) \leq \frac{1}{2} |\xi_{n-1}^r - \eta_{n-1}^r|^2 + \frac{1}{2} |\xi_n^r - \eta_n^r|^2. \quad (2.5.29)$$

holds, and consequently, making use of (2.5.29) $\psi_{n-1}^r \geq 0$, we then obtain for $r \leq R$

$$\psi_n^r |\xi_n^r - \eta_n^r|^2 - \psi_{n-1}^r (\xi_{n-1}^r - \eta_{n-1}^r)(\xi_n^r - \eta_n^r)$$

$$\begin{aligned}
&\geq \psi_n^r |\xi_n^r - \eta_n^r|^2 - \frac{\psi_{n-1}^r}{2} |\xi_{n-1}^r - \eta_{n-1}^r|^2 - \frac{1}{2} \psi_{n-1}^r |\xi_n^r - \eta_n^r|^2 \\
&= \frac{\psi_n^r}{2} |\xi_n^r - \eta_n^r|^2 - \frac{\psi_{n-1}^r}{2} |\xi_{n-1}^r - \eta_{n-1}^r|^2 + \frac{1}{2} (\psi_n^r - \psi_{n-1}^r) |\xi_n^r - \eta_n^r|^2 \\
&\geq \frac{\psi_n^r}{2} |\xi_n^r - \eta_n^r|^2 - \frac{\psi_{n-1}^r}{2} |\xi_{n-1}^r - \eta_{n-1}^r|^2 - \frac{1}{2} \sup_{\substack{0 \leq r \leq R; \\ |z| \leq 2R}} |\partial_z \psi(r, z)| h \left| \dot{\xi}_n^r \right| |\xi_n^r - \eta_n^r|^2. \quad (2.5.30)
\end{aligned}$$

Again, application of Young's inequality to the last term of the right hand side of (2.5.28) yields

$$\left| \frac{1}{2} \partial_z \psi(r, \theta_2) (\xi_{n-1}^r - \eta_{n-1}^r)^2 (\xi_n^r - \eta_n^r) \right| \leq \frac{1}{2} \sup_{\substack{0 \leq r \leq R; \\ |z| \leq 2R}} |\partial_z \psi(r, z)| \left[\frac{2}{3} |\xi_{n-1}^r - \eta_{n-1}^r|^3 + \frac{1}{3} |\xi_n^r - \eta_n^r|^3 \right],$$

and therefore

$$\begin{aligned}
&\frac{1}{2} \partial_z \psi(r, \theta_1) (\xi_n^r - \eta_n^r) |\xi_n^r - \eta_n^r|^2 - \frac{1}{2} \partial_z \psi(r, \theta_2) (\xi_{n-1}^r - \eta_{n-1}^r) (\xi_n^r - \eta_n^r) \\
&\leq \frac{1}{2} \sup_{\substack{0 \leq r \leq R; \\ |z| \leq 2R}} |\partial_z \psi(r, z)| \left[\frac{4}{3} |\xi_n^r - \eta_n^r|^3 + \frac{2}{3} |\xi_{n-1}^r - \eta_{n-1}^r|^3 \right]. \quad (2.5.31)
\end{aligned}$$

follows for $r \leq R$.

Inserting the estimates (2.5.30) and (2.5.28) into (2.5.27) we obtain the following inequality

$$\begin{aligned}
&\frac{\psi_n^r}{2} |\xi_n^r - \eta_n^r|^2 - \frac{\psi_{n-1}^r}{2} |\xi_{n-1}^r - \eta_{n-1}^r|^2 \\
&\leq [(g(r, \xi_n^r) - g(\xi_{n-1}^r) - (g(r, \eta_n^r) - g(\eta_{n-1}^r)))] [(u_n - v_n)] \\
&\quad + \frac{1}{2} \sup_{\substack{0 \leq r \leq R; \\ |z| \leq 2R}} |\partial_z \psi(r, z)| h \left| \dot{\xi}_n^r \right| |\xi_n^r - \eta_n^r|^2 \\
&\quad + \frac{1}{2} \sup_{\substack{0 \leq r \leq R; \\ |z| \leq 2R}} |\partial_z \psi(r, z)| \left[\frac{4}{3} |\xi_n^r - \eta_n^r|^3 + \frac{1}{3} |\xi_{n-1}^r - \eta_{n-1}^r|^3 \right]. \quad (2.5.32)
\end{aligned}$$

Setting $v_n = u_{n-1}$ for $n \geq 1$ and $v_0 = u_0$, we obtain $\eta_0^r = \xi_0^r$ and $\eta_n^r = \xi_{n-1}^r$ for any $n = 1, \dots, m$.

Therefore (2.5.32) transforms into

$$\begin{aligned}
&\frac{\psi_n^r}{2} |\xi_n^r - \xi_{n-1}^r|^2 - \frac{\psi_{n-1}^r}{2} |\xi_{n-1}^r - \xi_{n-2}^r|^2 \\
&\leq [(g(r, \xi_n^r) - g(\xi_{n-1}^r) - (g(r, \xi_{n-1}^r) - g(\xi_{n-2}^r)))] [(u_n - u_{n-1})] \\
&\quad + \frac{7}{6} \sup_{\substack{0 \leq r \leq R; \\ |z| \leq 2R}} |\partial_z \psi(r, z)| h \left| \dot{\xi}_n^r \right| |\xi_n^r - \xi_{n-1}^r|^2 \\
&\quad + \frac{1}{6} \sup_{\substack{0 \leq r \leq R; \\ |z| \leq 2R}} |\partial_z \psi(r, z)| h \left| \dot{\xi}_{n-1}^r \right| |\xi_{n-1}^r - \xi_{n-2}^r|^2.
\end{aligned}$$

Dividing this inequality by h^2 finishes the proof. \square

CHAPTER 3

MODEL PROBLEM AND MAIN RESULTS

In the sequel we study a nonlinear PDE containing a continuous hysteresis operator \mathfrak{W} . The model equation we consider is the following and corresponds to the flow problem introduced in Chapter 1

$$\frac{\partial}{\partial t} \mathfrak{W}[p] - \nabla \cdot k(\mathfrak{W}[p]) (\nabla p + \hat{z}) = 0, \quad \text{in } \Omega \times (0, T),$$

where p is unknown, Ω is an open bounded set of \mathbb{R}^3 , k is a Lipschitz continuous superposition operator, and \hat{z} the upward vertical unit vector.

We first introduce a weak formulation in the framework of Sobolev spaces associated to the above system in presence of a hysteresis operator of Preisach type (2.4.2), also accounting for boundary conditions of Signorini type (1.6.2).

Under suitable assumptions on the domain Ω , the data of the problem, and on the hysteresis operator \mathfrak{W} , we are able to establish existence of a weak solution p and also prove the local boundedness in the interior of all partial derivatives of p . Furthermore, we show that when the boundary conditions reduce to the case of Dirichlet boundary conditions the above system admits a unique weak solution.

The existence result is based on approximation by Rothe's scheme (implicit time discretization), a priori estimates and passage to the limit by a compactness argument. During the proof we concentrate ourselves on the limit procedure and exploit the results established in Chapters 4 - 6, where we present the approximation and sequentially prove in full detail all the necessary estimates for the approximate problem. In particular, we refer to Chapter 4 for the introduction of the approximate problem and for the establishment of a weak maximum principle for the approximate solutions, to Chapter 5 for the derivation of oscillation decay estimates for the approximate solutions and to Chapter 6 for the proof of an appropriate bound for the „time discrete“ derivative of approximate solutions.

Furthermore, applying the results obtained in Chapter 7, we prove higher interior regularity of solutions to our central problem. And finally, a uniqueness result for the case of Dirichlet boundary conditions follows by an argument based on Gronwall's Lemma.

3.1 Weak Formulation of the Problem

Let us consider an open, bounded and connected domain $\Omega \subset \mathbb{R}^3$ representing the space occupied with the porous medium. We denote by $\partial\Omega$ the boundary of Ω and by $\Gamma_1 \subset \partial\Omega$ a closed two-dimensional Lipschitz manifold with positive bidimensional measure, representing that part of $\partial\Omega$ on which seepage is allowed.

Moreover, let $T > 0$ be a given time instant and set $Q := \Omega \times (0, T)$, $\Sigma_1 := \Gamma_1 \times (0, T)$.

We now transfer the Signorini boundary condition (1.6.2) into the functional analytic setting in the following way: For a given function $\tilde{P} \in L^2(0, T; H^1(\Omega))$, with

$$\gamma_0 \tilde{P} \geq 0 \quad \text{a.e. on } \Sigma_1,$$

where γ_0 is the trace operator $H^1(\Omega) \rightarrow H^{\frac{1}{2}}(\Omega)$, we introduce the following convex set of functions

$$K := \{v \in L^2(0, T; H^1(\Omega)) : (\gamma_0 v)^+ = \gamma_0 \tilde{P} \text{ a.e. on } \Sigma_1\}. \quad (3.1.1)$$

Therefore (1.6.2) turns into

$$\mathbf{k}(\nabla p + \rho g \hat{z}) \cdot \vec{\mathbf{n}}(u - \varphi) \leq 0, \quad \forall \varphi \in K$$

where we denote by $\vec{\mathbf{n}}$ the outward normal unit vector to Ω .

We now present the central problem of this thesis.

Problem 3.1.1 (Central Problem).

Let $a_0 \geq 0$, consider a space dependent Preisach operator \mathfrak{W} introduced in Definition 2.4.3, and let $p^0 \in L^2(\Omega)$, $\lambda : \Omega \rightarrow \Lambda$, and $\tilde{P} \in L^2(0, T; H^1(\Omega))$ be given.

We search for a function $p \in K \cap H^1(Q)$, with $\mathfrak{W}[\lambda, p] \in H^1(0, T; L^2(\Omega))$, such that

$$p(x, 0) = p^0(x) \quad \text{for a.a. } \Omega,$$

and setting $s := a_0 p + \mathfrak{W}[\lambda, p]$, the pair of functions (p, s) satisfy the following variational inequality

$$\iint_Q \left(\frac{\partial s}{\partial t} (p - v) + \mathbf{k}[s](\nabla p + \hat{z}) \nabla (p - v) \right) dx dt \leq 0, \quad \forall v \in K, \quad (3.1.2)$$

where \mathbf{k} represents the hydraulic conductivity my means of a superposition operator and $\hat{z} = (0, 0, 1)$.

The variational inequality (3.1.2) is a weak formulation of equation (1.5.4a) (where all the constants are assumed to be equal to 1) coupled with the Signorini condition (1.6.2).

3.2 Assumptions on the Data, the Domain Ω , and the Preisach Operator

In order to prove existence, regularity and uniqueness results, we pose the following general assumptions.

We start with hypotheses on the boundary data \tilde{P} .

Assumption 3.2.1 (Assumption on the boundary function). *Suppose that*

① *the function \tilde{P} possesses the following regularity*

$$\tilde{P} \in C^{\alpha, \frac{\alpha}{2}}(\bar{Q}) \cap H^1(0, T; H^1(\Omega)), \quad \dot{\tilde{P}} \in L^\infty(Q), \quad \gamma_0 \dot{\tilde{P}} \in L^\infty(\Sigma_1),$$

with some given $\alpha \in (0, 1)$, as well as

$$\tilde{P}(\cdot, 0) \in W^{1,4}(\Omega) \cap H^2(\Omega)$$

② *there exist $\Gamma'_1 \subset \Gamma_1$ a closed two-dimensional manifold with positive bidimensional measure such that $\tilde{P} > 0$ on $\text{int}\Gamma'_1 \times [0, T]$, and $\tilde{P} = 0$ on $(\Gamma_1 \setminus \Gamma'_1) \times [0, T]$.*

Hypothesis 3.2.1③ means that the set $\{x \in \text{int}\Gamma_1 : \tilde{P}(x) > 0\}$ does not change in time and is rather restrictive, for it prevents the basins from either increasing or decreasing. It will appear in Chapter 6 and will allow us to multiply the approximate equation by the (discretized) time derivative of the pressure, overcoming restrictions due to the Signorini-type boundary conditions. Unfortunately the structure of our proof does not allow us to lift this assumption at the moment.

In Chapter 5 we establish oscillation decay estimates for (approximate) solutions of Problem 3.1.1 deriving certain inequalities characterizing De Giorgi function classes (c.f. definitions in Section A.8). For these function classes it is well known, that their members are Hölder continuous up to the boundary, provided that they satisfy Neumann or Dirichlet type boundary conditions (and the boundary data is smooth enough). Unfortunately, we were not aware of any results concerning GLOBAL Hölder continuity up to the boundary of functions from De Giorgi classes if mixed boundary conditions are involved.

However, we found out that under the geometrical assumptions on the domain Ω , as stated below, we can still prove Hölder continuity for members of the De Giorgi function classes (for the detailed proof we refer to Section A.8).

In fact, Assumptions 3.2.2① and ② are standard assumptions if one deals with Dirichlet or Neumann boundary conditions respectively (see for instance [43, Chapter 2, §8]). Only assumption

3.2.2③ is a new one and arises from the appearance of mixed boundary conditions. It concerns the contact set between the different boundaries and requests that the boundary of Ω is not smooth at this contact set.

Assumption 3.2.2 (Assumptions of the Domain Ω). *Suppose that $\Omega \subset \mathbb{R}^3$ is an open, bounded, and convex domain of class $C^{0,1}$, such that for all $(x, y, z) \in \Omega$ $z \geq 0$ holds.*

Moreover, suppose with Γ_1 and Γ'_1 as in Assumption 3.2.1 that there positive constants $\varrho_0, \delta_1, \delta_2, \delta_3 \in (0, 1)$, such that

- ① *for all $x_0 \in \partial\Omega$ and any ball $B_\varrho(x_0)$ centered at x_0 with radius $0 < \varrho \leq \varrho_0$*

$$|\Omega \cap B_\varrho(x_0)| \geq \delta_2 |B_\varrho(x_0)|,$$

holds,

- ② *$\text{int}\Gamma_1$ possesses the positive geometrical density property (see Definition A.1.2), i.e. for all $x_0 \in \text{int}\Gamma_1$ and any ball $B_\varrho(x_0)$ centered at x_0 with radius $0 < \varrho \leq \varrho_0$,*

$$|\Omega \cap B_\varrho(x_0)| \leq (1 - \delta_1) |B_\varrho(x_0)|$$

holds,

- ③ *$\partial\Gamma_1$ and $\partial\Gamma'_1$ possess the special positive geometric density property (see Definition A.1.3), i.e.*

- (a) *there exist a $C^{0,1}$ domain $\tilde{\Omega}$ with the property that $\overline{\Omega} \subset \overline{\tilde{\Omega}}$ and $\overline{\partial\Omega} \setminus \overline{\Gamma_1} \subset \partial\tilde{\Omega}$, and that for any ball $B_\varrho(x_0)$ centered at $x_0 \in \partial\Gamma_1$ with radius $0 < \varrho \leq \varrho_0$, $\tilde{\Omega} \cap B_\varrho(x_0)$ is convex, and*

$$|\Omega \cap B_\varrho(x_0)| \leq \left| \tilde{\Omega} \cap B_\varrho(x_0) \right| - \delta_3 |B_\varrho(x_0)|$$

is satisfied.

- (b) *there exist a $C^{0,1}$ domain $\tilde{\Omega}'$ with the property that $\overline{\Omega} \subset \overline{\tilde{\Omega}'}$ and $\overline{\partial\Omega} \setminus \overline{\Gamma'_1} \subset \partial\tilde{\Omega}'$, and for any ball $B_\varrho(x_0)$ centered at $x_0 \in \partial\Gamma'_1$ with radius $0 < \varrho \leq \varrho_0$, $\tilde{\Omega}' \cap B_\varrho(x_0)$ is convex, and*

$$|\Omega \cap B_\varrho(x_0)| \leq \left| \tilde{\Omega}' \cap B_\varrho(x_0) \right| - \delta_3 |B_\varrho(x_0)|$$

is satisfied.

Fig. 3.1 shows an illustrative two-dimensional example of such a domain defined by

$$\Omega := \left\{ (x, y) \in \mathbb{R}^2 : |(x, y)| < 1 \right\} \cap \left\{ (x, y) \in \mathbb{R}^2 : y < \frac{1}{2}x^2 + \frac{1}{2} \right\} \cap \left\{ (x, y) \in \mathbb{R}^2 : y < -\frac{1}{2}x + \frac{1}{2} \right\},$$

with

$$\Gamma_1 := \left\{ (x, y) \in \mathbb{R}^2 : y = \frac{1}{2}x^2 + \frac{1}{2}, x \in [-1, 0] \right\} \cup \left\{ (x, y) \in \mathbb{R}^2 : y = -\frac{1}{2}x + \frac{1}{2}, x \in [0, 1] \right\},$$

$$\Gamma'_1 := \left\{ (x, y) \in \mathbb{R}^2 : y = \frac{1}{2}x^2 + \frac{1}{2}, x \in [-1, 0] \right\},$$

and

$$\partial\Gamma_1 := \{(-1, 0), (1, 0)\}, \quad \partial\Gamma'_1 := \left\{ (-1, 0), \left(\frac{1}{2}, 0 \right) \right\}$$

Clearly, Ω is convex and of class $C^{0,1}$, thus satisfies Assumptions 3.2.2 ① and ②. Moreover, we

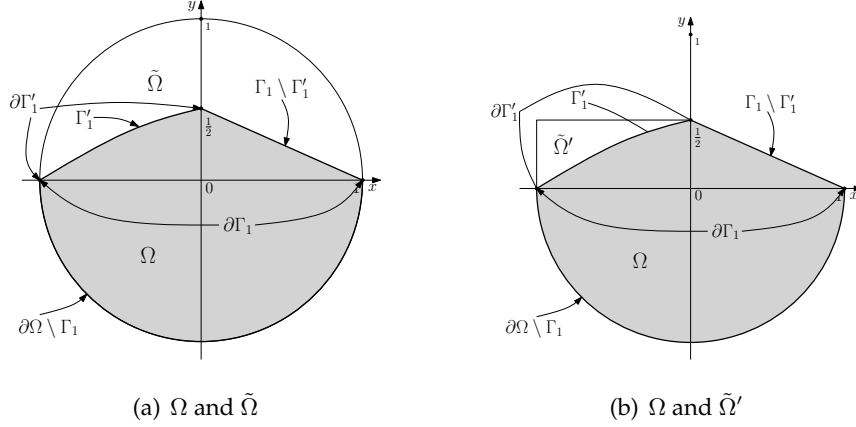

Figure 3.1: 2-dimensional example of an admissible set Ω

can choose

$$\tilde{\Omega} = \{(x, y) \in \mathbb{R}^2 : |(x, y)| < 1\}, \quad \text{with} \quad \partial\tilde{\Omega} = \{(x, y) \in \mathbb{R}^2 : |(x, y)| = 1\},$$

and

$$\begin{aligned} \tilde{\Omega}' = \{(x, y) \in \mathbb{R}^2 : |(x, y)| < 1\} \cap \left\{ (x, y) \in \mathbb{R}^2 : y < -\frac{1}{2}x + \frac{1}{2} \right\} \\ \cap \left\{ (x, y) \in \mathbb{R}^2 : x > -1 \right\} \cap \left\{ (x, y) \in \mathbb{R}^2 : y < \frac{1}{2} \right\} \end{aligned}$$

with

$$\partial\tilde{\Omega}' = (\partial\Omega \setminus \Gamma'_1) \cup \left\{ (-1, y) \in \mathbb{R}^2 : y \in \left[0, \frac{1}{2}\right] \right\} \cup \left\{ \left(x, \frac{1}{2}\right) \in \mathbb{R}^2 : x \in [-1, 0] \right\}.$$

Then we find that for any $0 < \varrho \leq 1$ and $x_0 \in \partial\Gamma_1$

$$|\Omega \cap B_\varrho(x_0)| \leq \left| \tilde{\Omega} \cap B_\varrho(x_0) \right| - \frac{1}{24} |B_\varrho(x_0)|,$$

is satisfied and for any $0 < \varrho \leq 1$ and $x_0 \in \partial\Gamma'_1$

$$|\Omega \cap B_\varrho(x_0)| \leq \left| \tilde{\Omega}' \cap B_\varrho(x_0) \right| - \frac{3}{100} |B_\varrho(x_0)|,$$

holds. Thus Ω fulfills condition 3.2.2 ③ with the choice $\delta_3 = \frac{3}{100}$.

We proceed with hypotheses on the Preisach operator \mathfrak{W} .

Assumption 3.2.3 (Assumptions on the Preisach operator). *Suppose that the Preisach density function ψ satisfies Assumptions 2.3.6 and 2.3.10. Moreover, with*

$$\partial Q := \partial\Omega \times (0, T) \cup \Omega \times \{0\},$$

and \tilde{P} as in Assumption 3.2.1, let the nonnegative number \bar{R} be defined as

$$\bar{R} := \sup_{\partial Q} \tilde{P} + \sup_{(x,y,z) \in \Omega} z.$$

Let $\underline{s}, \bar{s} \in (0, 1)$ with $\underline{s} \leq \bar{s}$ and $a_0 > 0$ be given and assume that the Preisach operator \mathfrak{W} defined according to Definition 2.4.3 and corresponding to the density function ψ satisfies the following:

For $\lambda : \Omega \rightarrow \Lambda_{\bar{R}}$ and an input $u \in L^\infty(Q)$ with $|u| \leq \bar{R}$ a.e. in Q there exist numbers $\underline{\mathfrak{W}}, \overline{\mathfrak{W}}$ satisfying

$$\underline{s} \leq -a_0 \bar{R} + \underline{\mathfrak{W}}, \quad a_0 \bar{R} + \overline{\mathfrak{W}} \leq \bar{s}, \quad \text{and}$$

$$\underline{\mathfrak{W}} \leq \mathfrak{W}[\lambda, u] \leq \overline{\mathfrak{W}} \quad \text{a.e. in } \Omega \text{ for a.a. } t \in [0, T].$$

The number \bar{s} can be interpreted as the residual water content and $1 - \underline{s}$ can be understood as the residual air content (c.f. Section 1.3) and therefore Assumption 3.2.3 allows us to conclude that for appropriately bounded pressure the saturation remains inside $[\underline{s}, \bar{s}]$.

The inclusion of the additional term $a_0 \text{id}$ to the s vs. p relation is a technical one and appears in Chapter 4-7 allowing for the derivation of appropriate estimates. The resulting operator is still rate-independent and thus a hysteresis operator in the sense of the definitions from Chapter 2.

Next, we pose some assumptions on the hydraulic conductivity \mathbf{k} .

Assumption 3.2.4 (Structural assumptions on \mathbf{k}).

Let \mathbf{k} be a superposition operator generated by a nonnegative, nondecreasing, Lipschitz continuous function $k : \mathbb{R} \rightarrow \mathbb{R}$

$$\mathbf{k}[s](x, t) = k(s(x, t)). \quad (3.2.1)$$

Moreover, with the numbers $0 < \underline{s} < \bar{s} < 1$ from Assumption 3.2.3, suppose that there exist numbers $0 < \underline{k} \leq \bar{k}$ such that k satisfies

$$0 < \underline{k} \leq k(s) \leq \bar{k} \quad \text{for all } s \in [\underline{s}, \bar{s}].$$

And finally we pose the following hypotheses on the initial value p^0 and the initial configuration λ .

Assumption 3.2.5 (Assumptions on initial data). Let \tilde{P} be as in Assumption 3.2.1, $\lambda : \Omega \rightarrow \Lambda_{\bar{R}}$ with \bar{R} as in Assumption 3.2.3, and suppose that the initial value p^0 satisfies $p^0(\cdot) = \tilde{P}(\cdot, 0)$ and belongs to the elliptic De Giorgi Class $\check{\mathcal{B}}_2(\bar{\Omega}, M, \gamma)$ (c.f. Definition A.8.2) and that for a.a. $x \in \Gamma_1$ p^0 satisfies

$$\mathbf{k}(a_0 p^0 + \mathfrak{W}[\lambda, p^0])(\nabla p^0 + \hat{z}) \cdot \vec{\mathbf{n}}(p^0 - v) \leq 0 \quad \forall v : \Gamma_1 \rightarrow \mathbb{R}, \text{ s.t. } v^+ = \tilde{P}(x, 0)$$

with \mathfrak{W} as in Assumption 3.2.3. Moreover we assume that

$$\sup_{x \in \Omega} \int_0^{\bar{R}} \beta(r) |\nabla \lambda(x, r)| dr, \quad \int_0^{\bar{R}} \langle \lambda(\cdot, r) \rangle_{\alpha, \Omega} \beta(r) dr < \infty$$

where $\langle \cdot \rangle_{\alpha, \Omega}$ stands for the Hölder seminorm as in (A.2.1) and $\beta(r)$ is as in Assumption 2.3.6.

The assumption on p^0 indicates that p^0 satisfies the „elliptic“ version of the Signorini boundary condition (1.6.2) and will allow us to estimate the initial values of the incremental time ratio of approximate solutions in Chapter 6. The hypothesis on λ will appear in Chapters 5 and 6 and enables us to conclude that for Hölder continuous inputs also the output of the Preisach operator is Hölder continuous on the one hand, and also allows for the derivation of an appropriate estimate of the initial values of the incremental time ratio of approximate solutions in Chapter 6 on the other hand.

3.3 Main Results

We now present the central results from this thesis together with their proof and start with the following theorem concerning the existence of solutions to Problem 3.1.1.

Theorem 3.3.1 (Existence). Let Assumptions 3.2.1 - 3.2.5 be satisfied. Let \bar{R} be as in Assumption 3.2.3, $\lambda : \Omega \rightarrow \Lambda_{\bar{R}}$, and $p^0(\cdot) = \tilde{P}(\cdot, 0)$, with \tilde{P} as in Assumption 3.2.1.

Then Problem 3.1.1 admits at least one solution p with the following regularity

$$p \in W^{1, \infty}(0, T; L^2(\Omega)) \cap H^1(0, T; H^1(\Omega)) \cap C^{\alpha, \frac{\alpha}{4}}(\bar{Q}),$$

with some $\alpha \in (0, 1)$, satisfying in addition $\|p\|_{L^\infty(Q)} \leq \bar{R}$ with \bar{R} as in Assumption 3.2.3. Moreover, the function s defined by $s = a_0 p + \mathfrak{W}[\lambda, p]$, where \mathfrak{W} represents the space dependent Preisach operator as in Definition 2.4.3, satisfies

$$s \in W^{1, \infty}(0, T; L^2(\Omega)) \cap H^1(Q) \cap C^{\alpha, \frac{\alpha}{4}}(\bar{Q}).$$

Proof: The proof of this theorem is based on Rothe’s scheme. For this aim, let $m \in \mathbb{N}$ and $h := T/m$. Moreover, we assume that with the constants θ as in Lemma A.8.9 and \bar{R} as in Assumption 3.2.3

$$h \leq \min \left\{ \frac{1}{4\bar{R}}; \theta^2; \theta^{-\frac{2}{3}}; \frac{1}{36} \right\},$$

holds. This assumption is not restrictive, as we intend to pass to the limit as $h \rightarrow 0$. Then, according to Corollary 4.1.3 there exist sequences $\{p_m^n\}_{n \in \{1, \dots, m\}}$ and $\{w_m^n\}_{n \in \{1, \dots, m\}}$ satisfying for all $n \in \{1, \dots, m\}$ the following variational inequality

$$\int_{\Omega} \left(\frac{s_m^n - s_m^{n-1}}{h} (p_m^n - v) + k_m^{n-1} (\nabla p_m^n + \hat{z}) \cdot \nabla (p_m^n - v) \right) dx \leq 0, \quad \forall v \in K_m^n, \quad (3.3.1)$$

where we set for all $n \in \{0, \dots, m\}$

$$s_m^n := a_0 p_m^n + w_m^n, \quad k_m^n := k(s_m^n),$$

and where the sets K_m^n are defined for $n \in \{0, \dots, m\}$ in the following way

$$K_m^n := \{v \in H^1(\Omega) : \gamma_0 v^+ = \tilde{P}(\cdot, nh) \text{ a.e. on } \Gamma_1\} \quad \text{for } n = 1, \dots, m.$$

For any given sequence $\{u_m^n\}_{n \in \{0, \dots, m\}}$ we define its the piecewise constant and piecewise linear time interpolates according to the following schemes:

$$\begin{aligned} \bar{u}_+^h(x, t) &:= u_m^n(x), & \bar{u}_-^h(x, t) &:= u_m^{n-1}(x), \\ \hat{u}_h(x, t) &:= u_m^{n-1}(x) + \frac{t - (n-1)h}{h} (u_m^n(x) - u_m^{n-1}(x)) \end{aligned} \quad (3.3.2)$$

for each $x \in \Omega$ and $t \in [(n-1)h, nh)$, $n = 1, \dots, m$, continuously extended to $t = T$.

By construction of the sequences $\{p_m^n\}_{n \in \{1, \dots, m\}}$ and $\{w_m^n\}_{n \in \{1, \dots, m\}}$ (c.f. Problem 4.1.1), we have that

$$\bar{w}_+^h = \mathfrak{W}[\lambda, \bar{p}_+^h], \quad \bar{w}_-^h = \mathfrak{W}[\lambda, \bar{p}_-^h]$$

hold, where \bar{p}_\pm^h and \bar{w}_\pm^h are defined according to the scheme (3.3.2) and where \mathfrak{W} is the space dependent Preisach operator from Definition 2.4.3 acting on $L^2(\Omega; G_+(0, T))$. Thus, from (3.3.1) we find that the following inequality

$$\int_{\Omega} \frac{\partial}{\partial t} \hat{s}_h(\bar{p}_+^h - \bar{v}_+^h) + k(\bar{s}_-^h) (\nabla \bar{p}_+^h + \hat{z}) \cdot \nabla (\bar{p}_+^h - \bar{v}_+^h) dx \leq 0 \quad (3.3.3)$$

holds for all \bar{v}_+^h being the constant time interpolate of a sequence $v_m^1 \in K_m^1, \dots, v_m^m \in K_m^m$ a.e. in (h, T) .

As a consequence of the estimates obtained in Propositions 4.2.1, 4.3.1, 5.4.1, 6.3.1, and 6.4.1 we derive the following bounds

$$\begin{aligned} \|\hat{p}_h\|_{W^{1, \infty}(0, T; L^2(\Omega)) \cap H^1(0, T; H^1(\Omega)) \cap C^{\alpha, \frac{\alpha}{4}}(\bar{Q})} &\leq C, \\ \|\hat{s}_h\|_{W^{1, \infty}(0, T; L^2(\Omega)) \cap H^1(Q) \cap C^{\alpha, \frac{\alpha}{4}}(\bar{Q})} &\leq C, \end{aligned}$$

where the constant C is independent of h . Moreover, due to Proposition 4.2.1 $\|\hat{p}_h\|_{L^\infty(Q)} \leq \bar{R}$ holds with \bar{R} as in Assumption 3.2.3. Therefore, by virtue of Theorem A.2.3 and Proposition A.2.2 there exist functions

$$p \in W^{1, \infty}(0, T; L^2(\Omega)) \cap H^1(0, T; H^1(\Omega)) \cap C^{\alpha, \frac{\alpha}{4}}(\bar{Q}),$$

$$s \in W^{1,\infty}(0, T; L^2(\Omega)) \cap H^1(Q) \cap C^{\alpha, \frac{\alpha}{4}}(\bar{Q}),$$

with $\|p\|_{L^\infty(Q)} \leq \bar{R}$, such that passing to the limit as $h \rightarrow 0$ along a subsequence

$$(\hat{p}_h, \hat{s}_h) \rightarrow (p, s) \quad \text{uniformly in } (C(\bar{Q}))^2, \quad (3.3.4a)$$

$$\hat{p}_h \rightarrow p \quad \text{weakly in } H^1(0, T; H^1(\Omega)), \quad (3.3.4b)$$

$$\hat{s}_h \rightarrow s \quad \text{weakly in } H^1(Q), \quad (3.3.4c)$$

$$\left(\frac{\partial}{\partial t} \hat{p}_h, \frac{\partial}{\partial t} \hat{s}_h \right) \rightarrow \left(\frac{\partial}{\partial t} p, \frac{\partial}{\partial t} s \right) \quad \text{weakly star in } (L^\infty(0, T; L^2(\Omega)))^2. \quad (3.3.4d)$$

As a consequence of Theorem A.2.4 and estimates (3.3.4b) and (3.3.4c)

$$(\hat{p}_h, \hat{p}_h) \rightarrow (p, p) \quad \text{strongly in } (L^2(\Omega; C([0, T])))^2$$

as $h \rightarrow 0$ along a further subsequence if necessary. Furthermore, for every $m \in \mathbb{N}$ and every $(x, t) \in Q$

$$\begin{aligned} \left| \hat{p}_h(x, t) - \bar{p}_\pm^h(x, t) \right|^2 &\leq \max_{n \in \{1, \dots, m\}} |p_m^n(x) - p_m^{n-1}(x)|^2 \leq \sum_{n=1}^m |p_m^n(x) - p_m^{n-1}(x)|^2, \\ \left| \hat{s}_h(x, t) - \bar{s}_\pm^h(x, t) \right|^2 &\leq \max_{n \in \{1, \dots, m\}} |s_m^n(x) - s_m^{n-1}(x)|^2 \leq \sum_{n=1}^m |s_m^n(x) - s_m^{n-1}(x)|^2 \end{aligned}$$

holds and similarly

$$\left| \nabla \hat{p}_h(x, t) - \nabla \bar{p}_\pm^h(x, t) \right|^2 \leq \max_n |\nabla p_m^n(x) - \nabla p_m^{n-1}(x)|^2 \leq \sum_{n=1}^m |\nabla p_m^n(x) - \nabla p_m^{n-1}(x)|^2$$

is satisfied. Moreover, Proposition 5.4.1 yields

$$\left| \hat{s}_h(x, t) - \bar{s}_\pm^h(x, t) \right| \leq \max_n |s_m^n(x) - s_m^{n-1}(x)| \leq \mu_2 h^{\frac{\alpha}{4}}$$

with the constants μ_2 and α as in Proposition 5.4.1. Hence,

$$\left\| \hat{p}_h - \bar{p}_\pm^h \right\|_{L^2(\Omega; G_+(0, T))} + \left\| \hat{s}_h - \bar{s}_\pm^h \right\|_{L^2(\Omega; G_+(0, T))} + \left\| \nabla \hat{p}_h - \nabla \bar{p}_\pm^h \right\|_{L^2(Q)} + \left\| \hat{s}_h - \bar{s}_\pm^h \right\|_{L^\infty(Q)} \leq Ch^{\frac{\alpha}{4}}.$$

Consequently, \bar{p}_\pm^h converges to p strongly in $L^2(\Omega; G_+(0, T))$, $\nabla \bar{p}_\pm^h$ converges to ∇p weakly in $L^2(Q)$, and \bar{s}_\pm^h converges to s strongly in $L^2(\Omega; G_+(0, T)) \cap L^\infty(Q)$ as $h \rightarrow 0$. Making use of the continuity of the operator \mathfrak{W} on the space $L^2(\Omega; G_+(0, T))$, we find passing to the limit as $h \rightarrow 0$

$$\bar{s}_\pm^h \rightarrow s = a_0 p + \mathfrak{W}[\lambda, p] \quad \text{strongly in } L^2(\Omega; G_+(0, T)) \cap L^\infty(Q).$$

As a consequence

$$\liminf_{h \rightarrow 0} \iint_Q \frac{\partial}{\partial t} \hat{s}_h (\bar{p}_+^h - \bar{v}_+^h) dx dt \geq \iint_Q \frac{\partial}{\partial t} s (p - v) dx dt$$

follows. Moreover, the continuity of k yields, that

$$k(\bar{s}_-^h) \rightarrow k(s) \quad \text{strongly in } L^\infty(Q)$$

as $h \rightarrow 0$. Therefore, with the help of Proposition 4.3.1 we infer

$$\int_Q \left| (k(\bar{s}_-^h) - k(s)) \right| \left| \nabla \bar{p}_+^h \right|^2 dx dt \leq \mu_1 \left\| k(\bar{s}_-^h) - k(s) \right\|_{L^\infty(Q)} \rightarrow 0,$$

with μ_1 as in Proposition 4.3.1. For this reason (and extracting a further subsequence if necessary) we conclude

$$\liminf_{h \rightarrow 0} \iint_Q k(\bar{s}_-^h) \left| \nabla \bar{p}_+^h \right|^2 dx dt \geq \iint_Q k(s) |\nabla p|^2 dx dt.$$

Integrating (3.3.3) in time and passing to the \liminf as $h \rightarrow 0$ along a suitable subsequence, we then get (3.1.2) and the proof is complete. \square

Let us now study additional regularity of solutions to Problem 3.1.1 and prove the following theorem.

Theorem 3.3.2 (Interior Regularity). *Suppose that the hypotheses of Theorem 3.3.1 hold and let $\beta \in L_{loc}^1(0, \infty)$ be as in Assumption 2.3.6, \bar{R} be as in Assumption 3.2.3, $\lambda : \Omega \rightarrow \Lambda_{\bar{R}}$, and suppose that in addition*

$$\nabla \lambda \in L^{\frac{20}{3}}(\Omega \times (0, \bar{R})), \quad \text{and} \quad \beta \in L_{loc}^{\frac{20}{17}}(0, \infty)$$

hold. Then every solution p of Problem 3.1.1 possesses the following additional regularity

$$\nabla p, \frac{\partial}{\partial t} p \in L_{loc}^\infty(Q).$$

Proof: Since by assumption the hypotheses of Theorem 3.3.1 hold, there exist a solution p of Problem 3.1.1 such that

$$p \in W^{1,\infty}(0, T; L^2(\Omega)) \cap H^1(0, T; H^1(\Omega)) \cap C^{\alpha, \frac{\alpha}{4}}(\bar{Q})$$

with some $\alpha \in (0, 1)$. Moreover, the function s defined by $s = a_0 p + \mathfrak{W}[\lambda, p]$, where \mathfrak{W} denotes the space dependent Preisach operator as in Definition 2.4.3, satisfies

$$s \in W^{1,\infty}(0, T; L^2(\Omega)) \cap H^1(Q) \cap C^{\alpha, \frac{\alpha}{4}}(\bar{Q}).$$

Therefore, we find by virtue of interpolation (c.f. Proposition A.6.1)

$$\frac{\partial}{\partial t} p, \frac{\partial}{\partial t} s \in L^{\frac{10}{3}}(Q).$$

Thus, the Lipschitz-continuity of k and application of Proposition 7.1.4 with the choice $q = \frac{10}{3}$ yield

$$\nabla p \in L_{loc}^{\frac{20}{3}}(Q).$$

Observing that the requirements of Proposition 7.2.1 are met, we infer with the help of Proposition 7.2.1

$$\frac{\partial}{\partial t} p \in L_{loc}^{\infty}(Q).$$

This, together with the piecewise Lipschitz-continuity of \mathfrak{W} and the Lipschitz-continuity of \mathbf{k} imply in turn that the conditions of Proposition 7.1.4 hold for any $q \geq 0$, and consequently Proposition 7.1.4 yields

$$\nabla p \in L_{loc}^{\frac{34}{3}}(Q).$$

Furthermore, making use of Proposition 2.4.6 we obtain

$$\nabla s \in L_{loc}^{\frac{20}{3}}(Q),$$

and consequently the continuity of \mathbf{k} together with Proposition 7.3.1 implies

$$\nabla p \in L_{loc}^{\infty}(Q),$$

and the proof is complete. \square

Finally, as mentioned in the chapter introduction, we now deal with the Richards equation (1.5.4a) coupled with Dirichlet boundary conditions. In the physical context this corresponds to the case when the pressure on the whole boundary of the domain Ω is prescribed, i.e. the whole in-/outflow is known in advance. From the mathematical point of view, this model is less interesting than the one with mixed boundary conditions, nevertheless we present a (shortened) existence- and uniqueness proof also for this problem, since the techniques applied are instructive and could be used for other problems described by a parabolic PDE with hysteresis.

We first present the weak formulation of (1.5.4a), coupled with Dirichlet boundary conditions.

Problem 3.3.3 (Problem with Dirichlet boundary conditions). *Let $a_0 \geq 0$. Consider a space dependent Preisach operator \mathfrak{W} introduced in Definition 2.4.3, and let $p^0 \in L^2(\Omega)$, $\lambda : \Omega \rightarrow \Lambda$, and $\tilde{P} \in L^2(0, T; H^1(\Omega))$ be given.*

We search for a function $p \in H^1(Q)$, with $\mathfrak{W}[\lambda, p] \in H^1(0, T; L^2(\Omega))$, such that

$$p(x, 0) = p^0(x) \text{ a.e. in } \Omega, \quad \gamma_0 p = \gamma_0 \tilde{P} \text{ a.e. on } \partial\Omega \times (0, T),$$

where γ_0 denotes the Trace-Operator, and setting $s := a_0 p + \mathfrak{W}[\lambda, p]$ the pair of functions (p, s) satisfy the following variational inequality

$$\iint_Q \left(\frac{\partial s}{\partial t} (p - v) + \mathbf{k}[s](\nabla p + \hat{z}) \nabla (p - v) \right) dx dt \leq 0, \quad (3.3.5)$$

for all $v \in L^2(0, T; H^1(\Omega))$ with $\gamma_0 v = \gamma_0 \tilde{P}$ a.e. on $\partial\Omega \times (0, T)$ and where \mathbf{k} is a superposition operator and $\hat{z} = (0, 0, 1)$.

For this problem we have the following result.

Theorem 3.3.4 (Existence and Uniqueness in the case of Dirichlet boundary). *Let Assumptions 3.2.1, 3.2.2(①, ②), 3.2.3, 3.2.4, and 3.2.5 be satisfied. Let \bar{R} be as in Assumption 3.2.3, $\lambda : \Omega \rightarrow \Lambda_{\bar{R}}$, and $p^0(\cdot) = \tilde{P}(\cdot, 0)$, with \tilde{P} as in Assumption 3.2.1.*

Then Problem 3.3.3 admits a solution p , with the following regularity

$$p \in W^{1,\infty}(0, T; L^2(\Omega)) \cap H^1(0, T; H^1(\Omega)) \cap C^{\alpha, \frac{\alpha}{4}}(\bar{Q}),$$

satisfying in addition $\|p\|_{L^\infty(Q)} \leq \bar{R}$ with \bar{R} as in Assumption 3.2.3. Moreover, if $\nabla \tilde{P} \in L^\infty(Q)$, and $\gamma_0 \nabla \tilde{P} \in L^\infty(\partial Q)$, then

$$\nabla p, \frac{\partial}{\partial t} p \in L^\infty(Q).$$

And finally, if

$$A_{\bar{R}} := \inf_{\substack{r < \bar{R}, \\ |z| \leq 2\bar{R}}} \psi(r, z) > 0,$$

then the solution p of Problem 3.3.3 is unique.

Proof: The existence of solutions to Problem 3.3.3 can be proven in the same way, as it has been done in Theorem 3.3.1, namely:

- ① In fact, the results from Chapter 4 hold, without any modifications of the proofs presented therein.
- ② Moreover, inequalities (5.1.2), (5.2.1) hold for any levels subject to the conditions

$$a \geq \sup_{Q(\rho, \tau) \cap Q} \bar{u}_m - 2\bar{R}, \quad a \geq \sup_{Q(\rho, \tau) \cap \Omega \times \{0\}} \bar{u}_m, \quad \text{and} \quad a \geq \sup_{Q(\rho, \tau) \cap \partial\Omega \times (0, T)} \gamma_0 \bar{u}_m, \quad (3.3.6)$$

and inequality (5.3.1) holds for any level a subject to

$$a \geq \sup_{B_\rho(x_0) \cap \Omega} u_m^n - 2\bar{R}, \quad \text{and} \quad a \geq \sup_{B_\rho(x_0) \cap \partial\Omega} \pm \gamma_0 u_m^n \quad (3.3.7)$$

where $u_m^n = \pm p_m^n$, $\bar{u}_m = \pm \bar{p}_m$, and \bar{p}_m is the constant time interpolate of the sequence of approximate solutions $\{p_m^n\}_{n \in \{0, \dots, m\}}$. Then, the statement of Proposition 5.4.1 follows directly by virtue of Assumption 3.2.1, Assumption 3.2.2 ① and ②, and the main result of [34].

- ③ Finally, Propositions 6.2.1 and 6.3.1 can be proven in exactly the same way as it has been done in Chapter 6.
- ④ Repeating the arguments of the proof of Theorem 3.3.1, it follows that Problem 3.3.3 admits a solution with the desired regularity.

Let us now briefly outline, how one can show that *all partial derivatives of our solution p are globally bounded*.

By a classical flattening argument presented for instance in [7, Sections 5.4 and 5.5], one can assume, that the cylinder $Q_0 \subseteq Q$ in Section 7.1 can also be chosen such that $\overline{Q_0} \cap \overline{Q} \neq \emptyset$. Then, making use of the assumption, that $\nabla p^0 = \nabla \tilde{P}(\cdot, 0) \in L^\infty(\Omega)$ and of $\nabla \tilde{P} \in L^\infty(Q)$, we extend the results obtained in Propositions 7.1.4, 7.2.1 and 7.3.1 to the whole space-time cylinder Q . Thus, following the proof of Theorem 3.3.2 we obtain

$$\nabla p, \frac{\partial}{\partial t} p \in L^\infty(Q).$$

Finally, we show that the solution of Problem 3.3.3 is unique.

For this aim, let p_1 and p_2 be two solutions of Problem 3.3.3 and for $i = 1, 2$ we set $s_i = a_0 p_i + \mathfrak{W}[\lambda, p_i]$, where \mathfrak{W} is as in Definition 2.4.3. Thus, we obtain from (3.3.5)

$$\iint_Q \left(\frac{\partial s_1}{\partial t} (p_1 - v_1) + \mathbf{k}[s_1](\nabla p_1 + \hat{z}) \nabla (p_1 - v_1) \right) dx dt \leq 0,$$

and

$$\iint_Q \left(\frac{\partial s_2}{\partial t} (p_2 - v_2) + \mathbf{k}[s_2](\nabla p_2 + \hat{z}) \nabla (p_2 - v_2) \right) dx dt \leq 0,$$

for all v_i with $\gamma_0 v_i = \tilde{P}$ a.e. on $\partial\Omega \times (0, T)$. For an arbitrary $t_0 \in (0, T]$ we define the sequence $\{\chi_n\}_{n \in \mathbb{N}} \subset L^\infty(\mathbb{R})$ as

$$\chi_n(t) = \begin{cases} 0, & \text{if } t \leq 0, \\ nt, & \text{if } 0 \leq t \leq \frac{1}{n}, \\ 1, & \text{if } \frac{1}{n} \leq t \leq t_0 - \frac{1}{n}, \\ n(t_0 - t), & \text{if } t_0 - \frac{1}{n} \leq t \leq t_0, \\ 0, & \text{if } t \geq t_0, \end{cases}$$

and choose $v_1 = p_1 - (p_1 - p_2)\chi_n$ and $v_2 = p_2 + (p_1 - p_2)\chi_n$. Adding the corresponding inequalities we infer

$$\begin{aligned} & \iint_Q \left(\left[\frac{\partial s_1}{\partial t} - \frac{\partial s_2}{\partial t} \right] (p_1 - p_2) \chi_n \right. \\ & \quad \left. + \mathbf{k}[s_1](\nabla p_1 + \hat{z}) \nabla (p_1 - p_2) \chi_n - \mathbf{k}[s_2](\nabla p_2 + \hat{z}) \nabla (p_1 - p_2) \chi_n \right) dx dt \leq 0. \end{aligned}$$

As χ_n converges weakly* in $L^\infty(\mathbb{R})$ to the characteristic function of the interval $[0, t_0]$, we can pass to the limit as $n \rightarrow \infty$ and obtain

$$\begin{aligned} & \int_0^{t_0} \int_\Omega \left(\left[\frac{\partial s_1}{\partial t} - \frac{\partial s_2}{\partial t} \right] (p_1 - p_2) \right. \\ & \quad \left. + \mathbf{k}[s_1](\nabla p_1 + \hat{z}) \nabla (p_1 - p_2) - \mathbf{k}[s_2](\nabla p_2 + \hat{z}) \nabla (p_1 - p_2) \right) dx dt \leq 0. \end{aligned}$$

For $r > 0$ and all $(x, t) \in Q$ we put

$$\xi_r^i(x, t) := \wp_r[\lambda(x), p_i(x, \cdot)](t), \quad i = 1, 2,$$

with the play operator \wp_r as in Definition 2.2.8.

Let g be the generating function of our Preisach operator as in (2.3.8) corresponding to the density function ψ . As in [18], we obtain a.e. in Q the following estimate

$$\begin{aligned} \frac{\partial}{\partial t}(g(r, \xi_r^1) - g(r, \xi_r^2))(p_1 - p_2) &\geq \frac{\partial \xi_r^2}{\partial t}(\xi_r^1 - \xi_r^2)(\psi(r, \xi_r^1) - \psi(r, \xi_r^2)) \\ &\quad + \frac{1}{2} \frac{\partial}{\partial t} \left(\psi(r, \xi_r^1) |\xi_r^1 - \xi_r^2|^2 \right) - \frac{1}{2} \frac{\partial \xi_r^1}{\partial t} \frac{\partial \psi}{\partial t}(r, \xi_r^1) |\xi_r^1 - \xi_r^2|^2. \end{aligned}$$

As a consequence of the piecewise Lipschitz-property of the play operator and with the help of $\frac{\partial}{\partial t} p_i \in L^\infty(Q)$ there exists a constant $C > 0$ such that

$$\left| \frac{\partial \xi_r^i}{\partial t} \right| \leq \left| \frac{\partial}{\partial t} p_i \right| \leq C$$

holds a.e. in Q . Thus, making use of Assumptions 2.3.6 and 2.3.10 on the Preisach density ψ , there exists another constant, still denoted by C , such that for all $r \leq \bar{R}$

$$\frac{\partial}{\partial t}(g(r, \xi_r^1) - g(r, \xi_r^2))(p_1 - p_2) \geq \frac{1}{2} \frac{\partial}{\partial t} \left(\psi(r, \xi_r^1) |\xi_r^1 - \xi_r^2|^2 \right) - C |\xi_r^1 - \xi_r^2|^2$$

is satisfied a.e. in Q . Recalling that $\|p\|_{L^\infty(Q)} \leq \bar{R}$ and $\Lambda : \Omega \rightarrow \Lambda_{\bar{R}}$ hold, Proposition 2.2.10 yields $\xi_r^1, \xi_r^2 = 0$ for $r > \bar{R}$ a.e. in Ω for a.a. $t \in [0, T]$, and therefore, by virtue of $\psi(r, v) \geq A_{\bar{R}} > 0$ we find

$$\begin{aligned} &\int_0^{t_0} \int_\Omega \left[\frac{\partial s_1}{\partial t} - \frac{\partial s_2}{\partial t} \right] (p_1 - p_2) \\ &\quad \geq \frac{a_0}{2} \|p_1(\cdot, t_0) - p_2(\cdot, t_0)\|_{L^2(\Omega)}^2 + \frac{A_{\bar{R}}}{2} \int_0^{\bar{R}} \|\xi_r^1(\cdot, t_0) - \xi_r^2(\cdot, t_0)\|_{L^2(\Omega)}^2 \\ &\quad \quad - C \int_0^{t_0} \int_0^{\bar{R}} \|\xi_r^1(\cdot, t) - \xi_r^2(\cdot, t)\|_{L^2(\Omega)}^2 dr dt. \quad (3.3.8) \end{aligned}$$

On the other hand, Young's inequality, the boundedness and Lipschitz continuity of \mathbf{k} , and $\nabla p \in L^\infty(Q)$ yield, that there exists another constant, again denoted by C , such that

$$\begin{aligned} &\int_0^{t_0} \int_\Omega \mathbf{k}[s_1](\nabla p_1 + \hat{z}) \nabla(p_1 - p_2) - \mathbf{k}[s_2](\nabla p_2 + \hat{z}) \nabla(p_1 - p_2) dx dt \\ &\quad \geq \underline{k} \int_0^{t_0} \|\nabla p_1(\cdot, t) - \nabla p_2(\cdot, t)\|_{L^2(\Omega)}^2 dt - \int_0^{t_0} \int_\Omega L_k |s_1 - s_2| |\nabla p_2 + \hat{z}| |\nabla p_1 - \nabla p_2| dx dt \\ &\quad \geq \frac{k}{2} \int_0^{t_0} \|\nabla p_1(\cdot, t) - \nabla p_2(\cdot, t)\|_{L^2(\Omega)}^2 dt - C \int_0^{t_0} \int_\Omega |s_1 - s_2|^2 dx dt. \quad (3.3.9) \end{aligned}$$

Moreover, similarly to [18, inequality (5.6)], we obtain making use of Taylor's theorem and of the assumption $\partial_z \psi(r, z) \in L_{loc}^\infty(0, \infty)$ (c.f. Assumption 2.3.10) that there exists again another constant

$C > 0$, such that for all $r \leq \bar{R}$ the following inequality

$$|g(r, \xi_r^1) - g(r, \xi_r^2)| \leq C \left(A_{\bar{R}} + \bar{R} \sup_{\substack{r < \bar{R}, \\ |z| \leq 2\bar{R}}} \partial_z \psi(r, z) \right) |(\xi_r^1 - \xi_r^2)|$$

is satisfied a.e. in Q . Then, Hölder's inequality yields

$$\begin{aligned} |s_1 - s_2|^2 &\leq 2a_0 |p_1 - p_2|^2 + 2 \left(\int_0^{\bar{R}} |g(r, \xi_r^1) - g(r, \xi_r^2)| \, dr \right)^2 \\ &\leq 2a_0 |p_1 - p_2|^2 + C \int_0^{\bar{R}} |\xi_r^1 - \xi_r^2|^2 \, dr \end{aligned}$$

with another nonnegative constant C . Assembling the estimates it follows

$$\begin{aligned} \|p_1(\cdot, t_0) - p_2(\cdot, t_0)\|_{L^2(\Omega)}^2 &+ \int_0^{\bar{R}} \|\xi_r^1(\cdot, t_0) - \xi_r^2(\cdot, t_0)\|_{L^2(\Omega)}^2 \\ &\leq \int_0^{t_0} \|p_1(\cdot, t) - p_2(\cdot, t)\|_{L^2(\Omega)}^2 + \int_0^{\bar{R}} \|\xi_r^1(\cdot, t) - \xi_r^2(\cdot, t)\|_{L^2(\Omega)}^2 \, dr \, dt, \end{aligned}$$

and hence, application of Gronwall's inequality (A.10.1) implies

$$p_1(\cdot, t_0) = p_2(\cdot, t_0)$$

a.e. in Ω . As $t_0 \in (0, T]$ was chosen arbitrary $p_1 = p_2$ a.e. in Q follows. \square

CHAPTER 4

APPROXIMATION AND THE WEAK MAXIMUM PRINCIPLE

In this chapter we deal with the approximate problem corresponding to Problem 3.1.1.

First of all, we introduce the time discrete approximation of Problem 3.1.1. Using the implicit time discretization scheme with the discretization parameter $h > 0$, we transform the original (parabolic) problem into a family of elliptic problems, where the solutions p_n at each new time step n depend on the solutions p_{n-1} of the previous time step $n - 1$. Existence and uniqueness result for these elliptic problems at the time step n then follows by virtue of a generalization of the Brwoder-Minty Theorem (Theorem A.4.1), provided that the solutions at the previous time steps are bounded.

Since this boundedness is a priori not clear, we turn our attention to this matter in the second section and show the global boundedness of p_n for every time step n where the bound is independent of h and n . Choosing functions of the form $(p_n - a)^+$ as test-functions we derive the estimate of the supremum norm. This technique was already successfully applied in [4, 5] to obtain global boundedness of solutions to the Richards equation with hysteresis.

At the end of this chapter, we show an easy consequence of the weak maximum principle which gives us an estimate of ∇p_n .

4.1 The Approximate Problem

Let us fix $m \in \mathbb{N}$ and define the time step $h := T/m$. We set for $n \in \{0, \dots, m\}$

$$\tilde{P}_m^n(\cdot) := \tilde{P}(\cdot, nh) \quad \text{a.e. in } \Omega, \quad \text{as well as} \quad (4.1.1a)$$

$$K_m^n := \{v \in H^1(\Omega) | \gamma_0 v^+ = \gamma_0 \tilde{P}_m^n \text{ a.e. on } \Gamma_1\}. \quad (4.1.1b)$$

Setting $\hat{z} := (0, 0, 1)$, we approximate our central Problem 3.1.1 by an implicit time discretization scheme and introduce the following problem.

Problem 4.1.1. For $n = 1, \dots, m$ we consider the following recurrent systems with the unknown $p_m^n \in K_m^n$ such that for any $v \in K_m^n$

$$\int_{\Omega} (\mathfrak{s}_m^n (p_m^n - v) + k_m^{n-1} (\nabla p_m^n + \hat{z}) \cdot \nabla (p_m^n - v)) dx \leq 0 \quad (4.1.2a)$$

is satisfied, with $p_m^0(\cdot) = \tilde{P}(\cdot, 0)$ and where we set

$$s_m^n = a_0 p_m^n + w_m^n, \quad \text{a.e. in } \Omega, \quad n = 0, \dots, m, \quad (4.1.2b)$$

$$\mathfrak{s}_m^n := \frac{s_m^n - s_m^{n-1}}{h}, \quad \text{a.e. in } \Omega, \quad n = 1, \dots, m, \quad (4.1.2c)$$

$$w_m^n(x) := \int_0^\infty g(r, \xi_m^n(x, r)) dr, \quad g(r, v) = \int_0^v \psi(r, z) dz \quad (4.1.2d)$$

for a.a. $x \in \Omega$ and all $n \in \{0, \dots, m\}$, and where the sequence $\{\xi_m^n(x, r)\}_{n \in \{0, \dots, m\}}$ is defined recursively for a.a. $x \in \Omega$ and any $r > 0$ by

$$\xi_m^0(x, r) := P[\lambda(x, \cdot), u_m^0(x)](r), \quad \xi_m^n(x, r) := P[\xi_m^{n-1}(x, \cdot), u_m^n(x)](r), \quad (4.1.2e)$$

with the projection operator $P : \Lambda \times \mathbb{R} \rightarrow \Lambda$ defined as

$$P[\lambda, v] := \max \{v - r, \min \{v + r, \lambda(r)\}\}. \quad (4.1.2f)$$

We construct the solution to Problem 4.1.1 by induction over n . Denoting by $\langle \cdot, \cdot \rangle$ the duality pairing between $H^1(\Omega)$ and $(H^1(\Omega))^*$ and assuming that $p_m^{n-1} \in K_m^{n-1}$ is already known, we define the operator

$$\mathcal{Z}_m^n : K_m^n \rightarrow (H^1(\Omega))^*$$

by the formula

$$\langle \mathcal{Z}_m^n(u), v \rangle := \int_{\Omega} a_0 uv dx + \int_{\Omega} wv dx + h \int_{\Omega} k_m^{n-1} (\nabla u + \hat{z}) \nabla v dx,$$

where

$$w(x) = \int_0^\infty g(r, P[\xi_m^{n-1}(x, \cdot), u(x)](r)) dr. \quad (4.1.3)$$

Thus, (4.1.2a) can be rewritten in the following form

$$\langle \mathcal{Z}_m^n(p_m^n), p_m^n - v \rangle \leq \langle a_0 p_m^{n-1} + w_m^{n-1}, p_m^n - v \rangle \quad \forall v \in K_m^n. \quad (4.1.4)$$

We claim the following properties of the operator \mathcal{Z}_m^n .

Lemma 4.1.2. Let Assumption 3.2.3 hold, $n \in \{1, \dots, m\}$, and assume that $p_m^j \in K_m^j$ for $j \in \{0, \dots, n-1\}$, and that there exist $0 < \underline{k} \leq \bar{k}$, such that $\underline{k} \leq k_m^{n-1} \leq \bar{k}$ a.e. in Ω holds. Then the

operator \mathcal{L}_m^n is bounded, strictly monotone, continuous (in the sense of the definitions in Section A.4), and coercive, in the sense that there exists $u_0 \in K_m^n$ such that

$$\frac{\langle \mathcal{L}_m^n(u), u - u_0 \rangle}{\|u\|_{H^1(\Omega)}} \rightarrow \infty \quad \text{as } \|u\|_{H^1(\Omega)} \rightarrow \infty.$$

Proof:

① Let us start with the boundedness of \mathcal{L}_m^n . By virtue of $0 < \underline{k} \leq k_m^{n-1} \leq \bar{k}$, we obviously have for any $u, v \in H^1(\Omega)$ the following estimate

$$\begin{aligned} |\langle \mathcal{L}_m^n(u), v \rangle| &\leq \left| \int_{\Omega} (a_0 u + w) v \, dx + h \int_{\Omega} k_m^{n-1} (\nabla u + \hat{z}) \nabla v \, dx \right| \\ &\leq \left[a_0 \|u\|_{L^2(\Omega)} + \|w\|_{L^2(\Omega)} \right] \|v\|_{L^2(\Omega)} + \bar{k} h \|\nabla u + \hat{z}\|_{L^2(\Omega)} \|\nabla v\|_{L^2(\Omega)}. \end{aligned}$$

Thus, the estimate

$$\|\mathcal{L}_m^n(u)\|_{(H^1(\Omega))^*} \leq a_0 \|u\|_{L^2(\Omega)} + \|w\|_{L^2(\Omega)} + \bar{k} h \|\nabla u + \hat{z}\|_{L^2(\Omega)}$$

holds for any $u \in H^1(\Omega)$. Moreover, by virtue of Assumption 3.2.3 and Proposition 2.4.4 the function w defined by (4.1.3) is affinely bounded for any $u \in L^2(\Omega)$, and the following estimate

$$|w(x)| \leq R\tilde{b} + 3\tilde{b} \sum_{j=0}^{n-1} |p_m^j(x)| + 3\tilde{b} |u(x)|$$

holds for a.a. $x \in \Omega$, where \tilde{b} is as in Assumption 2.3.6. Recalling that by assumption p_m^j exist for $j \in \{0, \dots, n-1\}$ and belong to $L^2(\Omega)$, the preceding estimate yields the existence of a constant $\hat{c}_0 > 0$, such that

$$\|w\|_{L^2(\Omega)} \leq \hat{c}_0 + \hat{c}_0 \sum_{j=0}^{n-1} \|p_m^j\|_{L^2(\Omega)} + \hat{c}_0 \|u\|_{L^2(\Omega)}. \quad (4.1.5)$$

Keeping in mind, that $|\hat{z}| = 1$, we infer that

$$\|\mathcal{L}_m^n(u)\|_{(H^1(\Omega))^*} \leq (a_0 + \bar{k}h + \hat{c}_0) \|u\|_{H^1(\Omega)} + \bar{k}h |\Omega|^{\frac{1}{2}} + \hat{c}_0, \quad (4.1.6)$$

is satisfied for any $u \in H^1(\Omega)$, and therefore \mathcal{L}_m^n is a bounded operator.

② Let us proceed with the strict monotonicity of \mathcal{L}_m^n .

Let $u_1, u_2 \in K_m^n$ and for $i = 1, 2$ we set $w_i(x) = \int_0^\infty g(r, P[\xi_m^{n-1}(x, \cdot), u_i(x)](r)) \, dr$. Recalling $0 < \underline{k} \leq k_m^{n-1}$, we observe that

$$\begin{aligned} \langle \mathcal{L}_m^n(u_1) - \mathcal{L}_m^n(u_2), u_1 - u_2 \rangle &= \int_{\Omega} a_0 |u_1 - u_2|^2 + (w_1 - w_2)(u_1 - u_2) + h k_m^{n-1} |\nabla(u_1 - u_2)|^2 \, dx \\ &\geq a_0 \|u_1 - u_2\|_{L^2(\Omega)}^2 \, dx + h \underline{k} \|\nabla(u_1 - u_2)\|_{L^2(\Omega)}^2 \end{aligned}$$

holds, where in the last estimate we used the monotonicity of the mapping $u \mapsto w$ defined by (4.1.3). Consequently, for all $u_1 \neq u_2$

$$\langle \mathcal{L}_m^n(u_1) - \mathcal{L}_m^n(u_2), u_1 - u_2 \rangle > 0$$

follows and therefore \mathcal{Z}_m^n is strictly monotone.

③ Let us now take a look at the continuity of \mathcal{Z}_m^n .

Let $u \in H^1(\Omega)$ and $\{u_j\}_{j \in \mathbb{N}} \subset H^1(\Omega)$ such that $u_j \rightarrow u$ strongly in $H^1(\Omega)$. Thus, by virtue of $0 < \underline{k} \leq k_m^{n-1}$ and Hölder's inequality it follows that

$$\begin{aligned} \int_{\Omega} a_0(u_j - u)v \, dx + h \int_{\Omega} k_m^{n-1} \nabla(u_j - u) \nabla v \, dx \\ \leq a_0 \|u_j - u\|_{L^2(\Omega)} \|v\|_{L^2(\Omega)} + h \bar{k} \|\nabla(u_j - u)\|_{L^2(\Omega)} \|\nabla v\|_{L^2(\Omega)} \\ \leq \max\{a_0, \bar{k}h\} \|v\|_{H^1(\Omega)} \|u_j - u\|_{H^1(\Omega)} \end{aligned}$$

holds for any $v \in H^1(\Omega)$. Observing that the projection operator P from (4.1.2f) is nonexpansive, we infer for a.a. $x \in \Omega$ and all $r > 0$

$$|P[\xi_m^{n-1}(x, r), u_j(x)] - P[\xi_m^{n-1}(x, r), u(x)]| \leq |u_j(x) - u(x)|.$$

Recalling that by virtue of Assumption 2.3.10 $0 \leq \psi(r, z) = \partial_z g(r, z)$ holds, we obtain for a.a. $x \in \Omega$

$$\begin{aligned} \int_0^\infty |g(r, P[\xi_m^{n-1}(x, r), u_j(x)] - g(r, P[\xi_m^{n-1}(x, r), u(x)])| \, dr \leq \int_0^\infty |u_j(x) - u(x)| \beta(r) \, dr \\ \leq |u_j(x) - u(x)| \tilde{b} \end{aligned}$$

with \tilde{b} as in Assumption 2.3.6. Consequently,

$$\sup_{\|v\|_{H^1(\Omega)}=1} |\langle \mathcal{Z}_m^n(u_j) - \mathcal{Z}_m^n(u), v \rangle| \rightarrow 0 \quad \text{as} \quad \|u_j - u\|_{H^1(\Omega)} \rightarrow 0.$$

Hence, \mathcal{Z}_m^n is a continuous operator.

④ At last let us prove the coercivity of \mathcal{Z}_m^n . By the monotonicity of the mapping $u \mapsto w$ defined in (4.1.3)

$$(w - w_m^{n-1})(u - p_m^{n-1}) \geq 0$$

holds a.e. in Ω for all $u \in L^2(\Omega)$. Thus, (4.1.5) together with Hölder's and Young's inequalities yields the following estimate

$$\int_{\Omega} wu \, dx \geq -(\hat{c}_0 \|u\|_{L^2(\Omega)} + \hat{c}_0) \|p_m^{n-1}\|_{L^2(\Omega)} - \|w_m^{n-1}\|_{L^2(\Omega)} \|u\|_{L^2(\Omega)} - \|w_m^{n-1}\|_{L^2(\Omega)} \|p_m^{n-1}\|_{L^2(\Omega)}.$$

Recalling that by assumption p_m^{n-1} and w_m^{n-1} exist and belong to $L^2(\Omega)$, we obtain setting

$$\hat{c}_1 := \hat{c}_0 \|p_m^{n-1}\|_{L^2(\Omega)} + \|w_m^{n-1}\|_{L^2(\Omega)} \quad \text{and} \quad \hat{c}_2 := \hat{c}_0 \|p_m^{n-1}\|_{L^2(\Omega)} + \|w_m^{n-1}\|_{L^2(\Omega)} \|p_m^{n-1}\|_{L^2(\Omega)} \quad (4.1.7)$$

the following estimate

$$\int_{\Omega} wu \, dx \geq -\hat{c}_1 \|u\|_{L^2(\Omega)} - \hat{c}_2 \quad (4.1.8)$$

for any $u \in L^2(\Omega)$ and w defined by (4.1.3).

Let now $u_0 \in K_m^n$ be arbitrary. Hence, by virtue of (4.1.5), (4.1.8), Hölder's and Young's inequalities, it follows that

$$\begin{aligned} \int_{\Omega} w(u - u_0) dx &\geq -\hat{c}_1 \|u\|_{L^2(\Omega)} - \hat{c}_2 - \|w\|_{L^2(\Omega)} \|u_0\|_{L^2(\Omega)} \\ &\geq -\hat{c}_1 \|u\|_{L^2(\Omega)} - \hat{c}_2 - \hat{c}_0 \|u\|_{L^2(\Omega)} \|u_0\|_{L^2(\Omega)} - \hat{c}_0 \|u_0\|_{L^2(\Omega)} \\ &\geq -\frac{a_0}{2} \|u\|_{L^2(\Omega)}^2 - \frac{\hat{c}_1^2}{a_0} - \hat{c}_2 - \frac{\hat{c}_1^2}{a_0} \|u_0\|_{L^2(\Omega)}^2 - \hat{c}_0 \|u_0\|_{L^2(\Omega)} \end{aligned}$$

is satisfied for any $u \in L^2(\Omega)$. Assembling the estimates we consequently conclude

$$\begin{aligned} \langle \mathcal{L}_m^n(u), u - u_0 \rangle &= \int_{\Omega} a_0 u(u - u_0) + w(u - u_0) dx + hk_m^{n-1} (\nabla u + \hat{z})(\nabla u + \hat{z} - (\nabla u_0 + \hat{z})) dx \\ &\geq a_0 \|u\|_{L^2(\Omega)}^2 - a_0 \|u\|_{L^2(\Omega)} \|u_0\|_{L^2(\Omega)} - \frac{a_0}{2} \|u\|_{L^2(\Omega)}^2 \\ &\quad - \frac{\hat{c}_1^2}{a_0} - \hat{c}_2 - \frac{\hat{c}_1^2}{a_0} \|u_0\|_{L^2(\Omega)}^2 - \hat{c}_0 \|u_0\|_{L^2(\Omega)} \\ &\quad + h\underline{k} \|\nabla u + \hat{z}\|_{L^2(\Omega)}^2 - h\bar{k} \|\nabla u + \hat{z}\|_{L^2(\Omega)} \|\nabla u_0 + \hat{z}\|_{L^2(\Omega)} \\ &\geq \frac{a_0}{4} \|u\|_{L^2(\Omega)}^2 - \left[\frac{1}{a_0} + \frac{\hat{c}_1^2}{a_0} \right] \|u_0\|_{L^2(\Omega)}^2 - \frac{\hat{c}_1^2}{a_0} - \hat{c}_2 - \hat{c}_0 \|u_0\|_{L^2(\Omega)} \\ &\quad + h\frac{\underline{k}}{2} \|\nabla u + \hat{z}\|_{L^2(\Omega)}^2 - h\frac{\bar{k}^2}{2\underline{k}} \|\nabla u_0 + \hat{z}\|_{L^2(\Omega)}^2, \end{aligned}$$

and since Ω is bounded

$$\frac{\langle \mathcal{L}_m^n(u), u - u_0 \rangle}{\|u\|_{H^1(\Omega)}} \rightarrow \infty \quad \text{as } \|u\|_{H^1(\Omega)} \rightarrow \infty$$

follows, which finishes the proof. \square

As a consequence of Lemma 4.1.2 and Theorem A.4.1 we obtain the following result.

Corollary 4.1.3. *Let Assumption 3.2.3 hold, $n \in \{1, \dots, m\}$, and assume that $p_m^j \in K_m^j$ for $j \in \{0, \dots, n-1\}$, and that there exist $0 < \underline{k} \leq \bar{k}$, such that $\underline{k} \leq k_m^{n-1} \leq \bar{k}$ a.e. in Ω holds. Then the variational inequality (4.1.4) admits one and only one solution $p_m^n \in K_m^n$.*

Proof: As by assumption $p_m^j \in K_m^j \subset L^2(\Omega)$ holds for all $j \in \{0, \dots, n-1\}$, we obtain by virtue of Proposition 2.4.4 that $w_m^{n-1} \in L^2(\Omega)$, and therefore in particular $a_0 p_m^{n-1} + w_m^{n-1}$ belongs to $(H^1(\Omega))^*$. Thus, the claim follows by virtue of Lemma 4.1.2 and Theorem A.4.1. \square

In the next section we will see, that for all $n = 1, \dots, m$ there exist \underline{k}, \bar{k} , independent of m, n , satisfying $\underline{k} \leq k_m^n \leq \bar{k}$ a.e. in Ω , provided that Assumptions 3.2.1, 3.2.3, and 3.2.4 hold and consequently for all $m \in \mathbb{N}$ Problem 4.1.1 admits one and only one sequence of solutions $\{p_m^n\}_{n \in \{1, \dots, m\}}$.

4.2 The Weak Maximum Principle

In this section we prove the weak maximum principle for solutions of Problem 4.1.1. We are going to adopt the proof which can be found in [43, Chapter 2, §7] to the time discrete setting.

Proposition 4.2.1. *Let $m \in \mathbb{N}$, $h = \frac{T}{m}$ with $h < 1$. Suppose that Assumptions 3.2.1 - 3.2.5 hold. Then for all $n \in \{1, \dots, m\}$ variational inequality (4.1.2a) admits one and only solution $p_m^n \in K_m^n$. Moreover,*

$$-\bar{R} \leq p_m^n \leq \bar{R} \quad \underline{s} \leq s_m^n \leq \bar{s}, \quad \underline{k} \leq k_m^n \leq \bar{k} \quad \text{a.e. in } \Omega, \quad (4.2.1)$$

where \bar{R} , \underline{s} , \bar{s} are as in Assumption 3.2.3, and \underline{k} , \bar{k} are as in Assumption 3.2.4.

Proof: We prove the claim by induction. Clearly, according to Assumptions 3.2.1, 3.2.3, and 3.2.4 the estimate (4.2.1) is satisfied for $n = 0$. Let now $l \in \{1, \dots, m\}$ and assume that the claim holds for all $n \in \{0, \dots, l-1\}$. Thus, in particular

$$\underline{k} \leq k_m^n \leq \bar{k} \quad \forall n \in \{0, \dots, l-1\}$$

is satisfied. Then Corollary 4.1.3 implies the existence of a unique solution p_m^l of (4.1.2a) at the time step l . Setting

$$\partial Q := (\Omega \times \{0\}) \cup (\partial\Omega \times (0, T)),$$

we introduce

$$a := \sup_{\partial Q} |\tilde{P}|, \quad Z := \sup_{(x,y,z) \in \Omega} z, \quad \text{and} \quad b := a + Z.$$

Let z be the third component of a point $(x, y, z) \in \Omega$. For $n \in \{1, \dots, l\}$ we define

$$(p_m^n + z)^{(b)} := (p_m^n + z - b)^+, \quad \text{and} \quad (-(p_m^n + z))^{(a)} := (-p_m^n - z - a)^+,$$

and consider the following functions

$$\phi_m^n = p_m^n - h(p_m^n + z)^{(b)} \quad \text{and} \quad \varphi_m^n = p_m^n + h(-(p_m^n + z))^{(a)}$$

① We observe that

$$(p_m^n + z)^{(b)} = (p_m^n + z - b)^+ \leq (p_m^n + Z - Z - a)^+ = (p_m^n - a)^+$$

holds and consequently $(p_m^n + z)^{(b)}$ vanishes a.e. on Γ_1 .

② On the other hand, $(-(p_m^n + z))^{(a)}$ vanishes a.e. on $\{x \in \Gamma_1 : \gamma_0 p_m^n \geq -z - a\}$ and on the set $\{x \in \Gamma_1 : \gamma_0 p_m^n \leq -z - a\}$ we have, keeping in mind that by virtue of Assumption 3.2.2 $z \geq 0$, the following estimate a.e.

$$\gamma_0 \varphi_m^n = \gamma_0 p_m^n + h\gamma_0(-p_m^n - z - a)^+ = (1-h)\gamma_0 p_m^n - h(z+a) \leq 0.$$

As both $(p_m^n + z)^{(b)}$ and $(-(p_m^n + z))^{(a)}$ belong to $H^1(\Omega)$, we have $\phi_m^n \in K_m^n$ and $\varphi_m^n \in K_m^n$ and consequently ϕ_m^n and φ_m^n are admissible test-functions for (4.1.2a).

Testing (4.1.2a) at the time step $n \in \{1, \dots, l\}$ with ϕ_m^n yields the following inequality

$$\int_{\Omega} (s_m^n - s_m^{n-1})(p_m^n + z)^{(b)} dx + h \int_{\Omega} (k_m^{n-1}(\nabla p_m^n + \hat{z})) \cdot \nabla (p_m^n + z)^{(b)} dx \leq 0. \quad (4.2.2)$$

We will now estimate the terms of (4.2.2) separately.

By virtue of

$$p_m^{n-1} + z - b \leq (p_m^{n-1} + z)^{(b)} \quad \text{and} \quad (p_m^n + z - b)(p_m^n + z)^{(b)} = \left((p_m^n + z)^{(b)} \right)^2 \quad \text{a.e. in } \Omega,$$

Remark 2.5.11, and Proposition 2.5.10, we calculate for the first integral of the left-hand of side of (4.2.2)

$$\begin{aligned} & \int_{\Omega} (s_m^n - s_m^{n-1})(p_m^n + z)^{(b)} dx \\ &= \int_{\Omega} a_0 [p_m^n - p_m^{n-1}] (p_m^n + z)^{(b)} dx + \int_{\Omega} [w_m^n - w_m^{n-1}] (p_m^n + z)^{(b)} dx \\ & \geq \frac{a_0}{2} \left\| (p_m^n + z)^{(b)} \right\|_{L^2(\Omega)}^2 - \left\| (p_m^{n-1} + z)^{(b)} \right\|_{L^2(\Omega)}^2 + \int_{\Omega} \mathcal{U}_m^{*n(b-z)} - \mathcal{U}_m^{*(n-1)(b-z)} dx, \end{aligned} \quad (4.2.3)$$

with the nonnegative potential $\mathcal{U}_m^{*n(b-z)}$ defined as in Remark 2.5.11.

Let us now take a look at the second integral of the left-hand side of (4.2.2).

Bearing in mind that by assumption $\bar{k} \geq k_m^n \geq \underline{k}$ for all $n \in \{0, \dots, l-1\}$, we deduce the following estimate

$$h \int_{\Omega} k_m^{n-1} \nabla (p_m^n + z) \cdot \nabla (p_m^n + z)^{(b)} dx \geq h \underline{k} \left\| \nabla (p_m^n + z)^{(b)} \right\|_{L^2(\Omega)}^2. \quad (4.2.4)$$

Furthermore, recalling that $(p_m^0 + z)(b) = 0$ a.e. in Ω , we obtain with the help of Remark 2.5.11

$$\mathcal{U}_m^{*0(b-z)} \leq \frac{\tilde{b}}{2} |(p_m^0 + z - b)^+|^2 = \frac{\tilde{b}}{2} |(p_m^0 + z)(b)|^2 = 0$$

a.e. in Ω . Thus, inserting (4.2.3) and (4.2.4) into (4.2.2), and summing the resulting inequality over $1 \leq n \leq l$, we obtain taking into account, that for all $n \in \{0, \dots, m\}$ the potentials $\mathcal{U}_m^{*n(b-z)}$ are nonnegative a.e. in Ω , the following estimate

$$\frac{a_0}{2} \left\| (p_m^l + z)^{(b)} \right\|_{L^2(\Omega)}^2 + \underline{k} h \sum_{n=1}^l \left\| \nabla \left((p_m^n + z)^{(b)} \right) \right\|_{L^2(\Omega)}^2 \leq 0.$$

Moreover, application of φ_m^n as a test-function in (4.1.2a) implies

$$\begin{aligned} & \int_{\Omega} ((-s_m^n) - (-s_m^{n-1}))(-p_m^n + z)^{(a)} dx \\ & \quad + h \int_{\Omega} (k_m^{n-1} \nabla (-p_m^n + z)) \cdot \nabla (-p_m^n + z)^{(a)} dx \leq 0. \end{aligned}$$

As before, by virtue of Remark 2.5.11 and Proposition 2.5.10, the following estimates hold

$$\int_{\Omega} (-s_m^n) - (-s_m^{n-1})(-p_m^n + z)^{(a)} dx$$

$$\geq \frac{a_0}{2} \left\| (-p_m^n + z)^{(a)} \right\|_{L^2(\Omega)}^2 - \left\| (-p_m^{n-1} + z)^{(a)} \right\|_{L^2(\Omega)}^2 + \int_{\Omega} \mathcal{U}_m^{*n(a-z)} - \mathcal{U}_m^{*(n-1)(a-z)} dx, \quad (4.2.5)$$

with the nonnegative potential $\mathcal{U}_m^{*n(a-z)}$ defined as in Remark 2.5.11, as well as

$$h \int_{\Omega} k_m^{n-1} \nabla(-p_m^n + z) \cdot \nabla(-p_m^n + z)^{(a)} dx \geq h \underline{k} \left\| \nabla(-p_m^n + z)^{(a)} \right\|_{L^2(\Omega)}^2. \quad (4.2.6)$$

Thus, proceeding as above, we arrive at the following inequality

$$\frac{a_0}{2} \left\| (-p_m^l + z)^{(a)} \right\|_{L^2(\Omega)}^2 + \underline{k} h \sum_{n=1}^l \left\| \nabla(-p_m^n + z)^{(a)} \right\|_{L^2(\Omega)}^2 \leq 0,$$

and consequently

$$-a \leq p_m^l + z \leq b$$

is satisfied a.e. in Ω . Thus, setting $\bar{R} := a + Z$,

$$-\bar{R} \leq p_m^l \leq \bar{R}$$

follows. With the help of Assumption 3.2.3 we deduce, that

$$\underline{\mathfrak{W}} \leq w_m^l \leq \overline{\mathfrak{W}},$$

is satisfied with $\underline{\mathfrak{W}}, \overline{\mathfrak{W}}$ as in Assumption 3.2.3. Therefore Assumption 3.2.4 yields

$$\underline{k} \leq k_m^l \leq \bar{k}$$

and the proof is complete. \square

4.3 Estimates of $h \sum_{n=1}^l \|\nabla p_m^n\|_{L^2(\Omega)}^2$

We now prove an easy consequence of Proposition 4.2.1 which reads as follows.

Proposition 4.3.1. *Let $m \in \mathbb{N}$, $h := \frac{T}{m}$ and let $\{p_m^n\}_{n \in \{1, \dots, m\}}$ be the sequence of solutions to Problem 4.1.1. Suppose that Assumptions 3.2.1 - 3.2.5 hold. Then there exists a constant $\mu_1 > 0$ independent of n, m , such that*

$$h \sum_{n=1}^m \|\nabla p_m^n\|_{L^2(\Omega)}^2 \leq \mu_1 \quad (4.3.1)$$

is satisfied.

Proof: Let $n \in \{1, \dots, m\}$. In (4.1.2a) we choose the test-function $v_m^n = (1-h)p_m^n + h\tilde{P}_m^n \in K_m^n$ and obtain:

$$\int_{\Omega} \left[(s_m^n - s_m^{n-1})(p_m^n - \tilde{P}_m^n) + h k_m^{n-1} (\nabla p_m^n + \hat{z}) \cdot \nabla (p_m^n - \tilde{P}_m^n) \right] dx \leq 0. \quad (4.3.2)$$

With the help of the First Energy Inequality for time discrete Preisach operators stated in Proposition 2.5.6, we find

$$\int_{\Omega} (s_m^n - s_m^{n-1}) p_m^n dx \geq \frac{a_0}{2} \|p_m^n\|_{L^2(\Omega)}^2 - \frac{a_0}{2} \|p_m^{n-1}\|_{L^2(\Omega)}^2 + \int_{\Omega} \mathcal{U}_m^n - \mathcal{U}_m^{n-1} dx,$$

where the \mathcal{U}_m^l is the discrete Preisach potential energy defined in Proposition 2.5.6. Furthermore, we deduce by discrete partial integration, Hölder's and Young's inequalities, and Proposition 4.2.1 that

$$\begin{aligned} - \int_{\Omega} (s_m^n - s_m^{n-1}) \tilde{P}_m^n dx &= - \int_{\Omega} s_m^n \tilde{P}_m^n - s_m^{n-1} \tilde{P}_m^{n-1} dx + h \int_{\Omega} s_m^{n-1} \dot{\tilde{P}}_m^n dx \\ &\geq - \int_{\Omega} s_m^n \tilde{P}_m^n - s_m^{n-1} \tilde{P}_m^{n-1} dx - h \bar{s} |\Omega|^{\frac{1}{2}} \left\| \dot{\tilde{P}}_m^n \right\|_{L^2(\Omega)} \end{aligned}$$

holds, where \bar{s} is as in Assumption 3.2.3. Then, the uniform boundedness of our approximate solutions established in Proposition 4.2.1 together with Hölder's and Young's inequalities implies

$$\begin{aligned} h \int_{\Omega} k_m^{n-1} (\nabla p_m^n + \hat{z}) \cdot \nabla (p_m^n - \tilde{P}_m^n) dx \\ = h \int_{\Omega} k_m^{n-1} \left[|\nabla p_m^n + \hat{z}|^2 - (\nabla p_m^n + \hat{z}) \cdot (\nabla \tilde{P}_m^n + \hat{z}) \right] dx \\ \geq \frac{k}{2} h \|\nabla p_m^n + \hat{z}\|_{L^2(\Omega)}^2 - \frac{\bar{k}^2}{2k} h \left\| \nabla \tilde{P}_m^n + \hat{z} \right\|_{L^2(\Omega)}^2, \end{aligned}$$

where \underline{k}, \bar{k} are as in Assumption 3.2.4. Hence, assembling the estimates and summing the result over $n = 1, \dots, l, l \in \{1, \dots, m\}$ we find the following inequality

$$\begin{aligned} \frac{a_0}{2} \|p_m^l\|_{L^2(\Omega)}^2 + \int_{\Omega} \mathcal{U}_m^l dx + \frac{k}{2} h \sum_{n=1}^l \|\nabla p_m^n + \hat{z}\|_{L^2(\Omega)}^2 \\ \leq \frac{a_0}{2} \|p_m^0\|_{L^2(\Omega)}^2 + \int_{\Omega} \mathcal{U}_m^0 dx + \int_{\Omega} s_m^l \tilde{P}_m^l - s_m^0 \tilde{P}_m^0 dx \\ + h \sum_{n=1}^l \bar{s} |\Omega|^{\frac{1}{2}} \left\| \dot{\tilde{P}}_m^n \right\|_{L^2(\Omega)} + \frac{\bar{k}^2}{2k} h \sum_{n=1}^l \left\| \nabla \tilde{P}_m^n + \hat{z} \right\|_{L^2(\Omega)}^2. \end{aligned}$$

Observing that this inequality is trivially satisfied also for $l = 0$, as an empty sum equals to 0 by convention, it follows with the help of Proposition 4.2.1

$$\begin{aligned} \frac{a_0}{2} \max_{0 \leq n \leq m} \|p_m^n\|_{L^2(\Omega)}^2 + \max_{0 \leq n \leq m} \int_{\Omega} \mathcal{U}_m^n dx + \frac{k}{2} h \sum_{n=1}^m \|\nabla p_m^n + \hat{z}\|_{L^2(\Omega)}^2 \\ \leq \frac{a_0}{2} \|p_m^0\|_{L^2(\Omega)}^2 + \int_{\Omega} \mathcal{U}_m^0 dx + 2\bar{s} |Q| \left\| \tilde{P} \right\|_{L^\infty(Q)} \\ + h \sum_{n=1}^m \bar{s} |\Omega|^{\frac{1}{2}} \left\| \dot{\tilde{P}}_m^n \right\|_{L^2(\Omega)} + \frac{\bar{k}^2}{2k} h \sum_{n=1}^m \left\| \nabla \tilde{P}_m^n + \hat{z} \right\|_{L^2(\Omega)}^2, \end{aligned}$$

and consequently, Minkowski's inequality yields

$$\frac{k}{2} h \sum_{n=1}^l \|\nabla p_m^n + \hat{z}\|_{L^2(\Omega)}^2 \leq 2\bar{s} |Q| \left\| \tilde{P} \right\|_{L^\infty(Q)} + \bar{s} |Q|^{\frac{1}{2}} \left\| \dot{\tilde{P}} \right\|_{L^2(Q)} + \frac{\bar{k}^2 + k}{2k} \left\| \nabla \tilde{P} + \hat{z} \right\|_{L^2(Q)}^2.$$

Due to Assumptions 3.2.1 and 3.2.2 the right-hand side of this inequality is bounded independently of m, n and therefore claim follows. \square

CHAPTER 5

OSCILLATION DECAY ESTIMATES

In this chapter we prove oscillation decay estimates for the sequence $\{p_m^n\}_{n \in \{1, \dots, m\}}$ of approximate solutions to Problem 4.1.1.

Around 1957, De Giorgi and Nash [28, 52] succeeded in establishing Hölder estimates of solutions to scalar-valued elliptic and parabolic PDEs in divergence form with bounded and measurable coefficients. Ladyzhenskaya and Ural'tseva expanded their theory for both elliptic and parabolic equations in [44, 43].

For the derivation of oscillation decay estimates we are going to exploit the results of [34], where Hölder estimates were obtained for so called DIFFERENCE PARTIAL DIFFERENTIAL EQUATIONS OF ELLIPTIC-PARABOLIC TYPE. The technique is based on De Giorgi iteration and, since by virtue of Proposition 4.2.1 the leading elliptic coefficient is uniformly bounded, the only difference to the problem considered in [34] lies in the occurrence of a hysteresis operator under the time derivative in our equation. Nevertheless, we will see that the presence of hysteresis poses no obstacle to the application of the mentioned technique, as we can apply Proposition 2.5.10.

Following [34], we derive two different types of estimates, as the time discrete equations represent the feature of elliptic or parabolic equations depending on whether the time discrete mesh is relatively large or small compared to the size of the domain under consideration. From this viewpoint Kukuchi introduced in [34] two function spaces depending on the time discrete mesh, which are only variations of classical De Giorgi function classes studied in [28, 52, 44, 43]. To obtain oscillation decay estimates for the functions p_m^n we make use of Theorem A.8.16. Thus, we have to verify that our sequence $\{p_m^n\}_{n \in \{1, \dots, m\}}$ of solutions to Problem 4.1.1 satisfy inequalities (A.8.2.2a), (A.8.2.2b), and (A.8.1.2). We will do this in the following sections.

5.1 First Estimate

Let us first verify inequality (A.8.2.2a). The result is stated in the Lemma below.

Lemma 5.1.1. *Let $m \in \mathbb{N}$, $h := \frac{T}{m}$ with $h < 1$, and suppose that Assumptions 3.2.1 - 3.2.5 hold. Let $\{p_m^n\}_{n \in \{0, \dots, m\}}$ be the sequence of solutions to Problem 4.1.1.*

Let $x_0 \in \bar{\Omega}$, $n_0 \in \{1, \dots, m\}$ be arbitrary, and put $t_{n_0} := n_0 h$. For $\varrho_0 > 0$ as in Assumption 3.2.2 and $\tau_0 \geq \sqrt{h}$, we denote by $B_\varrho = B_\varrho(x_0)$ the ball centered at x_0 with radius $0 < \varrho \leq \varrho_0$, and by $Q(\varrho, \tau)$ a local parabolic cylinder of the form

$$Q(\varrho, \tau) := B_\varrho \times (t_{n_0} - \tau, t_{n_0}),$$

where $\sqrt{h} \leq \tau \leq \tau_0$. Let \bar{p}_m be the piecewise constant time interpolate of the sequence $\{p_m^n\}_{n \in \{0, \dots, m\}}$, defined by

$$\bar{p}_m(x, t) := \begin{cases} p_m^n(x), & \text{for } (n-1)h < t \leq nh, n \geq 1, \\ p_m^0(x), & \text{for } t = 0, \end{cases} \quad \text{for a.a. } x \in \Omega, \quad (5.1.1)$$

Moreover, we set $\bar{u}_m := \pm \bar{p}_m$, and $\bar{u}_m^{(a)} := (\bar{u}_m - a)^+$ for any $a \in \mathbb{R}$.

Then there exist a constant $\gamma > 0$, independent of m, n, ϱ, τ , such that for all $\sigma_1 \in (0, 1)$

$$\begin{aligned} \sup_{\max\{0, t_{n_0} - \tau\} \leq t \leq t_{n_0}} \left\| \bar{u}_m^{(a)}(\cdot, t) \right\|_{L^2(B_{(1-\sigma_1)\varrho} \cap \Omega)}^2 &\leq \left\| \bar{u}_m^{(a)}(\cdot, \max\{0, t_{n_0} - \tau\}) \right\|_{L^2(B_\varrho \cap \Omega)}^2 \\ &+ \gamma \left((\sigma_1 \varrho)^{-2} \int_{\max\{0, t_{n_0} - \tau\}}^{t_{n_0}} \left\| \bar{u}_m^{(a)} \right\|_{L^2(B_\varrho \cap \Omega)}^2 + |[A_{a, \varrho}]_m(t)| dt \right) \end{aligned} \quad (5.1.2)$$

holds, where

$$[A_{a, \varrho}]_m(t) := \left\{ x \in B_\varrho \cap \Omega : \bar{u}_m^{(a)}(\cdot, t) > a \right\}, \quad (5.1.3)$$

and where the levels a satisfy

$$a \geq \sup_{Q(\varrho, \tau) \cap Q} \bar{u}_m - 2\bar{R}, \quad \text{and} \quad a \geq \sup_{Q(\varrho, \tau) \cap \Omega \times \{0\}} \bar{u}_m, \quad (5.1.4a)$$

with \bar{R}, \bar{R} is as in Assumption 3.2.3, as well as

$$\diamond \quad \text{if } \bar{u}_m = \bar{p}_m \quad a \geq \sup_{Q(\varrho, \tau) \cap (\Gamma'_1 \times (0, T))} (\gamma_0 \bar{p}_m)^+, \quad (5.1.4b)$$

$$\diamond \quad \text{if } \bar{u}_m = -\bar{p}_m \quad a \geq \sup_{Q(\varrho, \tau) \cap \Sigma_1} -(\gamma_0 \bar{p}_m)^+, \quad (5.1.4c)$$

with the classical convention $\sup_{(x, t) \in \emptyset} u(x, t) = -\infty$.

Proof: The proof follows the arguments of [34]. Thus let $x_0, n_0, t_{n_0}, \varrho_0$, and τ_0 as above. Moreover, let $\varrho, \tau \in \mathbb{R}^+$ and $\sigma_1 \in (0, 1)$ be arbitrary satisfying $\varrho \leq \varrho_0, \sqrt{h} \leq \tau \leq \tau_0$.

Let $\zeta \in C_0^1(\mathbb{R}^3)$ be a scalar-valued function satisfying $0 \leq \zeta \leq 1$, $|\nabla\zeta(x)| < \frac{2}{\sigma_1\varrho}$, and

$$\zeta(x) = \begin{cases} 1 & \text{for } |x - x_0| < (1 - \sigma_1)\varrho, \\ 0 & \text{for } |x - x_0| > \varrho. \end{cases} \quad (5.1.5)$$

Let $n_1 \in \{0, \dots, m\}$ be such that $t_{n_0} - \tau \leq n_1 h \leq t_{n_0}$ and consider the local parabolic cylinder

$$Q(\varrho, \tau) = B_\varrho \times (n_0 h - \tau, n_0 h).$$

Observing that for any $n \in \{n_1, \dots, n_0\}$ and any level a satisfying

$$a \geq \max \left\{ \sup_{Q(\varrho, \tau) \cap Q} \bar{p}_m - 2\bar{R}; \sup_{Q(\varrho, \tau) \cap \Omega \times \{0\}} \bar{p}_m; \sup_{Q(\varrho, \tau) \cap (\Gamma_1^+ \times (0, T))} (\gamma_0 \bar{p}_m)^+ \right\},$$

with $Q(\varrho, \tau)$ as above, the nonnegative function $\gamma_0(p_m^n - a)^+\zeta^2$ vanishes particularly on those parts of Γ_1 where $\gamma_0 p_m^n > 0$. Hence,

$$\phi_m^n = p_m^n - h(p_m^n - a)^+\zeta^2 =: p_m^n - h p_m^{n(a)} \zeta^2$$

is an admissible test-function for (4.1.2a) for all $n \in \{n_1, \dots, n_0\}$.

Applying ϕ_m^n as a test-function in (4.1.2a) yields

$$\int_{\Omega} \left((s_m^n - s_m^{n-1}) p_m^{n(a)} \zeta^2 + h k_m^{n-1} (\nabla p_m^n + \hat{z}) \cdot \nabla (p_m^{n(a)} \zeta^2) \right) dx \leq 0 \quad (5.1.6)$$

for all $n \in \{n_1, n_0\}$. Now we want to estimate the terms of the left-hand side of (5.1.6) separately. The second term can be estimated in the same way, as it has been done in [34]. In order to estimate the first term, we will exploit the results of Proposition 2.5.10.

① As in the proof of Proposition 4.2.1 we obtain by virtue of

$$p_m^{n-1} - a \leq p_m^{(n-1)(a)} \quad \text{and} \quad (p_m^n - a) p_m^{n(a)} = (p_m^{n(a)})^2 \quad \text{a.e. in } \Omega,$$

and Proposition 2.5.10 the following estimate

$$\begin{aligned} & \int_{\Omega} (s_m^n - s_m^{n-1}) p_m^{n(a)} \zeta^2 dx \\ & \geq \frac{a_0}{2} \left[\left\| p_m^{n(a)} \zeta \right\|_{L^2(\Omega)}^2 - \left\| p_m^{(n-1)(a)} \zeta \right\|_{L^2(\Omega)}^2 \right] + \int_{\Omega} \mathcal{U}_m^{*n(a)} \zeta^2 - \mathcal{U}_m^{*(n-1)(a)} \zeta^2 dx, \end{aligned} \quad (5.1.7)$$

where the potentials $\mathcal{U}_m^{*n(a)}$ are defined as in Proposition 2.5.10.

② Introducing the level sets

$$[A_{a, \varrho}]_m^n := \{x \in B_\varrho \cap \Omega : p_m^n - a > 0\}, \quad (5.1.8)$$

we observe that

$$p_m^n \Big|_{[A_{a,\varrho}]_m^n} = p_m^{n(a)} \Big|_{[A_{a,\varrho}]_m^n} \quad \text{and} \quad \nabla p_m^n \Big|_{[A_{a,\varrho}]_m^n} = \nabla p_m^{n(a)} \Big|_{[A_{a,\varrho}]_m^n}$$

hold for all $n \in \{n_1, \dots, n_2\}$ a.e. Hence, bearing in mind that Proposition 4.2.1 yields $0 < \underline{k} \leq k_m^n \leq \bar{k}$ for all $n \in \{0, \dots, m\}$, we obtain by virtue of Young's inequality

$$\begin{aligned} \int_{\Omega} k_m^{n-1} (\nabla p_m^n + \hat{z}) \cdot \nabla p_m^{n(a)} \zeta^2 dx &\geq \int_{[A_{a,\varrho}]_m^n} \underline{k} |\nabla p_m^{n(a)}|^2 \zeta^2 dx - \int_{[A_{a,\varrho}]_m^n} \bar{k} |\hat{z}| |\nabla p_m^{n(a)}| \zeta^2 dx \\ &\geq \frac{3\underline{k}}{4} \int_{[A_{a,\varrho}]_m^n} |\nabla p_m^{n(a)}|^2 \zeta^2 dx - \frac{\bar{k}^2}{\underline{k}} \int_{[A_{a,\varrho}]_m^n} \zeta^2 dx, \end{aligned} \quad (5.1.9)$$

as well as

$$\begin{aligned} &2 \int_{\Omega} k_m^{n-1} (\nabla p_m^n + \hat{z}) p_m^{n(a)} \zeta \cdot \nabla \zeta dx \\ &\geq -2 \int_{[A_{a,\varrho}]_m^n} \bar{k} |\nabla p_m^n| |p_m^{n(a)}| \zeta |\nabla \zeta| dx - 2 \int_{[A_{a,\varrho}]_m^n} \bar{k} |\hat{z}| |p_m^{n(a)}| \zeta |\nabla \zeta| dx \\ &\geq - \int_{[A_{a,\varrho}]_m^n} \frac{\underline{k}}{2} |\nabla p_m^{n(a)}|^2 \zeta^2 dx - 2 \left(\frac{\bar{k}^2}{\underline{k}} + \bar{k}^2 \right) \int_{[A_{a,\varrho}]_m^n} |p_m^{n(a)}|^2 |\nabla \zeta|^2 dx - \int_{[A_{a,\varrho}]_m^n} \frac{1}{2} \zeta^2 dx, \end{aligned} \quad (5.1.10)$$

since $|\hat{z}| = 1$. Recalling the construction of the function ζ , we find $|\nabla \zeta| \leq 2(\sigma_1 \varrho)^{-1}$ and follow assembling the estimates (5.1.9) and (5.1.10)

$$\begin{aligned} &\int_{\Omega} \left(k_m^{n-1} (\nabla p_m^n + \hat{z}) \cdot \nabla (p_m^{n(a)} \zeta^2) \right) dx \\ &\geq \int_{[A_{a,\varrho}]_m^n} \frac{\underline{k}}{4} |\nabla p_m^{n(a)}|^2 \zeta^2 dx - \left(\frac{\bar{k}^2}{\underline{k}} + \bar{k}^2 \right) 8(\sigma_1 \varrho)^{-2} \int_{[A_{a,\varrho}]_m^n} |p_m^{n(a)}|^2 dx \\ &\quad - \left(\frac{1}{2} + \frac{\bar{k}^2}{\underline{k}} \right) \int_{[A_{a,\varrho}]_m^n} \zeta^2 dx. \end{aligned} \quad (5.1.11)$$

Inserting the estimates (5.1.7) and (5.1.11) into (5.1.6), and summing the result over $n \in \{n_1, \dots, n_2\}$ with $n_2 \in \{n_1, \dots, n_0\}$ we obtain

$$\begin{aligned} &\frac{a_0}{2} \left\| p_m^{n_2(a)} \zeta \right\|_{L^2(\Omega)}^2 + \int_{\Omega} \mathcal{U}_m^{*n_2(a)} \zeta^2 dx + \frac{\underline{k}}{4} h \sum_{n=n_1}^{n_2} \int_{B_{\varrho}} |\nabla p_m^{n(a)}|^2 \zeta^2 dx \\ &\leq \frac{a_0}{2} \left\| p_m^{(n_1-1)(a)} \zeta \right\|_{L^2(\Omega)}^2 + \int_{\Omega} \mathcal{U}_m^{*(n_1-1)(a)} \zeta^2 dx \\ &\quad + (\sigma_1 \varrho)^{-2} c_1 h \sum_{n=n_1}^{n_2} \int_{[A_{a,\varrho}]_m^n} |p_m^{n(a)}|^2 dx + c_1 h \sum_{n=n_1}^{n_2} \int_{[A_{a,\varrho}]_m^n} \zeta^2 dx, \end{aligned} \quad (5.1.12)$$

where we set

$$c_1 := \max \left\{ 8 \left(\frac{\bar{k}^2}{\underline{k}} + \bar{k}^2 \right); \left(\frac{1}{2} + \frac{\bar{k}^2}{\underline{k}} \right) \right\}. \quad (5.1.13)$$

Moreover, we observe that inequality (5.1.12) is trivially satisfied when $n_2 = n_1 - 1$, as by convention an empty sum is 0. Thus, taking in (5.1.12) the maximum over $n_2 \in \{n_1 - 1, \dots, n_0\}$ it follows that

$$\begin{aligned} & \max_{(n_1-1) \leq n \leq n_0} \left\| p_m^{n(a)} \zeta \right\|_{L^2(\Omega)}^2 + \max_{(n_1-1) \leq n \leq n_0} \frac{2}{a_0} \int_{\Omega} \mathcal{U}_m^{*n(a)} \zeta^2 dx \\ & \leq \left\| p_m^{(n_1-1)(a)} \zeta \right\|_{L^2(\Omega)}^2 + \frac{2}{a_0} \int_{\Omega} \mathcal{U}_m^{*(n_1-1)(a)} \zeta^2 dx \\ & \quad + \gamma \left((\sigma_1 \varrho)^{-2} h \sum_{n=n_1}^{n_0} \int_{[A_{a,\varrho}]_m^n} \left| p_m^{n(a)} \right|^2 dx + h \sum_{n=n_1}^{n_0} |[A_{a,\varrho}]_m^n| \right) \end{aligned}$$

holds, where $\gamma := \frac{2}{a_0} c_1$. Consequently,

$$\begin{aligned} & \max_{(n_1-1) \leq n \leq n_0} \left\| p_m^{n(a)} \zeta \right\|_{L^2(\Omega)}^2 \leq \left\| p_m^{(n_1-1)(a)} \zeta \right\|_{L^2(\Omega)}^2 \\ & \quad + \gamma \left((\sigma_1 \varrho)^{-2} h \sum_{n=n_1}^{n_0} \int_{[A_{a,\varrho}]_m^n} \left| p_m^{n(a)} \right|^2 dx + h \sum_{n=n_1}^{n_0} |[A_{a,\varrho}]_m^n| \right) \end{aligned}$$

is satisfied. Since by assumption $\tau \geq \sqrt{h}$ and $h < 1$, we have in particular that $\tau \geq h$ holds. Hence, denoting for a number $r \in \mathbb{R}$ by $\lfloor r \rfloor := \max \{z \in \mathbb{Z} : z \leq r\}$,

$$n_0 - \left\lfloor \frac{\tau}{h} \right\rfloor + 1 \leq n_0$$

follows, and setting $n_1 := \max \{1; n_0 - \lfloor \frac{\tau}{h} \rfloor + 1\}$ we obtain

$$\begin{aligned} & \max_{\max\{0; n_0 - \lfloor \frac{\tau}{h} \rfloor\} \leq n \leq n_0} \left\| p_m^{n(a)} \right\|_{L^2(B_{(1-\sigma_1)\varrho} \cap \Omega)}^2 \leq \left\| p_m^{(\max\{0; n_0 - \lfloor \frac{\tau}{h} \rfloor\})(a)} \right\|_{L^2(B_{(1-\sigma_1)\varrho} \cap \Omega)}^2 \\ & \quad + \gamma \left((\sigma_1 \varrho)^{-2} h \sum_{n=\max\{0; n_0 - \lfloor \frac{\tau}{h} \rfloor\} + 1}^{n_0} \int_{[A_{a,\varrho}]_m^n} \left| p_m^{n(a)} \right|^2 dx + h \sum_{n=\max\{0; n_0 - \lfloor \frac{\tau}{h} \rfloor\} + 1}^{n_0} |[A_{a,\varrho}]_m^n| \right). \end{aligned}$$

Based on the definition of \bar{p}_m , we can rewrite this inequality in the form

$$\begin{aligned} & \sup_{\max\{0; t_{n_0} - \tau\} \leq t \leq t_{n_0}} \left\| \bar{p}_m^{(a)}(\cdot, t) \right\|_{L^2(B_{(1-\sigma_1)\varrho} \cap \Omega)}^2 \leq \left\| \bar{p}_m^{(a)}(\cdot, \max\{0; t_{n_0} - \tau\}) \right\|_{L^2(B_{\varrho} \cap \Omega)}^2 \\ & \quad + \gamma \left((\sigma_1 \varrho)^{-2} \int_{\max\{0; t_{n_0} - \tau\}}^{t_{n_0}} \left\| \bar{p}_m^{(a)} \right\|_{L^2(B_{\varrho})}^2 dx + |[A_{a,\varrho}]_m(t)| dt \right), \quad (5.1.14) \end{aligned}$$

where

$$[A_{a,\varrho}]_m(t) := \{x \in B_{\varrho} : \bar{p}_m(x, t) > a\}. \quad (5.1.15)$$

Therefore, the function \bar{p}_m satisfies (5.1.2).

Let us now consider the function $-\bar{p}_m$. We observe that for any $n \in \{n_1, \dots, n_0\}$ and any level a satisfying

$$a \geq \max \left\{ \sup_{Q(\varrho, \tau) \cap Q} -\bar{p}_m - 2\bar{R}; \sup_{Q(\varrho, \tau) \cap \Omega \times \{0\}} -\bar{p}_m; \sup_{Q(\varrho, \tau) \cap \Sigma_1} -(\gamma_0 \bar{p}_m)^+ \right\},$$

the nonnegative function $\gamma_0(-p_m^n - a)^+\zeta^2$ vanishes particularly on those parts of Γ_1 where $\gamma_0 p_m^n > 0$. On the other hand, if $|\{x \in \Gamma_1 \cap B_\varrho(x_0) : \gamma_0 p_m^n \leq 0\}| \neq 0$, then $\sup_{Q(\varrho, \tau) \cap \Sigma_1} -(\gamma_0 \bar{p}_m)^+ = 0$, and a is necessary nonnegative. Hence, if $\gamma_0 p_m^n(x) \leq 0$ we have for all $h < 1$

$$\gamma_0 p_m^n + h\gamma_0(-p_m^n(x) - a)^+ \leq 0,$$

and consequently the function

$$\varphi_m^n := p_m^n + h(-p_m^n - a)^+\zeta^2 = p_m^n + h(-p_m^n)^{(a)}\zeta^2$$

is an admissible test-function for (4.1.2a), for all $n \in \{n_1, \dots, n_0\}$. Thus, applying φ_m^n as a test-function in (4.1.2a) and arguing as above we obtain estimate (5.1.14) for the function $-\bar{p}_m$ and conclude, that $\pm\bar{p}_m$ satisfies (5.1.2) with γ defined as above. \square

5.2 Second Estimate

In this section we show, that the functions $\pm\bar{p}_m$ satisfy inequality (A.8.2.2b). The result we prove reads as follows.

Lemma 5.2.1. *Let $m \in \mathbb{N}$, $h := \frac{T}{m}$ with $h < 1$, and suppose that Assumptions 3.2.1 - 3.2.5 hold. Let $\{p_m^n\}_{n \in \{0, \dots, m\}}$ be the sequence of solutions to Problem 4.1.1.*

Let $x_0 \in \bar{\Omega}$, $n_0 \in \{1, \dots, m\}$ be arbitrary and put $t_{n_0} := n_0 h$. For $0 < \varrho_0$ as in Assumption 3.2.2, and $\sqrt{h} \leq \tau_0$ we denote again by $B_\varrho = B_\varrho(x_0)$ the ball centered at x_0 with radius $0 < \varrho \leq \varrho_0$, and by $Q(\varrho, \tau)$ a local parabolic cylinder

$$Q(\varrho, \tau) := B_\varrho \times (t_{n_0} - \tau, t_{n_0}),$$

where $\sqrt{h} \leq \tau \leq \tau_0$.

Let \bar{p}_m is the piecewise constant time interpolate of $\{p_m^n\}_{n \in \{0, \dots, m\}}$ given by (5.1.1), $\bar{u}_m = \pm\bar{p}_m$, and for $a \in \mathbb{R}$ we set $\bar{u}_m^{(a)} := (\bar{u}_m - a)^+$.

Then there exist a constant $\Upsilon > 0$, independent of m, n, ϱ and τ , such that for any $\sigma_1, \sigma_2 \in (0, 1)$ the following inequality is satisfied

$$\begin{aligned} & \sup_{\max\{0; t_{n_0} - (1 - \sigma_2)\tau\} \leq t \leq t_{n_0}} \left\| \bar{u}_m^{(a)} \right\|_{L^2(B_{\varrho - \sigma_1 \varrho} \cap \Omega)}^2 + \int_{\max\{0; t_{n_0} - (1 - \sigma_2)\tau\}}^{t_{n_0}} \left\| \nabla \bar{u}_m^{(a)} \right\|_{L^2(B_{\varrho - \sigma_1 \varrho} \cap \Omega)}^2 dt \\ & \leq \Upsilon \int_{\max\{0; t_{n_0} - \tau\}}^{t_{n_0}} [(\sigma_1 \varrho)^{-2} + (\sigma_2 \tau)^{-1}] \left\| \bar{u}_m^{(a)} \right\|_{L^2(B_\varrho \cap \Omega)}^2 + |[A_{a, \varrho}]_m(t)| dt, \end{aligned} \quad (5.2.1)$$

where $[A_{a, \varrho}]_m(t)$ are defined in (5.1.3), and the levels a satisfy restrictions (5.1.4).

Proof: Again, the proof follows the arguments of [34]. Thus, let $x_0, n_0, t_{n_0}, \varrho_0$, and τ_0 be as above. Moreover, let $\varrho, \tau \in \mathbb{R}^+$ and $\sigma_1, \sigma_2 \in (0, 1)$ be arbitrary satisfying $\varrho \leq \varrho_0, \sqrt{h} \leq \tau \leq \tau_0$.

Let the scalar-valued function $\zeta \in C_0^1(\mathbb{R}^3)$ satisfying $0 \leq \zeta \leq 1$, $|\nabla\zeta(x)| < \frac{2}{\sigma_1\varrho}$ be as in (5.1.5).

For given $\tau > 0$, $0 < \sigma_2 < 1$ and $n_0 \in \{1, \dots, m\}$ we introduce a step function $\eta_m(t)$ defined on $[0, T]$ as follows:

$$\eta_m(t) := \eta_m^n \quad \text{for} \quad t_{n-1} < t \leq t_n, \quad n \in 1, \dots, m, \quad (5.2.2)$$

where

$$\eta_m^n := \begin{cases} 1 & \text{for } n_0 - \left\lfloor \frac{(1-\sigma_2)\tau}{h} \right\rfloor \leq n \leq n_0, \\ \frac{n-n_0 + \left\lfloor \frac{\tau}{h} \right\rfloor - 1}{\left\lfloor \frac{\tau}{h} \right\rfloor - 2 - \left\lfloor \frac{(1-\sigma_2)\tau}{h} \right\rfloor} & \text{for } n_0 - \left\lfloor \frac{\tau}{h} \right\rfloor + 1 \leq n \leq n_0 - \left\lfloor \frac{(1-\sigma_2)\tau}{h} \right\rfloor - 1, \\ 0 & \text{for } n \leq n_0 - \left\lfloor \frac{\tau}{h} \right\rfloor. \end{cases}$$

As in [34], we will distinguish the following cases

$$\textcircled{1} \quad \sigma_2\tau \geq 4h,$$

$$\textcircled{2} \quad \sigma_2\tau < 4h.$$

$\textcircled{1}$ We start with the case $\sigma_2\tau \geq 4h$.

Particularly, in view of $\sigma_2\tau \geq 4h$, we have

$$0 \leq \eta_m^n - \eta_m^{n-1} \leq \frac{4h}{\sigma_2\tau}, \quad n \in \{1, \dots, m\}.$$

Considering the local parabolic cylinder

$$Q(\varrho, \tau) = B_\varrho \times (n_0h - \tau, n_0h),$$

we see, as in the proof of Lemma 5.1.1, that for any $n \in \{\max\{0, \left\lfloor \frac{\tau}{h} \right\rfloor\}, \dots, n_0\}$ and any level a satisfying (5.1.4) the function

$$\phi_m^n = p_m^n - h(p_m^n - a)^+ \zeta^2 \eta_m^n =: p_m^n - hp_m^{n(a)} \zeta^2 \eta_m^n$$

is an admissible test-function for (4.1.2a) for all $n \in \{\max\{0, \left\lfloor \frac{\tau}{h} \right\rfloor\}, \dots, n_0\}$, where as before for a number $r \in \mathbb{R}$ we use the notation $\lfloor r \rfloor := \max\{z \in \mathbb{Z} : z \leq r\}$.

Applying ϕ_m^n as a test-function in (4.1.2a) at the time steps

$$n \in \left\{ \max\left\{0, n_0 - \left\lfloor \frac{\tau}{h} \right\rfloor\right\}, \dots, n_1 \right\}, \quad \text{with} \quad n_1 \in \left\{ \max\left\{0, n_0 - \left\lfloor \frac{\tau}{h} \right\rfloor\right\}, \dots, n_0 \right\},$$

and summing the resulting inequalities over $n \in \{\max\{0, n_0 - \left\lfloor \frac{\tau}{h} \right\rfloor\}, \dots, n_1\}$, we obtain

$$\begin{aligned} & \sum_{n=\max\{0, n_0 - \left\lfloor \frac{\tau}{h} \right\rfloor\}}^{n_1} \int_{\Omega} (s_m^n - s_m^{n-1}) p_m^{n(a)} \zeta^2 \eta_m^n \, dx \\ & + h \sum_{n=\max\{0, n_0 - \left\lfloor \frac{\tau}{h} \right\rfloor\}}^{n_1} \int_{\Omega} k_m^{n-1} (\nabla p_m^n + \hat{z}) \nabla \left(p_m^{n(a)} \zeta^2 \eta_m^n \right) \, dx \leq 0. \end{aligned} \quad (5.2.3)$$

The second term on the left-hand side of (5.2.3) can be estimated as it has been done in (5.1.11).

Let us now take a closer look at the first term of the left-hand side of (5.2.3).

As by definition $\eta_m^{n_0 - \lfloor \frac{\tau}{h} \rfloor} = 0$, $p_m^{0(a)} = 0$, and $\eta_m^n = 1$ for $n \geq n_0 - \lfloor \frac{(1-\sigma_2)\tau}{h} \rfloor + 1$ hold, we calculate

$$\begin{aligned}
& \sum_{n=\max\{0; n_0 - \lfloor \frac{\tau}{h} \rfloor\}}^{n_1} \int_{\Omega} (s_m^n - s_m^{n-1}) p_m^{n(a)} \zeta^2 \eta_m^n dx \\
&= \sum_{n=\max\{0; n_0 - \lfloor \frac{\tau}{h} \rfloor\} + 1}^{n_1} \int_{\Omega} (s_m^n - s_m^{n-1}) p_m^{n(a)} \zeta^2 \eta_m^n dx \\
&= \sum_{n=\max\{0; n_0 - \lfloor \frac{(1-\sigma_2)\tau}{h} \rfloor\}}^{\max\{0; n_0 - \lfloor \frac{\tau}{h} \rfloor\}} \int_{\Omega} (s_m^n - s_m^{n-1}) p_m^{n(a)} \zeta^2 \eta_m^n dx \\
&\quad + \sum_{n=\max\{0; n_0 - \lfloor \frac{(1-\sigma_2)\tau}{h} \rfloor\} + 1}^{n_1} \int_{\Omega} (s_m^n - s_m^{n-1}) p_m^{n(a)} \zeta^2 dx, \quad (5.2.4)
\end{aligned}$$

Then, Proposition 2.5.10 implies

$$\begin{aligned}
& \sum_{n=\max\{0; n_0 - \lfloor \frac{(1-\sigma_2)\tau}{h} \rfloor\} + 1}^{n_1} \int_{\Omega} (s_m^n - s_m^{n-1}) p_m^{n(a)} \zeta^2 dx \\
&\geq \frac{a_0}{2} \left[\left\| p_m^{n_1(a)} \zeta \right\|_{L^2(\Omega)}^2 - \left\| p_m^{\max\{0; n_0 - \lfloor \frac{(1-\sigma_2)\tau}{h} \rfloor\}(a)} \zeta \right\|_{L^2(\Omega)}^2 \right] \\
&\quad + \int_{\Omega} \mathcal{U}_m^{*n_1(a)} \zeta^2 - \mathcal{U}_m^{*\max\{0; n_0 - \lfloor \frac{(1-\sigma_2)\tau}{h} \rfloor\}(a)} \zeta^2 dx, \quad (5.2.5)
\end{aligned}$$

as well as

$$\begin{aligned}
& \sum_{n=\max\{0; n_0 - \lfloor \frac{\tau}{h} \rfloor\} + 1}^{\max\{0; n_0 - \lfloor \frac{(1-\sigma_2)\tau}{h} \rfloor\}} \int_{\Omega} (s_m^n - s_m^{n-1}) p_m^{n(a)} \zeta^2 \eta_m^n dx \\
&\geq \sum_{n=\max\{0; n_0 - \lfloor \frac{\tau}{h} \rfloor\} + 1}^{\max\{0; n_0 - \lfloor \frac{(1-\sigma_2)\tau}{h} \rfloor\}} \frac{a_0}{2} \left[\left\| p_m^{n(a)} \zeta \right\|_{L^2(\Omega)}^2 - \left\| p_m^{(n-1)(a)} \zeta \right\|_{L^2(\Omega)}^2 \right] \eta_m^n \\
&\quad + \sum_{n=\max\{0; n_0 - \lfloor \frac{\tau}{h} \rfloor\} + 1}^{\max\{0; n_0 - \lfloor \frac{(1-\sigma_2)\tau}{h} \rfloor\}} \left[\int_{\Omega} \mathcal{U}_m^{*n(a)} \zeta^2 - \mathcal{U}_m^{*(n-1)(a)} \zeta^2 \right] \eta_m^n dx,
\end{aligned}$$

where the nonnegative potentials $\mathcal{U}_m^{*n(a)}$ are defined as in Proposition 2.5.10. Moreover, we find

$$\begin{aligned}
& \sum_{n=\max\{0; n_0 - \lfloor \frac{\tau}{h} \rfloor\} + 1}^{\max\{0; n_0 - \lfloor \frac{(1-\sigma_2)\tau}{h} \rfloor\}} \frac{a_0}{2} \left[\left\| p_m^{n(a)} \zeta \right\|_{L^2(\Omega)}^2 - \left\| p_m^{(n-1)(a)} \zeta \right\|_{L^2(\Omega)}^2 \right] \eta_m^n \\
&\geq \sum_{n=\max\{0; n_0 - \lfloor \frac{\tau}{h} \rfloor\} + 1}^{\max\{0; n_0 - \lfloor \frac{(1-\sigma_2)\tau}{h} \rfloor\}} \frac{a_0}{2} \left[\left\| p_m^{n(a)} \zeta \right\|_{L^2(\Omega)}^2 \eta_m^n - \left\| p_m^{(n-1)(a)} \zeta \right\|_{L^2(\Omega)}^2 \eta_m^{n-1} \right]
\end{aligned}$$

$$-h \sum_{n=\max\{0; n_0 - \lfloor \frac{\tau}{h} \rfloor\} + 1}^{\max\{0; n_0 - \lfloor \frac{(1-\sigma_2)\tau}{h} \rfloor\}} \frac{a_0}{2} \left\| p_m^{(n-1)(a)} \zeta \right\|_{L^2(\Omega)}^2 \left[\frac{\eta_m^n - \eta_m^{n-1}}{h} \right].$$

Because of $0 \leq \frac{\eta_n - \eta_{n-1}}{h} \leq \frac{4}{\sigma_2 \tau}$, $\eta_m^{n_0 - \lfloor \frac{\tau}{h} \rfloor} = 0$, $\eta_m^{n_0 - \lfloor \frac{(1-\sigma_2)\tau}{h} \rfloor} = 1$, and $p_m^{0(a)} = 0$, it follows from the preceding inequality

$$\begin{aligned} & \sum_{n=\max\{0; n_0 - \lfloor \frac{\tau}{h} \rfloor\} + 1}^{\max\{0; n_0 - \lfloor \frac{(1-\sigma_2)\tau}{h} \rfloor\}} \frac{a_0}{2} \left[\left\| p_m^{n(a)} \zeta \right\|_{L^2(\Omega)}^2 - \left\| p_m^{(n-1)(a)} \zeta \right\|_{L^2(\Omega)}^2 \right] \eta_m^n \\ & \geq \frac{a_0}{2} \left\| p_m^{\max\{0; n_0 - \lfloor \frac{(1-\sigma_2)\tau}{h} \rfloor\}(a)} \zeta \right\|_{L^2(\Omega)}^2 - \frac{2a_0}{\sigma_2 \tau} h \sum_{n=\max\{0; n_0 - \lfloor \frac{\tau}{h} \rfloor\} + 1}^{\max\{0; n_0 - \lfloor \frac{(1-\sigma_2)\tau}{h} \rfloor\}} \left\| p_m^{(n-1)(a)} \zeta \right\|_{L^2(\Omega)}^2 dx. \quad (5.2.6) \end{aligned}$$

Exploiting the results of Proposition 2.5.10, we find that for all $n \in \{0, \dots, m\}$ the potentials $\mathcal{U}_m^{*n(a)}$ satisfy the following estimate a.e. in Ω

$$\mathcal{U}_m^{*n(a)} \leq \frac{\tilde{b}}{2} \left| p_m^{n(a)} \right|^2$$

with $\tilde{b} = \int_{n_0}^{\infty} \beta(r) dr$ as in Assumption 2.3.6. Thus, we deduce similarly to (5.2.6) the succeeding estimate

$$\begin{aligned} & \sum_{n=\max\{0; n_0 - \lfloor \frac{\tau}{h} \rfloor\} + 1}^{\max\{0; n_0 - \lfloor \frac{(1-\sigma_2)\tau}{h} \rfloor\}} \left[\int_{\Omega} \mathcal{U}_m^{*n(a)} \zeta^2 - \mathcal{U}_m^{*(n-1)(a)} \zeta^2 \right] \eta_m^n dx \\ & \geq \int_{\Omega} \mathcal{U}_m^{*\max\{0; n_0 - \lfloor \frac{(1-\sigma_2)\tau}{h} \rfloor\}(a)} \zeta^2 dx - \frac{4}{\sigma_2 \tau} h \sum_{n=\max\{0; n_0 - \lfloor \frac{\tau}{h} \rfloor\} + 1}^{\max\{0; n_0 - \lfloor \frac{(1-\sigma_2)\tau}{h} \rfloor\}} \int_{\Omega} \mathcal{U}_m^{*(n-1)(a)} \zeta^2 dx \\ & \geq \int_{\Omega} \mathcal{U}_m^{*\max\{0; n_0 - \lfloor \frac{(1-\sigma_2)\tau}{h} \rfloor\}(a)} \zeta^2 dx - \frac{2\tilde{b}}{\sigma_2 \tau} h \sum_{n=\max\{0; n_0 - \lfloor \frac{\tau}{h} \rfloor\} + 1}^{\max\{0; n_0 - \lfloor \frac{(1-\sigma_2)\tau}{h} \rfloor\}} \int_{\Omega} \left| p_m^{(n-1)(a)} \right|^2 \zeta^2 dx. \quad (5.2.7) \end{aligned}$$

Inserting the estimates (5.2.5), (5.2.6), and (5.2.7) into (5.2.4), we arrive at

$$\begin{aligned} & \sum_{n=\max\{0; n_0 - \lfloor \frac{\tau}{h} \rfloor\}}^{n_1} \int_{\Omega} (s_m^n - s_m^{n-1}) p_m^{n(a)} \zeta^2 \eta_m^n dx \\ & \geq \frac{a_0}{2} \left\| p_m^{n_1(a)} \zeta \right\|_{L^2(\Omega)}^2 + \int_{\Omega} \mathcal{U}_m^{*n_1(a)} \zeta^2 dx \\ & \quad - 2 \frac{a_0 + \tilde{b}}{(\sigma_2 \tau)} h \sum_{n=\max\{0; n_0 - \lfloor \frac{\tau}{h} \rfloor\}}^{\max\{0; n_0 - \lfloor \frac{(1-\sigma_2)\tau}{h} \rfloor\} - 1} \left\| p_m^{n(a)} \zeta \right\|_{L^2(\Omega)}^2. \quad (5.2.8) \end{aligned}$$

Taking into account that the potential $\mathcal{U}_m^{*n_1(a)}$ is nonnegative a.e. in Ω , and inserting (5.1.11) and (5.2.8) into (5.2.3) we find

$$\begin{aligned} & \left\| p_m^{n_1(a)} \zeta \right\|_{L^2(\Omega)}^2 + h \sum_{n=n_0-\lfloor \frac{\tau}{h} \rfloor}^{n_1} \int_{\Omega} \left| \nabla p_m^{n(a)} \right|^2 \zeta^2 \eta_m^n dx \\ & \leq \Upsilon_1 \left(\left[(\sigma_1 \varrho)^{-2} + (\sigma_2 \tau)^{-1} \right] h \sum_{n=n_0-\lfloor \frac{\tau}{h} \rfloor}^{n_1} \int_{[A_{a,\varrho}]_m^n} \left| p_m^{n(a)} \right|^2 dx + h \sum_{n=\max\{0; n_0-\lfloor \frac{\tau}{h} \rfloor\}}^{n_1} |[A_{a,\varrho}]_m^n| \right), \end{aligned}$$

where $[A_{a,\varrho}]_m^n$ is as in (5.1.8),

$$\Upsilon_1 := \max \left\{ \frac{2}{a_0}; \frac{4}{\underline{k}} \right\} (c_1; 2(a_0 + \tilde{b})),$$

and c_1 as in (5.1.13). Consequently, taking the maximum over $n_1 \in \{\max\{0; n_0 - \lfloor \frac{\tau}{h} \rfloor\}, \dots, n_0\}$ in the preceding inequality we infer

$$\begin{aligned} & \max_{\max\{0; n_0-\lfloor \frac{\tau}{h} \rfloor\} \leq n \leq n_0} \left\| p_m^{n(a)} \zeta \right\|_{L^2(\Omega)}^2 + h \sum_{n=\max\{0; n_0-\lfloor \frac{\tau}{h} \rfloor\}}^{n_0} \int_{\Omega} \left| \nabla p_m^{n(a)} \right|^2 \zeta^2 \eta_m^n dx \\ & \leq \Upsilon_1 \left[\left[(\sigma_1 \varrho)^{-2} + (\sigma_2 \tau)^{-1} \right] h \sum_{n=\max\{0; n_0-\lfloor \frac{\tau}{h} \rfloor\}}^{n_0} \int_{[A_{a,\varrho}]_m^n} \left| p_m^{n(a)} \right|^2 dx + h \sum_{n=\max\{0; n_0-\lfloor \frac{\tau}{h} \rfloor\}}^{n_0} |[A_{a,\varrho}]_m^n| \right]. \end{aligned}$$

Recalling the construction of the function ζ and the definition (5.1.1) of \bar{p}_m , we conclude that

$$\begin{aligned} & \sup_{\max\{0; t_0-(1-\sigma_2)\tau\} \leq t \leq t_0} \left\| \bar{p}_m^{(a)} \right\|_{L^2(B_{\varrho-\sigma_1\varrho} \cap \Omega)}^2 + \int_{\max\{0; t_0-(1-\sigma_2)\tau\}}^{t_0} \left\| \nabla \bar{p}_m^{(a)} \right\|_{L^2(B_{\varrho-\sigma_1\varrho} \cap \Omega)}^2 dt \\ & \leq \Upsilon_1 \left(\left[(\sigma_1 \varrho)^{-2} + (\sigma_2 \tau)^{-1} \right] \int_{\max\{0; t_0-\tau\}}^{t_0} \left\| \bar{p}_m^{(a)} \right\|_{L^2(B_{\varrho} \cap \Omega)}^2 dt + \int_{\max\{0; t_0-\tau\}}^{t_0} |[A_{a,\varrho}]_m(t)| dt \right) \quad (5.2.9) \end{aligned}$$

is satisfied, where $[A_{a,\varrho}]_m(t)$ as in (5.1.3). In other words, (5.2.1) holds.

Arguing as in the proof of Lemma 5.1.1, we observe that for any $n \in \{\max\{0; n_0 - \lfloor \frac{\tau}{h} \rfloor\}, \dots, n_0\}$ and any level a satisfying conditions (5.1.4) the function

$$\varphi_m^n(x) := p_m^n(x) + h(-p_m^n(x) - a)^+ \zeta^2$$

is an admissible test-function for (4.1.2a), for all $n \in \{\max\{0; n_0 - \lfloor \frac{\tau}{h} \rfloor\}, \dots, n_0\}$ in $Q(\varrho, \tau)$. Repeating the arguments above, we obtain inequality (5.2.9) for the function $-\bar{p}_m$. This implies that $\pm \bar{p}_m$ satisfies inequality (5.2.1) as long as $\tau \geq \sqrt{h}$ and $\sigma_2 \tau \geq 4h$.

② Next, we deal with the case $\sigma_2 \tau < 4h$.

Here, we obviously have

$$\frac{1}{h} < 4(\sigma_2 \tau)^{-1}. \quad (5.2.10)$$

Starting with (5.1.6) we arrive by virtue of Proposition 2.5.10 and estimate (5.1.11) at the following inequality (c.f. (5.1.12))

$$\frac{a_0}{2} \left\| p_m^{n_2(a)} \zeta \right\|_{L^2(\Omega)}^2 + \int_{\Omega} \mathcal{U}_m^{*n_2(a)} \zeta^2 dx + \frac{\underline{k}}{4} h \sum_{n=n_1}^{n_2} \int_{\Omega} \left(\nabla p_m^{n(a)} \right)^2 \zeta^2 dx$$

$$\begin{aligned} &\leq \frac{a_0}{2} \left\| p_m^{(n_1-1)(a)} \zeta \right\|_{L^2(\Omega)}^2 + \int_{\Omega} \mathcal{U}_m^{*(n_1-1)(a)} \zeta^2 dx \\ &\quad + (\sigma_1 \varrho)^{-2} c_1 h \sum_{n=n_1}^{n_2} \int_{[A_{a,\varrho}]_m^n} \left| p_m^{n(a)} \right|^2 dx + c_1 h \sum_{n=n_1}^{n_2} \int_{[A_{a,\varrho}]_m^n} \zeta^2 dx \end{aligned}$$

for any $n_1, n_2 \in \{\max\{0; n_0 - \lfloor \frac{\tau}{h} \rfloor\}, \dots, n_0\}$. Observing that this inequality is trivially satisfied for $n_2 = n_1 - 1$ we obtain with the constant c_1 as in (5.1.13)

$$\begin{aligned} &\max_{n_1-1 \leq n \leq n_2} \frac{a_0}{2} \left\| p_m^{n(a)} \zeta \right\|_{L^2(\Omega)}^2 + \max_{n_1-1 \leq n \leq n_2} \int_{\Omega} \mathcal{U}_m^{*n(a)} \zeta^2 dx + \frac{k}{4} h \sum_{n=n_1}^{n_2} \int_{B_\varrho} \left(\nabla p_m^{n(a)} \right)^2 \zeta^2 dx \\ &\leq \frac{a_0}{2} \left\| p_m^{(n_1-1)(a)} \zeta \right\|_{L^2(\Omega)}^2 + \int_{\Omega} \mathcal{U}_m^{*(n_1-1)(a)} \zeta^2 dx \\ &\quad + (\sigma_1 \varrho)^{-2} c_1 h \sum_{n=n_1}^{n_2} \int_{[A_{a,\varrho}]_m^n} \left| p_m^{n(a)} \right|^2 dx + c_1 h \sum_{n=n_1}^{n_2} |[A_{a,\varrho}]_m^n|, \end{aligned}$$

and therefore

$$\frac{k}{4} h \sum_{n=n_1}^{n_2} \int_{\Omega} \left(\nabla p_m^{n(a)} \right)^2 \zeta^2 dx \leq (\sigma_1 \varrho)^{-2} c_1 h \sum_{n=n_1}^{n_2} \int_{[A_{a,\varrho}]_m^n} \left| p_m^{n(a)} \right|^2 dx + c_1 h \sum_{n=n_1}^{n_2} |[A_{a,\varrho}]_m^n| \quad (5.2.11)$$

holds for any $n_1, n_2 \in \{\max\{0; n_0 - \lfloor \frac{\tau}{h} \rfloor\}, \dots, n_0\}$.

On the other hand, bearing in mind that $\sigma_2 \tau < 4h$, we have that

$$\begin{aligned} \int_{B_{\varrho-\sigma_1 \varrho} \cap \Omega} \left| p_m^{n(a)} \right|^2 dx &\leq \int_{\Omega} \left| p_m^{n(a)} \right|^2 \zeta^2 dx \\ &\leq 4(\sigma_2 \tau)^{-1} h \int_{\Omega} \left| p_m^{n(a)} \right|^2 \zeta^2 dx \\ &\leq 4(\sigma_2 \tau)^{-1} h \sum_{j=n_1}^{n_2} \int_{\Omega} \left| p_m^{j(a)} \right|^2 \zeta^2 dx \end{aligned}$$

is satisfied for any $n \in \{n_1, \dots, n_2\}$ and therefore

$$\max_{n_1 \leq n \leq n_2} \int_{B_{\varrho-\sigma_1 \varrho} \cap \Omega} \left| p_m^{n(a)} \right|^2 dx \leq 4(\sigma_2 \tau)^{-1} h \sum_{n=n_1}^{n_2} \int_{\Omega} \left| p_m^{n(a)} \right|^2 \zeta^2 dx \quad (5.2.12)$$

follows. Adding (5.2.11) and (5.2.12) and choosing

$$n_1 = \max \left\{ 0; n_0 - \left\lfloor \frac{(1-\sigma_2)\tau}{h} \right\rfloor \right\} \quad \text{and} \quad n_2 = n_0,$$

we infer, recalling the construction of the function ζ and the definition (5.1.1) of \bar{p}_m ,

$$\begin{aligned} &\sup_{\max\{0; t_{n_0} - (1-\sigma_2)\tau\} \leq t \leq t_{n_0}} \left\| \bar{p}_m^{(a)} \right\|_{L^2(B_{\varrho-\sigma_1 \varrho} \cap \Omega)}^2 + \int_{\max\{0; t_{n_0} - (1-\sigma_2)\tau\}}^{t_{n_0}} \left\| \nabla \bar{p}_m^{(a)} \right\|_{L^2(B_{\varrho-\sigma_1 \varrho} \cap \Omega)}^2 dt \\ &\leq \Upsilon_2 \left([(\sigma_1 \varrho)^{-2} + (\sigma_2 \tau)^{-1}] \int_{\max\{0; t_{n_0} - \tau\}}^{t_{n_0}} \left\| \bar{p}_m^{(a)} \right\|_{L^2(B_\varrho \cap \Omega)}^2 dt + \int_{\max\{0; t_{n_0} - \tau\}}^{t_{n_0}} |[A_a]_m(t)| dt \right), \end{aligned}$$

where

$$\Upsilon_2 := \max \left\{ 1, \frac{4}{k} \right\} (c_1 + 4).$$

Analogously we obtain this inequality for $-\bar{p}_m$. Hence, setting $\Upsilon = \max\{\Upsilon_1, \Upsilon_2\}$ the functions $\pm \bar{p}_m$ satisfy (5.2.1) as long as $\tau \geq \sqrt{h}$. \square

5.3 Third Estimate

In this section we show, that the functions $\pm \bar{p}_m$ satisfy inequality (A.8.1.2), provided that $\varrho \leq h$. The result is stated in the following lemma

Lemma 5.3.1. *Let $m \in \mathbb{N}$, $h := \frac{T}{m} h < 1$, suppose that Assumptions 3.2.1 - 3.2.5 hold and let the sequence $\{p_m^n\}_{n \in \{0, \dots, m\}}$ be the sequence of solutions to (4.1.2a).*

Let $x_0 \in \bar{\Omega}$, ϱ_0 in Assumption 3.2.2 and denote by $B_\varrho = B_\varrho(x_0)$ the ball centered at x_0 with radius $\varrho > 0$ satisfying $\varrho \leq \min\{h; \varrho_0\}$.

We set $u_m^n = \pm p_m^n$, and $u_m^{n(a)} := (u_m^n - a)^+$ for any $a \in \mathbb{R}$. Then there exists a constant $\Xi > 0$, independent of m, n , and ϱ such that for any $\sigma_1 \in (0, 1)$ and all $n \in \{1, \dots, m\}$

$$\int_{B_{\varrho - \sigma_1 \varrho} \cap \Omega} \left| \nabla u_m^{n(a)} \right|^2 dx \leq \Xi \left[\sigma_1^{-2} \varrho^{-1} \sup_{[A_{a, \varrho}]_m^n} |u_m^n - a|^2 + 1 \right] |[A_{a, \varrho}]_m^n|^{\frac{2}{3}}, \quad (5.3.1)$$

holds, where $[A_{a, \varrho}]_m^n$ is as in (5.1.8) and the levels a satisfy

$$a \geq \sup_{B_\varrho(x_0) \cap \Omega} u_m^n - 2\bar{R}, \quad (5.3.2a)$$

with \bar{R} as in Assumption 3.2.3, as well as

$$\diamond \quad \text{if } u_m^n = p_m^n \quad a \geq \sup_{B_\varrho(x_0) \cap \Gamma'_1} (\gamma_0 p_m^n)^+, \quad (5.3.2b)$$

$$\diamond \quad \text{if } u_m^n = -p_m^n \quad a \geq \sup_{B_\varrho(x_0) \cap \Gamma_1} -(\gamma_0 p_m^n)^+, \quad (5.3.2c)$$

with the classical convention $\sup_{(x,t) \in \emptyset} u(x,t) = -\infty$.

Proof: Again, the proof follows the arguments of [34]. So let x_0 and ϱ_0 be as above and $n \in \{1, \dots, m\}$. Let $\sigma_1 \in (0, 1)$ be arbitrary, and $\varrho > 0$ satisfying $\varrho \leq \min\{h; \varrho_0\}$.

For $0 < \sigma_1 < 1$ let $\zeta \in C_0^1(\mathbb{R}^3)$ be as in (5.1.5).

Again, as in the proof of Lemma 5.1.1, we see that the function

$$\phi_m^n = p_m^n - h [(p_m^n - a)^+] \zeta^2 =: p_m^n - h \zeta^2 [p_m^{n(a)}]$$

is an admissible test-function for (4.1.2a) provided that the levels a satisfy condition (5.3.2).

Application of ϕ_m^n as a test-function (4.1.2a) at the time step $n \in \{1, \dots, m\}$ yields

$$\int_{\Omega} \left((s_m^n - s_m^{n-1}) p_m^{n(a)} \zeta^2 + h k_m^{n-1} \nabla (p_m^n + z) \cdot \nabla (p_m^{n(a)} \zeta^2) \right) dx \leq 0. \quad (5.3.3)$$

Setting $\tilde{M} = \max\{\bar{s}, \bar{R}\}$, where \bar{R} and \bar{s} are as in Assumption 3.2.3, we obtain by virtue of our assumption $\varrho \leq h$, with $|B_1(0)|$ being the volume of the unit sphere in \mathbb{R}^3

$$1 \leq \frac{1}{h} \leq \frac{1}{\varrho} = |B_1(0)|^{\frac{1}{3}} |B_\varrho|^{-\frac{1}{3}}.$$

Moreover, due to (5.3.2a) it follows

$$p_m^n - a \Big|_{B_\varrho(x_0) \cap \Omega} \leq 2\tilde{M}.$$

On the other hand, the set $[A_{a,\varrho}]_m^n$ defined in (5.1.8) satisfies $[A_{a,\varrho}]_m^n \subset B_\varrho(x_0)$, and therefore we find

$$\begin{aligned} \frac{1}{h} \left| \int_{\Omega} (s_m^n - s_m^{n-1}) p_m^{n(a)} \zeta^2 dx \right| &\leq 4\tilde{M}^2 h^{-1} |[A_{a,\varrho}]_m^n| \\ &\leq 4\tilde{M}^2 |B_1(0)|^{\frac{1}{3}} |B_\varrho|^{-\frac{1}{3}} |[A_{a,\varrho}]_m^n| \\ &\leq 4\tilde{M}^2 |B_1(0)|^{\frac{1}{3}} |[A_{a,\varrho}]_m^n|^{\frac{2}{3}}. \end{aligned} \quad (5.3.4)$$

Keeping in mind, that $\varrho \leq h$, we obtain from (5.3.3), with the help of (5.1.11) and (5.3.4)

$$\begin{aligned} \int_{B_{\varrho-\sigma_1\varrho} \cap \Omega} |\nabla p_m^{n(a)}|^2 dx &\leq \frac{4}{\underline{k}} c_1 \left((\sigma_1\varrho)^{-2} \int_{[A_{a,\varrho}]_m^n} |p_m^{n(a)}|^2 dx + |[A_{a,\varrho}]_m^n| \right) \\ &\quad + \frac{16}{\underline{k}} \tilde{M}^2 |B_1(0)|^{\frac{1}{3}} |[A_{a,\varrho}]_m^n|^{\frac{2}{3}} \\ &\leq \Xi \left[\sigma_1^{-2} \varrho^{-1} \sup_{[A_{a,\varrho}]_m^n} |p_m^n - a|^2 + 1 \right] |[A_{a,\varrho}]_m^n|^{\frac{2}{3}}, \end{aligned} \quad (5.3.5)$$

where c_1 is as in (5.1.13) and

$$\Xi := \frac{4}{\underline{k}} \max \left\{ c_1 |B_1(0)|^{\frac{1}{3}}; c_1 |\Omega|^{\frac{1}{3}} + 4\tilde{M}^2 |B_1(0)|^{\frac{1}{3}} \right\}. \quad (5.3.6)$$

Consequently, p_m^n satisfies (5.3.1), provided that $\varrho \leq h$.

Applying $\varphi_m^n := p_m^n + h [(-p_m^n - a)^+] \zeta^2$, where the levels a are chosen according to (5.3.2), as a test-function in (4.1.2a) at the time step n and arguing as above, we obtain estimate (5.3.5) for the function $-p_m^n$. Thus, $\pm p_m^n$ satisfies (5.3.1) for all $n \in \{1, \dots, m\}$ with Ξ as in (5.3.6). \square

5.4 Oscillation Decay Estimates for Approximate Solutions

Let us now prove the main result of this chapter which reads as follows

Proposition 5.4.1. *Suppose that Assumptions 3.2.1 - 3.2.5 hold, and let $m \in \mathbb{N}$, $h := \frac{T}{m}$, such that*

$$h < \min \left\{ \theta^2, \theta^{-\frac{2}{3}}, \frac{1}{36} \right\}$$

with θ as in Lemma A.8.9. Let ϱ_0 be as in Assumption 3.2.2, and $\tau_0 > 0$. Further, let the sequence $\{p_m^n\}_{n \in \{0, \dots, m\}}$ be the sequence of solutions to Problem 4.1.1, $\{w_m^n\}_{n \in \{0, \dots, m\}}$ defined according to (4.1.2d), and $\{s_m^n\}_{n \in \{0, \dots, m\}} = \{a_0 p_m^n + w_m^n\}_{n \in \{0, \dots, m\}}$.

Then there exist numbers $0 < \mu_2$ and α , with $0 < \alpha < 1$, independent of n, m , such that

$$\text{osc} \{p_m^n; \Omega \cap B_\varrho(x_0)\}, \text{osc} \{s_m^n; \Omega \cap B_\varrho(x_0)\} \leq \mu_2 \varrho^\alpha \quad \text{for } 0 \leq n \leq m \quad (5.4.1)$$

are satisfied for any ball $B_\varrho(x_0) \subset \mathbb{R}^3$ centered at $x_0 \in \bar{\Omega}$ with radius $\varrho \leq \varrho_0$, and

$$\left| p_m^n(x) - p_m^{n'}(x) \right|, \left| s_m^n(x) - s_m^{n'}(x) \right| \leq \mu_2 [(n - n')h]^{\frac{\alpha}{4}} \quad (5.4.2)$$

hold for any $x \in \Omega$ and any positive integers n and n' with $0 \leq n' \leq n \leq m$ and $(n - n')h < 1$.

Proof: Due to Propositions 4.2.1 and 4.3.1 we know that the piecewise constant time interpolate \bar{p}_m of the sequence $\{p_m^n\}_{n \in \{0, \dots, m\}}$, defined by (5.1.1), satisfies (A.8.2.1) where we can take $M = \bar{R}$ with \bar{R} as in Assumption 3.2.3.

Moreover, Lemmata 5.1.1 and 5.2.1 yield, that $\pm \bar{p}_m$ fulfill (A.8.2.2a) and (A.8.2.2b) for any ϱ, τ with the restriction $0 < \varrho \leq \varrho_0$, $\sqrt{h} \leq \tau \leq \tau_0$, and all $\sigma_1, \sigma_2 \in (0, 1)$. In addition, by virtue of Lemma 5.3.1 the functions $\pm p_m^n$ satisfy (A.8.1.2) for all $n \in \{1, \dots, m\}$ and any $0 < \varrho \leq \varrho_0$, and $\varrho \leq h$.

Let us now consider the sequence $\{p_{m+1}^n\}_{n \in \{0, \dots, m+1\}}$ defined by

$$p_{m+1}^0 = p_m^0, \quad \text{and} \quad p_{m+1}^n = p_m^{n-1} \quad \text{for } n = 1, 2, \dots, m+1.$$

Then, clearly the piecewise constant time interpolate \bar{p}_{m+1} of $\{p_{m+1}^n\}_{n \in \{0, \dots, m+1\}}$, defined according to formula (5.1.1), satisfies (A.8.2.1) with the constant M as above, where the time instant T is replaced by $T + h$ and the space-time cylinder Q is replaced by $Q_h := \Omega \times (0, T + h)$.

Moreover, $\pm \bar{p}_{m+1}$ fulfill (A.8.2.2a) and (A.8.2.2b) in Q_h for any ϱ, τ with the restriction $0 < \varrho \leq \varrho_0$, $\sqrt{h} \leq \tau \leq \tau_0$, and all $\sigma_1, \sigma_2 \in (0, 1)$.

In addition, by virtue of Assumption 3.2.5, the functions $\pm p_m^0$ satisfy (A.8.1.2), and consequently $\pm p_m^n$ satisfy (A.8.1.2) for all $n \in \{1, \dots, m+1\}$ and any $0 < \varrho \leq \varrho_0$, and $\varrho \leq h$.

Therefore, the sequence $\{p_m^n\}_{n \in \{0, \dots, m+1\}}$ meets the requirements of Theorem A.8.16. Thus, according to Theorem A.8.16, there exist numbers $0 < \bar{\mu}_2$ and α with $0 < \alpha < 1$, independent of n, m , such that

$$\text{osc} \{p_{m+1}^n; \Omega \cap B_\varrho(x_0)\} \leq \bar{\mu}_2 \varrho^\alpha \quad \text{for } 1 \leq n \leq m+1 \quad (5.4.3)$$

is satisfied for any ball $B_\varrho(x_0) \subset \mathbb{R}^3$ centered at $x_0 \in \bar{\Omega}$ with radius $\varrho \leq \varrho_0$, ϱ_0 as in Assumption 3.2.2, and

$$\left| p_{m+1}^n(x) - p_{m+1}^{n'}(x) \right| \leq \bar{\mu}_2 [(n - n')h]^{\frac{\alpha}{4}} \quad (5.4.4)$$

holds for any $x \in \Omega$ and any positive integers n and n' with $1 \leq n' \leq n \leq m+1$ and $(n - n')h < 1$.

Recalling the construction of the sequence $\{p_{m+1}^n\}_{n \in \{0, \dots, m+1\}}$, we have in particular for any $x_1, x_2 \in B_\varrho(x_0) \cap \Omega$

$$\frac{|p_m^n(x_1) - p_m^n(x_2)|}{|x_1 - x_2|^\alpha} \leq \bar{\mu}_2, \quad \text{for any } 0 \leq n \leq m,$$

as well as

$$\frac{|p_m^{n_1}(x) - p_m^{n_2}(x)|}{|(n_1 - n_2)h|^{\frac{\alpha}{4}}} \leq \bar{\mu}_2 \quad \text{for a.a. } x \in \Omega$$

for any $0 \leq n_2 < n_1 \leq m$ with $(n_1 - n_2)h < 1$.

Let the sequence $\{w_m^n\}_{n \in \{0, \dots, m\}}$ be defined according to (4.1.2d). Then, due to Proposition 2.3.9 the following inequality holds

$$|w_m^n(x_1) - w_m^n(x_2)| \leq \int_0^{\bar{R}} |\lambda(x_1, r) - \lambda(x_2, r)| \beta(r) dr + \tilde{b}(\bar{R}) \max_{0 \leq j \leq n} |p_m^j(x_1) - p_m^j(x_2)|,$$

where \bar{R} is as in Assumption 3.2.3. Thus, we find

$$|w_m^n(x_1) - w_m^n(x_2)| \leq \left[\int_0^{\bar{R}} \langle \lambda(\cdot, r) \rangle_{\alpha, \Omega} \beta(r) dr + \tilde{b}(\bar{R}) \bar{\mu}_2 \right] |x_1 - x_2|^\alpha,$$

where $\langle \lambda(\cdot, r) \rangle_{\alpha, \Omega}$ denotes the Hölder-seminorm of $\lambda(\cdot, r)$, defined in (A.2.1). As by virtue of Assumption 3.2.5 the expression

$$\int_0^{\bar{R}} \langle \lambda(\cdot, r) \rangle_{\Omega}^{(\alpha)} \beta(r) dr$$

is bounded independently of m, n, ϱ , we infer, setting

$$\check{\mu}_2 := \tilde{b}(\bar{R}) \bar{\mu}_2 + \int_0^{\bar{R}} \langle \lambda(\cdot, r) \rangle_{\Omega}^{(\alpha)} \beta(r) dr,$$

that for all $0 \leq n \leq m$ the estimate

$$\text{osc} \{w_m^n; \Omega \cap B_\varrho(x_0)\} \leq \check{\mu}_2 \varrho^\alpha \quad (5.4.5)$$

is satisfied for any ball $B_\varrho(x_0) \subset \mathbb{R}^3$ with radius $\varrho \leq \varrho_0$.

Now let $x \in \Omega$ be arbitrary, and take $0 \leq n_2 < n_1 \leq m$. Then we clearly have

$$|w_m^{n_1}(x) - w_m^{n_2}(x)| = |w_m^{n_1}(x) - \tilde{w}_m^{n_1}(x)|,$$

where $\{\tilde{w}_m^n\}_{n \in \{0, \dots, m\}}$ is the output of the discretized Preisach operator, defined by (4.1.2d), corresponding to the initial configuration $\lambda(x, \cdot)$, and the input sequence $\{v_m^n\}_{n \in \{0, \dots, m\}}$, defined as follows

$$v_m^n(x) := \begin{cases} p_m^0(x), & \text{for } 0 \leq n \leq n_1 - n_2, \\ p_m^{n - (n_1 - n_2)}(x) & \text{for } n_1 - n_2 \leq n \leq m. \end{cases}$$

With the help of Proposition 2.3.9 we then calculate

$$\begin{aligned} |w_m^{n_1}(x) - w_m^{n_2}(x)| &= |w_m^{n_1}(x) - \tilde{w}_m^{n_1}(x)| \\ &\leq \tilde{b}(\bar{R}) \max_{0 \leq n \leq n_1} |p_m^n(x) - v_m^n(x)| \leq \tilde{b}(\bar{R}) \bar{\mu}_2 |(n_1 - n_2)h|^{\frac{\alpha}{4}}. \end{aligned}$$

Hence,

$$\left| w_m^n(x) - w_m^{n'}(x) \right| \leq \check{\mu}_2 [(n - n')h]^{\frac{\alpha}{4}} \quad (5.4.6)$$

holds for any $x \in \Omega$ and any positive integers n and n' with $0 \leq n' \leq n \leq m$ and $(n - n')h < 1$. Bearing in mind the definition of the sequence $\{s_m^n\}_{n \in \{0, \dots, m\}}$, we can set $\mu_2 := \max \{\bar{\mu}_2; a_0 \bar{\mu}_2 + \check{\mu}_2\}$ and the proof is complete. \square

CHAPTER 6

ESTIMATES OF THE TIME DERIVATIVE

In this chapter we will prove that the sequence of solutions $\{p_m^n\}_{n \in \{1, \dots, m\}}$ of our approximate Problem 4.1.1 satisfies the following estimate

$$\left\| \frac{p_m^l - p_m^{l-1}}{h} \right\|_{L^2(\Omega)}^2 + h \sum_{n=1}^l \left\| \frac{\nabla p_m^n - \nabla p_m^{n-1}}{h} \right\|_{L^2(\Omega)}^2 \leq C \quad \forall l \in \{1, \dots, m\},$$

where the constant C is independent of m and l .

The proof of this result will be quite challenging. Indeed, the natural way to obtain this kind of estimate, would be based on building the incremental time ratio of the variational inequality (4.1.2a), by taking in (4.1.2a) at the time step n the test-function $\phi_m^n = [p_m^{n-1} + \tilde{P}_m^n - \tilde{P}_m^{n-1}]$ and at time step $n-1$ the test-function $\phi_m^{n-1} = [p_m^n + \tilde{P}_m^{n-1} - \tilde{P}_m^n]$ and then adding both inequalities. If we would be able to make use of the Second Order Energy Inequality for the Preisach operator, we would obtain, after application of Hölder's inequality and summation over n , an inequality of the following form:

$$\begin{aligned} \left\| \frac{p_m^l - p_m^{l-1}}{h} \right\|_{L^2(\Omega)}^2 + h \sum_{n=1}^l \left\| \frac{\nabla p_m^n - \nabla p_m^{n-1}}{h} \right\|_{L^2(\Omega)}^2 \\ \leq c + ch \sum_{n=1}^l \left\| \frac{p_m^n - p_m^{n-1}}{h} \right\|_{L^2(\Omega)}^2 + ch \sum_{n=1}^l \int_{\Omega} \left| \frac{p_m^n - p_m^{n-1}}{h} \right|^2 |\nabla p_m^n + \hat{z}|^2 dx. \end{aligned}$$

Unfortunately, problems with further estimating arise from the lack of an obvious possibility to estimate the last term on the right-hand side in a suitable way. Moreover, the derivation of the above inequality becomes problematic, since the hysteresis loops are not necessarily convex, and thus the Second Order Energy Inequality for Preisach operators does not hold.

The solution to the depicted difficulties lies in the application of Proposition 2.5.12 (as a replacement for the Second Order Energy Inequality), and also in the exploitation of Hölder continuity of the approximate solution p_m^n in $\bar{\Omega}$. As the estimates are quite long we will split the proof in

several smaller lemmata. In the following section we will prove some technical results making use of the $C^{0,\alpha}(\bar{\Omega})$ regularity of the functions p_m^n .

6.1 Some Preliminary Results

Throughout this chapter, let us denote for $m \in \mathbb{N}$, $h = T/m$, and a sequence $\{y_m^n\}_{n \in \{0, \dots, m\}}$ the incremental time ratio \dot{y}_m^n of $\{y_m^n\}_{n \in \{0, \dots, m\}}$ by

$$\dot{y}_m^n := \frac{y_m^n - y_m^{n-1}}{h}, \quad \text{for } n \in \{1, \dots, m\}.$$

The aim of this section is to find a way, how we could estimate the integral expressions

$$\int_{\Omega} |\dot{s}_m^n| |\dot{p}_m^n|^2 \zeta^2 dx \quad \text{and} \quad \int_{\Omega} |\dot{p}_m^n|^2 |\nabla p_m^n + \hat{z}|^2 \zeta^2 dx,$$

where (s_m^n, p_m^n) are the pair of solutions to Problem 4.1.1 at the time steps $n = 1, \dots, m$ and ζ is a nonnegative cut-off function. The first estimate is provided by Lemma 6.1.1 and the second is provided by Lemma 6.1.3 at the end of this section.

We start with the following result.

Lemma 6.1.1. *Suppose that Assumptions 3.2.1- 3.2.5 hold. Let $m \in \mathbb{N}$, $h := \frac{T}{m}$ and $\{p_m^n\}_{n \in \{1, \dots, m\}}$ be the sequence of solutions to Problem (4.1.1). Moreover, assume that with \bar{R} as in Assumption 3.2.3*

$$h \leq \frac{1}{4\bar{R}}$$

holds. For any $\varrho_0 > 0$ and $x_0 \in \bar{\Omega}$ let $\zeta \in C_0^1(\mathbb{R}^3)$, $0 \leq \zeta \leq 1$, be a cut-off function with the property

$$\zeta(x) = \begin{cases} 1 & \text{for } x \in B_{\varrho_0}, \\ 0 & \text{for } x \in \mathbb{R}^3 \setminus B_{2\varrho_0} \end{cases} \quad |\nabla \zeta| \leq \frac{2}{\varrho_0}, \quad (6.1.1)$$

where B_{ϱ_0} ($B_{2\varrho_0}$) denotes the ball centered at x_0 with radius ϱ_0 ($2\varrho_0$ resp.). Then for all $\epsilon > 0$ and all $l \in \{1, \dots, m\}$ the following inequality holds

$$\begin{aligned} h \sum_{n=1}^l \int_{\Omega} |\dot{s}_m^n| |\dot{p}_m^n|^2 \zeta^2 \leq & \frac{1}{\epsilon} h \sum_{n=1}^l \int_{\Omega} |\dot{p}_m^n|^2 |\nabla p_m^n + \hat{z}|^2 \zeta^2 dx + 3\bar{k}^2 \epsilon h \sum_{n=1}^l \|\nabla \dot{p}_m^n \zeta\|_{L^2(\Omega)}^2 \\ & + \hat{C}_1(\varrho_0)(1 + \epsilon) h \sum_{n=1}^l \|\dot{p}_m^n\|_{L^2(\Omega)}^2 + \hat{C}_1(\varrho_0) \frac{1 + \epsilon^2}{\epsilon}, \end{aligned} \quad (6.1.2)$$

where

$$\hat{C}_1(\varrho_0) := \bar{k}^2 \|\nabla \dot{P}\|_{L^2(Q)}^2 + \frac{\mu_1}{4} \|\dot{P}\|_{L^\infty(Q)}^2 + (a_0 + \tilde{b}(\bar{R})) \|\dot{P}\|_{L^\infty(Q)} + \frac{32\bar{k}^2}{\varrho_0^2} \|\dot{P}\|_{L^2(Q)}^2 + \frac{32\bar{k}^2}{\varrho_0^2}.$$

with \bar{k} as in Assumption 3.2.4, a_0 and \bar{R} as in Assumption 3.2.3, $\tilde{b}(\bar{R})$ as in Assumption 2.3.6, and μ_1 as in Proposition 4.3.1.

Proof: Let $\varrho_0 > 0$, $x_0 \in \bar{\Omega}$ be arbitrary, $\zeta \in C_0^1(\mathbb{R}^3)$ be a cut-off function as in (6.1.1), and $n \in \{1, \dots, m\}$.

Making use of Assumption 3.2.3 on the Preisach operator, and of the boundedness of the approximate solutions obtained in Proposition 4.2.1, the monotonicity property of the Preisach operator (see Proposition 2.5.5) yields the following estimate for all $n \in \{1, \dots, m\}$ a.e. in Ω

$$0 \leq \dot{s}_m^n \dot{p}_m^n \leq (a_0 + \tilde{b}(\bar{R})) |\dot{p}_m^n|^2,$$

where \bar{R} is as in Assumption 3.2.3 and $\tilde{b}(\bar{R})$ is as in Assumption 2.3.6. Therefore, it follows

$$\begin{aligned} h \sum_{n=1}^l \int_{\Omega} |\dot{s}_m^n| |\dot{p}_m^n|^2 \zeta^2 dx &= h \sum_{n=1}^l \int_{\Omega} \dot{s}_m^n \dot{p}_m^n |\dot{p}_m^n| \zeta^2 dx \\ &= h \sum_{n=1}^l \int_{\Omega} \dot{s}_m^n \left[\dot{p}_m^n - \dot{\tilde{P}}_m^n \right] |\dot{p}_m^n| \zeta^2 dx + h \sum_{n=1}^l \int_{\Omega} \dot{s}_m^n \dot{\tilde{P}}_m^n |\dot{p}_m^n| \zeta^2 dx \\ &\leq h \sum_{n=1}^l \int_{\Omega} \dot{s}_m^n \left[\dot{p}_m^n - \dot{\tilde{P}}_m^n \right] |\dot{p}_m^n| \zeta^2 dx \\ &\quad + (a_0 + \tilde{b}(\bar{R})) \left\| \dot{\tilde{P}}_m^n \right\|_{L^\infty(\Omega)} h \sum_{n=1}^l \left\| \dot{p}_m^n \zeta \right\|_{L^2(\Omega)}^2, \end{aligned} \quad (6.1.3)$$

We claim, that for all $n \in \{1, \dots, m\}$ the functions

$$\phi_m^n := p_m^n - h^3 \left[\dot{p}_m^n - \dot{\tilde{P}}_m^n \right] |\dot{p}_m^n| \zeta^2.$$

belong to K_m^n . Indeed,

- ① Let $x \in \Gamma_1$, such that $\gamma_0 p_m^n(x) > 0$. Hence, by virtue of Assumption 3.2.1 also $\gamma_0 p_m^{n-1}(x) > 0$, and we find, that $\gamma_0 \dot{p}_m^n(x) = \dot{\tilde{P}}_m^n(x)$. Consequently, $\gamma_0 \phi_m^n(x) = \gamma_0 p_m^n(x)$ follows.
- ② Let now $x \in \Gamma_1$, such that $\gamma_0 p_m^n(x) \leq 0$. Then again Assumption 3.2.1 yields $\gamma_0 p_m^{n-1}(x) \leq 0$, and we follow, that $\dot{\tilde{P}}_m^n(x) = 0$. Keeping in mind that $\gamma_0 p_m^{n-1}(x) \leq 0$ holds, we obtain

$$\begin{aligned} \gamma_0 \phi_m^n(x) &= \gamma_0 p_m^n(x) - h^2 (\gamma_0 p_m^n(x) - \gamma_0 p_m^{n-1}(x)) \gamma_0 |\dot{p}_m^n(x)| \zeta^2(x) \\ &= \gamma_0 p_m^n(x) [1 - h^2 \gamma_0 |\dot{p}_m^n(x)| \zeta^2(x)] + h^2 \gamma_0 p_m^{n-1}(x) \gamma_0 |\dot{p}_m^n(x)| \zeta^2(x) \\ &\leq \gamma_0 p_m^n(x) [1 - h^2 \gamma_0 |\dot{p}_m^n(x)| \zeta^2(x)]. \end{aligned}$$

Moreover, our assumptions $h \leq \frac{1}{4\bar{R}}$ and $\zeta \leq 1$ yield

$$h^2 \gamma_0 |\dot{p}_m^n(x)| \zeta^2(x) \leq \frac{2 \max_{0 \leq n \leq m} \|p_m^n\|_{L^\infty(\Omega)}}{4\bar{R}} \leq \frac{\bar{R}}{2\bar{R}} = \frac{1}{2},$$

and therefore $(\gamma_0 \phi_m^n)^+ = 0 = (\gamma_0 p_m^n)^+$ a.e. on Γ_1 follows.

Choosing in (4.1.2a) at the time step $n \in \{1, \dots, m\}$ the test-function ϕ_m^n and summing the resulting inequalities over $n \in \{1, \dots, l\}$ with $l \in \{1, \dots, m\}$ we obtain

$$h^3 \sum_{n=1}^l \int_{\Omega} \dot{s}_m^n \left[\dot{p}_m^n - \dot{\tilde{P}}_m^n \right] |\dot{p}_m^n| \zeta^2 dx + h^3 \sum_{n=1}^l \int_{\Omega} k_m^{n-1} (\nabla p_m^n + \hat{z}) \cdot \nabla \left(\left[\dot{p}_m^n - \dot{\tilde{P}}_m^n \right] |\dot{p}_m^n| \zeta^2 \right) dx \leq 0,$$

which in turn implies

$$h \sum_{n=1}^l \int_{\Omega} \dot{s}_m^n \left[\dot{p}_m^n - \dot{\tilde{P}}_m^n \right] |\dot{p}_m^n| \zeta^2 dx + h \sum_{n=1}^l \int_{\Omega} k_m^{n-1} (\nabla p_m^n + \hat{z}) \cdot \nabla \left(\left[\dot{p}_m^n - \dot{\tilde{P}}_m^n \right] |\dot{p}_m^n| \zeta^2 \right) dx \leq 0. \quad (6.1.4)$$

To establish inequality (6.1.2), we have to estimate the second term of the left-hand side of (6.1.4).

First, a simple computation yields

$$\begin{aligned} \nabla \left(\left[\dot{p}_m^n - \dot{\tilde{P}}_m^n \right] |\dot{p}_m^n| \zeta^2 \right) &= \left[\nabla \dot{p}_m^n - \nabla \dot{\tilde{P}}_m^n \right] |\dot{p}_m^n| \zeta^2 \\ &\quad + \left[\dot{p}_m^n - \dot{\tilde{P}}_m^n \right] \nabla |\dot{p}_m^n| \zeta^2 + 2 \left[\dot{p}_m^n - \dot{\tilde{P}}_m^n \right] |\dot{p}_m^n| \zeta \nabla \zeta \end{aligned}$$

for all $n \in \{1, \dots, m\}$ a.e. in Ω . Since $|\nabla |\dot{p}_m^n|| \leq |\nabla \dot{p}_m^n|$ clearly holds for all $n \in \{1, \dots, m\}$ a.e. in Ω , we obtain:

- ① With the help of Proposition 4.2.1 we have $0 < \underline{k} \leq k_m^n \leq \bar{k}$ for any $n \in \{0, \dots, m\}$ a.e. in Ω , and therefore Young's inequality implies for an arbitrary $\epsilon > 0$

$$\begin{aligned} &h \sum_{n=1}^l \int_{\Omega} k_m^{n-1} |\nabla p_m^n + \hat{z}| \left[|\nabla \dot{p}_m^n| + |\nabla \dot{\tilde{P}}_m^n| \right] |\dot{p}_m^n| \zeta^2 dx \\ &\leq h \sum_{n=1}^l \int_{\Omega} \bar{k} |\dot{p}_m^n| |\nabla p_m^n + \hat{z}| |\nabla \dot{p}_m^n| \zeta^2 dx + h \sum_{n=1}^l \int_{\Omega} \bar{k} |\dot{p}_m^n| |\nabla p_m^n + \hat{z}| \left| \nabla \dot{\tilde{P}}_m^n \right| \zeta^2 dx \\ &\leq \frac{1}{2\epsilon} h \sum_{n=1}^l \int_{\Omega} |\dot{p}_m^n|^2 |\nabla p_m^n + \hat{z}|^2 \zeta^2 dx \\ &\quad + \bar{k}^2 \epsilon h \sum_{n=1}^l \left\| \nabla \dot{p}_m^n \zeta \right\|_{L^2(\Omega)}^2 + \bar{k}^2 \epsilon \left\| \nabla \dot{\tilde{P}}_m^n \right\|_{L^2(Q)}^2. \quad (6.1.5) \end{aligned}$$

- ② Similarly, it follows

$$\begin{aligned} &h \sum_{n=1}^l \int_{\Omega} k_m^{n-1} |\nabla p_m^n + \hat{z}| \left[|\dot{p}_m^n| + \left| \dot{\tilde{P}}_m^n \right| \right] \nabla |\dot{p}_m^n| \zeta^2 dx \\ &\leq h \sum_{n=1}^l \int_{\Omega} \bar{k} |\dot{p}_m^n| |\nabla p_m^n + \hat{z}| |\nabla \dot{p}_m^n| \zeta^2 dx + h \sum_{n=1}^l \int_{\Omega} \bar{k} |\nabla p_m^n + \hat{z}| |\nabla \dot{p}_m^n| \left| \dot{\tilde{P}}_m^n \right| \zeta^2 dx \\ &\leq \frac{1}{4\epsilon} h \sum_{n=1}^l \int_{\Omega} |\dot{p}_m^n|^2 |\nabla p_m^n + \hat{z}|^2 \zeta^2 dx + 2\bar{k}^2 \epsilon h \sum_{n=1}^l \left\| \nabla \dot{p}_m^n \zeta \right\|_{L^2(\Omega)}^2 \\ &\quad + \frac{1}{4\epsilon} \left\| \dot{\tilde{P}}_m^n \right\|_{L^\infty(Q)}^2 h \sum_{n=1}^l \left\| \nabla p_m^n + \hat{z} \right\|_{L^2(\Omega)}^2. \end{aligned}$$

Now, Proposition 4.3.1 yields

$$h \sum_{n=1}^l \|\nabla p_m^n + \hat{z}\|_{L^2(\Omega)}^2 \leq \mu_1,$$

with μ_1 as in Proposition 4.3.1, and as a consequence we deduce the following estimate

$$\begin{aligned} & h \sum_{n=1}^l \int_{\Omega} k_m^{n-1} |\nabla p_m^n + \hat{z}| \left[|\dot{p}_m^n| + \left| \dot{\tilde{P}}_m^n \right| \right] |\nabla p_m^n| \zeta^2 dx \\ & \leq \frac{1}{4\epsilon} h \sum_{n=1}^l \int_{\Omega} |\dot{p}_m^n|^2 |\nabla p_m^n + \hat{z}|^2 \zeta^2 dx + 2\bar{k}^2 \epsilon h \sum_{n=1}^l \|\nabla \dot{p}_m^n \zeta\|_{L^2(\Omega)}^2 + \frac{1}{4\epsilon} \|\dot{\tilde{P}}\|_{L^\infty(Q)}^2 \mu_1. \end{aligned} \quad (6.1.6)$$

③ Moreover, by construction $|\nabla \zeta| \leq \frac{2}{\varrho_0}$ holds, and as in ① and in ② we infer

$$\begin{aligned} & h \sum_{n=1}^l \int_{\Omega} 2k_m^{n-1} |\nabla p_m^n + \hat{z}| \left[|\dot{p}_m^n| + \left| \dot{\tilde{P}}_m^n \right| \right] |\dot{p}_m^n| \zeta |\nabla \zeta| dx \\ & \leq h \sum_{n=1}^l \int_{\Omega} 2\bar{k} |\dot{p}_m^n|^2 |\nabla p_m^n + \hat{z}| \zeta |\nabla \zeta| dx + h \sum_{n=1}^l \int_{\Omega} 2\bar{k} |\dot{p}_m^n| |\nabla p_m^n + \hat{z}| \left| \dot{\tilde{P}}_m^n \right| \zeta |\nabla \zeta| dx \\ & \leq \frac{1}{4\epsilon} h \sum_{n=1}^l \int_{\Omega} |\dot{p}_m^n|^2 |\nabla p_m^n + \hat{z}|^2 \zeta^2 dx + 8\bar{k}^2 \epsilon h \sum_{n=1}^l \|\dot{p}_m^n \nabla \zeta\|_{L^2(\Omega)}^2 + 8\bar{k}^2 \epsilon \|\dot{\tilde{P}} \nabla \zeta\|_{L^2(Q)}^2 \\ & \leq \frac{1}{4\epsilon} h \sum_{n=1}^l \int_{\Omega} |\dot{p}_m^n|^2 |\nabla p_m^n + \hat{z}|^2 \zeta^2 dx + \frac{32\bar{k}^2}{\varrho_0^2} \epsilon h \sum_{n=1}^l \|\dot{p}_m^n\|_{L^2(\Omega)}^2 + \frac{32\bar{k}^2}{\varrho_0^2} \epsilon \|\dot{\tilde{P}}\|_{L^2(Q)}^2. \end{aligned} \quad (6.1.7)$$

The regularity of the boundary data \tilde{P} stated in Assumption 3.2.1 together with the statement of Proposition 4.3.1 yields that the quantity

$$\hat{c}_0(\varrho_0) := \bar{k}^2 \|\nabla \dot{\tilde{P}}\|_{L^2(Q)}^2 + \frac{1}{4} \|\dot{\tilde{P}}\|_{L^\infty(Q)}^2 \mu_1 + \frac{32\bar{k}^2}{\varrho_0^2} \|\dot{\tilde{P}}\|_{L^2(Q)}^2$$

is bounded independently of m, n . Therefore, assembling the estimates (6.1.5) - (6.1.7) we find

$$\begin{aligned} & h \sum_{n=1}^l \left| \int_{\Omega} k_m^{n-1} (\nabla p_m^n + \hat{z}) \cdot \nabla \left(\left[\dot{p}_m^n - \dot{\tilde{P}}_m^n \right] |\dot{p}_m^n| \zeta^2 \right) dx \right| \\ & \leq \frac{1}{\epsilon} h \sum_{n=1}^l \int_{\Omega} |\dot{p}_m^n|^2 |\nabla p_m^n + \hat{z}|^2 \zeta^2 dx + 3\bar{k}^2 \epsilon h \sum_{n=1}^l \|\nabla \dot{p}_m^n \zeta\|_{L^2(\Omega)}^2 \\ & \quad + \frac{32\bar{k}^2}{\varrho_0^2} \epsilon h \sum_{n=1}^l \|\dot{p}_m^n\|_{L^2(\Omega)}^2 + \hat{c}_0(\varrho_0) \left[\epsilon + \frac{1}{\epsilon} \right]. \end{aligned} \quad (6.1.8)$$

Inserting (6.1.8) into (6.1.4) and setting

$$\hat{c}_1(\varrho_0) := \frac{32\bar{k}^2}{\varrho_0^2} + \hat{c}_0(\varrho_0),$$

we conclude

$$\begin{aligned}
& h \sum_{n=1}^l \int_{\Omega} \dot{s}_m^n \left[\dot{p}_m^n - \dot{P}_m^n \right] |\dot{p}_m^n| \zeta^2 dx \\
& \leq \frac{1}{\epsilon} h \sum_{n=1}^l \int_{\Omega} |\dot{p}_m^n|^2 |\nabla p_m^n + \hat{z}|^2 \zeta^2 dx + 3\bar{k}^2 \epsilon h \sum_{n=1}^l \|\nabla \dot{p}_m^n \zeta\|_{L^2(\Omega)}^2 \\
& \quad + \hat{c}_1(\varrho_0) \epsilon h \sum_{n=1}^l \|\dot{p}_m^n\|_{L^2(\Omega)}^2 + \hat{c}_1(\varrho_0) \frac{1 + \epsilon^2}{\epsilon}. \quad (6.1.9)
\end{aligned}$$

Finally, as by virtue of Assumption 3.2.5 the quantity $\|\dot{P}\|_{L^\infty(Q)}$ is bounded independently of m, n , and ϱ_0 , the claim follows inserting (6.1.9) into (6.1.3). \square

Let us prove another auxiliary result which reads as follows.

Lemma 6.1.2. *Suppose, that Assumptions 3.2.1- 3.2.5 hold. Moreover, let $m \in \mathbb{N}$, $h := \frac{T}{m}$, and let $\{p_m^n\}_{n \in \{1, \dots, m\}}$ be the sequence of solutions to Problem (4.1.1). Moreover, assume that with \bar{R} as in Assumption 3.2.3*

$$h \leq \frac{1}{4\bar{R}},$$

holds and let the constants μ_2 and α be as in Proposition 5.4.1.

Let $\varrho_0 > 0$, such that $2\varrho_0$ is as in Assumption 3.2.2 and suppose that in addition $0 < \varrho_0 \leq \frac{1}{2} \mu_2^{-\frac{1}{\alpha}}$ holds. For $x_0 \in \bar{\Omega}$, we define $B_{2\varrho_0}$ to be the ball centered at x_0 with radius $2\varrho_0$, and for $n \in \{0, \dots, m\}$ we set

$${}_n p_0 := \min_{B_{2\varrho_0} \cap \Omega} p_m^n.$$

Then with $\zeta \in C_0^1(\mathbb{R}^3)$ as in (6.1.1) the following inequality is satisfied for all $l \in \{1, \dots, m\}$

$$\begin{aligned}
& h \sum_{n=1}^l \int_{\Omega} k_m^{n-1} (\nabla p_m^n + \hat{z}) \cdot \nabla \left[(p_m^n - {}_n p_0) |\dot{p}_m^n|^2 \zeta^2 \right] dx \\
& \leq \mu_2 (2\varrho_0)^\alpha h \sum_{n=1}^l \int_{\Omega} |\dot{p}_m^n|^2 |\nabla p_m^n + \hat{z}|^2 \zeta^2 dx \\
& \quad + \mu_2 (2\varrho_0)^\alpha \left[3\bar{k} \left(\|\dot{P}\|_{L^\infty(\Sigma_1)}^2 + 1 \right)^{\frac{3}{2}} + 3\bar{k}^2 \right] h \sum_{n=1}^l \|\nabla \dot{p}_m^n \zeta\|_{L^2(\Omega)}^2 \\
& \quad + \hat{C}_2(\varrho_0) h \sum_{n=1}^l \|\dot{p}_m^n\|_{L^2(\Omega)}^2 + \hat{C}_2(\varrho_0),
\end{aligned}$$

where

$$\hat{C}_2(\varrho_0) := 2\hat{C}_1(\varrho_0) + 9\bar{k} \left(\|\dot{P}\|_{L^\infty(\Sigma_1)}^2 + 1 \right)^{\frac{3}{2}} \left[\mu_1 + |Q| + \frac{1}{\varrho_0^2} |Q| \right]$$

with \bar{k} as in Assumption 3.2.4, μ_1 as in Proposition 4.3.1, and $\hat{C}_1(\varrho_0)$ as in Lemma 6.1.1.

Proof: Let $\varrho_0 > 0$, $x_0 \in \bar{\Omega}$ and let $\zeta \in C_0^1(\mathbb{R}^3)$ be a cut-off function defined in (6.1.1). For all $n \in \{0, \dots, m\}$ we set

$$M := \|\dot{P}\|_{L^\infty(\Sigma_1)} \quad \text{and} \quad {}_n p_0 := \min_{B_{2\varrho_0} \cap \Omega} p_m^n, \quad (6.1.10)$$

and define the sequence $\{b_m^n\}_{n \in \{1, \dots, m\}} \subset H^1(\Omega)$ by

$$b_m^n := \begin{cases} 0 & \text{if } |\dot{p}_m^n|^2 \leq M^2 =: \hat{M} \\ |\dot{p}_m^n|^2 - \hat{M} & \text{if } \hat{M} \leq |\dot{p}_m^n|^2 \leq \hat{M} + 1 \\ 1 & \text{if } \hat{M} + 1 \leq |\dot{p}_m^n|^2, \end{cases} \quad \text{a.e. in } \Omega. \quad (6.1.11)$$

Due to Assumption 3.2.1 and to Proposition 5.4.1 the functions p_m^n are continuous on $\bar{\Omega}$ for all $n \in \{0, \dots, m\}$, therefore we can decompose the domain Ω in the following way

$$\Omega = \left\{x \in \Omega; |\dot{p}_m^n|^2 \leq \hat{M} + 1\right\} \cup \left\{x \in \Omega; |\dot{p}_m^n|^2 > \hat{M} + 1\right\}$$

for all $n \in \{0, \dots, m\}$. Thus, we obtain for all $l \in \{1, \dots, m\}$ the succeeding identity

$$\begin{aligned} & h \sum_{n=1}^l \int_{\Omega} k_m^{n-1} (\nabla p_m^n + \hat{z}) \cdot \nabla \left[(p_m^n - n p_0) |\dot{p}_m^n|^2 \zeta^2 \right] dx \\ &= h \sum_{n=1}^l \int_{\{x \in \Omega; |\dot{p}_m^n|^2 \leq \hat{M} + 1\}} k_m^{n-1} (\nabla p_m^n + \hat{z}) \cdot \nabla \left[(p_m^n - n p_0) |\dot{p}_m^n|^2 \zeta^2 \right] dx \\ &+ h \sum_{n=1}^l \int_{\{x \in \Omega; |\dot{p}_m^n|^2 > \hat{M} + 1\}} k_m^{n-1} (\nabla p_m^n + \hat{z}) \cdot \nabla \left[(p_m^n - n p_0) |\dot{p}_m^n|^2 \zeta^2 \right] dx. \end{aligned} \quad (6.1.12)$$

Bearing in mind, that

$$b_m^n \Big|_{\{x \in \Omega; |\dot{p}_m^n|^2 \geq \hat{M} + 1\}} = 1$$

for all $n \in \{1, \dots, m\}$ a.e. in Ω ,

$$\begin{aligned} & h \sum_{n=1}^l \int_{\{x \in \Omega; |\dot{p}_m^n|^2 > \hat{M} + 1\}} k_m^{n-1} (\nabla p_m^n + \hat{z}) \cdot \nabla \left[(p_m^n - n p_0) |\dot{p}_m^n|^2 \zeta^2 \right] dx \\ &= h \sum_{n=1}^l \int_{\{x \in \Omega; |\dot{p}_m^n|^2 > \hat{M} + 1\}} k_m^{n-1} (\nabla p_m^n + \hat{z}) \cdot \nabla \left[(p_m^n - n p_0) |\dot{p}_m^n|^2 b_m^n \zeta^2 \right] dx. \end{aligned}$$

follows. Furthermore, clearly

$$\left\{x \in \Omega; |\dot{p}_m^n|^2 > \hat{M} + 1\right\} = \left\{x \in \Omega; |\dot{p}_m^n|^2 > \hat{M}\right\} \setminus \left\{x \in \Omega; \hat{M} \leq |\dot{p}_m^n|^2 \leq \hat{M} + 1\right\}$$

holds, and consequently we obtain

$$\begin{aligned} & h \sum_{n=1}^l \int_{\{x \in \Omega; |\dot{p}_m^n|^2 > \hat{M} + 1\}} k_m^{n-1} (\nabla p_m^n + \hat{z}) \cdot \nabla \left[(p_m^n - n p_0) |\dot{p}_m^n|^2 b_m^n \zeta^2 \right] dx \\ &= h \sum_{n=1}^l \int_{\{x \in \Omega; |\dot{p}_m^n|^2 > \hat{M}\}} k_m^{n-1} (\nabla p_m^n + \hat{z}) \cdot \nabla \left[(p_m^n - n p_0) |\dot{p}_m^n|^2 b_m^n \zeta^2 \right] dx \\ &- h \sum_{n=1}^l \int_{\{x \in \Omega; \hat{M} \leq |\dot{p}_m^n|^2 \leq \hat{M} + 1\}} k_m^{n-1} (\nabla p_m^n + \hat{z}) \cdot \nabla \left[(p_m^n - n p_0) |\dot{p}_m^n|^2 b_m^n \zeta^2 \right] dx. \end{aligned} \quad (6.1.13)$$

Let us take a look at the first integral of the right-hand side of this expression. Observing that by definition (6.1.11) of the sequence $\{b_m^n\}_{n \in \{1, \dots, m\}}$

$$b_m^n \Big|_{\{x \in \Omega; |\dot{p}_m^n|^2 \leq \hat{M}\}} = 0$$

is satisfied for all $n \in \{1, \dots, m\}$ a.e. in Ω , the first term of the right-hand side of (6.1.13) transforms into

$$\begin{aligned} h \sum_{n=1}^l \int_{\{x \in \Omega; |\dot{p}_m^n|^2 > \hat{M}\}} k_m^{n-1} (\nabla p_m^n + \hat{z}) \cdot \nabla \left[(p_m^n - {}_n p_0) |\dot{p}_m^n|^2 b_m^n \zeta^2 \right] dx \\ = h \sum_{n=1}^l \int_{\Omega} k_m^{n-1} (\nabla p_m^n + \hat{z}) \cdot \nabla \left[(p_m^n - {}_n p_0) |\dot{p}_m^n|^2 b_m^n \zeta^2 \right] dx. \end{aligned} \quad (6.1.14)$$

Inserting (6.1.13) and (6.1.14) into (6.1.12), we thus obtain the following identity

$$\begin{aligned} h \sum_{n=1}^l \int_{\Omega} k_m^{n-1} (\nabla p_m^n + \hat{z}) \cdot \nabla \left[(p_m^n - {}_n p_0) |\dot{p}_m^n|^2 \zeta^2 \right] dx \\ = h \sum_{n=1}^l \int_{\{x \in \Omega; |\dot{p}_m^n|^2 \leq \hat{M}+1\}} k_m^{n-1} (\nabla p_m^n + \hat{z}) \cdot \nabla \left[(p_m^n - {}_n p_0) |\dot{p}_m^n|^2 \zeta^2 \right] dx \\ - h \sum_{n=1}^l \int_{\{x \in \Omega; \hat{M} \leq |\dot{p}_m^n|^2 \leq \hat{M}+1\}} k_m^{n-1} (\nabla p_m^n + \hat{z}) \cdot \nabla \left[(p_m^n - {}_n p_0) |\dot{p}_m^n|^2 b_m^n \zeta^2 \right] dx \\ + h \sum_{n=1}^l \int_{\Omega} k_m^{n-1} (\nabla p_m^n + \hat{z}) \cdot \nabla \left[(p_m^n - {}_n p_0) |\dot{p}_m^n|^2 b_m^n \zeta^2 \right] dx. \end{aligned} \quad (6.1.15)$$

We estimate the terms of the right-hand side of (6.1.15) separately.

- ① By virtue of Assumption 3.2.4, and Proposition 4.2.1 $0 < \underline{k} \leq k_m^n \leq \bar{k}$ holds for all $n \in \{0, \dots, m\}$, so consequently

$$\begin{aligned} \left| \int_{\{x \in \Omega; |\dot{p}_m^n|^2 \leq \hat{M}+1\}} k_m^{n-1} (\nabla p_m^n + \hat{z}) \cdot \nabla \left[(p_m^n - {}_n p_0) |\dot{p}_m^n|^2 \zeta^2 \right] dx \right| \\ \leq \bar{k} \int_{\{x \in \Omega; |\dot{p}_m^n|^2 \leq \hat{M}+1\}} |\nabla p_m^n + \hat{z}| \left| \nabla \left[(p_m^n - {}_n p_0) |\dot{p}_m^n|^2 \zeta^2 \right] \right| dx \end{aligned} \quad (6.1.16)$$

follows. Moreover, the Hölder continuity of p_m^n obtained in Proposition 5.4.1 yields, that there exist constants μ_2 , and α independent of m, n , and ϱ_0 , such that for all $n \in \{1, \dots, m\}$

$$|p_m^n - {}_n p_0| \leq \text{osc} \{p_m^n; B_{2\varrho_0} \cap \Omega\} \leq \mu_2 (2\varrho_0)^\alpha$$

holds a.e. in Ω . Taking this pointwise estimate into account, we find for all $n \in \{1, \dots, m\}$ a.e. in Ω the following inequality

$$\left| \nabla \left[(p_m^n - p_0) |\dot{p}_m^n|^2 \zeta^2 \right] \right|$$

$$\begin{aligned}
&\leq |\nabla p_m^n| |\dot{p}_m^n|^2 \zeta^2 + 2 |p_m^n - n p_0| |\dot{p}_m^n| |\nabla \dot{p}_m^n| \zeta^2 + 2 |p_m^n - n p_0| |\dot{p}_m^n|^2 \zeta |\nabla \zeta| \\
&\leq |\nabla p_m^n| |\dot{p}_m^n|^2 \zeta^2 + 2\mu_2(2\varrho_0)^\alpha |\dot{p}_m^n| |\nabla \dot{p}_m^n| \zeta^2 + 2\mu_2(2\varrho_0)^\alpha |\dot{p}_m^n|^2 \zeta |\nabla \zeta|. \quad (6.1.17)
\end{aligned}$$

As for $n \in \{1, \dots, m\}$

$$|\dot{p}_m^n|^2 \Big|_{\{x \in \Omega; |\dot{p}_m^n|^2 \leq \hat{M}+1\}} \leq \hat{M} + 1, \quad (6.1.18)$$

we obtain as a consequence of Cauchy's and Young's inequalities and the estimates (6.1.17) and (6.1.18) for all $n \in \{1, \dots, m\}$

$$\begin{aligned}
&\int_{\{x \in \Omega; |\dot{p}_m^n|^2 \leq \hat{M}+1\}} |\nabla p_m^n + \hat{z}| \left| \nabla \left[(p_m^n - n p_0) |\dot{p}_m^n|^2 \zeta^2 \right] \right| dx \\
&\leq (\hat{M} + 1) \int_{\{x \in \Omega; |\dot{p}_m^n|^2 \leq \hat{M}+1\}} |\nabla p_m^n + \hat{z}|^2 \zeta^2 + |\nabla p_m^n + \hat{z}| |\hat{z}| \zeta^2 dx \\
&\quad + 2(\hat{M} + 1)^{\frac{1}{2}} \mu_2(2\varrho_0)^\alpha \int_{\{x \in \Omega; |\dot{p}_m^n|^2 \leq \hat{M}+1\}} |\nabla p_m^n + \hat{z}| |\nabla \dot{p}_m^n| \zeta^2 dx \\
&\quad + 2(\hat{M} + 1) \mu_2(2\varrho_0)^\alpha \int_{\{x \in \Omega; |\dot{p}_m^n|^2 \leq \hat{M}+1\}} |\nabla p_m^n + \hat{z}| \zeta |\nabla \zeta| dx.
\end{aligned}$$

Applying Young's inequality to the right-hand side of this estimate, and keeping in mind that $|\hat{z}| = 1$, we follow

$$\begin{aligned}
&\int_{\{x \in \Omega; |\dot{p}_m^n|^2 \leq \hat{M}+1\}} |\nabla p_m^n + \hat{z}| \left| \nabla \left[(p_m^n - n p_0) |\dot{p}_m^n|^2 \zeta^2 \right] \right| dx \\
&\leq (\hat{M} + 1) \mu_2(2\varrho_0)^\alpha \|\nabla \dot{p}_m^n \zeta\|_{L^2(\Omega)}^2 \\
&\quad + (\hat{M} + 1) \left[2 \|\nabla p_m^n + \hat{z}\|_{L^2(\Omega)}^2 + \frac{1}{4} \|\zeta\|_{L^2(\Omega)}^2 \right] \\
&\quad + (\hat{M} + 1) \mu_2(2\varrho_0)^\alpha \left[2 \|\nabla p_m^n + \hat{z}\|_{L^2(\Omega)}^2 + \|\nabla \zeta\|_{L^2(\Omega)}^2 \right].
\end{aligned}$$

Recalling that by construction $|\zeta| \leq 1, |\nabla \zeta| \leq \frac{2}{\varrho_0}$ as well as $\varrho_0 \leq \frac{1}{2} \mu_2^{-\frac{1}{\alpha}}$ hold, we deduce from the preceding inequality

$$\begin{aligned}
&h \sum_{n=1}^l \int_{\{x \in \Omega; |\dot{p}_m^n|^2 \leq \hat{M}+1\}} |\nabla p_m^n + \hat{z}| \left| \nabla \left[(p_m^n - n p_0) |\dot{p}_m^n|^2 \zeta^2 \right] \right| dx \\
&\leq (\hat{M} + 1) \mu_2(2\varrho_0)^\alpha h \sum_{n=1}^l \|\nabla \dot{p}_m^n \zeta\|_{L^2(\Omega)}^2 \\
&\quad + (\hat{M} + 1) \left[4h \sum_{n=1}^l \|\nabla p_m^n + \hat{z}\|_{L^2(\Omega)}^2 + |Q| + \frac{4}{\varrho_0^2} |Q| \right]. \quad (6.1.19)
\end{aligned}$$

Due to Propositions 4.3.1

$$h \sum_{n=1}^l \|\nabla p_m^n + \hat{z}\|_{L^2(\Omega)}^2 \leq \mu_1$$

holds, and therefore (6.1.19) implies the following estimate

$$\begin{aligned}
& h \sum_{n=1}^l \int_{\{x \in \Omega; |\dot{p}_m^n|^2 \leq \hat{M}+1\}} |\nabla p_m^n + \hat{z}| \left| \nabla \left[(p_m^n - n p_0) |\dot{p}_m^n|^2 \zeta^2 \right] \right| dx \\
& \leq (\hat{M} + 1) \mu_2 (2\varrho_0)^\alpha h \sum_{n=1}^l \|\nabla \dot{p}_m^n \zeta\|_{L^2(\Omega)}^2 + \hat{c}_2(\varrho_0), \quad (6.1.20)
\end{aligned}$$

with the constant \hat{c}_2 defined by

$$\hat{c}_2(\varrho_0) := (\hat{M} + 1) \left[4\mu_1 + |Q| + \frac{4}{\varrho_0^2} |Q| \right]. \quad (6.1.21)$$

Assembling (6.1.20) and (6.1.16) then implies

$$\begin{aligned}
& \left| h \sum_{n=1}^l \int_{\{x \in \Omega; |\dot{p}_m^n|^2 \leq \hat{M}+1\}} k_m^{n-1} (\nabla p_m^n + \hat{z}) \cdot \nabla \left[(p_m^n - n p_0) |\dot{p}_m^n|^2 \zeta^2 \right] dx \right| \\
& \leq (\hat{M} + 1) \mu_2 (2\varrho_0)^\alpha \bar{k} h \sum_{n=1}^l \|\nabla \dot{p}_m^n \zeta\|_{L^2(\Omega)}^2 + \hat{c}_2(\varrho_0) \bar{k}. \quad (6.1.22)
\end{aligned}$$

② Let us proceed with the second term of the right-hand side of (6.1.15).

By virtue of the definition (6.1.11) of b_m^n the estimate $|\nabla b_m^n| \leq 2 |\dot{p}_m^n| |\nabla \dot{p}_m^n|$ clearly holds for all $n \in \{1, \dots, m\}$ a.e. in $\{x \in \Omega : \hat{M} \leq |\dot{p}_m^n|^2 \leq \hat{M} + 1\}$. Moreover, again by virtue of Proposition 5.4.1, there exist constants μ_2, α , independent of m, n, ϱ_0 , such that for all $n \in \{1, \dots, m\}$ the pointwise estimate

$$|p_m^n - n p_0| \leq \text{osc} \{p_m^n; B_{2\varrho_0 \cap \Omega}\} \leq \mu_2 (2\varrho_0)^\alpha$$

is satisfied a.e. in Ω . Keeping in mind that $|b_m^n| \leq 1$ for all $n \in \{1, \dots, m\}$ a.e. in Ω , we find the following estimate for all $n \in \{1, \dots, m\}$ a.e. in $\{x \in \Omega : \hat{M} \leq |\dot{p}_m^n|^2 \leq \hat{M} + 1\}$

$$\begin{aligned}
\left| \nabla \left[(p_m^n - n p_0) |\dot{p}_m^n|^2 b_m^n \zeta^2 \right] \right| & \leq \left| \nabla \left[(p_m^n - n p_0) |\dot{p}_m^n|^2 \zeta^2 \right] \right| |b_m^n| + \left| \left[(p_m^n - n p_0) |\dot{p}_m^n|^2 \zeta^2 \right] \right| |\nabla b_m^n| \\
& \leq \left| \nabla \left[(p_m^n - n p_0) |\dot{p}_m^n|^2 \zeta^2 \right] \right| + 2 \text{osc} \{p_m^n; B_{2\varrho_0 \cap \Omega}\} |\dot{p}_m^n|^3 |\nabla \dot{p}_m^n| \zeta^2 \\
& \leq \left| \nabla \left[(p_m^n - n p_0) |\dot{p}_m^n|^2 \zeta^2 \right] \right| + 2\mu_2 (2\varrho_0)^\alpha |\dot{p}_m^n|^3 |\nabla \dot{p}_m^n| \zeta^2.
\end{aligned}$$

So consequently, exploiting the uniform boundedness of k_m^n obtained in Proposition 4.2.1, we have

$$\begin{aligned}
& h \sum_{n=1}^l \left| \int_{\{x \in \Omega; \hat{M}+1 \geq |\dot{p}_m^n|^2 > \hat{M}\}} k_m^{n-1} (\nabla p_m^n + \hat{z}) \cdot \nabla \left[(p_m^n - n p_0) |\dot{p}_m^n|^2 b_m^n \zeta^2 \right] dx \right| \\
& \leq \bar{k} h \sum_{n=1}^l \int_{\{x \in \Omega; \hat{M}+1 \geq |\dot{p}_m^n|^2 > \hat{M}\}} |\nabla p_m^n + \hat{z}| \left| \nabla \left[(p_m^n - n p_0) |\dot{p}_m^n|^2 \zeta^2 \right] \right| dx \\
& \quad + 2\mu_2 (2\varrho_0)^\alpha \bar{k} h \sum_{n=1}^l \int_{\{x \in \Omega; \hat{M}+1 \geq |\dot{p}_m^n|^2 > \hat{M}\}} |\nabla p_m^n + \hat{z}| |\dot{p}_m^n|^3 |\nabla \dot{p}_m^n| \zeta^2 dx. \quad (6.1.23)
\end{aligned}$$

By virtue of the estimate (6.1.20), we immediately follow that

$$\begin{aligned} & \bar{k}h \sum_{n=1}^l \int_{\{x \in \Omega; \hat{M}+1 \geq |\dot{p}_m^n|^2 > \hat{M}\}} |\nabla p_m^n + \hat{z}| \left| \nabla \left[(p_m^n - n p_0) |\dot{p}_m^n|^2 \zeta^2 \right] \right| dx \\ & \leq \bar{k}h \sum_{n=1}^l \int_{\{x \in \Omega; |\dot{p}_m^n|^2 \leq \hat{M}+1\}} |\nabla p_m^n + \hat{z}| \left| \nabla \left[(p_m^n - n p_0) |\dot{p}_m^n|^2 \zeta^2 \right] \right| dx \\ & \leq (\hat{M} + 1) \bar{k} \mu_2 (2\varrho_0)^\alpha h \sum_{n=1}^l \left\| \nabla \dot{p}_m^n \zeta \right\|_{L^2(\Omega)}^2 + \hat{c}_2(\varrho_0) \bar{k}, \end{aligned} \quad (6.1.24)$$

is satisfied with $\hat{c}_2(\varrho_0)$ as in (6.1.21).

As on the other hand

$$|\dot{p}_m^n| \Big|_{\{x \in \Omega; \hat{M}+1 \geq |\dot{p}_m^n|^2 > \hat{M}\}} \leq (\hat{M} + 1)^{\frac{1}{2}}$$

clearly holds, Young's inequality implies

$$\begin{aligned} & 2\mu_2(2\varrho_0)^\alpha \bar{k}h \sum_{n=1}^l \int_{\{x \in \Omega; \hat{M}+1 \geq |\dot{p}_m^n|^2 > \hat{M}\}} |\nabla p_m^n + \hat{z}| |\dot{p}_m^n|^3 |\nabla \dot{p}_m^n| \zeta^2 dx \\ & \leq 2\mu_2(2\varrho_0)^\alpha \bar{k} (\hat{M} + 1)^{\frac{3}{2}} h \sum_{n=1}^l \int_{\{x \in \Omega; \hat{M}+1 \geq |\dot{p}_m^n|^2 > \hat{M}\}} |\nabla(p_m^n + z)| |\nabla \dot{p}_m^n| \zeta^2 dx \\ & \leq \mu_2(2\varrho_0)^\alpha \bar{k} (\hat{M} + 1)^{\frac{3}{2}} \left[h \sum_{n=1}^l \left\| \nabla p_m^n + \hat{z} \right\|_{L^2(\Omega)}^2 + h \sum_{n=1}^l \left\| \nabla \dot{p}_m^n \zeta \right\|_{L^2(\Omega)}^2 \right]. \end{aligned} \quad (6.1.25)$$

Again, Proposition 4.3.1 yields

$$h \sum_{n=1}^l \left\| \nabla p_m^n + \hat{z} \right\|_{L^2(\Omega)}^2 \leq \mu_1,$$

and therefore we deduce, keeping in mind that $|\zeta| \leq 1$, $\varrho_0 \leq \frac{1}{2} \mu_2^{-\frac{1}{\alpha}}$, and inserting (6.1.24) and (6.1.25) into (6.1.23) the following inequality

$$\begin{aligned} & h \sum_{n=1}^l \left| \int_{\{x \in \Omega; \hat{M}+1 \geq |\dot{p}_m^n|^2 > \hat{M}\}} k_m^{n-1} (\nabla p_m^n + \hat{z}) \cdot \nabla \left[(p_m^n - n p_0) |\dot{p}_m^n|^2 b_m^n \zeta^2 \right] dx \right| \\ & \leq 2\mu_2(2\varrho_0)^\alpha \bar{k} (\hat{M} + 1)^{\frac{3}{2}} h \sum_{n=1}^l \left\| \nabla \dot{p}_m^n \zeta \right\|_{L^2(\Omega)}^2 + \hat{c}_2(\varrho_0) \bar{k} + \bar{k} (\hat{M} + 1)^{\frac{3}{2}} \mu_1. \end{aligned} \quad (6.1.26)$$

③ Finally, we estimate the last term of the right-hand side of (6.1.15), i.e. we estimate

$$h \sum_{n=1}^l \int_{\Omega} k_m^{n-1} (\nabla p_m^n + \hat{z}) \cdot \nabla \left[(p_m^n - n p_0) |\dot{p}_m^n|^2 b_m^n \zeta^2 \right] dx.$$

First, we claim that the functions $\phi_m^n := p_m^n - \left(|\dot{p}_m^n|^2 [p_m^n - n p_0] \right) b_m^n \zeta^2$ are admissible test-functions for (4.1.2a) for any time step $n \in \{1, \dots, m\}$. Indeed:

- (i) Let $x \in \Gamma_1$, with $\gamma_0 p_m^n(x) > 0$. Then, by virtue of Assumption 3.2.4 $\gamma_0 p_m^{n-1}(x) > 0$, and consequently $\gamma_0 \dot{p}_m^n(x) = \dot{P}_m^n(x)$ follows. Thus, by construction (c.f. (6.1.11)) $b_m^n(x) = 0$ holds, and therefore $\gamma_0 \phi_m^n(x) = \gamma_0 p_m^n(x)$ is satisfied.
- (ii) Let now $x \in \Gamma_1$, with $\gamma_0 p_m^n(x) \leq 0$. Then, from the definition of ${}_n p_0$ we have $(\gamma_0 p_m^n(x) - {}_n p_0) \zeta^2 \geq 0$, and since $0 \leq b_m^n$, it follows that $\gamma_0 \phi_m^n(x) \leq \gamma_0 p_m^n(x) \leq 0$ holds.

Hence, altogether we find $(\gamma_0 \phi_m^n)^+ = (\gamma_0 p_m^n)^+$ a.e. on Γ_1 . Applying of ϕ_m^n as a test-function in (4.1.2a) at the time step $n \in \{1, \dots, m\}$ and summing the resulting inequalities over $n \in \{1, \dots, l\}$, with $l \in \{1, \dots, m\}$, we infer

$$\begin{aligned} h \sum_{n=1}^l \int_{\Omega} \dot{s}_m^n \left(|\dot{p}_m^n|^2 [p_m^n - {}_n p_0] b_m^n \zeta^2 \right) dx \\ + h \sum_{n=1}^l \int_{\Omega} k_m^{n-1} (\nabla p_m^n + \hat{z}) \cdot \nabla \left(|\dot{p}_m^n|^2 [p_m^n - {}_n p_0] b_m^n \zeta^2 \right) dx \leq 0. \end{aligned} \quad (6.1.27)$$

Now, due to Proposition 5.4.1, there exist μ_2 , α , independent of m, n , and ϱ_0 , such that for any $n \in \{1, \dots, m\}$ the following estimate holds

$$\begin{aligned} - \int_{\Omega} \dot{s}_m^n \left(|\dot{p}_m^n|^2 [p_m^n - {}_n p_0] b_m^n \zeta^2 \right) dx \\ \leq \int_{\Omega} |\dot{s}_m^n| |\dot{p}_m^n|^2 |p_m^n - {}_n p_0| b_m^n \zeta^2 dx \\ \leq \text{osc} \{p_m^n; B_{2\varrho_0} \cap \Omega\} \int_{\Omega} |\dot{s}_m^n| |\dot{p}_m^n|^2 b_m^n \zeta^2 dx \\ \leq \mu_2 (2\varrho_0)^\alpha \int_{\Omega} |\dot{s}_m^n| |\dot{p}_m^n|^2 b_m^n \zeta^2 dx. \end{aligned}$$

And since $0 \leq b_m^n \leq 1$ by construction, and $\varrho_0 \leq \frac{1}{2} \mu_2^{-\frac{1}{\alpha}}$ by assumption, we calculate with the help of Lemma 6.1.1 (choosing $\epsilon = 1$)

$$\begin{aligned} - h \sum_{n=1}^l \int_{\Omega} \dot{s}_m^n \left(|\dot{p}_m^n|^2 [p_m^n - {}_n p_0] b_m^n \zeta^2 \right) dx \\ \leq \mu_2 (2\varrho_0)^\alpha h \sum_{n=1}^l \int_{\Omega} |\dot{p}_m^n|^2 |\nabla p_m^n + \hat{z}|^2 \zeta^2 dx + 3\bar{k}^2 \mu_2 (2\varrho_0)^\alpha h \sum_{n=1}^l \|\nabla \dot{p}_m^n \zeta\|_{L^2(\Omega)}^2 \\ + 2\hat{C}_1(\varrho_0) h \sum_{n=1}^l \|\dot{p}_m^n\|_{L^2(\Omega)}^2 + 2\hat{C}_1(\varrho_0), \end{aligned}$$

where $\hat{C}_1(\varrho_0)$ is as in Lemma 6.1.1. Inserting this estimate into (6.1.27) implies

$$\begin{aligned} h \sum_{n=1}^l \int_{\Omega} k_m^{n-1} (\nabla p_m^n + \hat{z}) \cdot \nabla \left(|\dot{p}_m^n|^2 [p_m^n - {}_n p_0] b_m^n \zeta^2 \right) dx \\ \leq \mu_2 (2\varrho_0)^\alpha h \sum_{n=1}^l \int_{\Omega} |\dot{p}_m^n|^2 |\nabla p_m^n + \hat{z}|^2 \zeta^2 dx + 3\bar{k}^2 \mu_2 (2\varrho_0)^\alpha h \sum_{n=1}^l \|\nabla \dot{p}_m^n \zeta\|_{L^2(\Omega)}^2 \end{aligned}$$

$$+ 2\hat{C}_1(\varrho_0)h \sum_{n=1}^l \|\dot{p}_m^n\|_{L^2(\Omega)}^2 + 2\hat{C}_1(\varrho_0). \quad (6.1.28)$$

Finally, inserting (6.1.22), (6.1.26), and (6.1.28) into (6.1.15), we find

$$\begin{aligned} & h \sum_{n=1}^l \int_{\Omega} k_m^{n-1} (\nabla p_m^n + \hat{z}) \cdot \nabla \left[(p_m^n - n p_0) |\dot{p}_m^n|^2 \zeta^2 \right] dx \\ & \leq \mu_2 (2\varrho_0)^\alpha h \sum_{n=1}^l \int_{\Omega} |\dot{p}_m^n|^2 |\nabla p_m^n + \hat{z}|^2 \zeta^2 dx \\ & \quad + \mu_2 (2\varrho_0)^\alpha \left[3\bar{k}(\hat{M} + 1)^{\frac{3}{2}} + 3\bar{k}^2 \right] h \sum_{n=1}^l \|\nabla \dot{p}_m^n \zeta\|_{L^2(\Omega)}^2 \\ & \quad + 2\hat{C}_1(\varrho_0)h \sum_{n=1}^l \|\dot{p}_m^n\|_{L^2(\Omega)}^2 \\ & \quad + 2\bar{k}\hat{c}_2(\varrho_0) + \bar{k}(\hat{M} + 1)^{\frac{3}{2}}\mu_1 + 2\hat{C}_1(\varrho_0), \end{aligned}$$

and the claim follows. \square

Let us finally show, how the results of Lemmata 6.1.1 and 6.1.2 can be used to estimate the expression

$$\int_{\Omega} |\dot{p}_m^n|^2 |\nabla p_m^n + \hat{z}|^2 \zeta^2 dx.$$

We prove the following statement.

Lemma 6.1.3. *Suppose, that Assumptions 3.2.2- 3.2.5 are satisfied. Let $m \in \mathbb{N}$, $h := \frac{T}{m}$, and let $\{p_m^n\}_{n \in \{1, \dots, m\}}$ be the sequence of solutions to Problem (4.1.2a). Moreover, assume that with \bar{R} as in Assumption 3.2.3*

$$h \leq \frac{1}{4\bar{R}}.$$

Let the constants μ_2 and α be as in Proposition 5.4.1, and $\varrho_0 > 0$, be such that $2\varrho_0$ is as in Assumption 3.2.2 with the additional restriction

$$\varrho_0 \leq \frac{1}{2} \min \left\{ \frac{1}{\mu_2}; \frac{\bar{k}}{12\mu_2} \right\}^{\frac{1}{\alpha}}.$$

Then, for a cut-off function $\zeta \in C_0^1(\mathbb{R}^3)$ as in (6.1.1) the following inequality is satisfied for all $l \in \{1, \dots, m\}$

$$\begin{aligned} & h \sum_{n=1}^l \int_{\Omega} |\dot{p}_m^n|^2 |\nabla p_m^n + \hat{z}|^2 \zeta^2 dx \\ & \leq \frac{2}{\bar{k}} \left[3 \left(\|\gamma_0 \dot{P}\|_{L^\infty(\Sigma_1)}^2 + 1 \right)^{\frac{3}{2}} \bar{k} + 4\bar{k}^2 \right] \mu_2 (2\varrho_0)^\alpha h \sum_{n=1}^l \|\nabla \dot{p}_m^n \zeta\|_{L^2(\Omega)}^2 \\ & \quad + \hat{C}_3(\varrho_0)h \sum_{n=1}^l \|\dot{p}_m^n\|_{L^2(\Omega)}^2 + \hat{C}_3(\varrho_0), \quad (6.1.29) \end{aligned}$$

where

$$\hat{C}_3(\varrho_0) := \frac{2}{\underline{k}} \left[\hat{C}_2(\varrho_0) + \frac{4\bar{k}^2}{\varrho_0^2} + \frac{\bar{k}^2}{\underline{k}^2} \right]$$

with \underline{k}, \bar{k} as in Assumption 3.2.4, and $\hat{C}_2(\varrho_0)$ as in Lemma 6.1.2.

Proof: Let $\varrho_0 > 0$, $x_0 \in \bar{\Omega}$ and let $\zeta \in C_0^1(\mathbb{R}^3)$ be a cut-off function as in (6.1.1). For $n \in \{0, \dots, m\}$, let ${}_n p_0$, and M be as in (6.1.10), and set $\hat{M} = M^2$. Due to Proposition 4.2.1 we have $0 < \underline{k} \leq k_m^n$ for all $n \in \{0, \dots, m\}$, and with the help of Cauchy's inequality we calculate for any $l \in \{1, \dots, m\}$

$$\begin{aligned} & h \sum_{n=1}^l \int_{\Omega} |\dot{p}_m^n|^2 |\nabla p_m^n + \hat{z}|^2 \zeta^2 dx \\ & \leq \frac{1}{\underline{k}} h \sum_{n=1}^l \int_{\Omega} k_m^{n-1} |\dot{p}_m^n|^2 (\nabla p_m^n + \hat{z}) \cdot (\nabla p_m^n + \hat{z}) \zeta^2 dx \\ & = \frac{1}{\underline{k}} h \sum_{n=1}^l \int_{\Omega} k_m^{n-1} (\nabla p_m^n + \hat{z}) \cdot \left[\nabla (p_m^n - {}_n p_0) |\dot{p}_m^n|^2 \zeta^2 \right] dx \\ & \quad + \frac{1}{\underline{k}} h \sum_{n=1}^l \int_{\Omega} k_m^{n-1} (\nabla p_m^n + \hat{z}) \cdot \left[\hat{z} |\dot{p}_m^n|^2 \zeta^2 \right] dx. \quad (6.1.30) \end{aligned}$$

We estimate the terms of the right-hand side of this inequality separately.

- ① Bearing in mind that $|\hat{z}| = 1$, and that by virtue of Proposition 4.2.1 $0 < \underline{k} \leq k_m^n \leq \bar{k}$ holds for all $n \in \{0, \dots, m\}$, we find with the help of Young's inequality

$$\begin{aligned} & \left| \frac{1}{\underline{k}} h \sum_{n=1}^l \int_{\Omega} k_m^{n-1} (\nabla p_m^n + \hat{z}) \cdot \left[\hat{z} |\dot{p}_m^n|^2 \zeta^2 \right] dx \right| \\ & \leq \frac{\bar{k}}{\underline{k}} h \sum_{n=1}^l \int_{\Omega} |\nabla p_m^n + \hat{z}| |\dot{p}_m^n|^2 \zeta^2 dx \\ & \leq \frac{1}{4} h \sum_{n=1}^l \int_{\Omega} |\nabla p_m^n + \hat{z}|^2 |\dot{p}_m^n|^2 \zeta^2 dx + \frac{\bar{k}^2}{\underline{k}^2} h \sum_{n=1}^l \int_{\Omega} |\dot{p}_m^n|^2 \zeta^2 dx. \quad (6.1.31) \end{aligned}$$

- ② Furthermore, a straightforward computation yields for all $n \in \{1, \dots, m\}$ a.e. in Ω

$$\begin{aligned} & \nabla (p_m^n - {}_n p_0) |\dot{p}_m^n|^2 \zeta^2 \\ & = \nabla \left[(p_m^n - {}_n p_0) |\dot{p}_m^n|^2 \zeta^2 \right] - 2 (p_m^n - {}_n p_0) \dot{p}_m^n \nabla \dot{p}_m^n \zeta^2 - 2 (p_m^n - {}_n p_0) |\dot{p}_m^n| \zeta \nabla \zeta \end{aligned}$$

and therefore we clearly have

$$\begin{aligned} & \left| \frac{1}{\underline{k}} h \sum_{n=1}^l \int_{\Omega} k_m^{n-1} (\nabla p_m^n + \hat{z}) \cdot \left[\nabla (p_m^n - {}_n p_0) |\dot{p}_m^n|^2 \zeta^2 \right] dx \right| \\ & \leq \frac{1}{\underline{k}} \left| h \sum_{n=1}^l \int_{\Omega} k_m^{n-1} (\nabla p_m^n + \hat{z}) \cdot \nabla \left[(p_m^n - {}_n p_0) |\dot{p}_m^n|^2 \zeta^2 \right] dx \right| \end{aligned}$$

$$\begin{aligned}
& + \frac{1}{\underline{k}} \left| h \sum_{n=1}^l \int_{\Omega} k_m^{n-1} (\nabla p_m^n + \hat{z}) \cdot [2(p_m^n - n p_0) \dot{p}_m^n \nabla \dot{p}_m^n \zeta^2] dx \right| \\
& \quad \frac{1}{\underline{k}} \left| h \sum_{n=1}^l \int_{\Omega} k_m^{n-1} (\nabla p_m^n + \hat{z}) \cdot [2(p_m^n - n p_0) |\dot{p}_m^n|^2 \zeta \nabla \zeta] dx \right|. \quad (6.1.32)
\end{aligned}$$

The first integral of the right-hand side of (6.1.32) can be estimated by means of Lemma 6.1.2. Let us estimate the other two terms.

Once again, by virtue of Proposition 5.4.1, there exist positive numbers μ_2 and α independent of m, n, ϱ_0 , such that for all $n \in \{1, \dots, m\}$

$$\text{osc} \{p_m^n; B_{2\varrho_0} \cap \Omega\} \leq \mu_2 (2\varrho_0)^\alpha$$

holds.

Therefore, with the help of Young's inequality, we find for the second integral of the right-hand side of (6.1.32)

$$\begin{aligned}
& h \sum_{n=1}^l \left| \int_{\Omega} k_m^{n-1} (\nabla p_m^n + \hat{z}) \cdot [2(p_m^n - n p_0) \dot{p}_m^n \nabla \dot{p}_m^n \zeta^2] dx \right| \\
& \leq h \sum_{n=1}^l \text{osc} \{p_m^n; B_{2\varrho_0} \cap \Omega\} \bar{k} \int_{\Omega} 2 |\dot{p}_m^n| |\nabla p_m^n + \hat{z}| |\nabla \dot{p}_m^n| \zeta^2 dx \\
& \leq \mu_2 (2\varrho_0)^\alpha h \sum_{n=1}^l \left[\int_{\Omega} |\dot{p}_m^n|^2 |\nabla p_m^n + \hat{z}|^2 \zeta^2 dx + \bar{k}^2 \|\nabla \dot{p}_m^n \zeta\|_{L^2(\Omega)}^2 \right]. \quad (6.1.33)
\end{aligned}$$

And for the last term of the right-hand side of (6.1.32) Young's inequality implies

$$\begin{aligned}
& h \sum_{n=1}^l \left| \int_{\Omega} k_m^{n-1} (\nabla p_m^n + \hat{z}) \cdot [2(p_m^n - p_0) |\dot{p}_m^n|^2 \zeta \nabla \zeta] dx \right| \\
& \leq h \sum_{n=1}^l \text{osc} \{p_m^n; B_{2\varrho_0} \cap \Omega\} \bar{k} \int_{\Omega} 2 |\dot{p}_m^n|^2 |\nabla p_m^n + \hat{z}| \zeta |\nabla \zeta| dx \\
& \leq \mu_2 (2\varrho_0)^\alpha h \sum_{n=1}^l \left[\int_{\Omega} |\dot{p}_m^n|^2 |\nabla p_m^n + \hat{z}|^2 \zeta^2 dx + \bar{k}^2 \|\dot{p}_m^n |\nabla \zeta|\|_{L^2(\Omega)}^2 \right]. \quad (6.1.34)
\end{aligned}$$

Bearing in mind that $|\nabla \zeta| \leq \frac{2}{\varrho_0}$ and $\varrho_0 \leq \frac{1}{2} \mu_2^{-\frac{1}{\alpha}}$ hold, application of Lemma 6.1.2 together with the estimates (6.1.30), (6.1.31), (6.1.32), (6.1.33), and (6.1.34) provides

$$\begin{aligned}
& h \sum_{n=1}^l \int_{\Omega} |\dot{p}_m^n|^2 |\nabla p_m^n + \hat{z}|^2 \zeta^2 dx \leq \left(\frac{3\mu_2 (2\varrho_0)^\alpha}{\underline{k}} + \frac{1}{4} \right) h \sum_{n=1}^l \int_{\Omega} |\dot{p}_m^n|^2 |\nabla p_m^n + \hat{z}|^2 \zeta^2 dx \\
& \quad + \frac{1}{\underline{k}} \left[3(\hat{M} + 1)^{\frac{3}{2}} \bar{k} + 4\bar{k}^2 \right] \mu_2 (2\varrho_0)^\alpha h \sum_{n=1}^l \|\nabla \dot{p}_m^n \zeta\|_{L^2(\Omega)}^2 \\
& \quad + \frac{1}{\underline{k}} \left[\hat{C}_2(\varrho_0) + \frac{4\bar{k}^2}{\varrho_0^2} + \frac{\bar{k}^2}{\underline{k}^2} \right] h \sum_{n=1}^l \|\dot{p}_m^n\|_{L^2(\Omega)}^2 + \frac{1}{\underline{k}} \hat{C}_2(\varrho_0),
\end{aligned}$$

where $\hat{C}_2(\varrho_0)$ is as in Lemma 6.1.2. Making use of our assumption that ϱ_0 satisfies

$$\varrho_0 \leq \frac{1}{2} \left(\frac{k}{12\mu_2} \right)^{\frac{1}{\alpha}},$$

the claim follows. \square

6.2 Estimate of Initial Values

In view of the proof of Proposition 6.3.1 (bound of the incremental time ratio \dot{p}_m^n) we need to establish an estimate of \dot{p}_m^1 . We do this in the sequel.

Proposition 6.2.1. *Let $m \in \mathbb{N}$, $h := \frac{T}{m}$ and p_m^1 be the solution to (4.1.2a) at the time step $n = 1$. Suppose that Assumptions 3.2.1 -3.2.5 are satisfied and that $h < 1$ holds. Then there exist a constant $\mu_3 > 0$, independent of m, n such that*

$$\|\dot{p}_m^1\|_{L^2(\Omega)}^2 + h \|\nabla \dot{p}_m^1\|_{L^2(\Omega)}^2 \leq \mu_3.$$

Proof: Let p_m^1 be the solution to (4.1.2a) at the time step $n = 1$. We claim that the function

$$\phi_m^1 = p_m^1 - h^2 \left[\dot{p}_m^1 - \dot{P}_m^1 \right]$$

belongs to K_m^1 . Indeed

- ① Let $x \in \Gamma_1$ with $\gamma_0 p_m^1(x) > 0$. Then Assumption 3.2.1 yields that also $\gamma_0 p_m^0(x) > 0$ and therefore $\gamma_0 \dot{p}_m^1(x) = \dot{P}_m^1$ as well as $\gamma_0 \phi_m^1(x) = \gamma_0 p_m^1(x)$ hold.
- ② Now let $x \in \Gamma_1$ with $\gamma_0 p_m^1(x) \leq 0$. Then again by virtue of Assumption 3.2.1 we have $\gamma_0 p_m^0 \leq 0$ and consequently $\dot{P}_m^1 = 0$, as well as

$$\gamma_0 \phi_m^1(x) = \gamma_0 p_m^1 - h(\gamma_0 p_m^1 - \gamma_0 p_m^0) = (1-h)\gamma_0 p_m^1 + h\gamma_0 p_m^0 \leq (1-h)\gamma_0 p_m^1 \leq 0$$

are satisfied, provided that $h < 1$. Thus, ϕ_m^1 belongs to K_m^1 .

Applying ϕ_m^1 as the test-function in (4.1.2a) at the time step $n = 1$ we find

$$h^2 \int_{\Omega} \dot{s}_m^1 \left[\dot{p}_m^1 - \dot{P}_m^1 \right] dx + h^2 \int_{\Omega} k_m^0 (\nabla p_m^1 + \hat{z}) \cdot \nabla \left[\dot{p}_m^1 - \dot{P}_m^1 \right] dx \leq 0. \quad (6.2.1)$$

Moreover, an easy computation yields the following identity

$$\begin{aligned} & \int_{\Omega} k_m^0 (\nabla p_m^1 + \hat{z}) \cdot \nabla \left[\dot{p}_m^1 - \dot{P}_m^1 \right] dx \\ &= h \int_{\Omega} k_m^0 \nabla \dot{p}_m^1 \cdot \nabla \left[\dot{p}_m^1 - \dot{P}_m^1 \right] dx + \int_{\Omega} k_m^0 \nabla (p_m^0 + z) \cdot \nabla \left[\dot{p}_m^1 - \dot{P}_m^1 \right] dx, \end{aligned}$$

and therefore we obtain dividing (6.2.1) by h^2

$$\begin{aligned} \int_{\Omega} \dot{s}_m^1 \left[\dot{p}_m^1 - \dot{\tilde{P}}_m^1 \right] dx + h \int_{\Omega} k_m^0 \nabla \dot{p}_m^1 \cdot \nabla \left[\dot{p}_m^1 - \dot{\tilde{P}}_m^1 \right] dx \\ + \int_{\Omega} k_m^0 \nabla (p_m^0 + z) \cdot \nabla \left[\dot{p}_m^1 - \dot{\tilde{P}}_m^1 \right] dx \leq 0. \end{aligned} \quad (6.2.2)$$

We estimate the terms of this inequality separately.

- ① Let us start with the first term on the left-hand side of (6.2.2). Making use of the boundedness of p_m^1 obtained in Proposition 4.2.1, of Assumption 3.2.3 on the Preisach operator, and of Proposition 2.5.5, we see that the estimates

$$\dot{s}_m^1 \dot{p}_m^1 \geq a_0 |\dot{p}_m^1|^2 \quad \text{and} \quad |\dot{s}_m^1| \leq \left(a_0 + \tilde{b}(\bar{R}) \right) |\dot{p}_m^1|.$$

are satisfied a.e. in Ω , where \bar{R} is as in Assumption 3.2.3 and $\tilde{b}(\bar{R})$ is as in Assumption 2.3.6. Hence, application of Hölder's and Young's inequalities yields the following lower bound for the first term of left-hand side of (6.2.2)

$$\begin{aligned} \int_{\Omega} \dot{s}_m^1 \left[\dot{p}_m^1 - \dot{\tilde{P}}_m^1 \right] dx &\geq a_0 \|\dot{p}_m^1\|_{L^2(\Omega)}^2 - \left(a_0 + \tilde{b}(\bar{R}) \right) \|\dot{p}_m^1\|_{L^2(\Omega)} \left\| \dot{\tilde{P}}_m^1 \right\|_{L^2(\Omega)} \\ &\geq \frac{a_0}{2} \|\dot{p}_m^1\|_{L^2(\Omega)}^2 - \frac{\left(a_0 + \tilde{b}(\bar{R}) \right)^2}{2a_0} \left\| \dot{\tilde{P}}_m^1 \right\|_{L^2(\Omega)}^2. \end{aligned} \quad (6.2.3)$$

- ② For the second term of the left-hand side of (6.2.2) we obtain with the help of the uniform boundedness of k_m^0 and Hölder's and Young's inequalities

$$\begin{aligned} h \int_{\Omega} k_m^0 \nabla \dot{p}_m^1 \cdot \nabla \left[\dot{p}_m^1 - \dot{\tilde{P}}_m^1 \right] dx \\ \geq \underline{k} h \int_{\Omega} |\nabla \dot{p}_m^1|^2 dx - \bar{k} h \int_{\Omega} |\nabla \dot{p}_m^1| \left| \nabla \dot{\tilde{P}}_m^1 \right| dx \\ \geq \frac{\underline{k}}{2} h \|\nabla \dot{p}_m^1\|_{L^2(\Omega)}^2 - \frac{\bar{k}^2}{2\underline{k}} h \left\| \nabla \dot{\tilde{P}}_m^1 \right\|_{L^2(\Omega)}^2. \end{aligned} \quad (6.2.4)$$

- ③ Finally, let us estimate the last term of the left-hand side of (6.2.2). We observe that the function

$$\psi := p_m^0 + h^2 \left[\dot{p}_m^1 - \dot{\tilde{P}}_m^1 \right]$$

belongs to K_m^0 . Indeed, we clearly have

- (i) If $x \in \Gamma_1$ with $\gamma_0 p_m^0(x) = \tilde{P}_m^0(x) > 0$, then by virtue of Assumption 3.2.1 $\gamma_0 p_m^1(x) > 0$ holds as well and consequently $\gamma_0 \psi(x) = \gamma_0 p_m^0(x)$ follows.
- (ii) If $x \in \Gamma_1$ with $\gamma_0 p_m^0(x) = \tilde{P}_m^0(x) \leq 0$, then again $\gamma_0 p_m^1(x) \leq 0$ holds by virtue of Assumption 3.2.1 and therefore $\gamma_0 \dot{\tilde{P}}_m^1(x) = 0$. With the help of $h < 1$ we conclude

$$\gamma_0 \psi(x) = \gamma_0 p_m^0(x) + h^2 \gamma_0 \dot{p}_m^1(x) = (1 - h) \gamma_0 p_m^0(x) + h \gamma_0 p_m^1(x) \leq 0,$$

and consequently $(\gamma_0 \psi)^+ = (\gamma_0 p_m^0)^+$ a.e. on Γ_1 follows.

Denoting by \vec{n} the outward normal vector to Ω , we infer with the help of Assumption 3.2.5

$$h^2 k_m^0 (\nabla p_m^0 + \hat{z}) \left[\dot{p}_m^1 - \dot{\tilde{P}}_m^1 \right] \cdot \vec{n} = -k_m^0 (\nabla p_m^0 + \hat{z}) \left(p_m^0 - \left(p_m^0 + h^2 \left[\dot{p}_m^1 - \dot{\tilde{P}}_m^1 \right] \right) \right) \cdot \vec{n} \geq 0$$

a.e. on Γ_1 , and therefore

$$k_m^0 (\nabla p_m^0 + \hat{z}) \left[\dot{p}_m^1 - \dot{\tilde{P}}_m^1 \right] \cdot \vec{n} \geq 0,$$

is satisfied a.e. on Γ_1 . Furthermore, applying Green's formula we find

$$\begin{aligned} & \int_{\Omega} k_m^0 (\nabla p_m^0 + \hat{z}) \cdot \nabla \left[\dot{p}_m^1 - \dot{\tilde{P}}_m^1 \right] dx \\ &= - \int_{\Omega} \nabla \cdot (k_m^0 (\nabla p_m^0 + \hat{z})) \left[\dot{p}_m^1 - \dot{\tilde{P}}_m^1 \right] dx \\ & \quad + \int_{\Gamma_1} k_m^0 (\nabla p_m^0 + \hat{z}) \left[\dot{p}_m^1 - \dot{\tilde{P}}_m^1 \right] \cdot \vec{n} d\sigma \\ & \geq - \int_{\Omega} \nabla \cdot (k_m^0 (\nabla p_m^0 + \hat{z})) \left[\dot{p}_m^1 - \dot{\tilde{P}}_m^1 \right] dx. \end{aligned}$$

Then, Hölder's and Young's inequalities applied to the right-hand side of the preceding inequality yield

$$\begin{aligned} & \int_{\Omega} k_m^0 (\nabla p_m^0 + \hat{z}) \cdot \nabla \left[\dot{p}_m^1 - \dot{\tilde{P}}_m^1 \right] dx \\ & \geq - \int_{\Omega} |\nabla \cdot (k_m^0 (\nabla p_m^0 + \hat{z}))| |\dot{p}_m^1| dx - \|\nabla \cdot (k_m^0 (\nabla p_m^0 + \hat{z}))\|_{L^2(\Omega)} \left\| \dot{\tilde{P}}_m^1 \right\|_{L^2(\Omega)} \\ & \geq - \frac{a_0}{4} \|\dot{p}_m^1\|_{L^2(\Omega)}^2 - \frac{2}{a_0} \|\nabla \cdot (k_m^0 (\nabla p_m^0 + \hat{z}))\|_{L^2(\Omega)}^2 - \frac{a_0}{4} \left\| \dot{\tilde{P}}_m^1 \right\|_{L^2(\Omega)}^2. \end{aligned} \quad (6.2.5)$$

Inserting the estimates (6.2.3), (6.2.4), and (6.2.5) into (6.2.2) we then obtain

$$\begin{aligned} & \frac{a_0}{4} \|\dot{p}_m^1\|_{L^2(\Omega)}^2 + \frac{k}{2} h \|\nabla \dot{p}_m^1\|_{L^2(\Omega)} \\ & \leq \frac{\bar{k}^2}{2\underline{k}} \|\nabla \dot{\tilde{P}}\|_{L^2(Q)}^2 + \frac{2}{a_0} \|\nabla \cdot (k_m^0 (\nabla p_m^0 + \hat{z}))\|_{L^2(\Omega)}^2 + \left[\frac{a_0}{4} + \frac{(a_0 + \tilde{b}(\bar{R}))^2}{2a_0} \right] |\Omega| \|\dot{\tilde{P}}\|_{L^\infty(Q)}^2. \end{aligned} \quad (6.2.6)$$

Observing that by virtue of Assumptions 3.2.1, 3.2.4, 3.2.5, and Proposition 2.4.5 the right-hand side of (6.2.6) is bounded independently of m and n , the claim follows. \square

6.3 Estimate of the Incremental Time Ratio

In this section we provide an estimate of the incremental time ratio \dot{p}_m^n of the sequence $\{p_m^n\}_{n \in \{1, \dots, m\}}$ of solutions to the approximate Problem 4.1.1 stated in the Proposition below. In order to do this, we exploit the statements of Lemmata 6.1.1 and 6.1.3, and of Proposition 6.2.1.

Proposition 6.3.1. *Let Assumptions 3.2.1 - 3.2.5 be satisfied, $m \in \mathbb{N}$, $h := \frac{T}{m}$, and let $\{p_m^n\}_{n \in \{1, \dots, m\}}$ be the sequence of solutions to Problem 4.1.1. Assume moreover with \bar{R} as in Assumption 3.2.3*

$$h \leq \frac{1}{4\bar{R}}.$$

For each $n \in \{0, \dots, m\}$ we set $s_m^n = a_0 p_m^n + w_m^n$, where w_m^n are defined according to formula (4.1.2d) corresponding to the input sequence $\{p_m^n\}_{n \in \{1, \dots, m\}}$, and the initial configuration $\lambda : \Omega \rightarrow \Lambda_{\bar{R}}$ with \bar{R} as in Assumption 3.2.3. Then there exist a constant $\mu_4 > 0$, independent of m, n , such that the following estimates hold

$$\max_{1 \leq n \leq m} \|\dot{s}_m^n\|_{L^2(\Omega)}^2, \quad \max_{1 \leq n \leq m} \|\dot{p}_m^n\|_{L^2(\Omega)}^2 + h \sum_{n=1}^m \|\nabla \dot{p}_m^n\|_{L^2(\Omega)}^2 \leq \mu_4 \quad (6.3.1)$$

Proof: Let $\varrho_0 > 0$ be such that $2\varrho_0$ is as in Assumption 3.2.2, $x_0 \in \bar{\Omega}$, and let $\zeta \in C_0^1(\mathbb{R}^3)$ be a cut-off function for the ball $B_{\varrho_0}(x_0)$ centered at x_0 with radius ϱ_0 , defined in (6.1.1).

We claim that for all $n \in \{2, \dots, m\}$ the functions

$$\begin{aligned} \phi_m^n &= p_m^n - h \left[p_m^n - p_m^{n-1} - \tilde{P}_m^n + \tilde{P}_m^{n-1} \right] \zeta^2, \\ \phi_m^{n-1} &= p_m^{n-1} - h \left[p_m^{n-1} - p_m^n - \tilde{P}_m^{n-1} + \tilde{P}_m^n \right] \zeta^2 \end{aligned}$$

belong to K_m^n and K_m^{n-1} respectively. Indeed,

- ① Let $x \in \Gamma_1$, such that $\gamma_0 p_m^n(x) > 0$ ($\gamma_0 p_m^{n-1}(x) > 0$ resp.) holds. Then by virtue of Assumption 3.2.1, we have that also $\gamma_0 p_m^{n-1}(x) > 0$ ($\gamma_0 p_m^n(x) > 0$ resp.).

Hence, $\gamma_0 p_m^n(x) = \tilde{P}_m^n(x)$, and $\gamma_0 p_m^{n-1}(x) = \tilde{P}_m^{n-1}(x)$ are satisfied, and consequently $\gamma_0 \phi_m^n(x) = \gamma_0 p_m^n(x)$ ($\gamma_0 \phi_m^{n-1}(x) = \gamma_0 p_m^{n-1}(x)$ resp.) follows.

- ② Now let $x \in \Gamma_1$, such that $\gamma_0 p_m^n(x) \leq 0$ ($\gamma_0 p_m^{n-1}(x) \leq 0$). Then again by virtue of Assumption 3.2.1, we have $\gamma_0 p_m^{n-1}(x) \leq 0$ ($\gamma_0 p_m^n(x) \leq 0$ resp.), and therefore $\tilde{P}_m^n = \tilde{P}_m^{n-1} = 0$ hold.

Thus,

$$\gamma_0 \phi_m^n \leq (1 - h\zeta^2(x))\gamma_0 p_m^n(x) + h\gamma_0 p_m^{n-1}(x)\zeta^2(x) \leq 0,$$

and analogously

$$\gamma_0 \phi_m^{n-1}(x) \leq (1 - h\zeta^2(x))\gamma_0 p_m^{n-1}(x) + h\gamma_0 p_m^n(x)\zeta^2(x) \leq 0,$$

are satisfied, provided that $h < 1$.

As a consequence we obtain $(\gamma_0 \phi_m^n)^+ = (\gamma_0 p_m^n)^+$, and $(\gamma_0 \phi_m^{n-1})^+ = (\gamma_0 p_m^{n-1})^+$ a.e. on Γ_1 , and therefore $\phi_m^n \in K_m^n$ and $\phi_m^{n-1} \in K_m^{n-1}$ follow.

Choosing in (4.1.2a) at the time step n the test-function ϕ_m^n , and at time step $n-1$ the test-function ϕ_m^{n-1} , and then adding the resulting inequalities we find

$$\begin{aligned}
& h \int_{\Omega} (\dot{s}_m^n - \dot{s}_m^{n-1}) \left[p_m^n - p_m^{n-1} - \tilde{P}_m^n + \tilde{P}_m^{n-1} \right] \zeta^2 dx \\
& + h \int_{\Omega} (k_m^{n-1}(\nabla p_m^n + \hat{z}) - k_m^{n-2}(\nabla p_m^{n-1} + \hat{z})) \cdot \nabla \left(\left[p_m^n - p_m^{n-1} - \tilde{P}_m^n + \tilde{P}_m^{n-1} \right] \zeta^2 \right) dx \leq 0.
\end{aligned}$$

Dividing both sides of the preceding inequality by h^2 and summing the result over $n \in \{2, \dots, l\}$, $l \in \{2, \dots, m\}$ it follows

$$\begin{aligned}
& \sum_{n=2}^l \int_{\Omega} (\dot{s}_m^n - \dot{s}_m^{n-1}) \left[\dot{p}_m^n - \dot{P}_m^n \right] \zeta^2 dx \\
& + \sum_{n=2}^l \int_{\Omega} (k_m^{n-1}(\nabla p_m^n + \hat{z}) - k_m^{n-2}(\nabla p_m^{n-1} + \hat{z})) \cdot \nabla \left(\left[\dot{p}_m^n - \dot{P}_m^n \right] \zeta^2 \right) dx \leq 0.
\end{aligned}$$

Let us consider the second term of the left-hand side of this inequality. A straightforward computation yields the following identities

$$\begin{aligned}
\textcircled{1} \quad & k_m^{n-1}(\nabla p_m^n + \hat{z}) - k_m^{n-2}(\nabla p_m^{n-1} + \hat{z}) \\
& = k_m^{n-1}(\nabla p_m^n + \hat{z}) - k_m^{n-1}(\nabla p_m^{n-1} + \hat{z}) + k_m^{n-1}(\nabla p_m^{n-1} + \hat{z}) - k_m^{n-2}(\nabla p_m^{n-1} + \hat{z}) \\
& = h k_m^{n-1} \nabla \dot{p}_m^n + h \dot{k}_m^{n-1}(\nabla p_m^{n-1} + \hat{z}),
\end{aligned}$$

and

$$\textcircled{2} \quad \nabla \left(\left[\dot{p}_m^n - \dot{P}_m^n \right] \zeta^2 \right) = \nabla \left[\dot{p}_m^n - \dot{P}_m^n \right] \zeta^2 + 2 \left[\dot{p}_m^n - \dot{P}_m^n \right] \zeta \nabla \zeta.$$

Hence, assembling the preceding results we conclude

$$\begin{aligned}
& \sum_{n=1}^l \int_{\Omega} (\dot{s}_m^n - \dot{s}_m^{n-1}) \dot{p}_m^n \zeta^2 dx + h \sum_{n=1}^l \int_{\Omega} k_m^{n-1} |\nabla \dot{p}_m^n|^2 \zeta^2 \\
& \leq \sum_{n=1}^l \int_{\Omega} (\dot{s}_m^n - \dot{s}_m^{n-1}) \dot{P}_m^n \zeta^2 dx + h \sum_{n=1}^l \int_{\Omega} k_m^{n-1} \nabla \dot{p}_m^n \nabla \dot{P}_m^n \zeta^2 dx \\
& - 2h \sum_{n=1}^l \int_{\Omega} k_m^{n-1} \nabla \dot{p}_m^n \left[\dot{p}_m^n - \dot{P}_m^n \right] \zeta \nabla \zeta dx - h \sum_{n=1}^l \int_{\Omega} \dot{k}_m^{n-1} (\nabla p_m^{n-1} + \hat{z}) \cdot \nabla \left[\dot{p}_m^n - \dot{P}_m^n \right] \zeta^2 dx \\
& - 2h \sum_{n=1}^l \int_{\Omega} \dot{k}_m^{n-1} (\nabla p_m^{n-1} + \hat{z}) \left[\dot{p}_m^n - \dot{P}_m^n \right] \zeta \cdot \nabla \zeta dx \tag{6.3.2}
\end{aligned}$$

Let us now estimate the terms on the left-hand side of (6.3.2). First, for $r > 0$ we put $\{\xi_m^n(\cdot, r)\}_{n \in \{0, \dots, m\}}$ to be the output of the discretized play operator defined according to formula (4.1.2e), corresponding to the input sequence $\{p_m^n(\cdot)\}_{n \in \{0, \dots, m\}}$, and the initial configuration $\lambda(\cdot, r)$. For brevity we set for $n \in \{0, \dots, m\}$

$$\xi_m^{n,r}(x) := \xi_m^n(x, r), \quad \text{and} \quad \psi_m^{n,r}(x) := \psi(\xi_m^n(x, r)), \quad \text{for a.a. } x \in \Omega.$$

Then, the Hilpert type inequality stated in Proposition 2.5.12 together with the uniform boundedness of solutions obtained in Proposition 4.2.1 yields for all $n \in \{2, \dots, m\}$

$$\begin{aligned} & \frac{\psi_m^{n r}}{2} \left| \dot{\xi}_m^{n r} \right|^2 - \frac{\psi_m^{n-1 r}}{2} \left| \dot{\xi}_{n-1}^r \right|^2 \\ & \leq \left[\frac{g(r, \xi_m^{n r}) - g(r, \xi_m^{n-1 r})}{h} - \frac{g(r, \xi_m^{n-1 r}) - g(r, \xi_m^{n-2 r})}{h} \right] \dot{p}_m^n \\ & \quad + \frac{7}{6} \sup_{\substack{0 \leq r \leq \bar{R}; \\ |z| \leq 2\bar{R}}} |\partial_z \psi(r, z)| h \left| \dot{\xi}_m^{n r} \right|^3 + \frac{1}{6} \sup_{\substack{0 \leq r \leq \bar{R}; \\ |z| \leq 2\bar{R}}} |\partial_z \psi(r, z)| h \left| \dot{\xi}_m^{n-1 r} \right|^3 \end{aligned}$$

a.e. in Ω .

Moreover, making use of Proposition 2.5.3, we obtain the pointwise estimate $\left| \dot{\xi}_m^{n r} \right| \leq \left| \dot{p}_m^n \right|$ for all $n \in \{1, \dots, m\}$ a.e. in Ω . And since $\lambda : \Omega \rightarrow \Lambda_{\bar{R}}$ by assumption, and $\|p_m^n\|_{L^\infty(\Omega)} \leq \bar{R}$ by virtue of Proposition 4.2.1, we infer with the help of Proposition 2.5.4 that $\xi_m^{n r} = 0$ is satisfied for all $n \in \{0, \dots, m\}$ a.e. in Ω , provided that $r > \bar{R}$. Thus, for any $l \in \{2, \dots, m\}$ the succeeding estimate follows

$$\begin{aligned} & \sum_{n=2}^l \int_0^{\bar{R}} \frac{\psi_m^{n r}}{2} \left| \dot{\xi}_m^{n r} \right|^2 \zeta^2 - \frac{\psi_m^{n-1 r}}{2} \left| \dot{\xi}_m^{n-1 r} \right|^2 \zeta^2 dr \\ & \leq \sum_{n=2}^l \int_0^{\bar{R}} \left[\frac{g(r, \xi_m^{n r}) - g(r, \xi_m^{n-1 r})}{h} - \frac{g(r, \xi_m^{n-1 r}) - g(r, \xi_m^{n-2 r})}{h} \right] \dot{p}_m^n \zeta^2 dr \\ & \quad + \frac{7}{6} \sup_{\substack{0 \leq r \leq \bar{R}; \\ |z| \leq 2\bar{R}}} |\partial_z \psi(r, z)| h \sum_{n=2}^l \int_0^{\bar{R}} \left| \dot{p}_m^n \right|^3 \zeta^2 dr + \frac{1}{6} \sup_{\substack{0 \leq r \leq \bar{R}; \\ |z| \leq 2\bar{R}}} |\partial_z \psi(r, z)| h \sum_{n=2}^l \int_0^{\bar{R}} \left| \dot{p}_m^{n-1} \right|^3 \zeta^2 dr. \end{aligned}$$

Bearing in mind that for $r > \bar{R}$ we have $\xi_m^{n r} = 0$ for all $n \in \{0, \dots, m\}$ a.e. in Ω and recalling the definition of the sequence $\{w_m^n\}_{n \in \{0, \dots, m\}}$, we infer

$$\begin{aligned} & \int_{\Omega} \int_0^{\bar{R}} \frac{\psi_m^{l r}}{2} \left| \dot{\xi}_m^{l r} \right|^2 \zeta^2 - \frac{\psi_m^{1 r}}{2} \left| \dot{\xi}_m^{1 r} \right|^2 \zeta^2 dr dx \\ & \leq \sum_{n=1}^l \int_{\Omega} (\dot{w}_m^n - \dot{w}_m^{n-1}) \dot{p}_m^n \zeta^2 dx \\ & \quad + \frac{14}{6} \sup_{\substack{0 \leq r \leq \bar{R}; \\ |z| \leq 2\bar{R}}} |\partial_z \psi(r, z)| \bar{R} h \sum_{n=2}^l \int_{\Omega} \left| \dot{p}_m^n \right|^3 \zeta^2 dx + \frac{1}{6} \sup_{\substack{0 \leq r \leq \bar{R}; \\ |z| \leq 2\bar{R}}} |\partial_z \psi(r, z)| \bar{R} h \int_{\Omega} \left| \dot{p}_m^1 \right|^3 \zeta^2 dx. \end{aligned}$$

Moreover, the piecewise Lipschitz property of the play operator (cf. Proposition 2.5.3), Assumptions 2.3.6 and 2.3.10 on the density ψ , and Proposition 6.2.1 imply

$$\int_{\Omega} \int_0^{\bar{R}} \frac{\psi_m^{1 r}}{2} \left| \dot{\xi}_m^{1 r} \right|^2 dr dx \leq \frac{1}{2} \int_{\Omega} \left| \dot{p}_m^1 \right|^2 \int_0^{\bar{R}} \beta(r) dr dx \leq \frac{\tilde{b}(\bar{R})}{2} \|\dot{p}_m^1\|_{L^2(\Omega)}^2 \leq \frac{\tilde{b}(\bar{R})}{2} \mu_3,$$

where $\tilde{b}(\bar{R})$ is as in Assumption 2.3.6, and where in the last estimate we made use of Proposition 6.2.1.

On the other hand, Hölder's inequality together with interpolation inequalities (c.f. Lemmata A.6.2 and A.6.1), and Proposition 6.2.1 yield the following result

$$h \int_{\Omega} |\dot{p}_m^1|^3 dx \leq h |\Omega|^{\frac{90}{7}} \|\dot{p}_m^1\|_{L^{\frac{10}{3}}(\Omega)}^3 = h^{\frac{1}{10}} |\Omega|^{\frac{90}{7}} \left(h \|\dot{p}_m^1\|_{L^{\frac{10}{3}}(\Omega)}^{\frac{10}{3}} \right)^{\frac{9}{10}} \leq h^{\frac{1}{10}} |\Omega|^{\frac{90}{7}} \left(\beta \mu_3^{\frac{1}{2}} \right)^{\frac{9}{10}},$$

where β is as in Proposition A.6.1 and μ_3 is as in Proposition 6.2.1. Bearing in mind that $h \leq 1$, setting

$$c_0 := \frac{\tilde{b}(\bar{R})}{2} \mu_3 + \frac{1}{6} \sup_{\substack{0 \leq r \leq \bar{R}; \\ |z| \leq 2\bar{R}}} |\partial_z \psi(r, z)| \bar{R} |\Omega|^{\frac{90}{7}} \left(\beta \mu_3^{\frac{1}{2}} \right)^{\frac{9}{10}},$$

$$c_1 := \frac{14}{6} \sup_{\substack{0 \leq r \leq \bar{R}; \\ |z| \leq 2\bar{R}}} |\partial_z \psi(r, z)| \bar{R},$$

and taking the nonnegativeness of ψ (c.f. Assumption 2.3.6) into account, we infer

$$\sum_{n=1}^l \int_{\Omega} (\dot{w}_m^n - \dot{w}_m^{n-1}) \dot{p}_m^n \zeta^2 dx \geq -c_0 - c_1 h \sum_{n=2}^l \int_{\Omega} |\dot{p}_m^n|^3 \zeta^2 dx. \quad (6.3.3)$$

As by virtue of Proposition 2.5.5

$$|\dot{p}_m^n|^2 \leq \frac{1}{a_0} \dot{s}_m^n \dot{p}_m^n \leq \frac{1}{a_0} |\dot{s}_m^n| |\dot{p}_m^n|$$

holds for all $n \in \{1, \dots, m\}$ a.e. in Ω , application of Lemma 6.1.1 provides for any $\epsilon > 0$

$$\begin{aligned} h \sum_{n=1}^l \int_{\Omega} |\dot{p}_m^n|^3 \zeta^2 &\leq \frac{1}{a_0} h \sum_{n=1}^l \int_{\Omega} |\dot{s}_m^n| |\dot{p}_m^n|^2 \zeta^2 \\ &\leq \frac{1}{a_0 \epsilon} h \sum_{n=1}^l \int_{\Omega} |\dot{p}_m^n|^2 |\nabla p_m^n + \hat{z}|^2 \zeta^2 dx + \frac{3\bar{k}^2}{a_0} \epsilon h \sum_{n=1}^l \|\nabla \dot{p}_m^n \zeta\|_{L^2(\Omega)}^2 \\ &\quad + \frac{\hat{C}_1(\varrho_0)}{a_0} (1 + \epsilon) h \sum_{n=1}^l \|\dot{p}_m^n\|_{L^2(\Omega)}^2 + \frac{\hat{C}_1(\varrho_0)}{a_0} \frac{1 + \epsilon^2}{\epsilon}, \end{aligned}$$

where $\hat{C}_1(\varrho_0)$ is as in Lemma 6.1.1. Choosing $\epsilon = \epsilon_1 := \frac{a_0 \bar{k}}{12c_1 \bar{k}^2}$, the preceding inequality turns into

$$\begin{aligned} c_1 h \sum_{n=1}^l \int_{\Omega} |\dot{p}_m^n|^3 \zeta^2 &\leq \frac{12c_1^2 \bar{k}^2}{a_0^2 \bar{k}} h \sum_{n=1}^l \int_{\Omega} |\dot{p}_m^n|^2 |\nabla p_m^n + \hat{z}|^2 \zeta^2 dx + \frac{\bar{k}}{4} h \sum_{n=1}^l \|\nabla \dot{p}_m^n \zeta\|_{L^2(\Omega)}^2 \\ &\quad + \frac{\hat{C}_1(\varrho_0) c_1}{a_0} (1 + \epsilon_1) h \sum_{n=1}^l \|\dot{p}_m^n\|_{L^2(\Omega)}^2 + \frac{\hat{C}_1(\varrho_0) c_1}{a_0} \frac{1 + \epsilon_1^2}{\epsilon_1}. \end{aligned}$$

Inserting this estimate into (6.3.3) and taking Lemma 6.1.1 into account, we conclude

$$\begin{aligned} \sum_{n=1}^l \int_{\Omega} (\dot{w}_m^n - \dot{w}_m^{n-1}) \dot{p}_m^n \zeta^2 dx &\geq -c_0 - \frac{12c_1^2 \bar{k}^2}{a_0^2 \bar{k}} h \sum_{n=2}^l \int_{\Omega} |\dot{p}_m^n|^2 |\nabla p_m^n + \hat{z}|^2 \zeta^2 dx - \frac{\bar{k}}{4} h \sum_{n=2}^l \|\nabla \dot{p}_m^n \zeta\|_{L^2(\Omega)}^2 \end{aligned}$$

$$- \frac{c_1 \hat{C}_1(\varrho_0)}{a_0} (1 + \epsilon_1) h \sum_{n=2}^l \|\dot{p}_m^n\|_{L^2(\Omega)}^2 - \frac{c_1 \hat{C}_1(\varrho_0)}{a_0} \frac{1 + \epsilon_1^2}{\epsilon_1}. \quad (6.3.4)$$

Inserting (6.3.4) into the left-hand side of (6.3.2) and using the uniform boundedness of the sequence $\{k_m^n\}_{n \in \{1, \dots, m\}}$ obtained in Proposition 4.2.1, we find the following estimate

$$\begin{aligned} & \sum_{n=2}^l \int_{\Omega} (\dot{s}_m^n - \dot{s}_m^{n-1}) \dot{p}_m^n \zeta^2 dx + h \sum_{n=2}^l \int_{\Omega} k_m^{n-1} |\nabla \dot{p}_m^n|^2 \zeta^2 dx \\ & \geq \frac{a_0}{2} \|\dot{p}_m^1 \zeta\|_{L^2(\Omega)}^2 + \frac{3k}{4} h \sum_{n=2}^l \|\nabla \dot{p}_m^n \zeta\|_{L^2(\Omega)}^2 - \frac{12c_1^2 \bar{k}^2}{a_0^2 k} h \sum_{n=2}^l \int_{\Omega} |\dot{p}_m^n|^2 |\nabla p_m^n + \hat{z}|^2 \zeta^2 dx \\ & \quad - \frac{a_0}{2} \|\dot{p}_m^1 \zeta\|_{L^2(\Omega)}^2 - c_0 - \frac{c_1 \hat{C}_1(\varrho_0)}{a_0} \frac{1 + \epsilon_1^2}{\epsilon_1} - \frac{c_1 \hat{C}_1(\varrho_0)}{a_0} / (1 + \epsilon_1) h \sum_{n=2}^l \|\dot{p}_m^n\|_{L^2(\Omega)}^2. \end{aligned}$$

Due to Proposition 6.2.1 $\|\dot{p}_m^1\|_{L^2(\Omega)}^2 \leq \mu_3$ holds, and consequently by virtue of Lemma 6.1.1 and Assumption 3.2.1 the quantity

$$\check{c}_1(\varrho_0) := \frac{c_1 \hat{C}_1(\varrho_0)}{a_0} (1 + \epsilon_1) + \frac{a_0}{2} \mu_3 + c_0 + \frac{c_1 \hat{C}_1(\varrho_0)}{a_0} \frac{1 + \epsilon_1^2}{\epsilon_1}$$

is bounded independently of m and n . Thus, finally we obtain the following lower bound for the left-hand side of (6.3.2)

$$\begin{aligned} & \sum_{n=2}^l \int_{\Omega} (\dot{s}_m^n - \dot{s}_m^{n-1}) \dot{p}_m^n \zeta^2 dx + h \sum_{n=2}^l \int_{\Omega} k_m^{n-1} |\nabla \dot{p}_m^n|^2 \zeta^2 dx \\ & \geq \frac{a_0}{2} \|\dot{p}_m^1 \zeta\|_{L^2(\Omega)}^2 \zeta^2 + \frac{3k}{4} h \sum_{n=2}^l \|\nabla \dot{p}_m^n \zeta\|_{L^2(\Omega)}^2 \\ & \quad - \frac{12c_1^2 \bar{k}^2}{a_0^2 k} h \sum_{n=2}^l \int_{\Omega} |\dot{p}_m^n|^2 |\nabla p_m^n + \hat{z}|^2 \zeta^2 dx \\ & \quad - \check{c}_1(\varrho_0) h \sum_{n=2}^l \|\dot{p}_m^n\|_{L^2(\Omega)}^2 - \check{c}_1(\varrho_0). \quad (6.3.5) \end{aligned}$$

Now we will deal with the right-hand side of (6.3.2).

① Setting for all $n \in \{1, \dots, m\}$

$$\ddot{P}_m^n := \frac{\dot{P}_m^n - \dot{P}_m^{n-1}}{h},$$

we obtain by discrete partial integration and Young's inequality the following estimate

$$\begin{aligned} & \sum_{n=2}^l \int_{\Omega} (\dot{s}_m^n - \dot{s}_m^{n-1}) \dot{P}_m^n \zeta^2 dx \\ & = \sum_{n=2}^l \int_{\Omega} \dot{s}_m^n \dot{P}_m^n \zeta^2 - \dot{s}_m^{n-1} \dot{P}_m^{n-1} \zeta^2 - \dot{s}_m^{n-1} \left(\dot{P}_m^n - \dot{P}_m^{n-1} \right) \zeta^2 dx \\ & = \sum_{n=2}^l \int_{\Omega} \dot{s}_m^n \dot{P}_m^n \zeta^2 - \dot{s}_m^{n-1} \dot{P}_m^{n-1} \zeta^2 dx - h \sum_{n=2}^l \int_{\Omega} \dot{s}_m^{n-1} \ddot{P}_m^n \zeta^2 dx \end{aligned}$$

$$\begin{aligned}
&\leq \sum_{n=2}^l \int_{\Omega} \dot{s}_m^n \dot{P}_m^n \zeta^2 - \dot{s}_m^{n-1} \dot{P}_m^{n-1} \zeta^2 dx + h \sum_{n=2}^l \|\dot{s}_m^{n-1} \zeta\|_{L^2(\Omega)} \left\| \ddot{P}_m^n \zeta \right\|_{L^2(\Omega)} \\
&\leq \int_{\Omega} \dot{s}_m^l \dot{P}_m^l \zeta^2 - \dot{s}_m^1 \dot{P}_m^1 \zeta^2 dx + h \sum_{n=2}^l \|\dot{s}_m^{n-1} \zeta\|_{L^2(\Omega)}^2 + \frac{1}{4} \left\| \ddot{P} \right\|_{L^2(Q)}^2.
\end{aligned}$$

With the help of Proposition 2.5.5, we see that the pointwise estimate

$$|\dot{s}_m^n| \leq (a_0 + \tilde{b}(\bar{R})) |\dot{p}_m^n| \quad (6.3.6)$$

holds for all $n \in \{1, \dots, m\}$ a.e. in Ω with \bar{R} as in Assumption 3.2.3 and $\tilde{b}(\bar{R})$ as in Assumption 2.3.6. Therefore, Hölder's and Young's inequalities yield

$$\begin{aligned}
&\int_{\Omega} \dot{s}_m^l \dot{P}_m^l \zeta^2 - \dot{s}_m^1 \dot{P}_m^1 \zeta^2 dx + h \sum_{n=2}^l \|\dot{s}_m^{n-1} \zeta\|_{L^2(\Omega)}^2 + \frac{1}{4} \left\| \ddot{P} \right\|_{L^2(Q)}^2 \\
&\leq \frac{a_0}{4} \left\| \dot{p}_m^l \right\|_{L^2(\Omega)}^2 + (a_0 + \tilde{b}(\bar{R}))^2 h \sum_{n=1}^l \|\dot{p}_m^n \zeta\|_{L^2(\Omega)}^2 \\
&\quad + 2 \frac{(a_0 + \tilde{b}(\bar{R}))^2}{a_0} \max_{0 \leq n \leq m} \left\| \dot{P}_m^n \right\|_{L^2(\Omega)}^2 + \frac{a_0}{4} \left\| \dot{p}_m^1 \right\|_{L^2(\Omega)}^2 + \frac{1}{4} \left\| \ddot{P} \right\|_{L^2(Q)}^2.
\end{aligned}$$

Moreover, again, by virtue of Proposition 6.2.1

$$\left\| \dot{p}_m^1 \right\|_{L^2(\Omega)}^2 \leq \mu_3$$

holds, and consequently we obtain

$$\begin{aligned}
&\sum_{n=2}^l \int_{\Omega} (\dot{s}_m^n - \dot{s}_m^{n-1}) \dot{P}_m^n \zeta^2 dx \\
&\leq \frac{a_0}{4} \left\| \dot{p}_m^l \right\|_{L^2(\Omega)}^2 + (a_0 + \tilde{b}(\bar{R}))^2 h \sum_{n=1}^l \|\dot{p}_m^n \zeta\|_{L^2(\Omega)}^2 \\
&\quad + 2 \frac{(a_0 + \tilde{b}(\bar{R}))^2}{a_0} |\Omega| \left\| \dot{P} \right\|_{L^\infty(Q)}^2 + \frac{a_0}{4} \mu_3 + \frac{1}{4} \left\| \ddot{P} \right\|_{L^2(Q)}^2. \quad (6.3.7)
\end{aligned}$$

- ② Let $\epsilon_2 > 0$, then Hölder's and Young's inequalities and the uniform boundedness of the sequence $\{k_m^n\}_{n \in \{1, \dots, m\}}$ obtained in Proposition 4.2.1 yield for the second term of the right-hand side of (6.3.2)

$$\begin{aligned}
h \sum_{n=2}^l \int_{\Omega} k_m^{n-1} \nabla \dot{p}_m^n \nabla \dot{P}_m^n \zeta^2 dx &\leq \bar{k} h \sum_{n=2}^l \left\| \nabla \dot{p}_m^n \zeta \right\|_{L^2(\Omega)} \left\| \nabla \dot{P}_m^n \zeta \right\|_{L^2(\Omega)} \\
&\leq \epsilon_2 h \sum_{n=2}^l \left\| \nabla \dot{p}_m^n \zeta \right\|_{L^2(\Omega)}^2 + \frac{\bar{k}^2}{4\epsilon_2} \left\| \nabla \dot{P} \right\|_{L^2(Q)}^2. \quad (6.3.8)
\end{aligned}$$

- ③ Bearing in mind that $|\nabla \zeta| \leq \frac{2}{\varrho_0}$, Hölder's, Young's and Cauchy's inequalities, together with the uniform boundedness of $\{k_m^n\}_{n \in \{1, \dots, m\}}$ imply for the third term of the right-hand side

of (6.3.2)

$$\begin{aligned}
& 2h \sum_{n=2}^l \left| \int_{\Omega} k_m^{n-1} \nabla \dot{p}_m^n \left[\dot{p}_m^n - \dot{\tilde{P}}_m^n \right] \zeta \nabla \zeta \, dx \right| \\
& \leq 2\bar{k}h \sum_{n=2}^l \int_{\Omega} |\nabla \dot{p}_m^n| \left[\left| \dot{p}_m^n \right| + \left| \dot{\tilde{P}}_m^n \right| \right] \zeta |\nabla \zeta| \, dx \\
& \leq 2\bar{k}h \sum_{n=2}^l \|\nabla \dot{p}_m^n \zeta\|_{L^2(\Omega)} \left\| \left[\left| \dot{p}_m^n \right| + \left| \dot{\tilde{P}}_m^n \right| \right] |\nabla \zeta| \right\|_{L^2(\Omega)} \\
& \leq \epsilon_2 h \sum_{n=2}^l \|\nabla \dot{p}_m^n \zeta\|_{L^2(\Omega)}^2 + \frac{4\bar{k}^2}{\varrho_0^2 \epsilon_2} h \left\| \left| \dot{p}_m^n \right| + \left| \dot{\tilde{P}}_m^n \right| \right\|_{L^2(\Omega)}^2 \\
& \leq \epsilon_2 h \sum_{n=2}^l \|\nabla \dot{p}_m^n \zeta\|_{L^2(\Omega)}^2 + \frac{8\bar{k}^2}{\varrho_0^2 \epsilon_2} h \sum_{n=2}^l \|\dot{p}_m^n\|_{L^2(\Omega)}^2 + \frac{8\bar{k}^2}{\varrho_0^2 \epsilon_2} \|\dot{\tilde{P}}\|_{L^2(Q)}^2. \tag{6.3.9}
\end{aligned}$$

- ④ Furthermore, making use of the Lipschitz continuity of k with Lipschitz constant L_k and of the pointwise inequality

$$|\dot{s}_m^n| \leq (a_0 + \tilde{b}(\bar{R})) |\dot{p}_m^n|,$$

stated in Proposition 2.5.5, we see with the help of Hölder's, Young's, and Cauchy's inequalities

$$\begin{aligned}
& h \sum_{n=2}^l \left| \int_{\Omega} \dot{k}_m^{n-1} (\nabla p_m^{n-1} + \hat{z}) \cdot \nabla \left[\dot{p}_m^n - \dot{\tilde{P}}_m^n \right] \zeta^2 \, dx \right| \\
& \leq h \sum_{n=2}^l \int_{\Omega} |\dot{k}_m^{n-1}| |\nabla p_m^{n-1} + \hat{z}| \left[|\nabla \dot{p}_m^n| + |\nabla \dot{\tilde{P}}_m^n| \right] \zeta^2 \, dx \\
& \leq h \sum_{n=2}^l \int_{\Omega} L_k (a_0 + \tilde{b}(\bar{R})) |\dot{p}_m^{n-1}| |\nabla p_m^{n-1} + \hat{z}| \left[|\nabla \dot{p}_m^n| + |\nabla \dot{\tilde{P}}_m^n| \right] \zeta^2 \, dx \\
& \leq \frac{\epsilon_2}{2} h \sum_{n=2}^l \left\| \left[|\nabla \dot{p}_m^n| + |\nabla \dot{\tilde{P}}_m^n| \right] \zeta \right\|_{L^2(\Omega)}^2 \\
& \quad + \frac{L_k^2 (a_0 + \tilde{b}(\bar{R}))^2}{2\epsilon_2} h \sum_{n=2}^l \int_{\Omega} |\dot{p}_m^{n-1}|^2 |\nabla p_m^{n-1} + \hat{z}|^2 \zeta^2 \, dx \\
& \leq \epsilon_2 h \sum_{n=2}^l \|\nabla \dot{p}_m^n \zeta\|_{L^2(\Omega)}^2 + \epsilon_2 \left\| \nabla \dot{\tilde{P}} \right\|_{L^2(Q)}^2 \\
& \quad + \frac{L_k^2 (a_0 + \tilde{b}(\bar{R}))^2}{2\epsilon_2} h \sum_{n=1}^l \int_{\Omega} |\dot{p}_m^n|^2 |\nabla p_m^n + \hat{z}|^2 \zeta^2 \, dx. \tag{6.3.10}
\end{aligned}$$

- ⑤ Finally, for the last term on the right-hand side of (6.3.2) we obtain arguing as before

$$\begin{aligned}
& h \sum_{n=2}^l \left| 2 \int_{\Omega} \dot{k}_m^{n-1} (\nabla p_m^{n-1} + \hat{z}) \left[\dot{p}_m^n - \dot{\tilde{P}}_m^n \right] \zeta \cdot \nabla \zeta \, dx \right| \\
& \leq 2h \sum_{n=2}^l \int_{\Omega} |\dot{k}_m^{n-1}| |\nabla p_m^{n-1} + \hat{z}| \left[\left| \dot{p}_m^n \right| + \left| \dot{\tilde{P}}_m^n \right| \right] \zeta |\nabla \zeta| \, dx
\end{aligned}$$

$$\begin{aligned}
&\leq h \sum_{n=2}^l \int_{\Omega} 2L_k \left(a_0 + \tilde{b}(\bar{R}) \right) |\dot{p}_m^{n-1}| |\nabla p_m^{n-1} + \hat{z}| \left[|\dot{p}_m^n| + |\dot{\tilde{P}}_m^n| \right] \zeta |\nabla \zeta| \, dx \\
&\leq \frac{16\epsilon_2}{\varrho_0^2} h \sum_{n=2}^l \|\dot{p}_m^n\|_{L^2(\Omega)}^2 + \frac{16\epsilon_2}{\varrho_0^2} \|\dot{\tilde{P}}\|_{L^2(Q)}^2 + \frac{L_k^2 \left(a_0 + \tilde{b}(\bar{R}) \right)^2}{2\epsilon_2} h \sum_{n=1}^l \int_{\Omega} |\dot{p}_m^n|^2 |\nabla p_m^n + \hat{z}|^2 \zeta^2 \, dx.
\end{aligned} \tag{6.3.11}$$

Assembling the estimates (6.3.7) -(6.3.11) it follows that

$$\begin{aligned}
\text{RHS of (6.3.2)} &\leq \frac{a_0}{4} \|\dot{p}_m^l\|_{L^2(\Omega)}^2 + 3\epsilon_2 h \sum_{n=2}^l \|\nabla \dot{p}_m^n \zeta\|_{L^2(\Omega)}^2 \\
&\quad + \frac{L_k^2 \left(a_0 + \tilde{b}(\bar{R}) \right)^2}{\epsilon_2} h \sum_{n=1}^l \int_{\Omega} |\dot{p}_m^n|^2 |\nabla p_m^n + \hat{z}|^2 \zeta^2 \, dx \\
&\quad + \left[\left(a_0 + \tilde{b}(\bar{R}) \right)^2 + \frac{8\bar{k}^2}{\varrho_0^2 \epsilon_2} + \frac{16\epsilon_2}{\varrho_0^2} \right] h \sum_{n=1}^l \|\dot{p}_m^n\|_{L^2(\Omega)}^2 \\
&\quad + 2 \frac{\left(a_0 + \tilde{b}(\bar{R}) \right)^2}{a_0} |\Omega| \|\dot{\tilde{P}}\|_{L^\infty(Q)}^2 + \frac{a_0}{4} \mu_3 + \frac{1}{4} \|\ddot{\tilde{P}}\|_{L^2(Q)}^2 \\
&\quad + \frac{\bar{k}^2}{4\epsilon_2} \|\nabla \dot{\tilde{P}}\|_{L^2(Q)}^2 + \frac{8\bar{k}^2}{\varrho_0^2 \epsilon_2} \|\dot{\tilde{P}}\|_{L^2(Q)}^2 + \epsilon_2 \|\nabla \dot{\tilde{P}}\|_{L^2(Q)}^2 + \frac{16\epsilon_2}{\varrho_0^2} \|\dot{\tilde{P}}\|_{L^2(Q)}^2
\end{aligned}$$

holds. Choosing $\epsilon_2 := \frac{k}{12}$ and observing, that due to Assumption 3.2.1 the quantity

$$\begin{aligned}
c_2(\varrho_0) &:= 2 \frac{\left(a_0 + \tilde{b}(\bar{R}) \right)^2}{a_0} |\Omega| \|\dot{\tilde{P}}\|_{L^\infty(Q)}^2 + \frac{a_0}{4} \mu_3 + \frac{1}{4} \|\ddot{\tilde{P}}\|_{L^2(Q)}^2 \\
&\quad + \frac{3\bar{k}^2}{k} \|\nabla \dot{\tilde{P}}\|_{L^2(Q)}^2 + \frac{96\bar{k}^2}{\varrho_0^2 k} \|\dot{\tilde{P}}\|_{L^2(Q)}^2 + \frac{k}{12} \|\nabla \dot{\tilde{P}}\|_{L^2(Q)}^2 + \frac{4k}{3\varrho_0^2} \|\dot{\tilde{P}}\|_{L^2(Q)}^2
\end{aligned}$$

is bounded independently of m, n , we can rewrite the preceding inequality as

$$\begin{aligned}
\text{RHS of (6.3.2)} &\leq \frac{a_0}{4} \|\dot{p}_m^l\|_{L^2(\Omega)}^2 + \frac{k}{4} h \sum_{n=2}^l \|\nabla \dot{p}_m^n \zeta\|_{L^2(\Omega)}^2 \\
&\quad + \frac{12L_k^2 \left(a_0 + \tilde{b}(\bar{R}) \right)^2}{k} h \sum_{n=1}^l \int_{\Omega} |\dot{p}_m^n|^2 |\nabla p_m^n + \hat{z}|^2 \zeta^2 \, dx \\
&\quad + \check{c}_2(\varrho_0) h \sum_{n=1}^l \|\dot{p}_m^n\|_{L^2(\Omega)}^2 + \check{c}_2(\varrho_0), \tag{6.3.12}
\end{aligned}$$

where

$$\check{c}_2(\varrho_0) := c_2(\varrho_0) + \left(a_0 + \tilde{b}(\bar{R}) \right)^2 + \frac{96\bar{k}^2}{\varrho_0^2 k} + \frac{4k}{3\varrho_0^2}.$$

Inserting the estimates (6.3.5) and (6.3.12) into (6.3.2), we find

$$\frac{a_0}{4} \|\dot{p}_m^l \zeta\|_{L^2(\Omega)}^2 + \frac{k}{2} h \sum_{n=2}^l \|\nabla \dot{p}_m^n \zeta\|_{L^2(\Omega)}^2$$

$$\begin{aligned} &\leq \left[\frac{12L_k^2 (a_0 + \tilde{b}(\bar{R}))^2}{\underline{k}} + \frac{12c_1^2 \bar{k}^2}{a_0^2 \underline{k}} \right] h \sum_{n=1}^l \int_{\Omega} |\dot{p}_m^n|^2 |\nabla p_m^n + \hat{z}|^2 \zeta^2 dx \\ &\quad + [\check{c}_1(\varrho_0) + \check{c}_2(\varrho_0)] h \sum_{n=1}^l \|\dot{p}_m^n\|_{L^2(\Omega)}^2 + \check{c}_1(\varrho_0) + \check{c}_2(\varrho_0). \end{aligned}$$

Choosing ϱ_0 , such that

$$\varrho_0 \leq \frac{1}{2} \min \left\{ \frac{1}{\mu_2}; \frac{\underline{k}}{12\mu_2} \right\}^{\frac{1}{\alpha}}$$

holds with μ_2 and α as in Proposition 5.4.1, we can apply Lemma 6.1.3 and obtain

$$\begin{aligned} &\frac{a_0}{4} \|\dot{p}_m^l \zeta\|_{L^2(\Omega)}^2 + \frac{\underline{k}}{2} h \sum_{n=2}^l \|\nabla \dot{p}_m^n \zeta\|_{L^2(\Omega)}^2 \\ &\leq \frac{2}{\underline{k}} \left[\frac{12L_k^2 (a_0 + \tilde{b}(\bar{R}))^2}{\underline{k}} + \frac{12c_1^2 \bar{k}^2}{a_0^2 \underline{k}} \right] \left[3 \left(\|\gamma_0 \dot{P}\|_{L^\infty(\Sigma_1)}^2 + 1 \right)^{\frac{3}{2}} \bar{k} + 4\bar{k}^2 \right] \mu_2 (2\varrho_0)^\alpha h \sum_{n=1}^l \|\nabla \dot{p}_m^n \zeta\|_{L^2(\Omega)}^2 \\ &\quad + \left[\hat{C}_3(\varrho_0) \frac{12L_k^2 (a_0 + \tilde{b}(\bar{R}))^2}{\underline{k}} + \check{c}_1(\varrho_0) + \check{c}_2(\varrho_0) \right] h \sum_{n=1}^l \|\dot{p}_m^n\|_{L^2(\Omega)}^2 \\ &\quad + \frac{12L_k^2 (a_0 + \tilde{b}(\bar{R}))^2}{\underline{k}} \hat{C}_3(\varrho_0) + \check{c}_1(\varrho_0) + \check{c}_2(\varrho_0), \end{aligned}$$

where $\hat{C}_3(\varrho_0)$ is as in Lemma 6.1.3. Moreover, let us take ϱ_0 such that in addition

$$\frac{2}{\underline{k}} \left[\frac{12L_k^2 (a_0 + \tilde{b}(\bar{R}))^2}{\underline{k}} + \frac{12c_1^2 \bar{k}^2}{a_0^2 \underline{k}} \right] \left[3 \left(\|\gamma_0 \dot{P}\|_{L^\infty(\Sigma_1)}^2 + 1 \right)^{\frac{3}{2}} \bar{k} + 4\bar{k}^2 \right] \mu_2 (2\varrho_0)^\alpha \leq \frac{\underline{k}}{4}.$$

holds. As a consequence, we obtain setting

$$\check{c}_3(\varrho_0) := \frac{12L_k^2 (a_0 + \tilde{b}(\bar{R}))^2}{\underline{k}} \hat{C}_3(\varrho_0) + \check{c}_1(\varrho_0) + \check{c}_2(\varrho_0)$$

the following inequality

$$\frac{a_0}{4} \|\dot{p}_m^l \zeta\|_{L^2(\Omega)}^2 + \frac{\underline{k}}{4} h \sum_{n=2}^l \|\nabla \dot{p}_m^n \zeta\|_{L^2(\Omega)}^2 \leq \frac{\underline{k}}{4} h \|\nabla \dot{p}_m^1 \zeta\|_{L^2(\Omega)}^2 + \check{c}_3(\varrho_0) h \sum_{n=1}^l \|\dot{p}_m^n\|_{L^2(\Omega)}^2 + \check{c}_3(\varrho_0).$$

And since Proposition 6.2.1 yields

$$h \|\nabla \dot{p}_m^1 \zeta\|_{L^2(\Omega)}^2 \leq \mu_3,$$

we see that

$$\frac{a_0}{4} \|\dot{p}_m^l \zeta\|_{L^2(\Omega)}^2 + \frac{\underline{k}}{4} h \sum_{n=1}^l \|\nabla \dot{p}_m^n \zeta\|_{L^2(\Omega)}^2 \leq \frac{\underline{k}}{2} \mu_3 + \check{c}_3(\varrho_0) h \sum_{n=1}^l \|\dot{p}_m^n\|_{L^2(\Omega)}^2 + \check{c}_3(\varrho_0) \quad (6.3.13)$$

is satisfied. Fixing ϱ_0^* in the following way

$$\varrho_0^* = \frac{1}{2} \min \left\{ \frac{1}{\mu_2}; \frac{k}{12\mu_2}; \frac{k^2}{8 \left[\frac{12L_k^2(a_0 + \bar{b}(\bar{R}))^2}{k} + \frac{12c_1^2 k^2}{a_0^2 k} \right] \left[3 \left(\|\gamma_0 \dot{P}\|_{L^\infty(\Sigma_1)}^2 + 1 \right)^{\frac{3}{2}} \bar{k} + 4k^2 \right]} \right\}^{\frac{1}{\alpha}},$$

and bearing in mind that Ω is bounded, we cover $\bar{\Omega}$ by a finite number $\mathfrak{N} \in \mathbb{N}$ of balls with radius ϱ_0^* . On each of this balls (6.3.13) necessarily holds. Thus, summing (6.3.13) over all these \mathfrak{N} balls, we obtain the following inequality

$$\frac{a_0}{4} \|\dot{p}_m^l\|_{L^2(\Omega)}^2 + \frac{k}{4} h \sum_{n=1}^l \|\nabla \dot{p}_m^n\|_{L^2(\Omega)}^2 \leq \frac{k}{2} \mathfrak{N} \mu_3 + \check{c}_3(\varrho_0^*) \mathfrak{N} + \check{c}_3(\varrho_0^*) \mathfrak{N} h \sum_{n=1}^l \|\dot{p}_m^n\|_{L^2(\Omega)}^2$$

Putting

$$\check{c}_4(\varrho_0^*) := \frac{4}{\min\{a_0; k\}} \left(\frac{k}{2} \mathfrak{N} \mu_3 + \check{c}_3(\varrho_0^*) \right) \mathfrak{N},$$

we conclude, that

$$\|\dot{p}_m^l\|_{L^2(\Omega)}^2 + h \sum_{n=2}^l \|\nabla \dot{p}_m^n\|_{L^2(\Omega)}^2 \leq \check{c}_4(\varrho_0^*) + \check{c}_4(\varrho_0^*) h \sum_{n=1}^l \|\dot{p}_m^n\|_{L^2(\Omega)}^2 \quad (6.3.14)$$

holds. Finally, applying the discrete Gronwall inequality (A.10.2) to (6.3.14) we arrive at

$$\|\dot{p}_m^l\|_{L^2(\Omega)}^2 + h \sum_{n=1}^l \|\nabla \dot{p}_m^n\|_{L^2(\Omega)}^2 \leq \check{c}_4(\varrho_0^*) \exp(\check{c}_4(\varrho_0^*) T).$$

Making use of the piecewise Lipschitz-property of our discrete Preisach operator (c.f Proposition 2.5.5) the claim follows. \square

6.4 Estimate of $\|\nabla s_m^n\|_{L^2(\Omega)}^2$

At last we prove a consequence of Proposition 6.3.1 which reads as follows.

Proposition 6.4.1. *Let Assumptions 3.2.1 - 3.2.5 hold, $m \in \mathbb{N}$, $h := \frac{T}{m}$, and $\{p_m^n\}_{n \in \{1, \dots, m\}}$ be the sequence of solutions to Problem (4.1.1). Moreover, assume with \bar{R} as in Assumption 3.2.3*

$$h \leq \min \left\{ 1; \frac{1}{4\bar{R}} \right\}.$$

For each $n \in \{0, \dots, m\}$ we set $s_m^n = a_0 p_m^n + w_m^n$, where w_m^n are defined according to formula (4.1.2d) corresponding to the input sequence $\{p_m^n\}_{n \in \{0, \dots, m\}}$ and the initial configuration $\lambda : \Omega \rightarrow \Lambda_{\bar{R}}$ with \bar{R} as in Assumption 3.2.3. Then there exist a constant $\mu_5 > 0$, independent of m, n , such that the following inequality is satisfied

$$h \sum_{n=1}^m \|\nabla s_m^n\|_{L^2(\Omega)}^2 \leq \mu_5. \quad (6.4.1)$$

Proof: Let the sequence $\{w_m^n\}_{n \in \{0, \dots, m\}}$ be as in the assertions of the Lemma. Then, Proposition 2.4.6 yields the following inequality

$$\max_{0 \leq n \leq m} \|\nabla w_m^n\|_{L^2(\Omega)}^2 \leq 4\hat{c} \left[1 + \left(h \sum_{n=0}^l \|\nabla p_m^n\|_{L^2(\Omega)}^2 \right) \left(h \sum_{n=1}^m \|\nabla \tilde{p}_m^n\|_{L^2(\Omega)}^2 \right) \right] \quad (6.4.2)$$

with \hat{c} as in Proposition 2.4.6. Thus, by virtue of Propositions 4.3.1 and 6.3.1 and Cauchy's inequality

$$h \sum_{n=1}^m \|\nabla s_m^n\|_{L^2(\Omega)}^2 \leq 2a_0 [\mu_1 + |Q|] + 4\hat{c}T [1 + 2\mu_4 (\mu_1 + |Q|)] =: \mu_5$$

holds, and the claim follows. \square

CHAPTER 7

FURTHER REGULARITY OF SOLUTIONS

In this chapter we study regularity properties of solutions p to Problem 3.1.1. To this aim we first use a method which is based on covering arguments of CALDERÓN-ZYGMUND type and which was introduced by Caffarelli and Peral in [13]. In this paper the authors deduce an interior higher integrability result for the gradient of solutions to elliptic equations. We will see in Section 7.1 that the presence of hysteresis poses no obstacles to the application of the techniques from [13], provided that the output of the Preisach operator is Hölder continuous, and its time derivative possesses certain integrability properties.

The higher integrability of the gradient of solutions p to Problem 3.1.1 will allow us to apply the so called MOSER ITERATION TECHNIQUE which was first introduced by Moser in his work [48] for elliptic PDEs and which was extended by Moser [49], and Aronson and Serrin [2] for parabolic (nonlinear) PDEs . The method is based on the fact that

$$\|u\|_{L^\infty} = \lim_{q \rightarrow \infty} \|u\|_{L^q}.$$

The basic idea in establishing the boundedness estimates is to choose suitable ρ_k and q_k such that for fixed $\varrho_0, t_0 > 0, \rho_0 = \varrho_0, \lim_{k \rightarrow \infty} \rho_k = \frac{\varrho_0}{2}$ and $\lim_{k \rightarrow \infty} q_k = +\infty$, and then try to prove that

$$A_k = \|u\|_{L^{q_k}(B_{\rho_k} \times (t_0 - \rho_k^2; t_0))}$$

satisfies the recursive formula

$$A_{k+1} \leq C^{\alpha_k} A_k,$$

with $\alpha_k \geq 0$, such that the series $\sum_{k=0}^{\infty} C^{\alpha_k}$ is convergent. Relying on the results of Section 7.1 we use the Moser iteration technique to establish in Section 7.2 the local boundedness of $\frac{\partial}{\partial t} p$, and in Section 7.3 the same technique provides the local boundedness of ∇p .

7.1 Calderón-Zygmund Type Estimates

We now study interior L^q estimates for the gradient of solutions p to Problem 3.1.1. Our proof follows the arguments, which can be found in [56]. The key to the proof of a higher integrability of the gradient of the function p lies in the decay estimate (7.1.30) of the level sets of the Hardy-Littlewood maximal function operator (see Definition A.11.3) of the function $|\nabla p + \hat{z}|^2$.

Iteration of (7.1.30) in combination with well known L^q estimates for the maximal function directly provides the desired integrability result. To prove (7.1.30), we make use of Lemma A.11.2 which is a direct consequence of a Calderón-Zygmund type covering argument. To apply this argument on level sets of the maximal function operator, it turns out that the statement of Lemma 7.1.2 must hold. Our strategy for the proof of Lemma 7.1.2 consist in a comparison of $\nabla p + \hat{z}$ to $\nabla v + \hat{z}$, where v is the unique weak solution of the heat equation

$$\dot{v} - \frac{k_0}{a_0} \nabla \cdot (\nabla v + \hat{z}) = 0 \text{ a.e. in } Q_\varrho, \quad v = p \text{ on } \partial Q_\varrho,$$

where Q_ϱ is a suitable small rectangle $Q_\varrho \subset Q$, ∂Q_ϱ denotes the parabolic boundary of Q_ϱ , $k_0 := \mathbf{k}[s](x_0, t_0)$ for some $(x_0, t_0) \in \overline{Q_\varrho}$, and a_0 is chosen as in Assumption 3.2.3. This comparison result is established in the following Lemma.

Lemma 7.1.1. *Suppose that the leading elliptic coefficient \mathbf{k} , the initial configuration λ , and the Preisach operator \mathfrak{W} involved in (3.1.2) satisfy Assumptions 3.2.3, and 3.2.4. Assume that Assumption 3.2.1 is satisfied and that there exists a solution $p \in H^1(Q)$ of Problem 3.1.1, such that setting $s := a_0 p + \mathfrak{W}[\lambda, p]$ with a_0 from Assumption 3.2.3*

$$p \in C^{\alpha, \frac{\alpha}{4}}(\overline{Q}), \quad \mathbf{k}[s] \in C^{\alpha, \frac{\alpha}{4}}(\overline{Q}), \quad \text{and} \quad \underline{k} \leq \mathbf{k}[s] \leq \bar{k}, \quad \text{in } Q,$$

hold with some $\alpha \in (0, 1)$, and \underline{k}, \bar{k} as in Assumption 3.2.4.

Let $x_0 \in \Omega$, $0 < t_0 \leq T$, and $0 < \varrho < 1$ satisfying

$$R_\varrho := \{x \in \mathbb{R}^3 : |x_i - x_0| < \varrho, i = 1, 2, 3\} \subset \Omega, \\ Q_\varrho := R_\varrho \times (t_0 - \varrho^2, t_0) \subset Q.$$

Setting $k_0 := \mathbf{k}(s(x_0, t_0 - \varrho^2))$, and

$$\partial Q_\varrho := \partial R_\varrho \times (t_0 - \varrho^2, t_0) \cup R_\varrho \times \{t_0 - \varrho^2\},$$

we take $v \in H^1(Q_\varrho) \cap C^{\beta, \frac{\beta}{4}}(\overline{Q})$, to be the unique weak solution of

$$a_0 \dot{v} - k_0 \nabla \cdot (\nabla v + \hat{z}) = 0 \text{ a.e. in } Q_\varrho, \quad v = p \text{ a.e. on } \partial Q_\varrho. \quad (7.1.1)$$

where $\hat{z} = (0, 0, 1) \in \mathbb{R}^3$, and $\beta \in (0, \frac{\alpha}{2})$ is as in Theorem A.9.1.

Choosing c_β as in Theorem A.9.1, and setting

$$c_\alpha := \max \left\{ \langle \mathbf{k}[s] \rangle_{x,Q}^\alpha, \langle \mathbf{k}[s] \rangle_{t,Q}^{\frac{\alpha}{4}}, \langle p \rangle_{x,Q}^\alpha, \langle p \rangle_{t,Q}^{\frac{\alpha}{4}} \right\},$$

where $\langle \cdot \rangle_{x,Q}^\alpha$ and $\langle \cdot \rangle_{t,Q}^{\frac{\alpha}{4}}$ denote the parabolic Hölder seminorms (see (A.2.2)), we suppose that ϱ satisfies in addition

$$\varrho \leq \min \left\{ 1; \left(\frac{4k}{\max \{c_\alpha, c_\beta\}} \right)^{\frac{4}{\beta}} \right\}. \quad (7.1.2)$$

Then the following estimates hold

$$\int_{Q_\varrho} |\nabla p - \nabla v|^2 dx dt \leq \frac{4 \max \{c_\alpha, c_\beta\} \varrho^{\frac{\beta}{4}}}{\underline{k}} \left[\int_{Q_\varrho} \left| \frac{\partial}{\partial t} \mathfrak{W}[\lambda, p] \right| + |\nabla p + \hat{z}|^2 dx dt \right], \quad (7.1.3a)$$

$$\int_{Q_\varrho} |\nabla v + \hat{z}|^2 dx \leq \left(2 + \frac{8 \max \{c_\alpha, c_\beta\} \varrho^{\frac{\beta}{4}}}{\underline{k}} \right) \left[\int_{Q_\varrho} \left| \frac{\partial}{\partial t} \mathfrak{W}[\lambda, p] \right| + |\nabla p + \hat{z}|^2 dx dt \right]. \quad (7.1.3b)$$

Proof: Our proof follows the arguments of [56]. Thus, taking $\varrho > 0$, $x_0 \in \Omega$, $t_0 \geq 0$, R_ϱ , Q_ϱ , ∂Q_ϱ , k_0 , p , and v as in the assumptions of the Lemma, a straightforward computation yields

$$\begin{aligned} & k_0 \int_{Q_\varrho} |\nabla p - \nabla v|^2 dx dt \\ & \leq \frac{a_0}{2} \int_{R_\varrho} |p(x, t_0) - v(x, t_0)|^2 dx + \int_{Q_\varrho} [k_0(\nabla p + \hat{z}) - k_0(\nabla v + \hat{z})] (\nabla p - \nabla v) dx dt \\ & \leq \int_{Q_\varrho} (a_0 \dot{p} - a_0 \dot{v}) (p - v) + \mathbf{k}[s] (\nabla p + \hat{z}) \nabla (p - v) - k_0 (\nabla v + \hat{z}) (\nabla p - \nabla v) dx dt \\ & \quad + \int_{Q_\varrho} (k_0 - \mathbf{k}[s]) (\nabla p + \hat{z}) \nabla (p - v) dx dt. \end{aligned} \quad (7.1.4)$$

Since v is the unique weak solution of (7.1.1), we clearly have by virtue of Theorem A.9.1 the following estimate

$$\int_{Q_\varrho} a_0 \dot{v} (v - p) + k_0 (\nabla v + \hat{z}) (\nabla v - \nabla p) dx dt \leq 0. \quad (7.1.5)$$

Let us now define the function $\chi_n(t) \in L^\infty(\mathbb{R})$ for all $n \geq 1$ as follows

$$\chi_n(t) = \begin{cases} 0, & \text{if } t \leq 0, \\ nt, & \text{if } 0 \leq t \leq \frac{1}{n}, \\ 1, & \text{if } \frac{1}{n} \leq t \leq t_0 - \frac{1}{n}, \\ n(t_0 - t), & \text{if } t_0 - \frac{1}{n} \leq t \leq t_0, \\ 0, & \text{if } t \geq t_0. \end{cases}$$

Observing that for a function $\phi \in H^1(Q)$ with the property $\gamma_0 \phi = 0$ a.e. on $\Gamma_1 \times (0, T)$ (with Γ_1 as in Assumption 3.2.1), the function $p - \phi \chi_n$ belongs to the set K (cf. Definition (3.1.1)), we infer with the help of the variational inequality (3.1.2)

$$\iint_Q (\dot{s} \phi \chi_n + \mathbf{k}[s] (\nabla p + \hat{z}) \nabla (\phi \chi_n)) dx dt \leq 0.$$

And since $\chi_n \rightarrow \chi_{[0,t_0]}$ weakly* in $L^\infty(0, T)$, where $\chi_{[0,t_0]}$ stands for the characteristic function of the set $[0, t_0]$, we can pass to the limit $n \rightarrow \infty$ in the preceding inequality and obtain

$$\int_0^{t_0} \int_{\Omega} (\dot{s}\phi + \mathbf{k}[s](\nabla p + \hat{z})\nabla\phi) dx dt \leq 0. \quad (7.1.6)$$

Bearing in mind that $v = p$ on ∂Q_ϱ , and also $p(\cdot, t_0) = v(\cdot, t_0)$ on ∂R_ϱ by continuous extension, we define the function ϕ in the following way

$$\phi = \begin{cases} 0, & \text{in } \Omega \times [0, t_0 - \varrho^2], \\ p - v, & \text{in } R_\varrho \times (t_0 - \varrho^2, t_0), \\ p(\cdot, t_0) - v(\cdot, t_0) & \text{in } R_\varrho \times [t_0, T], \\ 0, & \text{in } (\Omega \setminus R_\varrho) \times (t_0, T]. \end{cases}$$

Thus, in particular $\phi \in H^1(Q)$ and $\phi = 0$ on $\Gamma_1 \times (0, T)$ hold, and (7.1.6) implies the following estimate

$$\begin{aligned} \int_{Q_\varrho} a_0 \dot{p}(p - v) + \mathbf{k}[s](\nabla p + \hat{z})\nabla(p - v) dx dt \\ = \int_0^{t_0} \int_{\Omega} a_0 \dot{p}\phi + k(\nabla p + \hat{z})\nabla\phi dx dt \\ \leq - \int_0^{t_0} \int_{\Omega} \frac{\partial}{\partial t} \mathfrak{W}[\lambda, p]\phi dx dx \\ = - \int_{Q_\varrho} \frac{\partial}{\partial t} \mathfrak{W}[\lambda, p](p - v) dx dx, \end{aligned} \quad (7.1.7)$$

where \mathfrak{W} is the Preisach operator defined according to formula (2.4.2). Therefore, inserting (7.1.5), and (7.1.7) into (7.1.4) we obtain

$$k_0 \int_{Q_\varrho} |\nabla p - \nabla v|^2 dx dt \leq - \int_{Q_\varrho} \frac{\partial}{\partial t} \mathfrak{W}[\lambda, p](p - v) dx dx + \int_{Q_\varrho} (k_0 - \mathbf{k}[s])(\nabla p + \hat{z})\nabla(p - v) dx dt. \quad (7.1.8)$$

Bearing in mind that by assumption $p, \mathbf{k}[s] \in C^{\alpha, \frac{\alpha}{4}}(\overline{Q})$, with some given $\alpha \in (0, 1)$, and setting

$$c_\alpha = \max \left\{ \langle \mathbf{k}[s] \rangle_{x, Q}^\alpha; \langle \mathbf{k}[s] \rangle_{t, Q}^{\frac{\alpha}{4}}; \langle p \rangle_{x, Q}^\alpha; \langle p \rangle_{t, Q}^{\frac{\alpha}{4}} \right\}$$

where $\langle \cdot \rangle_{x, Q}^\alpha$ and $\langle \cdot \rangle_{t, Q}^{\frac{\alpha}{4}}$ stand for the parabolic Hölder seminorms as in (A.2.2), we observe that

$$\text{osc} \{ \mathbf{k}[s], Q_\varrho \}, \text{osc} \{ p, Q_\varrho \} \leq c_\alpha \varrho^{\frac{\alpha}{4}}$$

clearly hold. Therefore with $k_0 = \mathbf{k}[s](x_0, t_0 - \varrho^2)$ and $\varrho \leq 1$

$$| \mathbf{k}[s](x, t) - k_0 | \leq \text{osc} \{ k, Q_\varrho \} \leq c_\alpha \varrho^{\frac{\alpha}{4}}$$

follows. On the other hand, by virtue of $\varrho \leq 1$ and Theorem A.9.1 there exist constants $\beta \in (0, \frac{\alpha}{2})$, and $c_\beta > 0$, independent of ϱ , such that

$$\text{osc} \{v, Q_\varrho\} \leq c_\beta \varrho^{\frac{\beta}{4}}$$

is satisfied. Keeping in mind that $v(\cdot, t_0 - \varrho^2) = p(\cdot, t_0 - \varrho^2)$ a.e. in R_ϱ , we obtain for a.a. $(x, t) \in Q_\varrho$ the following estimate

$$\begin{aligned} |p(x, t) - v(x, t)| &= |p(x, t) - p(x_0, t_0 - \varrho^2) + p(x_0, t_0 - \varrho^2) - v(x, t)| \\ &= |p(x, t) - p(x_0, t_0 - \varrho^2) + v(x_0, t_0 - \varrho^2) - v(x, t)| \\ &\leq \text{osc} \{p, Q_\varrho\} + \text{osc} \{v, Q_\varrho\} \\ &\leq 2 \max \{c_\alpha, c_\beta\} \varrho^{\frac{\beta}{4}}. \end{aligned}$$

Consequently, as by assumption $\underline{k} \leq k_0$ holds, the following estimate follows from (7.1.8)

$$\begin{aligned} \frac{\underline{k}}{2} \int_{Q_\varrho} |\nabla p - \nabla v|^2 \, dx \, dt &\leq 2 \max \{c_\alpha, c_\beta\} \varrho^{\frac{\beta}{4}} \int_{Q_\varrho} \left| \frac{\partial}{\partial t} \mathfrak{W}[\lambda, p] \right| \, dx \, dt \\ &\quad + \max \{c_\alpha, c_\beta\} \varrho^{\frac{\beta}{4}} \int_{Q_\varrho} |\nabla p + \hat{z}| |\nabla p - \nabla v| \, dx \, dt. \end{aligned} \quad (7.1.9)$$

Thus, by virtue of $\frac{\max \{c_\alpha; c_\beta\} \varrho^{\frac{\beta}{4}}}{8} \leq \frac{\underline{k}}{2}$, Hölder's inequality applied to (7.1.8) yields

$$\frac{\underline{k}}{2} \int_{Q_\varrho} |\nabla p - \nabla v|^2 \, dx \, dt \leq 2 \max \{c_\alpha; c_\beta\} \varrho^{\frac{\beta}{4}} \left[\int_{Q_\varrho} \left| \frac{\partial}{\partial t} \mathfrak{W}[\lambda, p] \right| \, dx \, dx + \int_{Q_\varrho} |\nabla p + \hat{z}|^2 \, dx \, dt \right],$$

and (7.1.3a) follows.

For the verification of (7.1.3b) we observe that (7.1.3a) implies

$$\begin{aligned} \int_{Q_\varrho} |\nabla v + \hat{z}|^2 \, dx &= \int_{Q_\varrho} |\nabla p + \hat{z} + \nabla(v - p)|^2 \, dx \\ &\leq 2 \int_{Q_\varrho} |\nabla p + \hat{z}|^2 \, dx \, dt + 2 \int_{Q_\varrho} |\nabla p - \nabla v|^2 \, dx \, dt \\ &\leq \left(2 + \frac{8 \max \{c_\alpha; c_\beta\} \varrho^{\frac{\beta}{4}}}{\underline{k}} \right) \left[\int_{Q_\varrho} \left| \frac{\partial}{\partial t} \mathfrak{W}[\lambda, p] \right| \, dx \, dx + \int_{Q_\varrho} |\nabla p + \hat{z}|^2 \, dx \, dt \right], \end{aligned}$$

which is the desired estimate (7.1.3b). \square

We now consider a parabolic rectangle $Q_0 \subset \mathbb{R}^4$ and denote by $\mathcal{D}(Q_0)$ the set of all parabolic subrectangles \tilde{Q} of Q_0 , i.e. those rectangles with sides parallel to the sides of Q_0 that can be obtained from Q_0 by a positive finite number of parabolic subdivisions (see Definition A.11.1). We call $\check{\check{Q}}$ the PREDECESSOR of \tilde{Q} , if \tilde{Q} was obtained from $\check{\check{Q}}$ by exactly one parabolic subdivision. This procedure is illustrated in Fig. 7.1 in the case $Q_0 \subset \mathbb{R}^3$ (i.e. the spatial side is two-dimensional).

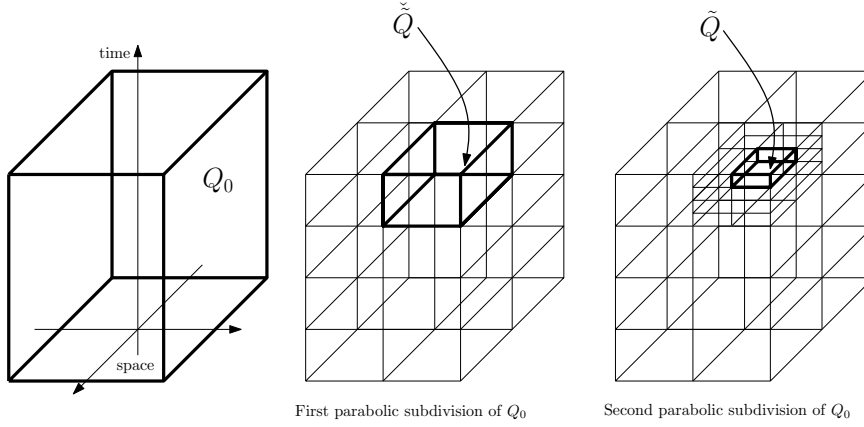

Figure 7.1: Parabolic subdivision illustrated on an example with 2-dimensional spatial side

As noted above, the application of the Calderón-Zygmund type Lemma A.11.2 will be the crucial point in deriving higher integrability estimates. The following Lemma provides a statement concerning the behavior of the level sets of the maximal function of $|\nabla p|^2$ which will be the central estimate in order to establish condition (ii) of Lemma A.11.2 for suitable sets \mathcal{X} and \mathcal{Y} .

Lemma 7.1.2. *Suppose that the leading elliptic coefficient \mathbf{k} , the initial configuration λ , and the Preisach operator \mathfrak{W} involved in (3.1.2) satisfy Assumptions 3.2.3 and 3.2.4. Assume that Assumption 3.2.1 holds and that there exists a solution $p \in H^1(Q)$ of Problem 3.1.1, such that setting $s := a_0 p + \mathfrak{W}[\lambda, p]$ with a_0 from Assumption 3.2.3*

$$p \in C^{\alpha, \frac{\alpha}{4}}(\bar{Q}), \quad \mathbf{k}[s] \in C^{\alpha, \frac{\alpha}{4}}(\bar{Q}), \quad \text{and} \quad \underline{k} \leq \mathbf{k}[s] \leq \bar{k}, \quad \text{in } Q,$$

hold with some $\alpha \in (0, 1)$, and \underline{k}, \bar{k} as in Assumption 3.2.4.

Let $x_0 \in \Omega$, $t_0 > 0$, and $\varrho_0 > 0$ satisfy

$$\begin{aligned} Q_{\varrho_0} &:= \{x \in \mathbb{R}^3 : |x_i - x_0| < \varrho_0, \ i = 1, 2, 3\} \times (t_0 - \varrho_0^2, t_0) \subset Q, \\ Q_{4\varrho_0} &:= \{x \in \mathbb{R}^3 : |x_i - x_0| < 4\varrho_0, \ i = 1, 2, 3\} \times \left(t_0 - \frac{17\varrho_0^2}{2}, t_0 + \frac{15\varrho_0^2}{2}\right) \subset Q, \end{aligned} \quad (7.1.10)$$

and

$$4\varrho_0 \leq \min \left\{ 1; \left(\frac{4\underline{k}}{\max\{c_\alpha, c_\beta\}} \right)^{\frac{4}{\beta}}; \left(\frac{\delta}{2} \frac{9^5}{4^5 \hat{c}_0} \right)^{\frac{1}{\beta}} \right\}, \quad (7.1.11)$$

for some given $\delta \in (0, 1)$, and with $\beta \in (0, \frac{\alpha}{2})$ and c_β chosen as in Theorem A.9.1, c_α as in Lemma 7.1.1, and \hat{c}_0 the constant from the weak (1,1) estimate of the maximal function operator from Lemma (A.11.4).

Let $M_{Q_{4\varrho_0}}(|\nabla p + \hat{z}|^2)$ be the restricted parabolic maximal function operator relative to $Q_{4\varrho_0}$ defined by

$$M_{Q_{4\varrho_0}}(|\nabla p + \hat{z}|^2)(\tilde{x}, \tilde{t}) := \sup_{(\tilde{x}, \tilde{t}) \in \bar{Q}} \frac{1}{|\bar{Q}|} \int_{\bar{Q}} |\nabla p + \hat{z}|^2(x, t) \, dx \, dt, \quad (7.1.12)$$

whenever $\bar{Q} \subset Q_{4\varrho_0}$ denotes any parabolic rectangle containing $(\tilde{x}, \tilde{t}) \in \mathbb{R}^4$, not necessarily with the same center.

Let $\mu > 1$ be arbitrary, and suppose there exist a parabolic rectangle $\tilde{Q} \subset Q_{\varrho_0}$ obtained by parabolic subdivision from Q_{ϱ_0} satisfying

$$\left| \left\{ (x, t) \in \tilde{Q} : M_{Q_{4\varrho_0}}(|\nabla p + \hat{z}|^2)(x, t) > 9^5 \left(4 + \frac{4^{2+\frac{\beta}{4}} \max\{c_\alpha, c_\beta\}}{\underline{k}} \right) \max\{1; \hat{c}_M\} \mu \right\} \right| > \delta |\tilde{Q}|,$$

with \hat{c}_M as in Theorem A.9.1.

Then the predecessor \check{Q} of \tilde{Q} satisfies

$$\check{Q} \subset \left\{ (x, t) \in Q_{\varrho_0} : M_{Q_{4\varrho_0}}(|\nabla p + \hat{z}|^2)(x, t) > \mu \right\} \cup \left\{ (x, t) \in Q_{\varrho_0} : M_{Q_{4\varrho_0}} \left(\left| \frac{\partial}{\partial t} \mathfrak{W}[\lambda, p] \right| \right) (x, t) > \mu \right\}.$$

Proof: Our proof follows the arguments of [56]. We argue by contradiction. Let us fix the numbers $\delta > 0$, ϱ_0 satisfying (7.1.11) and $\mu > 1$. Suppose that $\tilde{Q} \in \mathcal{D}(Q_{\varrho_0})$ is a rectangle satisfying

$$\left| \left\{ (x, t) \in \tilde{Q} : M_{Q_{4\varrho_0}}(|\nabla p + \hat{z}|^2)(x, t) > 9^5 \left(4 + \frac{4^{2+\frac{\beta}{4}} \max\{c_\alpha, c_\beta\}}{\underline{k}} \right) \max\{1; \hat{c}_M\} \mu \right\} \right| > \delta |\tilde{Q}|. \quad (7.1.13)$$

Let $\check{Q} \in \mathcal{D}(Q_{\varrho_0}) \cup \{Q_{\varrho_0}\}$ be the predecessor of \tilde{Q} (as illustrated in Figure 7.1), and assume that the conclusion for \check{Q} is false, i.e. there exists $(\xi, \tau) \in \check{Q}$ for which

$$\sup_{\substack{R \text{ rectangles} \\ (\xi, \tau) \in R}} \frac{1}{|R|} \int_R |\nabla p + \hat{z}|^2 dx dt \leq \mu, \quad \sup_{\substack{R \text{ rectangles} \\ (\xi, \tau) \in R}} \frac{1}{|R|} \int_R \left| \frac{\partial}{\partial t} \mathfrak{W}[\lambda, p] \right| dx dt \leq \mu \quad (7.1.14)$$

hold for all parabolic rectangles $R \subset Q_{4\varrho_0}$ with $(\xi, \tau) \in R$.

Since $\tilde{Q} \in \mathcal{D}(Q_{\varrho_0})$ was obtained from Q_{ϱ_0} by parabolic subdivision, there exist $\mathfrak{r} \in \mathbb{R}^3$, $\mathfrak{t} > 0$, and $\varrho > 0$, such that \tilde{Q} can be represented as

$$\tilde{Q} = \{x \in \mathbb{R}^3 : |x_i - \mathfrak{r}| < \varrho, i = 1, 2, 3\} \times (\mathfrak{t} - \varrho^2, \mathfrak{t}).$$

Let p be a solution to Problem 3.1.1, and $s := a_0 p + \mathfrak{W}[\lambda, p]$ with a_0 as in Assumption 3.2.3 and \mathfrak{W} be the Preisach operator defined by formula (2.4.3) corresponding to the input p and the initial configuration λ . Setting $k_0 := \mathbf{k}[s] \left(\mathfrak{r}, \mathfrak{t} - \frac{17\varrho^2}{2} \right)$ and defining

$$\tilde{R}_{4\varrho} := \{x \in \mathbb{R}^3 : |x_i - \mathfrak{r}| < 4\varrho, i = 1, 2, 3\}, \quad \tilde{Q}_{4\varrho} := \tilde{R}_{4\varrho} \times \left(\mathfrak{t} - \frac{17\varrho^2}{2}, \mathfrak{t} + \frac{15\varrho^2}{2} \right),$$

and

$$\partial \tilde{Q}_{4\varrho} = \partial \tilde{R}_{4\varrho} \times \left(\mathfrak{t} - \frac{17\varrho^2}{2}, \mathfrak{t} + \frac{15\varrho^2}{2} \right) \cup \tilde{R}_{4\varrho} \times \left\{ \mathfrak{t} - \frac{17\varrho^2}{2} \right\},$$

(see the illustrative example in Figure 7.2), we consider the unique weak solution $v \in H^1(\tilde{Q}_{4\varrho})$ of

$$a_0 \dot{v} - k_0 \nabla \cdot (\nabla v + \hat{z}) = 0 \text{ a.e. in } \tilde{Q}_{4\varrho}, \quad v = p \text{ a.e. on } \partial \tilde{Q}_{4\varrho}.$$

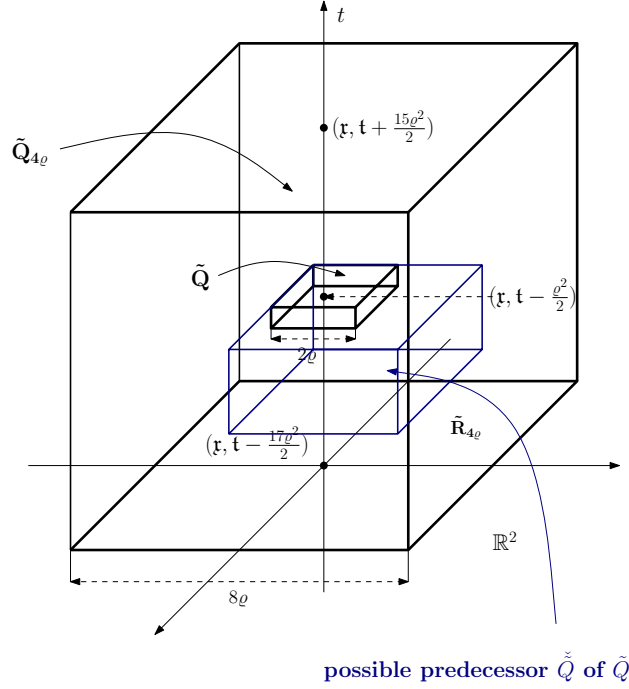

Figure 7.2: Illustrative example of the rectangles \tilde{Q} , \check{Q} , and $\tilde{Q}_{4\varrho}$

As \tilde{Q} was obtained by exactly one parabolic subdivision from \check{Q} , the inclusion $\tilde{Q} \subset \tilde{Q}_{4\varrho}$ holds (see illustration in Figure 7.2). Thus, we have $(\xi, \tau) \in \tilde{Q}_{4\varrho}$, so (7.1.14) yields in particular

$$\frac{1}{|\tilde{Q}_{4\varrho}|} \int_{\tilde{Q}_{4\varrho}} |\nabla p + \hat{z}|^2 dx dt \leq \mu, \quad \frac{1}{|\tilde{Q}_{4\varrho}|} \int_{\tilde{Q}_{4\varrho}} \left| \frac{\partial}{\partial t} \mathfrak{W}[\lambda, p] \right| dx dt \leq \mu.$$

Therefore, checking that by assumption 4ϱ satisfies (7.1.2), we obtain by virtue of Lemma 7.1.1, together with the preceding inequalities the following estimates

$$\textcircled{1} \quad \iint_{\tilde{Q}_{4\varrho}} |\nabla p - \nabla v|^2 dx dt \leq \frac{4 \max\{c_\alpha, c_\beta\} (4\varrho_0)^{\frac{\beta}{4}}}{\underline{k}} \mu |\tilde{Q}_{4\varrho}| \quad (7.1.15)$$

$$\textcircled{2} \quad \iint_{\tilde{Q}_{4\varrho}} |\nabla v + \hat{z}|^2 dx dt \leq 2 \left(2 + \frac{8 \max\{c_\alpha, c_\beta\} (4\varrho_0)^{\frac{\beta}{4}}}{\underline{k}} \right) \mu |\tilde{Q}_{4\varrho}|, \quad (7.1.16)$$

where c_α , c_β , and β are as in Lemma 7.1.1, and \underline{k} is as in Assumption 3.2.4.

Bearing in mind that $\varrho_0 \leq 1$, we obtain by virtue of Theorem A.9.1 and estimate (7.1.16) for

$$\tilde{Q}_{2\varrho} := \left\{ x \in \mathbb{R}^3 : |x_i - \mathfrak{x}| < 2\varrho, i = 1, 2, 3 \right\} \times \left(t - \frac{5\varrho^2}{2}, t + \frac{3\varrho^2}{2} \right),$$

the following inequality

$$\begin{aligned} \sup_{(x,t) \in \tilde{Q}_{2\varrho}} |\nabla v(x,t) + \hat{z}|^2 &\leq \frac{\hat{c}_M}{|\tilde{Q}_{4\varrho}|} \iint_{\tilde{Q}_{4\varrho}} |\nabla v + \hat{z}|^2 dx dt \\ &\leq 2 \left(2 + \frac{8 \max\{c_\alpha, c_\beta\} (4\varrho_0)^{\frac{\beta}{4}}}{\underline{k}} \right) \hat{c}_M \mu \\ &\leq \left(4 + \frac{4^{2+\frac{\beta}{4}} \max\{c_\alpha, c_\beta\}}{\underline{k}} \right) \max\{1; \hat{c}_M\} \mu =: N_0 \mu, \quad (7.1.17) \end{aligned}$$

with the obvious labeling of N_0 and the constant \hat{c}_M as in Theorem A.9.1.

Let us now consider the restricted maximal function operator relative to $\tilde{Q}_{2\varrho}$ defined as follows

$$M_{\tilde{Q}_{2\varrho}} \left(|\nabla p + \hat{z}|^2 \right) (x, t) := \sup_{\substack{R \subset Q_{2\varrho_0}, \\ (x, t) \in R}} \frac{1}{|R|} \int_R |\nabla p + \hat{z}|^2 dy ds.$$

We now claim that for any $(x, t) \in \tilde{Q}$

$$M_{Q_{4\varrho_0}} \left(|\nabla p + \hat{z}|^2 \right) (x, t) \leq \max \left\{ M_{\tilde{Q}_{2\varrho}} \left(|\nabla p + \hat{z}|^2 \right) (x, t), 9^5 \mu \right\} \quad (7.1.18)$$

holds.

Indeed, let $(x, t) \in \tilde{Q}$ and $R \subset Q_{4\varrho_0}$ be a parabolic rectangle satisfying $(x, t) \in R$ and $R \not\subset \tilde{Q}_{2\varrho}$.

Taking \tilde{x} , \tilde{t} , and $\tilde{\rho}$, such that R can be represented as

$$R := \{x \in \mathbb{R}^3; |x_i - \tilde{x}| < \tilde{\rho}, i = 1, 2, 3\} \times (\tilde{t} - \tilde{\rho}^2, \tilde{t}),$$

we observe that clearly $\tilde{\rho} > \frac{\varrho}{2}$ must hold. Thus, in particular there exists a rectangle \tilde{R} , such that $R \subset \tilde{R} \subset Q_{4\varrho_0}$ holds, and which has the property that $\tilde{Q} \subset \tilde{R}$, and $|\tilde{R}| \leq 9^5 |R|$. In Figure 7.3 we present an illustration of the spatial side of this relation.

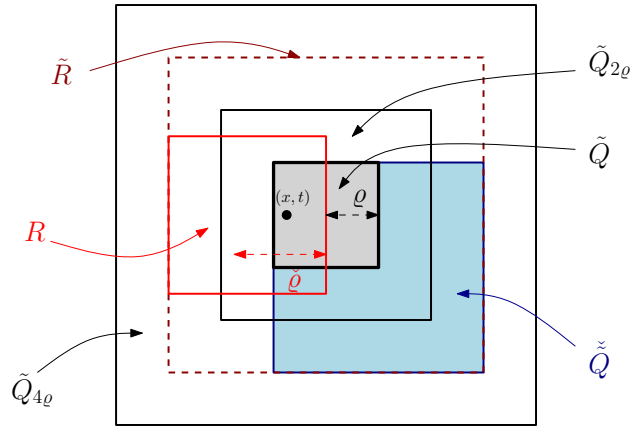

Figure 7.3: Illustrative example of spatial sides of the rectangles \tilde{Q} , \check{Q} , $\tilde{Q}_{2\varrho}$, $\tilde{Q}_{4\varrho}$, R , and \tilde{R}

Hence, by virtue of (7.1.14) we have the following estimate

$$\frac{1}{|R|} \int_R |\nabla p + \hat{z}|^2 dy ds \leq \frac{1}{|R|} \int_{\tilde{R}} |\nabla p + \hat{z}|^2 dy ds = \frac{|\tilde{R}|}{|R|} \frac{1}{|\tilde{R}|} \int_{\tilde{R}} |\nabla p + \hat{z}|^2 dy ds \leq 9^5 \mu,$$

so consequently (7.1.18) is satisfied.

Now, we claim that with N_0 defined as in (7.1.17), the following inclusion holds

$$\begin{aligned} & \left\{ (x, t) \in \tilde{Q} : M_{\tilde{Q}_{2\varrho}} \left(|\nabla p + \hat{z}|^2 \right) (x, t) > 9^5 N_0 \mu \right\} \\ & \subset \left\{ (x, t) \in \tilde{Q} : M_{\tilde{Q}_{2\varrho}} \left(|\nabla(p - v)|^2 \right) (x, t) > \frac{9^5 N_0}{4} \mu \right\}. \end{aligned} \quad (7.1.19)$$

Indeed, let (\tilde{x}, \tilde{t}) be such that $(\tilde{x}, \tilde{t}) \in \left\{ (x, t) \in \tilde{Q} : M_{\tilde{Q}_{2\varrho}} \left(|\nabla(p-v)|^2 \right) (x, t) \leq \frac{9^5 N_0}{4} \mu \right\}$. By virtue of

$$|\nabla p + \hat{z}|^2 = |\nabla p - \nabla v + \nabla v + \hat{z}|^2 \leq 2|\nabla p - \nabla v|^2 + 2|\nabla v + \hat{z}|^2,$$

and the boundedness of $|\nabla v + \hat{z}|^2$ in $\tilde{Q}_{2\varrho}$ obtained in (7.1.17) it follows

$$\sup_{\substack{R \subset \tilde{Q}_{2\varrho}, \\ (\tilde{x}, \tilde{t}) \in R}} \frac{1}{|R|} \int_R |\nabla p + \hat{z}|^2 dy ds \leq 2 \sup_{\substack{R \subset \tilde{Q}_{2\varrho}, \\ (\tilde{x}, \tilde{t}) \in R}} \int_R |\nabla(p-v)|^2 dx dt + 2N_0\mu \leq \frac{9^5 N_0 \mu}{2} + 2N_0\mu.$$

And since clearly $2 \leq \frac{9^5}{2}$, we obtain (7.1.19).

As a consequence of (7.1.18) and (7.1.19) we obtain the following bound

$$\begin{aligned} & \left| \left\{ (x, t) \in \tilde{Q} : M_{Q_{4\varrho_0}} \left(|\nabla p + \hat{z}|^2 \right) (x, t) > 9^5 N_0 \mu \right\} \right| \\ & \leq \left| \left\{ (x, t) \in \tilde{Q} : \max \left\{ M_{\tilde{Q}_{2\varrho}} \left(|\nabla p + \hat{z}|^2 \right) (x, t); 9^5 \right\} > 9^5 N_0 \mu \right\} \right| \\ & \leq \left| \left\{ (x, t) \in \tilde{Q} : M_{\tilde{Q}_{2\varrho}} \left(|\nabla p + \hat{z}|^2 \right) (x, t) > 9^5 N_0 \mu \right\} \right| \\ & \leq \left| \left\{ (x, t) \in \tilde{Q} : M_{\tilde{Q}_{2\varrho}} \left(|\nabla(p-v)|^2 \right) (x, t) > \frac{9^5 N_0}{4} \mu \right\} \right|. \end{aligned}$$

Keeping in mind that by definition $\frac{4^{2+\frac{\beta}{4}} \max \{c_\alpha; c_\beta\}}{k} \leq N_0$, the (1,1) weak type estimate for the maximal function operator stated in Lemma A.11.4 yields

$$\begin{aligned} & \left| \left\{ (x, t) \in \tilde{Q} : M_{\tilde{Q}_{2\varrho}} \left(|\nabla(p-v)|^2 \right) (x, t) > \frac{9^5 N_0}{4} \mu \right\} \right| \\ & \leq \frac{4\hat{c}_0}{9^5 N_0 \mu} \int_{\tilde{Q}_{2\varrho}} |\nabla(p-v)|^2 dx dt \\ & \leq \frac{4\hat{c}_0}{9^5 N_0 \mu} \int_{\tilde{Q}_{4\varrho}} |\nabla(p-v)|^2 dx dt \\ & \leq \frac{4\hat{c}_0}{9^5 N_0} \frac{4 \max \{c_\alpha; c_\beta\} (4\varrho_0)^{\frac{\beta}{4}}}{k} \left| \tilde{Q}_{4\varrho} \right| \\ & \leq \frac{4^5 \hat{c}_0}{9^5} \varrho_0^{\frac{\beta}{4}} \left| \tilde{Q} \right|, \end{aligned}$$

where the constant \hat{c}_0 is as in Lemma A.11.4. And finally, since by assumption

$$\varrho_0 \leq \left(\frac{\delta}{2} \frac{9^5}{4^5 \hat{c}_0} \right)^{\frac{4}{\beta}},$$

we conclude that

$$\left| \left\{ (x, t) \in \tilde{Q} : M_{Q_{4\varrho_0}} \left(|\nabla p + \hat{z}|^2 \right) (x, t) > 9^5 N_0 \mu \right\} \right| \leq \frac{\delta}{2} \left| \tilde{Q} \right|$$

holds, which is a contradiction to (7.1.13) and completes the proof of the Lemma. \square

Let us now prove an important consequence of Lemma 7.1.2.

Corollary 7.1.3. *Under the same hypotheses as in Lemma 7.1.2 the following estimate holds for all $k \in \mathbb{N}$*

$$\begin{aligned} & \left| \left\{ (x, t) \in Q_{\varrho_0} : M_{Q_{4\varrho_0}}(|\nabla p + \hat{z}|^2)(x, t) > (9^5 N_0)^k \eta_0 \right\} \right| \\ & \leq \delta^k \left| \left\{ (x, t) \in Q_{\varrho_0} : M_{Q_{4\varrho_0}}(|\nabla p + \hat{z}|^2)(x, t) > \eta_0 \right\} \right| \\ & \quad + \sum_{i=0}^k \delta^{(k-i)} \left| \left\{ (x, t) \in Q_{\varrho_0} : M_{Q_{4\varrho_0}} \left(\left| \frac{\partial}{\partial t} \mathfrak{W}[\lambda, p] \right| \right) (x, t) > (9^5 N_0)^i \eta_0 \right\} \right|, \end{aligned} \quad (7.1.20)$$

where

$$N_0 := \left(4 + \frac{4^{2+\frac{\beta}{4}} \max\{c_\alpha, c_\beta\}}{\underline{k}} \right) \max\{1; \hat{c}_M\},$$

and

$$\eta_0 := \frac{2}{\delta} \frac{\hat{c}_0}{|Q_{4\varrho_0}|} \int_{Q_{4\varrho_0}} |\nabla p + \hat{z}|^2 dx dt + 1,$$

and where the constant c_α is as in Lemma 7.1.2, c_β, \hat{c}_M are as in Theorem A.9.1, and \hat{c}_0 is as in Lemma A.11.4.

Proof: Let $\delta > 0$ be given and fix ϱ_0 such that ϱ_0 satisfies (7.1.11). Moreover let $Q_{\varrho_0}, Q_{4\varrho_0}$ be as (7.1.10).

To prove (7.1.20), we define for an arbitrary $\mu \geq \eta_0$ the sets

$$\mathcal{X} := \left\{ (x, t) \in Q_{\varrho_0} : M_{Q_{4\varrho_0}} \left(|\nabla p + \hat{z}|^2 \right) (x, t) > 9^5 N_0 \mu \right\},$$

and

$$\begin{aligned} \mathcal{Y} := & \left\{ (x, t) \in Q_{\varrho_0} : M_{Q_{4\varrho_0}}(|\nabla p + \hat{z}|^2)(x, t) > \mu \right\} \\ & \cup \left\{ (x, t) \in Q_{\varrho_0} : M_{Q_{4\varrho_0}} \left(\left| \frac{\partial}{\partial t} \mathfrak{W}[\lambda, p] \right| \right) (x, t) > \mu \right\}. \end{aligned}$$

Bearing in mind the definition of η_0 , the weak (1,1) estimate for $M_{Q_{4\varrho_0}}$ stated in Lemma A.11.4 yields

$$|\mathcal{X}| \leq \left| \left\{ (x, t) \in Q_{\varrho_0} : M_{Q_{4\varrho_0}} \left(|\nabla p + \hat{z}|^2 \right) (x, t) > \eta_0 \right\} \right| \leq \frac{\hat{c}_0}{\eta_0} \int_{Q_{4\varrho_0}} |\nabla p + \hat{z}|^2 dx dt \leq \frac{\delta}{2} |Q_{4\varrho_0}|.$$

Let us now consider a parabolic rectangle $\tilde{Q} \in \mathcal{D}(Q_{\varrho_0})$ satisfying

$$|\tilde{Q} \cap \mathcal{X}| > \delta |\tilde{Q}|,$$

with δ as above. Then according to Lemma 7.1.2 the predecessor $\check{\tilde{Q}}$ of \tilde{Q} satisfies

$$\check{\tilde{Q}} \subset \mathcal{Y}.$$

At this stage Lemma A.11.2 shows that

$$|\mathcal{X}| < \delta |\mathcal{Y}|. \quad (7.1.21)$$

With the choice

$$\mu_k := (9^5 N_0)^{k-1} \eta_0 \quad \text{for } k = 1, 2, \dots$$

estimate (7.1.21) translates directly in

$$\begin{aligned} & \left| \left\{ (x, t) \in Q_{\varrho_0} : M_{Q_{4\varrho_0}}(|\nabla p + \hat{z}|^2)(x, t) > (9^5 N_0)^k \eta_0 \right\} \right| \\ & \leq \delta \left| \left\{ (x, t) \in Q_{\varrho_0} : M_{Q_{4\varrho_0}}(|\nabla p + \hat{z}|^2)(x, t) > (9^5 N_0)^{k-1} \eta_0 \right\} \right| \\ & \quad + \delta \left| \left\{ (x, t) \in Q_{\varrho_0} : M_{Q_{4\varrho_0}} \left(\left| \frac{\partial}{\partial t} \mathfrak{W}[\lambda, p] \right| \right) (x, t) > (9^5 N_0)^{k-1} \eta_0 \right\} \right| \end{aligned}$$

for all $k \in \mathbb{N}$. Iteration of this estimate immediately yields

$$\begin{aligned} & \left| \left\{ (x, t) \in Q_{\varrho_0} : M_{Q_{4\varrho_0}}(|\nabla p + \hat{z}|^2)(x, t) > (9^5 N_0)^k \eta_0 \right\} \right| \\ & \leq \delta^k \left| \left\{ (x, t) \in Q_{\varrho_0} : M_{Q_{4\varrho_0}}(|\nabla p + \hat{z}|^2)(x, t) > \eta_0 \right\} \right| \\ & \quad + \sum_{i=0}^{k-1} \delta^i \left| \left\{ (x, t) \in Q_{\varrho_0} : M_{Q_{4\varrho_0}} \left(\left| \frac{\partial}{\partial t} \mathfrak{W}[\lambda, p] \right| \right) (x, t) > (9^5 N_0)^{k-i} \eta_0 \right\} \right|. \end{aligned}$$

Thus, rearranging the order of summation, the claim follows. \square

In the next Lemma we will see how the estimate (7.1.20) can be translated into an interior reverse Hölder inequality for the gradient of solutions p to Problem 3.1.1 which in turn yields the higher interior integrability of ∇p .

Proposition 7.1.4. *Suppose that the leading elliptic coefficient \mathbf{k} , the initial configuration λ , and the Preisach operator \mathfrak{W} involved in (3.1.2) satisfy Assumptions 3.2.3, and 3.2.4. Assume that Assumption 3.2.1 is satisfied and that there exists a solution $p \in H^1(Q)$ of Problem 3.1.1 such that setting $s := a_0 p + \mathfrak{W}[\lambda, p]$ with a_0 from Assumption 3.2.3*

$$p \in C^{\alpha, \frac{\alpha}{4}}(\overline{Q}), \quad \mathbf{k}[s] \in C^{\alpha, \frac{\alpha}{4}}(\overline{Q}), \quad \frac{\partial}{\partial t} \mathfrak{W} \in L^q(Q) \quad \text{and} \quad \underline{k} \leq \mathbf{k}[s] \leq \bar{k}, \quad \text{in } Q,$$

hold with some $\alpha \in (0, 1)$, some $q \geq 1$, and \underline{k}, \bar{k} as in Assumption 3.2.4. Then

$$\nabla p \in L_{loc}^{2q}(Q).$$

Proof: Let N_0 , and $\varrho_0 > 0$ be as in Corollary 7.1.3, the rectangles $Q_{\varrho_0}, Q_{4\varrho_0} \subset Q$ be defined as in (7.1.10), and q as in the conditions of the Lemma.

Since every function $f \in L_{loc}^1(Q)$ is bounded pointwise a.e. in Q_{ϱ_0} by the maximal function $M_{Q_{4\varrho_0}}$ (defined in (7.1.12)), the following estimate holds

$$\int_{Q_{\varrho_0}} |\nabla p + \hat{z}|^{2q} dx dt = \int_{Q_{\varrho_0}} (|\nabla p + \hat{z}|^2)^q dx dt \leq \int_{Q_{\varrho_0}} \left(M_{Q_{4\varrho_0}}(|\nabla p + \hat{z}|^2) \right)^q dx dt. \quad (7.1.22)$$

Applying the elementary identity (see. e.g [61, Theorem 8.16])

$$\int_{Q_{\varrho_0}} g^q dx dt = \int_0^\infty q\lambda^{q-1} |\{(x, t) \in Q_{\varrho_0} : g(x, t) > \lambda\}| d\lambda, \quad (7.1.23)$$

to the function $g = M_{Q_{4\varrho_0}} (|\nabla p + \hat{z}|^2)$, we find that

$$\int_{Q_{\varrho_0}} \left(M_{Q_{4\varrho_0}} (|\nabla p + \hat{z}|^2) \right)^q dx dt = \int_0^\infty q\lambda^{q-1} \left| \{(x, t) \in Q_{\varrho_0} : M_{Q_{4\varrho_0}} (|\nabla p + \hat{z}|^2) (x, t) > \lambda\} \right| d\lambda$$

is satisfied, and consequently (7.1.22) turns into

$$\int_{Q_{\varrho_0}} |\nabla p + \hat{z}|^{2q} dx dt \leq \int_0^\infty q\lambda^{q-1} \left| \{(x, t) \in Q_{\varrho_0} : M_{Q_{4\varrho_0}} (|\nabla p + \hat{z}|^2) (x, t) > \lambda\} \right| d\lambda. \quad (7.1.24)$$

Let us now define the quantities

$$\begin{aligned} \eta_1(s) &:= \left| \{(x, t) \in Q_{\varrho_0} : M_{Q_{4\varrho_0}} (|\nabla p + \hat{z}|^2) (x, t) > s\} \right|, \\ \eta_2(s) &:= \left| \{(x, t) \in Q_{\varrho_0} : M_{Q_{4\varrho_0}} \left(\left| \frac{\partial}{\partial t} \mathfrak{W}[\lambda, p] \right| \right) (x, t) > s\} \right|. \end{aligned} \quad (7.1.25)$$

We observe that both η_1 and η_2 are monotonically decreasing functions. So, setting

$$N_1 := 9^5 N_0, \quad (7.1.26)$$

and taking η_0 as in Corollary 7.1.3, we can decompose the interval $[0, \infty)$ in the following way

$$[0, \infty) = [0, \eta_0] \cup [\eta_0, N_1 \eta_0] \cup [N_1 \eta_0, N_1^2 \eta_0] \cup [N_1^2 \eta_0, N_1^3 \eta_0] \cup \dots$$

Assembling (7.1.25) and (7.1.24), we obtain

$$\begin{aligned} \int_{Q_{\varrho_0}} |\nabla p + \hat{z}|^{2q} dx dt &\leq \int_0^\infty q\lambda^{q-1} \eta_1(\lambda) d\lambda \\ &= q \int_0^{\eta_0} \lambda^{q-1} \eta_1(\lambda) d\lambda + q \sum_{k=0}^\infty \int_{N_1^k \eta_0}^{N_1^{k+1} \eta_0} \lambda^{q-1} \eta_1(\lambda) d\lambda \\ &\leq \eta_1(\eta_0) + q \sum_{k=0}^\infty \int_{N_1^k \eta_0}^{N_1^{k+1} \eta_0} \lambda^{q-1} \eta_1(N_1^k \eta_0) d\lambda. \end{aligned} \quad (7.1.27)$$

Exploiting the monotonicity of the function $\eta_1(t)$, we find

$$\begin{aligned} q \sum_{k=0}^\infty \int_{N_1^k \eta_0}^{N_1^{k+1} \eta_0} \lambda^{q-1} \eta_1(\lambda) d\lambda &\leq q \sum_{k=0}^\infty \int_{N_1^k \eta_0}^{N_1^{k+1} \eta_0} \lambda^{q-1} \eta_1(N_1^k \eta_0) d\lambda \\ &\leq \sum_{k=0}^\infty \eta_1(N_1^k \eta_0) \left[(N_1^{k+1} \eta_0)^q - (N_1^k \eta_0)^q \right] \\ &\leq \sum_{k=0}^\infty \eta_1(N_1^k \eta_0) \left[N_1^{k+1} \eta_0 \right]^q \\ &\leq (N_1 \eta_0)^q \sum_{k=0}^\infty \eta_1(N_1^k \eta_0) (N_1)^{qk}. \end{aligned} \quad (7.1.28)$$

Thus, using

$$\eta_1(\eta_0) \leq \eta_1(0) = \left| \left\{ (x, t) \in Q_{\varrho_0} : M_{Q_{4\varrho_0}}(|\nabla p + \hat{z}^2|)(x, t) > 0 \right\} \right| \leq |Q_{\varrho_0}|$$

together with (7.1.28), we conclude from (7.1.27) the following estimate

$$\int_{Q_{\varrho_0}} |\nabla p + \hat{z}|^{2q} dx \leq |Q_{\varrho_0}| + (N_1 \eta_0)^q \sum_{k=0}^{\infty} \eta_1(N_1^k \eta_0) (N_1)^{qk}. \quad (7.1.29)$$

Hence, we see that $\|\nabla p + \hat{z}\|_{L^{2q}(Q_{\varrho_0})}$ is finite, if we can prove that the series

$$\sum_{k=0}^{\infty} \eta_1(N_1^k \eta_0) (N_1)^{qk}$$

converges. Setting

$$\delta := \frac{1}{2N_1^q}$$

and choosing ϱ_0 satisfying the restriction (7.1.11), we obtain by virtue of Corollary 7.1.3 for any $k = 1, 2, \dots$ the following estimate

$$\eta_1(N_1^k \eta_0) \leq \delta^k \eta_1(\eta_0) + \sum_{i=0}^k \delta^{(k-i)} \eta_2(N_1^i \eta_0), \quad (7.1.30)$$

where we observe that this estimate trivially holds also for $k = 0$.

Let $J \in \mathbb{N}$ arbitrary and recalling the definition of δ we calculate

$$\begin{aligned} \sum_{k=0}^J N_1^{qk} \eta_1(N_1^k \eta_0) &\leq \sum_{k=0}^J N_1^{qk} \delta^k \eta_1(\eta_0) + \sum_{k=0}^J N_1^{qk} \sum_{i=0}^k \delta^{(k-i)} \eta_2(N_1^i \eta_0) \\ &= \sum_{k=0}^J \frac{1}{(2\delta)^k} \delta^k \eta_1(\eta_0) + \sum_{k=0}^J \frac{1}{(2\delta)^k} \sum_{i=0}^k \delta^{(k-i)} \eta_2(N_1^i \eta_0) \\ &= \sum_{k=0}^J \frac{1}{(2)^k} \eta_1(\eta_0) + \sum_{k=0}^J \sum_{i=0}^k 2^{-k} \delta^{-i} \eta_2(N_1^i \eta_0) \\ &\leq 2\eta_1(\eta_0) + \mathcal{A}, \end{aligned}$$

with the obvious labeling of \mathcal{A} , where the last step followed by exploiting the convergence of the geometric series.

Interchanging the order of summation in \mathcal{A} , and exploiting again the convergence of the geometric series, we find

$$\begin{aligned} \mathcal{A} &= \sum_{k=0}^J \sum_{i=0}^k 2^{-k} \delta^{-i} \eta_2(N_1^i \eta_0) = \sum_{i=0}^J \sum_{k=i}^J 2^{-k} \delta^{-i} \eta_2(N_1^i \eta_0) \\ &= \sum_{i=0}^J \delta^{-i} \eta_2(N_1^i \eta_0) \sum_{k=i}^J 2^{-k} \\ &= \sum_{i=0}^J \delta^{-i} \eta_2(N_1^i \eta_0) 2 \left[2^{-i} - 2^{-(J+1)} \right] \end{aligned}$$

$$\leq 2 \sum_{i=0}^J (2\delta)^{-i} \eta_2 (N_1^i \eta_0).$$

Passing to the limit $J \rightarrow \infty$ and bearing in mind the definition of δ , provides

$$\sum_{k=0}^{\infty} N_1^{qk} \eta_1 (N_1^k \eta_0) \leq 2\eta_1(\eta_0) + 2 \sum_{k=0}^{\infty} N_1^{qk} \eta_2 (N_1^k \eta_0). \quad (7.1.31)$$

Inserting (7.1.31) into (7.1.29) yields

$$\int_{Q_{\varepsilon_0}} |\nabla p + \hat{z}|^{2q} dx \leq |Q_{\varepsilon_0}| + 2(N_1 \eta_0)^q \eta_1(\eta_0) + 2(N_1 \eta_0)^q \sum_{k=0}^{\infty} N_1^{qk} \eta_2 (N_1^k \eta_0). \quad (7.1.32)$$

Let us now estimate the last sum on the right hand side of the preceding inequality.

With the intention to use the L^q estimate (A.11.5) of the maximal function operator, we calculate decomposing the interval $[0, \infty)$ again into intervals $[0, \eta_0]$ and $[N_1^k \eta_0, N_1^{k+1} \eta_0]$ for $k = 0, 1, 2, \dots$, making use of (7.1.23), and taking advantage of the monotonicity of η_2

$$\begin{aligned} \int_{Q_{\varepsilon_0}} \left| M_{Q_{4\varepsilon_0}} \left(\left| \frac{\partial}{\partial t} \mathfrak{W}[\lambda, p] \right| \right) \right|^q dx &= q \int_0^{\infty} \lambda^{q-1} \eta_2(\lambda) d\lambda \\ &= q \int_0^{\eta_0} \lambda^{q-1} \eta_2(\lambda) d\lambda + q \sum_{k=0}^{\infty} \int_{N_1^k \eta_0}^{N_1^{k+1} \eta_0} \lambda^{q-1} \eta_2(\lambda) d\lambda \\ &\geq q \int_0^{\eta_0} \eta_2(\eta_0) \lambda^{q-1} d\lambda + q \sum_{k=0}^{\infty} \int_{N_1^k \eta_0}^{N_1^{k+1} \eta_0} \eta_2(N_1^{k+1} \eta_0) \lambda^{q-1} d\lambda \\ &\geq \eta_2(\eta_0) \eta_0^q + q \sum_{k=0}^{\infty} \eta_2(N_1^{k+1} \eta_0) \int_{N_1^k \eta_0}^{N_1^{k+1} \eta_0} \lambda^{q-1} d\lambda \\ &= \eta_2(N_1^0 \eta_0) (N_1^0 \eta_0)^q + \sum_{k=0}^{\infty} \eta_2(N_1^{k+1} \eta_0) \left[(N_1^{k+1} \eta_0)^q - (N_1^k \eta_0)^q \right] \\ &= \eta_2(N_1^0 \eta_0) (N_1^0 \eta_0)^q + \sum_{k=0}^{\infty} (N_1^{k+1} \eta_0)^q \eta_2(N_1^{k+1} \eta_0) \left[1 - \frac{1}{N_1^q} \right] \\ &\geq \eta_2(N_1^0 \eta_0) (N_1^0 \eta_0)^q \left[1 - \frac{1}{N_1^q} \right] + \sum_{k=1}^{\infty} (N_1^k \eta_0)^q \eta_2(N_1^k \eta_0) \left[1 - \frac{1}{N_1^q} \right] \\ &= \sum_{k=0}^{\infty} (N_1^k \eta_0)^q \eta_2(N_1^k \eta_0) \frac{N_1^q - 1}{N_1^q}, \\ &\geq \sum_{k=0}^{\infty} N_1^{qk} \eta_2(N_1^k \eta_0) \frac{N_1^q - 1}{N_1^q}, \end{aligned}$$

where the last step follows since $\eta_0 \geq 1$ by construction, and the term $\frac{N_1^q - 1}{N_1^q}$ is nonnegative by virtue of $N_1 > 1$.

This inequality together with (A.11.5) provides the following estimate

$$2(N_1 \eta_0)^q \sum_{k=0}^{\infty} N_1^{qk} \eta_2(N_1^k \eta_0) \leq 2(N_1 \eta_0)^q \frac{N_1^q - 1}{N_1^q - 1} \int_{Q_{\varepsilon_0}} \left| M_{Q_{4\varepsilon_0}} \left(\left| \frac{\partial}{\partial t} \mathfrak{W}[\lambda, p] \right| \right) \right|^q dx dt$$

$$\leq 2 \frac{N_1^{2q} \eta_0^q c(q)}{(q-1) [N_1^q - 1]} \int_{Q_{\varrho_0}} \left| \frac{\partial}{\partial t} \mathfrak{W}[\lambda, p] \right|^q dx dt,$$

where $c(q) = c(3, q)$ is as in Lemma A.11.5. With

$$\eta_1(\eta_0) \leq \left| \left\{ (x, t) \in Q_{\varrho_0} : M_{Q_{4\varrho_0}} (|\nabla p + \hat{z}|^2) > 0 \right\} \right| \leq |Q_{\varrho_0}|$$

inequality (7.1.32) turns into

$$\int_{Q_{\varrho_0}} |\nabla p + \hat{z}|^{2q} dx dt \leq [1 + 2(N_1 \eta_0)^q] |Q_{\varrho_0}| + 2 \frac{N_1^{2q} \eta_0^q c(q)}{(q-1) [N_1^q - 1]} \int_{Q_{\varrho_0}} \left| \frac{\partial}{\partial t} \mathfrak{W}[\lambda, p] \right|^q dx dt.$$

Then the hypotheses on ∇p , and $\frac{\partial}{\partial t} \mathfrak{W}[\lambda, p]$ yield that there exists a constant \check{c} , independent of ϱ_0 , such that

$$\int_{Q_{\varrho_0}} |\nabla p + \hat{z}|^{2q} dx dt \leq \check{c} < \infty \quad (7.1.33)$$

holds. Finally, let Q' be a compact subset of Q . As Q is bounded in \mathbb{R}^4 , we can cover Q' by a finite number of rectangles Q_{ϱ_0} , such that $Q_{4\varrho_0} \subset Q$, and ϱ_0 satisfies (7.1.11). Then from (7.1.33) we obtain

$$\|\nabla p + \hat{z}\|_{L^{2q}(Q')} < \infty.$$

Hence, we have completed the proof. \square

7.2 Local Boundedness of \dot{p} in the Interior

In this section we will prove the local interior boundedness for the time derivative \dot{p} of solutions p to Problem 3.1.1. Our main tool for the proof is the Moser iteration technique, which was already successfully applied in [18] to prove global boundedness of the time derivative of solutions to certain parabolic PDE's involving hysteresis, although the authors of [18] did not encounter problems due to the dependence of the leading elliptic coefficient on the hysteresis operator, and also to the lack of convexity of hysteresis loops. We show, how the Moser iteration technique still can be applied in our case. Our approach follows the arguments which can be found for instance in [43, Chapter 3, §8].

Proposition 7.2.1. *Suppose that the leading elliptic coefficient \mathbf{k} , the initial configuration λ , and the Preisach operator \mathfrak{W} involved in (3.1.2) satisfy Assumptions 3.2.3, and 3.2.4. Assume that there exists a solution $p \in H^1(Q)$ of Problem 3.1.1 such that $p \in C^{\alpha, \frac{\alpha}{4}}(\bar{Q})$, $\|p\|_{L^\infty(Q)} \leq \bar{R}$, with \bar{R} as in Assumption 3.2.3, and*

$$\nabla p \in L_{loc}^{\frac{20}{3}}(Q), \quad \dot{p} \in L^{\frac{10}{3}}(Q) \quad (7.2.1)$$

hold. Then $\dot{p} \in L_{loc}^\infty(Q)$.

Proof: We start the proof recalling basic facts about Steklov-approximates. For $h > 0$, and a function $v \in L^2((-h, T) \times \Omega)$ satisfying $v = 0$ for a.a. $t \geq T - h$ and for a.a. $t \leq 0$, we define

$$[v]_{\bar{h}}(x, t) := \frac{1}{h} \int_{t-h}^t v(x, s) ds \quad \text{for a.a. } (x, t) \in \Omega \times (0, T).$$

Moreover, for a function $u \in L^2((0, T) \times \Omega)$ and $h > 0$, we define its Steklov-approximate u_h by

$$u_h(x, t) := \frac{1}{h} \int_t^{t+h} u(x, s) ds \quad \text{a.e. in } (0, T-h) \times \Omega$$

and recall the easy identity

$$\begin{aligned} - \int_0^T \int_{\Omega} u [v]_{\bar{h}} dx dt &= - \int_0^T \int_{\Omega} u(t) \frac{v(t) - v(t-h)}{h} dx dt \\ &= \int_0^{T-h} \int_{\Omega} \frac{u(t+h) - u(t)}{h} v(t) dx dt = \int_0^{T-h} \dot{u}_h v dx dt. \end{aligned} \quad (7.2.2)$$

Let now $x_0 \in \Omega$, $\varrho > 0$, and $t_0 \in (0, T)$ be chosen such that $B_{\varrho}(x_0) \subset \Omega$ and $0 < t_0 - \varrho^2$, where $B_{\varrho}(x_0)$ denotes the ball of radius ϱ centered at x_0 . We now introduce the sequences $\{\varrho_n\}_{n \in \{0,1,2,\dots\}} \subset \mathbb{R}$, $\{B_n\}_{n \in \{0,1,2,\dots\}} \subset \mathbb{R}^3$, and $\{Q_n\}_{n \in \{0,1,2,\dots\}} \subset \mathbb{R}^4$ as follows

$$\varrho_n := \frac{\varrho}{2} + \frac{\varrho}{2^{n+1}}, \quad B_n := B_{\varrho_n}(x_0), \quad Q_n := B_n \times (t_0 - \varrho_n^2, t_0), \quad n = 0, 1, 2, \dots$$

Corresponding to the sequence $\{Q_n\}_{n \in \{0,1,2,\dots\}}$, let $\{\zeta_n\}_{n \in \{1,2,\dots\}} \subset C_0^1(\mathbb{R}^4)$ be a sequence of cut-off functions satisfying

$$0 \leq \zeta_n \leq 1 \text{ a.e. in } Q_n, \quad \text{and} \quad \zeta_n(x, t) = \begin{cases} 1, & \text{for a.a. } (x, t) \in Q_{n+1}, \\ 0, & \text{for a.a. } (x, t) \in ((\mathbb{R}^3 \setminus B_n) \times \mathbb{R}) \cup ([0, t_0 - \varrho_n^2] \times \mathbb{R}^3), \end{cases}$$

$$\text{and } |\nabla \zeta_n| \leq \frac{2^{n+3}}{\varrho}, \quad \left| \dot{\zeta}_n \right| \leq \frac{2^{n+3}}{\varrho^2}.$$

With the intention to pass to the limit as $h \rightarrow 0$ we suppose that $h < \left(\frac{\varrho}{2}\right)^2$ holds, and take p to be a solution of Problem 3.1.1 satisfying the hypotheses of our Proposition. For $q \geq 0$ and $n, k \in \{1, 2, \dots\}$, we consider the functions $\eta_{n,k} \in L^2(0, T-h; H^1(\Omega))$ defined as follows

$$\eta_{n,k}(x, t) := \dot{p}_h(x, t) |\dot{p}_h(x, t)|^{2q} \zeta_n(x, t)^2 \chi_k(t), \quad \text{a.e. in } (0, T-h) \times \Omega,$$

where the functions $\chi_k(t) \in L^\infty(\mathbb{R})$ are defined for all $k \geq 1$ by

$$\chi_k(t) = \begin{cases} 0, & \text{if } t \leq 0, \\ kt, & \text{if } 0 \leq t \leq \frac{1}{k}, \\ 1, & \text{if } \frac{1}{k} \leq t \leq t_1 - \frac{1}{k}, \\ k(t_1 - t), & \text{if } t_1 - \frac{1}{k} \leq t \leq t_1, \\ 0, & \text{if } t \geq t_1, \end{cases}$$

for some $t_1 \in (t_0 - \varrho_{n+1}^2, t_0 - h]$. Thus in particular, $\eta_{n,k} = 0$ holds a.e. in Ω for $t = 0$ and for a.a. $t \in [t_1, T - h]$. Extending $\eta_{n,k}$ trivially to $(-h, T) \times \Omega$, we observe that for all $n, k \in \{1, 2, \dots\}$, the functions $\phi_{n,k} \in L^2(0, T; H^1(\Omega))$ defined by

$$\phi_{n,k}(x, t) := p(x, t) + [\dot{\eta}_{n,k}]_{\bar{h}}(x, t) \quad \text{a.e. in } (0, T) \times \Omega$$

satisfy $\gamma_0 \phi(x, t) := \gamma_0 p(x, t)$ for a.a. $(x, t) \in \partial\Omega \times (0, T)$, and thus $\phi_{n,k}$ are admissible test-functions for (3.1.2). Therefore we obtain from (3.1.2) choosing $\phi_{n,k}$ as above

$$\int_0^T \int_{\Omega} \dot{s} [\dot{\eta}_{n,k}]_{\bar{h}} + \mathbf{k}[s](\nabla p + \hat{z}) \nabla [\dot{\eta}_{n,k}]_{\bar{h}} dx dt \leq 0.$$

Recalling the definition of χ_k , we find applying identity (7.2.2) to the first term of the left-hand side of the preceding inequality

$$\int_0^{t_1} \int_{\Omega} \frac{\partial}{\partial t} \dot{s}_h \eta_{n,k} + \frac{\partial}{\partial t} [\mathbf{k}[s](\nabla p + \hat{z})]_h \nabla \eta_{n,k} dx dt \leq 0, \quad (7.2.3)$$

which is equivalent to

$$\int_0^{t_1} \int_{\Omega} \frac{\partial}{\partial t} \dot{s}_h [\dot{p}_h |\dot{p}_h|^{2q} \zeta_n^2] \chi_k(t) + \frac{\partial}{\partial t} [\mathbf{k}[s](\nabla p + \hat{z})]_h \nabla \left([\dot{p}_h |\dot{p}_h|^{2q} \zeta_n^2] \chi_k(t) \right) dx dt \leq 0. \quad (7.2.4)$$

As $\chi_k \rightarrow \chi_{[0, t_1]}$ weakly* in $L^\infty(0, T - h)$, where $\chi_{[0, t_1]}$ denotes the characteristic function of the interval $[0, t_1]$, we can pass to the limit as $k \rightarrow \infty$ and obtain

$$\int_0^{t_1} \int_{\Omega} \frac{\partial}{\partial t} \dot{s}_h [\dot{p}_h |\dot{p}_h|^{2q} \zeta_n^2] + \frac{\partial}{\partial t} [\mathbf{k}[s](\nabla p + \hat{z})]_h \nabla [\dot{p}_h |\dot{p}_h|^{2q} \zeta_n^2] dx dt \leq 0. \quad (7.2.5)$$

We estimate the terms in (7.2.5) separately.

- ① Bearing in mind that $\zeta_n(\cdot, 0) = 0$ a.e. in Ω , and that $t_1 \in (t_0 - \varrho_{n+1}^2, t_0 - h]$, we calculate for the first term of the left-hand side of (7.2.5)

$$\begin{aligned} \int_0^{t_1} \int_{\Omega} a_0 \frac{\partial}{\partial t} \dot{p}_h \dot{p}_h |\dot{p}_h|^{2q} \zeta_n^2 dx dt &= \frac{a_0}{2q+2} \int_0^{t_1} \int_{\Omega} \frac{\partial}{\partial t} |\dot{p}_h|^{2q+2} \zeta_n^2 dx dt \\ &\geq \frac{a_0}{2q+2} \left\| |\dot{p}_h(t_1)|^{q+1} \zeta_n(\cdot, t_1) \right\|_{L^2(\Omega)}^2 \\ &\quad - \frac{a_0}{q+1} \int_0^{t_0-h} \int_{\Omega} |\dot{p}_h|^{2q+2} \zeta_n \left| \dot{\zeta}_n \right| dx dt. \end{aligned}$$

Thus, recalling the construction of ζ_n we find the following lower bound

$$\begin{aligned} \int_0^{t_1} \int_{\Omega} a_0 \frac{\partial}{\partial t} \dot{p}_h \dot{p}_h |\dot{p}_h|^{2q} \zeta_n^2 dx dt \\ \geq \frac{a_0}{2q+2} \left\| |\dot{p}_h(t_1)|^{q+1} \right\|_{L^2(B_{n+1})}^2 - \frac{a_0}{q+1} \frac{2^{n+3}}{\varrho^2} \int_{t_0-\varrho_n^2}^{t_0-h} \int_{B_n} |\dot{p}_h|^{2q+2} dx dt. \end{aligned} \quad (7.2.6)$$

- ② Let us proceed with the term of the left-hand side of (7.2.5) containing the time derivative of the Preisach operator. The estimation procedure is based on the Hilpert type inequality for the Preisach operators stated in Proposition 2.3.13.

For any $r > 0$ we set

$$\xi^r(x, t) = \wp_r[\lambda(x), p(x, \cdot)](t)$$

for a.a. $t \in [0, T]$, a.e. in Ω , and consider two inputs $u(x, t)$ and $v(x, t)$ defined by

$$u(x, t) = p(x, t + h), \quad v(x, t) = p(x, t), \quad \text{for a.a. } t \in [0, t_0 - h], \quad \text{a.e. in } \Omega.$$

Moreover, let $\tilde{\lambda} : \Omega \rightarrow \Lambda_{\bar{R}}$ satisfy for all $r > 0$

$$u(x, 0) - \xi^r(x, h) = \min \left\{ r; \max \left\{ -r, u(x, 0) - \tilde{\lambda}(x, r) \right\} \right\} \quad \text{for a.a. } x \in \Omega.$$

Putting for $r > 0$

$$\eta_r(x, t) := \wp_r[\tilde{\lambda}(x), u(x, \cdot)](t), \quad \text{and} \quad \nu_r(x, t) := \wp_r[\lambda(x), v(x, \cdot)](t)$$

for a.a. $t \in [0, t_0 - h]$, a.e. in Ω , we observe that

$$\eta_r(x, t) = \xi^r(x, t + h) \quad \text{and} \quad \nu_r(x, t) = \xi^r(x, t)$$

holds for a.a. $t \in [0, t_0 - h]$, a.e. in Ω , and consequently Proposition 2.3.13 yields the following estimate

$$\begin{aligned} & [\dot{g}(r, \xi^r(x, t + h)) - \dot{g}(r, \xi^r(x, t))] (p(x, t + h) - p(x, t)) |p(x, t + h) - p(x, t)|^{2q} \\ &= [\dot{g}(r, \eta_r(x, t)) - \dot{g}(r, \nu_r(x, t))] (u(x, t) - v(x, t)) |u(x, t) - v(x, t)|^{2q} \\ &\geq [\dot{g}(r, \eta_r(x, t)) - \dot{g}(r, \nu_r(x, t))] (\eta_r(x, t) - \nu_r(x, t)) |\eta_r(x, t) - \nu_r(x, t)|^{2q} \\ &= [\dot{g}(r, \xi^r(x, t + h)) - \dot{g}(r, \xi^r(x, t))] (\xi^r(x, t + h) - \xi^r(x, t)) |\xi^r(x, t + h) - \xi^r(x, t)|^{2q} \end{aligned}$$

for a.a. $t \in [0, t_0 - h]$, a.e. in Ω . For simplicity, let us omit the dependence on the spatial variable in the notation and rewrite the preceding inequality as

$$\begin{aligned} & [\dot{g}(r, \xi^r(t + h)) - \dot{g}(r, \xi^r(t))] (p(t + h) - p(t)) |p(t + h) - p(t)|^{2q} \\ &\geq [\dot{g}(r, \xi^r(t + h)) - \dot{g}(r, \xi^r(t))] (\xi^r(t + h) - \xi^r(t)) |\xi^r(t + h) - \xi^r(t)|^{2q}. \end{aligned}$$

Moreover, recalling the definition of the function g , an easy computation yields

$$\begin{aligned} & \frac{1}{h^{2q+1}} [\dot{g}(r, \xi^r(t + h)) - \dot{g}(r, \xi^r(t))] (\xi^r(t + h) - \xi^r(t)) |\xi^r(t + h) - \xi^r(t)|^{2q} \\ &= \psi(r, \xi^r(t + h)) \dot{\xi}^r(t + h) \dot{\xi}_h^r(t) \left| \dot{\xi}_h^r(t) \right|^{2q} - \psi(r, \xi^r(t)) \dot{\xi}^r(t) \dot{\xi}_h^r(t) \left| \dot{\xi}_h^r(t) \right|^{2q}. \end{aligned}$$

Let us estimate the right-hand side of this identity. First we calculate

$$\begin{aligned} & \psi(r, \xi^r(t + h)) \dot{\xi}(r, t + h) \dot{\xi}_h^r(t) \left| \dot{\xi}_h^r(t) \right|^{2q} - \psi(r, \xi^r(t)) \dot{\xi}(r, t) \dot{\xi}_h^r(t) \left| \dot{\xi}_h^r(t) \right|^{2q} \\ &= h\psi(r, \xi^r(t + h)) \frac{\partial}{\partial t} \dot{\xi}_h^r(t) \dot{\xi}_h^r(t) \left| \dot{\xi}_h^r(t) \right|^{2q} \end{aligned}$$

$$\begin{aligned}
&= \frac{h}{2q+2} \psi(r, \xi^r(t+h)) \frac{\partial}{\partial t} \left| \dot{\xi}_h^r(t) \right|^{2q+2} \\
&= \frac{h}{2q+2} \psi(r, \xi^r(t+h)) \frac{\partial}{\partial t} \left| \dot{\xi}_h^r(t) \right|^{2q+2} + \frac{h}{2q+2} \frac{\partial}{\partial t} \psi(r, \xi^r(t+h)) \left| \dot{\xi}_h^r(t) \right|^{2q+2} \\
&\quad - \frac{h}{2q+2} \frac{\partial}{\partial t} \psi(r, \xi^r(t+h)) \left| \dot{\xi}_h^r(t) \right|^{2q+2} \\
&= \frac{h}{2q+2} \frac{\partial}{\partial t} \left(\psi(r, \xi^r(t+h)) \left| \dot{\xi}_h^r(t) \right|^{2q+2} \right) \\
&\quad - \frac{h}{2q+2} \partial_z \psi(r, \xi^r(t+h)) \dot{\xi}^r(t+h) \left| \dot{\xi}_h^r(t) \right|^{2q+2},
\end{aligned}$$

as well as

$$\begin{aligned}
&-\psi(r, \xi^r(t)) \dot{\xi}(r, t) \dot{\xi}_h^r(t) \left| \dot{\xi}_h^r(t) \right|^{2q} + \psi(r, \xi^r(t+h)) \dot{\xi}(r, t) \dot{\xi}_h^r(t) \left| \dot{\xi}_h^r(t) \right|^{2q} \\
&= h \frac{\psi(r, \xi^r(t+h)) - \psi(r, \xi^r(t))}{\xi^r(t+h) - \xi^r(t)} \dot{\xi}(r, t) \left| \dot{\xi}_h^r(t) \right|^{2q+2}.
\end{aligned}$$

Since by assumption $\|p\|_{L^\infty(Q)} \leq \bar{R}$ and $\lambda : \Omega \rightarrow \Lambda_{\bar{R}}$ we find by virtue of Proposition 2.2.7 that $\xi^r(x, t) = 0$ for $r \geq \bar{R}$, a.e in Q , and therefore the pointwise estimate

$$|\xi^r(x, t)| \leq |p(x, t)| + r$$

implies

$$\begin{aligned}
&\int_0^{t_1} \int_\Omega \frac{\partial}{\partial t} \dot{w}_h \dot{p}_h |\dot{p}_h|^{2q} \zeta_n^2 dx dt \\
&\geq \frac{1}{2q+2} \int_0^{t_1} \int_\Omega \int_0^{\bar{R}} \frac{\partial}{\partial t} \left(\psi(r, \xi^r(t+h)) \left| \dot{\xi}_h^r(t) \right|^{2q+2} \right) \zeta_n^2 dr dx dt \\
&\quad - \sup_{\substack{r \leq \bar{R}, \\ z \leq 2\bar{R}}} \partial_z \psi(r, z) \int_0^{t_1} \int_\Omega \int_0^{\bar{R}} \left(\frac{1}{2q+2} \left| \dot{\xi}(r, t+h) \right| + \left| \dot{\xi}(r, t) \right| \right) \left| \dot{\xi}_h^r(t) \right|^{2q+2} \zeta_n^2 dr dx dt,
\end{aligned}$$

and consequently

$$\begin{aligned}
&\int_0^{t_1} \int_\Omega \frac{\partial}{\partial t} \dot{w}_h \dot{p}_h |\dot{p}_h|^{2q} dx dt \\
&\geq \frac{1}{2q+2} \int_\Omega \int_0^{\bar{R}} \psi(r, \xi^r(t_1+h)) \left| \dot{\xi}_h^r(t_1) \right|^{2q+2} \zeta_n(t_1)^2 - \psi(r, \xi^r(h)) \left| \dot{\xi}_h^r(0) \right|^{2q+2} \zeta_n(0)^2 dr dx dt \\
&\quad - \frac{1}{q+1} \int_0^{t_1} \int_\Omega \int_0^{\bar{R}} \psi(r, \xi^r(t+h)) \left| \dot{\xi}_h^r(t) \right|^{2q+2} \zeta_n \dot{\zeta}_n dr dx dt \\
&\quad - \sup_{\substack{r \leq \bar{R}, \\ z \leq 2\bar{R}}} \partial_z \psi(r, z) \int_0^{t_1} \int_\Omega \int_0^{\bar{R}} \left(\frac{1}{2q+2} \left| \dot{\xi}(r, t+h) \right| + \left| \dot{\xi}(r, t) \right| \right) \left| \dot{\xi}_h^r(t) \right|^{2q+2} \zeta_n^2 dr dx dt
\end{aligned}$$

holds. Thinking of the properties of ζ_n and of the positivity of ψ , we arrive at the following inequality

$$\int_0^{t_1} \int_\Omega \frac{\partial}{\partial t} \dot{w}_h \dot{p}_h |\dot{p}_h|^{2q} \zeta_n dx dt$$

$$\begin{aligned}
&\geq - \sup_{\substack{r \leq \bar{R}, \\ z \leq 2\bar{R}}} \partial_z \psi(r, z) \int_{t_0 - \varrho_n}^{t_0 - h} \int_{B_n} \int_0^{\bar{R}} \left(\frac{1}{2q+2} \left| \dot{\xi}(r, t+h) \right| + \left| \dot{\xi}(r, t) \right| \right) \left| \dot{\xi}_h^r(t) \right|^{2q+2} dr dx dt \\
&\quad - \frac{1}{q+1} \frac{2^{n+3}}{\varrho^2} \int_{t_0 - \varrho_n}^{t_0 - h} \int_{B_n} \int_0^{\bar{R}} \psi(r, \xi^r(t+h)) \left| \dot{\xi}_h^r(t) \right|^{2q+2} dr dx dt. \quad (7.2.7)
\end{aligned}$$

Since by assumption p belongs to $C^{\alpha, \frac{\alpha}{4}}(\bar{Q})$ the time derivative $\frac{\partial}{\partial t} \xi^r$ exists for a.a. $t \in (0, T)$ a.e. in Ω and, according to Proposition 2.2.6, satisfies the following pointwise estimate

$$\left| \dot{\xi}^r \right| \leq |\dot{p}| \quad \text{a.e. in } \Omega \times (0, T). \quad (7.2.8)$$

Hence, applying Fubini's Theorem, Hölder's, and Cauchy's inequalities we find

$$\begin{aligned}
&\int_{t_0 - \varrho_n^2}^{t_0 - h} \int_{B_n} \int_0^{\bar{R}} \left(\frac{1}{2q+2} \left| \dot{\xi}(r, t+h) \right| + \left| \dot{\xi}(r, t) \right| \right) \left| \dot{\xi}_h^r(t) \right|^{2q+2} dr dx dt \\
&\leq \int_0^{\bar{R}} \int_{t_0 - \varrho_n^2}^{t_0 - h} \int_{B_n} \left(\frac{1}{2q+2} |\dot{p}(t+h)| + |\dot{p}(t)| \right) \left| \dot{\xi}_h^r(t) \right|^{2q+2} dx dt dr \\
&\leq \frac{2q+3}{2q+2} \|\dot{p}\|_{L^{\frac{10}{3}}(Q)} \int_0^{\bar{R}} \left\| \left| \dot{\xi}_h^r(t) \right|^{2q+2} \right\|_{L^{\frac{10}{7}}((t_0 - \varrho_n^2, t_0 - h) \times B_n)} dr \\
&= \frac{2q+3}{2q+2} \|\dot{p}\|_{L^{\frac{10}{3}}(Q)} \int_0^{\bar{R}} \left\| \dot{\xi}_h^r(t) \right\|_{L^{\frac{20(q+1)}{7}}((t_0 - \varrho_n^2, t_0 - h) \times B_n)}^{2q+2} dr. \quad (7.2.9)
\end{aligned}$$

Moreover, by virtue of Assumptions 2.3.6 and 2.3.10 $0 \leq \psi(r, v) \leq \beta(r)$ holds, and we obtain again by virtue of Hölder's inequality and Fubini's theorem

$$\begin{aligned}
&\int_{t_0 - \varrho_n^2}^{t_0 - h} \int_{B_n} \int_0^{\bar{R}} \psi(r, \xi^r(t+h)) \left| \dot{\xi}_h^r(t) \right|^{2q+2} dr dx dt \\
&= \int_0^{\bar{R}} \beta(r) \int_{t_0 - \varrho_n^2}^{t_0 - h} \int_{B_n} \left| \dot{\xi}_h^r(t) \right|^{2q+2} dx dt dr \\
&\leq |\Omega|^{\frac{3}{10}} \int_0^{\bar{R}} \beta(r) \left\| \dot{\xi}_h^r \right\|_{L^{\frac{20(q+1)}{7}}((t_0 - \varrho_n^2, t_0 - h) \times \Omega)}^{2q+2} dr. \quad (7.2.10)
\end{aligned}$$

Inserting (7.2.9) and (7.2.10) into (7.2.7) finally yields

$$\begin{aligned}
&\int_0^{t_1} \int_{\Omega} \frac{\partial}{\partial t} \dot{w}_h \dot{p}_h |\dot{p}_h|^{2q} dx dt \\
&\geq - \frac{2q+3}{2q+2} \|\dot{p}\|_{L^{\frac{10}{3}}(Q)} \int_0^{\bar{R}} \left\| \dot{\xi}_h^r \right\|_{L^{\frac{20(q+1)}{7}}((t_0 - \varrho_n^2, t_0 - h) \times B_n)}^{2q+2} dr \\
&\quad - |\Omega|^{\frac{3}{10}} \int_0^{\bar{R}} \beta(r) \left\| \dot{\xi}_h^r \right\|_{L^{\frac{20(q+1)}{7}}((t_0 - \varrho_n^2, t_0 - h) \times \Omega)}^{2q+2} dr. \quad (7.2.11)
\end{aligned}$$

Now we estimate the elliptic term of (7.2.5). Direct computation yields for a.a. $(x, t) \in \Omega \times (0, t_0 - h)$

$$\frac{\partial}{\partial t} [\mathbf{k}[s](x, t) \nabla(p(x, t) + z)]_h = \mathbf{k}[s](x, t+h) \nabla \dot{p}_h(x, t) + \dot{\mathbf{k}}[s](x, t) \nabla(p(x, t) + z)$$

as well as

$$\nabla \left[\dot{p}_h |\dot{p}_h|^{2q} \zeta_n^2 \right] = (2q+1) \nabla \dot{p}_h |\dot{p}_h|^{2q} \zeta_n^2 + 2 \dot{p}_h |\dot{p}_h|^{2q} \zeta_n \nabla \zeta_n$$

③ As by assumption $\mathbf{k}[s] \geq \underline{k} > 0$ holds a.e. in Q , we find the following estimate

$$(2q+1) \int_0^{t_1} \int_{\Omega} \mathbf{k}[s](x, t+h) \nabla \dot{p}_h \cdot \nabla \dot{p}_h |\dot{p}_h|^{2q} \zeta_n^2 dx dt \geq (2q+1) \underline{k} \int_0^{t_1} \int_{\Omega} |\nabla \dot{p}_h|^2 |\dot{p}_h|^{2q} \zeta_n^2 dx dt. \quad (7.2.12)$$

④ Then, again, bearing in mind $\mathbf{k}[s] \geq \underline{k} > 0$, applying Young's inequality, and recalling the properties of ζ_n , we deduce that

$$\begin{aligned} & 2 \int_0^{t_1} \int_{\Omega} \mathbf{k}[s](x, t+h) \nabla \dot{p}_h \cdot \dot{p}_h |\dot{p}_h|^{2q} \zeta_n \nabla \zeta_n dx dt \\ & \leq \frac{(2q+1)\underline{k}}{4} \int_0^{t_1} \int_{\Omega} |\nabla \dot{p}_h|^2 |\dot{p}_h|^{2q} \zeta_n^2 dx dt + \frac{4}{(2q+1)\underline{k}} \int_0^{t_1} \int_{\Omega} |\dot{p}_h|^{2q+2} |\nabla \zeta_n|^2 dx dt \\ & \leq \frac{(2q+1)\underline{k}}{4} \int_0^{t_1} \int_{\Omega} |\nabla \dot{p}_h|^2 |\dot{p}_h|^{2q} \zeta_n^2 dx dt + \frac{4\bar{k}^2}{(2q+1)\underline{k}} \frac{2^{2(n+3)}}{\varrho^2} \int_{t_0-\varrho_n^2}^{t_0-h} \int_{\Omega} |\dot{p}_h|^{2q+2} dx dt \end{aligned} \quad (7.2.13)$$

holds.

⑤ Moreover, again by virtue of Young's inequality

$$\begin{aligned} (2q+1) \int_0^{t_1} \int_{\Omega} \dot{\mathbf{k}}[s]_h (\nabla p + \hat{z}) \cdot \nabla \dot{p}_h |\dot{p}_h|^{2q} \zeta_n^2 dx dt \\ \leq (2q+1) \frac{\underline{k}}{2} \int_0^{t_1} \int_{\Omega} |\nabla \dot{p}_h|^2 |\dot{p}_h|^{2q} \zeta_n^2 dx dt \\ + \frac{2q+1}{2\underline{k}} \int_0^{t_1} \int_{\Omega} |\dot{\mathbf{k}}[s]_h|^2 |\nabla p + \hat{z}|^2 |\dot{p}_h|^{2q} \zeta_n^2 dx dt \end{aligned}$$

is satisfied. At this point we see why we cannot repeat the arguments of Section 6.1. To be able to do this, one would need, that our Preisach operator satisfies

$$|w(t+h) - w(t)| \leq L |p(t+h) - p(t)|, \quad \text{a.e. in } \Omega$$

for a.a. $t \in (0, T-h)$ with some constant $L > 0$, which must not hold. Thus, making use of our assumption that $(\nabla p + \hat{z})$, belongs to $L_{loc}^{\frac{20}{3}}(Q)$ we obtain by the Lipschitz continuity of k with Lipschitz constant L_k , the definition of ζ_n , and Hölder's inequality

$$\begin{aligned} & \int_0^{t_1} \int_{\Omega} |\dot{\mathbf{k}}[s]_h|^2 |\nabla p + \hat{z}|^2 |\dot{p}_h|^{2q} \zeta_n^2 dx dt \\ & \leq L_k^2 \int_{t_0-\varrho_n^2}^{t_0-h} \int_{B_n} |\dot{s}_h|^2 |\nabla p + \hat{z}|^2 |\dot{p}_h|^{2q} dx dt \\ & \leq L_k^2 \left\| |\nabla p + \hat{z}|^2 \right\|_{L^{\frac{10}{3}}(Q_n)} \left\| |\dot{s}_h|^2 |\dot{p}_h|^{2q} \right\|_{L^{\frac{10}{7}}((t_0-\varrho_n^2, t_0-h) \times B_n)}. \end{aligned}$$

As in particular $Q_n \subset Q_0$,

$$(2q+1) \int_0^{t_1} \int_{\Omega} \dot{\mathbf{k}}[s]_h (\nabla p + \hat{z}) \cdot \nabla \dot{p}_h |\dot{p}_h|^{2q} \zeta_n^2 dx dt$$

$$\begin{aligned} &\leq (2q+1) \frac{k}{2} \int_0^{t_1} \int_{\Omega} |\nabla \dot{p}_h|^2 |\dot{p}_h|^{2q} dx dt \\ &\quad + \frac{2q+1}{2k} L_k^2 \|\nabla p + \hat{z}\|_{L^{\frac{20}{3}}(Q_0)}^2 \left\| |\dot{s}_h|^2 |\dot{p}_h|^{2q} \right\|_{L^{\frac{10}{7}}((t_0-\varrho_n^2, t_0-h) \times B_n)} \end{aligned} \quad (7.2.14)$$

holds.

⑥ And finally, bearing in mind that $\nabla p + \hat{z} \in L_{loc}^{\frac{20}{3}}(Q)$, the Lipschitz continuity of \mathbf{k} , and a similar estimation procedure as above implies

$$\begin{aligned} &2 \int_0^{t_1} \int_{\Omega} \dot{\mathbf{k}}[s]_h (\nabla p + \hat{z}) \cdot \dot{p}_h |\dot{p}_h|^{2q} \zeta_n \nabla \zeta_n dx dt \\ &\leq 2L_k \frac{2^{(n+3)}}{\varrho} \int_{t_0-\varrho_n^2}^{t_0-h} \int_{B_n} |\dot{s}_h| |\nabla p + \hat{z}| |\dot{p}_h|^{2q+1} dx dt \\ &\leq L_k \frac{2^{(n+4)}}{\varrho} \|\nabla p + \hat{z}\|_{L^{\frac{10}{3}}(Q_0)} \left\| |\dot{s}_h| |\dot{p}_h|^{2q+1} \right\|_{L^{\frac{10}{7}}((t_0-\varrho_n^2, t_0-h) \times B_n)}. \end{aligned} \quad (7.2.15)$$

Introducing the constant

$$\hat{c}_0 := \|\dot{p}\|_{L^{\frac{10}{3}}(Q)} + |Q|^{\frac{3}{10}} + \frac{4\bar{k}^2 + 2a_0}{k} |Q|^{\frac{3}{10}} + L_k \|\nabla p + \hat{z}\|_{L^{\frac{10}{3}}(Q_0)} + \frac{L_k^2 \|\nabla p + \hat{z}\|_{L^{\frac{20}{3}}(Q_0)}^2}{2k}$$

and inserting estimates (7.2.6), (7.2.11), (7.2.12), (7.2.13), (7.2.14), and (7.2.15) into (7.2.5) it follows

$$\begin{aligned} &\frac{a_0}{2q+2} \left\| |\dot{p}_h(t_1)|^{q+1} \right\|_{L^2(B_{n+1})}^2 + \frac{(2q+1)k}{4} \int_0^{t_1} \int_{\Omega} |\nabla \dot{p}_h|^2 |\dot{p}_h|^{2q} \zeta_n^2 dx dt \\ &\leq (2q+2) \frac{2^{2(n+3)}}{\varrho^2} \hat{c}_0 \left[\left\| \dot{p}_h \right\|_{L^{\frac{10}{7}}((t_0-\varrho_n^2, t_0-h) \times B_n)}^{2q+2} + \int_0^{\bar{R}} \left\| \dot{\zeta}_h^r \right\|_{L^{\frac{20(q+1)}{7}}((t_0-\varrho_n^2, t_0-h) \times B_n)}^{2q+2} dr \right. \\ &\quad + \int_0^{\bar{R}} \beta(r) \left\| \dot{\zeta}_h^r \right\|_{L^{\frac{20(q+1)}{7}}((t_0-\varrho_n^2, t_0-h) \times B_n)}^{2q+2} dr \\ &\quad + \left\| |\dot{s}_h|^2 |\dot{p}_h|^{2q} \right\|_{L^{\frac{10}{7}}((t_0-\varrho_n^2, t_0-h) \times B_n)} \\ &\quad \left. + \left\| |\dot{s}_h| |\dot{p}_h|^{2q+1} \right\|_{L^{\frac{10}{7}}((t_0-\varrho_n^2, t_0-h) \times B_n)} \right]. \end{aligned} \quad (7.2.16)$$

Recalling the definition of ζ_n , we can estimate the left-hand side of (7.2.16) from below and obtain

$$\begin{aligned} &\frac{\min\{a_0; k\}}{4(q+1)} \left[\left\| |\dot{p}_h(t_1)|^{q+1} \right\|_{L^2(B_{n+1})}^2 + (q+1)^2 \int_{t_0-\varrho_{n+1}^2}^{t_1} \int_{B_{n+1}} |\nabla \dot{p}_h|^2 |\dot{p}_h|^{2q} dx dt \right] \\ &\leq \text{LHS of (7.2.16)}, \end{aligned}$$

and since $t_1 \in [t_0 - \varrho_{n+1}^2, t_0 - h]$ was chosen arbitrary, and the right-hand side of (7.2.16) is independent of t_1 ,

$$\begin{aligned} &\frac{\min\{a_0; k\}}{4(q+1)} \left[\sup_{t_0-\varrho_{n+1}^2 \leq t \leq t_0-h} \left\| |\dot{p}_h(t)|^{q+1} \right\|_{L^2(\Omega)}^2 + (q+1)^2 \int_{t_0-\varrho_{n+1}^2}^{t_0-h} \int_{\Omega} |\nabla \dot{p}_h|^2 |\dot{p}_h|^{2q} dx dt \right] \\ &\leq \text{RHS of (7.2.16)} \end{aligned}$$

follows. As the identity

$$\left[\nabla |\dot{p}_h|^{q+1} \right]^2 = (q+1)^2 |\nabla \dot{p}_h|^2 |\dot{p}_h|^{2q}$$

is satisfied a.e in Q , we obtain by interpolation (Proposition A.6.1)

$$\begin{aligned} & \left\| |\dot{p}_h|^{q+1} \right\|_{L^{\frac{10}{3}}((t_0 - \varrho_{n+1}^2, t_0 - h) \times B_{n+1})}^2 \\ & \leq \beta^2 \left[\sup_{t_0 - \varrho_{n+1}^2 \leq t \leq t_0 - h} \left\| |\dot{p}_h(t)|^{q+1} \right\|_{L^2(B_{n+1})}^2 + \int_{t_0 - \varrho_{n+1}^2}^{t_0 - h} \int_{B_{n+1}} |\nabla |\dot{p}_h|^{q+1}|^2 dx dt \right] \\ & \leq \beta^2 \left[\sup_{t_0 - \varrho_{n+1}^2 \leq t \leq t_0 - h} \left\| |\dot{p}_h(t)|^{q+1} \right\|_{L^2(B_{n+1})}^2 + (q+1)^2 \int_{t_0 - \varrho_{n+1}^2}^{t_0 - h} \int_{B_{n+1}} |\nabla \dot{p}_h|^2 |\dot{p}_h|^{2q} dx dt \right], \end{aligned}$$

with β as in Proposition A.6.1. As a consequence

$$\frac{\min\{a_0; \underline{k}\}}{4\beta^2(q+1)} \left\| |\dot{p}_h|^{q+1} \right\|_{L^{\frac{10}{3}}((t_0 - \varrho_{n+1}^2, t_0 - h) \times B_{n+1})}^2 \leq \text{RHS of (7.2.16)}$$

holds and setting

$$\gamma^2 := \frac{2\beta^2}{\min\{a_0; \underline{k}\}},$$

we find the following estimate

$$\left\| |\dot{p}_h|^{q+1} \right\|_{L^{\frac{10}{3}}((t_0 - \varrho_{n+1}^2, t_0 - h) \times B_{n+1})}^2 \leq 2(q+1)\gamma^2 * \text{RHS of (7.2.16)}. \quad (7.2.17)$$

Let us now show how (7.2.17) can be turned into an estimate of $\|\dot{p}\|_{L^\infty(Q_\infty)}$. Choosing the numbers q as

$$q = \left(\frac{7}{6}\right)^{n+1} - 1, \quad \text{for } n = 0, 1, \dots,$$

we claim that

$$\|\dot{p}\|_{L^{\frac{10}{3} * \left(\frac{7}{6}\right)^{n+1}}(Q_{n+1})} \leq \prod_{i=1}^{n+1} \left(\frac{7}{3}\right)^{i\left(\frac{6}{7}\right)^i} \vartheta^{\left(\frac{6}{7}\right)^i} \|\dot{p}\|_{L^{\frac{10}{3}}(Q_0)} \quad (7.2.18)$$

holds for all $n = 0, 1, \dots$ and where the constant ϑ is defined as

$$\vartheta := \gamma \frac{2^{\frac{7}{2}}}{\varrho} \hat{c}_0^{\frac{1}{2}} \left[1 + \bar{R} + \tilde{b}(\bar{R}) + (a_0 + \tilde{b}(\bar{R}))^2 + (a_0 + \tilde{b}(\bar{R})) \right]^{\frac{1}{2}}, \quad (7.2.19)$$

We prove the claim by induction: For $n = 0$, inequality (7.2.17) turns into

$$\begin{aligned} & \left\| \dot{p}_h \right\|_{L^{\frac{10}{3} * \frac{7}{6}}((t_0 - \varrho_1^2, t_0 - h) \times B_1)}^{\frac{7}{3}} \\ & \leq 2 \frac{7}{6} \gamma^2 * \frac{2^6}{\varrho^2} \hat{c}_0 \left[\left\| \dot{p}_h \right\|_{L^{\frac{10}{3}}((t_0 - \varrho_0^2, t_0 - h) \times B_0)}^{\frac{7}{3}} + \int_0^{\bar{R}} \left\| \dot{\xi}_h^r \right\|_{L^{\frac{10}{3}}((t_0 - \varrho_0^2, t_0 - h) \times B_0)}^{\frac{10}{3}} dr \right. \\ & \quad + \int_0^{\bar{R}} \beta(r) \left\| \dot{\xi}_h^r \right\|_{L^{\frac{10}{3}}((t_0 - \varrho_0^2, t_0 - h) \times B_0)}^{\frac{7}{3}} dr \\ & \quad + \left\| |\dot{s}_h|^2 |\dot{p}_h|^{\frac{1}{3}} \right\|_{L^{\frac{10}{7}}((t_0 - \varrho_0^2, t_0 - h) \times B_0)} \\ & \quad \left. + \left\| |\dot{s}_h| |\dot{p}|^{\frac{4}{3}} \right\|_{L^{\frac{10}{7}}((t_0 - \varrho_0^2, t_0 - h) \times B_0)} \right]. \quad (7.2.20) \end{aligned}$$

Recalling that by assumption $\dot{p} \in L^{\frac{10}{3}}(Q)$ holds, we obtain as a consequence of Propositions 2.2.5, and 2.3.11, that for all $r > 0$ also $\dot{\xi}^r \in L^{\frac{10}{3}}(Q)$ and $\dot{s} \in L^{\frac{10}{3}}(Q)$ and therefore, a classical estimate stated in Lemma A.5.6 together with Hölder's inequality yields

$$\|\dot{p}_h\|_{L^{\frac{10}{3}}((t_0-\varrho_0^2, t_0-h) \times B_0)} \leq \|\dot{p}\|_{L^{\frac{10}{3}}(Q_0)}.$$

Moreover, it follows by virtue of (7.2.8), and Lemma A.5.6

$$\left\| \dot{\xi}_h^r(t) \right\|_{L^{\frac{10}{3}}((t_0-\varrho_0^2, t_0-h) \times B_0)} \leq \left\| \dot{\xi}^r(t) \right\|_{L^{\frac{10}{3}}(Q_0)} \leq \|\dot{p}(t)\|_{L^{\frac{10}{3}}(Q_0)}.$$

Further, by virtue of Propositions 2.3.11 we have

$$|\dot{s}| \leq (a_0 + \tilde{b}(\bar{R})) |\dot{p}|, \quad \text{a.e. in } (0, T) \times \Omega$$

and consequently making use of Hölder's inequality and Lemma A.5.6 we find

$$\begin{aligned} & \left\| |\dot{s}_h|^2 |\dot{p}_h|^{\frac{1}{3}} \right\|_{L^{\frac{10}{7}}((t_0-\varrho_0^2, t_0-h) \times B_0)} \\ & \leq \left\| |\dot{s}_h|^2 \right\|_{L^{\frac{5}{3}}((t_0-\varrho_0^2, t_0-h) \times B_0)} \left\| |\dot{p}_h|^{\frac{1}{3}} \right\|_{L^{10}((t_0-\varrho_0^2, t_0-h) \times B_0)} \\ & = \|\dot{s}_h\|_{L^{\frac{10}{3}}((t_0-\varrho_0^2, t_0-h) \times B_0)}^2 \|\dot{p}_h\|_{L^{\frac{10}{3}}((t_0-\varrho_0^2, t_0-h) \times B_0)}^{\frac{1}{3}} \\ & \leq \|\dot{s}\|_{L^{\frac{10}{3}}(Q_0)}^2 \|\dot{p}\|_{L^{\frac{10}{3}}(Q_0)}^{\frac{1}{3}} \\ & \leq (a_0 + \tilde{b}(\bar{R}))^2 \|\dot{p}\|_{L^{\frac{10}{3}}(Q_0)}^{\frac{7}{3}}, \end{aligned}$$

as well as

$$\left\| |\dot{s}_h| |\dot{p}_h|^{\frac{4}{3}} \right\|_{L^{\frac{10}{7}}((t_0-\varrho_0^2, t_0-h) \times B_0)} \leq (a_0 + \tilde{b}(\bar{R})) \|\dot{p}\|_{L^{\frac{10}{3}}(Q_0)}^{\frac{7}{3}}.$$

Thus, we obtain from (7.2.20) the following estimate

$$\begin{aligned} & \|\dot{p}\|_{L^{\frac{10}{3} * \frac{7}{6}}((t_0-\varrho_1^2, t_0-h) \times B_1)}^{\frac{7}{3}} \\ & \leq \left(\frac{7}{3}\right)^2 \gamma^2 * \frac{2^7}{\varrho^2} \hat{c}_0 \|\dot{p}\|_{L^{\frac{10}{3}}(Q_0)}^{\frac{7}{3}} \left[1 + \bar{R} + \tilde{b}(\bar{R}) + (a_0 + \tilde{b}(\bar{R}))^2 + (a_0 + \tilde{b}(\bar{R})) \right] \\ & = \left(\frac{7}{3}\right)^2 \vartheta^2 \|\dot{p}\|_{L^{\frac{10}{3}}(Q_0)}^{\frac{7}{3}}, \end{aligned}$$

with the obvious labeling of ϑ^2 . Observing, that the right-hand side of this inequality is bounded independently of h , Lemma A.5.6 yields

$$\|\dot{p}\|_{L^{\frac{10}{3} * \frac{7}{6}}(Q_1)}^{\frac{7}{3}} \leq \left(\frac{7}{3}\right)^2 \vartheta^2 \|\dot{p}\|_{L^{\frac{10}{3}}(Q_0)}^{\frac{7}{3}}, \quad (7.2.21)$$

and consequently we obtain

$$\|\dot{p}\|_{L^{\frac{10}{3} * \frac{7}{6}}(Q_1)} \leq \left(\frac{7}{3}\right)^{\frac{6}{7}} \vartheta^{\frac{6}{7}} \|\dot{p}\|_{L^{\frac{10}{3}}(Q_0)}. \quad (7.2.22)$$

Let now $n \geq 1$ and suppose that (7.2.18) holds for all $i \in 0, \dots, n-1$. Then choosing the numbers q as

$$q = \left(\frac{7}{6}\right)^{i+1} - 1, \quad i = 0, 1, \dots, n-1$$

We obtain as in the case $n = 0$:

$$\begin{aligned} \textcircled{1} \quad & \left\| |\dot{p}_h|^{q+1} \right\|_{L^{\frac{20}{7}}(Q_n)}^2 \leq \|\dot{p}\|_{L^{\frac{20}{7}*(q+1)}(Q_n)}^{2q+2}, \\ \textcircled{2} \quad & \left\| \dot{\xi}_h^r(t) \right\|_{L^{\frac{20(q+1)}{7}}((t_0-\varrho_n^2, t_0-h) \times B_n)}^{2q+2} \leq \|\dot{p}(t)\|_{L^{\frac{20(q+1)}{7}}(Q_n)}^{2q+2}, \\ \textcircled{3} \quad & \left\| |\dot{s}_h|^2 |\dot{p}_h|^{2q} \right\|_{L^{\frac{10}{7}}((t_0-\varrho_n^2, t_0-h) \times B_n)} \leq (a_0 + \tilde{b}(\bar{R}))^2 \|\dot{p}\|_{L^{\frac{20}{7}*(q+1)}(Q_n)}^{2q+2}, \end{aligned}$$

and

$$\textcircled{4} \quad \left\| |\dot{s}_h| |\dot{p}_h|^{2q+1} \right\|_{L^{\frac{10}{7}}((t_0-\varrho_n^2, t_0-h) \times B_n)} \leq (a_0 + \tilde{b}(\bar{R})) \|\dot{p}\|_{L^{\frac{20}{7}*(q+1)}(Q_n)}^{2q+2}.$$

Inserting these estimates into (7.2.17), and setting

$$\vartheta^2 := \gamma^2 \frac{2^7}{\varrho^2} \hat{c}_0 \left[1 + \bar{R} + \tilde{b}(\bar{R}) + (a_0 + \tilde{b}(\bar{R}))^2 + (a_0 + \tilde{b}(\bar{R})) \right],$$

we obtain

$$\|\dot{p}_h\|_{L^{\frac{10}{3}*(\frac{7}{6})^{n+1}}((t_0-\varrho_{n+1}^2, t_0-h) \times B_{n+1})}^{2*(\frac{7}{6})^{n+1}} \leq \left(\frac{7}{3}\right)^{2(n+1)} \vartheta^2 \|\dot{p}\|_{L^{\frac{20}{7}*(\frac{7}{6})^{n+1}}(Q_n)}^{2*(\frac{7}{6})^{n+1}}. \quad (7.2.23)$$

And since

$$\frac{20}{7} \cdot \frac{7}{6} = \frac{10}{3}$$

the preceding inequality turns into

$$\|\dot{p}_h\|_{L^{\frac{10}{3}*(\frac{7}{6})^{n+1}}((t_0-\varrho_{n+1}^2, t_0-h) \times B_{n+1})}^{(\frac{7}{6})^{n+1}} \leq \left(\frac{7}{3}\right)^{n+1} \vartheta \|\dot{p}\|_{L^{\frac{10}{3}*(\frac{7}{6})^n}(Q_n)}^{(\frac{7}{6})^{n+1}}, \quad (7.2.24)$$

and consequently

$$\begin{aligned} \|\dot{p}_h\|_{L^{\frac{10}{3}*(\frac{7}{6})^{n+1}}((t_0-\varrho_{n+1}^2, t_0-h) \times B_{n+1})} & \leq \left(\frac{7}{3}\right)^{(n+1)(\frac{6}{7})^{n+1}} \vartheta^{(\frac{6}{7})^{n+1}} \|\dot{p}\|_{L^{\frac{10}{3}*(\frac{7}{6})^n}(Q_n)} \\ & \leq \prod_{i=1}^{n+1} \left(\frac{7}{3}\right)^{i(\frac{6}{7})^i} \vartheta^{(\frac{6}{7})^i} \|\dot{p}\|_{L^{\frac{10}{3}}(Q_0)} \end{aligned} \quad (7.2.25)$$

holds. Let us show that the right-hand side of this inequality is bounded independently of h . We have

$$\ln \left(\prod_{i=1}^{n+1} \left(\frac{7}{3}\right)^{i(\frac{6}{7})^i} \vartheta^{(\frac{6}{7})^i} \right) = \sum_{i=1}^{n+1} i \left(\frac{6}{7}\right)^i \ln \left(\frac{7}{3}\right) + \left(\frac{6}{7}\right)^i \ln(\vartheta)$$

Exploiting that for any $\alpha < 1$

$$\sum_{i=0}^n i\alpha^i = \frac{n\alpha^{n+2} - (n+1)\alpha^{n+1} + \alpha}{(\alpha-1)^2} \leq \frac{\alpha}{(\alpha-1)^2},$$

$$\sum_{i=0}^n \alpha^i = \frac{1-\alpha^{n+1}}{1-\alpha} \leq \frac{1}{1-\alpha},$$

are satisfied, we deduce that

$$\begin{aligned} \ln \left(\prod_{i=1}^{n+1} \left(\frac{7}{3} \right)^{i \left(\frac{6}{7} \right)^i} \vartheta^{\left(\frac{6}{7} \right)^i} \right) &\leq \ln \left(\frac{7}{3} \right) \frac{\frac{6}{7}}{\left(1 - \frac{6}{7}\right)^2} + \ln(\vartheta) \frac{1}{1 - \frac{6}{7}} \\ &= 42 \ln \left(\frac{7}{3} \right) + 7 \ln(\vartheta), \end{aligned}$$

holds, and therefore

$$\prod_{i=1}^{n+1} \left(\frac{7}{3} \right)^{i \left(\frac{6}{7} \right)^i} \vartheta^{\left(\frac{6}{7} \right)^i} \leq \left(\frac{7}{3} \right)^{42} \vartheta^7 \quad (7.2.26)$$

follows. Therefore we can pass to the limit as $h \rightarrow 0$ in (7.2.25) and obtain

$$\|\dot{p}\|_{L^{\frac{10}{3} * \left(\frac{7}{6} \right)^{n+1}}(Q_{n+1})} \leq \prod_{i=1}^{n+1} \left(\frac{7}{3} \right)^{i \left(\frac{6}{7} \right)^i} \vartheta^{\left(\frac{6}{7} \right)^i} \|\dot{p}\|_{L^{\frac{10}{3}}(Q_0)} \leq \left(\frac{7}{3} \right)^{42} \vartheta^7 \|\dot{p}\|_{L^{\frac{10}{3}}(Q_0)}.$$

Making use of the well known fact that

$$\|\dot{p}\|_{L^\infty(Q_\infty)} = \lim_{n \rightarrow \infty} \|\dot{p}\|_{L^{q_n}(Q_n)},$$

we finally find

$$\|\dot{p}\|_{L^\infty\left((t_0 - \frac{\varrho^2}{4}; t_0) \times B_{\frac{\varrho}{2}}(x_0)\right)} = \lim_{n \rightarrow \infty} \|\dot{p}\|_{L^{\frac{10}{3} * \left(\frac{7}{6} \right)^n}(Q_n)} \leq \left(\frac{7}{3} \right)^{42} \vartheta^7 \|\dot{p}\|_{L^{\frac{10}{3}}(Q_0)}. \quad (7.2.27)$$

Since Q is bounded, we can cover any compact subset \tilde{Q} of Q by a finite number of cylinders $Q_\varrho = (t_0 - \varrho^2, t_0) \times B_\varrho(x_0)$ which satisfy $Q_{2\varrho} \subset Q$. Exploiting (7.2.27) finishes the proof. \square

7.3 Local Boundedness of ∇p in the Interior

In this section we will prove, that also the gradient ∇p of solutions p to Problem 3.1.1 are locally bounded in the interior. As in the previous section, we apply the Moser iteration technique and follow the arguments which can be found for instance in [43, Chapter 3, §8].

Proposition 7.3.1. *Suppose that the leading elliptic coefficient \mathbf{k} , the initial configuration λ , and the Preisach operator \mathfrak{W} involved in (3.1.2) satisfy Assumptions 3.2.3, and 3.2.4. Assume that there exists a solution $p \in H^1(Q)$ of Problem 3.1.1 such that $p \in C^{\alpha, \frac{\alpha}{4}}(\bar{Q})$, $\|p\|_{L^\infty(Q)} \leq \bar{R}$, with \bar{R} as in Assumption 3.2.3, and setting $s = a_0 p + \mathfrak{W}[\lambda, p]$ with a_0 as in Assumption 3.2.3*

$$\nabla \mathbf{k}[s] \in L_{loc}^{\frac{20}{3}}(Q), \quad \nabla p \in L_{loc}^{\frac{20}{3}}(Q), \quad \frac{\partial}{\partial t} \mathfrak{W}[\lambda, p] \in L_{loc}^\infty(Q) \quad (7.3.1)$$

hold. Then $\nabla p \in L_{loc}^\infty(Q)$.

Proof: The proof is similar to that of Proposition 7.2.1. Thus, let p be a solution of Problem 3.1.1 satisfying the hypotheses of the Proposition. Moreover, let $x_0 \in \Omega$, $\varrho > 0$, and $t_0 \in (0, T]$ be chosen such that $B_\varrho(x_0) \subset \Omega$ and $0 < t_0 - \varrho^2$, where $B_\varrho(x_0)$ denotes the ball of radius ϱ centered at x_0 .

As in the previous section let us consider the sequences

$$\{\varrho_n\}_{n \in \{0,1,2,\dots\}}, \quad \{B_n\}_{n \in \{0,1,2,\dots\}}, \quad \text{and} \quad \{Q_n\}_{n \in \{0,1,2,\dots\}},$$

defined by

$$\varrho_n := \frac{\varrho}{2} + \frac{\varrho}{2^{n+1}}, \quad B_n := B_{\varrho_n}(x_0), \quad Q_n := B_n \times (t_0 - \varrho_n^2, t_0),$$

and the corresponding sequence of cut-off functions $\{\zeta_n\}_{n \in \{1,2,\dots\}} \subset C_0^1(\mathbb{R}^4)$, satisfying

$$0 \leq \zeta_n \leq 1 \text{ a.e. in } Q_n, \quad \text{and} \quad \zeta_n(x, t) = \begin{cases} 1, & \text{for a.a. } (x, t) \in Q_{n+1}, \\ 0, & \text{for a.a. } (x, t) \in ((\mathbb{R}^3 \setminus B_n) \times \mathbb{R}) \cup (\mathbb{R}^3 \times [0, t_0 - \varrho_n^2]), \end{cases}$$

$$\text{and } |\nabla \zeta_n| \leq \frac{2^{n+3}}{\varrho}, \quad \left| \dot{\zeta}_n \right| \leq \frac{2^{n+3}}{\varrho^2}.$$

For $\tau \in \mathbb{R}$ and a function $v \in L^2(Q)$ we define the difference quotients of v by

$$D_\tau^j v(x, t) := \frac{v(x + \tau e_j, t) - v(x, t)}{\tau}, \quad j = 1, 2, 3, \quad \text{for a.a. } (x, t) \in Q, \text{ s.t. } (x + \tau e_j, t) \in Q,$$

where e_j denotes the j -th unit vector in \mathbb{R}^3 .

Moreover we put

$$\nabla_{-\tau} v(x, t) = \begin{pmatrix} D_{-\tau}^1 v(x, t) \\ D_{-\tau}^2 v(x, t) \\ D_{-\tau}^3 v(x, t) \end{pmatrix}, \text{ for a.a. } (x, t) \in Q, \text{ s.t. } (x - \tau e_j, t) \in Q, j = 1, 2, 3,$$

as well as

$$\nabla_\tau v(x, t) = \begin{pmatrix} D_\tau^1 v(x, t) \\ D_\tau^2 v(x, t) \\ D_\tau^3 v(x, t) \end{pmatrix}, \text{ for a.a. } (x, t) \in Q, \text{ s.t. } (x + \tau e_j, t) \in Q, j = 1, 2, 3.$$

With the intention to pass to the limit as $\tau \rightarrow 0$ we can suppose that $0 < \tau \leq \text{dist}(B_0, \partial\Omega)$ holds, and consequently $\nabla_\tau p(x, t)$ and $\nabla_{-\tau} \cdot \nabla_\tau p$ are defined for any $(x, t) \in Q_0$.

Let $q \geq 0$ and for $n, k \in \{1, 2, \dots\}$ we consider the functions $\eta_{n,k} \in L^2(0, T; H^1(B_0))$ defined by

$$\eta_{n,k}(x, t) := \nabla_\tau p |\nabla_\tau p|^{2q} \zeta_n^2 \chi_k(t), \quad \text{a.e. in } (0, T) \times B_0,$$

where the function $\chi_k(t) \in L^\infty(\mathbb{R})$ is defined for all $k \geq 1$ and some $t_1 < t_0$ as follows

$$\chi_k(t) = \begin{cases} 0, & \text{if } t \leq 0, \\ kt, & \text{if } 0 \leq t \leq \frac{1}{k}, \\ 1, & \text{if } \frac{1}{k} \leq t \leq t_1 - \frac{1}{k}, \\ k(t_1 - t), & \text{if } t_1 - \frac{1}{k} \leq t \leq t_1, \\ 0, & \text{if } t \geq t_1. \end{cases}$$

Observing that $\eta_{n,k} = 0$ holds a.e. in $[0, T] \times (\bar{\Omega} \setminus B_0)$, and for a.a. $(x, t) \in \Omega \times [t_1, T]$ we extend $\eta_{n,k}$ trivially to Q . Therefore for all $n, k \in \{1, 2, \dots\}$, the functions $\phi_{n,k} \in L^2(0, T; H^1(\Omega))$ defined by

$$\phi_{n,k}(x, t) := p(x, t) + \nabla_{-\tau} \cdot \eta_{n,k}(x, t) \quad \text{a.e. in } Q$$

satisfy $\gamma_0 \phi(x, t) = \gamma_0 p(x, t)$ for a.a. $(x, t) \in \partial\Omega \times (0, T)$ and consequently $\phi_{n,k}$ are admissible testfunctions for (3.1.2). Testing (3.1.2) with $\phi_{n,k}$ we obtain the following inequality

$$\begin{aligned} & - \int_Q a_0 \dot{p} \nabla_{-\tau} \cdot \left(\nabla_{\tau} p |\nabla_{\tau} p|^{2q} \zeta_n^2 \chi_k \right) dx dt - \int_Q \mathbf{k}[s](\nabla p + \hat{z}) \cdot \nabla \left(\nabla_{-\tau} \cdot \left(\nabla_{\tau} u |\nabla_{\tau} u|^{2q} \zeta_n^2 \chi_k \right) \right) dx dt \\ & \leq - \int_Q \frac{\partial}{\partial t} \mathfrak{W}[\lambda, p] \nabla_{-\tau} \cdot \left(\nabla_{\tau} u |\nabla_{\tau} u|^{2q} \zeta_n^2 \chi_k \right) dx dt; \end{aligned} \quad (7.3.2)$$

As χ_k does not depend on x and $\chi_k \rightarrow \chi_{[0, t_1]}$ weakly* in $L^\infty(0, T)$, where $\chi_{[0, t_1]}$ denotes the characteristic function of the intervall $[0, t_1]$, we can pass to the limit in (7.3.2) as $k \rightarrow \infty$ and obtain

$$\begin{aligned} & - \int_0^{t_1} \int_{\Omega} a_0 \dot{p} \nabla_{-\tau} \cdot \left(\nabla_{\tau} p |\nabla_{\tau} p|^{2q} \zeta_n^2 \right) dx dt \\ & \quad - \int_0^{t_1} \int_{\Omega} \mathbf{k}[s](\nabla p + \hat{z}) \cdot \nabla \left(\nabla_{-\tau} \cdot \left(\nabla_{\tau} p |\nabla_{\tau} p|^{2q} \zeta_n^2 \right) \right) dx dt \\ & \leq - \int_0^{t_1} \int_{\Omega} \frac{\partial}{\partial t} \mathfrak{W}[\lambda, p] \nabla_{-\tau} \cdot \left(\nabla_{\tau} p |\nabla_{\tau} p|^{2q} \zeta_n^2 \right) dx dt. \end{aligned} \quad (7.3.3)$$

In the following we estimate the terms of (7.3.3) separately.

① Applying Lemma A.5.5 to the first term of the left-hand side of (7.3.3) we find

$$\begin{aligned} & - \int_0^{t_1} \int_{\Omega} a_0 \dot{p} \nabla_{-\tau} \cdot \left(\nabla_{\tau} p |\nabla_{\tau} p|^{2q} \zeta_n^2 \right) dx dt \\ & = \int_0^{t_1} \int_{\Omega} a_0 \nabla_{\tau} \dot{p} \cdot \nabla_{\tau} p |\nabla_{\tau} p|^{2q} \zeta_n^2 dx dt \\ & = \frac{a_0}{2q+2} \int_0^{t_1} \int_{\Omega} \frac{\partial}{\partial t} |\nabla_{\tau} p|^{2q+2} \zeta_n^2 dx dt. \end{aligned}$$

Moreover, by virtue of

$$\begin{aligned} & \frac{a_0}{2q+2} \int_0^{t_1} \int_{\Omega} \frac{\partial}{\partial t} |\nabla_{\tau} p|^{2q+2} \zeta_n^2 dx dt \\ &= \frac{a_0}{2q+2} \int_{\Omega} \left[|\nabla_{\tau} p(t_1)|^{2q+2} \zeta_n(t_1)^2 - |\nabla_{\tau} p(0)|^{2q+2} \zeta_n(0)^2 \right] dx \\ & \quad - \frac{a_0}{q+1} \int_0^{t_1} \int_{\Omega} |\nabla_{\tau} p|^{2q+2} \zeta_n \dot{\zeta}_n dx dt \end{aligned}$$

and recalling that by construction $\zeta_n(0) = 0$ a.e. in Ω , $\zeta_n(t_1) = 1$ a.e. in B_{n+1} , $\zeta_n = 0$ a.e. in $([0, t_1] \times \Omega) \setminus ([t_0 - \varrho_n^2, t_1] \times B_n)$, and $|\dot{\zeta}_n| \leq \frac{2^{n+3}}{\varrho^2}$ hold, we obtain

$$\begin{aligned} & \frac{a_0}{2q+2} \int_0^{t_1} \int_{\Omega} \frac{\partial}{\partial t} |\nabla_{\tau} p|^{2q+2} \zeta_n^2 dx dt \\ & \geq \frac{a_0}{2q+2} \int_{B_{n+1}} |\nabla_{\tau} p(t_1)|^{2q+2} dx - \frac{a_0}{q+1} \frac{2^{n+3}}{\varrho^2} \int_{Q_n} |\nabla_{\tau} p|^{2q+2} dx dt, \end{aligned}$$

which in turn yields

$$\begin{aligned} & - \int_0^{t_1} \int_{\Omega} a_0 p \nabla_{-\tau} \cdot \left(\nabla_{\tau} p |\nabla_{\tau} p|^{2q} \zeta_n^2 \right) dx dt \\ & \geq \frac{a_0}{2q+2} \int_{B_{n+1}} |\nabla_{\tau} p(t_1)|^{2q+2} dx - \frac{a_0}{q+1} \frac{2^{n+3}}{\varrho^2} \int_{Q_n} |\nabla_{\tau} p|^{2q+2} dx dt. \quad (7.3.4) \end{aligned}$$

Let us proceed with the elliptic term of (7.3.3). By virtue of Lemma A.5.5, we calculate

$$\begin{aligned} & - \int_0^{t_1} \int_{\Omega} \mathbf{k}[s] (\nabla p + \hat{z}) \cdot \nabla \left(\nabla_{-\tau} \cdot \left(\nabla_{\tau} p |\nabla_{\tau} p|^{2q} \zeta_n^2 \right) \right) dx dt \\ &= - \int_0^{t_1} \int_{\Omega} \sum_{i=1}^3 \mathbf{k}[s] (\partial_i p + \hat{z}) \partial_i \left(\sum_{j=1}^3 D_{-\tau}^j \left(D_{\tau}^j p |\nabla_{\tau} p|^{2q} \zeta_n^2 \right) \right) dx dt \\ &= - \int_0^{t_1} \int_{\Omega} \sum_{i=1}^3 \sum_{j=1}^3 \mathbf{k}[s] (\partial_i p + \hat{z}) D_{-\tau}^j \left(\partial_i \left(D_{\tau}^j p |\nabla_{\tau} p|^{2q} \zeta_n^2 \right) \right) dx dt \\ &= \int_0^{t_1} \int_{\Omega} \sum_{i=1}^3 \sum_{j=1}^3 D_{\tau}^j [\mathbf{k}[s] (\partial_i p + \hat{z})] \partial_i \left(D_{\tau}^j p |\nabla_{\tau} p|^{2q} \zeta_n^2 \right) dx dt. \quad (7.3.5) \end{aligned}$$

Moreover, a straightforward computation yields for all $i, j = 1, 2, 3$

$$D_{\tau}^j [\mathbf{k}[s] (\partial_i p + \hat{z})] = \mathbf{k}[s] D_{\tau}^j \partial_i p + D_{\tau}^j \mathbf{k}[s] [(\partial_i p + \hat{z})],$$

a.e. in Q_0 , as well as

$$\begin{aligned} \partial_i \left(D_{\tau}^j p |\nabla_{\tau} p|^{2q} \zeta_n^2 \right) &= \partial_i D_{\tau}^j p |\nabla_{\tau} p|^{2q} \zeta_n^2 + 2q D_{\tau}^j p |\nabla_{\tau} p|^{2q-2} \left(\sum_{l=1}^3 D_{\tau}^l p \partial_i \cdot D_{\tau}^l p \right) \zeta_n^2 \\ & \quad + 2 D_{\tau}^j p |\nabla_{\tau} p|^{2q} \zeta_n \partial_i \zeta_n \end{aligned}$$

a.e. in Q_0 . Therefore we obtain the following estimates for the elliptic part of (7.3.3)

② First, the hypotheses of the Proposition, together with Assumption 3.2.4 on \mathbf{k} imply

$$\int_0^{t_1} \int_{\Omega} \sum_{i=1}^3 \sum_{j=1}^3 \mathbf{k}[s] |D_{\tau}^j \partial_i p|^2 |\nabla_{\tau} p|^{2q} \zeta_n^2 dx dt \geq \underline{k} \int_0^{t_1} \int_{\Omega} \sum_{i=1}^3 \sum_{j=1}^3 |D_{\tau}^j \partial_i p|^2 |\nabla_{\tau} p|^{2q} \zeta_n^2 dx dt$$

$$= \underline{k} \int_0^{t_1} \int_{\Omega} |\nabla \nabla_{\tau} p|^2 |\nabla_{\tau} p|^{2q} \zeta_n^2 dx dt. \quad (7.3.6)$$

③ Then again, a straightforward computation yields

$$\begin{aligned} & 2q \int_0^{t_1} \int_{\Omega} \mathbf{k}[s] |\nabla_{\tau} p|^{2q-2} \sum_{i=1}^3 \sum_{j=1}^3 \partial_i D_{\tau}^j p D_{\tau}^j p \left(\sum_{l=1}^3 D_{\tau}^l p \partial_i D_{\tau}^l p \right) \zeta_n^2 dx dt \\ &= 2q \int_0^{t_1} \int_{\Omega} \mathbf{k}[s] |\nabla_{\tau} p|^{2q-2} \sum_{i=1}^3 \sum_{j=1}^3 \partial_i D_{\tau}^j p D_{\tau}^j p \left(\sum_{l=1}^3 D_{\tau}^l p \partial_i D_{\tau}^l p \right) \zeta_n^2 dx dt \\ &= 2q \int_0^{t_1} \int_{\Omega} \mathbf{k}[s] |\nabla_{\tau} p|^{2q-2} \sum_{j=1}^3 \left(\sum_{i=1}^3 D_{\tau}^j p \partial_i D_{\tau}^j p \right)^2 \zeta_n^2 dx dt, \end{aligned}$$

and therefore by virtue of Assumption 3.2.4

$$\begin{aligned} & 2q \int_0^{t_1} \int_{\Omega} \mathbf{k}[s] |\nabla_{\tau} p|^{2q-2} \sum_{i=1}^3 \sum_{j=1}^3 \partial_i D_{\tau}^j p D_{\tau}^j p \left(\sum_{l=1}^3 D_{\tau}^l p \partial_i D_{\tau}^l p \right) \zeta_n^2 dx dt \\ & \geq 2q \underline{k} \int_0^{t_1} \int_{\Omega} |\nabla_{\tau} p|^{2q-2} \sum_{j=1}^3 \left(\sum_{i=1}^3 D_{\tau}^j p \partial_i D_{\tau}^j p \right)^2 \zeta_n^2 dx dt \quad (7.3.7) \end{aligned}$$

follows.

④ Moreover, making use of Assumption 3.2.4, we deduce with the help of Young's inequality

$$\begin{aligned} & 2 \left| \int_0^{t_1} \int_{\Omega} \sum_{i=1}^3 \sum_{j=1}^3 \mathbf{k}[s] \partial_i D_{\tau}^j p D_{\tau}^j p |\nabla_{\tau} p|^{2q} \zeta_n \nabla \zeta_n dx dt \right| \\ & \leq 2\bar{k} \int_0^{t_1} \int_{\Omega} \sum_{i=1}^3 \sum_{j=1}^3 |\partial_i D_{\tau}^j p| |D_{\tau}^j p| |\nabla_{\tau} p|^{2q} \zeta_n |\nabla \zeta_n| dx dt \\ & \leq \int_0^{t_1} \int_{\Omega} \frac{\underline{k}}{4} |\nabla \nabla_{\tau} p|^2 |\nabla_{\tau} p|^{2q} \zeta_n^2 + \frac{36\bar{k}^2}{\underline{k}} |\nabla_{\tau} p|^{2q+2} |\nabla \zeta_n|^2 dx dt. \end{aligned}$$

Recalling the construction of ζ_n , the preceding inequality turns into

$$\begin{aligned} & 2 \left| \int_0^{t_1} \int_{\Omega} \sum_{i=1}^3 \sum_{j=1}^3 \mathbf{k}[s] \partial_i D_{\tau}^j p D_{\tau}^j p |\nabla_{\tau} p|^{2q} \zeta_n \nabla \zeta_n dx dt \right| \\ & \leq \frac{\underline{k}}{4} \int_0^{t_1} \int_{\Omega} |\nabla \nabla_{\tau} p|^2 |\nabla_{\tau} p|^{2q} \zeta_n^2 dx dt + \frac{36\bar{k}^2}{\underline{k}} \frac{2^{2(n+3)}}{\varrho^2} \int_{Q_n} |\nabla_{\tau} p|^{2q+2} dx dt. \quad (7.3.8) \end{aligned}$$

⑤ Then again, bearing in mind the construction of ζ_n and that $|\hat{z}| = 1$, application of Young's inequality provides

$$\begin{aligned} & \left| \int_0^{t_1} \int_{\Omega} \sum_{i=1}^3 \sum_{j=1}^3 D_{\tau}^j \mathbf{k}[s] (\partial_i p + \hat{z}) \partial_i D_{\tau}^j p |\nabla_{\tau} p|^{2q} \zeta_n^2 dx dt \right| \\ & \leq \int_0^{t_1} \int_{\Omega} \sum_{i=1}^3 \sum_{j=1}^3 |D_{\tau}^j \mathbf{k}| (|\partial_i p| + 1) |\partial_i D_{\tau}^j p| |\nabla_{\tau} p|^{2q} \zeta_n^2 dx dt \end{aligned}$$

$$\leq \frac{\underline{k}}{4} \int_0^{t_1} \int_{\Omega} |\nabla \nabla_{\tau} p|^2 |\nabla_{\tau} p|^{2q} \zeta_n^2 dx dt + \frac{2}{\underline{k}} \int_{Q_n} |\nabla_{\tau} k|^2 (|\nabla p| + 1)^2 |\nabla_{\tau} p|^{2q} dx dt.$$

Furthermore, by virtue of Young's inequality, we find that

$$\begin{aligned} & |\nabla p| |\nabla_{\tau} p|^q + |\nabla_{\tau} p|^q \\ & \leq \frac{1}{q+1} |\nabla p|^{q+1} + \frac{q}{q+1} |\nabla_{\tau} p|^{q+1} + \frac{q}{q+1} |\nabla_{\tau} p|^{q+1} + \frac{1}{q+1} \\ & \leq |\nabla p|^{q+1} + 2 |\nabla_{\tau} p|^{q+1} + 1 \end{aligned}$$

is satisfied for all $q \geq 0$ and consequently

$$\begin{aligned} & \left| \int_0^{t_1} \int_{\Omega} \sum_{i=1}^3 \sum_{j=1}^3 D_{\tau}^j \mathbf{k}[s] (\partial_i p + \hat{z}) \partial_i D_{\tau}^j p |\nabla_{\tau} p|^{2q} \zeta_n^2 dx dt \right| \\ & \leq \frac{\underline{k}}{4} \int_0^{t_1} \int_{\Omega} |\nabla \nabla_{\tau} p|^2 |\nabla_{\tau} p|^{2q} \zeta_n^2 dx dt + \frac{4}{\underline{k}} \int_{Q_n} |\nabla_{\tau} k|^2 |\nabla p|^{2q+2} dx dt \\ & \quad + \frac{16}{\underline{k}} \int_{Q_n} |\nabla_{\tau} k|^2 |\nabla_{\tau} p|^{2q+2} dx dt + \frac{4}{\underline{k}} \int_{Q_n} |\nabla_{\tau} k|^2 dx dt \quad (7.3.9) \end{aligned}$$

follows.

⑥ Moreover, again by virtue of Young's inequality and the construction of ζ_n we obtain the following estimate

$$\begin{aligned} & 2q \left| \int_0^{t_1} \int_{\Omega} \sum_{i=1}^3 \sum_{j=1}^3 D_{\tau}^j \mathbf{k}[s] (\partial_i p + \hat{z}) D_{\tau}^j p |\nabla_{\tau} p|^{2q-2} \left(\sum_{l=1}^3 D_{\tau}^l p \partial_i D_{\tau}^l p \right) \zeta_n^2 dx dt \right| \\ & \leq \int_0^{t_1} \int_{\Omega} \sum_{i=1}^3 \sum_{j=1}^3 |D_{\tau}^j k| (|\partial_i p| + 1) |D_{\tau}^j p| |\nabla_{\tau} p|^{2q-2} \left| \sum_{l=1}^3 D_{\tau}^l p \partial_i D_{\tau}^l p \right| \zeta_n^2 dx dt \\ & \leq \int_0^{t_1} \int_{\Omega} q \frac{3}{\underline{k}} |\nabla_{\tau} k|^2 (|\nabla p| + 1)^2 |\nabla_{\tau} p|^{2q} \zeta_n^2 + \underline{k} q |\nabla_{\tau} p|^{2q-2} \sum_{i=1}^3 \left(\sum_{l=1}^3 D_{\tau}^l p \partial_i D_{\tau}^l p \right)^2 \zeta_n^2 dx dt. \end{aligned}$$

Arguing as in the previous step we find

$$\begin{aligned} & 2q \left| \int_0^{t_1} \int_{\Omega} \sum_{i=1}^3 \sum_{j=1}^3 D_{\tau}^j \mathbf{k}[s] (\partial_i p + \hat{z}) D_{\tau}^j p |\nabla_{\tau} p|^{2q-2} \left(\sum_{l=1}^3 D_{\tau}^l p \partial_i D_{\tau}^l p \right) \zeta_n^2 dx dt \right| \\ & \leq \underline{k} q \int_0^{t_1} \int_{\Omega} |\nabla_{\tau} p|^{2q-2} \sum_{i=1}^3 \left(\sum_{l=1}^3 D_{\tau}^l p \partial_i D_{\tau}^l p \right)^2 \zeta_n^2 dx dt \\ & \quad + \frac{6}{\underline{k}} q \int_{Q_n} |\nabla_{\tau} k|^2 |\nabla p|^{2q+2} dx dt + \frac{24}{\underline{k}} q \int_{Q_n} |\nabla_{\tau} k|^2 |\nabla_{\tau} p|^{2q+2} dx dt \\ & \quad + q \frac{6}{\underline{k}} \int_{Q_n} |\nabla_{\tau} k|^2 dx dt. \quad (7.3.10) \end{aligned}$$

⑦ And finally, Young's inequality yields

$$\begin{aligned}
& 2 \left| \int_0^{t_1} \int_{\Omega} \sum_{i=1}^3 \sum_{j=1}^3 D_{\tau}^j k(\partial_i p + \hat{z}) D_{\tau}^j p |\nabla_{\tau} p|^{2q} \zeta_n \nabla \zeta_n dx dt \right| \\
& \leq 2 \int_0^{t_1} \int_{\Omega} \sum_{i=1}^3 \sum_{j=1}^3 |D_{\tau}^j k| (|\partial_i p| + 1) |D_{\tau}^j p| |\nabla_{\tau} p|^{2q} \zeta_n |\nabla \zeta_n| dx dt \\
& \leq \int_0^{t_1} \int_{\Omega} |\nabla_{\tau} k|^2 (|\nabla p| + 1)^2 |\nabla_{\tau} p|^{2q} \zeta_n^2 + 3 |\nabla_{\tau} p|^{2q+2} |\nabla \zeta_n|^2 dx dt,
\end{aligned}$$

and with a similar computation as before

$$\begin{aligned}
& 2 \left| \int_0^{t_1} \int_{\Omega} \sum_{i=1}^3 \sum_{j=1}^3 D_{\tau}^j k(\partial_i p + \hat{z}) D_{\tau}^j p |\nabla_{\tau} p|^{2q} \zeta_n \nabla \zeta_n dx dt \right| \\
& \leq 3 \frac{2^{2(n+3)}}{\varrho^2} \int_{Q_n} |\nabla_{\tau} p|^{2q+2} dx dt + 8 \int_{Q_n} |\nabla_{\tau} k|^2 |\nabla_{\tau} p|^{2q+2} dx dt \\
& \quad + 2 \int_{Q_n} |\nabla_{\tau} k|^2 |\nabla p|^{2q+2} dx dt + 2 \int_{Q_n} |\nabla_{\tau} k|^2 dx dt \quad (7.3.11)
\end{aligned}$$

follows.

Let us now estimate the right-hand side of (7.3.3).

- ⑧ Bearing in mind the construction of ζ_n , Lemma A.5.4 together with Hölder's inequality implies

$$\begin{aligned}
& \left| \int_0^{t_1} \int_{\Omega} \frac{\partial}{\partial t} \mathfrak{W}[\lambda, p] \nabla_{-\tau} \cdot \left(\nabla_{\tau} p |\nabla_{\tau} p|^{2q} \zeta_n^2 \right) dx dt \right| \\
& = \left| \int_{Q_n} \frac{\partial}{\partial t} \mathfrak{W}[\lambda, p] \nabla_{-\tau} \cdot \left(\nabla_{\tau} p |\nabla_{\tau} p|^{2q} \zeta_n^2 \right) dx dt \right| \\
& \leq \left\| \frac{\partial}{\partial t} \mathfrak{W}[\lambda, p] \right\|_{L^{\infty}(Q_n)} \left\| \nabla_{-\tau} \cdot \left(\nabla_{\tau} p |\nabla_{\tau} p|^{2q} \zeta_n^2 \right) \right\|_{L^1(Q_n)} \\
& \leq \left\| \frac{\partial}{\partial t} \mathfrak{W}[\lambda, p] \right\|_{L^{\infty}(Q_n)} \left\| \nabla \cdot \left(\nabla_{\tau} p |\nabla_{\tau} p|^{2q} \zeta_n^2 \right) \right\|_{L^1(Q_n)}.
\end{aligned}$$

By virtue of the trivial identities

$$\begin{aligned}
& \left\| \frac{\partial}{\partial t} \mathfrak{W}[\lambda, p] \right\|_{L^{\infty}(Q_n)} \left\| \nabla \cdot \left(\nabla_{\tau} p |\nabla_{\tau} p|^{2q} \zeta_n^2 \right) \right\|_{L^1(Q_n)} \\
& = \int_{Q_n} \left\| \frac{\partial}{\partial t} \mathfrak{W}[\lambda, p] \right\|_{L^{\infty}(Q_n)} \left| \nabla \cdot \left(\nabla_{\tau} p |\nabla_{\tau} p|^{2q} \zeta_n^2 \right) \right| dx dt, \quad (7.3.12)
\end{aligned}$$

and

$$\begin{aligned}
\nabla \cdot \left(\nabla_{\tau} p |\nabla_{\tau} p|^{2q} \zeta_n^2 \right) & = \sum_{i=1}^3 \partial_i \left(D_{\tau}^i p |\nabla_{\tau} p|^{2q} \zeta_n^2 \right) \\
& = \sum_{i=1}^3 \partial_i D_{\tau}^i p |\nabla_{\tau} p|^{2q} \zeta_n^2 + 2q |\nabla_{\tau} p|^{2q-2} \sum_{i=1}^3 D_{\tau}^i p \sum_{j=1}^3 \partial_i D_{\tau}^j p D_{\tau}^j p \zeta_n^2 \\
& \quad + 2 \sum_{i=1}^3 D_{\tau}^i p |\nabla_{\tau} p|^{2q} \zeta_n \partial_i \zeta_n
\end{aligned}$$

a.e. in Q_n , we deduce with the help of Hölder's inequality the following estimates

$$\begin{aligned} \left\| \frac{\partial}{\partial t} \mathfrak{W}[\lambda, p] \right\|_{L^\infty(Q_n)} & \sum_{i=1}^3 \partial_i D_\tau^i p |\nabla_\tau p|^{2q} \zeta_n^2 \\ & \leq \frac{k}{4} |\nabla \nabla_\tau p|^2 |\nabla_\tau p|^{2q} \zeta_n^2 + \frac{3}{k} \left\| \frac{\partial}{\partial t} \mathfrak{W}[\lambda, p] \right\|_{L^\infty(Q_n)}^2 |\nabla_\tau p|^{2q} \zeta_n^2, \end{aligned} \quad (7.3.13)$$

$$\begin{aligned} 2q \left\| \frac{\partial}{\partial t} \mathfrak{W}[\lambda, p] \right\|_{L^\infty(Q_n)} & |\nabla_\tau p|^{2q-2} \sum_{i=1}^3 D_\tau^i p \sum_{j=1}^3 \partial_i D_\tau^j p D_\tau^j p \zeta_n^2 \\ & \leq \frac{k}{2} q |\nabla_\tau p|^{2q-2} \sum_{i=1}^3 \left(\sum_{j=1}^3 \partial_i D_\tau^j p D_\tau^j p \right)^2 \zeta_n^2 + \frac{2}{k} q \left\| \frac{\partial}{\partial t} \mathfrak{W}[\lambda, p] \right\|_{L^\infty(Q_n)}^2 |\nabla_\tau p|^{2q} \zeta_n^2, \end{aligned} \quad (7.3.14)$$

as well as

$$\begin{aligned} 2 \left\| \frac{\partial}{\partial t} \mathfrak{W}[\lambda, p] \right\|_{L^\infty(Q_n)} & \sum_{i=1}^3 D_\tau^i p |\nabla_\tau p|^{2q} \zeta_n \partial_i \zeta_n \\ & \leq |\nabla_\tau p|^{2q+2} |\nabla \zeta_n|^2 + \left\| \frac{\partial}{\partial t} \mathfrak{W}[\lambda, p] \right\|_{L^\infty(Q_n)}^2 |\nabla_\tau p|^{2q} \zeta_n^2. \end{aligned} \quad (7.3.15)$$

Therefore, exploiting the construction of ζ_n , we find assembling (7.3.12) - (7.3.15) the succeeding bound

$$\begin{aligned} & \left| \int_0^{t_1} \int_\Omega \frac{\partial}{\partial t} \mathfrak{W}[\lambda, p] \nabla_{-\tau} \cdot \left(\nabla_\tau p |\nabla_\tau p|^{2q} \zeta_n^2 \right) dx dt \right| \\ & \leq \frac{k}{4} \int_0^{t_1} \int_{B_{n+1}} |\nabla \nabla_\tau p|^2 |\nabla_\tau p|^{2q} \zeta_n^2 dx dt \\ & \quad + \frac{k}{2} q \int_0^{t_1} \int_{B_{n+1}} |\nabla_\tau p|^{2q-2} \sum_{i=1}^3 \left(\sum_{j=1}^3 \partial_i D_\tau^j p D_\tau^j p \right)^2 \zeta_n^2 dx dt \\ & \quad + \frac{5+k}{k} \left\| \frac{\partial}{\partial t} \mathfrak{W}[\lambda, p] \right\|_{L^\infty(Q_n)}^2 \int_{Q_n} |\nabla_\tau p|^{2q} dx dt \\ & \quad + \frac{2^{2(n+3)}}{\varrho^2} \int_{Q_n} |\nabla_\tau p|^{2q+2} dx dt. \end{aligned} \quad (7.3.16)$$

And since Young's inequality yields the pointwise estimate

$$|\nabla_\tau p|^{2q} \leq \frac{q}{q+1} |\nabla_\tau p|^{2q+2} + \frac{1}{q+1} \leq |\nabla_\tau p|^{2q+2} + 1$$

a.e. in Q , we finally conclude that

$$\begin{aligned} & \left| \int_0^{t_1} \int_\Omega \frac{\partial}{\partial t} \mathfrak{W}[\lambda, p] \nabla_{-\tau} \cdot \left(\nabla_\tau p |\nabla_\tau p|^{2q} \zeta_n^2 \right) dx dt \right| \\ & \leq \frac{k}{4} \int_0^{t_1} \int_{B_{n+1}} |\nabla \nabla_\tau p|^2 |\nabla_\tau p|^{2q} \zeta_n^2 dx dt \\ & \quad + \frac{k}{2} q \int_0^{t_1} \int_{B_{n+1}} |\nabla_\tau p|^{2q-2} \sum_{i=1}^3 \left(\sum_{j=1}^3 \partial_i D_\tau^j p D_\tau^j p \right)^2 \zeta_n^2 dx dt \end{aligned}$$

$$\begin{aligned}
& + \left(\frac{5+k}{\underline{k}} \left\| \frac{\partial}{\partial t} \mathfrak{W}[\lambda, p] \right\|_{L^\infty(Q_n)}^2 + \frac{2^{2(n+3)}}{\varrho^2} \right) \int_{Q_n} |\nabla_\tau p|^{2q+2} dx dt \\
& \quad + \frac{5+k}{\underline{k}} \left\| \frac{\partial}{\partial t} \mathfrak{W}[\lambda, p] \right\|_{L^\infty(Q_n)}^2 |Q_n| \quad (7.3.17)
\end{aligned}$$

holds.

Inserting the estimates (7.3.4), (7.3.6), (7.3.7), (7.3.8), (7.3.9), (7.3.10), (7.3.11), (7.3.17) into (7.3.3) we conclude that

$$\begin{aligned}
& \frac{a}{2q+2} \int_{B_{n+1}} |\nabla_\tau p(t_1)|^{2q+2} dx + \int_0^{t_1} \int_{B_{n+1}} \frac{\underline{k}}{4} |\nabla \nabla_\tau p|^2 |\nabla_\tau u|^{2q} dx dt \\
& \quad + \frac{\underline{k}}{2} q \int_0^{t_1} \int_{B_{n+1}} \sum_{i=1}^3 \left(\sum_{j=1}^3 D_\tau^j p \partial_i D_\tau^j p \right)^2 |\nabla_\tau p|^{2q-2} dx dt \\
& \leq \left(a_0 + 4 + \frac{5+k}{\underline{k}} \left\| \frac{\partial}{\partial t} \mathfrak{W}[\lambda, p] \right\|_{L^\infty(Q_n)}^2 + \frac{36\bar{k}^2}{\underline{k}} \right) \frac{2^{2(n+3)}}{\varrho^2} \int_{Q_n} |\nabla_\tau p|^{2q+2} dx dt \\
& \quad + \frac{12}{\underline{k}} (q+1) \int_{Q_n} |\nabla_\tau k|^2 |\nabla p|^{2q+2} dx dt + \frac{48}{\underline{k}} (q+1) \int_{Q_n} |\nabla_\tau k|^2 |\nabla_\tau p|^{2q+2} dx dt \\
& \quad + \frac{12}{\underline{k}} (q+1) \int_{Q_n} |\nabla_\tau k|^2 dx dt + \frac{5+k}{\underline{k}} \left\| \frac{\partial}{\partial t} \mathfrak{W}[\lambda, p] \right\|_{L^\infty(Q_n)}^2 |Q_n|
\end{aligned}$$

is satisfied. Introducing the constant

$$\hat{c}_0 := a_0 + 4 + \frac{5+k}{\underline{k}} \max\{1; |Q|\} \left\| \frac{\partial}{\partial t} \mathfrak{W}[\lambda, p] \right\|_{L^\infty(Q_n)}^2 + \frac{36\bar{k}^2}{\underline{k}} + \frac{48}{\underline{k}} + \frac{12}{\underline{k}} \|\nabla k\|_{L^2(Q)}^2,$$

and observing that

$$\sum_{i=1}^3 \left(\sum_{j=1}^3 D_\tau^j p \partial_i D_\tau^j p \right)^2 \leq 3 \sum_{j=1}^3 \sum_{i=1}^3 |D_\tau^j p|^2 |\partial_i D_\tau^j p|^2 = 3 |\nabla \nabla_\tau p|^2 |\nabla_\tau p|^2$$

holds a.e. in Q , the succeeding estimate follows

$$\begin{aligned}
& \frac{a}{2q+2} \int_{B_{n+1}} |\nabla_\tau p(t_1)|^{2q+2} dx + \frac{\underline{k}}{12} (q+1) \int_0^{t_1} \int_{B_{n+1}} \sum_{j=1}^3 \left(\sum_{i=1}^3 D_\tau^j p \partial_i D_\tau^j p \right)^2 |\nabla_\tau p|^{2q-2} dx dt \\
& \leq \hat{c}_0 \frac{2^{2(n+3)}}{\varrho^2} (q+1) \left[\int_{Q_n} (1 + |\nabla_\tau k|^2) |\nabla_\tau p|^{2q+2} + |\nabla_\tau k|^2 |\nabla p|^{2q+2} dx dt + 2 \right].
\end{aligned}$$

Proceeding as in [43, Chapter 3, §11] we find that

$$\left| \nabla (|\nabla_\tau p|^{q+1}) \right|^2 \leq 2(q+1)^2 |\nabla_\tau p|^{2q-2} \sum_{i=1}^3 \left(\sum_{j=1}^3 D_\tau^j p \partial_i D_\tau^j p \right)^2$$

is satisfied a.e. in Q and as a consequence

$$\frac{\min\{a_0; \underline{k}\}}{24(q+1)} \left[\left\| |\nabla_\tau p(t_1)|^{q+1} \right\|_{L^2(B_{n+1})}^2 + \left\| \nabla (|\nabla_\tau p|^{q+1}) \right\|_{L^2((t_0 - \varrho_{n+1}^2, t_1) \times B_{n+1})}^2 \right]$$

$$\leq \hat{c}_0 \frac{2^{2(n+3)}}{\varrho^2} (q+1) \left[\int_{Q_n} (1 + |\nabla_{\tau} k|^2) |\nabla_{\tau} p|^{2q+2} + |\nabla_{\tau} k|^2 |\nabla p|^{2q+2} dx dt + 2 \right] \quad (7.3.18)$$

holds. By virtue of Hölder's inequality and of Lemma A.5.4 we find the following estimates

$$\begin{aligned} \textcircled{1} \quad \int_{Q_n} (1 + |\nabla_{\tau} k|^2) |\nabla_{\tau} p|^{2q+2} dx dt &\leq \left[|Q_n|^{\frac{3}{10}} + \left\| |\nabla_{\tau} k|^2 \right\|_{L^{\frac{10}{3}}(Q_n)} \right] \left\| |\nabla_{\tau} p|^{2q+2} \right\|_{L^{\frac{10}{7}}(Q_n)} \\ &\leq \left[|Q_0|^{\frac{3}{10}} + \left\| \nabla k \right\|_{L^{\frac{20}{3}}(Q_0)}^2 \right] \left\| |\nabla_{\tau} p|^{q+1} \right\|_{L^{\frac{20}{7}}(Q_n)}^2, \end{aligned} \quad (7.3.19)$$

$$\begin{aligned} \textcircled{2} \quad \int_{Q_n} |\nabla_{\tau} k|^2 |\nabla p|^{2q+2} dx dt &\leq \left\| |\nabla_{\tau} k|^2 \right\|_{L^{\frac{10}{3}}(Q_n)} \left\| |\nabla p|^{2q+2} \right\|_{L^{\frac{10}{7}}(Q_n)} \\ &\leq \left\| \nabla k \right\|_{L^{\frac{20}{3}}(Q_0)}^2 \left\| |\nabla p|^{q+1} \right\|_{L^{\frac{20}{7}}(Q_n)}^2. \end{aligned} \quad (7.3.20)$$

Inserting (7.3.19) and (7.3.20) into (7.3.18), and taking the supremum over $t_1 \in [t_0 - \varrho_{n+1}^2, t_0]$ in the resulting inequality, we arrive at

$$\begin{aligned} &\frac{\min\{a_0; \underline{k}\}}{24(q+1)} \left[\sup_{t_0 - \varrho_{n+1}^2 \leq t \leq t_0} \left\| |\nabla_{\tau} p(t)|^{q+1} \right\|_{L^2(B_{n+1})}^2 + \left\| \nabla(|\nabla_{\tau} p|^{q+1}) \right\|_{L^2(Q_{n+1})}^2 \right] \\ &\leq \hat{c}_0 \frac{2^{2(n+3)}}{\varrho^2} (q+1) \left(\left[|Q_0|^{\frac{3}{10}} + \left\| \nabla k \right\|_{L^{\frac{20}{3}}(Q_0)}^2 \right] \left(\left\| |\nabla p|^{q+1} \right\|_{L^{\frac{20}{7}}(Q_n)}^2 + \left\| |\nabla_{\tau} p|^{q+1} \right\|_{L^{\frac{20}{7}}(Q_n)}^2 \right) + 2 \right). \end{aligned} \quad (7.3.21)$$

Moreover, application of the interpolation inequality sated in Proposition A.6.1 to the left-hand side of (7.3.21) yields

$$\begin{aligned} &\frac{\min\{a_0; \underline{k}\}}{24\beta^2(q+1)} \left\| |\nabla_{\tau} p|^{q+1} \right\|_{L^{\frac{10}{3}}(Q_{n+1})}^2 \\ &\leq \hat{c}_0 \frac{2^{2(n+3)}}{\varrho^2} (q+1) \left(\left[|Q_0|^{\frac{3}{10}} + \left\| \nabla k \right\|_{L^{\frac{20}{3}}(Q_0)}^2 \right] \left(\left\| |\nabla_{\tau} p|^{q+1} \right\|_{L^{\frac{20}{7}}(Q_n)}^2 + \left\| |\nabla p|^{q+1} \right\|_{L^{\frac{20}{7}}(Q_n)}^2 \right) + 2 \right), \end{aligned} \quad (7.3.22)$$

where β is as in Proposition A.6.1. Introducing the constant

$$\gamma^2 := \frac{6\beta^2}{\min a_0, \underline{k}} \frac{2^6}{\varrho^2} \hat{c}_0 \max \left\{ 1; |Q_0|^{\frac{3}{10}} + \left\| \nabla k \right\|_{L^{\frac{20}{3}}(Q_0)}^2 \right\},$$

we can rewrite (7.3.22) as follows

$$\left\| |\nabla_{\tau} p|^{q+1} \right\|_{L^{\frac{10}{3}}(Q_{n+1})}^2 \leq (q+1)^2 (2^{n+1} \gamma)^2 \left(\left\| |\nabla_{\tau} p|^{q+1} \right\|_{L^{\frac{20}{7}}(Q_n)}^2 + \left\| |\nabla p|^{q+1} \right\|_{L^{\frac{20}{7}}(Q_n)}^2 + 1 \right). \quad (7.3.23)$$

Choosing the numbers q such that $(q+1) = \left(\frac{7}{6}\right)^{n+1}$, $n \geq 0$ and observing that $\frac{20}{7} \frac{7}{6} = \frac{10}{3}$ holds, (7.3.23) turns into

$$\left\| |\nabla_{\tau} p| \right\|_{L^{\frac{10}{3} * \left(\frac{7}{6}\right)^{n+1}}(Q_{n+1})}^{\left(\frac{7}{6}\right)^{n+1}} \leq \left(\frac{7}{3}\right)^{n+1} \gamma \left(\left\| |\nabla_{\tau} p| \right\|_{L^{\frac{10}{3} * \left(\frac{7}{6}\right)^n}(Q_n)}^{\left(\frac{7}{6}\right)^{n+1}} + \left\| |\nabla p| \right\|_{L^{\frac{10}{3} * \left(\frac{7}{6}\right)^n}(Q_n)}^{\left(\frac{7}{6}\right)^{n+1}} + 1 \right). \quad (7.3.24)$$

Proceeding as in Section 7.2 we conclude, that

$$\max \left\{ 1; \|\nabla p\|_{L^{\frac{10}{3}} * \left(\frac{7}{6}\right)^{n+1}(Q_{n+1})} \right\} \leq \prod_{i=1}^{n+1} \left(\frac{7}{3}\right)^{i\left(\frac{6}{7}\right)^i} (2\gamma)^{\left(\frac{6}{7}\right)^i} \max \left\{ 1; \|\nabla p\|_{L^{\frac{10}{3}}(Q_0)} \right\} \quad (7.3.25)$$

holds, and consequently

$$\|\nabla p\|_{L^\infty\left(\left(t_0 - \frac{\rho^2}{4}; t_0\right) \times B_{\frac{\rho}{2}}(x_0)\right)} \leq \left(\frac{7}{3}\right)^{42} (2\gamma)^7 \max \left\{ 1; \|\nabla p\|_{L^{\frac{10}{3}}(Q_0)} \right\}$$

is satisfied. The same covering argument as in Section 7.2 finishes the proof. \square

APPENDIX A

GENERAL ANALYSIS RESULTS

The appendix contains important Definitions, Theorems etc. used in this thesis. Almost all of them are presented without a proof, we quote in each case references where the reader may find further details. We make an exception in Section A.8 and present complete proofs for the EMBEDDINGS OF DE GIORGI FUNCTION CLASSES INTO HÖLDER SPACES extending well known results to a particular situation, which - to our knowledge - is not covered in the literature.

A.1 Domains and their Boundaries

Let Ω be an open subset of \mathbb{R}^N , $N \in \mathbb{N}$, $N \geq 1$. We denote by $\partial\Omega$ the boundary of Ω .

We start this section introducing domains of class $C^{m,\lambda}$ following [68, Section 2].

Definition A.1.1 (Open Sets of Class $C^{m,\lambda}$). *Let us denote by $B_N(x, \varrho)$ the open ball in \mathbb{R}^N centered at x with radius ϱ .*

For any $m \in \mathbb{N}$ and $0 \leq \lambda \leq 1$, we say that Ω is of class $C^{m,\lambda}$ and write $\Omega \in C^{m,\lambda}$, if and only if for any $x \in \partial\Omega$, there exist

- (i) *two positive constants $\varrho = R_x$ and δ ,*
- (ii) *a mapping $\varphi : B_{N-1}(x, \varrho) \rightarrow \mathbb{R}$ of class $C^{m,\lambda}$,*
- (iii) *a Cartesian system of coordinates y_1, \dots, y_N ,*

such that the point x is characterized by $y_1 = \dots = y_N = 0$ in this Cartesian system and for any $y' := (y_1, \dots, y_{N-1}) \in B_{N-1}(x, \varrho)$

$$\begin{aligned} y_N = \varphi(y') & \implies (y', y_N) \in \partial\Omega, \\ \varphi(y') < y_N < \varphi(y') + \delta & \implies (y', y_N) \in \Omega, \end{aligned}$$

$$\varphi(y') - \delta < y_N < \varphi(y') \quad \implies (y', y_N) \notin \bar{\Omega}.$$

We say, that Ω is a continuous (Lipschitz, Hölder, resp.) open set, whenever it is of class $C^{0,0}$ ($C^{0,1}$, $C^{0,\lambda}$ for some $\lambda \in (0, 1)$, resp.)

Let us proceed with the so called property of POSITIVE GEOMETRIC DENSITY. We refer to [16, Definition 17.2]

Definition A.1.2 (Positive geometric density). Let $\Gamma \subseteq \partial\Omega$. We say that Γ satisfies the property of positive geometric density with respect to the Lebesgue measure in \mathbb{R}^N , if there exist $\theta \in (0, 1)$ and $\varrho_0 > 0$, such that for all $x_0 \in \Gamma$ and every ball $B_\varrho(x_0)$ centered at x_0 with radius $\varrho \leq \varrho_0$

$$|\Omega \cap B_\varrho(x_0)| \leq (1 - \theta) |B_\varrho(x_0)| \quad (\text{A.1.1})$$

is satisfied.

For instance this property is fulfilled by any bounded, convex domain Ω . In this case $\theta = \frac{1}{2}$.

Let us proceed with another property of a domain Ω , which we will call SPECIAL POSITIVE GEOMETRIC DENSITY.

Definition A.1.3 (Special positive geometric density). Let $\Gamma \subseteq \partial\Omega$. We say that $\partial\Gamma$ satisfies the property of special positive geometric density, if there exist

(i) a $C^{0,1}$ domain M such that $\bar{\Omega} \subset \bar{M}$ and $\overline{\partial\Omega} \setminus \bar{\Gamma} \subset \partial M$,

(ii) two positive constants ϱ_0 and $\theta \in (0, 1)$ such that

for any ball $B_\varrho(x_0)$ centered at $x_0 \in \partial\Gamma$ with radius $0 < \varrho \leq \varrho_0$

$$|\Omega \cap B_\varrho(x_0)| \leq |M \cap B_\varrho(x_0)| - \theta |B_\varrho(x_0)| \quad (\text{A.1.2})$$

is satisfied.

An example for such a domain (c.f. Fig. A.1.1) is

$$\Omega := \left\{ (x, y) \in \mathbb{R}^2 : |(x, y)| < 1 \right\} \cap \left\{ (x, y) \in \mathbb{R}^2 : y < \frac{1}{2}x^2 + \frac{1}{2} \right\},$$

with

$$\Gamma := \left\{ (x, y) \in \mathbb{R}^2 : y = \frac{1}{2}x^2 + \frac{1}{2}, x \in [-1, 1] \right\},$$

$$\partial\Gamma := \{(-1, 0), (1, 0)\}$$

and

$$M = \left\{ (x, y) \in \mathbb{R}^2 : |(x, y)| < 1 \right\}, \quad \partial M = \left\{ (x, y) \in \mathbb{R}^2 : |(x, y)| = 1 \right\}.$$

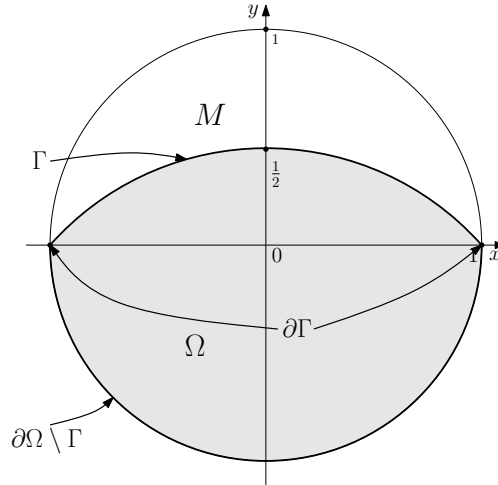

Figure A.1.1: Illustrative example of the special geometric density property

Then for any $0 < \varrho \leq 1$ and $x_0 \in \partial\Gamma$

$$|\Omega \cap B_\varrho(x_0)| \leq |M \cap B_\varrho(x_0)| - \frac{1}{24} |B_\varrho(x_0)|$$

holds.

Let us now introduce the so called CONE PROPERTY of a domain. We refer to [16, Definition 17.4].

Definition A.1.4 (The cone property). *Let $\mathcal{C}_0 \subset \mathbb{R}^N$ be a closed, circular, spherical cone of solid angle α , height h_0 , and vertex at the origin. Such a cone has the volume*

$$|\mathcal{C}_0| = \frac{\alpha}{N} h_0^N.$$

A domain Ω is said to have the cone property, if there exists some \mathcal{C}_0 such that for all $x \in \bar{\Omega}$ there exists a circular, spherical cone \mathcal{C}_x with vertex at x and congruent to \mathcal{C}_0 , all contained in $\bar{\Omega}$.

We now quote (see [29, Theorem 1.2.2.2]) the following result.

Proposition A.1.5. *Any bounded Lipschitz domain has the cone property.*

Let us prove an other property of domains possessing the cone property.

Lemma A.1.6. *Let $\Omega \subset \mathbb{R}^N$, $N \in \mathbb{N}$ open, bounded. If Ω possesses the cone property then there exist $\theta \in (0, 1)$ and $\varrho_0 > 0$, such that for all $x_0 \in \bar{\Omega}$ and every ball $B_\varrho(x_0)$ centered at x_0 with radius $\varrho \leq \varrho_0$*

$$|\Omega \cap B_\varrho(x_0)| \geq \theta |B_\varrho(x_0)| \tag{A.1.3}$$

holds.

Proof: Suppose that Ω has the cone property and let \mathcal{C}_0 be the cone of angle α and height h_0 as in Definition A.1.4. Let us take $\varrho_0 \leq h_0$.

For any $x_0 \in \bar{\Omega}$ and $0 < \varrho \leq \varrho_0$ we denote by $B_{\varrho_0}(x_0) \subset \mathbb{R}^N$ the ball $B_{\varrho_0}(x_0)$ centered at x_0 with radius ϱ_0 . In the case $B_{\varrho_0}(x_0) \subset \Omega$

$$|\Omega \cap B_{\varrho}(x_0)| = |B_{\varrho}(x_0)| \geq \theta |B_{\varrho_0}(x_0)|$$

is obviously satisfied for all $\theta \in (0, 1)$. Suppose that $B_{\varrho_0}(x_0) \not\subset \Omega$. Without restriction, we can assume that $x_0 \in \partial\Omega$. As Ω possesses the cone property, there exists a cone $\mathcal{C}_{x_0} \subset \bar{\Omega}$ with vertex x_0 and congruent to \mathcal{C}_0 . Then we clearly have

$$|B_{\varrho} \cap \Omega| \geq |B_{\varrho} \cap \text{int } \mathcal{C}_{x_0}| = \theta(\alpha) |B_{\varrho}|,$$

where $\theta(\alpha)$ depends only on the angle α . This finishes the proof. \square

A.2 Function Spaces

Let $\Omega \subset \mathbb{R}^N$, $N \in \mathbb{N}$. We assume that the definitions of the spaces of scalar functions on Ω are known, for example the spaces $C^0(\bar{\Omega})$, $L^p(\Omega)$, $L^p_{loc}(\Omega)$, and $W^{k,p}(\Omega)$ for all $k \in \mathbb{N}$, and all $p \in [1, +\infty]$, $k \leq p$.

For $T > 0$, we define by $\mathcal{F}(0, T)$ THE SET OF ALL MAPPINGS $u : [0, T] \rightarrow \mathbb{R}$ and by $BV(0, T)$ the SPACE OF FUNCTIONS WITH BOUNDED VARIATION. This is the space of all functions $u : [0, T] \rightarrow \mathbb{R}$ for which

$$\sup_{P \in \mathcal{P}} \sum_{i=0}^{n_P-1} |u(t_{i+1}) - u(t_i)| < \infty,$$

where the supremum is taken over the set $\mathcal{P} = \{P = \{t_0, \dots, t_{n_P}\}; P \text{ is a partition of } [0, T]\}$.

Furthermore, we denote by $C^1_0(\mathbb{R}^N)$ the SPACE OF CONTINUOUSLY DIFFERENTIABLE FUNCTIONS WITH COMPACT SUPPORT, by $C^0_r([0, T])$ the SPACE OF FUNCTIONS WHICH ARE CONTINUOUS ON THE RIGHT IN $[0, T)$ and set $G_+(0, T)$ to be THE SPACE OF RIGHT-CONTINUOUS REGULATED FUNCTIONS. This is the space of functions $u : [0, T] \rightarrow \mathbb{R}$, which admit the left limit $u(t_-)$ at each point $t \in [0, T)$. Defining the seminorm

$$\|u\|_{[0,t]} := \sup_{\tau \in [0,t]} |u(\tau)| \quad \text{for } u \in G_+(0, T) \text{ and } t \in [0, T],$$

we observe that $\|\cdot\|_{[0,T]}$ is a norm and $G_+(0, T)$ endowed with this norm is a Banach space.

Let Ω be a Lipschitz - domain in \mathbb{R}^N . We say that a function $u : \bar{\Omega} \rightarrow \mathbb{R}$ satisfies HÖLDER'S CONDITION with the exponent $\alpha \in (0, 1)$, and the Hölder constant $\langle u \rangle_{\alpha, \Omega}$ in the domain $\bar{\Omega}$, if

$$\langle u \rangle_{\alpha, \Omega} := \sup_{\substack{x, x' \in \Omega, \\ |x-x'| \leq \varrho_0}} \frac{|u(x) - u(x')|}{|x - x'|^\alpha} < \infty. \quad (\text{A.2.1})$$

We denote by $C^{0,\alpha}(\overline{\Omega})$ the space of HÖLDER CONTINUOUS FUNCTIONS, i.e. the space of functions which are continuous in $\overline{\Omega}$ with finite $\langle u \rangle_{\alpha,\Omega}$. Endowed with the norm

$$\|u\|_{C^{0,\alpha}(\overline{\Omega})} := \|u\|_{C^0(\overline{\Omega})} + \langle u \rangle_{\alpha,\Omega}$$

$C^{0,\alpha}(\overline{\Omega})$ is a Banach space.

Let $Q := \Omega \times (0, T)$. We say that a function $u : \overline{Q} \rightarrow \mathbb{R}$ satisfies the PARABOLIC HÖLDER CONDITION with the exponents $\alpha, \beta \in (0, 1)$, if for some fixed $0 < \varrho_0$

$$\langle u \rangle_{x,Q}^\alpha := \sup_{\substack{(x,t),(x',t') \in Q, \\ |x-x'| \leq \varrho_0}} \frac{|u(x,t) - u(x',t')|}{|x-x'|^\alpha} < \infty, \quad (\text{A.2.2a})$$

$$\langle u \rangle_{t,Q}^\beta := \sup_{\substack{(x,t),(x',t') \in Q, \\ |t-t'| \leq \varrho_0}} \frac{|u(x,t) - u(x',t')|}{|t-t'|^\beta} < \infty. \quad (\text{A.2.2b})$$

Moreover, we denoted by $C^{\alpha,\beta}(\overline{Q})$ the PARABOLIC HÖLDER SPACE, i.e. the space of functions which are continuous in \overline{Q} , with finite $\langle u \rangle_{x,Q}^\alpha$, and $\langle u \rangle_{t,Q}^\beta$. Endowed with the norm

$$\|u\|_{C^{\alpha,\beta}(\overline{Q})} := \|u\|_{C^0(\overline{Q})} + \langle u \rangle_{x,Q}^\alpha + \langle u \rangle_{t,Q}^\beta,$$

$C^{\alpha,\beta}(\overline{Q})$ is a Banach space.

Let us now quote the following well known theorem (see [10, Theorem 4.25]).

Theorem A.2.1 (Arzelà-Ascoli). *Let K be a compact metric space and let \mathcal{H} be a bounded subset of $C^0(K)$. Assume that \mathcal{H} is uniformly equicontinuous, that is*

$$\forall \varepsilon > 0 \exists \delta > 0 \text{ such that } d(x_1, x_2) < \delta \Rightarrow |f(x_1) - f(x_2)| < \varepsilon \quad \forall f \in \mathcal{H}.$$

Then the closure of \mathcal{H} in $C(K)$ is compact.

We prove an easy consequence of this theorem.

Proposition A.2.2. *Let $\Omega \subset \mathbb{R}^N$, $N \in \mathbb{N}$ open, bounded and $Q := \Omega \times (0, T)$.*

If a sequence $\{u_m\}_{m \in \mathbb{N}} \subset C^{\alpha, \frac{\alpha}{4}}(\overline{Q})$ satisfies

$$|u_m(x, t) - u_m(y, t)| \leq C |x - y|^\alpha \quad \text{for all } x, y \in \Omega, \text{ and all } t \in [0, T], \text{ and} \quad (\text{A.2.3a})$$

$$|u_m(x, t_1) - u_m(x, t_2)| \leq C |t_1 - t_2|^{\frac{\alpha}{4}} \quad \text{for all } t_1, t_2 \in [0, T], \text{ and all } x \in \Omega \quad (\text{A.2.3b})$$

with a constant $C > 0$ independent of m , then there exists $u \in C^{\alpha, \frac{\alpha}{4}}(\overline{Q})$, such that (up to a sequence) we have for $m \rightarrow \infty$

$$u_m \rightarrow u \quad \text{uniformly in } \overline{Q}.$$

Proof: By virtue of the boundedness of Q and (A.2.3), the sequence $\{u_m\}_{m \in \mathbb{N}}$ is equicontinuous and uniformly bounded in $C^0(\overline{Q})$. Thus, the Theorem of Arzelà-Ascoli A.2.1 yields the existence of a function $u \in C^0(\overline{Q})$ such that for $m \rightarrow \infty$ we have (up to a sequence)

$$u_m \rightarrow u, \quad \text{uniformly in } \overline{Q}.$$

Moreover, this convergence together with (A.2.3) implies that

$$u \in C^{\alpha, \frac{\alpha}{4}}(\overline{Q}).$$

□

For $\Omega \subset \mathbb{R}^N$, $N \geq 1$ and a Banach space B we denote by $\mathcal{S}(\Omega; B)$ the family of SIMPLE functions, namely functions with finite range such that the inverse image of any element of B is measurable.

We then introduce the space of BOCHNER MEASURABLE FUNCTIONS $\Omega \rightarrow B$ as follows

$$\mathcal{M}(\Omega; B) := \{v: \Omega \rightarrow B: \exists \{v_n \in \mathcal{S}(\Omega; B)\}_{n \in \mathbb{N}}, \text{ such that } v_n \rightarrow v \text{ strongly } B, \text{ a.e. } \Omega\}.$$

The BOCHNER SPACE OF CONTINUOUS FUNCTIONS is defined in the following way

$$C^0(\overline{\Omega}; B) := \{v \in \mathcal{M}(\Omega; B) : v \text{ is continuous}\}.$$

Together with the norm $\|v\|_{C^0(\overline{\Omega}; B)} := \max_{x \in \Omega} \|v\|_B$, $C^0(\overline{\Omega}; B)$ is a Banach space.

The BOCHNER-LEBESGUE SPACES

$$L^p(\Omega; B) := \left\{ v \in \mathcal{M}(\Omega; B) : \int_{\Omega} \|v\|_B^p dx < \infty \right\}, \quad p \in [1, \infty), \text{ and}$$

$$L^\infty(\Omega; B) := \{v \in \mathcal{M}(\Omega; B) : \text{ess sup}_{\Omega} \|v\|_B < \infty\}$$

are Banach spaces equipped with the norms

$$\|v\|_{L^p(\Omega; B)} := \left(\int_{\Omega} \|v\|_B^p \right)^{1/p} \quad \text{and} \quad \|v\|_{L^\infty(\Omega; B)} := \text{ess sup}_{\Omega} \|v\|_B.$$

If B is a Hilbert space, then also $L^2(\Omega; B)$ is a Hilbert space endowed with the scalar product

$$\langle u, v \rangle_{L^2(\Omega; B)} = \int_{\Omega} \langle u(x), v(x) \rangle_B dx.$$

If B is reflexive, then so are $L^p(\Omega; B)$ for $1 < p < \infty$, and if B is separable and $1 \leq p < \infty$ then the dual space of $L^p(\Omega; B)$ can be identified with $L^{\frac{p}{p-1}}(\Omega; B^*)$ in the following way

$$(L^p(\Omega; B))^* \langle u, v \rangle_{L^p(\Omega; B)} := \int_{\Omega} B^* \langle u(x), v(x) \rangle_B dx$$

for any $u \in L^{\frac{p}{p-1}}(\Omega; B^*)$ and $v \in L^p(\Omega; B)$.

For a multiindex $\alpha = (\alpha_1, \dots, \alpha_n) \in \mathbb{N}^n$ let $|\alpha| := \sum_{i=1}^n \alpha_i$ and

$$D^\alpha := \sum_{|\alpha|} \frac{\partial^{|\alpha|}}{\partial x_1 \cdots \partial x_N}.$$

We say that $v \in L^1_{loc}(\Omega; B)$ is the WEAK DERIVATIVE of a function $u \in L^1_{loc}(\Omega; B)$ of order α , and write $D^\alpha u$, if

$$\int_{\Omega} v\varphi \, dx = (-1)^{|\alpha|} \int_{\Omega} u D^\alpha \varphi \, dx$$

holds for all $\varphi \in C_0^\infty(\Omega)$. We denote by

$$W^{k,p}(\Omega; B) := \{v \in L^p(\Omega; B) : D^\alpha v \in L^p(\Omega; B), \forall \alpha, |\alpha| \leq k\} \quad \forall k \in \mathbb{N}, \forall p \in [1, +\infty],$$

the SOBOLEV SPACE of Banach space valued functions, where $D^\alpha v$ denotes the weak derivative of the function v .

Moreover, for $k \geq 1$ we set

$$H^k(\Omega; B) := W^{k,2}(\Omega; B).$$

If B is a Hilbert space, so is $H^k(\Omega; B)$.

We recall the following result for reflexive and separable Banach spaces (see. e.g [10, Theorem 3.18 and Corollary 3.30])

Theorem A.2.3. *Let B be a reflexive Banach space and $\{x_n\}_{n \in \mathbb{N}}$ a bounded sequence in B . Then there exists a subsequence of $\{x_n\}_{n \in \mathbb{N}}$ which converges weakly in B .*

If B is a separable Banach space and $\{x_n\}_{n \in \mathbb{N}}$ a bounded sequence in B^ , then there exists a subsequence of $\{x_n\}_{n \in \mathbb{N}}$ which converges weakly* in B^* .*

Moreover, we recover the following result (c.f [45, Chapter 4]).

Theorem A.2.4 (A compact embedding). *Let $\Omega \subset \mathbb{R}^N$, $N \geq 1$, be an open and bounded $C^{0,1}$ domain and $Q := \Omega \times (0, T)$. Then the embedding $H^1(Q) \hookrightarrow L^2(\Omega; C([0, T]))$ is continuous and compact.*

A.3 Kurzweil Integral

Following [41], we recall the definition of the Kurzweil integral, introduced in [42]. The basic concept of this theory is that of a δ -FINE PARTITION. Consider a closed interval $[a, b] \subset \mathbb{R}$, and denote by $\mathcal{D}_{a,b}$ the set of all divisions of the form

$$d = \{t_0, \dots, t_m\}, \quad a = t_0 < t_1 < \dots < t_m = b.$$

With a division $d = \{t_0, \dots, t_m\} \in \mathcal{D}_{a,b}$ we associate partitions D defined as

$$D = \{(\tau_j, [t_{j-1}, t_j]); j = 1, \dots, m\}; \quad \tau_j \in [t_{j-1}, t_j] \forall j = 1, \dots, m, \quad (\text{A.3.1})$$

and introduce the set

$$\Gamma(a, b) := \{\delta : [a, b] \rightarrow \mathbb{R}; \delta(t) > 0 \text{ for every } t \in [a, b]\}.$$

For $t \in [a, b]$ and $\delta \in \Gamma(a, b)$ we denote

$$I_\delta(t) := (t - \delta(t), t + \delta(t)),$$

and call a partition D of the form (A.3.1) δ -finite, if for every $j = 1, \dots, m$ we have

$$\tau_j \in [t_{j-1}, t_j] \subset I_\delta(\tau_j),$$

and the following implication holds

$$\tau_j = t_{j-1} \Rightarrow j = 1, \quad \tau_j = t_j \Rightarrow j = m.$$

The set of all δ -finite partitions is denoted by $\mathcal{F}_\delta(a, b)$.

For given functions $f, g : [a, b] \rightarrow \mathbb{R}$ and a partition D of the form (A.3.1), we define the KURZWEIL INTEGRAL SUM $K_D(f, g)$ by the formula

$$K_D(f, g) = \sum_{j=1}^m f(\tau_j)(g(t_j) - g(t_{j-1})).$$

Definition A.3.1 (Kurzweil Integral). *Let $f, g : [a, b] \rightarrow \mathbb{R}$ be given. We say that $J \in \mathbb{R}$ is the Kurzweil integral over $[a, b]$ of f w.r.t g , and denote*

$$J = \int_a^b f(t) dg(t),$$

if for every $\varepsilon > 0$ there exists $\delta \in \Gamma(a, b)$ such that for every $D \in \mathcal{F}_\delta(a, b)$ we have

$$|J - K_D(f, g)| \leq \varepsilon.$$

A.4 Remarks on Monotone Operators

The results of this section can be found for instance in [60].

Let X be a real and reflexive Banach-space, and $A : X \rightarrow X^*$. We denote by ${}_{X^*}\langle \cdot, \cdot \rangle_X$ the duality pairing between X and X^* . Then A is said to be

(i) MONOTONE, if and only if for any $u, v \in X$

$${}_{X^*}\langle Au - Av, u - v \rangle_X \geq 0,$$

(ii) STRICTLY MONOTONE, if and only if for any $u, v \in X$

$${}_{X^*}\langle Au - Av, u - v \rangle_X > 0,$$

(iii) CONTINUOUS if and only if for $n \rightarrow \infty$

$$u_n \rightarrow u \quad \text{in } X \quad \text{implies} \quad Au_n \rightarrow Au \quad \text{in } X^*,$$

(iv) BOUNDED if and only if A maps bounded subsets of X to bounded subsets of X^* .

We state the following generalization of the Browder-Minty Theorem (c.f. [60, Lemma 1.4(i), Lemma 2.6(i), (ii), and Theorem 3.51]).

Theorem A.4.1. *Let $C \neq \emptyset$ be a convex, closed subset of a reflexive and real Banach space X . Set $A : C \rightarrow X^*$ be a monotone, continuous and bounded operator satisfying for any $u_0 \in C$*

$$\lim_{\|u\| \rightarrow \infty, u \in C} \frac{X^* \langle Au, u - u_0 \rangle_X}{\|u\|_X} = \infty.$$

Then

(i) *For all $b \in X^*$ there exists a solution u of*

$$X^* \langle b - Au, u - v \rangle_X \geq 0, \quad \forall v \in C. \quad (\text{A.4.1})$$

(ii) *If in addition $A : C \rightarrow X^*$ is strictly monotone, then there exists a unique solution of (A.4.1) for any $b \in X^*$.*

A.5 Cut-Offs, Difference Quotients, and Steklov-Approximates

Let $\Omega \subset \mathbb{R}^N$, $N \in \mathbb{N}$. For a function $u \in L^q(\Omega)$, $q \geq 1$, we set for any $k \in \mathbb{R}$

$$u^{(k)} := \max \{u(x) - k, 0\}, \quad \text{and} \quad A_k := \{x \in \Omega : u(x) > k\}.$$

One can find the following Lemma in [43, Chapter 2, Lemma 4.2].

Lemma A.5.1. *Let $\Omega \subset \mathbb{R}^N$, $N \in \mathbb{N}$, open and bounded and let $u \in W^{1,m}(\Omega)$, $m \in \mathbb{N}$. Then for any $k \in \mathbb{R}$ the functions $u^{(k)}$ belong to $W^{1,m}(\Omega)$. Moreover, if $\sup_{\partial\Omega} u \leq k_0$, then for $k \geq k_0$ we have that $u^{(k)} \in W_0^{1,m}(\Omega)$.*

It is well known, that for PDEs the weak or classical differentiability of functions may often be deduced through a consideration of their difference quotients defined as follows.

Definition A.5.2. *Let $\Omega \subset \mathbb{R}^N$, $N \in \mathbb{N}$, and let \vec{e}_i be the unit coordinate vector in the x_i direction. We define the difference quotient in the direction \vec{e}_i by*

$$D_h^i u(x) := \frac{u(x + he_i) - u(x)}{h}, \quad h \neq 0. \quad (\text{A.5.1})$$

The following basic lemmas refer to difference quotients of functions in Sobolev spaces and can be found in [27, Section 7.11]

Lemma A.5.3. Let $\Omega \subset \mathbb{R}^N$, $N \in \mathbb{N}$, open and bounded, $u \in L^p(\Omega)$, $1 < p < \infty$, and suppose that there exists a constant K such that for $i \in \{1, \dots, n\}$ the difference quotients $D_h^i u$ belong to $L^p(\Omega')$ and $\|D_h^i u\|_{L^p(\Omega')} \leq K$ hold for all $h > 0$ and any compact subset Ω' of Ω satisfying $h \leq \text{dist}(\Omega', \partial\Omega)$. Then the weak partial derivative $\partial_i u$ exists and satisfies $\|\partial_i u\|_{L^p(\Omega)} \leq K$.

Lemma A.5.4. Let $\Omega \subset \mathbb{R}^N$, $N \in \mathbb{N}$, open and bounded, $u \in W^{1,p}(\Omega)$, $1 < p < \infty$. Then for all $i \in \{1, \dots, n\}$ the difference quotients $D_h^i u$ belong to $L^p(\Omega')$ for any compact subset Ω' of Ω satisfying $h \leq \text{dist}(\Omega', \partial\Omega)$, and we have

$$\|D_h^i u\|_{L^p(\Omega')} \leq \|\partial_i u\|_{L^p(\Omega)}.$$

Let us state the well known result for "partial integration" with difference quotients

Lemma A.5.5. Let $\Omega \subset \mathbb{R}^N$, $N \in \mathbb{N}$, open and bounded, $u \in L^p(\Omega)$ and $v \in L^q(\Omega)$, and $1 < p, q < \infty$ satisfying $\frac{1}{p} + \frac{1}{q} = 1$. Then for any compact subset Ω' of Ω and $h \leq \text{dist}(\Omega', \partial\Omega)$ we have

$$\int_{\Omega'} u(x) D_h^i v(x) dx = - \int_{\Omega'} D_h^i u(x) v(x) dx.$$

Finally, we state an easy consequence of the previous results.

Lemma A.5.6. Let $\Omega \subset \mathbb{R}^N$, $N \in \mathbb{N}$, $T > 0$, and $u \in L^p((0, T) \times \Omega)$ with $1 < p < \infty$. For $h > 0$ we define the function $u_h : \Omega \times [0, T - h] \rightarrow \mathbb{R}$ by

$$u_h(x, t) := \frac{1}{h} \int_t^{t+h} u(x, \tau) d\tau, \quad \text{for a.a. } (x, t) \in \Omega \times [0, T - h].$$

If there exists a constant K , independent of h such that $\|\dot{u}_h\|_{L^p(\Omega \times [0, T-h])} \leq K$, then the weak partial derivative \dot{u} exists and satisfies $\|\dot{u}\|_{L^p(\Omega \times (0, T))} \leq K$.

If on the other hand $u \in W^{1,p}(0, T; L^p(\Omega))$, $1 < p < \infty$. Then $\dot{u}_h \in L^p(\Omega \times (0, T - h))$, and we have

$$\|\dot{u}_h\|_{L^p(\Omega \times (0, T-h))} \leq \|\dot{u}\|_{L^p(\Omega \times (0, T))}.$$

A.6 Interpolation Inequalities

In this section we recall basic interpolation inequalities. We refer to [43, Chapter 2, §3]

Proposition A.6.1.

Let $T > 0$, $\Omega \subset \mathbb{R}^N$, $N \in \mathbb{N}$ open and bounded, and let $u \in L^\infty(0, T; L^2(\Omega)) \cap L^2(0, T; H^1(\Omega))$. Then for any q, r and $N > 2$ satisfying

$$\frac{1}{r} + \frac{N}{2q} = \frac{N}{4}, \quad r \in [2, \infty], \quad q \in \left[2, \frac{2N}{N-2}\right]$$

there exists a constant β such that the following inequality is satisfied

$$\|u\|_{L^r(0, T; L^q(\Omega))} \leq \beta \left[\|u\|_{L^\infty(0, T; L^2(\Omega))} + \|\nabla u\|_{L^2(\Omega \times (0, T))} \right].$$

Proposition A.6.2. Let $T > 0$, $\Omega \subset \mathbb{R}^N$, $N \in \mathbb{N}$ be open and bounded and $u \in L^r(0, T; L^q(\Omega))$ with $r, q \geq 1$. Then for any $r_1 \in [1, r]$ and any $q_1 \in [1, q]$

$$\|u\|_{L^{r_1}(0, T; L^{q_1}(\Omega))} \leq \left(\int_0^T |\Omega|^{\frac{r}{q}} dt \right)^{\frac{r-r_1}{r r_1}} \|u\|_{L^r(0, T; L^q(\Omega))}$$

holds.

A.7 Additional Results

The results presented in this section can be found in [43, Chapter 2, §5] and in [44, Chapter 2, §3]. We start recalling the following algebraic lemma (cf. [43, Chapter 2, Lemma 5.6]).

Lemma A.7.1. Assume that for a sequence $\{y_h\}_{h \in \mathbb{N}} \subseteq \mathbb{R}_0^+$

$$y_{h+1} \leq c b^h y_h^{1+\epsilon} \quad \text{for } h = 0, 1, \dots,$$

with some positive constants c, ϵ and $b \geq 1$.

Then

$$y_h \leq c^{\frac{(1+\epsilon)^h - 1}{\epsilon}} b^{\frac{(1+\epsilon)^h - 1}{\epsilon^2} - \frac{h}{\epsilon}} y_0^{(1+\epsilon)^h}$$

holds. In particular, if

$$y_0 \leq \theta := c^{-1/\epsilon} b^{-1/\epsilon^2} \quad \text{and } b > 1,$$

then

$$y_h \leq \theta b^{-h/\epsilon}$$

and therefore $y_h \rightarrow 0$ with $h \rightarrow \infty$.

Let us present the following lemma (cf. [44, Chapter 2, Lemma 3.9, and Remark 3.3]).

Lemma A.7.2. Let $\Omega \subset \mathbb{R}^N$, $N \in \mathbb{N}$ be an open, bounded domain and $B_\varrho(x_0) \subset \mathbb{R}^N$ be a ball centered at $x_0 \in \bar{\Omega}$ with radius ϱ and suppose that $B_\varrho \cap \Omega$ is convex. Then for any function $u \in W^{1,1}(B_\varrho \cap \Omega)$ and $k, l \in \mathbb{R}$ with $l > k$ the following estimate holds

$$(l - k) |\{x \in B_\varrho \cap \Omega : u(x) > l\}|^{1-\frac{1}{N}} \leq \beta \frac{\varrho^N}{|\{B_\varrho(x_0) \cap \Omega : u(x) \leq k\}|} \int_{\{B_\varrho(x_0) \cap \Omega : k < u(x) \leq l\}} |\nabla u| dx,$$

with $\beta := \frac{2^N}{N}(\omega_N + 1)$, where ω_N denotes the surface of the unit ball in \mathbb{R}^N .

As a consequence we also have the following result (see [43, Chapter 2, inequality (5.5)]).

Corollary A.7.3. Let $\Omega \subset \mathbb{R}^N$, $N \in \mathbb{N}$ be an open, bounded domain, and $B_\varrho(x_0) \subset \mathbb{R}^N$ be a ball centered at $x_0 \in \bar{\Omega}$ with radius ϱ , and suppose that $B_\varrho \cap \Omega$ is convex. Then for any function $u \in W^{1,1}(B_\varrho \cap \Omega)$ and $k, l \in \mathbb{R}$ with $l > k$

$$(l - k) |\{x \in B_\varrho \cap \Omega : u(x) > l\}| \leq \beta_1 \frac{\varrho^{N+1}}{|\{B_\varrho(x_0) \cap \Omega : u(x) \leq k\}|} \int_{\{B_\varrho(x_0) \cap \Omega : k < u(x) \leq l\}} |\nabla u| dx$$

holds, where $\beta_1 = \beta |B_1|^{\frac{1}{N}}$ and β as in Lemma A.7.2.

The following Lemma is very useful while proving Hölder-continuity of a function $u \in H^1(\Omega)$, and can be found in [44, Ch. 2, Lemma 4.8].

Lemma A.7.4. *Let $\Omega \subset \mathbb{R}^N$, $N \in \mathbb{N}$, $\varrho_0 > 0$, $x_0 \in \overline{\Omega}$, and $B_{\varrho_0}(x_0) \subset \mathbb{R}^N$ be a ball centered at x_0 with radius ϱ_0 .*

Let $b > 1$ be a fixed number, and consider concentric balls $B_\varrho(x_0)$, and $B_{b\varrho}(x_0)$ centered at x_0 with radius ϱ , and $b\varrho$ resp..

Let $u : \Omega \rightarrow \mathbb{R}$ be measurable function, which is bounded in $B_{\varrho_0}(x_0) \cap \Omega$ and suppose that for any radius $\varrho \leq \frac{\varrho_0}{b}$ the function u satisfies either

$$\text{osc} \{u, B_\varrho(x_0) \cap \Omega\} \leq c_1 \varrho^\nu,$$

or

$$\text{osc} \{u, B_\varrho(x_0) \cap \Omega\} \leq \eta \text{osc} \{u, B_{b\varrho}(x_0) \cap \Omega\}$$

with some positive $c_1, \nu \leq 1$ and $\eta < 1$. Then for $\varrho \leq \varrho_0$

$$\text{osc} \{u, B_\varrho(x_0) \cap \Omega\} \leq c \left(\frac{\varrho}{\varrho_0} \right)^\alpha,$$

holds, where

$$\alpha = \min \{-\ln_b \eta, \nu\}, \quad c = b^\alpha \max \{c_1 \varrho_0^\nu; \text{osc} \{u, B_{\varrho_0}(x_0) \cap \Omega\}\}$$

A similar result holds for the space time dependent case and can be found in [43, Ch. 2, Lemma 5.8].

Lemma A.7.5. *Let $\Omega \subset \mathbb{R}^N$, $N \in \mathbb{N}$, and $Q := \Omega \times (0, T)$.*

Let $\varrho_0 > 0$, $x_0 \in \overline{\Omega}$, $t_0 \in (0, T]$ and $\theta_0 > 0$, and we denote by $B_\varrho(x_0) \subset \mathbb{R}^N$ a ball centered at x_0 with radius $\varrho \leq \varrho_0$ and by Q_ϱ a local parabolic cylinder of the form

$$Q_\varrho := B_\varrho(x_0) \times (t_0 - \theta_0 \varrho^2, t_0).$$

for $\varrho \leq \varrho_0$. Assume that a measurable function $u(x, t)$ is bounded in $Q_{\varrho_0} \cap Q$ and suppose that for a fixed $b > 1$ and for any $\varrho \leq b^{-1} \varrho_0$ the function u satisfies either

$$\text{osc} \{u, Q_\varrho \cap Q\} \leq c_1 \varrho^\nu,$$

or

$$\text{osc} \{u, Q_\varrho \cap Q\} \leq \eta \text{osc} \{u, Q_{b\varrho}\}$$

with some positive $c_1, \nu \leq 1$ and $\eta < 1$. Then for $\varrho \leq \varrho_0$

$$\text{osc} \{u, Q_\varrho \cap Q\} \leq c \varrho_0^{-1} \varrho^\alpha$$

holds, where

$$\alpha = \min \{-\ln_b \eta, \nu\}, \quad c = b^\alpha \max \{\omega_0, c_1 \varrho_0^\nu\}, \quad \omega_0 = \text{osc} \{u, Q_{\varrho_0} \cap Q\}$$

A.8 De Giorgi - Type Classes

In this section we present a unified treatment of embeddings of De Giorgi elliptic and parabolic classes into Hölder spaces. Our result covers in particular the case of a mixed space boundary, where we deal with functions satisfying a Neumann condition on one part of the space boundary and a Signorini type condition on its complement. To our knowledge there is no literature handling this particular situation. In general, we follow ideas from [43, 44], where the case of boundary regularity (for Neumann or Dirichlet boundary) is briefly mentioned, and provide clear and complete proofs. We restrict ourselves to the case of three space dimensions, although the presented proofs hold in higher space dimensions as well (with slight modifications of the constants).

A.8.1 An Elliptic De Giorgi Class

At this point we establish analytical results which allow us to conclude Hölder continuity of solutions to a various class of elliptic problems. We present a criterion in the form of an integral inequality and show that $H^1(\Omega)$ functions fulfilling this inequality also satisfy Hölder's condition. The first result of this kind was established by De Giorgi in [28]. In our proofs we proceed following the arguments of [44, Chapter 2, §6] and extend the proofs also to the case when our functions satisfy a Neumann condition on one part of the boundary and a Signorini type condition on its complement.

In order to do this we need to pose the following assumption on the domain $\Omega \subset \mathbb{R}^3$.

Assumption A.8.1 (Assumption on Ω). *Let $\Omega \subset \mathbb{R}^3$ be an open, bounded, and convex domain of class $C^{0,1}$ and suppose that there exist a closed two-dimensional manifold $\Gamma \subset \partial\Omega$, a closed two-dimensional manifold $\Gamma' \subset \Gamma$ (both with positive bidimensional measure), and positive constants $\varrho_0, \delta_1, \delta_2, \delta_3 \in (0, 1)$ such that*

- (i) *for all $x_0 \in \partial\Omega$ and any ball $B_\varrho(x_0)$ centered at x_0 with radius $0 < \varrho \leq \varrho_0$, $\Omega \cap B_\varrho(x_0)$ is convex and*

$$|\Omega \cap B_\varrho(x_0)| \geq \delta_1 |B_\varrho(x_0)|,$$

holds. (In fact the latter inequality is satisfied by virtue of Lemma A.1.6 as Ω is of class $C^{0,1}$ and thus possesses the cone property).

- (ii) *$\text{int}\Gamma$ possesses the positive geometrical density property, i.e. for all $x_0 \in \text{int}\Gamma$ and any ball $B_\varrho(x_0)$ centered at x_0 with radius $0 < \varrho \leq \varrho_0$*

$$|\Omega \cap B_\varrho(x_0)| \leq (1 - \delta_2) |B_\varrho(x_0)|$$

is satisfied.

(iii) $\partial\Gamma$ and $\partial\Gamma'$ possess the special positive geometric density property, i.e.

(a) there exists a $C^{0,1}$ domain $\tilde{\Omega}$, such that $\bar{\Omega} \subset \bar{\tilde{\Omega}}$ and $\overline{\partial\Omega \setminus \Gamma} \subset \partial\tilde{\Omega}$, such that for any ball $B_\varrho(x_0)$ centered at $x_0 \in \partial\Gamma$ with radius $0 < \varrho \leq \varrho_0$, $\tilde{\Omega} \cap B_\varrho(x_0)$ is convex and

$$|\Omega \cap B_\varrho(x_0)| \leq \left| \tilde{\Omega} \cap B_\varrho(x_0) \right| - \delta_3 |B_\varrho(x_0)|$$

holds,

(b) there exists a $C^{0,1}$ domain $\tilde{\Omega}'$, such that $\bar{\Omega} \subset \bar{\tilde{\Omega}'}$ and $\overline{\partial\Omega \setminus \Gamma'} \subset \partial\tilde{\Omega}'$, such that for any ball $B_\varrho(x_0)$ centered at $x_0 \in \partial\Gamma'$ with radius $0 < \varrho \leq \varrho_0$, $\tilde{\Omega}' \cap B_\varrho(x_0)$ is convex and

$$|\Omega \cap B_\varrho(x_0)| \leq \left| \tilde{\Omega}' \cap B_\varrho(x_0) \right| - \delta_3 |B_\varrho(x_0)|$$

are satisfied.

An illustrative example of such a domain is depicted in Fig. 3.1.

For given positive numbers M , γ , and $\varrho_0 > 0$ we define the following class of functions.

Definition A.8.2 ($\check{B}_2(\bar{\Omega}, M, \gamma)$). For Ω satisfying Assumption A.8.1, we say that a function $u(x) \in H^1(\Omega)$ belongs to the class $\check{B}_2(\bar{\Omega}, M, \gamma)$ (cf. [44, Class $\mathcal{B}_2(\Omega, M, \gamma, \gamma, 2, \frac{1}{6})$ in Ch. 2, §6]), if u satisfies the following conditions.

$$\textcircled{1} \|u\|_{L^\infty(\Omega)} \leq M \tag{A.8.1.1}$$

$\textcircled{2}$ The functions $w = \pm u$ satisfy the following inequality

$$\int_{\{x \in B_{(1-\sigma)\varrho}(x_0) \cap \Omega : u > k\}} |\nabla w|^2 dx \leq \gamma \left(\sigma^{-2} \varrho^{-1} \sup_{\{x \in B_\varrho(x_0) \cap \Omega : u > k\}} (w(x) - k)^2 + 1 \right) |\{x \in B_\varrho(x_0) \cap \Omega : u > k\}|^{\frac{2}{3}}, \tag{A.8.1.2}$$

in which $B_\varrho(x_0) \subset \mathbb{R}^3$ is any ball centered at $x_0 \in \bar{\Omega}$ with $0 < \varrho \leq \varrho_0$, σ is any positive number from the interval $(0, 1)$, and k is an arbitrary number subject only to the conditions

$$k \geq \sup_{B_\varrho(x_0) \cap \Omega} w - 2M, \tag{A.8.1.3a}$$

and

$$\diamond \text{ if } w = u : \quad k \geq \sup_{B_\varrho(x_0) \cap \Gamma'} (\gamma_0 u)^+, \tag{A.8.1.3b}$$

$$\diamond \text{ if } w = -u : \quad k \geq \sup_{B_\varrho(x_0) \cap \Gamma} -(\gamma_0 u)^+, \tag{A.8.1.3c}$$

with the classical convention that $\sup_\emptyset u = -\infty$ and with Γ and Γ' as in Assumption A.8.1.

In the following we prove that $\check{B}_2(\bar{\Omega}, M, \gamma)$ is continuously embedded into $C^{0,\alpha}(\bar{\Omega})$, provided that the boundary data is smooth enough and Ω satisfies Assumption A.8.1. Proceeding as in [44, Chapter 2, §6,7] we first establish a sequence of Lemmata, necessary to obtain the result stated in Theorem A.8.7.

Let us start with the proof of the following result, which is an extension of [44, Chapter 6, Lemma 6.2]

Lemma A.8.3. *Suppose that $\Omega \subset \mathbb{R}^3$ satisfies Assumption A.8.1. Let $x_0 \in \bar{\Omega}$ and denote by $B_\varrho(x_0) \subset \mathbb{R}^3$ the ball centered at x_0 with radius $0 < \varrho \leq \varrho_0$ and $\varrho_0 > 0$ as in Assumption A.8.1. Let $w \in H^1(\Omega)$ and suppose that with some $\gamma > 0$*

$$\int_{\{x \in B_{(1-\sigma)\varrho}(x_0) \cap \Omega\} : k < w(x) \leq l} |\nabla w|^2 dx \leq \gamma \left(\sigma^{-2} \varrho^{-1} \sup_{\{x \in B_\varrho(x_0) \cap \Omega\} : w(x) > k} (w - k)^2 + 1 \right) |\{x \in B_\varrho(x_0) \cap \Omega : w > k\}|^{\frac{2}{3}} \quad (\text{A.8.1.4})$$

is satisfied for all $\sigma \in (0, 1)$, $0 < \varrho$ with $\frac{\varrho_0}{4} \leq (1 - \sigma)\varrho \leq \varrho \leq \frac{\varrho_0}{2}$, and any

$$k \in \left[k_0, k_0 + \frac{H}{2} \right], \quad H := \sup_{B_\varrho(x_0) \cap \Omega} w - k_0, \quad l \in \left[k, \frac{1}{2} \left(k + \sup_{B_\varrho(x_0) \cap \Omega} w \right) \right]$$

for some given level $k_0 \in \mathbb{R}$.

Then, setting

$$\theta := \min \left\{ \frac{\delta_1}{2^7} |B^1|; 4^{-90} \left(\frac{\beta \gamma^{\frac{1}{2}}}{\delta_1 |B^1|} \right)^{-6} \right\},$$

where δ_1 is as in Assumption A.8.1(i) and $|B^1|$ denotes the volume of the unit ball in \mathbb{R}^3 , either

$$\textcircled{1} \quad H := \sup_{B_{\varrho_0}(x_0) \cap \Omega} w - k_0 \leq \varrho_0^{\frac{1}{2}}, \quad \text{or} \quad (\text{A.8.1.5a})$$

$$\textcircled{2} \quad \sup_{B_{\frac{\varrho_0}{4}}(x_0) \cap \Omega} w \leq k_0 + \frac{H}{2} \quad (\text{A.8.1.5b})$$

is satisfied, provided that

$$\left| \{x \in B_{\frac{\varrho_0}{2}}(x_0) \cap \Omega : w > k_0\} \right| \leq \theta \varrho_0^3 \quad (\text{A.8.1.6})$$

holds.

Proof: Our proof is almost identical to the proof of [44, Chapter 2, Lemma 6.2].

Let $x_0 \in \bar{\Omega}$, $w \in H^1(\Omega)$, $\varrho_0 > 0$, and $k_0 \in \mathbb{R}$ satisfying the conditions of the Lemma. Let us consider the sequence of concentric balls $\{B_h\}_{h \in \{0,1,\dots\}}$ centered at x_0 with radii ϱ_h , defined by

$$B_h := B_{\varrho_h}(x_0), \quad \text{with} \quad \varrho_h := \frac{\varrho_0}{4} + \frac{\varrho_0}{2^{h+2}}, \quad h = 0, 1, \dots,$$

and the sequence $\{\sigma_h\}_{h \in \{0,1,\dots\}} \subset (0,1)$,

$$\sigma_h := \frac{1}{2(2^h + 1)}, \quad h = 0, 1, \dots \quad (\text{A.8.1.7})$$

Computing that

$$(1 - \sigma_h)\varrho_h = \varrho_{h+1} \quad h = 0, 1, \dots$$

holds for all $h = 0, 1, \dots$, and introducing the sequence $\{k_h\}_{h \in \{0,1,\dots\}}$ of increasing levels defined by

$$k_h := k_0 + \frac{H}{2} - \frac{H}{2^{h+1}}, \quad h = 0, 1, \dots$$

with $H := \sup_{B_{\varrho_0}(x_0) \cap \Omega} w - k_0$, we find from (A.8.1.4) with the choice $\varrho = \varrho_h$, $\sigma = \sigma_h$, $k = k_h$, and $l = k_{h+1}$ for all $h \geq 0$ the following inequality

$$\begin{aligned} & \int_{\{x \in B_{h+1} \cap \Omega : k_h < w \leq k_{h+1}\}} |\nabla w|^2 dx \\ & \leq \gamma \left(\sigma_h^{-2} \varrho_h^{-1} \sup_{\{x \in B_h \cap \Omega : w > k_h\}} (w(x) - k_h)^2 + 1 \right) |\{x \in B_h \cap \Omega : w > k_h\}|^{\frac{2}{3}}. \end{aligned} \quad (\text{A.8.1.8})$$

By construction

$$k_{h+1} \geq k_h, \quad H \geq \sup_{B_h \cap \Omega} w - k_h, \quad \text{and} \quad \sigma_h^{-2} \leq 2^{2(h+3)}$$

hold, and therefore (A.8.1.8) turns into

$$\int_{\{x \in B_{h+1} \cap \Omega : k_h < w \leq k_{h+1}\}} |\nabla w|^2 dx \leq \gamma \left[2^{2(h+3)} \varrho_0^{-1} H^2 + 1 \right] |\{x \in B_h \cap \Omega : w > k_h\}|^{\frac{2}{3}}. \quad (\text{A.8.1.9})$$

Suppose now that (A.8.1.5a) does not hold. Thus,

$$H = \sup_{B_{\varrho_0} \cap \Omega} w - k_0 > \varrho_0^{\frac{1}{2}}$$

must hold, and consequently

$$1 < \varrho_0^{-1} H^2 \quad (\text{A.8.1.10})$$

follows. Setting for $h \geq 0$

$$\mathcal{D}_{h+1} := \{x \in B_{h+1} \cap \Omega : k_h < w \leq k_{h+1}\}$$

and observing that

$$|\mathcal{D}_{h+1}| \leq |\{x \in B_h \cap \Omega : w > k_h\}| \quad (\text{A.8.1.11})$$

holds, we find with the help of Hölder's inequality, (A.8.1.9), (A.8.1.10), and (A.8.1.11)

$$\int_{\mathcal{D}_{h+1}} |\nabla w| dx \leq \left(\int_{\mathcal{D}_{h+1}} |\nabla w|^2 dx \right)^{\frac{1}{2}} |\mathcal{D}_{h+1}|^{\frac{1}{2}} \leq \gamma^{\frac{1}{2}} \varrho_0^{-\frac{1}{2}} H 2^{h+6} |\{x \in B_h \cap \Omega : u > k_h\}|^{\frac{5}{6}}. \quad (\text{A.8.1.12})$$

Introducing the sequence $\{z_h\}_{h \in \{0,1,2,\dots\}}$ defined by

$$z_h := |\{x \in B_h \cap \Omega : w > k_h\}|,$$

we find by virtue of Lemma A.7.2 with the choices $k = k_h, l = k_{h+1}$, and $\varrho = \varrho_h$, and making use of (A.8.1.12)

$$\begin{aligned} \frac{1}{2^{h+2}} H z_{h+1}^{\frac{2}{3}} &\leq \beta \frac{\varrho_h^3}{|\{x \in B_h \cap \Omega : w \leq k_h\}|} \int_{\mathcal{D}_{h+1}} |\nabla w| \, dx \\ &\leq \beta \frac{\varrho_h^3}{|\{x \in B_h \cap \Omega : w \leq k_h\}|} \gamma^{\frac{1}{2}} \varrho_0^{-\frac{1}{2}} H 2^{h+6} z_h^{\frac{5}{6}}, \end{aligned}$$

where the constant β is as in Lemma A.7.2. Hence

$$z_{h+1}^{\frac{2}{3}} \leq 4^{h+4} \beta \gamma^{\frac{1}{2}} \frac{\varrho_0^3}{\varrho_0^{\frac{1}{2}} |\{x \in B_h \cap \Omega : w \leq k_h\}|} z_h^{\frac{5}{6}} \quad (\text{A.8.1.13})$$

is satisfied. Let us denote by $|B^1|$ the volume of the unit ball in \mathbb{R}^3 . Bearing in mind that (A.8.1.6) holds and that by assumption $\theta \leq \frac{\delta_1}{2_* 4^3} |B^1|$, $\varrho_h \leq \frac{\varrho_0}{2}$, and $k_h \geq k_0$ for all $h \geq 0$, we obtain

$$|\{x \in B_h \cap \Omega : w > k_h\}| \leq \left| \left\{ x \in B_{\frac{\varrho_0}{2}}(x_0) \cap \Omega : w > k_0 \right\} \right| \leq \theta \varrho_0^3 \leq \frac{\delta_1}{2} \left| B_{\frac{\varrho_0}{4}}(x_0) \right|.$$

On the other hand, Assumption A.8.1 (i) together with $\varrho_h \geq \frac{\varrho_0}{4}$ yields that

$$|B_h \cap \Omega| \geq \left| B_{\frac{\varrho_0}{4}}(x_0) \cap \Omega \right| \geq \delta_1 \left| B_{\frac{\varrho_0}{4}}(x_0) \right|$$

is satisfied. Therefore,

$$|\{x \in B_h \cap \Omega : w \leq k_h\}| = |B_h \cap \Omega| - |\{x \in B_h \cap \Omega : w > k_h\}| \geq \frac{\delta_1}{2} \left| B_{\frac{\varrho_0}{4}}(x_0) \right| = \frac{\delta_1}{2} \frac{\varrho_0^3}{4^3} |B^1|$$

holds, and we obtain from (A.8.1.13)

$$z_{h+1}^{\frac{2}{3}} \leq 4^{h+4} \beta \gamma^{\frac{1}{2}} \frac{2}{\delta_1} \frac{4^3}{\varrho_0^{\frac{1}{2}} |B^1|} z_h^{\frac{5}{6}} \leq \left(2 \frac{4^7 \beta \gamma^{\frac{1}{2}}}{\delta_1 |B^1| \varrho_0^{\frac{1}{2}}} \right) 4^h z_h^{\frac{5}{6}}.$$

Recalling that by construction $z_{h+1} \leq z_h$, we infer multiplying the preceding inequality by $z_{h+1}^{\frac{1}{3}}$

$$z_{h+1} \leq \left(2 \frac{4^7 \beta \gamma^{\frac{1}{2}}}{\delta_1 |B^1| \varrho_0^{\frac{1}{2}}} \right) 4^h z_h^{\frac{7}{6}}.$$

Moreover, as $\varrho_{h+1} = (1 - \sigma_h) \varrho_h \leq \varrho_h \leq \varrho_0$ and $\frac{1}{1 - \sigma_h} \leq 2$, we conclude

$$\varrho_0^{-\frac{1}{2}} \leq \varrho_h^{-\frac{1}{2}} = \varrho_h^{3 - \frac{7}{2}} = (\varrho_h^{-3})^{\frac{7}{6}} (1 - \sigma_h)^{-3} \varrho_{h+1}^3 \leq 2^3 (\varrho_h^{-3})^{\frac{7}{6}} \varrho_{h+1}^3.$$

Thus,

$$\frac{z_{h+1}}{\varrho_{h+1}^3} \leq \left(\frac{4^9 \beta \gamma^{\frac{1}{2}}}{\delta_1 |B^1|} \right) 4^h \left(\frac{z_h}{\varrho_h^3} \right)^{\frac{7}{6}}$$

follows. Observing that the conditions of the Lemma yield

$$z_0 \leq \theta \varrho_0^3 \leq 4^{-90} \left(\frac{\beta \gamma^{\frac{1}{2}}}{\delta_1 |B^1|} \right)^{-6} \varrho_0^3,$$

application of Lemma A.7.1 implies that $\frac{z_h}{\varrho_h^3}$ converges to 0 as $h \rightarrow \infty$. This yields in particular

$$\frac{z_\infty}{\varrho_\infty^3} = \frac{4^3 \left| \left\{ x \in B_{\frac{\varrho_0}{4}}(x_0) \right\} \cap \Omega : w > k_0 + \frac{H}{2} \right|}{\varrho_0^3} = 0$$

and (A.8.1.5b) follows. \square

Let us proceed with our next result, which is a generalized version of [44, Chapter 2, Lemma 6.3]

Lemma A.8.4. *Let $\Omega \subset \mathbb{R}^3$ satisfy Assumption A.8.1, $k' \in \mathbb{R}$, $x_0 \in \overline{\Omega}$, and $B_\varrho(x_0)$ be the ball centered at x_0 with radius $0 < \varrho \leq \varrho_0$ and ϱ_0 as in Assumption A.8.1.*

Let $w \in H^1(\Omega)$ and assume that there exist γ and $\epsilon_0 > 0$, such that

$$\left| \left\{ x \in B_{\frac{\varrho_0}{2}}(x_0) \cap \Omega : w \leq k' \right\} \right| \geq \epsilon_0 \left| B_{\frac{\varrho_0}{2}}(x_0) \right| \quad (\text{A.8.1.14})$$

holds and

$$\begin{aligned} & \int_{\{x \in B_{(1-\sigma)\varrho}(x_0) \cap \Omega\} : k < w(x) \leq l} |\nabla w|^2 dx \\ & \leq \gamma \left(\sigma^{-2} \varrho^{-1} \sup_{B_\varrho(x_0) \cap \Omega} (w - k)^2 + 1 \right) \left| \{x \in B_\varrho(x_0) \cap \Omega : w > k\} \right|^{\frac{2}{3}} \end{aligned} \quad (\text{A.8.1.15})$$

are satisfied for any $\sigma \in (0, 1)$ and any $\varrho > 0$ with $\frac{\varrho_0}{4} \leq (1 - \sigma)\varrho \leq \varrho \leq \varrho_0$, and levels k, l subject to

$$k \in [k', k''], \quad l \in \left[k, \frac{1}{2} \left(k + \sup_{B_{\varrho_0}(x_0) \cap \Omega} w \right) \right],$$

where

$$\omega := \sup_{B_{\varrho_0}(x_0) \cap \Omega} w - k' \quad \text{and} \quad k'' \geq \sup_{B_{\varrho_0}(x_0) \cap \Omega} w - \frac{\omega}{2^s},$$

with

$$s := 2 + \frac{4\gamma\beta^2}{\theta^{\frac{4}{3}} \epsilon_0^2 |B^1|^{\frac{1}{3}}},$$

β as in Lemma A.7.2, θ as in Lemma A.8.3 and $|B^1|$ denotes the volume of the unit ball in \mathbb{R}^3 .

Then, setting $k^ := \sup_{B_{\varrho_0}(x_0) \cap \Omega} w - \frac{\omega}{2^{s-1}}$ the following estimate holds*

$$\left| \left\{ x \in B_{\frac{\varrho_0}{2}}(x_0) \cap \Omega : w(x) > k^* \right\} \right| \leq \theta \varrho_0^3, \quad (\text{A.8.1.16})$$

provided that

$$\omega > 2^s \varrho_0^{\frac{1}{2}}.$$

Proof: With the number s as in the conditions of the Lemma and following the proof of [44, Chapter 2, Lemma 6.3], we consider the sequences

$$\{k_t\}_{t=0,1,\dots,s-1} \quad \text{and} \quad \{\mathcal{D}_t\}_{t=0,1,\dots,s-1}$$

defined by

$$k_t := \sup_{B_{\varrho_0}(x_0) \cap \Omega} w - \frac{\omega}{2^t}, \quad \mathcal{D}_t := \left\{ x \in B_{\frac{\varrho_0}{2}}(x_0) \cap \Omega : k_t < w(x) \leq k_{t+1} \right\}.$$

Moreover, for k' and k'' as in the assertions of our Lemma,

$$k' \leq k_t \leq k'' \quad \text{and} \quad k_t < k_{t+1} = \sup_{B_{\varrho_0} \cap \Omega} w - \frac{\omega}{2^{t+1}} = \frac{1}{2} \left(k_t + \sup_{B_{\varrho_0}(x_0) \cap \Omega} w \right),$$

clearly holds for all $t \in [0, s-1]$. Thus, a function w as in the conditions of the Lemma satisfies inequality (A.8.1.15) with the choice $k = k_t$, $l = k_{t+1}$, $\varrho = \varrho_0$, and $\sigma = \frac{1}{2}$, in other words we have

$$\begin{aligned} \int_{\mathcal{D}_t} |\nabla w|^2 dx &\leq \gamma \left(4\varrho_0^{-1} \sup_{B_{\varrho_0} \cap \Omega} (w - k_t)^2 + 1 \right) \left| \{x \in B_{\varrho_0}(x_0) \cap \Omega : w > k\} \right|^{\frac{2}{3}} \\ &\leq \gamma \left(4\varrho_0^{-1} \left(\frac{\omega}{2^t} \right)^2 + 1 \right) |B_{\varrho_0}|^{\frac{2}{3}}. \end{aligned} \quad (\text{A.8.1.17})$$

By virtue of $\omega > 2^s \varrho_0^{\frac{1}{2}}$ and $|B_{\varrho_0}| = |B^1| \varrho_0^3$, it follows from (A.8.1.17)

$$\int_{\mathcal{D}_t} |\nabla w|^2 dx \leq \gamma \left(4 \left(\frac{\omega}{2^t} \right)^2 + \left(\frac{\omega}{2^s} \right)^2 \right) |B^1|^{\frac{2}{3}} \varrho_0 \leq 2^3 \gamma \left(\frac{\omega}{2^t} \right)^2 |B^1|^{\frac{2}{3}} \varrho_0 \quad (\text{A.8.1.18})$$

for all $t \leq s$. On the other hand, Lemma A.7.2 with the choice $k = k_t$, $l = k_{t+1}$, and $\varrho = \frac{\varrho_0}{2}$ implies

$$\begin{aligned} \frac{\omega}{2^{t+1}} \left| \left\{ x \in B_{\frac{\varrho_0}{2}}(x_0) \cap \Omega : w(x) > k_{t+1} \right\} \right|^{\frac{2}{3}} \\ \leq \beta \frac{\varrho_0^3}{2^3 \left| \left\{ x \in B_{\frac{\varrho_0}{2}}(x_0) \cap \Omega : w(x) \leq k_t \right\} \right|} \int_{\mathcal{D}_t} |\nabla w| dx \\ \leq \beta \frac{\varrho_0^3}{2^3 \left| \left\{ x \in B_{\frac{\varrho_0}{2}}(x_0) \cap \Omega : w(x) \leq k_t \right\} \right|} \int_{\mathcal{D}_t} |\nabla w| dx. \end{aligned} \quad (\text{A.8.1.19})$$

As by construction $k_t \geq k'$ for all $t \in \{0, \dots, s-1\}$, inequality (A.8.1.14) yields

$$\left| \left\{ x \in B_{\frac{\varrho_0}{2}}(x_0) \cap \Omega : w(x) \leq k_t \right\} \right| \geq \left| \left\{ x \in B_{\frac{\varrho_0}{2}}(x_0) \cap \Omega : w(x) \leq k' \right\} \right| \geq \epsilon_0 |B_{\frac{\varrho_0}{2}}(x_0)| = \epsilon_0 |B^1| \frac{\varrho_0^3}{2^3}.$$

Thus, we find by virtue of inequality (A.8.1.14) for all $t+1 \leq s-1$ the following estimate

$$\left| \left\{ x \in B_{\frac{\varrho_0}{2}}(x_0) \cap \Omega : w(x) > k_{s-1} \right\} \right|^{\frac{2}{3}} \leq \beta \frac{2^{t+1}}{\omega \epsilon_0 |B^1|} \int_{\mathcal{D}_t} |\nabla w| dx. \quad (\text{A.8.1.20})$$

Therefore, making use of (A.8.1.18) and of Hölder's inequality we deduce for all $t \in [0, \dots, s-2]$

$$\left| \left\{ x \in B_{\frac{\varrho_0}{2}}(x_0) \cap \Omega : w(x) > k_{s-1} \right\} \right|^{\frac{4}{3}} \leq \beta^2 \frac{2^{2t+2}}{\omega^2 \epsilon_0^2 |B^1|^2} \left(\int_{\mathcal{D}_t} |\nabla w| dx \right)^2$$

$$\begin{aligned} &\leq \beta^2 \frac{2^{2t+2}}{\omega^2 \epsilon_0^2 |B^1|^2} |\mathcal{D}_t| \int_{\mathcal{D}_t} |\nabla w|^2 dx \\ &\leq \beta^2 \frac{2^5}{\epsilon_0^2 |B^1|^{\frac{4}{3}}} |\mathcal{D}_t| \gamma \varrho_0. \end{aligned} \quad (\text{A.8.1.21})$$

Summing (A.8.1.21) over $t \in [0, \dots, s-2]$ and bearing in mind that $\sum_{t=0}^{s-2} |\mathcal{D}_t| \leq \left| B_{\frac{\varrho_0}{2}}(x_0) \right| = |B^1| \frac{\varrho_0^3}{2^3}$, we infer

$$(s-1) \left| \left\{ x \in B_{\frac{\varrho_0}{2}}(x_0) \cap \Omega : w(x) > k_{s-1} \right\} \right|^{\frac{4}{3}} \leq \beta^2 \frac{2^2}{\epsilon_0^2 |B^1|^{\frac{1}{3}}} \gamma \varrho_0^4.$$

With the choice

$$s = 2 + \frac{4\gamma\beta^2}{\theta^{\frac{4}{3}} \epsilon_0^2 |B^1|^{\frac{1}{3}}}$$

we obtain

$$\left| \left\{ x \in B_{\frac{\varrho_0}{2}}(x_0) \cap \Omega : w(x) > k_{s-1} \right\} \right| \leq \theta \varrho^3,$$

and since by definition $k^* = k_{s-1}$ the claim follows. \square

Let us now prove a generalized version of [44, Chapter 2, Lemma 6.1]

Lemma A.8.5. *Let $\Omega \subset \mathbb{R}^3$ satisfy Assumption A.8.1, $w \in H^1(\Omega)$, $k', k'' \in \mathbb{R}$, and $x_0 \in \bar{\Omega}$. Denoting again by $B_\varrho(x_0)$ the ball centered at x_0 with radius $0 < \varrho \leq \varrho_0$ with ϱ_0 as in Assumption A.8.1. We suppose that there exist $\gamma, \epsilon_0 > 0$ such that*

$$\left| \left\{ x \in B_{\frac{\varrho_0}{2}}(x_0) \cap \Omega : w \leq k' \right\} \right| \geq \epsilon_0 \left| B_{\frac{\varrho_0}{2}} \right| \quad (\text{A.8.1.22})$$

holds and for any $\sigma \in (0, 1)$ and $0 < \varrho$ satisfying $\frac{\varrho_0}{4} \leq (1-\sigma)\varrho \leq \varrho \leq \varrho_0$ the function w satisfies

$$\begin{aligned} &\int_{\{x \in B_{(1-\sigma)\varrho}(x_0) \cap \Omega\} : k < w(x) \leq l} |\nabla w|^2 dx \\ &\leq \gamma \left(\sigma^{-2} \varrho^{-1} \sup_{B_\varrho(x_0) \cap \Omega} (w-k)^2 + 1 \right) |\{x \in B_\varrho(x_0) \cap \Omega : w > k\}|^{\frac{2}{3}} \end{aligned} \quad (\text{A.8.1.23})$$

for levels k, l subject to

$$k \in [k', k''], \quad l \in \left[k, \frac{1}{2} \left(k + \sup_{B_{\varrho_0}(x_0) \cap \Omega} w \right) \right]. \quad (\text{A.8.1.24})$$

Then the quantity $\omega := \sup_{B_{\varrho_0}(x_0) \cap \Omega} w(x) - k'$ satisfies

$$\omega \leq 2^s \max \left\{ \sup_{B_{\varrho_0}(x_0) \cap \Omega} w(x) - \sup_{B_{\frac{\varrho_0}{4}}(x_0) \cap \Omega} w(x); \varrho_0^{\frac{1}{2}} \right\} \quad (\text{A.8.1.25})$$

with s as in Lemma (A.8.4), provided that $k'' \geq \sup_{B_{\varrho_0} \cap \Omega} w(x) - \frac{\omega}{2^s}$ holds.

Proof: The proof is almost identical to that of [44, Chapter 2, Lemma 6.1].

Clearly, if $\omega = \sup_{B_{\varrho_0} \cap \Omega} w(x) - k' \leq 2^s \varrho_0^{\frac{1}{2}}$, then (A.8.1.25) is satisfied. Hence, we assume that $\omega > 2^s \varrho_0^{\frac{1}{2}}$. As by assumption $k'' \geq \sup_{B_{\varrho_0}(x_0) \cap \Omega} w - \frac{\omega}{2^s}$ is satisfied, Lemma A.8.4 yields

$$\left| \left\{ x \in B_{\frac{\varrho_0}{2}}(x_0) \cap \Omega : w(x) > k_0 \right\} \right| \leq \theta \varrho^3$$

with $k_0 = \sup_{x \in B_{\varrho_0}(x_0) \cap \Omega} w - \frac{\omega}{2^{s-1}}$.

Moreover, assumption $\omega > 2^s \varrho_0^{\frac{1}{2}}$ together with $k'' \geq \sup_{B_{\varrho_0}(x_0) \cap \Omega} w - \frac{\omega}{2^s}$ imply

$$H := \sup_{x \in B_{\varrho_0}(x_0) \cap \Omega} w - k_0 = \frac{\omega}{2^{s-1}} > \varrho_0^{\frac{1}{2}} \quad \text{and} \quad k_0 + \frac{H}{2} \leq k''$$

and therefore Lemma A.8.3 yields

$$\sup_{B_{\frac{\varrho_0}{4}}(x_0) \cap \Omega} w \leq k_0 + \frac{H}{2} = \sup_{B_{\varrho_0}(x_0) \cap \Omega} w - \frac{\omega}{2^s}.$$

Consequently, (A.8.1.25) follows. □

In the following result we prove the crucial estimates of this section. We show that, under appropriate assumptions on the boundary data, functions from the class $\check{\mathcal{B}}_2(\bar{\Omega}, M, \gamma)$ satisfy conditions of Lemma A.7.4, which in turn provides the Hölder-continuity of these functions. The result reads as follows.

Lemma A.8.6. *Let $\Omega \subset \mathbb{R}^3$ satisfy Assumption A.8.1 and $u \in \check{\mathcal{B}}_2(\bar{\Omega}, M, \gamma)$. Furthermore, let $\phi \in C^{0,\epsilon}(\bar{\Omega})$ with $\epsilon \in (0, 1)$ such that $\phi \geq 0$ on Γ , $\phi > 0$ on $\text{int}\Gamma'$, and $\phi = 0$ on $\Gamma \setminus \Gamma'$, where Γ and Γ' are as in Assumption A.8.1 and suppose that $(\gamma_0 u)^+ = \phi$ a.e. on Γ .*

Then, for a fixed R_0 as in Assumption A.8.1 and concentric balls $B_{\varrho_0}(x_0)$ and $B_{\frac{\varrho_0}{4}}(x_0)$ centered at $x_0 \in \bar{\Omega}$ with radii $0 < \varrho_0 \leq R_0$ and $\frac{\varrho_0}{4}$ resp., one of the following implications hold

$$\textcircled{1} \quad \text{osc} \{u; B_{\varrho_0}(x_0) \cap \Omega\} \leq 2 \text{osc} \{\phi; \partial\Omega \cap B_{\varrho_0}\}, \tag{A.8.1.26a}$$

$$\textcircled{2} \quad \text{osc} \{u; B_{\varrho_0}(x_0) \cap \Omega\} \leq 2^{s+1} \varrho_0^{\frac{1}{2}}, \tag{A.8.1.26b}$$

$$\textcircled{3} \quad \text{osc} \left\{ u; B_{\frac{\varrho_0}{4}}(x_0) \cap \Omega \right\} \leq \left(1 - \frac{1}{2^{s+1}} \right) \text{osc} \{u; B_{\varrho_0}(x_0) \cap \Omega\}, \tag{A.8.1.26c}$$

where the number s depends only on γ , the domain Ω , R_0 , $\delta_1, \delta_2, \delta_3$ from Assumption A.8.1, and the constants θ and β from Lemmata A.8.3 and A.7.2 respectively.

Proof: We proceed similarly as in the proof of [44, Chapter 2, proof of Lemma 6.4]. In our case, we also account for the mixed boundary conditions. It is clear, that it suffices to distinguish the following cases illustrated in Fig. A.8.1

- ❶ $B_{\varrho_0}(x_0) \cap \Gamma = \emptyset$,
- ❷ $B_{\varrho_0}(x_0) \cap \Gamma \neq \emptyset$, $x_0 \in \Gamma$.

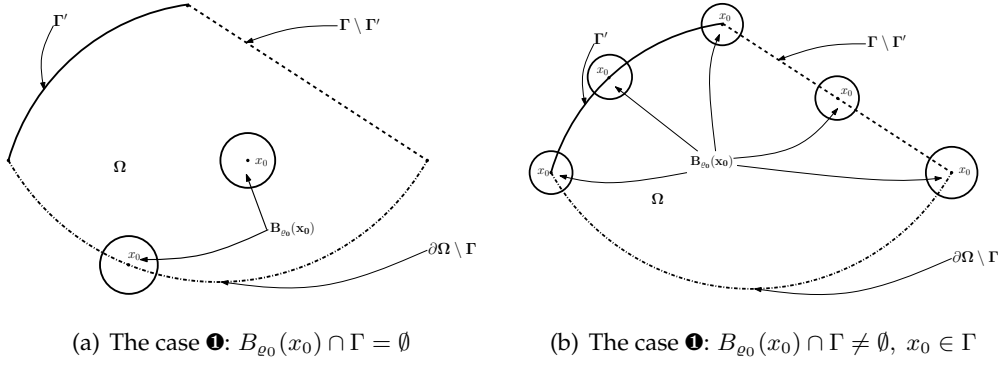
Figure A.8.1: different positions of the balls $B_{\varrho_0}(x_0)$

\bullet Let us start with the first case. Hence, $B_{\varrho_0}(x_0) \cap \Gamma = \emptyset$ and the conditions (A.8.1.3b) and (A.8.1.3c) on admissible levels for (A.8.1.2) are not active. Thus, by assumption the functions $\pm u$ satisfy (A.8.1.2) for any level k subject only to the condition $k \geq \sup_{B_{\varrho_0}(x_0) \cap \Omega} w - 2M$. Setting

$$\omega = \frac{1}{2} \operatorname{osc} \{u; B_{\varrho_0}(x_0) \cap \Omega\},$$

we observe that

$$k' := \sup_{B_{\varrho_0}(x_0) \cap \Omega} w - \omega = \sup_{B_{\varrho_0}(x_0) \cap \Omega} w - \frac{1}{2} \operatorname{osc} \{u; B_{\varrho_0}(x_0) \cap \Omega\} \geq \sup_{B_{\varrho_0}(x_0) \cap \Omega} w - 2M$$

holds with $w = \pm u$, and therefore inequality (A.8.1.23) is valid for any levels $k \geq k'$ and $l > k$.

Moreover, by virtue of

$$\sup_{B_{\varrho_0}(x_0) \cap \Omega} u - \frac{1}{2} \operatorname{osc} \{u; B_{\varrho_0}(x_0) \cap \Omega\} = \inf_{B_{\varrho_0}(x_0) \cap \Omega} u + \frac{1}{2} \operatorname{osc} \{u; B_{\varrho_0}(x_0) \cap \Omega\},$$

we conclude that

$$\left\{ x \in B_{\frac{\varrho_0}{2}}(x_0) \cap \Omega : u(x) \leq \sup_{B_{\varrho_0}(x_0) \cap \Omega} u - \frac{1}{2} \operatorname{osc} \{u; B_{\varrho_0}(x_0) \cap \Omega\} \right\} \\ \cup \left\{ x \in B_{\frac{\varrho_0}{2}}(x_0) \cap \Omega : u(x) \geq \inf_{B_{\varrho_0}(x_0) \cap \Omega} u + \frac{1}{2} \operatorname{osc} \{u; B_{\varrho_0}(x_0) \cap \Omega\} \right\} = B_{\frac{\varrho_0}{2}}(x_0) \cap \Omega$$

and consequently, either

$$\left| \left\{ x \in B_{\frac{\varrho_0}{2}}(x_0) \cap \Omega : u(x) \leq \sup_{B_{\varrho_0}(x_0) \cap \Omega} u - \frac{1}{2} \operatorname{osc} \{u; B_{\varrho_0}(x_0) \cap \Omega\} \right\} \right| \geq \frac{1}{2} \left| B_{\frac{\varrho_0}{2}}(x_0) \cap \Omega \right|, \quad (\text{A.8.1.27})$$

or

$$\left| \left\{ x \in B_{\frac{\varrho_0}{2}}(x_0) \cap \Omega : -u(x) \leq \sup_{B_{\varrho_0}(x_0) \cap \Omega} -u - \frac{1}{2} \operatorname{osc} \{u; B_{\varrho_0}(x_0) \cap \Omega\} \right\} \right| \geq \frac{1}{2} \left| B_{\frac{\varrho_0}{2}}(x_0) \cap \Omega \right| \quad (\text{A.8.1.28})$$

must be satisfied. In other words

$$\left| \left\{ x \in B_{\frac{\varrho_0}{2}}(x_0) \cap \Omega : w(x) \leq \sup_{B_{\varrho_0}(x_0) \cap \Omega} w - \frac{1}{2} \operatorname{osc} \{w; B_{\varrho_0}(x_0) \cap \Omega\} \right\} \right| \geq \frac{1}{2} \left| B_{\frac{\varrho_0}{2}}(x_0) \cap \Omega \right|, \quad (\text{A.8.1.29})$$

with either $w = u$ or $w = -u$ holds. Recalling that $k' \geq \sup_{B_{\varrho_0}(x_0) \cap \Omega} w - \frac{\omega}{2}$, we obtain

$$\left| \left\{ x \in B_{\frac{\varrho_0}{2}}(x_0) \cap \Omega : w(x) \leq k' \right\} \right| \geq \frac{1}{2} \left| B_{\frac{\varrho_0}{2}}(x_0) \cap \Omega \right|.$$

Hence, due to Lemma A.8.5 either

$$\text{osc} \{u; B_{\varrho_0}(x_0) \cap \Omega\} \leq 2\omega \leq 2^{s+1} \varrho_0^{\frac{1}{2}},$$

or

$$\begin{aligned} \text{osc} \{u; B_{\varrho_0}(x_0) \cap \Omega\} &\leq 2^{s+1} \left(\text{osc} \{w; B_{\varrho_0}(x_0) \cap \Omega\} - \text{osc} \left\{ w; B_{\frac{\varrho_0}{4}} \cap \Omega \right\} \right) \\ &= 2^{s+1} \left(\text{osc} \{u; B_{\varrho_0}(x_0) \cap \Omega\} - \text{osc} \left\{ u; B_{\frac{\varrho_0}{4}}(x_0) \cap \Omega \right\} \right), \end{aligned}$$

holds with the number s as in Lemma (A.8.4). This means that either (A.8.1.26b), or (A.8.1.26c) is satisfied.

② Let us proceed with the second case, i.e we assume that $B_{\varrho_0}(x_0) \cap \Gamma \neq \emptyset$, $x_0 \in \Gamma$.

Clearly, either

① both

$$\sup_{B_{\varrho_0}(x_0) \cap \Omega} u - \frac{\text{osc} \{u; B_{\varrho_0}(x_0) \cap \Omega\}}{4} \leq \sup_{\Gamma \cap B_{\varrho_0}(x_0)} \phi, \quad (\text{A.8.1.30a})$$

and

$$- \inf_{B_{\varrho_0}(x_0) \cap \Omega} u - \frac{\text{osc} \{u; B_{\varrho_0}(x_0) \cap \Omega\}}{4} \leq - \inf_{\Gamma \cap B_{\varrho_0}(x_0)} \phi \quad (\text{A.8.1.30b})$$

must hold, or

② either

$$\sup_{B_{\varrho_0}(x_0) \cap \Omega} u - \frac{\text{osc} \{u; B_{\varrho_0}(x_0) \cap \Omega\}}{4} \geq \sup_{\Gamma \cap B_{\varrho_0}(x_0)} \phi, \quad (\text{A.8.1.31a})$$

or

$$\inf_{B_{\varrho_0}(x_0) \cap \Omega} u + \frac{\text{osc} \{u; B_{\varrho_0}(x_0) \cap \Omega\}}{4} \leq \inf_{\Gamma \cap B_{\varrho_0}(x_0)} \phi \quad (\text{A.8.1.31b})$$

must be satisfied.

In the first case ① we find adding (A.8.1.30a) and (A.8.1.30b) that

$$\text{osc} \{u; B_{\varrho_0}(x_0) \cap \Omega\} \leq 2 \text{osc} \{ \phi; \Gamma \cap B_{\varrho_0}(x_0) \} \leq 2 \text{osc} \{ \phi; \partial \Omega \cap B_{\varrho_0}(x_0) \}$$

holds and consequently (A.8.1.26a) is satisfied.

Let us proceed with case ②.

Suppose first, that (A.8.1.31a) holds, i.e

$$\sup_{B_{\varrho_0}(x_0) \cap \Omega} u - \frac{\text{osc} \{u; B_{\varrho_0}(x_0) \cap \Omega\}}{4} \geq \sup_{\Gamma \cap B_{\varrho_0}(x_0)} \phi.$$

Recalling that the conditions of the Lemma yield $\phi > 0$ on $\text{int}\Gamma'$, and $\phi = 0$ on $\Gamma \setminus \Gamma'$, we calculate that

$$k' := \sup_{B_{\varrho_0}(x_0) \cap \Omega} u - \frac{\text{osc}\{u; B_{\varrho_0}(x_0) \cap \Omega\}}{4} \geq \max \left\{ 0; \sup_{\Gamma' \cap B_{\varrho_0}(x_0)} \phi; \sup_{B_{\varrho_0}(x_0) \cap \Omega} u - 2M \right\}$$

holds, and therefore all $k \geq k'$ are admissible levels for (A.8.1.2) in the ball $B_{\varrho_0}(x_0)$.

Clearly, it suffices to consider the following two subcases illustrated in Fig. A.8.2

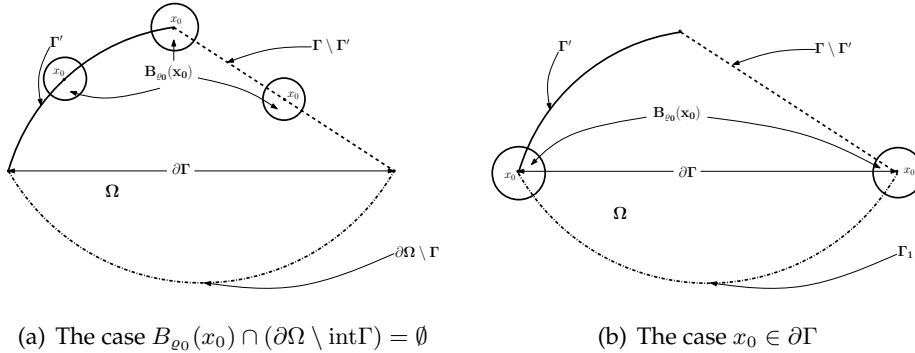

Figure A.8.2: Different positions of the balls $B_{\varrho_0}(x_0)$ in the case $\sup_{B_{\varrho_0}(x_0) \cap \Omega} u - \frac{\text{osc}\{u; B_{\varrho_0}(x_0) \cap \Omega\}}{4} \geq \sup_{\Gamma \cap B_{\varrho_0}(x_0)} \phi$

(a) Let us first assume that $B_{\varrho_0}(x_0) \cap (\partial\Omega \setminus \text{int}\Gamma) = \emptyset$ holds.

Bearing in mind $k' \geq 0$ and $u \leq k'$ a.e. on $\Gamma \cap B_{\varrho_0}(x_0)$, we see that the function \hat{u} defined by

$$\hat{u}(x) = \begin{cases} \max\{u(x); k'\}, & x \in B_{\varrho_0}(x_0) \cap \Omega, \\ k', & x \in B_{\varrho_0}(x_0) \setminus \Omega \end{cases}$$

satisfies inequality (A.8.1.23) for any k and l subject to (A.8.1.24) and where Ω is replaced by the set $\tilde{\Omega} = \Omega \cup B_{\varrho_0}(x_0)$.

As by construction $\hat{u} \leq k'$ a.e. in $B_{\varrho_0}(x_0) \setminus \Omega$, Assumption A.8.1(ii) yields

$$\left| \left\{ x \in B_{\frac{\varrho_0}{2}}(x_0) : \hat{u} > k' \right\} \right| = \left| \left\{ x \in B_{\frac{\varrho_0}{2}}(x_0) \cap \Omega : \hat{u} > k' \right\} \right| \leq \left| B_{\frac{\varrho_0}{2}}(x_0) \cap \Omega \right| \leq (1 - \delta_2) \left| B_{\frac{\varrho_0}{2}}(x_0) \right|,$$

with δ_2 as in Assumption A.8.1(ii). Then, by virtue of $B_{\frac{\varrho_0}{2}}(x_0) = B_{\frac{\varrho_0}{2}}(x_0) \cap \tilde{\Omega}$,

$$\left| \left\{ x \in B_{\frac{\varrho_0}{2}} \cap \tilde{\Omega} : \hat{u} \leq k' \right\} \right| \geq \delta_2 \left| B_{\frac{\varrho_0}{2}}(x_0) \right|$$

follows and consequently, (A.8.1.22) is satisfied. Hence, due to Lemma A.8.5 applied to the function \hat{u} and the domain $\tilde{\Omega}$ either

$$\text{osc} \left\{ \hat{u}; B_{\varrho_0}(x_0) \cap \tilde{\Omega} \right\} \leq 2^{s+1} \varrho_0^{\frac{1}{2}},$$

or

$$\text{osc} \left\{ \hat{u}; B_{\varrho_0}(x_0) \cap \tilde{\Omega} \right\} \leq 2^{s+1} \left(\text{osc} \left\{ \hat{u}; B_{\varrho_0}(x_0) \cap \tilde{\Omega} \right\} - \text{osc} \left\{ \hat{u}; B_{\frac{\varrho_0}{4}}(x_0) \cap \tilde{\Omega} \right\} \right),$$

must hold with the number s as in Lemma A.8.4, in other words either (A.8.1.26b) or (A.8.1.26c) is satisfied.

(b) In the case $x_0 \in \partial\Gamma$, we recall that Ω satisfies Assumption A.8.1(iii) and therefore the function \check{u} defined by

$$\check{u}(x) = \begin{cases} \max \{u(x); k'\}, & x \in B_{\varrho_0}(x_0) \cap \Omega, \\ k', & x \in (\tilde{\Omega} \cap B_{\varrho_0}(x_0)) \setminus \Omega, \end{cases}$$

satisfies inequality (A.8.1.23) for any k, l subject to (A.8.1.24), and $\tilde{\Omega}$ as in Assumption A.8.1(iii). Keeping in mind that $\check{u} \leq k'$ a.e. in $(\tilde{\Omega} \cap B_{\varrho_0}(x_0)) \setminus \Omega$, we infer with the help of Assumption A.8.1(iii) that

$$\begin{aligned} \left| \left\{ x \in B_{\frac{\varrho_0}{2}}(x_0) \cap \tilde{\Omega} : \check{u} > k' \right\} \right| &= \left| \left\{ x \in B_{\frac{\varrho_0}{2}}(x_0) \cap \Omega : \check{u} > k' \right\} \right| \\ &\leq \left| B_{\frac{\varrho_0}{2}} \cap \Omega \right| \leq \left| \tilde{\Omega} \cap B_{\frac{\varrho_0}{2}} \right| - \delta_3 \left| B_{\frac{\varrho_0}{2}}(x_0) \right| \end{aligned}$$

holds with δ_3 as in Assumption A.8.1(iii). Hence,

$$\left| \left\{ x \in B_{\frac{\varrho_0}{2}}(x_0) \cap \tilde{\Omega} : \check{u} \leq k' \right\} \right| \geq \delta_3 \left| B_{\frac{\varrho_0}{2}}(x_0) \right|$$

follows, and consequently (A.8.1.22) is satisfied. Thus, application of Lemma A.8.5 yields either

$$\text{osc} \left\{ \check{u}; B_{\varrho_0}(x_0) \cap \tilde{\Omega} \right\} \leq 2\omega \leq 2^{s+1} \varrho_0^{\frac{1}{2}},$$

or

$$\text{osc} \left\{ \check{u}; B_{\varrho_0}(x_0) \cap \tilde{\Omega} \right\} \leq 2^{s+1} \left(\text{osc} \left\{ \check{u}; B_{\varrho_0}(x_0) \cap \tilde{\Omega} \right\} - \text{osc} \left\{ \check{u}; B_{\frac{\varrho_0}{4}}(x_0) \cap \tilde{\Omega} \right\} \right),$$

i.e. either (A.8.1.26b), or (A.8.1.26c) must hold.

Let us now proceed with the case in which (A.8.1.31b) holds, i.e.

$$\inf_{B_{\varrho_0}(x_0) \cap \Omega} u + \frac{\text{osc} \{u; B_{\varrho_0}(x_0) \cap \Omega\}}{4} \leq \inf_{\Gamma \cap B_{\varrho_0}(x_0)} \phi$$

is satisfied. Clearly, it suffices to consider only three subcases depicted in the following figure

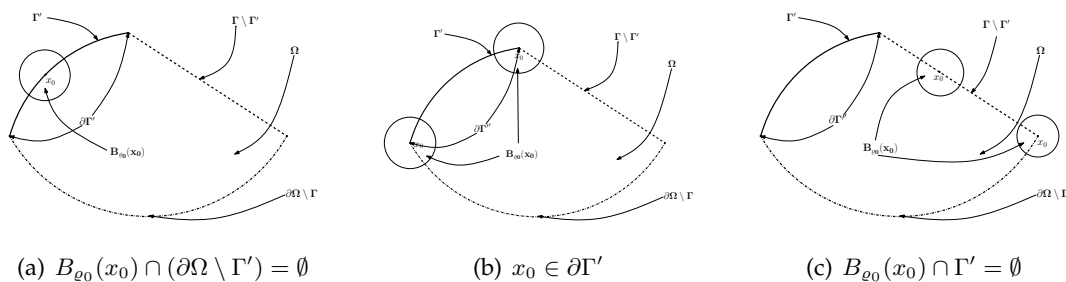

Figure A.8.3: Different positions of the balls $B_{\varrho_0}(x_0)$ in the case $\inf_{B_{\varrho_0}(x_0) \cap \Omega} u + \frac{\text{osc} \{u; B_{\varrho_0}(x_0) \cap \Omega\}}{4} \leq \inf_{\Gamma \cap B_{\varrho_0}(x_0)} \phi$

(a) In this case $B_{\varrho_0}(x_0) \cap (\partial\Omega \setminus \Gamma') = \emptyset$ holds and we have, as before, by virtue of assumptions $\phi > 0$ on $\text{int}\Gamma'$ and $(\gamma_0 u)^+ = \phi$ a.e. on Γ , that $\gamma_0 u = \phi$ a.e. on $\Gamma' \cap B_{\varrho_0}(x_0)$. Moreover, calculating

$$\sup_{\Gamma' \cap B_{\varrho_0}(x_0)} -u = \sup_{\Gamma' \cap B_{\varrho_0}(x_0)} -\phi = - \inf_{\Gamma \cap B_{\varrho_0}(x_0)} \phi \leq \sup_{B_{\varrho_0}(x_0) \cap \Omega} -u - \frac{\text{osc} \{-u; B_{\varrho_0}(x_0) \cap \Omega\}}{4},$$

we see that the level

$$k' := \sup_{B_{\varrho_0}(x_0) \cap \Omega} -u - \frac{\text{osc} \{-u; B_{\varrho_0}(x_0) \cap \Omega\}}{4}$$

is an admissible level for (A.8.1.2) with $-u$ and $B_{\varrho_0}(x_0)$. Thus in particular, $-u$ satisfies (A.8.1.23) for any levels k, l with $k \geq k'$ and $l > k$.

As Γ' satisfies Assumption A.8.1 (ii), we find that the function $-\hat{u}$ defined by

$$-\hat{u}(x) = \begin{cases} \max \{-u(x); k'\}, & x \in B_{\varrho_0}(x_0) \cap \Omega, \\ k', & x \in B_{\varrho_0}(x_0) \setminus \Omega \end{cases}$$

also satisfies inequality (A.8.1.23) for any k, l subject to (A.8.1.24) and Ω replaced by $\tilde{\Omega} = \Omega \cup B_{\varrho_0}(x_0)$. Bearing in mind that by construction $-\hat{u} \leq k'$ holds a.e. in $B_{\varrho_0}(x_0) \setminus \Omega$, we find by virtue of Assumption A.8.1(ii)

$$\begin{aligned} \left| \left\{ x \in B_{\frac{\varrho_0}{2}}(x_0) : -\hat{u} > k' \right\} \right| &= \left| \left\{ x \in B_{\frac{\varrho_0}{2}}(x_0) \cap \Omega : -\hat{u} > k' \right\} \right| \\ &\leq \left| B_{\frac{\varrho_0}{2}}(x_0) \cap \Omega \right| \leq (1 - \delta_2) \left| B_{\frac{\varrho_0}{2}}(x_0) \right| \end{aligned}$$

with δ_2 as in Assumption A.8.1(ii). Recalling $B_{\frac{\varrho_0}{2}}(x_0) = B_{\frac{\varrho_0}{2}}(x_0) \cup \tilde{\Omega}$,

$$\left| \left\{ x \in B_{\frac{\varrho_0}{2}} \cap \tilde{\Omega} : -\hat{u} \leq k' \right\} \right| \geq \delta_2 \left| B_{\frac{\varrho_0}{2}}(x_0) \right|$$

holds, and consequently (A.8.1.22) is satisfied. Application of Lemma A.8.5 yields either

$$\text{osc} \left\{ -\hat{u}; B_{\varrho_0}(x_0) \cap \tilde{\Omega} \right\} \leq 2^{s+1} \varrho_0^{\frac{1}{2}},$$

or

$$\text{osc} \left\{ -\hat{u}; B_{\varrho_0}(x_0) \cap \tilde{\Omega} \right\} \leq 2^{s+1} \left(\text{osc} \left\{ -\hat{u}; B_{\varrho_0}(x_0) \cap \tilde{\Omega} \right\} - \text{osc} \left\{ -\hat{u}; B_{\frac{\varrho_0}{4}}(x_0) \cap \tilde{\Omega} \right\} \right),$$

with the number s as in Lemma A.8.4, in other words either (A.8.1.26b) or (A.8.1.26c) is satisfied.

(b) In this case we have $x_0 \in \partial\Gamma'$. Thus, by virtue of assumptions $\phi > 0$ on $\text{int}\Gamma'$, $\phi = 0$ on $\Gamma \setminus \Gamma'$, and $(\gamma_0 u)^+ = \phi$ a.e. on Γ , we find $\gamma_0 u = \phi$ a.e. on $\Gamma' \cap B_{\varrho_0}(x_0)$, $(\gamma_0 u)^+ = 0$ a.e. on $(\Gamma \setminus \Gamma') \cap B_{\varrho_0}(x_0)$, as well as

$$\sup_{\Gamma \cap B_{\varrho_0}(x_0)} -(\gamma_0 u)^+ = 0 = - \inf_{\Gamma \cap B_{\varrho_0}(x_0)} \phi \leq \sup_{B_{\varrho_0}(x_0) \cap \Omega} -u - \frac{\text{osc} \{-u; B_{\varrho_0}(x_0) \cap \Omega\}}{4}.$$

Therefore, the level $k' := \sup_{B_{\varrho_0}(x_0) \cap \Omega} -u - \frac{\text{osc}\{-u; B_{\varrho_0}(x_0) \cap \Omega\}}{4}$ is admissible for (A.8.1.2) with the choice $-u$ and $B_{\varrho_0}(x_0)$.

Since $\partial\Gamma'$ satisfies Assumption A.8.1(iii), we see that the function \check{u} , defined by

$$\check{u}(x) = \begin{cases} \max\{-u(x); k'\}, & x \in B_{\varrho_0}(x_0) \cap \Omega, \\ k', & x \in (\tilde{\Omega}' \cap B_{\varrho_0}(x_0)) \setminus \Omega, \end{cases}$$

satisfies inequality (A.8.1.23) for any k, l subject to $k \geq k'$ and $\tilde{\Omega}'$ as in Assumption A.8.1(iii). Moreover, keeping in mind that $\check{u} \leq k'$ a.e. in $(\tilde{\Omega}' \cap B_{\varrho_0}(x_0)) \setminus \Omega$, we find by virtue of Assumption A.8.1(iii)

$$\begin{aligned} \left| \left\{ x \in B_{\frac{\varrho_0}{2}}(x_0) \cap \tilde{\Omega}' : \check{u} > k' \right\} \right| &= \left| \left\{ x \in B_{\frac{\varrho_0}{2}}(x_0) \cap \Omega : \check{u} > k' \right\} \right| \\ &\leq \left| B_{\frac{\varrho_0}{2}}(x_0) \cap \Omega \right| \leq \left| \tilde{\Omega}' \cap B_{\frac{\varrho_0}{2}}(x_0) \right| - \delta_3 \left| B_{\frac{\varrho_0}{2}}(x_0) \right|. \end{aligned}$$

with δ_3 as in Assumption A.8.1(iii). Hence,

$$\left| \left\{ x \in B_{\frac{\varrho_0}{2}}(x_0) \cap \tilde{\Omega}' : \check{u} \leq k' \right\} \right| \geq \delta_3 \left| B_{\frac{\varrho_0}{2}}(x_0) \right|$$

holds, and consequently (A.8.1.22) is satisfied. Therefore, Lemma A.8.5 yields either

$$\text{osc} \left\{ \check{u}; B_{\varrho_0}(x_0) \cap \tilde{\Omega}' \right\} \leq 2^{s+1} \varrho_0^{\frac{1}{2}},$$

or

$$\text{osc} \left\{ \check{u}; B_{\varrho_0}(x_0) \cap \tilde{\Omega}' \right\} \leq 2^{s+1} \left(\text{osc} \left\{ \check{u}; B_{\varrho_0}(x_0) \cap \tilde{\Omega}' \right\} - \text{osc} \left\{ \check{u}; B_{\frac{\varrho_0}{4}} \cap \tilde{\Omega}' \right\} \right),$$

with s as in Lemma A.8.4, i.e. either (A.8.1.26b), or (A.8.1.26c) is satisfied.

(c) In this case we have $B_{\varrho_0}(x_0) \cap \Gamma' = \emptyset$. As in case (b) it follows that

$$0 \leq \sup_{B_{\varrho_0}(x_0) \cap \Omega} -u - \frac{\text{osc} \{-u; B_{\varrho_0}(x_0) \cap \Omega\}}{4}. \quad (\text{A.8.1.32})$$

We now proceed as in the case considered in **1**. Thus, by assumption we have that the functions $w = \pm u$ satisfy (A.8.1.2) for any level k subject only to the condition $k \geq \sup_{B_{\varrho_0}(x_0) \cap \Omega} \pm w - 2M$ and $k \geq \sup_{B_{\varrho_0}(x_0) \cap \Gamma'} (\gamma_0 w)^+ = -\infty$ in the case $w = u$, or $k \geq \sup_{B_{\varrho_0}(x_0) \cap \Gamma'} -(\gamma_0 w)^+ = 0$ if $w = -u$. Setting

$$\omega = \frac{1}{2} \text{osc} \{u; B_{\varrho_0}(x_0) \cap \Omega\},$$

we observe that

$$k' := \sup_{B_{\varrho_0}(x_0) \cap \Omega} w - \frac{\omega}{2} = \sup_{B_{\varrho_0}(x_0) \cap \Omega} w - \frac{1}{4} \text{osc} \{u; B_{\varrho_0}(x_0) \cap \Omega\} \geq \sup_{B_{\varrho_0}(x_0) \cap \Omega} w - 2M$$

holds with $w = \pm u$, and therefore, taking (A.8.1.32) into account, inequalities (A.8.1.23) are valid for any levels $k \geq k'$, and $l > k$.

Moreover, by virtue of

$$\sup_{B_{\varrho_0}(x_0) \cap \Omega} u - \frac{1}{2} \operatorname{osc} \{u; B_{\varrho_0}(x_0) \cap \Omega\} = \inf_{B_{\varrho_0}(x_0) \cap \Omega} u + \frac{1}{2} \operatorname{osc} \{u; B_{\varrho_0}(x_0) \cap \Omega\},$$

we conclude that

$$\begin{aligned} & \left\{ x \in B_{\frac{\varrho_0}{2}}(x_0) \cap \Omega : u(x) \leq \sup_{B_{\varrho_0}(x_0) \cap \Omega} u - \frac{1}{2} \operatorname{osc} \{u; B_{\varrho_0}(x_0) \cap \Omega\} \right\} \\ & \cup \left\{ x \in B_{\frac{\varrho_0}{2}}(x_0) \cap \Omega : u(x) \geq \inf_{B_{\varrho_0}(x_0) \cap \Omega} u + \frac{1}{2} \operatorname{osc} \{u; B_{\varrho_0}(x_0) \cap \Omega\} \right\} \\ & = B_{\frac{\varrho_0}{2}}(x_0) \cap \Omega \end{aligned}$$

holds, and consequently either

$$\left| \left\{ x \in B_{\frac{\varrho_0}{2}}(x_0) \cap \Omega : u(x) \leq \sup_{B_{\varrho_0}(x_0) \cap \Omega} u - \frac{1}{2} \operatorname{osc} \{u; B_{\varrho_0}(x_0) \cap \Omega\} \right\} \right| \geq \frac{1}{2} \left| B_{\frac{\varrho_0}{2}}(x_0) \cap \Omega \right|, \quad (\text{A.8.1.33})$$

or

$$\left| \left\{ x \in B_{\frac{\varrho_0}{2}}(x_0) \cap \Omega : -u(x) \leq \sup_{B_{\varrho_0}(x_0) \cap \Omega} -u - \frac{1}{2} \operatorname{osc} \{u; B_{\varrho_0}(x_0) \cap \Omega\} \right\} \right| \geq \frac{1}{2} \left| B_{\frac{\varrho_0}{2}}(x_0) \cap \Omega \right| \quad (\text{A.8.1.34})$$

must be satisfied. In other words

$$\left| \left\{ x \in B_{\frac{\varrho_0}{2}}(x_0) \cap \Omega : w(x) \leq \sup_{B_{\varrho_0}(x_0) \cap \Omega} w - \frac{1}{2} \operatorname{osc} \{w; B_{\varrho_0}(x_0) \cap \Omega\} \right\} \right| \geq \frac{1}{2} \left| B_{\frac{\varrho_0}{2}}(x_0) \cap \Omega \right|, \quad (\text{A.8.1.35})$$

with either $w = u$ or $w = -u$ holds.

Recalling that $k' = \sup_{B_{\varrho_0}(x_0) \cap \Omega} w - \frac{\omega}{2} \geq \sup_{B_{\varrho_0}(x_0) \cap \Omega} w - \omega$, we thus infer

$$\left| \left\{ x \in B_{\frac{\varrho_0}{2}}(x_0) \cap \Omega : w(x) \leq k' \right\} \right| \geq \frac{1}{2} \left| B_{\frac{\varrho_0}{2}}(x_0) \cap \Omega \right|$$

and therefore Lemma A.8.5 yields either

$$\operatorname{osc} \{u; B_{\varrho_0}(x_0) \cap \Omega\} \leq 2\omega \leq 2^{s+1} \varrho_0^{\frac{1}{2}},$$

or

$$\begin{aligned} \operatorname{osc} \{u; B_{\varrho_0}(x_0) \cap \Omega\} & \leq 2^{s+1} \left(\operatorname{osc} \{w; B_{\varrho_0}(x_0) \cap \Omega\} - \operatorname{osc} \left\{ w; B_{\frac{\varrho_0}{4}} \cap \Omega \right\} \right) \\ & = 2^{s+1} \left(\operatorname{osc} \{u; B_{\varrho_0}(x_0) \cap \Omega\} - \operatorname{osc} \left\{ u; B_{\frac{\varrho_0}{4}} \cap \Omega \right\} \right), \end{aligned}$$

i.e. either (A.8.1.26b), or (A.8.1.26c) is satisfied with s as in Lemma A.8.4. This finishes the proof. \square

As a consequence of Lemmata A.8.6 and A.7.4 we obtain the following result.

Theorem A.8.7. *Let $\Omega \subset \mathbb{R}^3$ satisfy Assumption A.8.1, $u \in \check{\mathcal{B}}_2(\bar{\Omega}, M, \gamma)$, $\phi \in C^{0,\epsilon}(\bar{\Omega})$ with $\epsilon \in (0, 1)$ such that $\phi \geq 0$ on Γ , $\phi > 0$ on $\text{int}\Gamma'$, and $\phi = 0$ on $\Gamma \setminus \Gamma'$, where Γ and Γ' are as in Assumption A.8.1. Suppose that $(\gamma_0 u)^+ = \phi$ a.e. on Γ . Then*

$$\text{osc} \{u : B_\varrho(x_0) \cap \Omega\} \leq C \left(\frac{\varrho}{\varrho_0} \right)^{\alpha^*} \quad (\text{A.8.1.36})$$

holds for any ball $B_\varrho(x_0)$ centered at $x_0 \in \bar{\Omega}$ with radius $0 < \varrho \leq \varrho_0$ with ϱ_0 as in Assumption A.8.1, and where the constants C and α^* are defined by

$$\begin{aligned} \alpha^* &= \min \left\{ -\ln_4 \left(1 - \frac{1}{2^{s+1}} \right); \min \left\{ \frac{1}{2}; \epsilon \right\} \right\}, \\ C &= 4^{\alpha^*} \max \left\{ 2 \max \left\{ \|\phi\|_{C^{0,\epsilon}(\bar{\Omega})}; 2^s \right\} \varrho_0^{\min\{\frac{1}{2}; \epsilon\}}; 2M \right\}, \end{aligned}$$

and s is as in Lemma A.8.6.

A.8.2 A Parabolic De Giorgi Class

In this subsection we consider the parabolic analogue of the elliptic De Giorgi function class introduced in Definition A.8.2 and prove that, under appropriate assumptions on the initial and boundary data, this function class is continuously embedded into the parabolic Hölder space $C^{\alpha, \frac{\alpha}{2}}(\bar{Q})$.

Let us consider a domain $\Omega \subset \mathbb{R}^3$ satisfying Assumption A.8.1, $T > 0$ and set $Q := \Omega \times (0, T)$. We define $\Gamma_0 := \Omega \times \{0\}$ and for $x_0 \in \bar{\Omega}$, $t_0 \in (0, T]$, and $\varrho, \tau \geq 0$ we put

$$B_\varrho := B_\varrho(x_0) := \{x \in \mathbb{R}^3 : |x - x_0| < \varrho\}$$

and

$$Q(\varrho, \tau) := B_\varrho(x_0) \times (t_0 - \tau, t_0),$$

and call the latter set a local parabolic cylinder. Moreover, for a function

$$u \in L^\infty(0, T; L^2(\Omega)) \cap L^2(0, T; H^1(\Omega))$$

we define

$$\|u\|_{Q(\varrho, \tau) \cap Q} := \left(\sup_{t_0 - \tau \leq t \leq t_0} \|u(\cdot, t)\|_{L^2(B_\varrho(x_0) \cap \Omega)}^2 + \|\nabla u\|_{L^2(Q(\varrho, \tau) \cap Q)}^2 \right)^{\frac{1}{2}}.$$

Let M, γ be positive constants and take positive numbers ϱ_0, τ_0 . We introduce the parabolic De Giorgi function class following [43, Class $\mathcal{B}_2(\bar{Q}, M, \gamma, 2(1 + \frac{2}{N}), 2M, \frac{2}{N})$ in Ch. 2, §7].

Definition A.8.8 (The class $\check{\mathcal{B}}_2(\overline{Q}, M, \gamma)$).

We say, that a function $u = u(x, t)$ belongs to the function class $\check{\mathcal{B}}_2(\overline{Q}, M, \gamma)$ (cf. [43, Class $\mathcal{B}_2(\overline{Q}, M, \gamma, 2(1 + \frac{2}{N}), 2M, \frac{2}{N})$ in Ch. 2, §7]), if u satisfies the following conditions

$$\textcircled{1} \|u\|_{L^\infty(Q)} \leq M, \quad \sup_{0 \leq t \leq T} \|u(\cdot, t)\|_{L^2(\Omega)}^2 + \int_0^T \|\nabla u\|_{L^2(\Omega)}^2 dx dt < \infty \quad (\text{A.8.2.1})$$

$\textcircled{2}$ the functions $w = \pm u$ satisfy the following inequalities

$$\begin{aligned} \sup_{\max\{0; t_0 - \sigma_2 \tau\} < t < t_0} \|w^{(k)}\|_{L^2(B_{\varrho - \sigma_1 \varrho} \cap \Omega)}^2 &\leq \|w^{(k)}(x, \max\{0; t_0 - \tau\})\|_{L^2(B_\varrho \cap \Omega)}^2 \\ &+ \gamma \left((\sigma_1 \varrho)^{-2} \|w^{(k)}\|_{L^2(Q(\varrho, \tau) \cap Q)}^2 + \int_{\max\{0; t_0 - \tau\}}^{t_0} |\{x \in B_\varrho \cap \Omega : u(x, t) > k\}| dt \right) \end{aligned} \quad (\text{A.8.2.2a})$$

and

$$\begin{aligned} \|w^{(k)}\|_{Q(\varrho - \sigma_1 \varrho, \tau - \sigma_2 \tau) \cap Q}^2 &\leq \gamma \left([(\sigma_1 \varrho)^{-2} + (\sigma_2 \tau)^{-1}] \|w^{(k)}\|_{L^2(Q(\varrho, \tau) \cap Q)}^2 \right. \\ &\left. + \int_{\max\{0; t_0 - \tau\}}^{t_0} |\{x \in B_\varrho \cap \Omega : u(x, t) > k\}| dt \right), \end{aligned} \quad (\text{A.8.2.2b})$$

in which $Q(\varrho, \tau)$ is any local parabolic cylinder with ϱ, τ satisfying $\varrho \leq \varrho_0$ and $\tau \leq \tau_0$; σ_1 and σ_2 are arbitrary numbers from the interval $(0, 1)$, and k is an arbitrary number subject only to the following conditions:

$$k \geq \sup_{Q(\varrho, \tau) \cap Q} w - 2M, \quad k \geq \sup_{Q(\varrho, \tau) \cap \Gamma_0} w, \quad (\text{A.8.2.3a})$$

and setting $\Sigma' := \Gamma' \times (0, T)$, as well as $\Sigma := \Gamma \times (0, T)$)

$$\diamond \text{ if } w = u : \quad k \geq \sup_{Q(\varrho, \tau) \cap \Sigma'} (\gamma_0 u)^+, \quad (\text{A.8.2.3b})$$

$$\diamond \text{ if } w = -u : \quad k \geq \sup_{Q(\varrho, \tau) \cap \Sigma} -(\gamma_0 u)^+, \quad (\text{A.8.2.3c})$$

with Γ and Γ' as in Assumption A.8.1 and the classical convention, that $\sup_\emptyset u = -\infty$.

In the following we prove that $\check{\mathcal{B}}_2(\overline{Q}, M, \gamma)$ is continuously embedded into $C^{\alpha, \frac{\alpha}{2}}(\overline{Q})$. We follow the arguments of [43, Chapter 2, §7].

For this function class we have the following results.

Lemma A.8.9 (Ch. 2, Lemma 7.1 with $p = \frac{1}{2}$, $\xi = \frac{3}{4}$ in [43]).

Let $\theta = \frac{1}{64(108^2 + 1)\gamma}$ with γ as in (A.8.2.2a), and suppose that a function u satisfies inequality (A.8.2.2a) in $Q(\varrho, \theta \varrho^2)$ and a level $k \in \mathbb{R}$, and that

$$|\{x \in B_\varrho(x_0) \cap \Omega : u(x, \max\{0; t_0 - \theta \varrho^2\}) > k\}| \leq \frac{1}{2} |B_\varrho(x_0)| = \frac{|B_1|}{2} \varrho^3, \quad (\text{A.8.2.4})$$

as well as

$$H := \sup_{\substack{x \in B_\varrho(x_0) \cap \Omega, \\ \max\{0; t_0 - \theta \varrho^2\} \leq t \leq t_0}} u(x, t) - k > \varrho \quad (\text{A.8.2.5})$$

hold where $|B_1|$ denotes the volume of the unit ball in \mathbb{R}^3 . Then for all $t \in [\max\{0; t_0 - \theta\varrho^2\}, t_0]$ we have

$$\left| \left\{ x \in B_\varrho(x_0) \cap \Omega : u(x, t) \leq k + \frac{3}{4}H \right\} \right| \geq \frac{1}{18} |B_1| \varrho^3. \quad (\text{A.8.2.6})$$

Proof: The proof is almost identical to the proof of [43, Chapter 2, Lemma 7.1].

Let the conditions of the Lemma be satisfied. For $\varrho > 0$ and $x_0 \in \overline{\Omega}$, we set $B_\varrho(x_0) =: B_\varrho$.

Moreover, suppose that

$$H := \sup_{\substack{x \in B_\varrho \cap \Omega, \\ \max\{0; t_0 - \theta\varrho^2\} \leq t \leq t_0}} u(x, t) - k > \varrho.$$

Computing that for all $t \in [\max\{0; t_0 - \theta\varrho^2\}, t_0]$

$$t - \max\{0; t_0 - \theta\varrho^2\} \leq t - t_0 + \theta\varrho^2 \leq \theta\varrho^2$$

clearly holds, we find with the help of (A.8.2.2a) and (A.8.2.4) that the following inequality is satisfied for all $t \in [\max\{0; t_0 - \theta\varrho^2\}, t_0]$

$$\int_{\{x \in B_{(1-\sigma_1)\varrho} \cap \Omega : u(x, t) > k\}} (u(x, t) - k)^2 dx \leq \frac{1}{2} H^2 |B_1| \varrho^3 + \gamma\theta\varrho^2 [(\sigma_1)^{-2} H^2 \varrho^{-2} + 1] |B_1| \varrho^3. \quad (\text{A.8.2.7})$$

On the other hand

$$\begin{aligned} \left(\frac{3}{4}H \right)^2 \left| \left\{ x \in B_{(1-\sigma_1)\varrho} \cap \Omega : u(x, t) > k + \frac{3}{4}H \right\} \right| \\ \leq \int_{\{x \in B_{(1-\sigma_1)\varrho} \cap \Omega : u(x, t) > k + \frac{3}{4}H\}} \left(\frac{3}{4}H \right)^2 dx \\ \leq \int_{\{x \in B_{(1-\sigma_1)\varrho} \cap \Omega : u(x, t) > k\}} (u(x, t) - k)^2 dx \quad (\text{A.8.2.8}) \end{aligned}$$

clearly holds. Thus, combining (A.8.2.7) with (A.8.2.8), we infer

$$\left| \left\{ x \in B_{(1-\sigma_1)\varrho} \cap \Omega : u(x, t) > k + \frac{3}{4}H \right\} \right| \leq \frac{16}{9} \left[\frac{1}{2} + \gamma\theta\varrho^2 (\sigma_1^{-2} \varrho^{-2} + H^{-2}) \right] |B_1| \varrho^3.$$

Keeping in mind, that hat $H > \varrho$, it follows for all $t \in [\max\{0; t_0 - \theta\varrho^2\}, t_0]$

$$\begin{aligned} \left| \left\{ x \in B_{(1-\sigma_1)\varrho} \cap \Omega : u(x, t) > k + \frac{3}{4}H \right\} \right| \\ \leq \frac{16}{9} \left[\frac{1}{2} + \gamma\theta\varrho^2 (\sigma_1^{-2} \varrho^{-2} + \varrho^{-2}) \right] |B_1| \varrho^3 \\ \leq \frac{16}{9} \left[\frac{1}{2} + \gamma\theta (\sigma_1^{-2} + 1) \right] |B_1| \varrho^3. \quad (\text{A.8.2.9}) \end{aligned}$$

By virtue of the assumption $\sigma_1 \in (0, 1)$ we obtain

$$|\Omega \cap ((B_\varrho \setminus B_{(1-\sigma_1)\varrho}))| \leq |B_\varrho \setminus B_{(1-\sigma_1)\varrho}| \leq |B_1| \varrho^3 (\sigma_1^2 - 3\sigma_1 + 3) \sigma_1 \leq 3\sigma_1 |B_1| \varrho^3.$$

With the choice $\sigma_1 = \frac{1}{36 * 3} = \frac{1}{108}$ and $\theta = \frac{1}{64(108^2 + 1)\gamma}$, (A.8.2.9) implies

$$\left| \left\{ x \in B_\varrho \cap \Omega : u(x, t) > k + \frac{3}{4}H \right\} \right| \leq \left| \left\{ x \in B_{(1-\sigma_1)\varrho} \cap \Omega : u(x, t) > k + \frac{3}{4}H \right\} \right| + |B_\varrho \setminus B_{\varrho - \sigma_1 \varrho}|$$

$$\leq \frac{16}{9} \left[\frac{1}{2} + \gamma\theta (\sigma_1^{-2} + 1) \right] |B_1| \varrho^3 + 3\sigma_1 |B_1| \varrho^3 = \frac{17}{18} |B_\varrho|,$$

and the claim follows. \square

Let us proceed with the next result.

Lemma A.8.10 (Ch. 2, Lemma 7.2 in [43]).

Let $x_0 \in \bar{\Omega}$, $\varrho_0 > 0$, $t_0 > 0$, θ as in Lemma A.8.9 and set

$$Q_{\varrho_0} := B_{\varrho_0}(x_0) \times (t_0 - \theta\varrho_0^2, t_0), \quad Q_{\frac{\varrho_0}{2}} := B_{\frac{\varrho_0}{2}}(x_0) \times \left(t_0 - \frac{\theta}{4}\varrho_0^2, t_0 \right)$$

Let $k_0 \in \mathbb{R}$ and suppose that a function u satisfies inequality (A.8.2.2b) in Q_{ϱ_0} for any level $k \geq k_0$. Let

$$\theta_1 := 2^{-45} \beta^{-5} \left(\gamma \left[2 + \frac{1}{3\theta} \right] \right)^{-\frac{5}{2}},$$

with β as in Proposition A.6.1 and assume that

$$|\{(x, t) \in Q_{\varrho_0} \cap Q : u(x, t) > k_0\}| \leq \theta_1 \varrho_0^5 \quad (\text{A.8.2.10})$$

holds. Then either

$$\textcircled{1} \quad H := \sup_{Q_{\varrho_0} \cap Q} u(x, t) - k_0 < \varrho_0, \quad \text{or} \quad (\text{A.8.2.11a})$$

$$\textcircled{2} \quad \left| \left\{ (x, t) \in Q_{\frac{\varrho_0}{2}} \cap Q : u(x, t) > k_0 + \frac{H}{2} \right\} \right| = 0 \quad (\text{A.8.2.11b})$$

is satisfied.

Proof: We follow the arguments of the proof of [43, Chapter 2, Lemma 7.2].

Let the conditions of the Lemma be satisfied. For $\varrho_0 > 0$ and $x_0 \in \bar{\Omega}$ we put $B_{\varrho_0} := B_{\varrho_0}(x_0)$ and $\tau_0 = \theta\varrho_0^2$. Then, we introduce for $x \in B_{\varrho_0}$ and $t \in [t_0 - \tau_0, t_0]$

$$\tilde{x} := \frac{x - x_0}{\varrho_0}, \quad \tilde{t} := \frac{t - t_0}{\varrho_0^2},$$

and

$$\tilde{\Omega} := \{ \tilde{x} \in \mathbb{R}^3 : \tilde{x}\varrho_0 + x_0 \in \Omega \}, \quad \tilde{Q} := \tilde{\Omega} \times \left(-\frac{t_0}{\varrho_0^2}, \frac{T - t_0}{\varrho_0^2} \right).$$

With these definitions we observe that the cylinder $Q_{\varrho_0} := Q(\varrho_0, \tau_0) = B_{\varrho_0} \times (t_0 - \tau_0, t_0)$ corresponds to the cylinder $Q(1, \theta) = B_1(0) \times (-\theta, 0)$.

Now let $0 < \varrho \leq \varrho_0$ and $0 < \tau \leq \tau_0$. Setting

$$\tilde{\varrho} := \frac{\varrho}{\varrho_0}, \quad \tilde{\tau} := \frac{\tau}{\varrho_0^2} \quad \text{and} \quad Q(\tilde{\varrho}, \tilde{\tau}) := B_{\tilde{\varrho}}(0) \times (-\tilde{\tau}, 0),$$

we observe again, that $Q(\tilde{\varrho}, \tilde{\tau})$ corresponds to the cylinder $Q(\varrho, \tau) = B_\varrho(x_0) \times (t_0 - \tau, t_0)$.

Let k_0 be as in the assertions of the Lemma and using these new coordinates, we can rewrite (A.8.2.2b) for the cylinder $Q(\varrho, \tau)$ and a level $k \geq k_0$ as follows

$$\begin{aligned} \left\| u^{(k)} \right\|_{Q((1-\sigma_1)\tilde{\varrho}, (1-\sigma_2)\tilde{\tau}) \cap \tilde{Q}}^2 &\leq \gamma \left(\left[\frac{1}{\sigma_1^2 \tilde{\varrho}^2} + \frac{1}{\sigma_2 \tilde{\tau}} \right] \left\| u^{(k)} \right\|_{L^2(Q(\tilde{\varrho}, \tilde{\tau}) \cap \tilde{Q})}^2 \right. \\ &\quad \left. + \varrho_0^2 \int_{\max\left\{\frac{-t_0}{\varrho_0^2}, -\tilde{\tau}\right\}}^0 \left| \left\{ \tilde{x} \in B_{\tilde{\varrho}}(0) : u(\tilde{x}, \tilde{t}) > k \right\} \right| d\tilde{t} \right). \end{aligned} \quad (\text{A.8.2.12})$$

Suppose now, that

$$H := \sup_{Q_{\varrho_0} \cap Q} u(x, t) - k_0 \geq \varrho_0 \quad (\text{A.8.2.13})$$

is satisfied. Introducing the function v , defined by $v(x, t) := \frac{u(x, t)}{H}$ a.e. in Q , and the levels $\tilde{k} := \frac{k}{H}$ with $k \geq k_0$, we obtain, dividing (A.8.2.12) by H^2 and keeping in mind that $H^{-2}\varrho_0^2 \leq 1$, the following inequality

$$\begin{aligned} \left\| v^{(\tilde{k})} \right\|_{Q((1-\sigma_1)\tilde{\varrho}, (1-\sigma_2)\tilde{\tau}) \cap \tilde{Q}}^2 &\leq \gamma \left(\left[\frac{1}{\sigma_1^2 \tilde{\varrho}^2} + \frac{1}{\sigma_2 \tilde{\tau}} \right] \left\| v^{(\tilde{k})} \right\|_{L^2(Q(\tilde{\varrho}, \tilde{\tau}) \cap \tilde{Q})}^2 \right. \\ &\quad \left. + \int_{\max\left\{\frac{-t_0}{\varrho_0^2}, -\tilde{\tau}\right\}}^0 \left| \left\{ \tilde{x} \in B_{\tilde{\varrho}}(0) : v(\tilde{x}, \tilde{t}) > \tilde{k} \right\} \right| d\tilde{t} \right). \end{aligned} \quad (\text{A.8.2.14})$$

Let us now introduce a sequence of cylinders $\{Q_h\}_{h=0,1,\dots}$ with decreasing measures defined in the following way

$$Q_h := Q(\tilde{\varrho}_h, \tilde{\tau}_h) = B_{\tilde{\varrho}_h}(0) \times (-\tilde{\tau}_h, 0), \quad \tilde{\varrho}_h := \frac{1}{2} + \frac{1}{2^{h+1}}, \quad \tilde{\tau}_h := \frac{\theta}{4} + \frac{\theta}{2^{h+1}} + \frac{\theta}{2^{h+2}} \quad h = 0, 1, 2, \dots$$

With the sequences $\{\sigma_{1_h}\}_{h=0,1,\dots}$ and $\{\sigma_{2_h}\}_{h=0,1,\dots}$ defined by

$$\sigma_{1_h} = \frac{1}{2^{h+1} + 2}, \quad \text{and} \quad \sigma_{2_h} = \frac{3}{2(3 + 2^h)}, \quad h = 0, 1, 2, \dots$$

we verify that

$$\tilde{\varrho}_h(1 - \sigma_{1_h}) = \frac{2^h + 1}{2^{h+1}} \left(1 - \frac{1}{2^{h+1} + 2} \right) = \frac{2^h + 1}{2^{h+1}} \frac{2^{h+1} + 1}{2^{h+1} + 2} = \frac{2^{h+1} + 1}{2^{h+2}} = \frac{1}{2} + \frac{1}{2^{h+2}} = \tilde{\varrho}_{h+1}$$

and similarly, that

$$\tilde{\tau}_h(1 - \sigma_{2_h}) = \theta \frac{2^h + 3}{2^{h+2}} \frac{2^{h+1} + 3}{2(3 + 2^h)} = \theta \frac{2^{h+1} + 3}{2^{h+3}} = \frac{\theta}{4} + \frac{\theta}{2^{h+2}} + \frac{\theta}{2^{h+3}} = \tilde{\tau}_{h+1}$$

are satisfied. Consequently,

$$Q_{h+1} = Q(\tilde{\varrho}_{h+1}, \tilde{\tau}_{h+1}) = Q(\tilde{\varrho}_h(1 - \sigma_{1_h}), \tilde{\tau}_h(1 - \sigma_{2_h}))$$

holds. Further let us introduce a sequence of increasing levels $\{\tilde{k}_h\}_{h=0,1,\dots}$ defined by

$$\tilde{k}_h := \frac{k_0}{H} + \frac{1}{2} \left(1 - \frac{1}{2^h} \right) \quad h = 0, 1, 2, \dots$$

Thus we obtain from (A.8.2.14) for all $h \geq 0$

$$\begin{aligned} \left\| v(\tilde{k}_h) \right\|_{Q_{h+1} \cap \tilde{Q}}^2 &\leq \gamma \left(\left[4^{h+2} + \frac{2^{h+3}}{3\theta} \right] \left\| v(\tilde{k}_h) \right\|_{L^2(Q_h \cap \tilde{Q})}^2 \right. \\ &\quad \left. + \int_{\max\{-\frac{t_0}{\varrho_0^2}; -\tilde{\tau}_h\}}^0 \left| \left\{ \tilde{x} \in B_{\tilde{\varrho}_h}(0) : v(\tilde{x}, \tilde{t}) > \tilde{k}_h \right\} \right| d\tilde{t} \right). \end{aligned} \quad (\text{A.8.2.15})$$

Let us consider the sequence $\{z_h\}_{h=0,1,2,\dots}$ defined by

$$z_h := \int_{\max\{-\frac{t_0}{\varrho_0^2}; -\tilde{\tau}_h\}}^0 \left| \left\{ \tilde{x} \in B_{\tilde{\varrho}_h}(0) \cap \tilde{\Omega} : v(\tilde{x}, \tilde{t}) > \tilde{k}_h \right\} \right| d\tilde{t}, \quad h = 0, 1, 2, \dots$$

Observing that $\tilde{k}_{h+1} = \tilde{k}_h + \frac{1}{2^{h+2}}$, we obtain the following estimate

$$\begin{aligned} \left(\frac{1}{2^{h+2}} \right)^2 z_{h+1} &\leq \int_{\max\{-\frac{t_0}{\varrho_0^2}; -\tilde{\tau}_{h+1}\}}^0 \int_{\left\{ \tilde{x} \in B_{\tilde{\varrho}_{h+1}}(0) \cap \tilde{\Omega} : v(\tilde{x}, \tilde{t}) > \tilde{k}_h + \frac{1}{2^{h+2}} \right\}} \left(\frac{1}{2^{h+2}} \right)^2 d\tilde{x} d\tilde{t} \\ &\leq \int_{\max\{-\frac{t_0}{\varrho_0^2}; -\tilde{\tau}_{h+1}\}}^0 \int_{\left\{ \tilde{x} \in B_{\tilde{\varrho}_{h+1}}(0) \cap \tilde{\Omega} : v(\tilde{x}, \tilde{t}) > \tilde{k}_h \right\}} (v - \tilde{k}_h)^2 d\tilde{x} d\tilde{t}. \end{aligned} \quad (\text{A.8.2.16})$$

Application of Hölder's inequality and Proposition A.6.1 to the right-hand side of this inequality yields

$$\begin{aligned} \left\| v(\tilde{k}_h) \right\|_{L^2(Q_{h+1} \cap \tilde{Q})}^2 &\leq \left\| v(\tilde{k}_h) \right\|_{L^{\frac{10}{3}}(Q_{h+1} \cap \tilde{Q})}^2 \left(\int_{\max\{-\frac{t_0}{\varrho_0^2}; -\tilde{\tau}_{h+1}\}}^0 \left| \left\{ \tilde{x} \in B_{\tilde{\varrho}_{h+1}}(0) \cap \tilde{\Omega} : v(\tilde{x}, \tilde{t}) > \tilde{k}_h \right\} \right| d\tilde{t} \right)^{\frac{2}{5}} \\ &\leq \beta^2 \left\| v(\tilde{k}_h) \right\|_{Q_{h+1} \cap \tilde{Q}}^2 z_h^{\frac{2}{5}}, \end{aligned} \quad (\text{A.8.2.17})$$

where β is defined in Proposition A.6.1. Assembling (A.8.2.16), (A.8.2.17) it follows

$$z_{h+1} \leq 4^{h+2} \beta^2 \left\| v(\tilde{k}_h) \right\|_{Q_{h+1} \cap \tilde{Q}}^2 z_h^{\frac{2}{5}}. \quad (\text{A.8.2.18})$$

On the other hand we clearly have by virtue of (A.8.2.13) that $1 \geq v - \tilde{k}_0 \geq v - \tilde{k}_h$ for all h a.e. in Q . Thus,

$$\begin{aligned} \gamma \left(\left[4^{h+2} + \frac{2^{h+3}}{3\theta} \right] \left\| v(\tilde{k}_h) \right\|_{L^2(Q_h \cap \tilde{Q})}^2 + \int_{\max\{-\frac{t_0}{\varrho_0^2}; -\tilde{\tau}_h\}}^0 \left| \left\{ x \in B_{\tilde{\varrho}_h}(0) \cap \tilde{\Omega} : v(x, \tilde{t}) > \tilde{k}_h \right\} \right| d\tilde{t} \right) \\ \leq \gamma \left(4^{h+2} + \frac{2^{h+3}}{3\theta} + 1 \right) z_h. \end{aligned} \quad (\text{A.8.2.19})$$

Inserting (A.8.2.18) and (A.8.2.19) into (A.8.2.15) yields

$$z_{h+1} \leq 16^{h+2} \beta^2 \gamma \left(2 + \frac{1}{3\theta} \right) z_h^{1+\frac{2}{5}} = \left[2^8 \beta^2 \gamma \left(2 + \frac{1}{3\theta} \right) \right] 16^h z_h^{1+\frac{2}{5}}.$$

Thus, by virtue of Lemma A.7.1 we have that $z_h \rightarrow 0$ for $h \rightarrow \infty$, provided that

$$z_0 \leq 2^{-45} \beta^{-5} \left(\gamma \max\{1, \varrho_0^3\} \left[2 + \frac{1}{3\theta} \right] \right)^{-\frac{5}{2}} \leq 2^{-45} \beta^{-5} \left(\gamma \left[2 + \frac{1}{3\theta} \right] \right)^{-\frac{5}{2}} = \theta_1$$

holds. Due to the conditions of the Lemma,

$$\begin{aligned} z_0 &= \int_{\max\left\{-\frac{t_0}{\varrho_0^2}; -\theta\right\}}^0 \left| \left\{ \tilde{x} \in B_1(0) \cap \tilde{\Omega} : v(\tilde{x}, \tilde{t}) > \tilde{k}_0 \right\} \right| d\tilde{t} \\ &= \varrho_0^{-5} |\{(x, t) \in Q_{\varrho_0} \cap Q : u(x, t) > k_0\}| \leq \theta_1 \end{aligned}$$

is satisfied, and consequently

$$\begin{aligned} & \left| \left\{ (x, t) \in Q_{\frac{\varrho_0}{2}} : u(x, t) > k_0 + \frac{H}{2} \right\} \right| \\ &= \varrho_0^5 \int_{\max\left\{-\frac{t_0}{\varrho_0^2}; -\frac{\theta}{4}\right\}}^0 \left| \left\{ x \in B_{\frac{1}{2}}(0) \cap \tilde{\Omega} : v(x, \tilde{t}) > \tilde{k}_0 + \frac{1}{2} \right\} \right| d\tilde{t} = \varrho_0^5 \lim_{h \rightarrow \infty} z_h = 0 \end{aligned}$$

follows. □

Lemma A.8.11 (Ch. 2, Lemma 7.3 in [43]). *Let $u \in \check{B}_2(\bar{Q}, M, \gamma)$ and let Ω satisfy Assumption A.8.1. Suppose that there exists a function $\phi \in C^{\varepsilon, \frac{\varepsilon}{2}}(\bar{Q})$, $\varepsilon \in (0, 1)$, such that $\phi \geq 0$ on $\Gamma \times (0, T)$, $\phi > 0$ on $\text{int}\Gamma' \times (0, T)$, and $\phi = 0$ on $(\Gamma \setminus \Gamma') \times (0, T)$ with Γ and Γ' as in Assumption A.8.1, and*

$$u(x, 0) = \phi(x, 0) \quad \text{a.e. in } \Omega, \quad \text{as well as} \quad (\gamma_0 u)^+ = \phi \quad \text{a.e. on } \Gamma \times (0, T).$$

Let $R_0 \leq 1$ be as in Assumption A.8.1 and for $x_0 \in \bar{\Omega}$, $0 < \varrho_0 < 2\varrho_0 \leq R_0$ we denote by B_{ϱ_0} ($B_{2\varrho_0}$) the ball centered at x_0 with radius ϱ_0 ($2\varrho_0$ resp.).

Then there exists a number $s > 0$ depending only on ε , $\|\phi(\cdot, 0)\|_{C^\varepsilon(\bar{\Omega})}$, R_0 , $\delta_1, \delta_2, \delta_3$ from Assumption A.8.1 and the constants β_1 and θ_1 from Lemmata A.7.3 and A.8.10 such that putting

$$Q_{2\varrho_0} := B_{2\varrho_0} \times (t_0 - 4\theta\varrho_0^2, t_0), \quad Q_{\varrho_0} := B_{\varrho_0} \times (t_0 - \theta\varrho_0^2, t_0),$$

for $t_0 > 0$ and θ as in Lemma A.8.9, one of the following implications holds

$$\textcircled{1} \quad \omega := \text{osc} \{u, Q_{2\varrho_0} \cap Q\} \leq 2^s \rho^{\min\{1; \varepsilon\}} \quad (\text{A.8.2.20a})$$

$$\textcircled{2} \quad \text{osc} \{u, Q_{2\varrho_0} \cap Q\} \leq 4 \text{osc} \{\phi; Q_{2\varrho_0} \cap Q\}, \quad (\text{A.8.2.20b})$$

$$\textcircled{3} \quad \left| \left\{ (x, t) \in Q_{\varrho_0} \cap Q : u > \sup_{Q_{2\varrho_0} \cap Q} u - \frac{\omega}{2^s} \right\} \right| \leq \theta_1 \rho^5, \quad (\text{A.8.2.20c})$$

and the level $k := \sup_{Q_{2\varrho_0} \cap Q} u - \frac{\omega}{2^{s-1}}$ satisfies (A.8.2.3),

$$\textcircled{4} \quad \left| \left\{ (x, t) \in Q_{\varrho_0} \cap Q : -u > \sup_{Q_{2\varrho_0} \cap Q} -u - \frac{\omega}{2^s} \right\} \right| \leq \theta_1 \rho^5, \quad (\text{A.8.2.20d})$$

and the level $k := \sup_{Q_{2\varrho_0} \cap Q} -u - \frac{\omega}{2^{s-1}}$ satisfies (A.8.2.3).

Proof: We follow the arguments of the proof of [43, Chapter 2, Lemma 7.3], but as in the elliptic case, also account for the mixed boundary conditions.

Let the conditions of the Lemma be satisfied and set

$$\omega := \sup_{Q_{2\varrho_0} \cap Q} u - \inf_{Q_{2\varrho_0} \cap Q} u = \text{osc} \{u; Q_{2\varrho_0} \cap Q\}. \quad (\text{A.8.2.21})$$

Suppose that $\omega > 2^s \rho^{\min\{1; \varepsilon\}}$, where s is a number to be determined later, and ε is as in the assertions of the Lemma.

We will distinguish the following cases

- ❶ $Q_{\varrho_0} \cap ((\Gamma \times (0, T)) \cup \Gamma_0) = \emptyset$,
- ❷ $Q_{\varrho_0} \cap (\Gamma_0) = \emptyset$, $x_0 \in \Gamma$,
- ❸ $Q_{\varrho_0} \cap \Gamma_0 \neq \emptyset$.

❶ Let us start with the first case, i.e. suppose that $Q_{\varrho_0} \cap ((\Gamma \times (0, T)) \cup \Gamma_0) = \emptyset$. So in particular $t_0 - \theta\varrho_0^2 > 0$, and $B_{\varrho_0}(x_0) \cap \Gamma = \emptyset$ hold (see Fig. A.8.4).

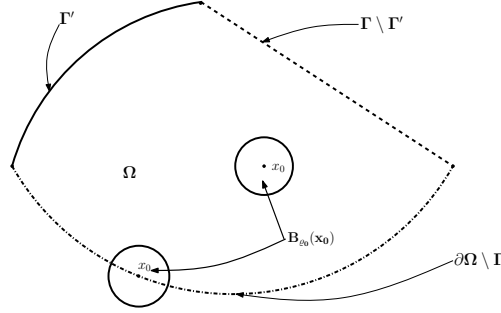

Figure A.8.4: The case ❶: $Q_{\varrho_0} \cap ((\Gamma \times (0, T)) \cup \Gamma_0) = \emptyset$

Computing

$$\sup_{Q_{2\varrho_0} \cap Q} u - \frac{\omega}{2} = \frac{\sup_{Q_{2\varrho_0} \cap Q} u}{2} + \frac{\inf_{Q_{2\varrho_0} \cap Q} u}{2} = \inf_{Q_{2\varrho_0} \cap Q} u + \frac{1}{2} \left(\sup_{Q_{2\varrho_0} \cap Q} u - \inf_{Q_{2\varrho_0} \cap Q} u \right) = \inf_{Q_{2\varrho_0} \cap Q} u + \frac{\omega}{2},$$

it follows that

$$\left\{ x \in B_{\varrho_0} \cap \Omega : u(x, t_0 - \theta\rho^2) \leq \sup_{Q_{2\varrho_0} \cap Q} u - \frac{\omega}{2} \right\} \cup \left\{ x \in B_{\varrho_0} \cap \Omega : u(x, t_0 - \theta\rho^2) \geq \inf_{Q_{2\varrho_0} \cap Q} u + \frac{\omega}{2} \right\} = B_{\varrho_0} \cap \Omega$$

is satisfied, so clearly either

$$\textcircled{1} \left| \left\{ x \in B_{\varrho_0} \cap \Omega : u(x, t_0 - \theta\rho^2) \leq \sup_{Q_{2\varrho_0} \cap Q} u - \frac{\omega}{2} \right\} \right| \geq \frac{1}{2} |B_{\varrho_0} \cap \Omega|$$

or

$$\textcircled{2} \left| \left\{ x \in B_{\varrho_0} \cap \Omega : u(x, t_0 - \theta\rho^2) \geq \inf_{Q_{2\varrho_0} \cap Q} u + \frac{\omega}{2} \right\} \right| \geq \frac{1}{2} |B_{\varrho_0} \cap \Omega|$$

must hold. In other words

$$\left| \left\{ x \in B_{\varrho_0} \cap \Omega : w(x, t_0 - \theta\rho^2) \leq \sup_{Q_{2\varrho_0} \cap Q} w - \frac{\omega}{2} \right\} \right| \geq \frac{1}{2} |B_{\varrho_0} \cap \Omega|$$

is satisfied with either $w = u$, or $w = -u$. Setting $\mu_+ = \sup_{Q_{2\varrho_0} \cap Q} w$, we follow

$$\left| \left\{ x \in B_{\varrho_0} \cap \Omega : w(x, t_0 - \theta\rho^2) \leq \mu_+ - \frac{\omega}{4} \right\} \right| \geq \frac{1}{2} |B_{\varrho_0} \cap \Omega|,$$

as $\mu_+ - \frac{\omega}{4} \geq \mu_+ - \frac{\omega}{2}$. This implies

$$\left| \left\{ x \in B_{\varrho_0} \cap \Omega : w(x, t_0 - \theta\rho^2) > \mu_+ - \frac{\omega}{4} \right\} \right| \leq \frac{1}{2} |B_{\varrho_0} \cap \Omega| \leq \frac{1}{2} |B_{\varrho_0}|.$$

Let us introduce an increasing sequence of levels $\{k_r\}_{r=1, \dots, s-1}$, with $s \geq 5$ to be determined later, defined by

$$k_r := \mu_+ - \frac{\omega}{2^r}, \quad r = 2, 3, \dots, s-1. \quad (\text{A.8.2.22})$$

Thus, for all $r \geq 2$

$$\left| \left\{ x \in B_{\varrho_0} \cap \Omega : w(x, t_0 - \theta\rho^2) > k_r \right\} \right| \leq \frac{1}{2} |B_{\varrho_0}| \quad (\text{A.8.2.23})$$

follows. Let us set $\bar{\mu}_+ := \sup_{Q_{\varrho_0} \cap Q} w$, and observe that

$$\text{either } \bar{\mu}_+ \leq \mu_+ - \frac{\omega}{2^s} \quad \text{or} \quad \bar{\mu}_+ > \mu_+ - \frac{\omega}{2^s}$$

hold.

If $\bar{\mu}_+ \leq \mu_+ - \frac{\omega}{2^s}$ we have

$$\left| \left\{ (x, t) \in Q_{\varrho_0} \cap Q : \bar{\mu}_+ > \mu_+ - \frac{\omega}{2^s} \right\} \right| = 0,$$

and consequently either (A.8.2.20c) or (A.8.2.20d) follows.

If $\bar{\mu}_+ > \mu_+ - \frac{\omega}{2^s}$ we deduce, bearing in mind that $\rho \leq 1$, $\varepsilon < 1$ and $\omega > 2^s \rho^\varepsilon > 2^s \rho$, the following inequality

$$H := \bar{\mu}_+ - \left(\mu_+ - \frac{\omega}{2^r} \right) \geq \frac{\omega}{2^r} - \frac{\omega}{2^s} = \frac{\omega}{2^s} (2^{s-r} - 1) \geq \frac{\omega}{2^s} > \rho. \quad (\text{A.8.2.24})$$

As in our case in particular $B_{\varrho_0} \cap \Gamma = \emptyset$ and $Q_{\varrho_0} \cap \Gamma_0 = \emptyset$, we find that any level k satisfying $k \geq \sup_{Q_{\varrho_0} \cap Q} w - 2M$ is admissible for (A.8.2.2a) and (A.8.2.2b) in the cylinder Q_{ϱ_0} .

Checking that $\frac{\omega}{4} \leq M$ holds, we deduce that for all $r \geq 2$ the levels k_r are admissible for (A.8.2.2a) and (A.8.2.2b) in the cylinder Q_{ϱ_0} . Thus, due to (A.8.2.23) and (A.8.2.24), we can apply Lemma A.8.9 in the cylinder Q_{ϱ_0} with the level k_r and obtain

$$\left| \left\{ x \in B_{\varrho_0} \cap \Omega : w(x, t) \leq \mu_+ - \frac{\omega}{2^r} + \frac{3}{4}H \right\} \right| \geq \frac{1}{18} |B_{\varrho_0} \cap \Omega|$$

for all $t \in [t_0 - \theta\rho^2, t_0]$. Moreover, we calculate

$$\mu_+ - \frac{\omega}{2^r} + \frac{3}{4}H \leq \mu_+ - \frac{\omega}{2^r} + \frac{3}{4} \frac{\omega}{2^r} = \mu_+ - \frac{\omega}{2^{r+2}}.$$

Hence in particular,

$$\left| \left\{ x \in B_{\varrho_0} \cap \Omega : w(x, t) \leq \mu_+ - \frac{\omega}{2^{r+2}} \right\} \right| \geq \frac{1}{18} |B_{\varrho_0} \cap \Omega| \quad (\text{A.8.2.25})$$

is satisfied for all $t \in [t_0 - \theta\rho^2, t_0]$. As by virtue of Assumption A.8.1 $B_{\varrho_0} \cap \Omega$ is convex, application of Lemma A.7.3 with the choice $k = k_r$ and $l = k_{r+1}$, $r \geq 4$ yields for all $t \in [t_0 - \theta\rho^2, t_0]$

$$(k_{r+1} - k_r) |\{x \in B_{\varrho_0} \cap \Omega : w(x, t) \geq k_{r+1}\}| \leq \frac{\beta_1 \rho^4}{|\{x \in B_{\varrho_0} \cap \Omega : w(x, t) \leq k_r\}|} \int_{\{x \in B_{\varrho_0} \cap \Omega : k_r < w(x, t) \leq k_{r+1}\}} |\nabla w(x, t)| \, dx,$$

where β_1 is as in Lemma A.7.3.

Exploiting inequality (A.8.2.25) and Assumption A.8.1(i) we deduce for all $r \geq 4$ the following estimate

$$\frac{1}{|\{x \in B_{\varrho_0} \cap \Omega : w(x, t) \leq k_r\}|} \leq \frac{18}{|B_{\varrho_0} \cap \Omega|} \leq \frac{18}{\delta_1 |B_{\varrho_0}|} = \frac{18}{\delta_1 |B_1| \rho^3}$$

where δ_1 is as in Assumption A.8.1(i), and consequently we arrive for all $t \in [t_0 - \theta\rho^2, t_0]$ at

$$\frac{\omega}{2^{r+1}} |\{x \in B_{\varrho_0} \cap \Omega : w(x, t) \geq k_{r+1}\}| \leq \frac{18\beta_1}{\delta_1 |B_1|} \rho \int_{\{x \in B_{\varrho_0} \cap \Omega : k_r < w(x, t) \leq k_{r+1}\}} |\nabla w(x, t)| \, dx. \quad (\text{A.8.2.26})$$

Let us now proceed with the cases **2** and **3**, i.e. in particular suppose that $Q_{\varrho_0} \cap ((\Gamma \times (0, T)) \cup \Gamma_0) \neq \emptyset$. Defining

$$\phi_+^0 := \sup_{Q_{2\rho} \cap \Gamma_0} \phi, \quad \phi_-^0 := \inf_{Q_{2\rho} \cap \Gamma_0} \phi, \quad \omega_\phi^0 := \phi_+^0 - \phi_-^0 = \text{osc} \{ \phi(x, 0); B_{2\varrho_0} \cap \Omega \}$$

and

$$\begin{aligned} \phi_+^1 &:= \sup_{Q_{2\rho} \cap (\Gamma \times (0, T))} \phi, & \phi_-^1 &:= \inf_{Q_{2\rho} \cap (\Gamma \times (0, T))} \phi, \\ \omega_\phi^1 &:= \phi_+^1 - \phi_-^1 = \text{osc} \{ (\gamma_0 \phi)^+; Q_{2\varrho_0} \cap (\Gamma \times (0, T)) \}, \end{aligned}$$

we observe, that either

① both

$$\sup_{Q_{2\varrho_0} \cap Q} u - \frac{\omega}{4} \leq \max \{ \phi_+^0, \phi_+^1 \} \quad (\text{A.8.2.27a})$$

and

$$- \inf_{Q_{2\varrho_0} \cap Q} u - \frac{\omega}{4} \leq - \min \{ \phi_-^0, \phi_-^1 \} \quad (\text{A.8.2.27b})$$

must hold, or

② either

$$\sup_{Q_{2\varrho_0} \cap Q} u - \frac{\omega}{4} \geq \max \{ \phi_+^0, \phi_+^1 \}, \quad (\text{A.8.2.28a})$$

or

$$\inf_{Q_{2\varrho_0} \cap Q} u + \frac{\omega}{4} \leq \min \{ \phi_-^0, \phi_-^1 \} \quad (\text{A.8.2.28b})$$

must be satisfied.

In the first case we clearly have adding (A.8.2.27a) and (A.8.2.27b)

$$\frac{\omega}{2} = \sup_{Q_{2\varrho_0} \cap Q} u - \inf_{Q_{2\varrho_0} \cap Q} u - \frac{\omega}{2} \leq \max \{ \phi_+^0, \phi_+^1 \} - \min \{ \phi_-^0, \phi_-^1 \} \leq \omega_\phi^0 + \omega_\phi^1,$$

and therefore (A.8.2.20b) follows.

Let us proceed with the second case and suppose that

$$\text{either } \sup_{Q_{2\varrho_0} \cap Q} u - \frac{\omega}{4} \geq \max \{ \phi_+^0, \phi_+^1 \} \quad \text{or} \quad \inf_{Q_{2\varrho_0} \cap Q} u + \frac{\omega}{4} \leq \min \{ \phi_-^0, \phi_-^1 \} \quad (\text{A.8.2.29})$$

holds.

We turn our attention to the case \ominus , i.e. we assume that $Q_{\varrho_0} \cap \Gamma_0 = \emptyset$ and $x_0 \in \Gamma$.

Suppose first, that

$$\sup_{Q_{2\varrho_0} \cap Q} u - \frac{\omega}{4} \geq \max \{ \phi_+^0; \phi_+^1 \}$$

holds. Since by assumption $\phi > 0$ on $\text{int}\Gamma' \times (0, T)$, and $\phi = 0$ on $(\Gamma \setminus \Gamma') \times (0, T)$, we find

$$\begin{aligned} k' := \sup_{Q_{2\varrho_0} \cap Q} u - \frac{\omega}{4} &\geq \max \left\{ 0; \sup_{Q_{2\varrho_0} \cap \Gamma' \times (0, T)} \phi; \sup_{Q_{2\varrho_0} \cap Q} u - 2M \right\} \\ &\geq \max \left\{ 0; \sup_{Q_{\varrho_0} \cap \Gamma' \times (0, T)} \phi; \sup_{Q_\rho \cap Q} u - 2M \right\} \end{aligned}$$

and consequently all $k \geq k'$ are admissible levels for (A.8.2.2a) and (A.8.2.2b) in the cylinder Q_{ϱ_0} .

Considering again the increasing sequence of levels $\{k_r\}_{r=1, \dots, s-1}$ defined as in (A.8.2.22) by

$$k_r := \sup_{Q_{2\varrho_0} \cap Q} u - \frac{\omega}{2^r}, \quad r = 2, 3, \dots, s-1,$$

it follows that for $r \geq 2$ the levels k_r are admissible for (A.8.2.2a) and (A.8.2.2b) in the cylinder Q_{ϱ_0} .

Clearly, it suffices to consider the following two subcases illustrated in Fig. A.8.5.

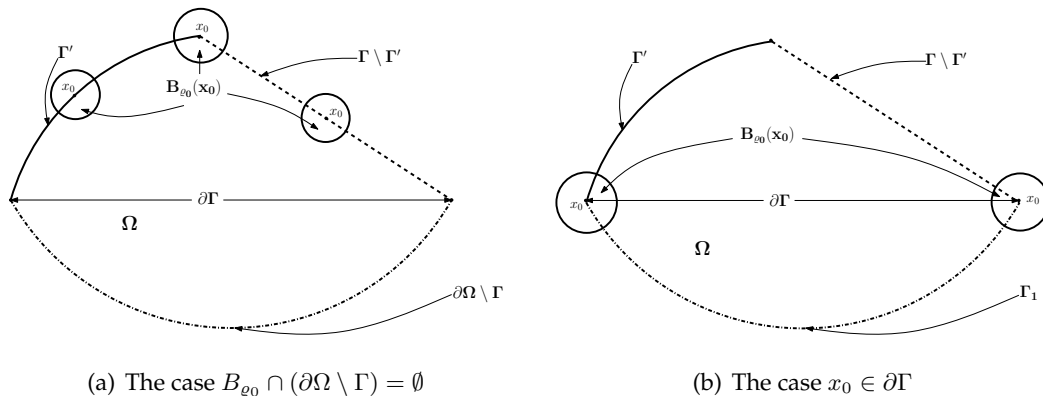

Figure A.8.5: Different positions of the balls B_{ϱ_0} in the case $\sup_{Q_{2\varrho_0} \cap Q} u - \frac{\omega}{4} \geq \max \{ \phi_+^0, \phi_+^1 \}$

- (a) We start with the case $B_{\varrho_0} \cap (\partial\Omega \setminus \Gamma) = \emptyset$. In this situation $(u - k_r)^+$ vanishes on $B_{\varrho_0} \cap \partial\Omega$ for all $t \in [t_0 - \theta\rho^2, t_0]$. Hence, extending $(u - k_r)^+$ for all $t \in [t_0 - \theta\rho^2, t_0]$ trivially to B_{ϱ_0} and applying Lemma A.7.3 to the function $(u - k_r)^+$ we obtain for any $l > k \geq 0$ and all $t \in [t_0 - \theta\rho^2, t_0]$ the following inequality

$$(l - k) \left| \left\{ x \in B_{\varrho_0} : (u - k_r)^+ > l \right\} \right| \leq \frac{\beta_1 \rho^4}{\left| \left\{ x \in B_{\varrho_0} : (u - k_r)^+ \leq k \right\} \right|} \int_{\left\{ x \in B_{\varrho_0} : k < (u - k_r)^+ \leq l \right\}} |\nabla(u - k_r)^+| \, dx.$$

Choosing $k = 0$ and $l = \frac{\omega}{2^{r+1}}$ the preceding inequality yields

$$\frac{\omega}{2^{r+1}} \left| \left\{ x \in B_{\varrho_0} : (u - k_r)^+ > \frac{\omega}{2^{r+1}} \right\} \right| \leq \frac{\beta_1 \rho^4}{\left| \left\{ x \in B_{\varrho_0} : (u - k_r)^+ \leq 0 \right\} \right|} \int_{\left\{ x \in B_{\varrho_0} : 0 < (u - k_r)^+ \leq \frac{\omega}{2^{r+1}} \right\}} |\nabla(u - k_r)^+| \, dx.$$

As $(u - k_r)^+ > 0$ only inside $B_{\varrho_0} \cap \Omega$, we infer

$$\frac{\omega}{2^{r+1}} \left| \left\{ x \in B_{\varrho_0} \cap \Omega : u > k_{r+1} \right\} \right| \leq \frac{\beta_1 \rho^4}{\left| \left\{ x \in B_{\varrho_0} : (u - k_r)^+ \leq 0 \right\} \right|} \int_{\left\{ x \in B_{\varrho_0} \cap \Omega : k_r < u \leq k_{r+1} \right\}} |\nabla u(x, t)| \, dx.$$

Moreover, by virtue of Assumption A.8.1(ii)

$$\left| \left\{ x \in B_{\varrho_0} : (u - k_r)^+ \leq 0 \right\} \right| \geq |B_{\varrho_0}| - |B_{\varrho_0} \cap \Omega| \geq \delta_2 |B_{\varrho_0}|$$

holds with δ_2 as in Assumption A.8.1(ii), and consequently

$$\frac{\omega}{2^{r+1}} \left| \left\{ x \in B_{\varrho_0} \cap \Omega : u > k_{r+1} \right\} \right| \leq \frac{\beta_1}{\delta_2 |B_1|} \rho \int_{\left\{ x \in B_{\varrho_0} \cap \Omega : k_r < u \leq k_{r+1} \right\}} |\nabla u(x, t)| \, dx \quad (\text{A.8.2.30})$$

is satisfied for all $t \in [t_0 - \theta\rho^2, t_0]$.

- (b) We proceed with the case $x_0 \in \partial\Gamma$, and take $\tilde{\Omega}$ to be a convex $C^{0,1}$ -domain as in Assumption A.8.1(iii). So in particular with δ_3 as in Assumption A.8.1(iii),

$$|\Omega \cap B_{\varrho_0}| \leq \left| \tilde{\Omega} \cap B_{\varrho_0} \right| - \delta_3 |B_{\varrho_0}|$$

holds.

As $(u - k_r)^+$ vanishes on $B_{\varrho_0} \cap \Gamma$ for all $t \in [t_0 - \theta\rho^2, t_0]$, we can extend $(u - k_r)^+$ for all $t \in [t_0 - \theta\rho^2, t_0]$ trivially to $\tilde{\Omega} \cap B_{\varrho_0}$. As $\tilde{\Omega}$ is convex by assumption, we obtain applying Lemma A.7.3 to the function $(u - k_r)^+$ for any $l > k$ and all $t \in [t_0 - \theta\rho^2, t_0]$ the following inequality

$$(l - k) \left| \left\{ x \in \tilde{\Omega} \cap B_{\varrho_0} : (u - k_r)^+ > l \right\} \right|$$

$$\leq \frac{\beta_1 \rho^4}{\left| \left\{ x \in \tilde{\Omega} \cap B_{\varrho_0} : (u - k_r)^+ \leq k \right\} \right|} \int_{\left\{ x \in \tilde{\Omega} \cap B_{\varrho_0} : k < (u - k_r)^+ \leq l \right\}} |\nabla(u - k_r)^+| dx.$$

Choosing $k = 0$ and $l = \frac{\omega}{2^{r+1}}$, the preceding inequality turns into

$$\begin{aligned} & \frac{\omega}{2^{r+1}} \left| \left\{ x \in \tilde{\Omega} \cap B_{\varrho_0} : (u - k_r)^+ > \frac{\omega}{2^{r+1}} \right\} \right| \\ & \leq \frac{\beta_1 \rho^4}{\left| \left\{ x \in \tilde{\Omega} \cap B_{\varrho_0} : (u - k_r)^+ \leq 0 \right\} \right|} \int_{\left\{ x \in \tilde{\Omega} \cap B_{\varrho_0} : 0 < (u - k_r)^+ \leq \frac{\omega}{2^{r+1}} \right\}} |\nabla(u - k_r)^+| dx, \end{aligned}$$

and since $(u - k_r)^+ > 0$ only inside $B_{\varrho_0} \cap \Omega$ we find

$$\begin{aligned} & \frac{\omega}{2^{r+1}} |\{x \in B_{\varrho_0} \cap \Omega : u > k_{r+1}\}| \\ & \leq \frac{\beta_1 \rho^4}{\left| \left\{ x \in \tilde{\Omega} \cap B_{\varrho_0} : (u - k_r)^+ \leq 0 \right\} \right|} \int_{\{x \in B_{\varrho_0} \cap \Omega : k_r < u \leq k_{r+1}\}} |\nabla u(x, t)| dx. \end{aligned}$$

Furthermore, Assumption A.8.1(iii) implies

$$\left| \left\{ x \in \tilde{\Omega} \cap B_{\varrho_0} : (u - k_r)^+ \leq 0 \right\} \right| \geq \left| \tilde{\Omega} \cap B_{\varrho_0} \right| - |B_{\varrho_0} \cap \Omega| \geq \delta_3 |B_{\varrho_0}|,$$

where δ_3 as in Assumption A.8.1(iii), and therefore

$$\frac{\omega}{2^{r+1}} |\{x \in B_{\varrho_0} \cap \Omega : u > k_{r+1}\}| \leq \frac{\beta_1}{\delta_3 |B_1|} \rho \int_{\{x \in B_{\varrho_0} \cap \Omega : k_r < u \leq k_{r+1}\}} |\nabla u(x, t)| dx. \quad (\text{A.8.2.31})$$

follows for all $t \in [t_0 - \theta \rho^2, t_0]$.

Now, let us consider the case

$$\inf_{Q_{2\varrho_0} \cap Q} u + \frac{\omega}{4} \leq \min \{ \phi_-^0; \phi_-^1 \}.$$

We distinguish the following three subcases illustrated in Fig. A.8.6

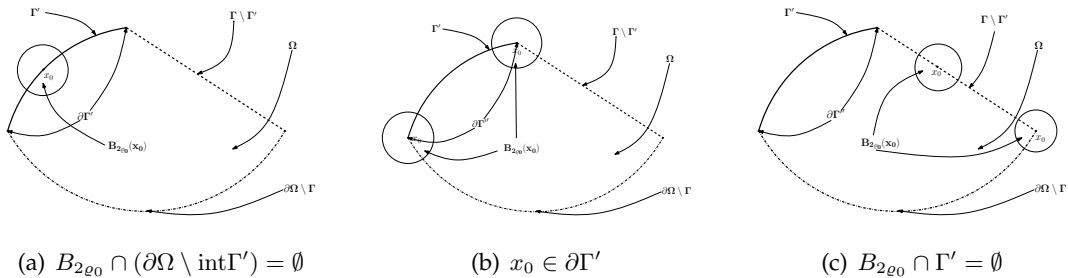

Figure A.8.6: Different positions of the balls B_{ϱ_0} in the case $\inf_{Q_{2\varrho_0} \cap Q} u + \frac{\omega}{4} \leq \min \{ \phi_-^0; \phi_-^1 \}$

- (a) Suppose that $B_{2\varrho_0} \cap (\partial\Omega \setminus \text{int}\Gamma') = \emptyset$. In this case, we have by virtue of assumptions $\phi > 0$ on $\text{int}\Gamma' \times (0, T)$, that $(\gamma_0 u)^+ = \phi$ a.e. on $Q_{2\varrho_0} \cap (\Gamma' \times (0, T))$ and consequently

$$\sup_{\Gamma' \times (0, T) \cap Q_{2\varrho_0}} -(\gamma_0 u)^+ = \sup_{\Gamma' \times (0, T) \cap Q_{2\varrho_0}} -\phi = -\phi_-^1 \leq \sup_{Q_{2\varrho_0} \cap Q} -u - \frac{\omega}{4}.$$

Thus, for all $r \geq 2$, the levels \bar{k}_r defined by

$$\bar{k}_r := \sup_{Q_{2\varrho_0} \cap Q} -u - \frac{\omega}{2r}$$

are admissible for (A.8.2.2b), and in particular $(-u - \bar{k}_r)^+ = 0$ a.e. on $B_{\varrho_0} \cap \partial\Omega$ for all $t \in [0, t_0 - \theta\rho^2, t_0]$. Extending $(-u - k_r)^+ = 0$ for all $t \in [t_0 - \theta\rho^2, t_0]$ trivially to B_{ϱ_0} , we obtain analogously to the case $\sup_{Q_{2\varrho_0} \cap Q} u - \frac{\omega}{4} \geq \max\{\phi_+^0; \phi_+^1\}$ the following estimate for the function $-u$

$$\frac{\omega}{2^{r+1}} |\{x \in B_{\varrho_0} \cap \Omega : -u > \bar{k}_{r+1}\}| \leq \frac{\beta_1}{\delta_2 |B_1|} \rho \int_{\{x \in B_{\varrho_0} \cap \Omega : \bar{k}_r < -u \leq \bar{k}_{r+1}\}} |-\nabla u(x, t)| dx. \quad (\text{A.8.2.32})$$

with δ_2 as in Assumption A.8.1(ii).

- (b) Suppose now $x_0 \in \partial\Gamma'$. As in the case considered in (a), we have by virtue of assumptions $\phi \geq 0$ on $\Gamma \times (0, T)$, $\phi > 0$ on $\text{int}\Gamma' \times (0, T)$, and $(\gamma_0 u)^+ = \phi$ a.e. on $\Gamma \times (0, T)$, that $\gamma_0 u = \phi$ a.e. on $Q_{2\varrho_0} \cap (\Gamma' \times (0, T))$. Then since $\phi = 0$ on $Q_{2\varrho_0} \cap ((\Gamma \setminus \Gamma') \times (0, T))$, we infer

$$0 = \sup_{\Gamma \times (0, T) \cap Q_{2\varrho_0}} -\phi = -\phi_-^1 \leq -\mu_- - \frac{\omega}{4} = \sup_{Q_{2\varrho_0} \cap Q} -u - \frac{\omega}{4}.$$

Thus, again for all $r \geq 2$, the levels \bar{k}_r defined by

$$\bar{k}_r := \sup_{Q_{2\varrho_0} \cap Q} -u - \frac{\omega}{2r}$$

are admissible for (A.8.2.2b), and in particular $(-u - \bar{k}_r)^+ = 0$ holds a.e. on $B_{\varrho_0} \cap \Gamma'$ for all $t \in [t_0 - \theta\rho^2, t_0]$. Let us consider the set $\tilde{\Omega}'$ as in Assumption A.8.1 (iii). Extending $(-u - k_r)^+ = 0$ for all $t \in [t_0 - \theta\rho^2, t_0]$ trivially to $\tilde{\Omega}' \cap B_{\varrho_0}$, we obtain similarly to the case $\sup_{Q_{2\varrho_0} \cap Q} u - \frac{\omega}{4} \geq \max\{\phi_+^0; \phi_+^1\}$ the following estimate for the function $-u$

$$\frac{\omega}{2^{r+1}} |\{x \in B_{\varrho_0} \cap \Omega : -u > \bar{k}_{r+1}\}| \leq \frac{\beta_1}{\delta_3 |B_1|} \rho \int_{\{x \in B_{\varrho_0} \cap \Omega : \bar{k}_r < -u \leq \bar{k}_{r+1}\}} |-\nabla u(x, t)| dx. \quad (\text{A.8.2.33})$$

with δ_3 as in Assumption A.8.1(iii).

- (c) Finally, we turn our attention to the case $B_{2\varrho_0} \cap \Gamma' = \emptyset$. Analogously to the case considered in (b), we infer

$$0 \leq \sup_{Q_{2\varrho_0} \cap Q} -u - \frac{\omega}{4}.$$

and proceed as in the case considered in **1**. Checking again, that

$$\sup_{Q_{2\varrho_0} \cap Q} u - \frac{\omega}{2} = \inf_{Q_{2\varrho_0} \cap Q} u + \frac{\omega}{2}.$$

holds, we obtain again that either

$$\textcircled{1} \left| \left\{ x \in B_{\varrho_0} \cap \Omega : u(x, t_0 - \theta\rho^2) \leq \mu_+ - \frac{\omega}{2} \right\} \right| \geq \frac{1}{2} |B_{\varrho_0} \cap \Omega|$$

or

$$\textcircled{2} \left| \left\{ x \in B_{\varrho_0} \cap \Omega : u(x, t_0 - \theta\rho^2) \geq \mu_- + \frac{\omega}{2} \right\} \right| \geq \frac{1}{2} |B_{\varrho_0} \cap \Omega|$$

must hold. Let us assume that the first inequality is satisfied. Hence, it follows

$$\left| \left\{ x \in B_{\varrho_0} \cap \Omega : u(x, t_0 - \theta\rho^2) > \sup_{Q_{2\varrho_0} \cap Q} u - \frac{\omega}{4} \right\} \right| \leq \frac{1}{2} |B_{\varrho_0} \cap \Omega| \leq \frac{1}{2} |B_{\varrho_0}|.$$

As in particular $B_{\varrho_0} \cap \Gamma' = \emptyset$, we have

$$\sup_{Q_{\varrho_0} \cap \Gamma' \times [0, T]} -\phi = -\infty$$

and therefore all the levels k_r defined for $r \geq 2$ by

$$k_r := \sup_{Q_{2\varrho_0} \cap Q} u - \frac{\omega}{2^r}$$

are admissible for (A.8.2.2a) and (A.8.2.2b). Furthermore, for all $r \geq 2$

$$|\{x \in B_{\varrho_0} \cap \Omega : u(x, t_0 - \theta\rho^2) > k_r\}| \leq \frac{1}{2} |B_{\varrho_0}| \quad (\text{A.8.2.34})$$

is satisfied. Let us set $\bar{\mu}_+ := \sup_{Q_{\varrho_0} \cap Q} u$ and observe as in case \bullet that either (A.8.2.20c) holds, or

$$H := \bar{\mu}_+ - \left(\sup_{Q_{2\varrho_0} \cap Q} u - \frac{\omega}{2^r} \right) > \varrho_0 \quad (\text{A.8.2.35})$$

is satisfied. Then, application of Lemma A.8.9 in the cylinder Q_{ϱ_0} with the level k_r yields in particular, that

$$\left| \left\{ x \in B_{\varrho_0} \cap \Omega : u(x, t) \leq \sup_{Q_{2\varrho_0} \cap Q} u - \frac{\omega}{2^{r+2}} \right\} \right| \geq \frac{1}{18} |B_{\varrho_0} \cap \Omega| \quad (\text{A.8.2.36})$$

is satisfied for all $t \in [t_0 - \theta\rho^2, t_0]$.

Due to Assumption A.8.1 and to Lemma A.7.3, we obtain for all $t \in [t_0 - \theta\rho^2, t_0]$

$$\begin{aligned} & (k_{r+1} - k_r) |\{x \in B_{\varrho_0} \cap \Omega : u(x, t) \geq k_{r+1}\}| \\ & \leq \frac{\beta_1 \rho^4}{|\{x \in B_{\varrho_0} \cap \Omega : u(x, t) \leq k_r\}|} \int_{\{x \in B_{\varrho_0} \cap \Omega : k_r < u(x, t) \leq k_{r+1}\}} |\nabla u(x, t)| \, dx, \end{aligned}$$

where β_1 is defined in Lemma A.7.3.

And consequently, exploiting inequality (A.8.2.36) and Assumption A.8.1(i), we find for all $r \geq 4$ and all $t \in [t_0 - \theta\rho^2, t_0]$

$$\frac{\omega}{2^{r+1}} |\{x \in B_{\varrho_0} \cap \Omega : u(x, t) \geq k_{r+1}\}| \leq \frac{18\beta_1}{\delta_1 |B_1|} \rho \int_{\{x \in B_{\varrho_0} \cap \Omega : k_r < u(x, t) \leq k_{r+1}\}} |\nabla u(x, t)| \, dx. \quad (\text{A.8.2.37})$$

Bearing in mind, that $0 = -\phi_-^1 \leq -\mu_- - \frac{\omega}{4}$, we obtain that for all $r \geq 2$ the levels \bar{k}_r defined by

$$\bar{k}_r := \sup_{Q_{2\varrho_0} \cap Q} -u - \frac{\omega}{2r}$$

are admissible levels for the function $-u$ in the cylinders Q_{ϱ_0} . Thus, in the case

$$\left| \left\{ x \in B_{\varrho_0} \cap \Omega : u(x, t_0 - \theta\rho^2) \geq \mu_- + \frac{\omega}{2} \right\} \right| \geq \frac{1}{2} |B_{\varrho_0} \cap \Omega|$$

it follows, that either (A.8.2.20d) holds, or the function $-u$ satisfies for all $r \geq 2$ and all $t \in [t_0 - \theta\rho^2, t_0]$ the following inequality

$$\frac{\omega}{2^{r+1}} \left| \left\{ x \in B_{\varrho_0} \cap \Omega : -u(x, t) \geq \bar{k}_{r+1} \right\} \right| \leq \frac{18\beta_1}{\delta_1 |B_1|} \rho \int_{\{x \in B_{\varrho_0} \cap \Omega : \bar{k}_r < u(x, t) \leq \bar{k}_{r+1}\}} |-\nabla u(x, t)| dx \quad (\text{A.8.2.38})$$

with β_1 as in Lemma A.7.3 and δ_1 as in Assumption A.8.1(i).

Finally, let us now consider case **Ⓞ**, i.e. suppose that $t_0 - \theta\rho^2 \leq 0$, and $x_0 \in \bar{\Omega}$.

By virtue of (A.8.2.29)

$$w(x, 0) \leq \sup_{Q_{2\varrho_0} \cap Q} w - \frac{\omega}{4}, \quad \text{for a.a. } x \in B_{\varrho_0} \cap \Omega$$

holds with either $w = u$ or $w = -u$.

Setting $\mu_+ := \sup_{Q_{2\varrho_0} \cap Q} w$, and considering again the increasing sequence of levels $\{k_r\}_{r=1, \dots, s-1}$ defined as in (A.8.2.22) by

$$k_r := \mu_+ - \frac{\omega}{2^r}, \quad r = 2, 3, \dots, s-1,$$

we observe that either

$$k_r \geq \sup_{Q_{2\varrho_0} \cap Q} u - \frac{\omega}{4} \geq \max\{\phi_+^0, \phi_+^1\}, \quad \text{or} \quad k_r \geq \sup_{Q_{2\varrho_0} \cap Q} -u - \frac{\omega}{4} \geq \max\{-\phi_-^0, -\phi_-^1\}, \quad \forall r \geq 2$$

holds, and hence we see similarly as in the case **Ⓜ** that the levels k_r are admissible for (A.8.2.2a) and (A.8.2.2b) in the cylinder Q_{ϱ_0} for $r \geq 2$. Moreover,

$$\left| \left\{ x \in B_{\varrho_0} \cap \Omega : w(x, 0) > k_r \right\} \right| \leq \left| \left\{ x \in B_{\varrho_0} \cap \Omega : w(x, 0) > \mu_+ - \frac{\omega}{4} \right\} \right| = 0$$

is satisfied for all $r \geq 2$. This implies

$$\left| \left\{ x \in B_{\varrho_0} \cap \Omega : w(x, 0) > k_r \right\} \right| = 0 \leq \frac{1}{2} |B_{\varrho_0}|, \quad \forall r = 2, 3, \dots, s-1 \quad (\text{A.8.2.39})$$

with $w = u$, or $w = -u$.

Let us set again $\bar{\mu}_+ := \sup_{Q_{\varrho_0} \cap Q} w$. Thus we have as in case **Ⓛ** that either (A.8.2.20c) or (A.8.2.20d) is satisfied or

$$H := \bar{\mu}_+ - \left(\mu_+ - \frac{\omega}{2^r} \right) \geq \frac{\omega}{2^r} - \frac{\omega}{2^s} = \frac{\omega}{2^s} (2^{s-r} - 1) \geq \frac{\omega}{2^s} > \varrho_0 \quad (\text{A.8.2.40})$$

holds.

Application of Lemma A.8.9 in the cylinder Q_{ϱ_0} with the level set k_r , with $r \geq 2$, yields for all $t \in [0, t_0]$ as in the case **1**

$$\left| \left\{ x \in B_{\varrho_0} \cap \Omega : w(x, t) \leq \mu_+ - \frac{\omega}{2^{r+2}} \right\} \right| \geq \frac{1}{18} |B_{\varrho_0} \cap \Omega|. \quad (\text{A.8.2.41})$$

Again, as due to Assumption A.8.1 $B_{\varrho_0} \cap \Omega$ is convex, we obtain by virtue of Lemma A.7.3 for $r \geq 4$ and all $t \in [0, t_0]$

$$\begin{aligned} & (k_{r+1} - k_r) |\{x \in B_{\varrho_0} \cap \Omega : w(x, t) \geq k_{r+1}\}| \\ & \leq \frac{\beta_1 \rho^4}{|\{x \in B_{\varrho_0} \cap \Omega : w(x, t) \leq k_r\}|} \int_{\{x \in B_{\varrho_0} \cap \Omega : k_r < u(x, t) \leq k_{r+1}\}} |\nabla w(x, t)| \, dx, \end{aligned}$$

so consequently exploiting inequality (A.8.2.41) and Assumption A.8.1(i) we find for all $t \in [0, t_0]$

$$\frac{\omega}{2^{r+1}} |\{x \in B_{\varrho_0} \cap \Omega : w(x, t) \geq k_{r+1}\}| \leq \frac{18\beta_1}{\delta_1 |B_1|} \rho \int_{\{x \in B_{\varrho_0} \cap \Omega : k_r < w(x, t) \leq k_{r+1}\}} |\nabla w(x, t)| \, dx. \quad (\text{A.8.2.42})$$

Let R_0 be as in the conditions of the Lemma. Then, assembling the estimates obtained in **1**, **2**, and **3**, we infer that for $r \geq 4$ and a constant c_0 depending only on Ω , R_0 , and $\delta_1, \delta_2, \delta_3$

$$\frac{\omega}{2^{r+1}} |\{x \in B_{\varrho_0} \cap \Omega : w > k_{r+1}\}| \leq \frac{\beta_1 c_0}{|B_1|} \rho \int_{\{x \in B_{\varrho_0} \cap \Omega : k_r < w \leq k_{r+1}\}} |\nabla w(x, t)| \, dx \quad (\text{A.8.2.43})$$

is satisfied, where either $w = u$, or $w = -u$, and

$$k_r := \sup_{Q_{2\varrho_0} \cap Q} w - \frac{\omega}{2^r}, \quad r = 4, \dots, s-1.$$

Integrating inequality (A.8.2.43) over $[\max\{0; t_0 - \theta\rho^2\}, t_0]$, taking both sides of the result to the power 2, and using the Cauchy-Schwarz inequality we obtain

$$\begin{aligned} & \left(\frac{\omega}{2^{r+1}} \right)^2 |\{x \in Q_{\varrho_0} \cap Q : w > k_{r+1}\}|^2 \\ & \leq \left(\frac{\beta_1 c_0}{|B_1|} \right)^2 \rho^2 \int_{\max\{0; t_0 - \theta\rho^2\}}^{t_0} \int_{\{x \in B_{\varrho_0} \cap \Omega : k_r < w \leq k_{r+1}\}} |\nabla u(x, t)|^2 \, dx \, dt \times \\ & \quad \times \int_{\max\{0; t_0 - \theta\rho^2\}}^{t_0} |\{x \in B_{\varrho_0} \cap \Omega : k_r < w \leq k_{r+1}\}| \, dt. \end{aligned}$$

Keeping in mind that for all $r \geq 4$ all the levels k_r are admissible for (A.8.2.2b) in the cylinders $Q(\rho, \tau) = Q_{2\varrho_0}$ and $Q((1 - \sigma_1)\rho, (1 - \sigma_2)\tau) = Q_{\varrho_0}$, we find

$$\begin{aligned} & \int_{\max\{0; t_0 - \theta\rho^2\}}^{t_0} \int_{\{x \in B_{\varrho_0} \cap \Omega : k_r < w \leq k_{r+1}\}} |\nabla w(x, t)|^2 \, dx \, dt \\ & \leq \left\| w^{(\mu_+ - \frac{\omega}{2^r})} \right\|_{Q_{\varrho_0} \cap Q}^2 \\ & \leq \gamma \left[\left(\frac{1}{\rho^2} + \frac{1}{3\theta\rho^2} \right) \left(\frac{\omega}{2^r} \right)^2 |Q_{2\varrho_0} \cap Q| + |Q_{2\varrho_0} \cap Q| \right], \end{aligned}$$

and consequently, recalling that $2^s \rho \leq \omega$, we obtain

$$|\{x \in Q_{\varrho_0} \cap Q : u > k_{r+1}\}|^2 \leq C \rho^5 \int_{\max\{0; t_0 - \theta \rho^2\}}^{t_0} |\{x \in B_{\varrho_0} \cap \Omega : k_r < w \leq k_{r+1}\}| dt$$

with

$$C := 2^9 |B_1| \gamma \left[2\theta + \frac{1}{3} \right] \left(\frac{\beta_1 c_0}{|B_1|} \right)^2.$$

Summing the preceding inequality over $r \in [4, s-1]$ we obtain

$$(s-4) \left| \left\{ (x, t) \in Q_{\varrho_0} \cap Q; w(x, t) > \sup_{Q_{2\varrho_0} \cap Q} w - \frac{\omega}{2^s} \right\} \right|^2 \leq C \theta |B_1| \rho^{10}.$$

Choosing $s = \max \left\{ 2 + \varepsilon + \log_2 \left(\|\phi^0\|_{C^\varepsilon(\overline{\Omega})} \right); 5 + \left\lfloor \frac{C\theta}{\theta_1^2} \right\rfloor \right\}$, the claim follows. \square

Let us now prove a consequence of Lemmata A.8.9, A.8.10, and A.8.11 which reads as follows.

Lemma A.8.12. *Let $u \in \check{B}_2(\overline{Q}, M, \gamma)$ and let Ω satisfy Assumption A.8.1. Suppose that there exists a function $\phi \in C^{\varepsilon, \frac{\varepsilon}{2}}(\overline{Q})$, $\varepsilon \in (0, 1)$, such that $\phi \geq 0$ on $\Gamma \times (0, T)$, $\phi > 0$ on $\text{int}\Gamma'$, and $\phi = 0$ on $(\Gamma \setminus \Gamma') \times (0, T)$ with Γ and Γ' as in Assumption A.8.1, and*

$$u(x, 0) = \phi(x, 0) \quad \text{a.e. in } \Omega \quad \text{and} \quad (\gamma_0 u)^+ = \phi \quad \text{a.e. on } \Gamma \times (0, T).$$

Let θ_1 as in Lemma A.8.10 and s as in Lemma A.8.11.

Let $x_0 \in \overline{\Omega}$, ϱ_0 as in Assumption A.8.1, $t_0 > 0$, θ as in Lemma A.8.9 and for any $0 < \varrho \leq \varrho_0$ we define

$$Q_{\frac{\varrho}{2}} = B_{\frac{\varrho}{2}}(x_0) \times \left(t_0 - \theta \frac{\varrho^2}{4}, t_0 \right) \subset Q,$$

$$Q_{2\varrho} = B_{2\varrho}(x_0) \times (t_0 - 4\theta \varrho^2, t_0) \subset Q.$$

Then one of the following implications holds

$$\textcircled{1} \quad \text{osc} \left\{ u; Q_{\frac{\varrho}{2}} \cap Q \right\} \leq 2^s \varrho, \quad (\text{A.8.2.44a})$$

$$\textcircled{2} \quad \text{osc} \left\{ u; Q_{2\varrho} \cap Q \right\} \leq 4 \|\phi\|_{C^{\varepsilon, \frac{\varepsilon}{2}}(\overline{Q})} \varrho^\varepsilon (1 + \theta^\varepsilon) \quad (\text{A.8.2.44b})$$

$$\textcircled{3} \quad \text{osc} \left\{ u; Q_{\frac{\varrho}{2}} \right\} \leq \left(1 - \frac{1}{2^s} \right) \text{osc} \left\{ u; Q_{2\varrho} \right\}. \quad (\text{A.8.2.44c})$$

Proof: Let θ_1 as in Lemma A.8.10 and s as in Lemma A.8.11. Furthermore, we assume that

$$\omega_1 := \text{osc} \left\{ u; Q_{\frac{\varrho}{2}} \right\} > 2^s \varrho^{\min\{1, \varepsilon\}}$$

holds. Thus,

$$\omega = \text{osc} \left\{ u; Q_\varrho \right\} > 2^s \varrho^{\min\{1, \varepsilon\}}.$$

follows. Then, Lemma A.8.11 yields that either (A.8.2.20b) or (A.8.2.20c) or (A.8.2.20d) hold. If (A.8.2.20b) holds, we immediately obtain (A.8.2.44b).

Let us now consider the case in which (A.8.2.20c) is satisfied. (In the other case we can repeat our arguments, while working with the function $-u$.) Therefore, in particular $k_0 = \frac{\omega}{2^{s-1}}$ is an admissible level for (A.8.2.2b) in the cylinder Q_ϱ . Hence, the conditions of Lemma A.8.10 are satisfied and we obtain for the cylinder Q_ϱ and the level $k_0 = \sup_{Q_{2\varrho} \cap Q} u - \frac{\omega}{2^{s-1}}$ that either

$$H = \sup_{Q_\varrho \cap Q} u - \left(\sup_{Q_{2\varrho} \cap Q} u - \frac{\omega}{2^{s-1}} \right) < \varrho$$

or

$$\left| \left\{ (x, t) \in Q_{\frac{\varrho}{2}} \cap Q : u > k_0 + \frac{H}{2} \right\} \right| = 0$$

must hold. In the first case we find, keeping in mind that $\omega > 2^s \varrho$,

$$\sup_{Q_{\frac{\varrho}{2}} \cap Q} u \leq \sup_{Q_\varrho \cap Q} u \leq \sup_{Q_{2\varrho} \cap Q} u - \frac{\omega}{2^{s-1}} + \varrho \leq \sup_{Q_{2\varrho} \cap Q} u - \frac{\omega}{2^s}.$$

In the second case we have

$$\sup_{Q_{\frac{\varrho}{2}} \cap Q} u \leq \mu_+ - \frac{\omega}{2^{s-1}} + \frac{H}{2} \leq \sup_{Q_{2\varrho} \cap Q} u - \frac{\omega}{2^s}.$$

Consequently,

$$\text{osc} \left\{ u; Q_{\frac{\varrho}{2}} \cap Q \right\} = \sup_{Q_{\frac{\varrho}{2}} \cap Q} u - \inf_{Q_{\frac{\varrho}{2}} \cap Q} u \leq \sup_{Q_{2\varrho} \cap Q} u - \inf_{Q_{2\varrho} \cap Q} u - \frac{\omega}{2^s} = \left(1 - \frac{1}{2^s} \right) \omega$$

is satisfied and the claim follows. \square

As a consequence of Lemmata A.8.12 and A.7.5 the following result holds.

Theorem A.8.13. *Let $u \in \tilde{B}_2(\bar{Q}, M, \gamma)$ and let Ω satisfy Assumption A.8.1. Suppose that there exists a function $\phi \in C^{\varepsilon, \frac{\varepsilon}{2}}(\bar{Q})$, $\varepsilon \in (0, 1)$, such that $\phi \geq 0$ on $\Gamma \times (0, T)$, $\phi > 0$ on $\text{int}\Gamma' \times (0, T)$, and $\phi = 0$ on $(\Gamma \setminus \Gamma') \times (0, T)$ with Γ and Γ' as in Assumption A.8.1, and*

$$u(x, 0) = \phi(x, 0) \quad \text{a.e. in } \Omega \quad \text{and} \quad (\gamma_0 u)^+ = \phi \quad \text{a.e. on } \Gamma \times (0, T).$$

Let θ_1 as in Lemma A.8.10 and s as in Lemma A.8.11 and for $x_0 \in \bar{\Omega}$, ϱ_0 as in Assumption A.8.1, $t_0 > 0$, θ as in Lemma A.8.9. Then for all $0 < \varrho \leq \varrho_0$ and

$$Q(\varrho, \theta \varrho^2) := B_\varrho(x_0) \times (t_0 - \theta \varrho^2, t_0),$$

we have the following estimate

$$\text{osc} \left\{ u : Q(\varrho, \theta \varrho^2) \right\} \leq C \left(\frac{\varrho}{\varrho_0} \right)^\alpha, \quad (\text{A.8.2.45})$$

where

$$\alpha = \min \left\{ -\log_4 \left(1 - \frac{1}{2^s} \right); \varepsilon \right\}, \quad C = 4^\alpha \max \left\{ 2M; \max \left\{ 2^s; 2 \|\phi\|_{C^{\varepsilon, \frac{\varepsilon}{2}}(\bar{Q})_{(1-\theta\varepsilon)}} \right\} \varrho_0^\varepsilon \right\}.$$

Proof: This is a consequence of Lemmas A.8.12 and A.7.5. \square

A.8.3 Time Discrete De Giorgi Classes

In order to deal with solutions of semidiscrete parabolic equations with the discretization parameter h , we follow the ideas of [34] and introduce two function spaces $\check{\mathcal{B}}_2^h(\bar{Q}, M, \gamma)$ and $\check{\mathcal{B}}_2^h(\bar{\Omega}, M, \gamma)$ according to the time mesh h ; one for treating the elliptic case, the other for handling the parabolic case.

Definition A.8.14 (The class $\check{\mathcal{B}}_2^h(\bar{Q}, M, \gamma)$).

Let $\Omega \subset \mathbb{R}^3$, $T > 0$, $m \in \mathbb{N}$, and $h := T/m$. Let $M, \gamma > 0$ be given and $\varrho_0, \tau_0 > 0$. We say a function $u = u(x, t)$ belongs to function class $\check{\mathcal{B}}_2^h(\bar{Q}, M, \gamma)$, if $u = u(x, t)$ satisfies (A.8.2.1) and the functions $w = \pm u$ satisfy (A.8.2.2a) and (A.8.2.2b) with t_0 replaced by $t_n = nh$, $n \in \{1, \dots, m\}$ for all local parabolic cylinders $Q(\rho, \tau)$ with the restriction $0 < \rho \leq \varrho_0$, $\sqrt{h} < \tau \leq \tau_0$, and all $\sigma_1, \sigma_2 \in (0, 1)$.

Definition A.8.15 (The class $\check{\mathcal{B}}_2^h(\bar{\Omega}, M, \gamma)$). Let $\Omega \subset \mathbb{R}^3$, $T > 0$, $m \in \mathbb{N}$, and $h := T/m$. Let M, γ be positive constants and $\varrho_0 > 0$. We say a function $u = u(x)$ belongs to function class $\check{\mathcal{B}}_2^h(\bar{\Omega}, M, \gamma)$, if $u = u(x)$ satisfies (A.8.1.1) and the functions $w = \pm u$ satisfy (A.8.1.2) for all balls B_ρ centered at $x_0 \in \bar{\Omega}$ with radius $0 < \rho \leq \varrho_0$ with the additional restriction $\rho \leq h$ and all $\sigma \in (0, 1)$.

Let us now present a result (see [34, Section 4]) which allows us to estimate the oscillation decay of solutions to Problem 4.1.1.

Theorem A.8.16 (Uniform Hölder estimates). Let $T > 0$, $m \in \mathbb{N}$, $h := T/m$ and suppose that Ω satisfies Assumption A.8.1.

Given a sequence $\{g_m^n\}_{n \in \{1, \dots, m\}} \in H^1(\Omega) \cap \check{\mathcal{B}}_2^h(\bar{\Omega}, M, \gamma)$, assume, that its piecewise constant time interpolate

$$\bar{g}_m(x, t) := \begin{cases} g_m^n(x), & \text{for } (n-1)h < t \leq nh, \ n \geq 1, \\ g_m^0(x), & \text{for } t = 0 \end{cases} \quad (\text{A.8.3.1})$$

belongs to $\check{\mathcal{B}}_2^h(\bar{Q}, M, \gamma)$. Suppose that there exists a sequence $\{\phi_m^n\}_{n \in \{0, \dots, m\}} \subset C^{0, \varepsilon}(\bar{\Omega})$, bounded uniformly w.r.t m, n in $C^{0, \varepsilon}(\bar{\Omega})$ such that for all $x \in \Omega$

$$|\phi_m^n - \phi_m^{n'}| \leq C |(n - n')h|^{\frac{\varepsilon}{2}}$$

holds for all $n, n' \in \{0, \dots, m\}$, $|(n - n')h| \leq 1$ with a nonnegative constant C independent of h, m, n, n' and x , and for all $n \in \{0, \dots, m\}$ ϕ_m^n satisfies $\phi_m^n \geq 0$ on Γ , $\phi_m^n > 0$ on $\text{int}\Gamma'$, and $\phi_m^n = 0$ on $\Gamma \setminus \Gamma'$ with Γ and Γ' as in Assumption A.8.1, and

$$g_m^0 = \phi_m^0 \quad \text{a.e. in } \Omega, \quad \text{and} \quad (\gamma_0 g_m^n)^+ = \phi_m^n \quad \text{a.e. on } \Gamma.$$

Let the number θ be as in Lemma A.8.9, then for h satisfying

$$h \leq \min \left\{ \theta^2; \theta^{-\frac{2}{3}}; \frac{1}{36} \right\}$$

the following oscillation decay estimate

$$\text{osc} \{u_m^n; \Omega \cap B_\varrho\} \leq \tilde{C} \varrho^\alpha \quad \text{for } 1 \leq n \leq m \quad (\text{A.8.3.2})$$

is satisfied for any ball $B_\varrho \subset \mathbb{R}^3$ with radius $0 < \varrho \leq \varrho_0$, with ϱ_0 as in Assumption A.8.1 and

$$\left| u_m^n(x) - u_m^{n'}(x) \right| \leq \tilde{C} [(n - n')h]^\frac{\alpha}{4} \quad (\text{A.8.3.3})$$

holds for any positive integers n and n' , $(n - n')h < 1$, $1 \leq n' \leq n \leq m$ and any $x \in \Omega$, with the constants

$$\alpha := \min \left\{ \frac{\alpha_1}{4}, \alpha_2 \right\}, \quad \tilde{C} := \max \left\{ C, C\theta^{-\frac{\alpha_1}{2}}; C\theta^{-\frac{\alpha_1}{2}} 4^{\alpha_2} \right\}$$

where α_1, C are as in Theorem A.8.7, and α_2 is as in Theorem A.8.7.

The proof can be found in [34, Section 4].

A.9 The Heat Equation

In this section we recall some well known results about the regularity of solutions to the Heat Equation. For details we refer to [43] and to [49].

Let $x_0 \in \mathbb{R}^3$, $t_0 \in \mathbb{R}$, and $\varrho > 0$. We define

$$R_\varrho := \{x \in \mathbb{R}^3 : |x_i - x_0| < \varrho, i = 1, 2, 3\}, \quad R_{\frac{\varrho}{2}} := \left\{x \in \mathbb{R}^3 : |x_i - x_0| < \frac{\varrho}{2}, i = 1, 2, 3\right\},$$

$$Q_\varrho := R_\varrho \times (t_0 - \varrho^2, t_0) \subset Q, \quad Q_{\frac{\varrho}{2}} := R_{\frac{\varrho}{2}} \times \left(t_0 - \frac{\varrho^2}{4}, t_0\right).$$

Let $a > 0$ be a constant and for given data $p \in L^2(t_0 - \varrho^2, t_0; H^1(R_\varrho))$ consider the heat equation

$$\dot{v} - a\Delta v = 0, \quad \text{a.e. in } Q_\varrho, \quad (\text{A.9.1a})$$

$$\gamma_0 v = \gamma_0 p \quad \text{a.e. on } \partial R_\varrho \times (t_0 - \varrho^2, t_0), \quad (\text{A.9.1b})$$

$$v(\cdot, t_0 - \varrho^2) = p(\cdot, t_0 - \varrho^2) \quad \text{a.e. in } R_\varrho, \quad (\text{A.9.1c})$$

where γ_0 denotes the trace operator. Let $p \in C^{\alpha, \frac{\alpha}{2}}(\overline{Q_\varrho}) \cap L^2(t_0 - \varrho^2, t_0; H^1(R_\varrho))$ and set

$$K_p := \left\{ \phi \in L^2(t_0 - \varrho^2, t_0; H^1(R_\varrho)) : \gamma_0 \phi = \gamma_0 p \text{ a.e. on } \partial R_\varrho \times (t_0 - \varrho^2, t_0) \right\}$$

It is well known (see e.g. [43, Chapter 3, Theorem 4.1]) that there exists a unique function $v \in H^1(Q_\varrho) \cap K_p$, such that $v(x, t_0 - \varrho^2) = p(x, t_0 - \varrho^2)$ a.e. in R_ϱ and v satisfies the following variational inequality

$$\iint_{Q_\varrho} \dot{v}(v - \phi) + a(\nabla v + \hat{z})(\nabla v - \nabla \phi) dx dt \leq 0 \quad \forall \phi \in K_p. \quad (\text{A.9.2})$$

We recall the following regularity results (see [43, Chapter 3, Theorem 4.1, Theorem 7.1] and [49])

Theorem A.9.1. *Let $p \in C^{\alpha, \frac{\alpha}{2}}(\overline{Q_\varrho}) \cap L^2(t_0 - \varrho^2, t_0; H^1(R_\varrho))$ and let $v \in H^1(Q_\varrho) \cap K_p$ be the solution v of (A.9.2). Then there exist constants $M > 0$, $\beta \in (0, \alpha]$, and $C(\beta) > 0$ (independent of v and ϱ) such that*

$$\begin{aligned} \|v\|_{L^\infty(Q_\varrho)} &\leq M \max \left\{ 1; \|p\|_{L^\infty(Q_\varrho)} + |Q_\varrho| + a_0 + k_0 \right\} =: \hat{M}, \\ \text{osc} \{v; Q_\varrho\} &\leq C(\beta) \max \left\{ 1; \hat{M} + \|p\|_{C^{\alpha, \frac{\alpha}{2}}(\overline{Q_\varrho})} \right\} \varrho^\beta =: c_\beta \varrho^\beta. \end{aligned}$$

Moreover there exists a constant c_M such that the following inequality holds

$$\|\nabla v\|_{L^\infty(Q_{\frac{\varrho}{2}})}^2 \leq \frac{c_M}{|Q_\varrho|} \int_{Q_\varrho} |\nabla v| \, dx \, dt,$$

where the constant c_M depends on a , and $|Q_\varrho|$, and is in particular independent of v , and ϱ .

A.10 Gronwall's Lemma

For the following result we refer to [69, Section I.1], see also [20, Section B.2].

Lemma A.10.1. *Let $0 < T < +\infty$ and $\varphi, \alpha, \beta : [0, T] \rightarrow \mathbb{R}$ be continuous functions, with α nondecreasing, and $\beta \geq 0$. If*

$$\varphi(t) \leq \alpha(t) + \int_0^t \beta(\tau) \varphi(\tau) \, d\tau, \quad \forall t \in [0, T],$$

then

$$\varphi(t) \leq \alpha(t) \exp \left(\int_0^t \beta(\tau) \, d\tau \right), \quad \forall t \in [0, T]. \tag{A.10.1}$$

We now state the following discrete version of Gronwall's lemma, whose proof can be found in [17, p. 75].

Lemma A.10.2. *Let $T > 0$, $m \in \mathbb{N}$, $h := T/m$, $\{\varphi_n\}_{n \in \{0, \dots, m\}}$ be a nonnegative sequence and $\alpha \geq 0$ a constant. Suppose that for $l \in \{1, \dots, m\}$*

$$\varphi_l \leq \alpha \left(1 + h \sum_{n=1}^l \varphi_n \right)$$

holds. Then

$$\varphi_l \leq \alpha (1 + \exp(\alpha T))$$

holds for all $l \in \{1, \dots, m\}$.

A.11 Parabolic Subdivision, a Calderón-Zygmund - Type Lemma, and the Hardy-Littlewood Maximal Function Operator

In this section we present some tools we used in Chapter 7. First we will recall a Calderón-Zygmund covering result and the properties of the maximal operator which arises in the parabolic setting and start with the introduction of the so called PARABOLIC SUBDIVISION.

Definition A.11.1 (Parabolic subdivision). *Given a parabolic rectangle $Q_0 \subset \mathbb{R}^{n+1}$, $n \in \mathbb{N}$, we divide*

- (i) *each spatial side into 2 equal parts and*
- (ii) *the temporal side into 2^2 equal parts.*

We call this procedure a PARABOLIC SUBDIVISION. With this procedure we obtain 2^{n+2} new parabolic subrectangles. By $\mathcal{R}(Q_0)$ we shall denote the class of all parabolic cylinders, which were obtained from Q_0 by a finite number of parabolic subdivisions. We call $\mathcal{R}(Q_0)$ a RECTANGLE COLLECTION.

Given a rectangle $\tilde{Q} \in \mathcal{R}(Q_0)$, we call $\check{Q} \in \mathcal{R}(Q_0) \cup \{Q_0\}$ the PREDECESSOR of \tilde{Q} , if and only if \tilde{Q} was obtained from \check{Q} by exactly one parabolic subdivision.

The following lemma plays an essential role in the proof of the results in Chapter 7. This result is a consequence of a Calderón-Zygmund type covering argument and its proof can be found for instance in [56].

Lemma A.11.2 (cf. [56], Lemma 2.3). *Let $Q_0 \subset \mathbb{R}^{n+1}$ be a parabolic rectangle.*

Assume that $\mathcal{X} \subset \mathcal{Y} \subset Q_0$ are measurable sets satisfying the following conditions:

- (i) *There exists $\delta > 0$ such that*

$$|\mathcal{X}| < \delta |Q_0|,$$

- (ii) *If $Q \in \mathcal{R}(Q_0)$, then*

$$|\mathcal{X} \cap Q| > \delta |Q| \quad \text{implies} \quad \check{Q} \subset \mathcal{Y},$$

where $\check{Q} \in \mathcal{R}(Q_0) \cup \{Q_0\}$ denotes the predecessor of Q .

Then it follows that $|\mathcal{X}| < \delta |\mathcal{Y}|$.

Let us proceed with the introduction of the RESTRICTED HARDY-LITTLEWOOD MAXIMAL FUNCTION OPERATOR.

Definition A.11.3 (Restricted Hardy Littlewood maximal function operator).

Let $n \in \mathbb{N}$ and $Q_0 \subset \mathbb{R}^{n+1}$ be a parabolic rectangle. We define the restricted Hardy-Littlewood maximal function operator relative to Q_0 as

$$M_{Q_0}(f)(x, t) := \sup_{Q \subset Q_0, (x, t) \in Q} \frac{1}{|Q|} \int_Q |f(y, \tau)| \, dy \, d\tau,$$

whenever $f \in L^1(Q_0)$, where Q denotes any rectangle contained in Q_0 , not necessarily with the same center, as long as it contains the point (x, t) .

We recall the following two estimates for M_{Q_0} (c.f [63, Chapter I.3, Theorem 1] or [15, Chapter 2]).

Lemma A.11.4 (Weak Type (1,1)). *Let Q_0 be a parabolic rectangle, $f \in L^1(Q_0)$, and $M_{Q_0}(f)$ as in Definition A.11.3. Then there exists a constant c_W such that*

$$|\{(x, t) \in Q_0 : |M_{Q_0}(f)(x, t)| \geq \lambda\}| \leq \frac{c_W}{\lambda} \int_{Q_0} |f(x, t)| \, dx \, dt, \quad \forall \lambda > 0 \quad (\text{A.11.1})$$

holds.

Moreover, we have the following result.

Lemma A.11.5 (Strong (p,p) estimate). *Let Q_0 be a parabolic rectangle, $f \in L^p(Q_0)$, $1 < p$, and $M_{Q_0}(f)$ as in Definition A.11.3. Then there exists a constant $c(n, p)$ such that*

$$\int_{Q_0} |M_{Q_0}(f)(x, t)|^p \, dx \, dt \leq \frac{c(n, p)}{p-1} \int_{Q_0} |f(x, t)|^p \, dx \, dt \quad (\text{A.11.2})$$

holds.

- [1] H.W. Alt, S. Luckhaus, and A. Visintin. On nonstationary flow through porous media. *Ann. Math. Pura Appl.*, 136:303–316, 1984.
- [2] D.G. Aronson and J. Serrin. Local behaviour of solutions of quasi-linear parabolic equations. *Archive for Rational Mechanics and Analysis*, 25:81–122, 1967.
- [3] J.L. Auriault, C. Boutin, and C. Geindreau. *Homogenization of coupled phenomena in heterogeneous media*. Wiley, 2009.
- [4] F. Bagagiolo and A. Visintin. Hysteresis in filtration through porous media. *Z. Anal. Anw.*, 19:977–998, 2000.
- [5] F. Bagagiolo and A. Visintin. Porous media filtration with hysteresis. *Adv. Math. Sci. Appl.*, 14:379–403, 2004.
- [6] J. Bear. *Dynamics of fluids in porous media*. Elsevier, 1972.
- [7] L. Beck. *Boundary regularity results for weak solutions of subquadratic elliptic systems*. PhD thesis, Friedrich-Alexander-Universität Erlangen-Nürnberg, 2008.
- [8] G.L. Bloomsburg and A.T. Correy. Diffusion of entrapped air from porous media. Hydrology paper 5, Forth Collins: Colorado State University, 1964.
- [9] N.D. Botkin, M. Brokate, and E.G. El Behi-Gornostaeva. One-phase flow in porous media with hysteresis. *Physica B: Condensed Matter*, 486:183–186, 2016.
- [10] Haim Brezis. *Functional Analysis, Sobolev Spaces and Partial Differential Equations*. Springer, 2011.
- [11] M. Brokate and J. Sprekels. Existence and optimal control of mechanical processes with hysteresis in viscous solid. *I.M.A. J. Appl. Math.*, 43:219–229, 1989.

- [12] M. Brokate and J. Sprekels. *Hysteresis and Phase Transitions*, volume 121 of *Applied Mathematical Sciences*. Springer, 1996.
- [13] L.A. Caffarelli and I. Peral. On $W^{1,p}$ estimates for elliptic equations in divergence form. *Comm. Pure App. Math*, 51(1):1–21, 1998.
- [14] W. Chesworth, editor. *Encyclopedia of Soil Science*. Springer, 2008.
- [15] M. de Guzmán. *Differentiation of Integrals in \mathbb{R}^n* , volume 481 of *Lecture Notes in Mathematics*. Springer, 1975.
- [16] E. DiBenedetto. *Real Analysis*. Birkhäuser, 2002.
- [17] M. Eleuteri. *On some P.D.E.s with hysteresis*. PhD thesis, University of Trento, 2006.
- [18] M. Eleuteri, J. Kopfová, and P. Krejčí. Magnetohydrodynamic flow with hysteresis. *SIAM Journal on Mathematical Analysis*, 2009.
- [19] J.A. Enderby. The domain model of hysteresis 1. Independent domains. *Faraday Soc. Trans.*, 51:835–848, 1955.
- [20] L. C. Evans. *Partial Differential Equations*, volume 19 of *Graduate Studies in Mathematics*. AMS, 1998.
- [21] D.H. Everett. A general Approach to hysteresis 3. A Formal treatment of the independent domain model of hysteresis. *Faraday Soc. Trans.*, 51:1077–1096, 1954.
- [22] D.H. Everett. A general Approach to hysteresis 4. An alternative formulation of the domain model. *Faraday Soc. Trans.*, 51:1551–1557, 1955.
- [23] D.H. Everett. Adsorption hysteresis. In E.A. Flood, editor, *Solid GAs interface*, pages 1055–1113. Marcel Dekker, 1967.
- [24] D.H. Everett and F.W. Smith. A general Approach to hysteresis 2. Development of the domain theory. *Faraday Soc. Trans.*, 50:187–197, 1954.
- [25] D.H. Everett and W.I. Witton. A general Approach to hysteresis 1. *Faraday Soc. Trans.*, 48:749–752, 1952.
- [26] R. Feddes, G. de Rooji, and J. van Dam. *Unsaturated-zone Modeling: Progress, Challenges, and Applications*. Kluwer, 2004.
- [27] D. Gilbarg and N.S. Trudinger. Elliptic partial differential equations of second order. In *A Series of Comprehensive Studies in Mathematics*, volume 224. Springer, 1st. edition edition, 1977.

- [28] E. De Giorgi. Sulla differenziabilità e l'analicità delle estremali degli integrali multipli regolari. *Mem. Accad. Sci. Torino. Cl. Sci. Fis. Math. Nat.*, 3:25–43, 1957.
- [29] P. Grisvard. *Elliptic Problems in Nonsmooth Domains*. Pitman, 1985.
- [30] M. Hassanizadeh and W. Gray. General conservation equations for multi-phase systems: 3. constitutive theory for porous media flow. *Adv. Water Res.*, 3(1):25–40, 1980.
- [31] R. Helmig. *Multiphase Flow and Transport Processes in the subsurface: A Contribution to the Modeling of Hydrosystems*. Springer, 1997.
- [32] D. Hillel. *Environmental Soil Physics*. Academic Press, San Diego, California, 1998.
- [33] R. K. Kaufmann and C. Cleveland. *Environmental Science*. McGraw-Hill, 2007.
- [34] N. Kikuchi. Hölder estimates of solutions for difference-differential equations of elliptic-parabolic type. Technical report, Department of Mathematic, Faculty of Science and Technology, Keio University, 1992.
- [35] P. Kordulová. Hysteresis in flow through porous media. *J. Phys. Conf. Ser.*, 268, 2011.
- [36] M.A. Krasnosel'skii and A.V. Pokrovskii. Periodic oscillations in systems with relay nonlinearities. *Sovjet Math. Dokl.*, 15:873–877, 1974.
- [37] M.A. Krasnosel'skii and A.V. Pokrovskii. Modelling transducers with hysteresis by means of continuous systems of relays. *Sovjet Math. Dokl.*, 17:447–451, 1976.
- [38] M.A. Krasnosel'skii and A.V. Pokrovskii. *Systems with Hysteresis*. Springer, 1989.
- [39] P. Krejčí. On maxwell equations with the preisach hysteresis operator: the one-dimensional time-periodic case. *Appl. Mat.*, 34:364–374, 1989.
- [40] P. Krejčí. *Hysteresis, Convexity and Dissipation in Hyperbolic Equations*, volume 8 of *GAKUTO International Series, Mathematical Sciences and Applications*. Gakkōtoshō, Japan, 1996.
- [41] P. Krejčí. The Kurzweil integral and hysteresis. *J. Phys. Conf. Ser.*, 55:144–154, 2006.
- [42] J. Kurzweil. Generalized ordinary differential equations and continuous dependence on a parameter. *Czechoslovak Math. J.*, 7(82):418–449, 1957.
- [43] O.A. Ladyzhenskaya, V.A. Solonnikov, and N.N. Ural'tseva. *Linear and Quasilinear Equations of Parabolic Type*, volume 23 of *Translations of Mathematical Monographs*. American Mathematical Society, 1968.

- [44] O.A. Ladyzhenskaya and N.N. Ural'tseva. *Linear and Quasilinear Elliptic Equations*. Academic Press, 1968.
- [45] J.L. Lions and E. Magenes. *Non-homogeneous boundary value problems and applications*, volume 1. Springer, 1972.
- [46] I.D. Mayergoyz. *Mathematical Models of hysteresis*. Springer, 1991.
- [47] N.R. Morrow and C.C. Harris. Capillary equilibrium in porous materials. *Soc. Pet. Eng. J.*, March, 1965.
- [48] J. Moser. On Harnack's theorem for elliptic differential equations. *Comm. Pure App. Math*, 14:577–591, 1961.
- [49] J. Moser. A Harnack inequality for parabolic differential equations. *Comm. Pure App. Math*, 17:101–134, 1964.
- [50] Y. Mualem. Modified approach to capillary hysteresis based on a similarity hypothesis. *Water resources Res.*, 9(5):1324–1331, 1973.
- [51] Y. Mualem. Conceptual model of hysteresis. *Water resources Res.*, 10(3):514–520, 1974.
- [52] J. Nash. Continuity of solutions of parabolic differential equations. *Am. J. Math*, 80:931–954, 1958.
- [53] L. Néel. Théories des lois d'aimantation de Lord Rayleigh, 1. *Chachiers Phys.*, 12:1–120, 1942.
- [54] L. Néel. Théories des lois d'aimantation de Lord Rayleigh, 2. *Chachiers Phys.*, 13:19–30, 1943.
- [55] F. Otto. L^1 -contraction and uniqueness for unstationary saturated-unsaturated porous media flow. *Adv. Math. Sci. Appl.*, 7:537–553, 1997.
- [56] I. Peral and F. Soria. A note on $W^{1,p}$ estimates for quasilinear parabolic equations. *Electronic Journal of Differential Equations, Conference 08*, pages 121–131, 2002.
- [57] J.R. Philip. Similarity hypothesis for capillary hysteresis in porous materials. *J. Geophys. Res.*, 69(8):1553–1562, 1964.
- [58] G. Pinder and W. Gray. *Essentials of multiphase flow and transport in porous media*. Wiley, 2008.
- [59] F. Preisach. Über die magnetische Nachwirkung. *Z. Physik*, 94:277–302, 1935.
- [60] M. Růžička. *Nichtlineare Funktionalanalysis*. Springer, 2004.
- [61] W. Rudin. *Real And Complex Analysis*. McGraw-Hill, 1987.

- [62] Monika Siegfanz. *Die Eindimensionale Wellengleichung mit Hysterese*. PhD thesis, Mathematisch - Naturwissenschaftliche Fakultät II der Humboldt - Universität zu Berlin, 2000.
- [63] E. Stein. *Harmonic analysis: Real-variable methods, orthogonality, and oscillatory integrals*, volume 43 of *Princeton Mathematical Series*. Princeton University Press, 1993.
- [64] A. Szymkiewicz. Modeling water flow in unsaturated porous media. In *GeoPlanet: Earth and Planetary Sciences*. Springer, 2013.
- [65] G.C. Topp. Soil water hysteresis: the domain model theory extended to pore interaction conditions. *Soil. Sci. Soc. Amer. Proc.*, 35:219–225, 1971.
- [66] M.Th. van Genuchten. A closed-form equation for predicting the hydraulic conductivity of unsaturated soils. *Soil. Sci. Soc. Amer. J.*, 44:892–898, 1980.
- [67] A. Visintin. *Differential Models of Hysteresis*. Springer, 1994.
- [68] A. Visintin. Notes on Sobolev Spaces. <http://www.science.unitn.it/visintin/Sobolev2013.pdf>, 2013-2014.
- [69] W. Walter. *Differential and integral inequalities*. Springer, 1970.
- [70] P. Weiss and J. de Freudenreich. *Arch. Sci. Phys. Nat. (Genève)*, 42:449, 1916.
- [71] S. Whitaker. Flow in porous media: A theoretical derivation of darcy's law. *Transport in Porous Media*, 1(1):3–25, 1986.