

**INTERNATIONAL COUNCIL FOR RESEARCH AND INNOVATION
IN BUILDING AND CONSTRUCTION**

WORKING COMMISSION W18 - TIMBER STRUCTURES

**BUILDING CLIMATE – LONG-TERM MEASUREMENTS TO
DETERMINE THE EFFECT ON THE MOISTURE GRADIENT IN
LARGE-SPAN TIMBER STRUCTURES**

P Dietsch

A Gamper

M Merk

S Winter

Lehrstuhl für Holzbau und Baukonstruktion
Technische Universität München

GERMANY

MEETING FORTY FIVE

VÄXJÖ

SWEDEN

AUGUST 2012

Presented by P Dietsch

J Köhler commented that the work was useful and had agreement with his own results. G Schickhofer commented that the work was important and asked about using different k_{mod} factors for different cases. He also asked for comments on the use of reinforcement. P Dietsch responded that this was a balance between scientific knowledge. This was important for large span glulam structures with beams of large widths. The type of reinforcement must consider its suitability in high moisture conditions. S Aicher questioned the conclusion that the timber should be produced to the moisture condition of use. This point is already in the code but never followed in practice. F Lam asked why correction to low moisture contents were not done as the study had such information. P Dietsch replied that the data was not suitable for this consideration because different types of wood were involved. S Winter stated that in combination with precipitation the erection time of the building was also important.

Building Climate – long-term measurements to determine the effect on the moisture gradient in large-span timber structures

P. Dietsch, A. Gamper, M. Merk, S. Winter
Lehrstuhl für Holzbau und Baukonstruktion
Technische Universität München, Germany

1 Introduction and Objective

The reaction of wood to moisture forms an integral part of any task in connection with this natural and renewable building material. This also applies to the planning, execution and maintenance of buildings built with wood or wood-based products. From logging the tree to the anticipated use, e.g. as a structural element, wood will go through various phases of processing and shape in which it is subjected to varying environmental conditions. Their influence on the wood moisture content can be illustrated by the “moisture chain”, sketched in Figure 1.

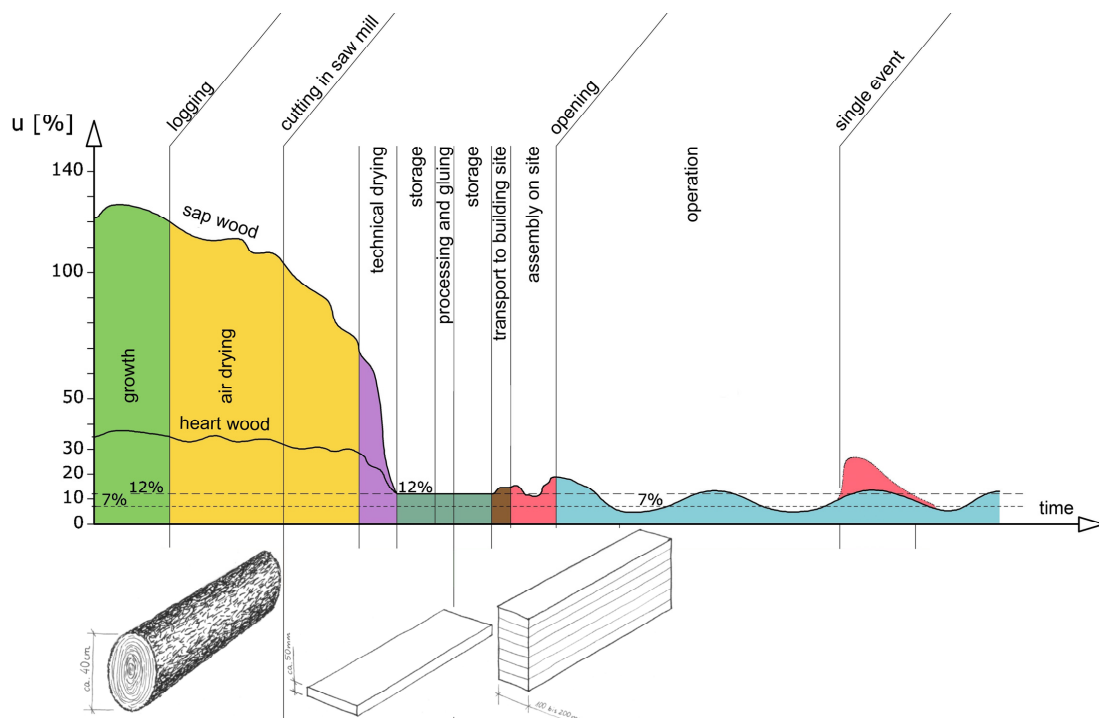

Figure 1: Sketch of a possible „moisture chain“, i.e. exposure to moisture from the tree to glued-laminated timber elements in the building

Changes in wood moisture content lead to changes of virtually all physical and mechanical properties (e.g. strength and stiffness properties) of wood. In EN 1995-1-1 [1], this is accounted for by classifying the timber elements into one of three possible service classes according to the climatic conditions during the design service life. An additional effect of changes of the wood moisture content is the associated shrinkage or swelling of the material. Since the outermost sections of the wood cross-sections will adapt to the climatic conditions at first, the resulting moisture gradient and the associated shrinkage or swelling will lead to internal stresses in the cross-section. If these stresses locally exceed the very low tension perpendicular to grain strength of wood, the result will be a stress relief in form of cracks which can reduce the load-carrying capacity of structural timber elements in e.g. shear or tension perpendicular to the grain. The evaluation of damages in large-span timber structures ([2] - [4]) shows that a prevalent type of damage is pronounced cracking in the glue lines and lamellas of glulam timber elements. Figures 2 and 3 show the types of damage and causes of damage deduced from the dataset of 245 assessments of large-span timber structures, which were evaluated at the Chair for Timber Structures and Building Construction. Almost half of the damages can be attributed to low or high moisture content or severe changes of the same. The total number of damages and causes of damage exceed the total number of structures since a structure can contain more than one type of damage.

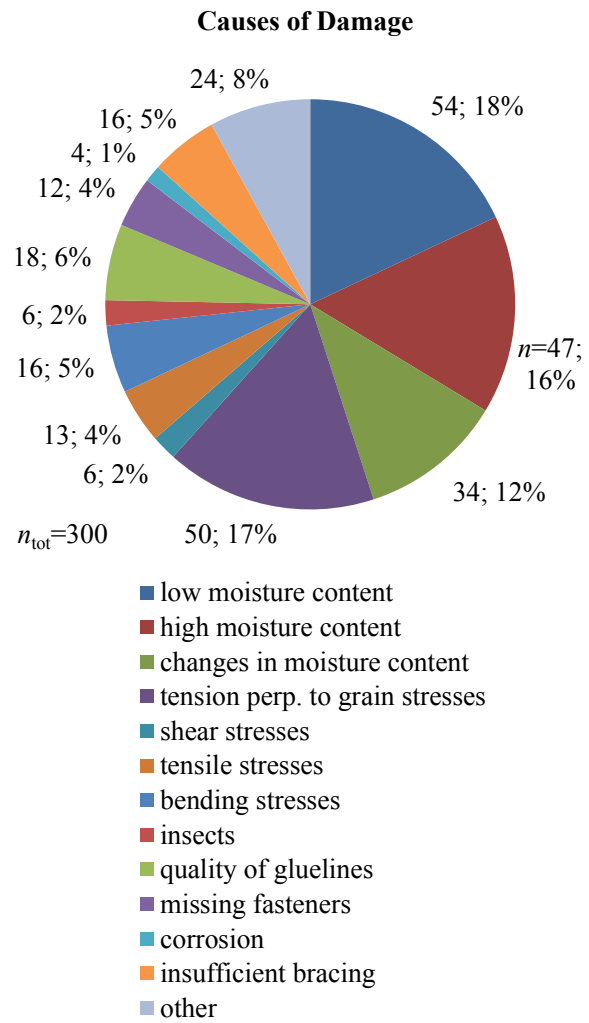
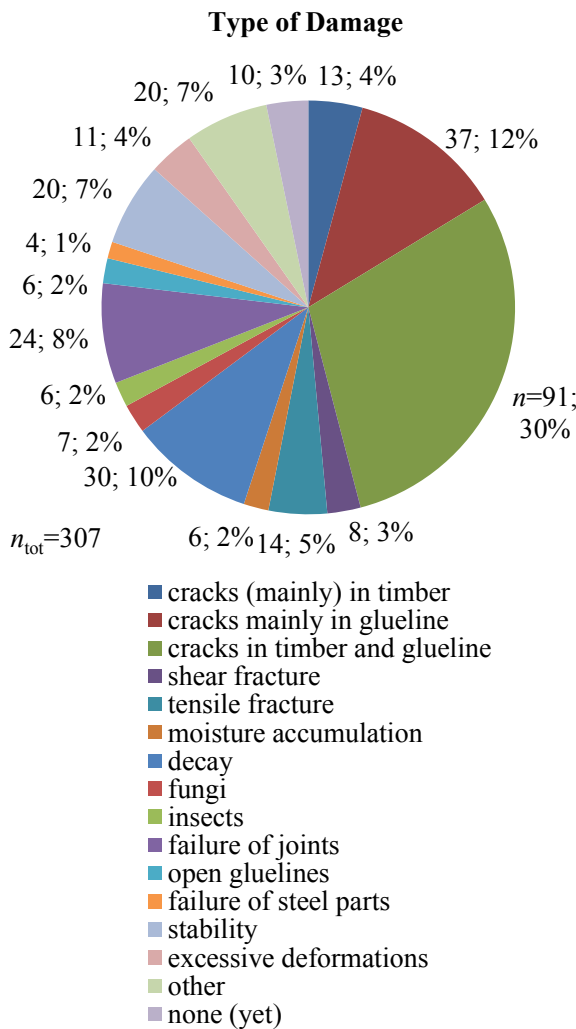

Figure 2: Type of damage from an evaluation of 245 assessments of large-span timber structures [5]

Figure 3: Causes of damage from an evaluation of 245 assessments of large-span timber structures [5]

Low or high moisture contents or severe changes of the same could sometimes be attributed to local conditions (e.g. roof leakage) but in the majority of cases, they could be explained by the climatic conditions, depending on the construction type and use of the building, and seasonal variations of the building climate. Figure 4 contains timber moisture content and climatic conditions for all structures for which such information was obtained during the assessment of the building. If multiple measurements of moisture content were taken, the given value represents the mean of these measurements. If measurements were taken at different depths, the mean of the near-surface measurements (mostly at 15 mm depth) is given. All evaluated measurements represent snap-shots of the situation at the date of assessment. They do neither give indications on the timber moisture content at the opening of the building (beginning of operation) nor on seasonal variations of the same. The measured timber moisture contents for buildings in Service Class 1 [1] show pronounced variations around a mean value of $u = 10.7\%$. The corresponding measurements of temperature and relative humidity feature a pronounced variation as well. Structural elements in Service Class 2 show smaller variations ($u_{\text{mean}} = 14.9\%$). Structural elements in Service Class 3 unsurprisingly feature large variations of timber moisture content ($u_{\text{mean}} = 22.4\%$) and building climate. The mean values of timber moisture content in dependence of the Service Class correspond well with the values compiled in [2].

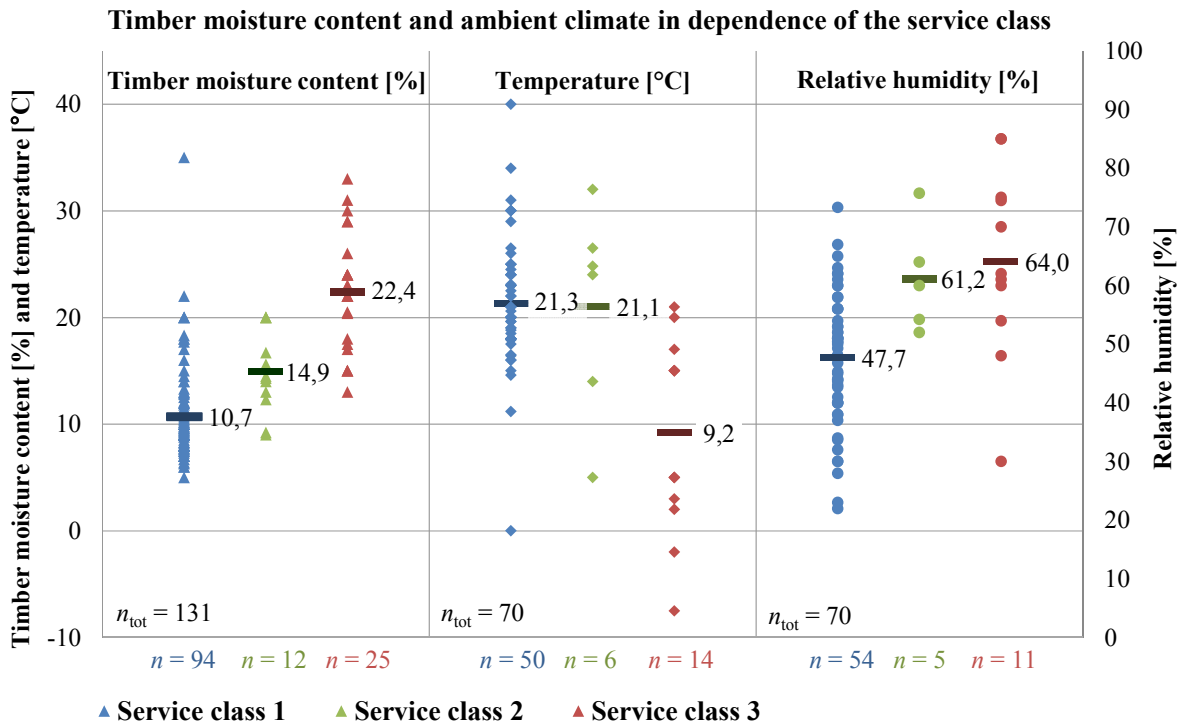

Figure 4: Timber moisture content and ambient climate in dependence of the service class, from the evaluation of 245 assessments of large-span timber structures [5]

The large variations in timber moisture content, temperature and relative humidity for buildings in Service Class 1 can partly be traced back to the diversity of types of use of these buildings. A differentiation of timber moisture content in dependence of the building use is given in Figure 5. This comparison only contains types of use for which a minimum of three buildings could be evaluated. The timber moisture contents in closed and heated buildings are oftentimes noticeably low. If structural elements, featuring high timber moisture contents due to deficient roof structures were excluded, the mean values of timber moisture content in closed and heated buildings would all fall below $u = 10\%$. 47% of the evaluated structures featured timber elements with moisture contents below 10%. The

mean values determined for riding rinks ($u_{\text{mean}} = 18.2\%$) and ice-skating rinks ($u_{\text{mean}} = 21.6\%$) support their categorization in Service Class 2 respectively Service Class 3 [6].

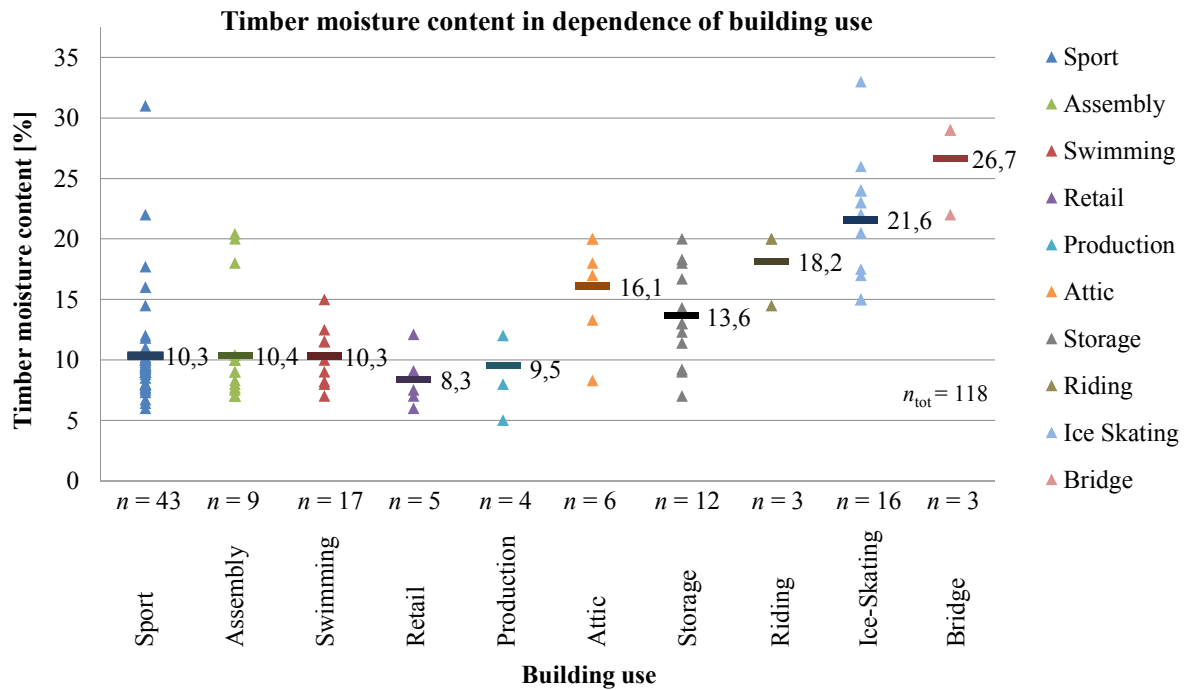

Figure 5: Timber moisture content in dependence of the type of building use, from an evaluation of 245 assessments of large-span timber structures [5]

Information on the sequence and magnitude of seasonal variations can only be obtained through long-term measurements of climate data (temperature, relative humidity) and timber moisture content. In the case of (large-span) timber structures, the measurement of moisture in different depths of the cross-section is of particular interest to draw conclusions on the magnitude and velocity of adjustment of the moisture distribution to changing climatic conditions. Although past research projects covered the long-term measurement of timber moisture content and/or temperature and relative humidity [7] – [14], none of them was carried out under the objective to enable a comparison between timber structures in large buildings of different types of use. The same is valid for the long-term measurement of moisture content at different depths on structural timber elements in-situ (phase “operation” in Figure 1). Both objectives should be covered within the research project presented.

2 Realisation of the research project

2.1 Chosen types of use and choice of objects

Within the research project, long-term measurements of timber moisture content, temperature and relative humidity in a total of 21 objects (halls with large-span timber roof structures) with seven different types of use (see Table 1) were realized. While all objects in uses “indoor swimming pool”, “gymnasium” and “production and sales” were heated and featured closed building envelopes, all objects in uses “riding rink”, “agriculture” and “warehouse” were unheated and featured partly open building envelopes. In the case of ice-skating rinks, only closed objects (climatized and non-climatized) were chosen since results for open or partly open ice-rinks are already available [11], [13]. When selecting the

objects, attention was given to cover the typical types structural systems for large-span timber roof structures. Only structures featuring softwood glulam with at least 140 mm width were included. In each object, the data was collected at two different points of measurement in order to capture possibly varying climatic conditions, e.g. due to solar radiation or the influence of heating systems. All necessary information for each object (e.g. building envelope, environmental conditions, climatization, structural system, element dimensions, surface treatment and position of the points of measurement) was prepared in separate building information sheets, including ground view, sectional view and photo documentation.

Table 1: Chosen types of use and number of objects in each use

Use	Number	Use	Number
Indoor swimming pool	3	Production and Sales	2
Ice rink	4	Agriculture (livestock)	3
Riding rink	3	Warehouse	3
Gymnasium	3	Total	21

2.2 Chosen method of measurement and verification of measured data

The electrical resistance measurement method was chosen for the measurements of the timber moisture content since this method constitutes a reliable and widely applied method, allowing for the non-destructive measurement of moisture gradients across the cross-section at one specific location (see e.g. [15]).

On this basis, a measuring system was developed in cooperation with the project partner. The system had to be able to cover moisture contents in the low range which implies the measurement of high electrical resistances (e.g. 6 % MC in spruce $\approx 10^{12} \Omega$). Subsequently, the chosen system, was installed on test specimens of glued-laminated timber from spruce and exposed to very dry, very humid and varying climate in the climate chambers of the materials testing laboratory at the Technische Universität München. The moisture contents were continuously measured with the measurement equipment and compared to the results of cyclic measurements with a calibrated reference moisture meter (GANN Hydromette RTU 600). There was neither a significant difference in the results of the two measurement systems, nor when using different types of electrodes. For further verification, two independent series of 4 x 6 test specimens from spruce ($L \times B \times H = 85 \times 60 \times 30$ mm) were produced and stored under four different controlled climatic conditions (20° C / 33 % RH; 20° C / 65 % RH; 20° C / 85% RH and 20° C / 100 % RH) which were realized by saturated saline solutions. For the very dry climate, only a relative humidity of about 45 % could be reached. This is explained by the industrial quality of the saline solution in combination with the fact that complete air-tightness of the container could not be achieved.

After the specimen had reached constant weight, their moisture content was measured with the chosen moisture meter (Scantronik Gigamodule) and two reference meters (GANN Hydromette RTU 600 and Greisinger GMH 3850). By subsequent kiln-drying, the actual moisture content was determined. Within the range of timber moisture content measured during this research project ($u_{\max} = 19$ %), good agreement was obtained for moisture contents between 12 % and 18 %, see Figure 6. Maximum absolute deviations in moisture content of 1.3 % were measured for the dry specimen, whereby the chosen moisture meter as well as the reference moisture meter tend to underestimate the actual moisture content at low ranges.

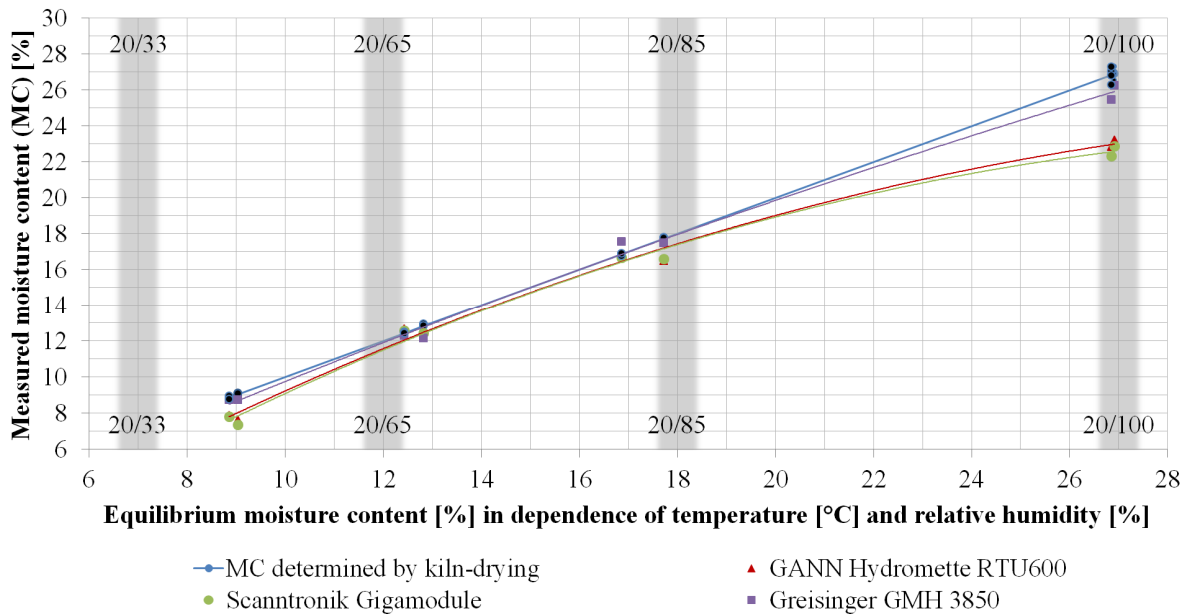

Figure 6: Results of the laboratory tests to verify the results obtained by chosen method for long-term measurements (resistance method – Scantronik Gigamodule)

2.2 Installation of measuring equipment, readout and processing of data

At each point of measurement, four pairs of teflon-isolated electrodes (GANN) with varying length were installed to enable the measurement of moisture content in clearly defined depths of the cross-section. To prevent erroneous measurements in case of surface condensate, the heads of the electrodes were also partly teflon-isolated, see Figure 7. For exact positioning of the electrodes in one lamella, ideally perpendicular to the grain, a drill guide featuring two diameters for each depth was used in connection with a drilling template. The ram-in electrodes were connected to the moisture meter by custom-built, shielded coaxial cables. The moisture meter developed in cooperation with the project partner enables the determination of moisture content at up to eight channels. The measurements which were generated every hour at both points of measurement were subsequently transmitted to a data logger. The climate data was recorded via a second data logger in combination with a sensor unit for relative humidity and air temperature. In addition, the surface temperatures at the two points of measurement were recorded to allow for the temperature compensation of the moisture content, see Figure 7.

After installation of the measuring equipment at two locations of the roof structure in each of the 21 objects, the data stored in the data loggers was read out three times over the measurement period. A manual readout was preferred to remote transmission since it could be combined with a reference measurement with another moisture meter, a function control as well as a control of the point of measurement itself. During these controls and the subsequent data analysis, a few notable issues were observed. In the indoor swimming pools, the chlorous climate resulted in accelerated corrosion and temporary malfunction of the climate sensors, necessitating their exchange. In ice-skating rink “B2”, a power line, although attached to the opposite side of the beam, led to an occasional shifting of the measurements for the duration of a few hours. Condensation around the point of measurement in objects “C3” and “G1” caused a short-circuit between the non-isolated plug-connections of the electrodes, resulting in a temporary deviation of the measurements for the duration of a few days. In all cases, the respective data was ignored and linear

interpolation was applied between the last and first set of correct measurements.

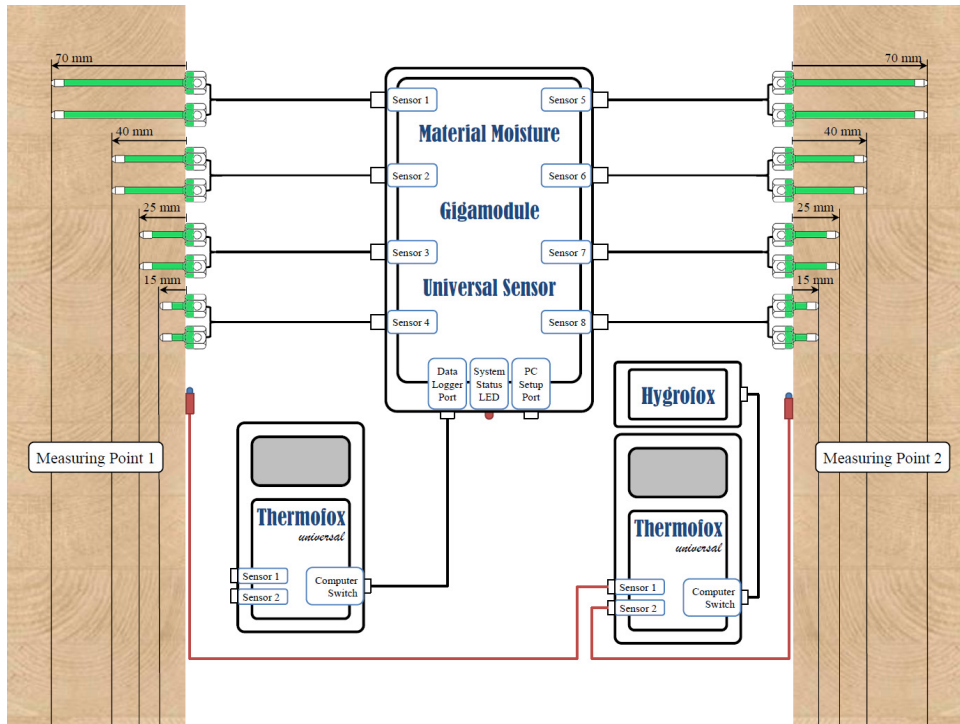

Figure 7: Systematic presentation of the measuring equipment

To analyze the data, a program on the basis of Excel was developed which made it possible to read the large amounts of data at the end of the planned duration of measurement and to further process and graphically illustrate the data in different charts. When converting the raw data, i.e. measurements of electrical resistance into timber moisture contents, a compensation of the effect of temperature was undertaken. For this, the actual material temperatures in the different depths were calculated from the measured surface temperatures, using the explicit Euler method [16] in combination with values for thermal conductivity given in e.g. [17] (see also [18], [19]). A modification of the measured timber moisture content with respect to the differences to the values determined by kiln-drying, observed during the laboratory tests, was not undertaken.

For comparative reasons, the measurements of relative humidity and temperature were used to determine the equilibrium moisture content prevailing in the cross-section near the surface as a moving average over ten days. This was done by applying the theoretical model of Hailwood & Horrobin [20] in combination with the coefficients determined by [21] (see also [18]). The influence of surface treatments which were present on the timber roof structure of ice-skating rinks “B1” and “B4” was not considered since the type of treatment could not be determined unambiguously.

3 Results

3.1 Processing and representation of results

Within the evaluation period from 1 October 2010 to 30 September 2011, a total of over 2.2 million readings were collected and analyzed by means of a specially developed program. The data read from the data loggers was prepared as curves (time series) of relative and absolute humidity and temperature at the location of measurement over time,

see Figure 8. The same type of representation was chosen for the measurements of timber moisture content in the four depths of the cross-section, see Figure 9. This figure also contains the calculated equilibrium moisture content.

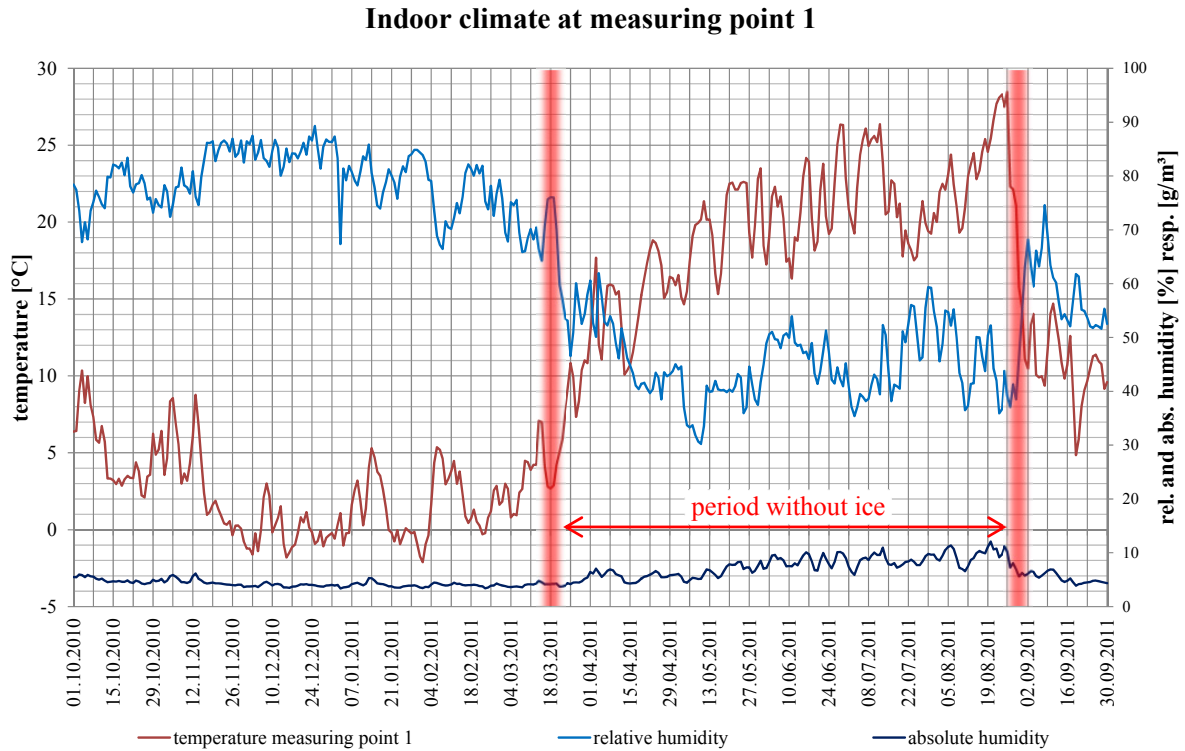

Figure 8: Variation of the relative and absolute humidity and the reference temperature over the measurement period, exemplary given for the ice rink in Buchloe

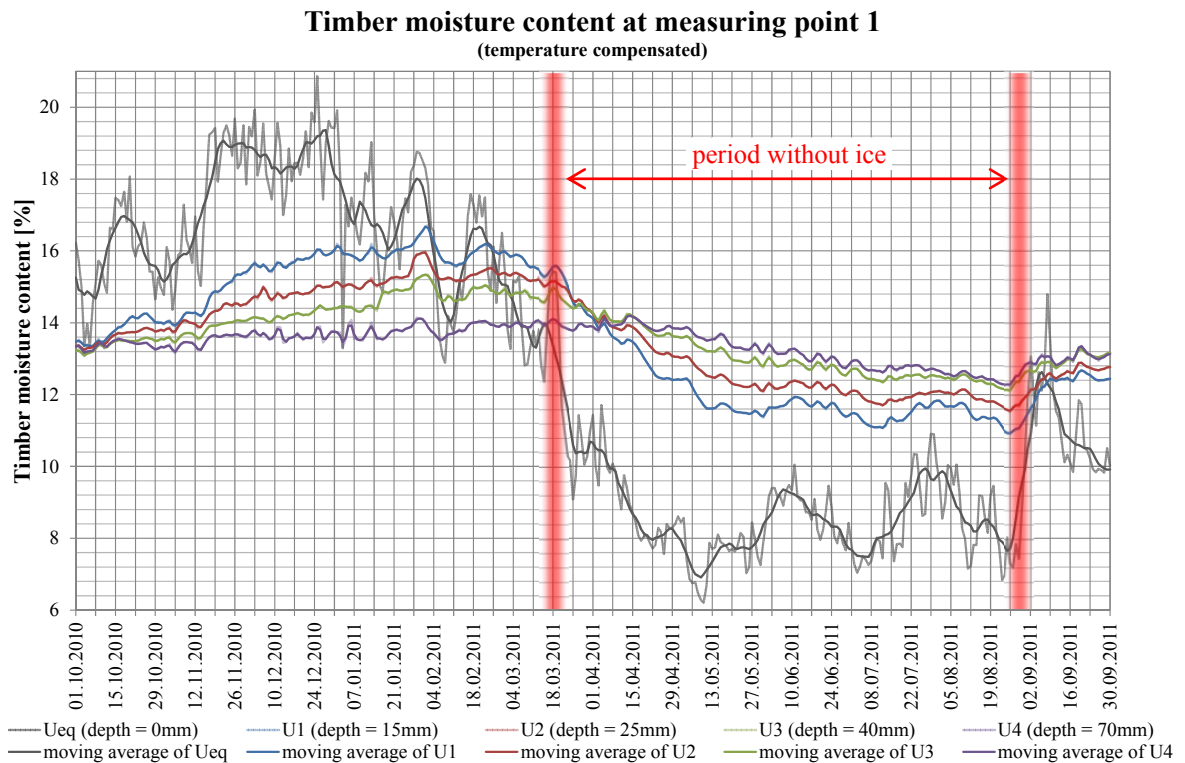

Figure 9: Variation of timber moisture content at different depths of the cross-section over the measurement period, exemplary given for the ice rink in Buchloe

In addition, graphical representations over the cross section were derived for the timber moisture content. This type of representation allows to create envelope curves of minimum and maximum timber moisture contents, see Figure 10, as well as envelope curves of minimum and maximum timber moisture gradient $\text{grad}(u) = du / dx$, see Figure 11. The graphical representations confirm the damped and delayed adaptation of timber moisture content with increasing depth.

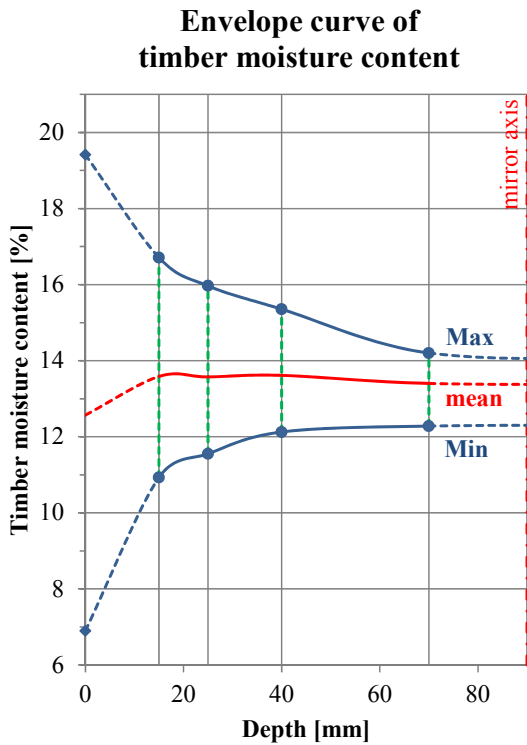

Figure 10: Envelope curve of the timber moisture content at different depths of the cross section, exemplary given for the ice rink in Buchloe

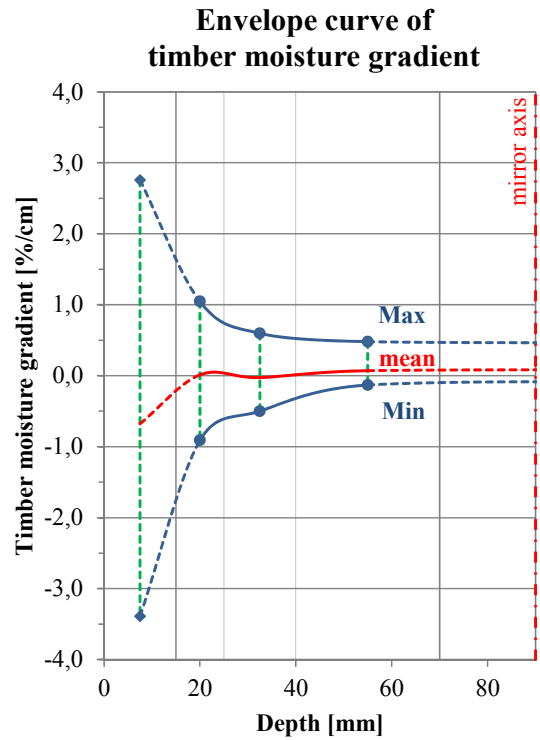

Figure 11: Envelope curve of the timber moisture gradient at different depths of the cross section, exemplary given for the ice rink in Buchloe

3.2. Results and remarks with regard to the different types of use

In the following, a summary of the results of all objects will be given in tabular format, see Table 2. This type of representation was chosen since a graphical representation is directly comprehensible but does not allow for a quick and concise overview of the results of all objects. For the graphical representations, the interested reader is kindly referred to the final report [22] of the research project. The table contains the mean values of relative humidity and temperature (both based on daily mean values) as well as the mean value of timber moisture content, averaged across all depths. In addition, the maximum amplitude, i.e. the difference between maximum and minimum value measured during the evaluation period, is given for all parameters. For the timber moisture content, the maximum gradient between two depths as well as the maximum difference in timber moisture content between the outermost (15 mm) and the innermost point of measurement (70 mm) is given. Figure 12 contains a graphical explanation of all data given in Table 2.

A comparison of the results of the individual types of building use confirms the expected large range of possible climatic conditions in buildings with timber structures. Evaluated for all types of use, the average timber moisture contents were between 4.4 % and 17.1 %.

As expected, the moisture gradients are lower in insulated and heated buildings than in non-insulated, partly open buildings with stronger influence of the naturally varying outdoor climate. If not explicitly stated, the numerical values of timber moisture content, temperature and relative humidity given in the following, represent mean values.

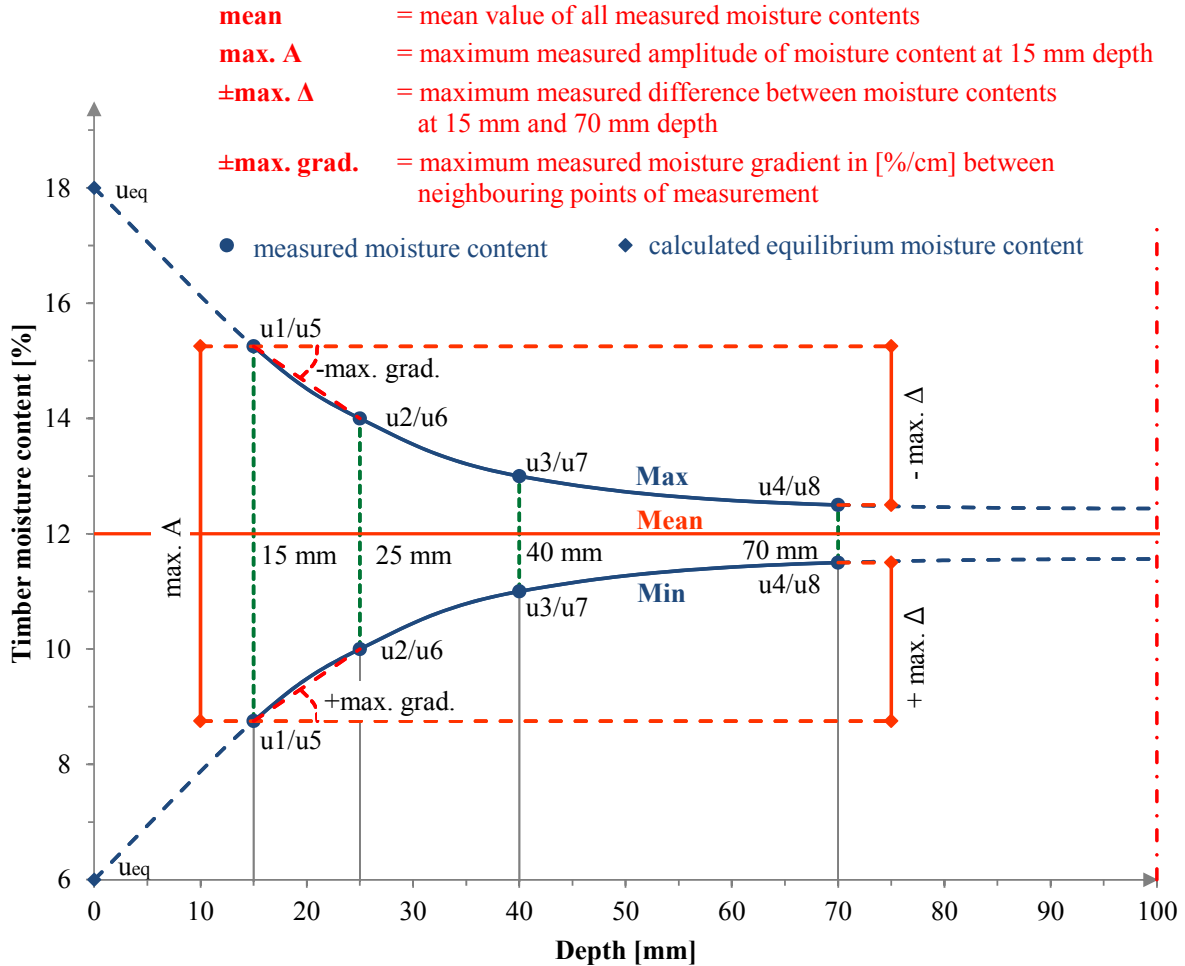

Figure 12: Sketch of envelope curve of moisture contents in the timber cross-section including notation of analyzed parameters

Very constant climatic conditions ($T \approx 30^{\circ}\text{C}$, 50 % RH) were found for indoor swimming pools (objects “A1” and “A3”) during standard operation. The timber moisture content featured small variations and small gradients. Transition zones to the outside air (object “A2”) represent an exception due to the lowering of the temperature which results in higher and more fluctuating relative humidity and timber moisture content.

In gymnasiums (objects “D”), constant climate was observed as well. The relative humidity was between 40 % and 50 % and since all objects were heated, the temperatures mostly remained constant at about 20°C . This resulted in constant timber moisture contents between 8 % and 10 % and very small moisture gradients. Object “D1” represents an exception since the roof structure is situated in a shed roof with skylights. This resulted in high temperatures and low relative humidities (RH = 28 %). The respective structural elements were very dry (MC of 4 % - 6 %). It should be noted that the measuring equipment tends to slightly underestimate the moisture contents at the low range, see section 2.2.

The climate in both objects “E - production and sales facilities” is only partially comparable due to their different type of use. Both halls are non-insulated and partly open

but due to the heating system, the influence of the outside climate on temperature and relative humidity are damped. Therefore the timber moisture gradient was relatively constant. In object “E2”, the metal processing and ironwork resulted in high temperatures below the roof (temporarily above 30°), combined with very low relative humidities (temporarily below 20 %). The resulting timber moisture content was about 5 %.

Table 2: Numerical summary of results of measurements

Object	Moisture content at measuring point 1						Moisture content at measuring point 2						Temperature		rel. Humidity	
	mean	max. A	±max. Δ	±max. grad.	mean	max. A	±max. Δ	±max. grad.	mean	max. A	±max. Δ	±max. grad.	mean	max. A	mean	max. A
	[% MC]			[%/cm]			[% MC]			[%/cm]			[°C]		[% rh]	
A1	8,75	1,44	+0,05	-1,01	+0,18	-0,11	9,26	1,23	+0,22	-0,36	-0,03	-0,49	29,68	6,67	48,26*	6,75*
A2	16,09	1,68	+0,52	-1,39	+0,36	-0,55	14,96	2,62	+0,66	-1,60	+0,27	-1,31	28,72	6,04	88,60*	19,40*
A3	8,67	1,83	-2,32	-4,73	-0,66	-1,41	7,70	1,89	-0,21	-1,70	-0,30	-1,04	30,48	19,50	45,55*	28,95*

* In these objects, a temporary malfunction of the climate sensors was encountered. The values given represent the periods of regular measurement.

Object	Moisture content at measuring point 1						Moisture content at measuring point 2						Temperature		rel. Humidity	
	mean	max. A	±max. Δ	±max. grad.	mean	max. A	±max. Δ	±max. grad.	mean	max. A	±max. Δ	±max. grad.	mean	max. A	mean	max. A
	[% MC]			[%/cm]			[% MC]			[%/cm]			[°C]		[% rh]	
B1	15,08	6,44	+1,69	-1,74	0,54	-0,89	13,91	4,23	+3,25	-0,45	0,27	-0,68	9,42	26,15	68,98	43,96
B2	13,54	5,80	+2,84	-1,95	1,0	-0,9	15,25	6,56	+3,87	-1,86	0,8	-1,2	9,86	29,90	62,20	59,06
B3	10,82	5,06	+1,64	-3,77	1,05	-1,54	9,58	4,00	+1,67	-2,14	0,40	-1,28	19,91	14,13	40,21	57,00
B4	13,32	1,93	+0,60	-0,93	-0,16	-0,73	14,91	2,83	+2,08	+0,35	+0,69	+0,05	9,16	18,82	68,31	44,67

Object	Moisture content at measuring point 1						Moisture content at measuring point 2						Temperature		rel. Humidity	
	mean	max. A	±max. Δ	±max. grad.	mean	max. A	±max. Δ	±max. grad.	mean	max. A	±max. Δ	±max. grad.	mean	max. A	mean	max. A
	[% MC]			[%/cm]			[% MC]			[%/cm]			[°C]		[% rh]	
C1	17,12	3,31	+1,03	-1,29	0,54	-0,65	16,39	3,43	+2,84	-0,03	1,25	0,23	13,28	22,51	79,71	52,63
C2	15,50	5,14	+3,01	-0,10	+2,77	+0,14	15,84	3,91	+1,51	-1,15	+0,70	-0,78	10,53	28,63	77,79	48,57
C3	14,43	5,84	+1,47	-2,69	+1,13	-0,71	15,48	4,52	+1,59	-1,77	+0,49	-0,78	9,76	30,48	77,85	52,29

Object	Moisture content at measuring point 1						Moisture content at measuring point 2						Temperature		rel. Humidity	
	mean	max. A	±max. Δ	±max. grad.	mean	max. A	±max. Δ	±max. grad.	mean	max. A	±max. Δ	±max. grad.	mean	max. A	mean	max. A
	[% MC]			[%/cm]			[% MC]			[%/cm]			[°C]		[% rh]	
D1	4,37	2,15	+0,28	-0,59	+0,16	-0,26	5,95	1,22	-0,02	-1,05	-0,16	-0,73	27,38	26,68	27,66	29,65
D2	7,98	2,02	+0,94	-0,71	+0,26	-0,18	8,10	2,06	+0,64	-1,13	+0,18	-0,65	20,58	16,72	42,77	42,01
D3	10,20	3,02	+0,52	-1,33	0,10	-0,76	10,01	2,66	+0,16	-1,67	0,12	-0,67	20,84	7,90	51,21	33,95

Object	Moisture content at measuring point 1						Moisture content at measuring point 2						Temperature		rel. Humidity	
	mean	max. A	±max. Δ	±max. grad.	mean	max. A	±max. Δ	±max. grad.	mean	max. A	±max. Δ	±max. grad.	mean	max. A	mean	max. A
	[% MC]			[%/cm]			[% MC]			[%/cm]			[°C]		[% rh]	
E1	7,70	1,85	+1,17	-0,65	0,11	-0,51	7,77	1,55	+1,28	-0,28	0,13	-0,51	18,35	17,50	40,86	38,59
E2	4,80	1,86	+0,74	-0,54	+0,31	-0,66	4,69	2,19	+1,10	-0,93	+0,85	-0,54	27,09	21,32	25,78	49,93

Object	Moisture content at measuring point 1						Moisture content at measuring point 2						Temperature		rel. Humidity	
	mean	max. A	±max. Δ	±max. grad.	mean	max. A	±max. Δ	±max. grad.	mean	max. A	±max. Δ	±max. grad.	mean	max. A	mean	max. A
	[% MC]			[%/cm]			[% MC]			[%/cm]			[°C]		[% rh]	
F1	16,52	3,69	+2,51	-0,48	+1,16	+0,33	15,77	3,07	+2,59	-1,82	+1,86	+0,54	11,59	21,58	74,67	45,60
F2	14,88	5,72	+2,86	+0,06	2,05	0,70	15,12	3,70	+2,05	-0,19	1,41	0,10	14,24	22,39	68,35	48,05
F3	14,48	4,83	+5,38	+1,35	+2,77	+0,91	15,25	4,52	+5,09	+1,18	+2,58	+0,73	12,60	28,17	69,22	54,08

Object	Moisture content at measuring point 1						Moisture content at measuring point 2						Temperature		rel. Humidity	
	mean	max. A	±max. Δ	±max. grad.	mean	max. A	±max. Δ	±max. grad.	mean	max. A	±max. Δ	±max. grad.	mean	max. A	mean	max. A
	[% MC]			[%/cm]			[% MC]			[%/cm]			[°C]		[% rh]	
G1	10,53	8,68	+3,59	-3,01	+3,22	-1,19	13,94	6,30	+2,78	-1,40	+2,15	-0,72	10,12	32,64	74,32	62,49
G2	13,27	6,12	+4,63	-1,25	+1,38	-1,16	12,69	3,61	+2,49	-0,67	+1,00	-0,48	9,67	32,46	67,13	54,01
G3	11,55	3,57	+1,44	-1,72	+0,29	-1,12	12,07	2,87	+1,75	-0,71	+0,67	-0,65	13,36	25,60	61,35	44,04

The ambient climate in closed, non-air conditioned ice rinks (objects “B1” and “B2”) was marked by a distinct change between winter (T = 4° C; 75 % RH) and summer months (i.e.

ice-free period with $T = 15^{\circ}\text{C}$; 60 % RH). The timber moisture content in ice-skating rinks was high and varied noticeably. In air-conditioned buildings (objects “B3” and “B4”), this effect was significantly damped. In objects “B1” and “B4”, the film-forming surface treatment showed a damping effect on the moisture gradient. During operation (ice season), the timber moisture content in structural timber elements above the ice was on average 1.5 % higher than in elements above other areas. It should be noted that the measurements were taken at the side faces of the beams and not at the bottom side facing the ice. Surfaces facing the ice cool down due to radiation exchange. This can lead to condensation, partly resulting in the formation of an ice-layer, and in the case of timber elements to increased moisture content, see e.g. [11].

The climate in riding rinks (objects “C”) was marked by seasonal variations leading to high amplitudes of temperature and relative humidity, the latter at high level (RH = 78 %). During the winter months, the combination of cold air in the non-insulated and unheated buildings and the humidity introduced by the sprinklers (to capture the dust), frequently resulted in condensation. As in other types of buildings which are influenced by the outside climate, the timber moisture contents were higher (MC \approx 16 %) and featured stronger seasonal variability. Due to the seasonal nature of the variations, these result in noticeable but not in exceptionally high timber moisture gradients.

Similarly strong seasonal variations of climatic condition were found for agricultural buildings with livestock (objects “F”), the relative humidity being slightly lower (RH = 70 %). In the winter months, the interaction of the cold outside air and increased humidity in the non-insulated, unheated and partly open buildings resulted in high timber moisture contents and partly in condensation.

Since warehouses (objects “G”) are oftentimes realized as partly open buildings, the climate is highly influenced by the outside climate. The mean timber moisture contents were between 10 % and 14 %, their variation was amongst the highest of all evaluated types of use. Object “G1” is used to store plants during winter. The additional humidity introduced by the plants resulted in high relative humidity and occasionally in extensive condensation. The structural elements below skylights (i.e. exposed to direct sunlight) featured the highest amplitude and moisture gradient of all objects evaluated.

In addition to the previously described, construction and use-dependent climatic conditions, do the results of the research project highlight one more important aspect. Temporary interventions, such as renovations or changes of use (temporary or permanent) can lead to major changes in climatic conditions, which are reflected by distinct changes in timber moisture content. Within this research project, strong drying of timber elements (renovation of indoor swimming pool “A3” and temporary conversion of ice-skating rink “B3”) as well as strong moistening of dry timber elements (conversion of former metal-processing production facility “E2”) was measured. Although the evaluation period could sometimes not cover the full effect of the intervention, a noticeable increase of the moisture gradient was observed. Accordingly, care should be taken during such interventions to realize a decelerated change of climatic conditions.

4 Conclusions

Historically the subject of moisture content of structural timber elements tended to be treated from the viewpoint of how to prevent high moisture contents to inhibit decay or growth of fungi. The evaluation of damages in large-span timber structures shows that cracking parallel to the grain due to low or severe changes of moisture content is amongst the prevalent types of damage in such structures. These cracks reduce the residual cross-

section to transfer tension perpendicular to grain or shear stresses. Shrinkage related cracking might be less pronounced in structural elements from solid timber if the correct sawing patterns are applied. Structural elements from glued-laminated timber with large cross-sections are more vulnerable in that aspect due to their decelerated adaptability to changing ambient climate. Fast and/or significant changes of ambient climate can be due to the type of construction and use of the building. Locally, these changes can be intensified, e.g. around skylights or in the vicinity of heating systems. In buildings with constant but dry climate, the most severe change of the same will mostly occur during the first winter of operation, after assembly and closure of the building.

A decelerated change of internal climate can be realized by adjusting heating systems to not reduce the relative humidity too fast and too strong. An artificial air humidification, e.g. in the form of evaporation basins is another possibility to damp the speed of drying of the structural timber elements. An alternative is a surface treatment, e.g. in the form of products which damp the moisture absorption and release in the first years of operation of the building (to counter fast drying of newly installed elements in constant but dry climates). In areas with strong but periodic changes of moisture content, protective covering in the form of panel materials could be another feasible measure. The last-mentioned possibility is momentarily being investigated and measured in a separate research project carried out by the authors in collaboration with the Studiengemeinschaft Holzleimbau e.V. In addition, it is intended to continue the measurements presented in ten objects with seasonally varying climate. Hereby the measurement equipment shall be upgraded in order to take additional measurements of the temperature within the cross-section. These measurements shall be used to verify the approach to calculate the material temperature in the different depths on the basis of the measured surface temperatures.

A potential implementation of the conclusions presented would be to include such information in textbooks or commented versions of codes, highlighting the benefits of using timber elements which feature a moisture content mirroring the expected average moisture content. Although the expected average moisture content is to be determined individually for each building, examples of classification of buildings of specific use into Service Classes (e.g. riding rinks, ice-skating halls) could be given. To increase the awareness towards dry climates it could be worthwhile to consider including a note in the code stating that the average moisture content of softwoods in heated and insulated buildings (Service Class 1) will in most cases be below 10 %.

The objective of this research project was to provide data, enabling an overview over climatic conditions and resulting timber moisture contents which can occur in large buildings of different use. To establish realistic reference values with regard to damage potential (cracking), further research in form of modeling and sensitivity studies, in combination with laboratory tests is necessary.

Acknowledgement

The research project was kindly supported by the following industry partners: Scantronik Mugrauer, DE-Zorneding; Studiengemeinschaft Holzleimbau e.V., DE-Wuppertal, bauart Konstruktions GmbH + Co. KG, DE-Lauterbach, Konstruktionsgruppe Bauen AG, DE-Kempten. Special gratitude is extended to the Research Initiative "Future Building" for funding the project with financial means of the Federal Office for Building and Regional Planning. In addition, the authors wish to acknowledge the help of students Michael Kraus, Manuel Waidelich, Stephanie Riedler und Astrid Indefrey during the readout and charting of data.

Literature

- [1] EN 1995-1-1:2004, Eurocode 5: Design of Timber Structures – Part 1-1: General – Common rules and rules for buildings, European Committee for Standardization CEN, Brussels, Belgium, 2004.
- [2] Blaß, H.-J., Frese, M., Schadensanalyse von Hallentragwerken aus Holz, Band 16 der Reihe Karlsruher Berichte zum Ingenieurholzbau, KIT Scientific Publishing, Karlsruhe, 2010
- [3] Frühwald, E., Serrano, E., Toratti, T., Emilsson, A., Thelandersson, S., Design of safe timber structures – How can we learn from structural failures in concrete, steel and timber?, Report TVBK-3053, Div. of Struct. Eng, Lund University, 2007
- [4] Dietsch, P., Winter, S., Assessment of the Structural Reliability of all wide span Timber Structures under the Responsibility of the City of Munich, Proceedings 33rd IABSE Symposium, Bangkok, Thailand, September 9-11 2009
- [5] Dietsch, P., Einsatz und Berechnung von Schubverstärkungen für Brettschichtholzbauteile, Dissertation, Technische Universität München, submitted in 07/2012.
- [6] Blaß, H., J., Ehlbeck, J., Kreuzinger, H., Steck, G., Erläuterungen zu DIN 1052:2004-08, Bruderverlag, Karlsruhe, 2004
- [7] Meierhofer, U., & Sell, J. Physikalische Vorgänge in wetterbeanspruchten Holzbauteilen – 2. und 3. Mitteilung, Holz als Roh- und Werkstoff, 37 (6+12), 1979, pp. 227-234 and 447-454
- [8] Krabbe, E., Neuhaus, H., Über Konstruktion, Klima und Holzfeuchtigkeit eines Hallenbades, Bauen mit Holz, 91 (4), 1989, pp. 214-217
- [9] Koponen, S., Puurakenteiden kosteudenhallinta rakentamisessa, TKK-TRT Report 1-0502, Helsinki, 2002
- [10] Evans, F., Kleppe, O., Dyken, T., Monitoring of Timber Bridges in Norway - Results, Report Norsk Treteknisk Institutt, Oslo, 2007
- [11] Feldmeier, F., Ergebnisse und Schlussfolgerungen aus den Felduntersuchung einer Eissporthalle, Tagungsband Ingenieurholzbau - Karlsruher Tage, 2007, pp. 98-104
- [12] Brischke, C., Rapp, A. O., Untersuchung des langfristigen Holzfeuchteverlaufs an ausgewählten Bauteilen der Fußgängerbrücke in Essing, Arbeitsbericht der Bundesforschungsanstalt für Forst- und Holzwirtschaft, Hamburg, 2007
- [13] Marquardt, H., Mainka, G.-W., Tauwasserausfall in Eissporthallen, Bauphysik, 30 (2), 2008, pp. 91-101
- [14] Niemz, P., Gereke, T., Auswirkungen kurz- und langzeitiger Luftfeuchteschwankungen auf die Holzfeuchte und die Eigenschaften von Holz, Bauphysik, 31 (6), 2009, pp. 380-385
- [15] Ressel, J., B., Fundamentals of wood moisture content measurement, Course notes, COST E53 Training School “Methods for measuring of moisture content and assessment of timber quality”, BFH, Hamburg, October 17 – 19 2006
- [16] Euler, L., Institutiones Calculi differentialis, Berlin, 1755
- [17] Kollmann, F., Coté, W., A., Principles of Wood Science and Technology I: Solid Wood, Springer, Berlin, 1968
- [18] Fortuin, G., Anwendung mathematischer Modelle zur Beschreibung der technischen Konvektionstrocknung von Schnittholz, Dissertation, Universität Hamburg, 2003
- [19] Keylwerth, R., Noack, D., Über den Einfluß höherer Temperaturen auf die elektrische Holzfeuchtigkeitsmessung nach dem Widerstandsprinzip, Holz als Roh- und Werkstoff, 14 (5), 1956, pp. 162-172.
- [20] Hailwood, A. J., Horrobin, S., Absorption of water by polymers: analysis in terms of a simple model, Transactions of the Faraday Society, Vol. 42b, 1946, pp. 84-92
- [21] Simpson, W. T., (1973), Predicting equilibrium moisture content of wood by mathematical models, Wood and Fiber Science, 5 (1), 1973, pp. 41-48
- [22] Gamper, A., Dietsch, P., Merk, M., Winter, S., Gebäudeklima - Langzeitmessung zur Bestimmung der Auswirkungen auf Feuchtegradienten in Holzbauteilen, Final Report, Lehrstuhl für Holzbau und Baukonstruktion, Technische Universität München, 2012

* This list only includes references in direct connection to this paper. A complete list of references with regard to the project is given in the final report.