

JRC CONFERENCE AND WORKSHOP REPORTS

2nd Symposium on Management of Future motorway and urban Traffic Systems (MFTS 2018)

*Booklet of abstracts
Ispra, 11-12 June 2018*

Editors:

Ciuffo, B., Alonso Raposo, M.,
Mourtzouchou, A., Belov, A.,
Makridis, M., Mattas, K., Mogno, C.

2018



MFTS 2018

11-12 June 2018, Ispra (Italy)

This publication is a Conference and Workshop report by the Joint Research Centre (JRC), the European Commission's science and knowledge service. It aims to provide evidence-based scientific support to the European policymaking process. The scientific output expressed does not imply a policy position of the European Commission. Neither the European Commission nor any person acting on behalf of the Commission is responsible for the use that might be made of this publication.

Contact information

Name: Biagio Ciuffo

Address: European Commission, Joint Research Centre, Via E. Fermi 2749, I-21027, Ispra (VA), Italy

Email: maria.alonso-raposo@ec.europa.eu

Tel.: +39 0332 789732

JRC Science Hub

<https://ec.europa.eu/jrc>

JRC112141

EUR 29248 EN

PDF	ISBN 978-92-79-87680-6	ISSN 1831-9424	doi:10.2760/722699
Print	ISBN 978-92-79-87679-0	ISSN 1018-5593	doi:10.2760/794584

Luxembourg: Publications Office of the European Union, 2018

© European Union, 2018

Reuse is authorised provided the source is acknowledged. The reuse policy of European Commission documents is regulated by Decision 2011/833/EU (OJ L 330, 14.12.2011, p. 39).

For any use or reproduction of photos or other material that is not under the EU copyright, permission must be sought directly from the copyright holders.

How to cite this report: Ciuffo, B., Alonso Raposo, M., Mourtzouchou, A., Belov, A., Makridis, M., Mattas, K., Mogno, C., *2nd Symposium on Management of Future motorway and urban Traffic Systems (MFTS 2018) - Booklet of abstracts - Ispra, 11-12 June 2018*, EUR 29248 EN, Publications Office of the European Union, Luxembourg, 2018, ISBN 978-92-79-87680-6, doi:10.2760/722699, JRC112141

All images © European Union 2018, except:

Upon submitting the final version of their abstract the authors have explicitly granted the European Commission the right of publishing the material contained therein.

Contents

Acknowledgements	1
1 Introduction	2
2 Abstracts DAY 1	5
2.1 Policy-Meets-Science Session	7
2.1.1 Enhanced Traffic Management – C-ITS Platform 2 nd Phase	7
2.1.2 Internet of Things and Autonomous Driving – Centralized or Decentralized?	9
2.1.3 Traffic Management Challenges with Connected and Automated Vehicles ..	12
2.2 Panel Session: Which role do we envisage for public authorities in the management of future motorways and urban traffic systems?	14
2.3 Parallel Session 1a - Networks.....	15
2.3.1 High-dimensional dynamic origin-destination demand calibration of large-scale stochastic simulation-based traffic models	15
2.3.2 On the Impact of Altruistic Autonomous Vehicles on the Efficiency of the Traffic Assignment Problem.....	18
2.3.3 PC-SPSA: Employing dimensionality reduction to limit SPSA noise in DTA model calibration	19
2.3.4 System optimal traffic management with vehicle connectivity and automation	22
2.3.5 GPU-assisted resilience analysis of land transportation networks	25
2.3.6 On efficiency and resilience of connected transportation networks.....	27
2.4 Parallel Session 1b - Projects and case-studies	28
2.4.1 Enhanced Traffic Management with Cooperative Intelligent Transport Systems – an example from Bordeaux Pilot Site	28
2.4.2 SHERPA-city, a web tool to evaluate the impact of traffic management schemes at urban level.....	31
2.4.3 Motorway-to-Motorway Metering.....	33
2.4.4 MEL Ecobonus-Mobility: A Smartcity project based on « In Vivo » evaluation concept	34
2.4.5 SOCRATES 2.0 – vision on paving the way for the future traffic management in Europe	36
2.4.6 EU ITS Platform on Future Motorway Traffic: Strategic Dialogue, Guidance, Operational Excellence	40
2.5 Parallel Session 2a - Collective Services.....	42
2.5.1 Frequent travel clustering algorithm for public transport planning	42
2.5.2 Assessment of system resilient performance indicators: Application for public transport systems.....	44
2.5.3 Improving Public Transport Service Regularity using Cooperative Driver Advisory Systems	46
2.5.4 A statistical simulation-based approach to identify network vulnerability to urban freight movements	49

2.6 Parallel Session 2b - ADAS.....	50
2.6.1 Cooperative Adaptive Cruise Control with Authority Transition at Merges: Insights into Flow Characteristics.....	50
2.6.2 Estimating the response time of a commercially available ACC controller ..	56
2.6.3 Safety Analysis of Cooperative Adaptive Cruise Control System in a Mixed Vehicle Scenario	59
2.6.4 A kinematic wave theory of tidal traffic flow	61
2.6.5 MPC-based optimal path planning for automated vehicles in realistic simulation.....	62
2.6.6 Optimal control of cooperative traffic systems with Hamilton-Jacobi formulation of kinematic wave model	64
3 Abstracts DAY 2	67
3.1 Plenary Session	69
3.1.1 Cars and Cities: a Quantitative Perspective on Some Future Mobility Models	69
3.2 Parallel Session 3a - Modelling	71
3.2.1 Submicroscopic framework to model mixed highway traffic.....	71
3.2.2 Minimization of Fuel Consumption for Vehicle Trajectories.....	75
3.2.3 Reduction of travel times and expected number of crashes in freeway traffic systems	77
3.2.4 Holistic approach for simulation of CAVs environment.....	80
3.2.5 MFC acceleration model – Simulating the vehicle dynamics	82
3.2.6 Modeling mixed flow of two-wheelers and cars in Lagrangian coordinates ..	85
3.3 Parallel Session 3b - Projects and case-studies	86
3.3.1 Economic implications of the transition to a Cooperative, Connected and Automated Mobility (CCAM)	86
3.3.2 Centralized Infrastructure-Assisted Management for Mixed Traffic at Transition Areas	88
3.3.3 Evolving Urban ITS standards - European Traffic Management & Multi-vendor Environments	91
3.3.4 Addressing Barriers and Opportunities Engendered by Big Data in Transport: The LeMO Project	93
3.3.5 Assessing the impact of CAVs on network capacity, fuel consumption and emissions. A motorway scenario	95
3.4 Parallel Session 4a - Traffic Control with CAVs.....	98
3.4.1 Real-time adaptive signal control strategies exploiting emerging vehicle technologies.....	98
3.4.2 Optimal flow metering and lane-changing control at motorway bottlenecks ..	99
3.4.3 Hierarchical multi-injection strategy and platoon manoeuvres at network junctions	101
3.4.4 Impact of Reservation-based Roadway Control on Capacity of Automated Vehicle Urban Traffic Systems	104

3.4.5	Distributed Collaborative Network Management	107
3.5	Parallel Session 4b - (Big) Data	109
3.5.1	Yes we can, with CANbus data	109
3.5.2	Analysis of Road Safety Speed from Floating Car Data and Their Possible Use in a V2V Environment.....	111
3.5.3	The power of information to assess road transportation impacts for a connected and sustainable mobility	113
3.5.4	Application of Hard Shoulder Lanes on Tunnels based on Studies of Driver Behavior using Virtual Reality Technologies.....	116
3.5.5	Using mobile phone data for urban network state estimation.....	118
3.5.6	Traffic state estimation and prediction at signalized intersections based on connected vehicles.....	121
3.6	Parallel Session 5a - Traffic Control	124
3.6.1	An application of shock wave theory to urban traffic modeling and control via dynamic speed advisory	124
3.6.2	Dynamic Emergency Lane Control.....	127
3.6.3	FF-ALINEA: A ramp metering control strategy for nearby and distant bottlenecks	130
3.6.4	Integrated Motorway Traffic Control Using Variable Speed Limits and Lane Change Control	132
3.7	Parallel Session 5b - Traffic Management.....	134
3.7.1	A social community approach to traffic management	134
3.7.2	Traffic Management as a Service	136
3.7.3	Quantum AI-based traffic management system	138
3.7.4	Coordination Models for Road Vehicle Automation. A Research Agenda ...	140

Acknowledgements

The editors would like to express their gratitude to the MFTS2018 contributors for the relevant and high quality material provided. The editors are mostly grateful to Ewelina Sujka, for all her efforts in organising the MFTS2018 Symposium.

Editors

Ciuffo, B., Joint Research Centre

Alonso Raposo, M., Joint Research Centre

Mourtzouchou, A., Joint Research Centre

Belov, A., Joint Research Centre

Makridis, M., Joint Research Centre

Mattas, K., Joint Research Centre

Mogno, C., Joint Research Centre

1 Introduction

The **2nd Symposium on Management of Future motorway and urban Traffic Systems** is focused on **future traffic management systems**, covering the subjects of traffic control, estimation, and modelling of motorway and urban networks, with particular emphasis on the presence of advanced vehicle communication and automation technologies. As connectivity and automation are being progressively introduced in our transport and mobility systems, there is indeed a growing need to understand the implications and opportunities for an enhanced traffic management as well as to identify innovative ways and tools to optimise traffic efficiency. In particular the debate on **centralized versus decentralized traffic management in the presence of connected and automated vehicles** has started attracting the attention of the research community. In this context, the Symposium provides a remarkable opportunity to share novel ideas and discuss future research directions.

The event is held at the premises of the *Joint Research Centre* of the *European Commission* in Ispra (Italy) on June 11-12, 2018.

CONFERENCE SCOPE AND FORMAT

MFTS 2018 dedicates **two full days** to discuss about the latest advances in the field of traffic management, specifically targeting the following main subjects:

- Which current and future traffic management challenges exist?
- How these challenges are being addressed at present?
- How connectivity and automation can support an enhanced traffic management in the future?
- What would be the best option for a future enhanced traffic management: centralized or decentralized?

A **threefold perspective** is adopted, representing the views and activities of the **Policy, Industry and Research/Academia** sectors as follows:

- A **Science-meets-policy day**, fostering exchange between European policy makers, local authorities, researchers and industrial partners dealing with transport connectivity and automation; followed by,
- A **Science-dedicated day**, uncovering up-to-date contributions from the scientific community on the core subjects.

Invited keynote speakers from these sectors set the scene with important facts and prospects, and a number of selected speakers provides key contributions in the form of presentations/posters.

A leaflet and website of the Symposium have been created, providing relevant details about the event: <https://ec.europa.eu/jrc/en/event/conference/mfts2018>.

ABSTRACT SUBMISSION

A **call for abstracts** was launched by the end of 2017. These abstracts have been compiled in the present **booklet of abstracts**, edited and published as a European Commission JRC Conference and Workshop Report.

Presenters have been selected on the basis of the information provided in the abstracts submitted. Each abstract was required to clearly formulate the main messages the authors would like to convey to the audience, following a given template. For abstracts submission, the Symposium functional mailbox was given:

JRC-MFTS-2018@ec.europa.eu.

Furthermore a **special issue** on the Management of Future Motorway and Urban Traffic Systems will be published on the **IEEE Transactions on Intelligent Transportation**

Systems¹. Full paper submission deadline is October 31st. Submission is not restricted to MFTS2018 participants.

PARTICIPATION

MFTS 2018 is **open for participation to**: *Researchers and Academics; Transport infrastructure managers and owners; Traffic operation managers, road transport operators; Industry, vehicle manufacturers and suppliers; Public authorities, governmental bodies; Non-governmental organisations; Other road transport stakeholders.*

Registration is **free of charge** and includes access to all symposium sessions, symposium material, lunches, coffee breaks and transport arrangements.

VENUE AND TRAVEL INFORMATION

The Symposium venue is the **Joint Research Centre of the European Commission** located in **Ispra** (Italy).

Venue address:

Via E. Fermi 2479, I - 21027 Ispra (Varese) Italy

EXTERNAL LINKS

The organisation of the 2nd Symposium on Management of Future motorway and urban Traffic Systems is coordinated with the organization of the 15th IFAC Symposium on Control in Transportation Systems (on June 6-8, 2018 in Savona, Italy). More information about this event is available at <http://www.cts2018.unige.it>.

LOCAL ORGANISING COMMITTEE

The following people are part of the **local organising committee**:

- Biagio Ciuffo (European Commission Joint Research Centre)
- María Alonso Raposo (European Commission Joint Research Centre)
- Michalis Makridis (European Commission Joint Research Centre)
- Konstantinos Mattas (European Commission Joint Research Centre)
- Ewelina Sujka (European Commission Joint Research Centre)
- Christian Thiel (European Commission Joint Research Centre)

SCIENTIFIC COMMITTEE

The following people are part of the **scientific committee**:

- Konstantinos Ampountolas (University of Glasgow)
- Constantinos Antoniou (Technical University of Munich)
- Nikolaos Bekiaris Liberis (Technical University of Crete)
- Neila Bhour (IFSTTAR)
- Klaus Bogenberger (Universität der Bundeswehr München)
- Rodrigo Castelan Carlson (Universidade Federal de Santa Catarina)
- Hilmi Celikoglu (Technical University of Istanbul)
- Andy Chow (City University of Hong Kong)
- Biagio Ciuffo (European Commission Joint Research Centre)
- Giacomo Como (Lund University)
- Giovanni De Nunzio (IFPEN)

¹ <https://www.ieee-itss.org/its-transactions-ongoing-special-issues>

- Nadir Farhi (IFSTTAR)
- José Ramón D. Frejo (TU Delft)
- Nikolas Geroliminis (EPFL)
- Jack Haddad (Israel Institute of Technology)
- Andreas Hegyi (TU Delft)
- Wenlong Jin (University of California Irvine)
- Mehdi Keyvan-Ekbatani (University of Canterbury)
- Tasos Kouvelas (EPFL)
- Balázs Adam Kulcsár (Chalmers University of Technology)
- Ludovic Leclercq (IFSTTAR)
- Carlos Lima Azevedo (MIT)
- Michalis Makridis (European Commission Joint Research Centre)
- Andreas Malikopoulos (University of Delaware)
- Vittorio Marzano (University of Napoli)
- Monica Menendez (ETH Zurich)
- Gábor Orosz (University of Michigan)
- Carolina Osorio (MIT)
- Ioannis Papamichail (Technical University of Crete)
- Vincenzo Punzo (University of Napoli)
- Mohsen Ramezani (The University of Sydney)
- Claudio Roncoli (Aalto University)
- Meead Saberi (Monash University)
- Samitha Samaranayake (Cornell)
- Ketan Savla (University of Southern California)
- Silvia Siri (University of Genova)
- Francesc Soriguera (Technical University of Catalunya)
- Christian Thiel (European Commission Joint Research Centre)
- Tomer Toledo (Israel Institute of Technology)
- Francesco Viti (University of Luxembourg)
- Meng Wang (TU Delft)
- Yibing Wang (Zhejiang University)

2 Abstracts DAY 1

An overview of the agenda of Day 1 is presented below:

MFTS 2018 DAY 1 - Monday 11 June 2018		
09:00-10:00	Registration and coffee	
10:00-10:10	MFTS2018 Welcome (<i>Auditorium</i>)	
10:10-12:00	Policy-Meets-Science Session (<i>Auditorium</i>)	
12:00-13:00	Panel Session: Which role do we envisage for public authorities in the management of future motorways and urban traffic systems? (<i>Auditorium</i>)	
13:00-14:00	Lunch break and Posters Session Day 1 (<i>Building 101 Ground Floor</i>)	
14:00-15:40	Parallel Session 1a: Networks (<i>Auditorium</i>)	Parallel Session 1b: Projects and case-studies (<i>Building 101/1003</i>)
15:40-16:00	Coffee break (<i>Auditorium</i>)	
16:00-17:40	Parallel Session 2a: Collective Services (<i>Auditorium</i>)	Parallel Session 2b: ADAS (<i>Building 101/1003</i>)
17:40-18:10	Posters Session Day 1 (<i>Building 101 Ground Floor</i>)	
20:30	Social Dinner	

A more detailed agenda is presented next:

09:00-10:00 **Registration and coffee**

10:00-10:10 **MFTS2018 Welcome** (*C. Roncoli, B. Ciuffo*)

Auditorium

10:10-12:00 **Policy-Meets-Science Session** (Chair: *P. Szymanski*)

P. Barradas (European Commission DG MOVE), *D. Helbing* (ETH Zurich) and *S. Shladover* (PATH University of California, Berkeley)

Auditorium

12:00-13:00 **Panel Session:**

Which role do we envisage for public authorities in the management of future motorways and urban traffic systems? (Chair: *F. Viti, B. Ciuffo*)

S. Shladover (PATH University of California, Berkeley), *D. Helbing* (ETH Zurich), *U. Fugiglando* (MIT), *P. Barradas* (European Commission DG MOVE), *R. Arditi* (EU EIP), *A. de Kort* (Rijkswaterstaat), *E. Marlier* (EPF)

Auditorium

13:00-14:00 **Lunch break and Posters Session Day 1** (Chair: *M. Alonso Raposo, N. Bekiaris Liberis*)

Building 101 Ground Floor

14:00-15:40 **Parallel Session 1a: Networks** (Chair: *I. Papamichail*)

C. Osorio, A. Espinosa, C. Antoniou, A. Belov, L. Galbusera, G. Como

Auditorium

14:00-15:40 **Parallel Session 1b: Projects and case-studies** (Chair: *G. De Nunzio*)

E. Monceyron, B. Degraeuwe, I. Cornwell, S. Melenec, I. Koller-Matschke, T. Geißler

Building 101/1003

15:40-16:00 **Coffee break**

Auditorium

16:00-17:40 **Parallel Session 2a: Collective Services** (Chair: *C. Antoniou*)

N. S. Hadjidimitriou, S. M. Hassan Mahdavia, G. Laskaris, Koutsopoulos, H. Simoni M. D.

Auditorium

16:00-17:40 **Parallel Session 2b: ADAS** (Chair: *C. Osorio*)

L. Xiao, M. Makridis, R. H. Patel, K. Ampountolas, K. S. Mountakis, A. H. F. Chow

Building 101/1003

17:40-18:10 **Posters Session continuation Day 1**

Building 101 Ground Floor

20:30 **Social Dinner**

2.1 Policy-Meets-Science Session

2.1.1 Enhanced Traffic Management – C-ITS Platform 2nd Phase

P. BARRADAS^a

^a *European Commission – Directorate General for Mobility and Transport*

If we focus on the road context, in many respects today's vehicles are already connected devices. In the near future, they are expected to interact directly with each other (vehicle to vehicle communications - V2V) and with the infrastructure (Vehicle to Infrastructure communications - V2I). This interaction is the domain of Intelligent Transport Cooperative Systems (C-ITS). This cooperative element can contribute significantly to road safety, traffic efficiency and driving comfort by helping the driver to make better decisions and to adapt to different traffic conditions in a more informed and dynamic manner. But for mobility to reap the benefits of digitization, it is important to understand that the period of coexistence of these with other types of vehicles on our roads will be long. It is also important to understand that these vehicles equipped with C-ITS technology will to a certain extent be 'computers connected on wheels'. As such, traffic rules (be they static or dynamic, obligations or recommendations), traffic patterns and traffic signs, will have to be digitized and translated into 'lines of code' so that they can be properly interpreted by vehicles. These 'electronic regulations' will be essential for the support and development of advanced autonomous driving functions.

They will also be essential to ensure that the mobility policy of cities can be translated into a more cooperative and integrated management transport system. The interaction of the Intelligent Transport Cooperative Systems domain should not therefore be confined to vehicles and infrastructure. It should be reflected in the orchestration of the various mobility systems and services. This means putting into practice collaboratively, when necessary, appropriate traffic management measures, seeking to reconcile the needs of individual mobility with the safeguarding of collective interest.

If we imagine the mobility of the future as an 'orchestra' of different transport systems, each able to play their own instrument, it will be necessary to follow a 'scoreboard' in order to be able to listen to music. Otherwise mobility will turn into deafening noise. The combination of the various systems should, when necessary, contribute in a synchronized, precise and harmonious way to reproduce a particular melody. The so-called 'instrumentalization' of mobility systems. Combinations of different systems for different situations. Music is the result of coordination and collaboration and the 'scoreboard', the element that interconnects the different systems: negotiation, collaboration and integration algorithms that make it possible to move from data to action.

A digital transport system requires thinking horizontally, in layers that cross the different modes of transport, and also in an integrated way, taking into account the vectors of energy and telecommunications. In addition, it requires you to stop thinking separately about the vehicle, its route and the infrastructure that supports it. An intelligent and sustainable transport vision must be able to integrate these three components and allow them to be permeable to data flows considered relevant to a cleaner, safer and more efficient mobility policy.

This data flow should be used to develop a layer of innovative services and applications that are made available through digital technologies to the various networks and transport systems. It is therefore necessary to accelerate the availability and facilitate access to transport data and to ensure that the exchange and re-use of data is in favor of the principles of safer, cleaner and integrated mobility. When establishing the digital architecture, the standards referred to in the legal framework of the European STI Directive and subsequent Delegated Acts (DATEX, SIRI, Netex, TAP-TSI, IATA, INSPIRE, TN-ITS) should be considered in order to guarantee interfaces interoperability and continuity of services in a data ecosystem that is intended to be efficient and secure.

This is the rationale underlying the creation of the European network of National Access Points. The doorway for the digitalisation of transportation.

The vision of a world where everything is connected (everything, everyone, everywhere) does not have to be incompatible with the diversity of options, freedom of choice and decentralized system governance, but the 'orchestration of mobility services' will require a 'conductor'. The neutral element that plays no instrument but is essential to music. A role that will undoubtedly be under the purview of the public sector.

In a 'intelligent' city, the various transport systems are interconnected in a digital layer, and greater degrees of interaction between different types of vehicles and traffic management systems can be expected. The vehicles communicate with each other and with the infrastructure and in this way priority can be given to certain types of transport, at certain times of the day and on certain routes, considered to be priority; for example emergency services, en route to a hospital; or a fire-fighting vehicle in response to an incident.

Lives are saved.

In a 'intelligent' city one can rethink the concept of public transport. By accessing real-time demand for transport, variable routes can be defined throughout the day and ensure better occupancy rates and contribute to a more efficient and diversified fleet management. Priority may be given to public transport at rush hour while alternative routes to other vehicles on the road may be suggested. You can also segment the demand by destination and distribute it by the various complementary systems (bus, metro, tram, shared, on demand, active modes ...), taking into account the available capacities, at that moment. Demand segmentation can be spatial or temporal. The allocation of time slots in conjunction with the assignment of certain routes to the various types of vehicles on the road (public or private) can contribute to shaping transport demand and reduce congestion. The combination of shared, on-demand and monthly subscription concepts can be a potentially interesting solution, not only in cities, but also in small urban settlements and rural areas, because it makes mobility more accessible, tailor made and inclusive.

Mobility is accessible, inclusive and sustainable.

In 'intelligent' cities, heavy goods vehicles can be encouraged to follow certain routes by providing direct incentives linked to fuel savings and travel times. The implementation of Green light optimized speed advisory (GLOSA), allows them to travel at a recommended speed, on a certain route with several traffic intersections in a coordinated way. And in reducing the number of stops, emissions are also significantly decreased. In an 'intelligent' city, the availability of the parking is known in real time and if the offer is lower than the demand, the city can direct you to its modal interfaces or to peripheral parking areas. You save time, energy and gain air quality.

Mobility is service-oriented, integrated, efficient and clean.

2.1.2 Internet of Things and Autonomous Driving – Centralized or Decentralized?

D. HELBING^a

^a *ETH Zurich/TU Delft/Complexity Science Hub Vienna*

Digital technologies – from cloud computing to Big Data, from Artificial Intelligence to cognitive computing, from robotics to 3D printing, from the Internet of Things to Virtual Reality, from blockchain technology to quantum computing – have opened up amazing opportunities for our future. The development of autonomous vehicles, for example, promises the next level of comfort and safety in mobility systems. At the same time, transport as a service allows for a new level of sustainability, as much less cars, parking lots and garages (and much less materials and energy required to build them) will be needed to offer the mobility we need. Nevertheless, the discussion, for example, about privacy, cybercrime, autonomous weapons, and “trolley problems” illustrates that, besides great opportunities, there are also major challenges and risks. Recently, not only in connection with Cambridge Analytica and Facebook, the public media have started to write about a “techlash” (i.e. a technological backlash), and engineering organizations such as the IEEE have started to work on frameworks such as “ethically aligned design”² and “value-sensitive design” or “design for values”.³ For example, experts discuss about solutions such as “privacy by design” or “democracy by design”⁴ (see Figure 1).

Figure 1. Core issues to consider in digital democracy platforms

What Is Democracy About?

- Human rights, human dignity
- Freedom
- Self-determination
- Pluralism
- Protection of minorities
- Division of power
- Checks and Balances
- Participation
- Transparency
- Fairness
- Justice
- Legitimacy
- Subsidiarity
- Anonymous and equal votes
- Privacy
- ✓ Protection from misuse/exposure
- ✓ Right to be left alone

Source: Own elaborations.

One of the question raised in this connection is: should we organize the data-rich society of the future in a centralized or decentralized way? This also concerns the deployment of the 5G network in Europe. An increasing number of experts recommends the development and use of decentralized information technologies (⁵) due to increasing dangers of misuse and vulnerabilities (e.g. by means of hacking), drawbacks on

(²) See the links:

http://standards.ieee.org/develop/indconn/ec/ead_v1.pdf,
http://standards.ieee.org/develop/indconn/ec/ead_v2.pdf, <https://ethicsinaction.ieee.org>

(³) <http://designforvalues.tudelft.nl>

(⁴) <https://www.ams-institute.org/solution/democracy-by-design/>

(⁵) <https://www.scientificamerican.com/article/will-democracy-survive-big-data-and-artificial-intelligence/>,
<https://techcrunch.com/2016/10/09/a-decentralized-web-would-give-power-back-to-the-people-online/>

democracy, and matters of resilience. In the following, I will shortly discuss economic, political, technological and health issues to consider.

1. A uniform, Europe-wide 5G network would not be economic. Making autonomous driving dependent on it could considerably delay autonomous driving. Today, many areas in Europe do not have a 3G or a 4G net, yet. This also includes many railway connections and many major roads, even in economically leading countries such as Germany. Besides, there are many regions lacking a mobile phone signal at all. It would be very expensive and take many years to deploy a 5G network all over Europe, which could offer standardized and reliable services as they would be needed to operate all traffic. By the time the deployment would be completed, we would probably have the next generations of wireless technology already, and perhaps new mobility concepts, too.

2. A Europe-wide control grid implies dangers to democracy. The developments in countries such as Turkey shows that powerful technologies can also be turned against people. A similar argument has recently been made about Facebook and various other IT companies, which have engaged in what is sometimes referred to as “surveillance capitalism” as well as in the manipulation of the opinions, emotions, decisions and behaviours of their users. It could be a political concern that technologies such as big nudging and neuromarketing aimed at manipulating peoples’ minds can be traced back to fascist projects and ideology. Moreover, it may raise concerns that some of the biggest companies harvesting Big Data across Europe have grown powerful during the Nazi regime or are linked to the military-industrial complex. Given that technologies originally developed for autocratic states and secret services are being applied to entire populations also in Western democracies,⁶ concerns are certainly not pointless. Decentralized data control could counter related risks.

3. If 5G would be deployed all over Europe as planned, this could imply health risks for hundreds of millions of people. Currently, we do not know enough what are the implications for health, if today’s radiation thresholds are exceeded or raised. In principle, as 5G is in the microwave spectrum, significant interaction of 5G radiation with biological matter, also the brain, cannot be sufficiently excluded. Hence, there may be undesirable side effects.

4. Autonomous driving as well as the Internet of Things can be operated in a decentralized way such that the local organization or self-organization of systems is enabled via real-time feedback. This includes traffic assistant systems based on “mechanism design” to reduce congestion on freeways, which is done by changing interactions between cars, based on local measurements. Novel self-organizing traffic light control systems are also able to considerably improve traffic flows in cities based on local measurements and interactions. Both can even be operated without a control centre. The traffic situation around the corner is more difficult to handle, but solutions using relay stations or laser-based systems are being developed.⁷

In summary, given the above concerns, the current “techlash”, and the fact that a decentralized realization of autonomous driving and IoT applications is possible, Europe would be wise to engage into the “digitization 2.0”, oriented primarily at local empowerment and coordination. This calls, in particular, for technical solutions supporting informational self-determination (see Figure 2). Data- and AI-based personal digital assistants could support people in taking better decision, in being more creative and innovative, and in coordinating each other and cooperating more successfully. They could also help us manage our personal data, namely who would have access to that what kinds of data and for what purposes. As trusted companies would get access to

⁽⁶⁾ See e.g. the Snowden and Wikileaks “Vault 7” revelations or the TED talk by Tristan Harris: <https://www.youtube.com/watch?v=C74amJRp730>

⁽⁷⁾ M. O’Toole, D.B. Lindell, and G. Wetzstein, Nature 555, 338-341 (2018); Autonome Autos: Laser-System und Algorithmen helfen verdeckte Objekte zu erkennen, <https://www.heise.de/newsticker/meldung/Autonome-Autos-Laser-System-und-Algorithmen-helfen-verdeckte-Objekte-zu-erkennen-3987149.html>

more data, the competition for data and trust would be expected to promote a trustable digital society. This would not only benefit autonomous driving.

Figure 2. Core issues to achieve informational self-determination

Informational Self-Determination

1. Send (a copy of) all personal data to a personal data mailbox
2. Require legally that personal data can only be used with the informed consent of individuals
3. Create a public platform that allows individuals to determine who is allowed to use what kind of data for what period of time and purpose (and what amount of money)
4. Build AI-based digital assistants that help people to easily administer personal data according to their preferences
5. Allow governments and scientists to run statistics on data
6. Report data use transparently to data mailbox

Source: Own elaborations.

2.1.3 Traffic Management Challenges with Connected and Automated Vehicles

S. E. SHLADOVER^a

^a PATH University of California, Berkeley

Connected and automated vehicles (CAV) have become an irresistible topic for discussion in the transportation field and among the general public in recent years, but those discussions are often clouded by use of vague and misleading terminology. This presentation begins with a clear definition of the terminology for driving automation systems based on the SAE J3016 classifications and definitions document. Before people can have a sensible discussion about a driving automation system, it is necessary to have clear definitions of the three primary attributes of such a system:

- The level of automation, or division of roles between the human driver and the automation system (ranging from level 0 with no automation to level 5, full automation under the entire range of conditions in which humans are able to drive);
- Whether the automation system is autonomous (independent and self-sufficient, without communication or cooperation with other vehicles or the infrastructure) or cooperative (communicating and coordinating with others);
- The operational design domain (ODD) of the system, identifying the geographic locations, road and traffic conditions, weather conditions and infrastructure support features needed for the automation system to be capable of performing its expected portions of the dynamic driving task.

Specific examples are provided to indicate the types of systems or functionality that represent each of the levels of automation.

The importance of the ODD is then explored in more detail, because this is the critical feature that determines how technologically challenging it will be to provide Level 4 automation (automating the complete dynamic driving task). Level 4 automation systems have already been in public use for 45 years in airport people movers, but those operate within a carefully restricted ODD, where they do not need to coexist with any unequipped vehicles, manually driven vehicles, bicyclists, pedestrians or animals. As the ODD restrictions are relaxed, the technological challenges increase dramatically, and examples are shown of some of the early attempts to provide Level 4 automation within less restricted ODDs (such as in the CityMobil2 Project). Segregation of the highly automated vehicles from hazards (moving obstacles) can enhance safety and facilitate earlier implementation of automation, but this requires physical infrastructure to enforce the separation and limits the locations where travelers can take advantage of the automation. This can be done in special cases, especially with newly constructed roads or cities, but is much harder to retrofit into existing built environments. For more general usage without physical segregation, the highly automated vehicles will have to be able to coexist with manually driven vehicles, bicyclists and pedestrians for the foreseeable future. It is hard to imagine the implementation of rules that would prohibit people from driving themselves in all but the most limited locations, just as horses are still permitted to use most roads a hundred years after they were rendered largely obsolete by motor vehicles.

A variety of architectures have been proposed for coordinating the actions of driving automation systems. This presentation advocates the advantages of a distributed hierarchical architecture as originally proposed by Varaiya in 1991, which provides for simplicity of development and implementation and minimizes the communication system burdens. In such an architecture, the safety-critical functions are confined to the lowest levels of the architecture, with the simplest patterns of connectivity, while the traffic management functions are at the higher levels. Those higher levels can provide information to the local controllers and vehicle controllers at the lower levels, but do not

exercise direct control over the safety-critical motions of the vehicles. This is important in ensuring safety, cyber security and computational and communication system efficiency.

Connectivity is central to the success of automation and to the management of automated traffic. This includes vehicle-vehicle (V2V) and vehicle-infrastructure-vehicle (V2I/I2V) wireless communications, each of which can enable automation functionalities that are not possible without connectivity. Those automation features are explained, with a particular emphasis on cooperative vehicle following, implemented as cooperative adaptive cruise control (CACC). Results of experiments with passenger cars using production ACC and CACC are shown in video and test data, with simulation models derived and calibrated directly from those data. The simulation models are then used to show how the capacity of a freeway section is decreased when the market penetration of ACC systems increases, but is increased significantly when those ACC systems are augmented with V2V communications to make them CACC. This shows the vital importance of the V2V coordination to enable any level of automation system to make traffic conditions better rather than worse than they are today.

The V2V communication capability is also very important for safety, to provide much faster responses to disturbances than human drivers or sensor-based automatic vehicle following systems. At higher levels of automation, verification of safe operation of all the adjacent vehicles can be ensured if they are all capable of communicating their status to each other (even the absence of messages from an expected vehicle source would indicate a problem), but this is not possible if unequipped vehicles are included in the mix. This leads to the conclusion that connectivity could be a more useful criterion to use to segregate vehicles than level of automation. If both connected manual and automated vehicles are mixed together, the V2V communications can provide safety assurance that would not be possible if unconnected vehicles were also included. This underscores the importance of implementing a mandate to equip new vehicles with V2V connectivity (a controversial topic at this stage in the U.S.).

The presentation concludes with a discussion of the central challenge of safety assurance for highly automated driving, and why this is going to require fundamental breakthroughs in software technology for the software at the safety-critical layers in the architecture. Based on current U.S. traffic safety statistics, fatal crashes occur once in about 3.4 million hours of driving (corresponding to 390 years of continuous 24/7 driving of an individual vehicle), while injury crashes correspond to about 7 years of continuous 24/7 driving. These levels of reliability far exceed the capabilities of modern software-driven consumer products such as portable computers and mobile phones, yet these levels must be achieved by highly automated driving systems before they can be societally acceptable. Learning systems are currently many orders of magnitude poorer at recognizing threats in the relatively unstructured driving environment than typical human drivers, so these are not the "silver bullet" to reach the required safety levels. These challenges in software safety assurance and in highly accurate threat assessment (with essentially zero false negatives and close to zero false positives) will require many years of fundamental research and development effort before the traffic management challenges will become the pacing item limiting the implementation of higher levels of driving automation.

2.2 Panel Session: Which role do we envisage for public authorities in the management of future motorways and urban traffic systems?

During the panel session, panellists and audience have discussed about the management of future transport systems on the basis of the following questions posed by the moderators.

1. How long will it take to reach a high (if not 100%) penetration of CAVs?
2. When an increasing number of vehicles will start to be connected and automated how traffic management can change? Which opportunities do you see for a better traffic management?
3. How people will react to the possibility of using shared CAVs? do you see the risk of a massive shift from mass transit to shared mobility services?
4. If shared CAVs will compete both with mass transit and with personal mobility there is the possibility that road traffic will significantly worsen. How to handle this? Do you see the need of a strong integration between all the modes of transport into a single transport management system with controlled access? Or should privately owned vehicles be allowed to use road transport as if it had infinite capacity (as it is the case today)?
5. Bounding the capacity of the transportation system may have negative consequences in terms of fairness. Is it possible to conceive an efficient transport system which at the same time ensures for everybody the right to move?
6. How will the value of time of travelers change with CAVs?
7. Assuming that technological and technical challenges are not a problem, what will be the legal aspects/barriers that will slow down CAV deployment?

The interaction between speakers and audience was facilitate by the use of the Slido interactive polling system⁸.

⁸ <https://www.sli.do/>

2.3 Parallel Session 1a - Networks

2.3.1 High-dimensional dynamic origin-destination demand calibration of large-scale stochastic simulation-based traffic models

C. OSORIO^a

^a *Department of Civil and Environmental Engineering, Massachusetts Institute of Technology, USA*

High-resolution urban traffic and mobility data is becoming increasingly available worldwide. This has sparked an increased interest in the development of traffic models to inform the design and the operations of urban mobility networks. Additionally, both the supply and the demand of our transportation systems are becoming more intricate (e.g., with vehicle-to-vehicle and vehicle-to-infrastructure communications). This is leading to more sophisticated and more intricate traffic models. Nonetheless, in order to enable the use of this new generation of higher resolution traffic models to inform practice, there is a pressing need to provide practitioners with systematic tools that enable the adequate calibration and validation of these models. The problem of model calibration has been widely studied in the literature. Nonetheless, there is a lack of algorithms that can efficiently address the difficult (e.g., high-dimensional, simulation-based, non-convex) calibration problems faced in practice.

This paper focuses on the offline calibration of demand, as defined by dynamic origin-destination (OD) matrices, for simulation-based traffic models. In general, the demand calibration problem aims to identify demand inputs that minimize a distance function between network performance estimates (e.g., expected link flows, speeds, travel times) obtained from field measurement and those obtained via simulation.

The goal of this paper is to design an OD calibration algorithm suitable for high-dimensional problems and large-scale networks. Moreover, the aim is to design a computationally efficient algorithm that can identify good quality solutions within few simulation runs. In practice, calibration algorithms are used within tight computational budgets (i.e., few simulation runs are carried out). Hence, the design of efficient algorithms contributes to current, and pressing, needs of practitioners.

A review of the recent OD calibration literature is provided in Zhang and Osorio (2017). The most common approach to simulation-based OD calibration has been the use of general-purpose algorithms, such as Stochastic Perturbation Simultaneous Approximation (SPSA) (Balakrishna et al.; 2007; Vaze et al.; 2009; Lee and Ozbay; 2009; Cipriani et al.; 2011; Ben-Akiva et al.; 2012; Lu et al.; 2015; Tympakianaki et al.; 2015) and the genetic algorithm (GA) (Kim et al.; 2001; Stathopoulos and Tsekeris; 2004; Kattan and Abdulhai; 2006; Vaze et al.; 2009). These commonly used general-purpose algorithms are guaranteed to achieve asymptotic convergence properties for a broad class of problems (e.g., non-transportation problems). Nonetheless, this generality comes with a lack of computational efficiency. In other words, the algorithms are not designed to identify good quality solutions fast (i.e., within tight computational budgets or few simulation runs). Nonetheless, when used to address OD calibration problems they are typically used within tight computational budgets. There is a current need to design efficient calibration algorithms.

This paper proposes to achieve computational efficiency by designing algorithms specifically tailored for calibration problems. More specifically, we propose to embed within the algorithm analytical and differentiable problem-specific structural information that enables the algorithm to identify good quality solutions within few simulation runs. The main idea, which we have successfully used for other continuous transportation problems (e.g., signal control (Chong and Osorio; 2017), congestion pricing (Osorio and Atastoy; 2017)), is to formulate, and embed within the algorithm, an analytical network model that provides an approximation of the (simulation-based) mapping between the decision vector and the objective function. For a calibration problem, the mapping

approximates the relationship between the calibration vector (e.g., OD matrix) and the simulation-based components of the objective function (e.g., expected link flows).

Recently, this idea has been formulated for a time-independent calibration problem (i.e., a single time interval was considered along with a dynamic stochastic traffic simulator) (Osorio; 2017). In this abstract, we refer to the latter approach as the static method. In this paper, we extend the static method to propose a method suitable for dynamic OD estimation. Let us first summarize the main ideas of the static method. We then discuss its extension and discuss preliminary results.

The static method is a metamodel method. This means that at every iteration of the algorithm, the following two main steps are carried out: (i) all simulation observations collected so far are used to fit the parameters of an analytical model, known as the metamodel; (ii) an analytical (i.e., not simulation-based) optimization problem is solved that optimizes the metamodel function (in this abstract, we refer to this metamodel optimization problem as the subproblem). The advantage of a metamodel approach is that the difficult simulation-based optimization problem is solved by solving a series of analytical subproblems, for which traditional and efficient gradient-based algorithms can be used. The challenge of such an approach lies in the formulation of a suitable metamodel. More specifically, the metamodel should: (i) be analytical and differentiable (such that the gradient-based algorithms can be used to solve the subproblems), (ii) be computationally tractable or computationally efficient (because the subproblems are solved at every iteration of the calibration algorithm), (iii) be scalable (such that calibration problems for large-scale networks can be addressed), and it should also (iv) provide a good approximation of the simulation-based objective function in the entire feasible region.

The formulation of a tractable, efficient yet also accurate model is a major challenge. The static method proposed such a formulation that satisfied the above criteria. For a network with n links, the analytical model was formulated as a system of n nonlinear equations. The model provides an analytical approximation of the mapping between OD demand and link counts and speeds. It has endogenous route choice. Note in particular, that the dimension of the system of equations scales independently of the dimension of the route choice set and of the link lengths. This makes it a scalable model.

Nonetheless, the model provides a stationary (hence, time-independent) mapping of demand to link metrics (e.g., expected link counts or speeds). A natural extension of the static method for a dynamic OD estimation problem would be to formulate a dynamic analytical model. Nonetheless, this would not be sufficiently tractable and scalable. Hence, we propose to use a stationary model, yet to correct for the transients through a low-dimensional set of metamodel parameters that are estimated (or fitted) at every iteration of the algorithm.

This simple idea has been tested both on toy networks (9 ODs, 28 links) with excellent results. Ongoing work is applying it to a calibration problem of a Singapore network, with four 30-minute time intervals during the morning peak period and 4050 ODs per time interval. The network contains 1150 links and over 18,000 routes. The preliminary results obtained so far are promising. The algorithm will be benchmarked versus a standard general-purpose derivative-free optimization algorithm suitable for high-dimensional problems. The talk will also discuss the potential of these ideas for real-time OD calibration.

References

- [1] Balakrishna, R., Ben-Akiva, M. E. and Koutsopoulos, H. N. (2007). Offline calibration of dynamic traffic assignment: simultaneous demand-and-supply estimation, *Transportation Research Record* 2003: 50–58.
- [2] Ben-Akiva, M., Gao, S., Wei, Z. and Wen, Y. (2012). A dynamic traffic assignment model for highly congested urban networks, *Transportation Research Part C* 24: 62–82.

- [3] Chong, L. and Osorio, C. (2017). A simulation-based optimization algorithm for dynamic large-scale urban transportation problems, *Transportation Science*. Forthcoming. Available at: <http://web.mit.edu/osorioc/www/papers/osoChoDynSOsubmitted.pdf>.
- [4] Cipriani, E., Florian, M., Mahut, M. and Nigro, M. (2011). A gradient approximation approach for adjusting temporal origin-destination matrices, *Transportation Research Part C* 19(2): 270–282.
- [5] Kattan, L. and Abdulhai, B. (2006). Noniterative approach to dynamic traffic origin-destination estimation with parallel evolutionary algorithms, *Transportation Research Record* 1964: 201–210.
- [6] Kim, H., Baek, S. and Lim, Y. (2001). Origin-destination matrices estimated with a genetic algorithm from link traffic counts, *Transportation Research Record* 1771: 156–163.
- [7] Lee, J. B. and Ozbay, K. (2009). New calibration methodology for microscopic traffic simulation using enhanced simultaneous perturbation stochastic approximation approach, *Transportation Research Record* 2124: 233–240.
- [8] Lu, L., Xu, Y., Antoniou, C. and Ben-Akiva, M. (2015). An enhanced SPSA algorithm for the calibration of dynamic traffic assignment models, *Transportation Research Part C* 51: 149–166.
- [9] Osorio, C. (2017). High-dimensional offline od calibration for stochastic traffic simulators of large-scale urban networks, *Technical report*, Massachusetts Institute of Technology. Under review. Available at: <http://web.mit.edu/osorioc/www/papers/osoODCalib.pdf>.
- [10] Osorio, C. and Atastoy, B. (2017). Efficient simulation-based toll optimization for large-scale networks, *Technical report*, Massachusetts Institute of Technology. Under review. Available at: <http://web.mit.edu/osorioc/www/papers/osoAtaTollSO.pdf>.
- [11] Stathopoulos, A. and Tsekeris, T. (2004). Hybrid meta-heuristic algorithm for the simultaneous optimization of the O-D trip matrix estimation, *Computer-Aided Civil and Infrastructure Engineering* 19(6): 421–435.
- [12] Tympakianaki, A., Koutsopoulos, H. and Jenelius, E. (2015). c-SPSA: Cluster-wise simultaneous perturbation stochastic approximation algorithm and its application to dynamic origindestination matrix estimation, *Transportation Research Part C* 55: 231–245.
- [13] Vaze, V., Antoniou, C., Wen, Y. and Ben-Akiva, M. (2009). Calibration of dynamic traffic assignment models with point-to-point traffic surveillance, *Transportation Research Record* 2090: 1–9.
- [14] Zhang, C. and Osorio, C. (2017). Efficient offline calibration of origin-destination (demand) for large-scale stochastic traffic models, *Technical report*, Massachusetts Institute of Technology. Under review. Available at: <http://web.mit.edu/osorioc/www/papers/zhaOsoODcalib.pdf>.

2.3.2 On the Impact of Altruistic Autonomous Vehicles on the Efficiency of the Traffic Assignment Problem

A. ESPINOSA^a, R.E. WILSON^a, R.D. CONNORS^b

^a *Department of Engineering Mathematics, University of Bristol*

^b *Institute for Transport Studies, University of Leeds*

It is well-known that the user equilibrium (UE) route assignment achieved by self-optimising drivers on a transport network is usually inefficient. Drivers' total cost (consisting principally of their travel time) is larger than in the system optimal (SO) route assignment, where drivers are centrally directed in order to minimise their total cost. However, in contrast to the SO assignment, the UE assignment is fair in that journeys with the same start and end points cost the same, regardless of the chosen route.

In future, autonomous vehicles (AVs) may introduce the possibility of achieving, or at least approaching, the SO assignment, if they behave altruistically so as to accept the directions of a central controller. Therefore in this paper, we study a version of the standard traffic assignment problem (STAP) in which a population of traditional self-optimising drivers interacts with a population of centrally directed AVs. In essence, this results in a bi-level problem where one population solves for UE and the other for SO, with the two populations interacting via the marginal congestion they each cause on the network. The resulting assignment is fair amongst the self-optimising drivers, however, AVs usually have to pay a range of higher costs to serve the wider interest.

For a given network problem with fixed topology and demand, the bifurcation parameter of interest is the proportion $\gamma \in [0, 1]$ of AVs. For $\gamma = 0$, we have no AVs and we obtain the present-day UE assignment. However $\gamma = 1$ represents a distant future where there are no traditionally driven vehicles at all and the SO assignment may be attained. Thus by increasing γ , we may study pathways into the future as the proportion of AVs is increased.

Our analysis begins with small-scale exemplar networks (sets of parallel links, the classical Braess diamond etc.) and a single origin-destination (OD) pair. The surprising result is that one has to introduce quite high proportions of AVs for there to be an improvement (reduction) in the total system cost. Specifically, for each set-up we find $\gamma_{crit} \in (0, 1)$ so that for $\gamma \leq \gamma_{crit}$ there is no reduction whatsoever in the total system cost, which then reduces sharply (via a first order phase transition) at γ_{crit} . In effect, for $0 \leq \gamma \leq \gamma_{crit}$ the selfish drivers rearrange their routes to soak up any benefit that the AVs provide. The implication is somewhat depressing: it is likely to be many more years before AVs deliver improved network efficiency via centrally directed route choice.

Finally, we study the dependence of the total system cost on γ for ensembles of larger scale networks. These are the synthetic city network models that we introduced at the 2017 Traffic and Granular Flow meeting. In particular, their topology may be varied via two further parameters which describe their grid-ness and connectedness. Despite the much more complicated set-up, the conclusions of the small-scale studies continue to hold broadly: namely, one needs large numbers of AVs to achieve a significant reduction in the total system cost.

2.3.3 PC-SPSA: Employing dimensionality reduction to limit SPSA noise in DTA model calibration

M. QURASHI^a, T. MA^a, E. CHANIOTAKIS^a, C. ANTONIOU^a

^a *Technical University of Munich, Germany*

Calibration and validation have long been a significant topic in traffic model development. In fact, when moving to Dynamic Traffic Assignment (DTA) models, the need to dynamically update the demand component creates a considerable burden on the existing algorithms, often rendering them impractical. SPSA [1] has been proposed [2] for DTA and microscopic traffic simulation model calibration, with encouraging results. As the problem size increases, however, it has been observed by several researchers that SPSA has been failing to converge reasonably. A number of researchers have provided alternative solutions, aimed at overcoming this issue [3-7]. Furthermore, a number of researchers have recently started using principal components analysis (PCA) as a way of dimensionality reduction in origin-destination (OD) estimation [8-10], with very encouraging results.

In this research, we combine SPSA and PCA, into a new algorithm we call PC-SPSA, in order to improve its convergence properties. We formulate the algorithm, demonstrate its operation (mainly the transformations from the OD matrices to the principal component vectors), and explore its performance. Practical issues that emerge from the scale of different variables and bounding their values are also discussed.

In order to explore the performance of PC-SPSA, we create a synthetic problem, in which SPSA has trouble converging at an acceptable value (see Figure 6) and apply PC-SPSA, which not only ultimately converge to a very low error, but also converges extremely quickly (i.e. in a handful of iterations), as shown in Figure 3. The scenarios in Figure 3 are of different dimensions d indicated as number of zones (ranging from 20 to 90 zones) with OD flows as d^2 and counts as a fifth of the number of OD flows. (The dimension of the problem is 1024 OD flows and 200 counts. The scenarios in the figure legend correspond to the algorithm (SPSA or PC-SPSA) and the interval for which it is applied (1 through 4).)

Ongoing research applies the same methodology in a real network in Vitoria, Spain. The network consists of 5,799 links (about 600km in length) and 2884 nodes. The network is divided into 57 zones, leading to an OD matrix with dimension of 3249. There are also 349 detectors. Figure 4 shows the preliminary results from this application, where PC-SPSA is able to converge in about 10 iterations, at approximately half of the error of SPSA.

Future work includes the comparison of PC-SPSA with the alternative approaches that have been proposed, such as W-SPSA [3-4] and c-SPSA [5]. One advantage that is already evident is that unlike e.g. W-SPSA, where the weight matrix needs to be obtained, PC-SPSA does not require any specific manipulations. Furthermore, extension of the PC-SPSA in the entire spectrum of model variables is planned, including the supply side parameters, where principal components could be very suitable in extracting relationships between model variables (e.g. capacities), thus allowing for the development of more detailed and representative traffic simulation models, with lower computational overhead (and sensitivity to noise).

Figure 3. SPSA vs. PC-SPSA performance, Synthetic network

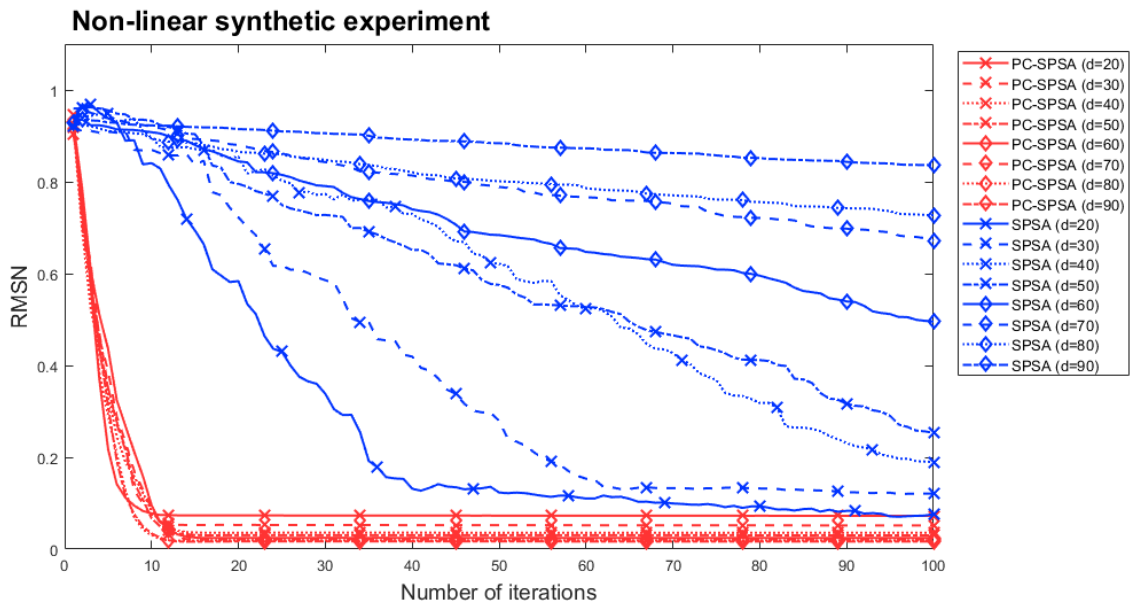

Source: Own elaborations.

Figure 4. SPSA vs. PC-SPSA performance, Vitoria network

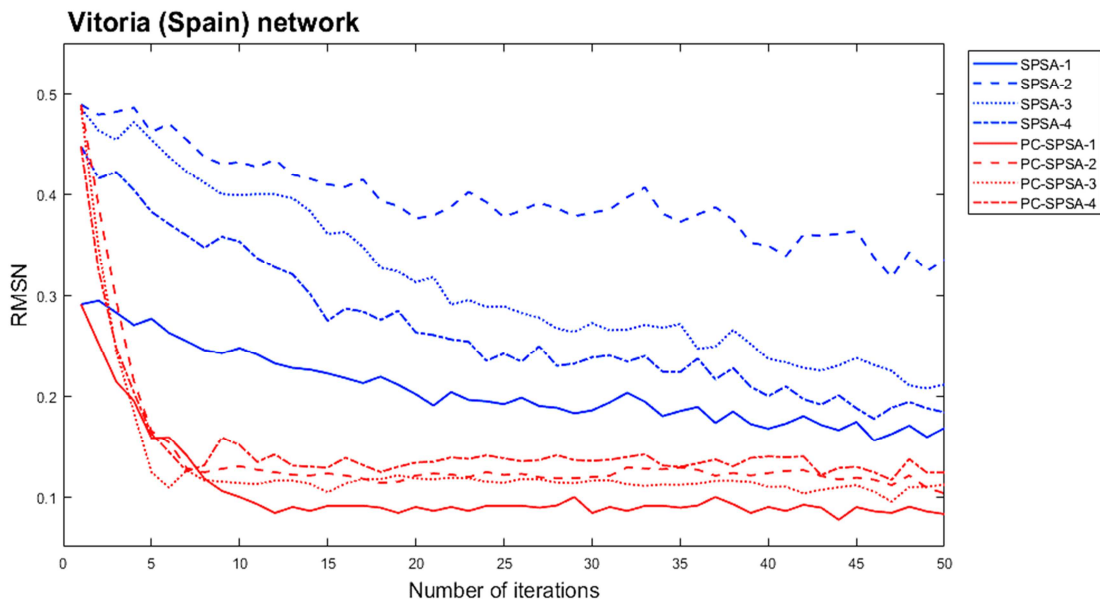

Source: Own elaborations.

References

- [1] Spall, J.C., 1992. Multivariate stochastic approximation using a simultaneous perturbation gradient approximation. *IEEE Trans. on Automatic Control* 37, 332–341.
- [2] Balakrishna, R., Antoniou, C., Ben-Akiva, M., Koutsopoulos, H.N., Wen, Y., 2007. Calibration of microscopic traffic simulation models: Methods and application. *Transportation Research Record: Journal of the Transportation Research Board* 1999, 198–207.

- [3] Lu, L., Xu, Y., Antoniou, C., Ben-Akiva, M., 2015. An enhanced SPSA algorithm for the calibration of dynamic traffic assignment models. *Transportation Research Part C: Emerging Technologies* 51, 149–166.
- [4] Antoniou, C., Azevedo, C.L., Lu, L., Pereira, F. and Ben-Akiva, M., 2015. W-SPSA in practice: Approximation of weight matrices and calibration of traffic simulation models. *Transportation Research Part C: Emerging Technologies*, 59, pp.129-146.
- [5] Tympakianaki, A., Koutsopoulos, H.N. and Jenelius, E., 2015. c-SPSA: Cluster-wise simultaneous perturbation stochastic approximation algorithm and its application to dynamic origin–destination matrix estimation. *Transportation Research Part C: Emerging Technologies*, 55, pp.231-245.
- [6] Cipriani, E., Florian, M., Mahut, M. and Nigro, M., 2011. A gradient approximation approach for adjusting temporal origin–destination matrices. *Transportation Research Part C: Emerging Technologies*, 19(2), pp.270-282.
- [7] Kostic, B., Gentile, G. and Antoniou, C., 2017, June. Techniques for improving the effectiveness of the SPSA algorithm in dynamic demand calibration. In *Models and Technologies for Intelligent Transportation Systems (MT-ITS), 2017 5th IEEE International Conference on* (pp. 368-373). IEEE.
- [8] Djukic, T., Van Lint, J. and Hoogendoorn, S., 2012. Application of principal component analysis to predict dynamic origin-destination matrices. *Transportation Research Record: Journal of the Transportation Research Board*, (2283), pp.81-89.
- [9] Prakash, A. A., Seshadri, R., Antoniou, C., Pereira, F. C., & Ben-Akiva, M. E. (2017). Reducing the Dimension of Online Calibration in Dynamic Traffic Assignment Systems. *Transportation Research Record: Journal of the Transportation Research Board*, (2667), 96-107.
- [10] Prakash, A. A., Seshadri, R., Antoniou, C., Pereira, F. C., & Ben-Akiva, M. E. (2018). Improving Scalability of Generic Online Calibration for Real-Time Dynamic Traffic Assignment Systems. *Transportation Research Record: Journal of the Transportation Research Board* (in press).

2.3.4 System optimal traffic management with vehicle connectivity and automation

A. BELOV^a, K. MATTAS^a, M. MAKRIDIS^a, B. CIUFFO^a

^a *European Commission Joint Research Center. Via E. Fermi 2749. 21027 – Ispra (VA)*

Many works in the last 50 years has been devoted to analyze network performance in terms of user equilibrium (UE) and system optimum (SO) assignment, but there is still no consensus about how to exploit the different approaches in the practice of traffic management. Most of the conclusions highlight the intrinsic difficulties to motivate drivers to follow routes based on the system optimum assignment. On the other hand, there are similar interdependence with distribution in time, i.e. UE leading to capacity drop and SO with tight scheduling to keep capacity at maximum level. The introduction of connected and automated vehicles (CAV) clearly offers the possibility to suggest routes and departure times able to achieve SO in both senses (allowing for example lower fares to vehicles accepting longer routes and/or later departure time, etc.).

In this context, the present work is devoted to investigate the features of traffic assignment and network loading approaches in the context of CAVs development. First, we analyze some basic aspects of SO traffic assignment with specific focus on the impact on network capacity especially in comparison with UE conditions. This is especially significant because, without tailored instructions, by only providing updated traffic information to CAVs, they are expected to load the network so that the final conditions will be closer to UE than what normal driver can achieve today. It is known that difference between UE and SO assignment appears mainly at medium to high traffic load and significantly decrease with exceeding of road capacity [1,2]. Thus, for generally desired maximum loading level (around 0.8-0.9) it is necessary to pay special attention to routing control.

The second part of the research focuses on the parameters for link and network performance estimation. Well known SO condition (namely equality of marginal cost) is indeed difficult to estimate because it requires a well-defined cost function. In the present work it has been experimentally proved by means of traffic simulation that state very close to SO assignment can be achieved by focusing on very simple metric of maximum of flow multiplied by speed (or divided by travel time) on all used routes. Such metric is found in some papers and is denoted as "efficiency", "kinetic energy" or as analogue of power in mechanical systems [e.g. 3]. We argue and show that maximization of this network performance estimation also corresponds to "minimal capacity" from 3-phase traffic theory (namely capacity with lowest flow breakdown probability) [4].

The final part of the current research focuses on the analysis of the use of the Macroscopic or Network Fundamental Diagram (MNDF) for traffic control algorithms. Literature shows that the MNDF-based access management approaches, usually using gating, are more efficient than traditional ones [e.g. 5]. However, MNDF-based gating have several strong drawbacks:

- it does not guarantee that all links operates in a most efficient way, except case with fully homogeneous conditions on every link which is not realistic;
- can cause unnecessary delays for flows near border of protected network;
- gating concept works well for "protected network" by regulation of inflow to that network, but it seems inappropriate when majority of flow going outside of this network (i.e. evening peak hour).
- In this light and taking into account modern trends in development of Cooperative Intelligent Transport Systems (C-ITS) and driving automation, it is concluded that MNDF-based approach is not the best option for future traffic management. With connectivity and automation, an aggregated approach becomes indeed obsolete. Thus, more precise link-based or even vehicle-based control is possible. To exploit

existing traffic networks better the concept of “traffic flow formation management” (TFFM) was recently proposed [6]. This concept becomes available with connectivity introduction and involves a set of control actions that aimed to ensure the most efficient flow propagation. In particular we propose a very simple approach to perform network traffic management. The main idea is to keep the parameter “flow/travel time” at maximum level on all links of the network by managing distribution on routes and access control. Such an approach, as it mentioned above, provides system optimal distribution on routes and with global maximization by access control it provides the best network performance, including lower probability of flow breakdown, which is not taken into account in approaches based on throughput maximization. Simulation modeling confirms efficiency of proposed approach (see Figure 5).

Figure 5. Toy network study

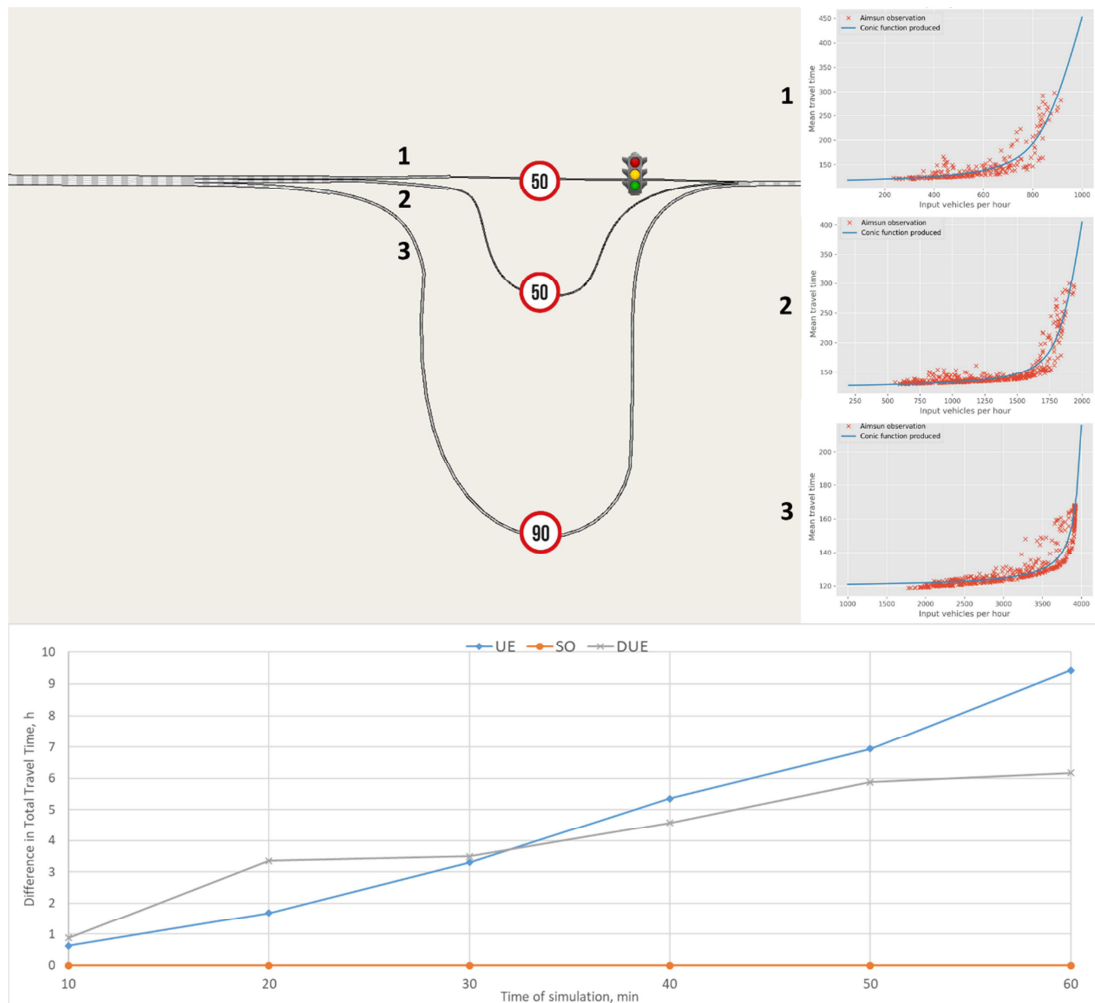

Source: Own elaborations.

References

- [1] Belov, A.V. Investigation of Braess’s paradox occurrence in transportation networks. Sbornik materialov 9-j mezhdunar. nauchno-tekhnich. konf. Belorusskij Nacionalnyj Tekhnicheskij Universitet [Proc. of the 9-th international conference. Byelorussian national technical university] Vol. 3. Minsk, pp. 141-142, 2011 (In Russian).
- [2] Leclercq, L., Geroliminis, N., Estimating MDFs in simple networks with route choice. Transport. Res. Part B: Methodol. 57, 468–484. 2013

- [3] Brilon, W. Traffic Flow Analysis beyond Traditional Methods. Proceedings of the 4th International Symposium on Highway Capacity, pp. 26-41, TRB Circular E-C018, Transportation Research Board, Washington D.C. 2000
- [4] Kerner, B.S. Optimum principle for a vehicular traffic network: minimum probability of congestion. *J. Phys. A: Math. Theor.* 44. 2011.
- [5] Keyvan-Ekbatani, M., Kouvelas, A., Papamichail, I., Papageorgiou, M., Exploiting the fundamental diagram of urban networks for feedback-based gating. *Transportation Research B*, 46(10), 1393-1403. 2012.
- [6] Belov, A.V. Improving of the road network efficiency by traffic flow formation management. Proceedings of 12th ITS European Congress, Strasbourg, France, 19-22 June 2017.

2.3.5 GPU-assisted resilience analysis of land transportation networks

L. GALBUSERA^a, G. GIANNOPOULOS^a

^a *European Commission, DG Joint Research Centre (JRC), Directorate E - Space, Security and Migration, Technology Innovation in Security Unit*

Resilience analysis of modern land transportation systems poses a multifold challenge [1]. On one side, the connectivity attributes of the network and presence of multi-modal infrastructures are key to determining friability and performance under perturbations. On the other side, emerging intelligent mobility systems and data sharing capabilities can enhance governance, facilitate traffic reconfiguration and adaptation, and ultimately promote a timely and more effective exploitation of the available resources after a shock has occurred.

As part of resilience assessment, scenario analysis under dynamically varying load intensities and spatial distributions can be computationally demanding [2,3]. This is particularly relevant when dense areas are considered and real-time decision making challenges traditional data ingestion and processing pipelines. Likewise, traffic data analysis comprises, more and more in time, aspects such as knowledge discovery, aggregation and semantic interpretation starting from multiple information sources and streams (e.g. sensors, media) [4].

In an effort to cope with some of these emerging aspects, transportation research is joining a number of other disciplines in the exploitation of *general-purpose computing on graphic processing units* (GPGPU). The capability to manage high data throughputs at affordable costs stands out as one the distinctive aspects of this trend. Modern GPUs offer advanced multi-threaded architectures, integration with established high-level programming languages and control over kernel concurrency. Such aspects allow mitigating some of the constraints that earlier-generation GPU computation posed to key transportation modelling routines [5].

Over the years, these features are allowing applications to different areas of traffic analysis, including simulation at different scales, traffic assignment, and traffic signal timing [6,7]. In many cases, considerable speedups are achieved over traditional CPU-based formulations. In addition, heterogeneous computing frameworks are being proposed, where the joint use of different processors contributes to high-efficiency solutions [8].

In this presentation, we will discuss the exploitation of GPU-based routines for resilience analysis of land transportation networks taking into account, in particular, perturbations affecting the number and distribution of available passageways over assigned connectivity configurations.

References

- [1] Ip, Wai Hung, and Dingwei Wang. "Resilience and friability of transportation networks: evaluation, analysis and optimization." *IEEE Systems Journal* 5.2 (2011): 189-198.
- [2] Ganin, Alexander A., et al. "Resilience and efficiency in transportation networks." *Science advances* 3.12 (2017): e1701079.
- [3] Osogami, Takayuki, et al. "Toward simulating entire cities with behavioral models of traffic." *IBM Journal of Research and Development* 57.5 (2013): 6-1.
- [4] Yan, Zhixian, et al. "Semantic trajectories: Mobility data computation and annotation." *ACM Transactions on Intelligent Systems and Technology (TIST)* 4.3 (2013): 49.
- [5] Strippgen, David, and Kai Nagel. "Multi-agent traffic simulation with CUDA." *High Performance Computing & Simulation, 2009. HPCS'09. International Conference on. IEEE, 2009.*

- [6] Perumalla, Kalyan S., et al. "GPU-based real-time execution of vehicular mobility models in large-scale road network scenarios." Proceedings of the 2009 ACM/IEEE/SCS 23rd Workshop on Principles of Advanced and Distributed Simulation. IEEE Computer Society, 2009.
- [7] Shen, Zhen, Kai Wang, and Fenghua Zhu. "Agent-based traffic simulation and traffic signal timing optimization with GPU." Intelligent transportation systems (itsc), 2011 14th international ieee conference on. IEEE, 2011.
- [8] Song, Xiao, et al. "Supporting real-world network-oriented mesoscopic traffic simulation on GPU." Simulation Modelling Practice and Theory 74 (2017): 46-63.

2.3.6 On efficiency and resilience of connected transportation networks

G. COMO^{a,b}

^a *Department of Mathematical Sciences "G.L. Lagrange", Politecnico di Torino, corso Duca degli Abruzzi 24, 10129, Torino, Italy,*

^b *Department of Automatic Control, Lund University, BOX 118, 22100, Lund, Sweden*

Fast-spreading vehicle connectivity and automation technologies are revolutionizing the transportation system, opening up new opportunities for efficient traffic management. At the same time, by increasing the complexity and interconnectedness of the transportation network, this technology may also make it more fragile to perturbations that can be spread and amplified by cascading mechanisms. In this talk, efficiency and resilience of dynamical transportation networks will be studied in two scenarios. First, we will present novel, provably stable, decentralized feedback traffic light control policies with variable cycle length. The proposed control strategies have quite a simple architecture, they are fully decentralized and do not require any information about the network structure or the turning rates. Yet, we will show these policies can provably achieve global objectives such as maximal throughput and resilience. We will both present tools for the theoretical analysis [1] and microsimulations validating the model [2]. Second, we will present a multi-scale model of dynamical transportation networks in which the dynamics of the traffic flows are intertwined with those of the drivers' route choices and the latter are constantly updated in response to information the congestion status of the whole network as well as decentralized influence mechanisms. Our main result shows that decentralized routing influence mechanisms allow the system planner to globally stabilise the transportation network around the social optimum traffic assignment [4]. This extends our previous results on stability of Wardrop equilibria [3] and is particularly remarkable as such mechanisms do not require any global information about the network structure or state and can be computed in a fully local way. This is joint work with Gustav Nilsson at Lund University and Rosario Maffiolo at Politecnico di Torino.

References

- [1] G. Nilsson and G. Como. On generalized proportional allocation policies for traffic signal control. Proceedings of the 20th IFAC World Congress, Toulouse (France), July 9-14, 2017, pp. 10053-10058.
- [2] G. Nilsson and G. Como. Evaluation of Decentralized Feedback Traffic Light Control with Dynamic Cycle Length. Proceedings of the 15th IFAC Workshop on Control of Transportation Systems (CTS2018), Savona (Italy), June 6-8, 2018.
- [3] G. Como, K. Savla, D. Acemoglu, M.A. Dahleh, and E. Frazzoli, Stability analysis of transportation networks with multiscale driver decisions, *SIAM Journal on Control and Optimization*, vol. 51 (3), pp.230-252, 2013.
- [4] R. Maffiolo and G. Como, Stability and optimality of multi-scale transportation networks with distributed dynamic tolls, preprint, 2018. Available at <http://arxiv.org/abs/1803.07959>

2.4 Parallel Session 1b - Projects and case-studies

2.4.1 Enhanced Traffic Management with Cooperative Intelligent Transport Systems – an example from Bordeaux Pilot Site

E. MONCEYRON^a, E. FRANCIERIES^b, A. PERPEY^c

^a Bordeaux Métropole, France

^b Gertrude SAEM, France

^c NeoGLS, France

The metropolis of Bordeaux stands out by its strong population growth and aims for tomorrow to rank among the main urban centres in Europe. The city has succeeded in reinventing itself, and continues to pursue with major projects to boost its new-found attractiveness. But the need for mobility is regularly increasing and even appealing systems and models will never catch up the ever growing need for transport in a dynamic city. So Bordeaux Métropole is hard at work to take up tomorrow's major challenges such as in mobility.

The Bordeaux region has been committed for many years to global solutions in order to manage traffic and travel flows in the city. Bordeaux was a precursor in the 1980s with the centralised Gertrude (⁹) system, which is part of the category of Real Time Adaptive ITS. Capable of combining all types of data (Traffic, Public Transport, Soft modes, Pollution, Parking, Weather, Incidents, and Collaborative) and integrate them into its real-time decision making, the system provides a plurality of strategies to the policies service. Since 1995, Bordeaux Metropole has consolidated its action with an ambitious policy to develop efficient public transport networks by launching a tram service in several phases, beginning in 2003, but continuing tomorrow with high service-level buses (BHNS) and multimodal offer. More recently, the Gertrude system has taken account of prioritized, exclusive right of way public transport and priority bus lines, with strategies adapted to real traffic conditions and significant gains in terms of travel time.

Having rolled a transport offering that is suited to the development of a European metropole and to make our metropolitan area more attractive, we must provide today easily-accessible, smoother-running, seamless, smarter mobility, including digital mobility. This ambition implies restricting the use of cars in the city centre, pushing ahead with the development of urban transport of the highest standard and rethinking the way we move around the city to make sure that this mobility is sustainable.

Indeed, while the positive effects of this new public transport multimodal network are now plain to see particularly within the urban core, we have observed at the same time, a noticeable increase in the use of cars, outside the ring road and partly correlated with demographic growth and urban sprawling. Rush hour traffic congestion remains unabated in spite of a lot of efforts of public transport authorities. And one of our current aims is to develop technological innovations simultaneously with innovations in usage, and to exploit the potential of the digital revolution fully to harness intelligence at the service of demand among citizens for sustainable mobility, and thus foster support for behavioural changes.

Bordeaux Metropole has put its subsidiary Gertrude Saem permanently in charge of optimizing and developing the multimodal regulation platform. It derives its capacity for innovation from its ongoing long-term commitment to responsible urban mobility via the following non-exhaustive approaches:

- A data exchange programme with the "connected world" and generation of eco-driving recommendations based on interactive and collaborative processes;

(⁹) GERTRUDE integrated real-time platform (Real-Time Electronic Management of Regulation for Town Planning, Travel and the Environment) developed by Gertrude SAEM a subsidiary of Bordeaux Metropole.

- Identifying/locating special vehicles (emergency vehicles, ...) and prioritizing their movements;
- Preparation of management models for green transport routes and "carbon scoring"/regulation of flows.

We are in particular involved in the 'C-The Difference' pilot project ⁽¹⁰⁾ funded by EC ⁽¹¹⁾ (2016-2018), which is able to experiment **C-ITS** (**C**ooperative-**I**ntelligent **T**ransport **S**ystems) services to help us increase security, fluidify traffic and reduce its impact while facilitating modal shift. This project has been elaborated on the basis of a shared vision developed and adopted by the consortium partners ⁽¹²⁾ representing demand and supply sides who have been committed for the last 10 years to bring C-ITS to the market through intensive efforts and long lasting investments in the development and deployment of C-ITS services. This group of pioneers are strong believers in the capacity of C-ITS services to bring efficient and cost-effective solutions to address urban mobility problems with respect specially to manage the traffic in an innovative way.

Within the 'C-The Difference' pilot, we provide a traffic Android app allowing driver to adapt his behaviour depending on the infrastructures and the different road events that might occur. The driver is able to get the information about the traffic or road events around him in real time during his daily commute.

The most successful service today is GLOSA (Green Light Optimal Speed Advisory), experienced since mid-2017 on all of the main roads of the agglomeration regulated by traffic lights (more than 500 intersections activated to date, 2000 traffic lights). It is to give to driver advices permitting to optimize their approach to a traffic light. The speed advice is delivered by the app that runs on the nomadic device on board (e.g. smartphone). The speed is calculated from RT raw data provided by the Gertrude TMS. Expected benefits are a smoother driving behavior while driving through one or more consecutive traffic intersections, with less stops, reducing emissions and increasing safety.

C-The Difference pilot project aims also at delivering an integrated impact assessment of C-ITS services enabled by up to 18 months' operation of mature C-ITS services with private and professional users in an extended urban environment taking advantage of the use of hybrid communications (ITS G5 and 3G/4G) and large fleets of vehicles from different categories (over 40 ITS G5 OBU equipped vehicles and over 1000 app downloads).

As C-ITS enable road users and traffic managers to exchange information in real time and use them to coordinate, connected vehicles provide Probe Vehicle Data (PVD) or Floating Car Data (FCD) services. These data can be exploited in both off-line and real-time to optimize traffic management. In the first case, they make it possible to improve traffic studies through a better knowledge of the users' behavior. In the second case, they complete the knowledge of traffic state and facilitate strategies for anticipating congestion peak. They can also make it possible to optimize investment budgets (equipment) and to facilitate the coordination of multiple operators. Managing traffic in urban areas is indeed also complex, multi-layered and a multi-functional process generally involving a range of diverse agencies.

Using data from tracer vehicles or drivers equipped with GPS (e.g. smartphone) is an alternative to replace or supplement information collected by conventional detection devices. Floating Car Data (FCD) are recorded in on-board electronic systems that collect information from sensors (location, speed, acceleration, direction of movement, etc.). These data are geolocated and retrieved anonymously and at regular intervals from these tracer vehicles. Through the current experimentation, Gertrude Saem is convinced that it

⁽¹⁰⁾ <http://c-thedifference.eu>

⁽¹¹⁾ Funding EC DG MOVE – tender MOVE/C3/2015-544 Pilot project « Beyond traffic jams: intelligent integrated transport solutions for road infrastructure »

⁽¹²⁾ Bordeaux Metropole, Gemeente Helmond, Blerwaque SPRL, MAP Traffic Management, Neo GLS, Dynniq, TNO, Cerema, IFSTTAR

is indeed possible to use FCD as a complement, or partially as a replacement for a conventional sensor, in order to regulate real-time traffic lights intersections.

Figure 6. Integration of FCD and already existing traffic data within TMS decision and control chain

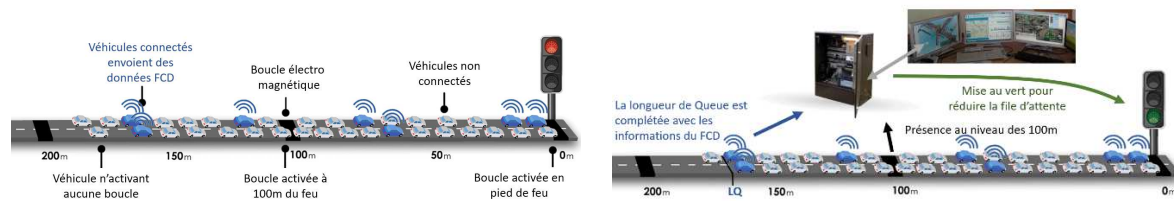

Source: Own elaborations.

References

- [1] « C-ITS Platform Phase2: Cooperative Intelligent Transport Systems towards Cooperative, Connected and Automated Mobility », final report, EC, September 2017.
- [2] « C-ITS Platform: Cooperative Intelligent Transport Systems », final report, EC, DG Move, January 2016.
- [3] « C-The Difference Pilot - Beyond Traffic Jams », Intermediate Study Report, Consortium, June 2017.
- [4] « CIMEC Cooperative ITS for Mobility in European Cities, ITS in European Cities: the CIMEC project / experience and recommendations », Consortium, EC, May 2017.

2.4.2 SHERPA-city, a web tool to evaluate the impact of traffic management schemes at urban level

B. DEGRAEUWE^a, E. PISONI^a, P. THUNIS^a

^a Directorate for Energy, Transport and Climate, Joint Research Centre, Ispra, Italy

Urban traffic schemes / policies can be used to improve mobility at city level. At the same time, a side effect of these schemes is on air quality, which can be improved or worsened depending on the resulting change in mobility (Is there an increased mobility demand due to the policy, so that this worsen air quality? The current demand has been optimized so that less emissions occur in the atmosphere?). As urban air quality is still an issue in Europe (more than 80% of urban population is still exposed to too high level of pollution [1]) there is the need to evaluate the impact of such urban traffic schemes, to maximize air quality benefit and reduce possible drawbacks.

This paper presents SHERPA-city, a user-friendly web tool with the aim to evaluate the impact of mobility schemes (i.e. low emission zones) on air quality. This is implemented following various steps.

- First the user selects an urban area of roughly 10 by 10 km, to be considered for the subsequent analysis. Default traffic flow data are provided from OpenTransportMap (www.openstransportmap.info), but if the user has more precise traffic data it is possible to update the default data. To calculate emissions on each road, vehicle fleet composition and emission factors are needed. A baseline fleet and some typical fleets are available in the tool, but the user (also in this case) can define a new fleet including vehicle categories of choice.
- Next, the user defines areas where measures will be taken as LEZ, new infrastructure or traffic calming measures. Specifically for diesel NOX emissions, the emission factors are updated with the latest "post-dieselgate" measurements.
- To link local emissions to concentrations, "dispersion kernels" are used. A dispersion kernel is the annual average concentration due to a unit emission source, calculated beforehand with a Gaussian dispersion model. The shape of the dispersion kernel depends on the local meteorology. The same emission source causes higher concentrations when the average wind speed is lower. Therefore a collection of kernels is provided covering the whole of Europe. Figure 1 illustrates that there are big differences across Europe. The concentrations for a scenario are obtained by scaling and summing the dispersion kernel over the study area at a resolution of 20 m. In this way information about episodes is lost but the calculation time is around 1 minute.

Figure 7. Maximum concentration ($\mu\text{g}/\text{m}^3$) around a point source of 1 kg/h, at a resolution of 28x28km

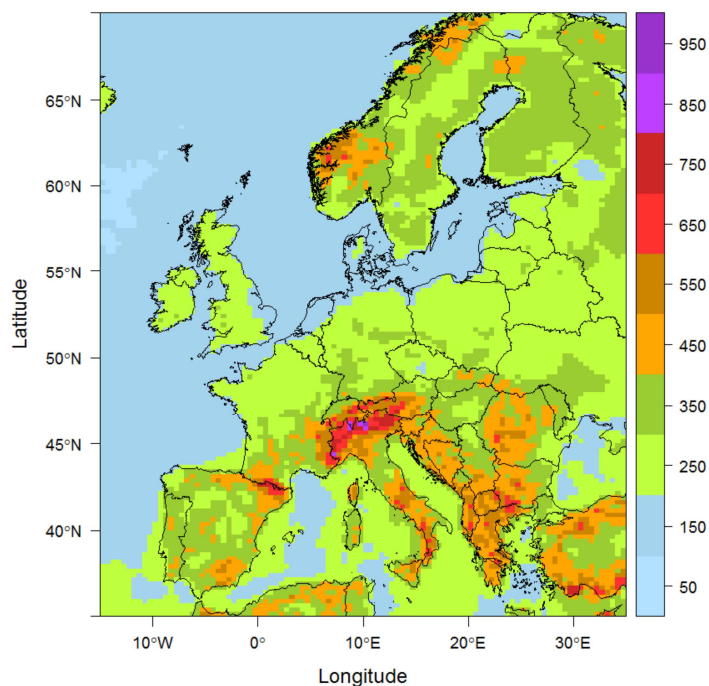

Source: Own elaborations.

- Finally, SHERPA-city only provides the contribution of the local traffic emissions to concentrations. To know the total concentration, information about the background concentration is needed. The SHERPA model [2], a source receptor model at European scale with a resolution of 7x7km provides this information. The combination of SHERPA and SHERPA-city allows local authorities to design air quality plans from the regional to the local scale.

Access to the SHERPA-city web tool can be requested to the authors.

References

- [1] EEA 2017, Air Quality in Europe. EEA Report No 13/2017.
- [2] A. Clappier, E. Pisoni, P. Thunis, 2017. A new approach to design source-receptor relationships for air quality modelling, *Environmental Modelling & Software*, 74, 66-74.

2.4.3 Motorway-to-Motorway Metering

I. CORNWELL^a

^a Mott MacDonald

Motorway-to-Motorway (M2M) intersections frequently experience flow breakdown at times of peak demand. Studies [1] have shown potential benefit in dynamic traffic control at motorway merges, to balance the demand and storage on the link roads with the demand and capacity of the main carriageway.

This paper describes the design and operation of a pilot motorway-to-motorway control system on the English motorways, which commenced live operation in January 2018. The system incorporates new and extended traffic control algorithms [2] which provide coordination between two link roads and the main carriageway. The control measures are link road metering using red/amber/green traffic signals, and variable mandatory speed limits on the main carriageway. The new control algorithms include a self-calibrating release algorithm, an extension of the ALINEA ramp metering algorithm, a variant of the HERO queue balancing algorithm, and an algorithm to coordinate the main carriageway speed control.

Through carefully partitioned software architecture, a single production code implementation of the algorithms is used in microsimulation modelling as well as the roadside control system. The modelling forecast that the M2M control system would produce savings in total journey times by utilising the capacity of the link roads to reduce congestion on the target motorway.

Early indications from live operation and the data available to date are that overall congestion reduction is being achieved. Further independent analysis is being undertaken with results due late 2018.

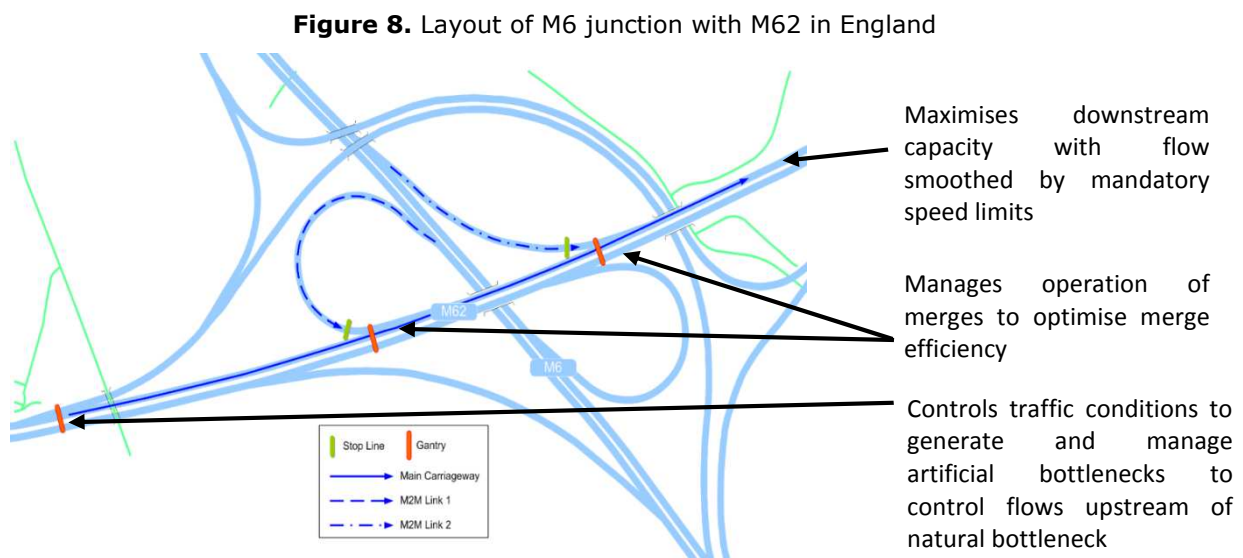

Source: Own elaborations.

References

- [1] R. Higginson, J. Hayden, S. Ubhi, J. Castle, "Motorway-to-motorway: a potential technological solution to motorway congestion", 18th World Congress on ITS, Orlando, 2011.
- [2] I. Cornwell, M. Sanca, R. Meekums, A. Withington, "Motorway-to-motorway metering: control algorithms and modelled evaluation", accepted for publication in 25th World Congress on ITS, Copenhagen, 2018.

2.4.4 MEL Ecobonus-Mobility: A Smartcity project based on « In Vivo » evaluation concept

S. MELENNEC^a, P. PALMIER^a, D. GIL^b, C. DEPIÈRE^c

^a *Cerema, France*

^b *VNF, France*

^c *European Metropolis of Lille, France*

Traffic jam at peak hours is a big challenge to face up for many metropolitan areas. It threatens their economical attractiveness with consequences on pollution and residents quality of life. As a solution, in Lille France as everywhere, motorways manager develops several efficient network dynamic regulations (ramp metering, dynamic speed limitations, user information, truck overtaking ban) checked by a traffic management center. In order to increase their effects and definitely make them a success the European Metropolis of Lille (MEL) which isn't the network manager but a local area authority, decided to deal with motorways transportation demand. The MEL project derives from "Spits Mijden" Rotterdam policy. The Ecobonus Mobility aims to generate sustainable changes of behaviour with the "nudge" of a positive toll. Simply it's a gamification project: You change your "routines" you're rewarded.

The European Metropolis of Lille (MEL) has chosen CEREMA to design an Ecobonus-Mobility project. MEL transportation and roads departments National, and local authorities, motorways manager, environmental agency take part in the project crew.

Firstable the crew has to get along with the regulatory context which is quite different between Netherlands and France. New technologies (for instance LAPI - automatic number plate reading - cameras, or on board unit) allow to collect much data about traffic and vehicles or drivers practices. The financial balance and the success of the project requires the observation of an unbiased initial situation. But what is legally permitted? There is no one-way answer. Behind a principle: no massive collect without people agreement, exemptions for traffic management could exist. Is it a proportionate use in view of MEL aim? How to organize data security?

Another vigilance point highlighted by the project crew: an anticipation of the peak hours. What does it mean? Gamers who play MEL Ecobonus Mobility project have to respect rules: Not to drive on motorways and cross a border around town centre between 7 am and 9 am. Each week day, they're free to play or not with depending on the best solution of that day: using public transport, car-sharing, teleworking, anticipating or shifting their trip. Motorways network manager warns the crew about the last alternative: the project mustn't advance traffic jam before 7 o'clock. That's why after the legally context about data collection, "in vivo" evaluation and smartcity concept are 2 pillars more of the project.

Concepts of "prioriori" or "posterioriori" evaluation are not appropriate to face up the risk of an anticipation of peak hours. This failure is not sure but it could break project credibility and people support which is essential to its success. So evaluation has to be the core system of the project which allows authorities to set up a common risk management policy. Of course the project crew made a functional FMECA (Failure Mode, Effects and Criticality Analysis) and a presentation to a "candid or ingenuous" will be organised in order to consolidate the whole system as it could be made in an "AlquemyLab" (with "qu", to refer to quality tools). No matter. To ensure project success the usually used Deming Wheel method: Plan, Do, Check, Act or Adjust successive steps was replaced by a new system moved by evaluation. Data collection, data sharing, analysis and management drive the project. As soon as an unwanted effect is detected by a partner during project life other gearings wherein take part enrolment, community gamers animation, rules, bonus rewards ... can be mobilised to adjust gamers behaviours.

What about MEL Ecobonus-Mobility as a Smartcity project? Ecobonus-Mobility is an optimization project. It aims to decrease - not eradicate - traffic jam at peak hours in

order to preserve area accessibility and competitiveness, to fight against pollution and to keep drivers serenity. The project is thought to serve people without discrimination. Those who play by rewarding them, those who don't play by decreasing traffic jam. It's a crowd project based on community effect. It needs active members to succeed. Indeed a new gearing appears on figure 34: Advertise. A positive buzz is the key of the project success. Drivers / gamers aren't people who respect a policy decided by the top but people who act to make the project a success story. Authorities needs to train and renew a motivated panel. Fitted out with an on board unit for their cars gamers accept to share their useful data -only - and alternatives to peak hours car with the ocean of data provided by all the area authorities: motorways network manager, public transport authorities, air quality supervision ... Gamers have the right to wait each day for day-context-adapted solutions based on weather, public transport occupancy rate ... Data collection, analysis and management are essential to the technical and economic viability of the project. It combines several centralised and organised traffic management systems of networks operators with data, feelings and media of a social community: the gamers. Interoperability, transparency, confidence are project keywords. Furthermore Ecobonus-Mobility is a cheap idea. Rotterdam experience returns a good social benefit. Minutes earned really balance investment cost.

Figure 9. MEL Ecobonus-Mobility System



Source: Own elaborations.

The project has to be robust easily adaptable and compatible with inevitable technological (and regulatory) changes. A systemic and modular approach was used to co-design the project into independent technical processes in order to promote not the solution by one area institutional actor but each new day Mobility as a Service for all drivers who join the project.

2.4.5 SOCRATES 2.0 – vision on paving the way for the future traffic management in Europe

I. KOLLER-MATSCHKE^a, A. DE KORT^b

^a *BMW Group, Mobility Technologies*

^b *Ministry of Infrastructure and the Environment, The Netherlands*

About SOCRATES 2.0

Online and in-car services have more and more influence on the trip, route and speed choices of road users. In this sense service providers have a growing influence on traffic behaviour. With selfdriving cars it will become even stronger for the involved car industries. Therefore, service providers and car industries play more and more an active part in traffic management.

To make traffic smoother, safer and more sustainable, a close cooperation between traffic centres, service providers, car industries and the road user itself has to be established. Need for a paradigm shift in the road transport system: Future traffic management has to be based on new cooperation frameworks and new/ extended services for the road users. That means a shift from the today's step by step traffic management process chain towards an interactive traffic management loop including all stakeholders, also the road user.

Many projects and platforms are dealing with various aspects of improving the road transport system on a strategic level (e.g. C-Roads Platform, C-ITS Platform, Lena4ITS) as well as on an operational level (e.g. C-Roads projects, CIC Corridor, Crocodile, DATEX II). However, one of the key elements of enabling tomorrows road transport system is to overcome the limitations of todays traffic management services as addressed in the TM2.0 platform: The integration of traffic management in mobile/in-car services, the use of crowd sourced data in traffic management and a well-structured cooperation (strategic, tactic and operational) of road authorities, service providers and car industries. The EU funded project SOCRATES 2.0 (= System of Coordinated Roadside and Automotive Services for Traffic Efficiency and Safety) incorporates and re-uses the knowledge and experiences of these ITS projects. SOCRATES 2.0 will be the deployment pilot for the TM 2.0 studies, where the ideas are tested in a large scale, real life environment

SOCRATES 2.0 paves the way for the next generation of traffic management in Europe, where public and private parties work together to provide optimal routes (faster, safer, cleaner) for the individual drivers, while securing also the collective interests via mobile/in-car and road-side services and via future self-driving vehicles. The goal of SOCRATES2.0 is to enable interactive and effective services on traffic management and traffic information. Services will be generated together by road authorities, service providers and BMW. Four pilot projects will be organised, involving thousands of users testing new and extended mobile/in-car services based on interactive traffic management addressing the following four use cases: Smart routing, actual speed and lane advice, local information and hazardous warning, improved roadside traffic management measures. The pilots are located in the regions of Amsterdam, Copenhagen, Munich and Antwerp and include motorways, regional roads, urban-interurban interfaces and urban roads. It is expected to lead to more business opportunities for the private partners, a more cost-effective traffic management for the public authorities and better service for the road users. The project started in September 2017 and will take three years.

Shared vision on an optimal framework of cooperation

The goal of SOCRATES 2.0 is to develop an optimal framework of cooperation between the public and private partners, as a basis for a European deployment of interactive traffic management. Strong partners are involved in SOCRATES 2.0. As road authorities there are Rijkswaterstaat, NDW (National Data Warehouse - The Netherlands), City of Amsterdam, Prov. Noord Holland, BAST (German Federal Highway Research Institute),

Vlaanderen (Flemish Region in Belgium), Vervoerregio Amsterdam; as market participants: TomTom, HERE, BrandMKRS, Be-Mobile, BMW, Technolution, MAPtm; and as associated partners: City of Copenhagen, Bavarian Road Administration, Drive Sweden, Vialis, Dynniq Nederland BV.

As a joint starting point for the project, the partners of Socrates assembled a shared vision on interactive traffic management. Elaborating on the principles of TM2.0, this shared vision identifies the individual and joint motivations, interests and expectations regarding:

- participating in SOCRATES 2.0;
- the road users (the end-users);
- the organisations involved (road authorities, intermediaries, service providers and car industry);
- developments in technology, in particular data, roadside systems and in-car services;
- relationships between the organisations involved and conditions for optimal cooperation.

The partners wanted to establish something new and not just improving any existing concept. To do so, they recognized that the idea of influencing traffic has to be transformed into supporting people travelling from A to B. As a result, the vision does not just focus on technology or the traffic management process but is elaborated along four dimensions: CUSTOMER, COMMUNITY, TECHNOLOGY and COLLABORATION.

Figure 10. The four dimensions of SOCRATES 2.0, their slogans and interactions

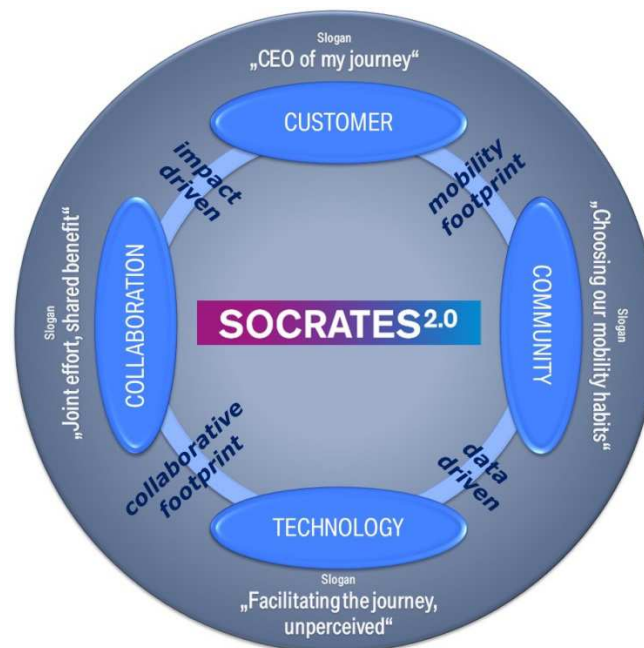

Source: Own elaborations.

Transferring the shared vision to a common SOCRATES 2.0 mission, each dimension was elaborated separately by addressing the following points:

- For each dimension it was made explicit *why* the partners support these joint objectives.
- For each dimension the *key questions* to be answered by the pilots were identified.
- Implying *main ideas* (what) and underlying leading *principles* (how).

Figure 11. Elaboration of the four dimensions of SOCRATES 2.0

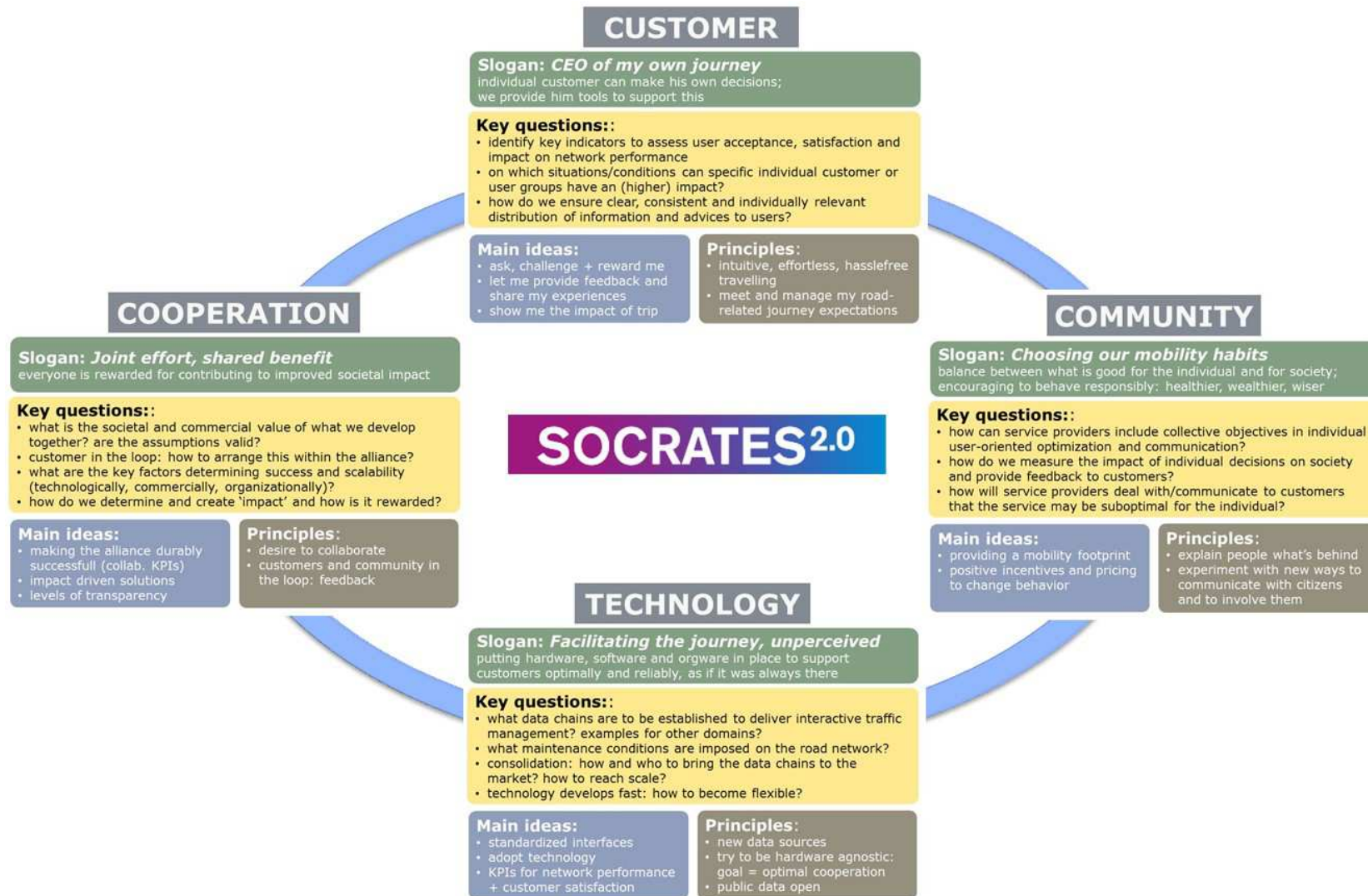

Source: Own elaborations.

Ongoing work: Tactical and operational levels of SOCRATES 2.0

The shared vision provided the main objectives, key research questions and leading principles on a strategic level. The vision gives guidance to define use cases and the scope of tests to be performed at the various pilot sites. The paradigm shift is needed to achieve real and successful interaction between customers, private and public organisations in mobility. As such – referring to the title – it really paves the way to future interactive traffic management.

To bring the new to the pilots in the ongoing deployment work, it is productive to have the elaborated statements as the agreed base:

- Active involvement of the customer and the communities (pre-trip, on-trip and post-trip)!
- Move from managing traffic to managing individuals!

Having these statements in mind, special focus is lead on intermediaries and strategies by describing actors, process dealing and variations of implementation in different use cases.

2.4.6 EU ITS Platform on Future Motorway Traffic: Strategic Dialogue, Guidance, Operational Excellence

T. GEIBLER^a, T. REIFF^a, J. DIERKE^a

^a *Federal Highway Research Institute (BAST), Bergisch Gladbach, Germany*

The face of Traffic Management will substantially change in the coming decade in support of truly cooperative services for road users and travellers. This step change will be driven by technological progress but has to be strongly underpinned by a common understanding and mutual agreement of the roles of different actors. On European level, the C-ITS Platform has strongly contributed to establishing this common vision and to identifying the necessary implementation steps. One of them is the large scale piloting of the collaboration between road operators and service providers as it is for example conceptualised in the TM 2.0 platform and piloted in the SOCRATES 2.0 action.

Being in its core a platform of road authorities and road operators collaborating for harmonised core European ITS services, the European ITS Platform (EU EIP) fulfils a pivotal role as ITS knowledge management centre. While some of the platform activities are devoted to develop and maintain harmonisation tools (e.g. quality framework for ITS services, National Access Points), the activity on monitoring and dissemination ties together the relevant developments across European ITS corridors (e.g. URSA MAJOR, crocodile, Arc Atlantique, MedTIS, NEXT-ITS) and special domains. Moreover, it takes also into account the collaboration dimension on Day One C-ITS services with C-Roads and the strategic exchange with key stakeholders. The guiding star behind the work of the activity on monitoring and dissemination is represented in Figure 12 below.

Figure 12. EU EIP activity on monitoring and dissemination

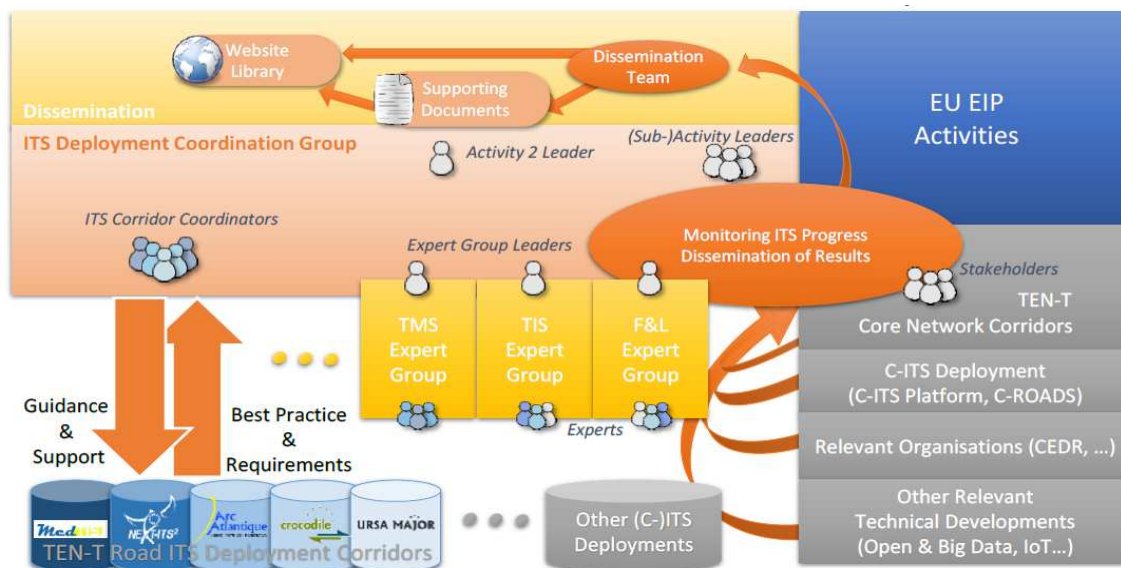

Source: Own elaborations.

The activities on monitoring and dissemination can be grouped as follows:

- Entering and maintaining a strategic dialogue with key stakeholder about further directions of traffic management and information services,
- Providing Guidance and support for (mostly corridor-based) deployment of core European ITS services,
- Disseminating operational excellence enabled by collection of best practises.

The strategic dialogue is facilitated mostly via presence and discussion at ITS European/World Congresses, participation in TEN-T days and targeted workshops. On the

example of the EU EIP Influencer Workshop in December 2017, three guiding questions have been discussed with a targeted cross-sector audience reaching out to automotive industry and ITS suppliers, integrators and service providers, road authorities and operators (incl. European umbrella organisations):

- What are your expectations regarding future road operator investment in ITS? How much continuity is needed and how much innovation is possible?
- Which technologies are sufficiently mature by now for real operational roll-out beyond the pilot stage, and how would such new services integrate and interact with existing systems and services?
- What models of cooperation – especially with road operators – do you propose for the changing landscape of road transport?

A summary report from the workshop, putting strong emphasis on the need for close cooperation, is available at the website www.its-platform.eu. Higher levels of cooperation and benefit can only be achieved when all relevant parties start negotiations and create governance schemes of mutual benefit, taking the entire chain from planning to operation together. The road operators have to 'de-silo' their approaches.

The guidance element roots in the set of Deployment Guidelines in support an efficient and harmonized implementation of future ITS. There are 19 existing Deployment Guidelines which focus on specific topics for example dynamic lane management, Co-Modal Traveller Information Services and intelligent and secure truck parking. The experience gained out of the deployed ITS across Europe are used to update the ITS Deployment Guidelines. It is planned to consolidate the set of guidelines and to provide a reference handbook which contains all relevant information to facilitate efficient harmonised ITS deployment across Europe. EU EIP collaborates with C-Roads in order to ensure that the reference handbook will be future-proof for the generation of Cooperative ITS services.

In order to intensify the collaboration with the ITS deployment corridors, corridors and EU EIP have recently formed a cross corridor coordination layer. This layer is intended to carry forward topics of mutual interest for several corridors and the platform.

In support of operational excellence, the activity has launched thematic expert groups to gather experts from all EU EIP partners, ITS corridors, road operators and beyond collaborate to improve existing systems and develop new fields of ITS applications. The expert groups support the deployment of ITS with main focus on traffic management, freight and logistics and traveller information services. The experts collect best practices and lessons learned.

In summary, the activity on monitoring and dissemination works in close cooperation with all EU EIP activities, corridors and key stakeholders to make the best use of a place to improve mutual impact and orchestration of the specific results and their influence on ITS Deployment in the future.

2.5 Parallel Session 2a - Collective Services

2.5.1 Frequent travel clustering algorithm for public transport planning

N. S. HADJIDIMITRIOU^a, M. IORI^a, R. KRAMER^a, M. MAMEI^a

^a *University of Modena and Reggio Emilia*

Among the main objectives of the European Commission, the reduction of congestion and emissions due to transport, remains a priority. The main strategy consists in the increase of the transport system efficiency and in the introduction of low emissions alternatives (EC, 2018). In large cities, the public transport network is usually well developed and high frequencies services can be offered to the citizens. The problem of congestion can be hardly solved in small and medium size cities. In Italy, for instance, most of the medium size cities are mainly monocentric, "having a center tending to sprawl in the periphery" [1]. Those cities are characterized by the extended use of private cars and by few public transport alternatives. Policy makers have, therefore, to deal with high motorization rate per capita (i.e. in Italy, 608 vehicles per 1000 inhabitant in 2016 according to Automobile Club Italy, Aci and National Institute for Statistics, Istat). In this context, the identification of the main traffic flows is fundamental when the objective is to plan the introduction of public services based on the demand for transport. GPS coordinates can become the main source of information to determine the behaviour of frequent travellers.

One of the main task to convert a set of GPS traces into actionable information is to identify and cluster the origins and destinations of those traces in order to identify possible locations for the stations and stops of public transportation systems.

The literature presents several works aimed at clustering origins and destinations of positioning data. The grid based clustering algorithms, for instance, have the capability to process large dataset of GPS coordinates. Qinpei et al. (2015) [2], for instance, propose a spatial clustering algorithm that is based on grid structure to identify patterns of users with complexity $O(N \log N)$. Similarly, Cao et al. (2009) [3] develop a grid based clustering algorithm to discover frequent trips based on GPS coordinates. They prove the effectiveness of the algorithm on a real dataset of a hundred of thousand tracks. Other approaches are focused on the reduction of the dataset dimension. Kumar et al (2016) [4], for instance, use a sampling scheme to reduce the 10 million taxi GPS origin and destination and implement a DBSCAN algorithm to determine the mobility patterns. Finally, Chen et al. (2017)[5] deployed the K-means algorithm to cluster 800.000 vehicles trips detected based on the license plate recognition and analyse the characteristics of the trips within each cluster.

In this work we adopt the p-center approach to classify similar travel patterns and use this information as a reference to propose bus lines that could be easily reached by the drivers. The p-center problem (PCP) is a classical combinatorial optimization problem that consists in selecting p points (centers) among a finite set of candidates centers and assigning a set of clients to them, with the aim of minimizing the dissimilarity of the worst assignment.

In this application, the candidate set of centers and the set of clients are the same travel paths. This set, denoted by N , is formed by arcs (i.e. origins and destinations) representing travel paths. The dissimilarity between two arcs is defined as the sum of the Haversine distances between their origins and their destinations.

To solve the problem, the binary search (BS) algorithm as proposed by Daskin (1995) [6] is implemented. The input of this algorithm are: the number of clusters to be created (K), the set of paths (N) and the dissimilarity matrix between each pair of paths. The BS algorithm solves a set covering problem at each iteration, and returns the optimal p centers (clusters) with a certain number of paths at the end of the search.

The algorithm is tested on real data of drivers from a medium size Italian city. The position of 125 drivers were registered during one year and a half in the context of a European Union project called Telefot. About 150 thousand travel-paths have been registered (only paths greater than 1km were considered). The algorithm aggregates pair of paths having the distances between their origins and their destinations lower than a parameter δ , and replaces them with a single path having its origin in the center of gravity. The parameter δ is set to 500m, and the computational experiments are performed with different values of K (5, 10, 20, 30, 40, 50, and 100). The results consist of clusters of coordinates of origin and destination. Each of the cluster has a path at the center of gravity which may correspond to the proposed public transport service. The origin and destination of the central path can be reached from the origin or destination of any other path included in the cluster by walking no more than Z kilometers.

This approach can provide guidelines to optimize the location of novel stations and stops of the public transportation service.

References

- [1] Ciro Gardi, *Urban Expansion, Land Cover and Soil Ecosystem Services*, Taylor & Francis Ltd, 2017.
- [2] Qinpei Zhao, Yang Shi, Qin Liu, Pasi Fränti, A grid-growing clustering algorithm for geo-spatial data, *Pattern Recognition Letters*, 53, 2015, 77-84.
- [3] Q. Cao, B. Bouqata, P. D. Mackenzie, D. Messier and J. J. Salvo, "A grid-based clustering method for mining frequent trips from large-scale, event-based telematics datasets," 2009 IEEE International Conference on Systems, Man and Cybernetics, San Antonio, TX, 2009, pp. 2996-3001.
- [4] D. Kumar, H. Wu, Y. Lu, S. Krishnaswamy and M. Palaniswami, "Understanding Urban Mobility via Taxi Trip Clustering," 2016 17th IEEE International Conference on Mobile Data Management (MDM), Porto, 2016, pp. 318-324.
- [5] Huiyu Chen, Chao Yang, and Xiangdong Xu, Clustering Vehicle Temporal and Spatial Travel Behavior Using License Plate Recognition Data, *Journal of Advanced Transportation Volume 2017* (2017).
- [6] Daskin, M. (1995). Center problems. In Daskin, M., editor, *Network and Discrete Location: Models, Algorithms, and Applications*, pages 154–197. Wiley, New York.

2.5.2 Assessment of system resilient performance indicators: Application for public transport systems

S. M. H. MAHDAVI^a, N. BHOURI^a, G. SCEMAMA^a

^a *Université Paris-Est; IFSTTAR/COSYS/GRETTIA, 6 14-20 Boulevard Newton Cité Descartes, Champs sur Marne 7 F-77447 Marne la Vallée, Cedex 2- France*

One of the challenging engineering problems is the design and development of resilient systems for public transport operation; set of inter-related strategies that carried out as a unified entity. The entity consists of series of time/space related performance measurement properties that are characterized by a set of strategies. Inevitable disruptive events cause damages to such system's functioning, but then again the implemented resilient system strategies also are expected to have a capacity to remain functional under such irregularities with minimal performance reduction (1). In order to mathematically quantify the functionality of operation and implemented strategies under disruptive event, notable inter-connected dimensions of the problem are documented by researchers and scholars; according to which the system performance is designated within different time states and measured according to respected dimensional strategic perspectives.

The objective of this paper is to propose a resilience index formulation that covers the magnitude of change in network performance. At pre-disruption state, it is described as system's capability to resist and withstand the impact without suffering a loss of functionality (2). In this case, resilience has to be studied in relation to some definitions of performance and strength indicators. It might be referred as functional reliability at the time of disruption. Hence, selected indicators are determinant of the magnitude of passenger route choice described as a probability of successful passenger flow transit without causing dis-connectivity or delay in the network.

Presenting a mathematical formulation of system resiliency in terms of the capability to resist and ability to withstand impact at a disrupted event requires not only capturing the magnitude of the system collapse but also assesment of the effects of system resilient performance indicators. The proposed approach enables decision-makers to enhance the level of strategic preparedness at system failure situation; characterizing the resulting effects on component failure regardless of failure type. Hence, the most comprehensive network resilience indicators should cover change in network performance with respect to the range of multi-dimensional perspectives; measures that can describe physical and service operational specifications of system operability. Hereafter, network complexity and the consequence of the relationship between different levels of service components are characterized through network properties/topology, service supply, and passenger demand.

To examine the the effects of each indicator on system resilience, an analysis is demonstrated through different networks reported by different authors and researchers; constructed based on sample Swiss road network that is initially reported by (3). Hence, the considered networks consist of a fixed number of bus stops and passenger demand matrix, set of different route sizes, with different flow distribution and connectivity patterns. The evaluation approach deploys investigating on how sensitive the network is to each performance indicator values and how passenger flow re-actions/re-distributions would change the resilient index value. To this end, in the analysis of system resilience, demonstrated in the context of public transport network, failures are caused due to changes in system components (i.e. links, transit stops); and extent of failure are described through network property (physical dimension of system components), system capacity and passenger flow change (service dimension of performance). Hence, our assesment of network resilience is twofold within a single index; the evaluation of system in terms of normalized structural functionality, system flow functionality and also analysis of flow distrubution pattern after disruption. This approach makes it possible to study the passenger flow distribution in relation to physical characteristics of network elements at disrupted events.

Keywords: network system resilience index, magnitude, public transport, passenger assignment, performance indicators, complex network

References

- [1] Jin JG, Tang LC, Sun L, Lee D-H. Enhancing metro network resilience via localized integration with bus services. *Transp Res Part E Logist Transp Rev* [Internet]. 2014;63(Supplement C):17–30. Available from: <http://www.sciencedirect.com/science/article/pii/S1366554514000039>.
- [2] Cats O, Koppenol G-J, Warnier M. Robustness assessment of link capacity reduction for complex networks: Application for public transport systems. *Reliab Eng Syst Saf* [Internet]. 2017;167(Supplement C):544–53. Available from: <http://www.sciencedirect.com/science/article/pii/S0951832016308894>.
- [3] Christoph E M. Evaluation and optimization of urban public transportation networks. *Eur J Oper Res*. 1980;5(6):396–404

2.5.3 Improving Public Transport Service Regularity using Cooperative Driver Advisory Systems

G. LASKARIS^a, M. SEREDYNSKI^b, F. VITI^a

^a *Mobilab Research Group, University of Luxembourg*

^b *E-Bus Competence Center*

High stochasticity is inherent in the nature of public transport (PT) operations. One of the constituents of the variability in travel time, among congestion, roadworks or other disruptions, is the delay caused by signalized intersections. It contributes to a longer and less reliable travel time, which affects also the service regularity of the line. This is reflected into long waiting times, uneven passenger loads, bus bunching, and increase of tailpipe emissions and overall poor level of service.

Operators can react dynamically to any disruption and proceed to corrective actions via different control strategies, among others at bus stations. Station control strategies consist of two categories: holding and stop skipping. Holding is extensively used as a strategy, instructing vehicles to remain at the stop for additional time to maintain regularity or to minimize passenger cost. A literature review on real time control is provided by [1]. It is worth mentioning that holding has been combined with other strategies such as stop skipping [2], boarding limits [3], expressing [4] or combination of more such as in [5].

Today, emerging communication technologies allow not only to monitor the position of buses but also enable vehicle-to-vehicle (V2V) and vehicle-to-infrastructure (V2I) connectivity. This widens the range of control actions that can be applied in real time acting correctively or tackling potential disruptions. In general, typical control actions applied between intersections include speed adjustments and traffic signal priority (TSP). The former has been used by, e.g., [6] to reduce bunching. The latter is provided to public transport vehicles given pre-different criteria [9]. The main drawback of signal priority is the delay added to the rest of the traffic network. Access to signal phase and timing (SPaT) allows developing a new class of driver advisory systems (DASs) referred to green light optimal speed advisory (GLOSA) and green light optimal dwell time advisory (GLODTA). With GLOSA, buses adjust their speed in order to pass through a green phase at a downstream intersection [9]. With GLODTA, a vehicle is instructed to extend the dwell time in order to pass through the next green phase at the next intersection [10]. Integrating GLOSA and GLODTA in synergy with TSP has been proven to be very effective and beneficial for the whole traffic system [11].

We argue that the objectives of both SPaT-based DASs and holding strategies are moving on the same direction and may work in a complementary way. The aim of this study is to combine holding by introducing the aforementioned SPaT DAS and revisit their criteria for speed adjustment and departure from stops to account also for the regularity of a transit line.

The innovative features developed in this study are summarized in the following main points:

- The speed advice by GLOSA, which by default simply advises the driver to target a broad range of speeds with no specific service objective, takes into account the current headways of consecutive buses;
- The extended dwell time at stops from GLODTA is applied in line with holding criteria for regularity, if holding needed; and
- By integrating the extended GLOSA and GLODTA with line regularity objectives, we consider also to reduce the need for TSP. In our approach, TSP is requested to a limited extend only if the TSP contribution is critical for the vehicle: to pass through a green phase or when provides significant benefits for line regularity.

In this work we derive analytically and present a novel control model in which, when a vehicle approaches a traffic light, the final decision for the speed is not limited to traverse the next intersection. Additionally, the decision involves the actual time headway between consecutive vehicles, in order to arrive evenly spaced as best as possible at stops, hence reducing the level of bunching.

At stops, where holding is applied (Time Control Points or TCPs), holding time for regularity is determined by a simple rule subject to the forward and backward headways [12], [13]. This holding strategy has proven its effectiveness, compared to other strategies [12], [14]. In order to ensure that vehicles, by the time of their departure, will also traverse the intersection without stopping, the additional time needed is estimated via GLODTA. The latter should be within a specific threshold (0.6 to 0.8 of the planned headway) in order to be acceptable. In case of a late arrival, only GLODTA time is checked and triggered only if it results in time saving for the line.

In the control strategy developed, calls for green time extension and green recall are also considered together with DAS, expecting to be in line with the findings of previous studies for need of weak TSP instead of strong TSP [11].

The proposed scheme is tested and evaluated by simulating an artificial high frequency line. Control is applied at specific stops of a bus line that high passenger demand and delays in terms of travel time are observed. We compare the new control criteria with independent application of holding and the DAS at the selected TCPs and a do-nothing case is used as a benchmark.

The main performance indicators used in this study are the adherence of headway of the line as well as total travel time and its variability. Moreover, we will also analyze the delay at the different intersections and the times the vehicles managed to pass through a green phase, in order to compare the results at both network level and at a local scale.

References

- [1] O. J. Ibarra-Rojas, F. Delgado, R. Giesen, and J. C. Muñoz, "Planning, operation, and control of bus transport systems: A literature review," *Transp. Res. Part B Methodol.*, vol. 77, pp. 38–75, Jul. 2015.
- [2] X. J. Eberlein, N. H. M. Wilson, and D. Bernstein, "Modeling Real-Time Control Strategies In Public Transit Operations," in *Computer-Aided Transit Scheduling*, P. N. H. M. Wilson, Ed. Springer Berlin Heidelberg, 1999, pp. 325–346.
- [3] F. Delgado, J. C. Munoz, and R. Giesen, "How much can holding and/or limiting boarding improve transit performance?," *Transp. Res. Part B Methodol.*, vol. 46, no. 9, pp. 1202–1217, Nov. 2012.
- [4] D. Sáez, C. E. Cortés, F. Milla, A. Núñez, A. Tirachini, and M. Riquelme, "Hybrid predictive control strategy for a public transport system with uncertain demand," *Transportmetrica*, vol. 8, no. 1, pp. 61–86, Jan. 2012.
- [5] M. M. Nesheli and A. Ceder, "Real-Time Public Transport Operations: Library of Control Strategies," *Transp. Res. Rec. J. Transp. Res. Board*, no. 2647, pp. 26–32, 2017.
- [6] C. F. Daganzo and J. Pilachowski, "Reducing bunching with bus-to-bus cooperation," *Transp. Res. Part B Methodol.*, vol. 45, no. 1, pp. 267–277, Jan. 2011.
- [7] C. Diakaki *et al.*, "Extensions and new applications of the traffic-responsive urban control strategy: Coordinated signal control for urban networks," *Transp. Res. Rec. J. Transp. Res. Board*, no. 1856, pp. 202–211, 2003.
- [8] N. van Oort, J. W. Boterman, and R. van Nes, "The impact of scheduling on service reliability: trip-time determination and holding points in long-headway services," *Public Transp.*, vol. 4, no. 1, pp. 39–56, Jun. 2012.

- [9] R. Bodenheimer, A. Brauer, D. Eckhoff, and R. German, "Enabling GLOSA for adaptive traffic lights," in *Vehicular Networking Conference (VNC), 2014 IEEE*, 2014, pp. 167–174.
- [10] B. Asadi and A. Vahidi, "Predictive cruise control: Utilizing upcoming traffic signal information for improving fuel economy and reducing trip time," *IEEE Trans. Control Syst. Technol.*, vol. 19, no. 3, pp. 707–714, 2011.
- [11] M. Seredynski and D. Khadraoui, "Complementing transit signal priority with speed and dwell time extension advisories," in *Intelligent Transportation Systems (ITSC), 2014 IEEE 17th International Conference on*, 2014, pp. 1009–1014.
- [12] O. Cats, A. Larijani, H. Koutsopoulos, and W. Burghout, "Impacts of Holding Control Strategies on Transit Performance," *Transp. Res. Rec. J. Transp. Res. Board*, vol. 2216, pp. 51–58, Dec. 2011.
- [13] L. Fu and X. Yang, "Design and Implementation of Bus-Holding Control Strategies with Real-Time Information," *Transp. Res. Rec. J. Transp. Res. Board*, vol. 1791, pp. 6–12, Jan. 2002.
- [14] O. Cats, A. Larijani, Á. Ólafsdóttir, W. Burghout, I. Andréasson, and H. Koutsopoulos, "Bus-Holding Control Strategies," *Transp. Res. Rec. J. Transp. Res. Board*, vol. 2274, pp. 100–108, Oct. 2012.

2.5.4 A statistical simulation-based approach to identify network vulnerability to urban freight movements

M. D. SIMONI^a, M. VESTRUCCI^b

^a *Dept. of Civil, Architectural, and Environmental Engineering, The University of Texas at Austin*

^b *Dept. of Statistics and Data Science, University of Texas at Austin*

Urban freight distribution is a major challenge in metropolitan areas. Freight traffic represents a significant portion of transportation costs (about 18% of total congestion costs in the US [1]) and delivery costs (up to 50% for parcel deliveries). Among the different externalities associated with the last-mile of the delivery chain (pollution, congestion, safety), the limited parking availability for commercial vehicles is certainly a critical issue [2,3]. In order to develop appropriate freight traffic management and policy measures to tackle this issue, it is important to determine network criticalities. These ones can depend on traffic characteristics, properties of freight demand, and on the network morphology. However, this is not a straightforward task given the complex interactions of freight operations with "regular" traffic, especially at network level.

In this study, we present a statistical approach to identify the critical factors and vulnerable areas of urban networks subject to urban freight operations. We focus in particular, on the problem of double-parking. The analyses of traffic impacts of freight operations are based on a hybrid traffic simulation model that reproduces macroscopically the behaviour of all traffic except for the delivery vehicles that are represented microscopically. The model is solved by means of a semi-analytical computational method that allows for efficient and accurate simulations of urban networks.

In this study, we investigate the downtown network of the city of Austin, Texas. A series of statistical analyses of the results are performed to characterize the network behaviour in response to double parking events, and to identify which links and areas of the system are the most affected. At the same time, information regarding the efficiency of carriers' delivery operations is analysed. This kind of information could help policy-makers to take informed decisions about managing freight traffic entering network, considering the impacts on both traffic and carriers' operations.

References

- [1] Schrank, David, Bill Eisele, Tim Lomax, and Jim Bak. (2015). 2015 Urban Mobility Scorecard. Harvard. Retrieved at: <http://d2dtl5nnlpfr0r.cloudfront.net/tti.tamu.edu/documents/mobility-scorecard-2015.pdf>. (Accessed on October, 2017).
- [2] Jaller, M., Holguín-Veras, J., & Hodge, S. (2013). Parking in the city: Challenges for freight traffic. *Transportation Research Record: Journal of the Transportation Research Board*, (2379), 46-56.
- [3] Nuzzolo, A., Comi, A., Ibeas, A., & Moura, J. L. (2016). Urban freight transport and city logistics policies: Indications from Rome, Barcelona, and Santander. *International Journal of Sustainable Transportation*, 10(6), 552-566.

2.6 Parallel Session 2b - ADAS

2.6.1 Cooperative Adaptive Cruise Control with Authority Transition at Merges: Insights into Flow Characteristics

L. XIAO^a, M. WANG^a, B. VAN AREM^a

^a *Department of Transport & Planning, Delft University of Technology*

Introduction

Cooperative Adaptive Cruise Control (CACC) systems have the potential to increase roadway capacity and mitigate traffic congestion thanks to the short following distance enabled by inter-vehicle communication [1] and have been tested in real-world pilots [2]. Impact of CACC systems on traffic flow operations is of paramount importance to policy-making, planning and operations regarding motorway networks. Although few studies analysed the capacity implications of CACC systems, strong assumptions need to be made to enable the closed-form analysis of equilibrium CACC behaviour [3] and dynamic features of traffic flow such as two-capacity phenomenon and stability are often neglected. These phenomena are well captured in microscopic traffic simulation, making it a competent tool to study flow impact of CACC [4-6].

To represent CACC vehicle behaviour in traffic simulations, default human-driver car-following models need to be replaced by CACC car-following models. A group of studies used the desired speeds or accelerations from CACC controllers as the actual speeds or accelerations in the simulation [7, 8], while others incorporated a single time delay in the modelled system dynamics, e.g. the current acceleration/speed is a function of gap and relative speed of a previous time [9, 10]. Others [1, 11, 12] applied a first-order lag between the desired speed/acceleration and the actual vehicle speed/acceleration to represent the driveline dynamics, whereas the effects of external factors still cannot be captured. The last group of studies modelled the actual speeds and/or accelerations of ACC/CACC vehicles using observed car-following response during field tests [2]. However, when operating at low speeds and safety-critical conditions, the model fails to avoid a collision. In reality, human drivers often take over the control of pedals and deactivate ACC/CACC systems when operating conditions are outside the design domain. This induces extra dynamics that are not represented by existing models. Furthermore, when operating on multi-lane highways, lane change manoeuvres involving interactions with surrounding vehicles are common at highway discontinuities such as merge and lane drop. These manoeuvres are also challenging for CACC systems and an authority transition often occurs in such circumstances.

This contribution proposes a multi-regime car-following model that operates in full-speed range and incorporates authority transition and plausible lane change behaviour. The model is applied to evaluate freeway operations at a merging bottleneck with varying CACC market penetration rates (MPRs).

CACC Car-following Model

We proposed a multi-regime car-following model of CACC vehicles with two parallel control loops as shown in Figure 13. At each time step, the model captures the decision of which mode the CACC system is operating and the relation between the realized acceleration/speed and the *delayed* positions and speeds of ego vehicle and the preceding vehicle, rather than detailing the ACC/CACC algorithms and lower-level vehicle dynamics.

Figure 13. Conceptual longitudinal model for CACC vehicles in simulations

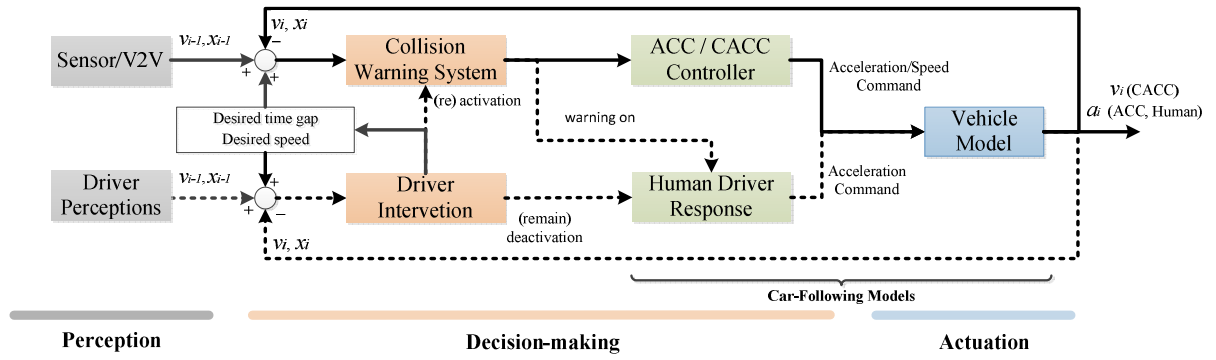

Source: Own elaborations.

CACC vehicles have three possible vehicle operating systems: manual driving, ACC operation and CACC operation. When operating in CACC mode, three sub-operation modes exist for three different motion purposes:

- A cruising controller to maintain a user-set desired speed if a preceding vehicle is absent:

$$a_{i,k} = k_0 \cdot (v_{set} - v_{i,k-1}) \quad (1)$$

where k_0 is the feedback gain and v_{set} is vehicle's desired speed.

- A gap-regulating controller to maintain a constant time gap with its predecessor in car-following situations:

$$v_{i,k} = v_{i,k-1} + k_p \cdot e_{i,k-1} + k_d \cdot \frac{d(e_{i,k-1})}{\Delta t} \quad (2)$$

where $e_{i,k-1}$ is gap error in the previous time step, which is determined by the constant time gap policy. k_p and k_d are feedback gains.

- A gap-closing controller performing a transition from the cruising controller to the gap-regulating controller when a CACC vehicle approaches its leader with a relative speed. The model formulation is the same as the gap-regulating mode but with a higher feedback gain k_d on the derivative term and a lower gain k_p on gap error.

CACC-Driver Interaction

CACC systems may be deactivated by human drivers and we modelled three types of CACC-Driver interactions:

- Type I - Safety-related deactivation: This can be system-initiated when the rear-end collision warning system indicates a high risk; or driver-initiated, e.g. drivers know CACC systems cannot cope with approaching the predecessor with very high relative speeds and take over vehicle control actively.
- Type II - Lane change related: This occurs when the CACC vehicles need to synchronise its speed with the target lane as preparation for a lane change or they should yield for other vehicles to change lane in front, i.e. cooperative lane change.
- Type III - Mandatory lane changes: This deactivation occurs when the CACC vehicle has to make mandatory lane changes at entries or exits or lane drops.

Simulation Setting and Results

The proposed CACC model is implemented in MOTUS, incorporating with the Integrated Lane Change Model with Relaxation and Synchronization (LMRS)[13]. A merge, a four-lane highway segment with a single-lane on-ramp, is simulated as shown in Figure 14

and we also simulate the same four-lane section without the merge (i.e. a pipeline network) for a comparison of capacity.

Figure 14. Road sketch of the simulated network with detector locations D1, D2 and D3

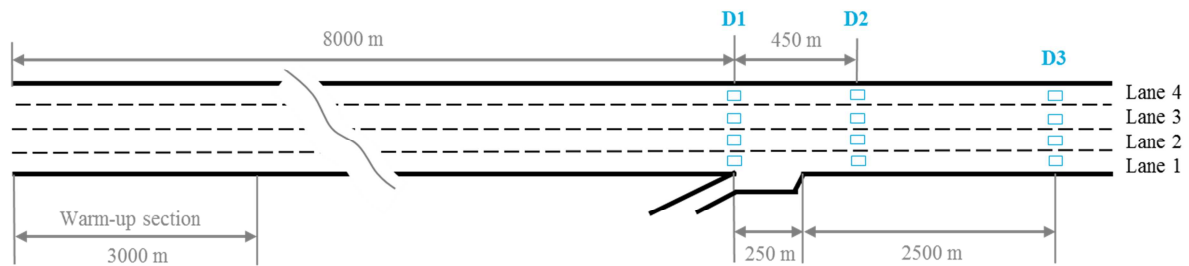

Source: Own elaborations.

Figure 15. Flow-Density plots with CACC MPRs

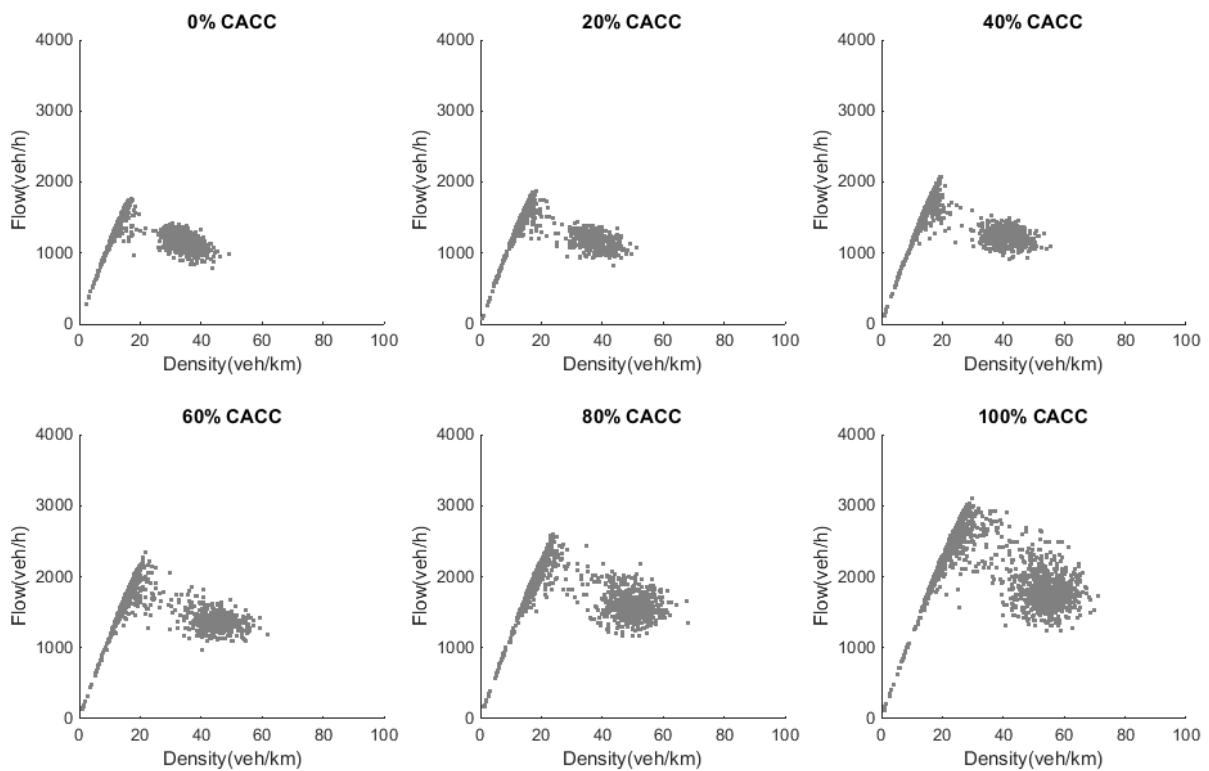

Source: Own elaborations.

Figure 15 shows the flow-density at the merging bottleneck with an increased CACC MPR. The general shape of fundamental diagram follows the reverse- λ shape curve as observed in manually-driven vehicle traffic. This suggests the existence of *capacity drop* in the mixed traffic with conventional vehicles and CACC vehicles and even with 100% CACC vehicles. It also becomes pronounced that the scatter in the congested flow regime increases with the CACC MPRs, especially at MPRs larger than 60%.

To further illustrate the capacity change, we compare the capacity measured at the pipeline network with the capacity of the merging bottleneck and the queue discharge rate. This gives the following insights:

- Pipeline capacity, merging capacity and queue discharge rates increase with the increase of MPRs. But the rate of capacity increase is much less than that of the MPRs, in particular at low MPRs;
- Capacity measured at pipeline stretch without network discontinuities are higher than merging capacity at all MPRs;
- Capacity drop exists with an order of 15% reduction in capacity prevails irrespective of the MPRs.

Table 1. Free-flow capacity and queue discharge rate with CACC market penetration rates, compared to theoretical upper bound and the pipeline capacity

veh/h/lane	CACC Market Penetration Rates					
	0%	20%	40%	60%	80%	100%
Theoretical upper bound	2332	2452	2645	2945	3397	3877
Pipeline Capacity	2124	2222	2353	2620	3092	3824
Δ	-	4.6%	10.8%	23.3%	45.6%	80.1%
Merging Capacity	2031	2094	2197	2400	2708	3293
Δ	-	3.1%	8.2%	18.2%	33.3%	62.1%
Queue Discharge Flow	1684	1774	1837	1999	2268	2725
Δ	-	5.3%	9.1%	18.7%	43.3%	61.8%
Capacity Drop	347	320	360	401	440	568
%	17.1%	15.4%	16.4%	16.7%	16.0%	17.2%

Source: Own elaborations.

At merging bottleneck, mandatory lane changes frequently take place, which leads to deactivations of CACC systems and CACC vehicles operating in manually-driven mode follow the predecessor with larger time gaps and inherit the asymmetric decelerating/accelerating behavior, both contribute to the reduction in throughput. In addition, when congestion starts, safety-related deactivations and lane-change-related deactivations increase, which adds fuel to the capacity drop. The relations among congestion pattern and system deactivation is clear from the heat map below.

Figure 16. The relations among congestion pattern and number of deactivations. An example in 60% CACC scenario with a 1200 veh/h on-ramp demand

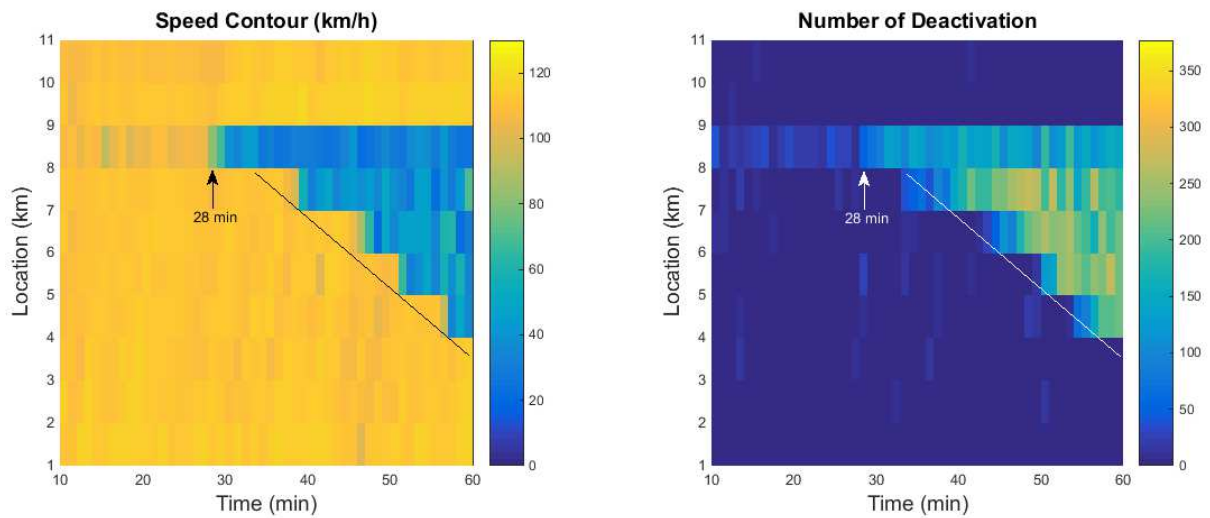

Source: Own elaborations.

Summary

We proposed multi-regime CACC model with authority transitions and applied it to examine the impact of CACC on flow features at a merging bottleneck via simulation. Results show that the capacity does increase with the increase of CACC MPRs, but the increase rate at realistic networks is not as promising as reported in the literature. The complex CACC deactivation/activation dynamics contribute to the scatter in the fundamental diagram and results in capacity drop, suggesting the attention needed for reliability issue and potential for cooperative merging. The study points out several directions of attention for road operators and system developers.

References

- [1] VanderWerf, J., et al., *Modeling Effects of Driver Control Assistance Systems on Traffic*. Transportation Research Record: Journal of the Transportation Research Board, 2001(1748): p. 167-174.
- [2] Milanés, V. and S.E. Shladover, *Modeling cooperative and autonomous adaptive cruise control dynamic responses using experimental data*. Transportation Research Part C-Emerging Technologies, 2014. 48: p. 285-300.
- [3] Chen, D.J., et al., *Towards vehicle automation: Roadway capacity formulation for traffic mixed with regular and automated vehicles*. Transportation Research Part B-Methodological, 2017. 100: p. 196-221.
- [4] Shladover, S.E., D. Su, and X.-Y. Lu, *Impacts of Cooperative Adaptive Cruise Control on Freeway Traffic Flow*. Transportation Research Record: Journal of the Transportation Research Board, 2012(2324): p. 63-70.
- [5] Makridis, M., et al., *Assessing the Impact of Connected and Automated Vehicles. A Freeway Scenario*, in Zachäus C., Müller B., Meyer G. (eds) *Advanced Microsystems for Automotive Applications 2017. Lecture Notes in Mobility*. . 2017, Springer, Cham. p. 213-225.
- [6] Talebpour, A. and H.S. Mahmassani, *Influence of connected and autonomous vehicles on traffic flow stability and throughput*. Transportation Research Part C-Emerging Technologies, 2016. 71: p. 143-163.
- [7] Wilmlink, I.R., G.A. Klunder, and B. van Arem. *Traffic Flow Effects of Integrated Full-Range Speed Assistance (IRSA)*. in *IEEE Intelligent Vehicles Symposium*. 2007. Istanbul: IEEE.

- [8] Deng, Q., *A General Simulation Framework for Modeling and Analysis of Heavy-Duty Vehicle Platooning*. IEEE Transactions on Intelligent Transportation Systems, 2016. 17(11): p. 3252-3262.
- [9] Ge, J.I. and G. Orosz, *Dynamics of connected vehicle systems with delayed acceleration feedback*. Transportation Research Part C: Emerging Technologies, 2014. 46: p. 46-64.
- [10] Jia, D. and D. Ngoduy, *Enhanced cooperative car-following traffic model with the combination of V2V and V2I communication*. Transportation Research Part B: Methodological, 2016. 90: p. 172-191.
- [11] van Arem, B., C.J.G. van Driel, and R. Visser, *The Impact of Cooperative Adaptive Cruise Control on Traffic-Flow Characteristics*. IEEE Transactions on Intelligent Transportation Systems, 2006. 7(4): p. 429-436.
- [12] Jia, D. and D. Ngoduy, *Platoon Based Cooperative Driving Model with Consideration of Realistic Inter-Vehicle Communication*. Transportation Research Part C: Emerging Technologies, 2016. 68: p. 245-264.
- [13] Schakel, W.J., V.L. Knoop, and B.v. Arem, *Integrated Lane Change Model with Relaxation and Synchronization*. Transportation Research Record: Journal of the Transportation Research Board, 2012(2316): p. 47-57.

2.6.2 Estimating the response time of a commercially available ACC controller

M. MAKRIDIS^a, K. MATTAS^a, B. CIUFFO^a, D. BORIO^b and R. GIULIANI^b

^a Directorate for Energy, Transport and Climate, European Commission – Joint Research Centre, Via E. Fermi, 2749 – 21027 Ispra (VA), Italy

^b Directorate for Space, Security and Migration, European Commission – Joint Research Centre, Via E. Fermi, 2749 – 21027 Ispra (VA), Italy

The next decades are expected to bring a transformation of the transportation sector as we experience it nowadays. It is highly probably that automation and connectivity will lead this transitional era with the deployment of Connected and Automated Vehicles (CAVs) [1]. New driving assistance technologies are constantly being deployed in commercial vehicle and soon will reach the higher levels in the SAE scale [2]. On one hand, connectivity and automation offer unprecedented capabilities but on the other hand there are privacy, security and safety challenges that need to be solved or regulated [3]–[5]. There are only few studies in the literature dealing with automated systems on real data. Moreover, in simulation studies, the impact of new technologies in the network is dependent one the parameterization of the model and thus inappropriate model design can easily point to misleading conclusions.

Since automation is still in its infancy, it is not possible to find in the market very advanced systems ready to test or simulate. Currently, an important functionality already tested and available in commercial vehicles is the Adaptive Cruise Control (ACC). This work presents an experimental study of an ACC-enabled vehicle that follows another one and a methodology of estimating the response time of such systems that can be adopted in other scenarios. The proposed methodology estimates the response time of the ACC system based on real measurements obtained from Global Navigation Satellite System (GNSS) receivers using two vehicles in car following mode. In order to conclude on the response time of the system, this work correlates the acceleration of the follower with the inter-vehicle speed difference.

In this work, the experiments were conducted over a predefined track in the Joint Research Centre (JRC) in Ispra, Italy. Both vehicles drove, in total, 28.7 km, 24.1 of which using the ACC controller and 4.6 in manual driving conditions. The leading vehicle was driving in manual mode. The length of a single lap is roughly 1.15 km and, in total, the results refer to 25 laps. We consider response time as the time needed for the ACC controller to react, responding on an obvious action of the leading vehicle. The possible actions that can be done by the leading vehicle are two, either acceleration or deceleration. The vehicle's controller obtain information about its speed, the speed of the leader vehicle and their relative distance.

So, in order to estimate the response of the ACC controller, the follower's acceleration, $acc(t_i)$, and the difference in the speed between leader and follower, $spdiff(t_i)$, are compared for each measurement, i . Next, $acc(t_i)$ is shifted for an interval between 0.1 and 4 s with a step of 0.1 s. For each shift, the Pearson's correlation coefficient, r , is computed. The shift value that corresponds to the highest r can be considered as the estimated response time of the following vehicle. For each shifted time series, $acc(t_i - s)$ with $s \in \{0, 0.1, \dots, 4\}$, the Pearson's correlation coefficient can be computed as:

$$r(s) = \frac{\sum_{i=1}^n (acc(t_i - s) - \overline{acc}) \cdot (spdiff(t_i) - \overline{spdiff})}{\sqrt{\sum_{i=1}^n (acc(t_i - s) - \overline{acc})^2} \cdot \sqrt{\sum_{i=1}^n (spdiff(t_i) - \overline{spdiff})^2}}$$

where \overline{acc} and \overline{spdiff} are the sample means of the time series used for the computation of $r(s)$. Finally, the response time can be estimated by finding the maximum of the derived set of coefficients:

An illustration of the above-described procedure is provided in Figure 17. The upper figure shows the vehicles' speed difference synchronized (action) with the acceleration of the follower (response). A clear lag can be observed between these two time series. The bottom part of the figure is obtained after shifting the two time series in order to maximize their correlation and consequently estimate the response time.

Figure 17. Estimation of response time based on maximizing time series correlation. Chart on top refers to the synchronized time series of the speed difference (light grey line) and the acceleration imposed by the ACC system (black line). Chart below refers to the same time series after shifting the acceleration profile by the estimated response time.

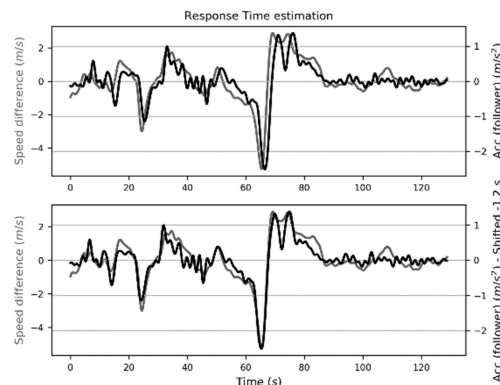

Source: Own elaborations.

The results from the present study show that contrary to prevalent opinion in the current literature, ACC has high response time values, close to human reaction time ones. The estimated values for the response time in our tests were found between 0.9 - 1.3 s for the laps when the driver had ACC mode on and between 1.4 - 1.5 s for the laps when the ACC model was off. Such response times can cause serious instability issues and can have a negative impact on the flow of the network.

The main findings of the present work can be summarized as follows:

- ACC response times found close to the reaction times of humans.
- ACC car following models for micro-simulation in the literature ignore or use low values for defining the response time of the vehicles.
- Time gap values found on real driving conditions are considered higher than the values found in the literature.

References

- [1] M. A. Raposo, B. Ciuffo, M. Makridis, and C. Thiel, "The r-evolution of driving: from Connected Vehicles to Coordinated Automated Road Transport (C-ART), Part I: Framework for a safe & efficient Coordinated Automated Road Transport (C-ART) system," EUR 28575.
- [2] "J3016A: Taxonomy and Definitions for Terms Related to Driving Automation Systems for On-Road Motor Vehicles - SAE International." [Online]. Available: http://standards.sae.org/j3016_201609/. [Accessed: 07-Dec-2017].
- [3] D. Barber and A. Best, "Connected and Automated Vehicle Simulation to Enhance Vehicle Message Delivery," in *Advances in Human Factors in Simulation and Modeling*, 2017, pp. 38-46.

- [4] D. J. Fagnant and K. Kockelman, "Preparing a nation for autonomous vehicles: opportunities, barriers and policy recommendations," *Transp. Res. Part Policy Pract.*, vol. 77, no. Supplement C, pp. 167–181, Jul. 2015.
- [5] K. Jadaan, S. Zeater, and Y. Abukhalil, "Connected Vehicles: An Innovative Transport Technology," *Procedia Eng.*, vol. 187, no. Supplement C, pp. 641–648, Jan. 2017.

2.6.3 Safety Analysis of Cooperative Adaptive Cruise Control System in a Mixed Vehicle Scenario

R. H. PATEL^a, J. HÄRRI^a, C. BONNET^a

^a Communication Systems Department, EURECOM, 06904 Sophia-Antipolis, France

Figure 18. A mixed vehicle scenario is represented with Cooperative Adaptive Cruise Control (CACC) vehicles and manually driven vehicles (MDVs). CACC vehicles are assumed to have both uplink and downlink whereas MDVs are assumed to have only uplink

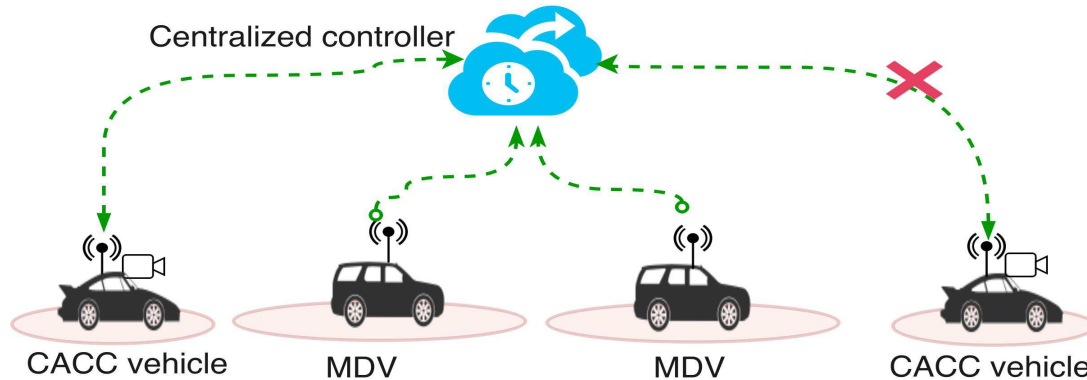

Source: Own elaborations.

The presence of onboard communication units opens up a plethora of opportunities to implement applications related to, including, but not limited to traffic efficiency, traffic hazard warnings, cooperative road safety and collision avoidance maneuvers. Different applications would have different accuracy and performance requirements. Most of these applications would require the *localization/sensing module* to obtain positioning information of participating vehicles' with a particular accuracy. This information needs to be communicated to other vehicles in a decentralized system or a centralized entity in a centralized system using the *communication module*. Based on the state parameters and the objectives, the *control module* needs to compute controls satisfying individual vehicle objectives whilst obeying constraints. Thus positioning, communication and control modules form the base of the platform on which different applications of a Cooperative Adaptive Cruise Control (CACC) run. Errors in any of these modules can create faulty controls for CACC vehicles.

When controls are computed, information of neighboring vehicles and their future controls (intent) need to be considered. The centralized controller computes control values over the prediction horizon which includes present and future control inputs. Thus the intent of the CACC vehicles is known to the control system. But in a *mixed vehicle scenario*, a control system can not know the future controls (the intent) of a manually driven vehicles (MDVs), but only predict it. There is a *model mismatch* when the predicted control is different from the actual control implementation of the MDV. As the intent of MDV can only be predicted and never be exactly known, CACC controls are never perfect in a mixed vehicle scenario. The use of such imperfect controls generated due to model mismatch can lead to collisions. Thus in a mixed vehicle scenario, besides communication, control and positioning errors, model mismatch based errors influence the performance of a centralized controller.

In this paper we simulate a mixed vehicle (refer Figure 18) braking scenario where CACC vehicles implement controls derived from a Model Predictive Control (MPC) based centralized controller and MDV react based on the neighboring vehicles. Among all aspects influencing CACC vehicles, in this work we focus on the impact of the following three, localization errors, model mismatches and communication errors. Consequences of the above errors on comfort and collision avoidance statistics are studied. We propose the use of a buffer where control inputs computed after every successful Model Predictive

Control (MPC) simulation are stored. In case of either an infeasibility (due to localization errors or model mismatch) or unavailability of new controls (due to communication errors), values from the buffer should be used. The improvement in results because of the use of a buffer is discussed.

2.6.4 A kinematic wave theory of tidal traffic flow

K. AMPOUNTOLAS^a, R. CASTELAN CARLSON^b

^a School of Engineering, University of Glasgow, Glasgow G12 8QQ, United Kingdom

^b Dept. of Automation & Systems, Federal University of Santa Catarina, Florianopolis-SC 88040-900, Brazil

In principle, bi-directional motorways should be designed to adequately serve the peak-hour traffic volume in both directions. However, if directional flow disparity is significant between the two directions of traffic, congestion may be created in one direction while the other direction free-flows; strongly under-utilising the existing infrastructure due to the lack of efficient and comprehensive lane control. In such cases, the optimal utilisation of the existing infrastructure capacity through the concept of tidal (or reversible) lanes is a practical approach to improve the traffic conditions, particularly during peak hours [1]. The benefit of tidal traffic flow is that the available flow capacity in each direction of traffic can be varied in response to highly directional inbound or outbound demands. An odd number of lanes, usually three to seven, are required for effective tidal traffic flow operation. The middle lane operates as a contraflow buffer zone to serve traffic in different directions. To ensure safe operation of contraflow, lane-use control signals located at overhead gantries are used wherever a particular movement is prohibited for designated lanes. A serious drawback, however, is the cost to manage and to efficiently control reversible lanes as well as the confusion to drivers and safety.

This work presents a theoretical analysis of tidal traffic flow that is based on the Kinematic Wave Theory (KWT). Also it provides a number of insights on the effectiveness of tidal flow lane management in terms of motorway capacity, throughput maximisation, and total time spent. The main question this work addresses is [2]: If inflows and outflows are balanced to maintain the bi-directional traffic in a steady-state for a fixed total number of desired bi-directional trips, what is the distribution of densities that maximises the bi-directional total outflow. How the infrastructure should be managed to accommodate this distribution? For the analysis of tidal traffic flow a simple kinematic wave model is employed that is based on a generic or a triangular fundamental diagram (FD). Two location-dependent concave FDs one for each direction of traffic are employed to discuss the kinematic wave solutions of the prevailing traffic.

The problem of bi-directional throughput maximisation is formulated as a constrained optimisation problem and first-order necessary conditions are derived. In this problem, the total bi-directional outflow is maximised subject to the total bi-directional accumulation of vehicles (provided some directional flow disparity between the two directions of traffic). The obtained optimality conditions imply that the most popular direction of traffic (i.e., the one with the largest number of trips) should have the smallest slope (kinematic wave speed) in absolute value, i.e., the densities closest to critical and flows closest to capacity. Further, it suggests that the least popular direction of traffic with the smallest number of trips should have the largest positive slope, i.e., should be on the rising branch of the FD. An alternative interpretation of the optimality conditions suggests that the ratio of exiting flows between the two directions of traffic is equal to the reciprocal of their kinematic wave speeds. In summary, the obtained optimality conditions suggest that infrastructure and densities should be managed so as to maximise flow on the direction of motorway that contains the maximum number of desired destinations. Well-designed tidal flow management policies would ideally conform to these conditions in order to be Pareto-optimal and benefit both directions of traffic [2].

References

- [1] J. Obenberger, "Managed lanes," *Public Roads*, vol. 68, no. 3, pp. 48-55, 2004.
- [2] K. Ampountolas, H. Salvaro Furtado, and R. Castelan Carlson, "Motorway tidal flow lane control," in *15th IFAC Symposium on Control in Transportation Systems*, Savona, Italy, June 6-8, 2018.

2.6.5 MPC-based optimal path planning for automated vehicles in realistic simulation

P. TYPALDOS^a, K.S. MOUNTAKIS^a, M. PAPAGEORGIOU^a, I. PAPAMICHAIL^a

^a *Dynamic Systems and Simulation Laboratory, School of Production Engineering & Management, Technical University of Crete, 73100, Chania, Greece*

Over the past few years, intensive research has been carried out towards the development of fully automated driving for road vehicles. Fully automated vehicles could improve safety and efficiency of traffic operations by reducing accidents caused by human driver errors, improve driver and passenger comfort and, at the same time, help to reduce traffic congestion. Although vehicle automation has already led to significant achievements in supporting the driver in various ways, raising the level of automation to fully-automated driving is a challenging problem. This is mainly due to the complexity of real-world environments, including avoidance of static and moving obstacles, compliance with traffic rules and consideration of human driving behaviour aspects. The development of fully automated driving algorithms is inherently related to planning and updating a vehicle path, which should be feasible, collision-free and user-acceptable. Planning such a path can be seen as a trajectory generation problem, i.e., creation of a quasi-continuous sequence of states that must be tracked by the vehicle control. Path planning in the presence of obstacles has been widely studied in robotics [1]; however, path planning for road vehicles is a more critical task, since the safety of the passengers must be guaranteed while vehicles are driving at high speeds [2].

In [3], an algorithm for generating a feasible and efficient path for an “ego” vehicle is derived from the opportune formulation of an optimal control problem. Vehicle kinematics, the road layout, the presence of obstacles (i.e. of other moving vehicles and road-boundaries), as well as traffic rules are taken into account in order to ensure path feasibility. More specifically, the following optimization problem is considered. For the kinematic equations of vehicle motion, the road is represented in two-dimensional space, and the ego vehicle position is expressed in global Euclidean coordinates. The state variables consist of the longitudinal and lateral position and the longitudinal and lateral speed, while the control variables are the longitudinal and lateral acceleration; the final time-horizon for the optimal control problem is fixed. As for the other vehicles, we assume at each optimization run that they maintain the speed they had at the start of the optimization, but more elaborate predictions are possible. Our approach amounts to minimizing an objective function that comprises:

- a penalty term for collision avoidance with other vehicles, featuring high values at each gross vehicle space and tending to zero outside of that space; the gross vehicle space incorporates, beyond the physical vehicle dimensions, also appropriate longitudinal time-gaps.
- a penalty term featuring high values near road boundaries, preventing the off-road departure of the ego vehicle;
- an appropriate penalty function for the compliance with specific traffic rules;
- a quadratic term that penalizes any deviation of longitudinal speed from a certain desired longitudinal speed;
- a quadratic term that penalizes any deviation of the ego vehicle’s lateral and longitudinal acceleration from zero (i.e. acceleration is penalized as it affects passenger comfort and fuel consumption).

Each of the aforementioned penalty terms is associated with a corresponding weight that reflects its relative importance. Exploiting the structure of the system dynamics (state equations), a reduced gradient may be readily obtained, and, thereby, the optimal control problem is mapped to a non-linear programming problem in the reduced space of the control variables. This results in a substantial reduction of the problem dimension, as state variables are essentially eliminated. Starting from an arbitrary initial control

trajectory (or path), a local minimum is obtained with a very efficient iterative Feasible Direction Search (FDS) algorithm [4]. A simple Dynamic Programming (DP) algorithm is also conceived to deliver the initial control trajectory, greatly enhancing the quality of obtained local minima.

In this work, we take advantage of low computation times in order to embed this optimization-based path-planning approach within a Model Predictive Control (MPC) framework, which is implemented in Aimsun's micro-simulation platform [5]. Considering a motorway network and alongside of vehicles following Aimsun's default driving behaviour, one or more vehicles are instructed to track a path produced by our optimization approach. The path for each such controlled vehicle is generated according to the current lane and speed of surrounding vehicles and is re-generated (updated) in the following cases:

- at the end of the time-horizon;
- when surrounding vehicles deviate substantially from their predicted paths (used for optimization);
- when the controlled vehicle cannot track the produced path (e.g. when certain safety-related lane-changing restrictions imposed by Aimsun are violated).

Aimsun's micro-simulation platform enables a thorough experimental evaluation of our approach on a large number of different traffic scenarios. More specifically, we present preliminary results related to traffic conditions with recurrent congestion. Within this simulation environment, the performance of our approach for the ego vehicle advancement, reduction of travel time or reduction of fuel consumption can be thoroughly assessed. From a macroscopic standpoint, we plan to eventually investigate the impact of different driving behaviours on traffic flow efficiency, particularly in cases of increasing penetration rates of automated vehicles.

References

- [1] Goerzen, C., Kong, Z. and Mettler, B., 2010. A survey of motion planning algorithms from the perspective of autonomous UAV guidance. *Journal of Intelligent and Robotic Systems*, 57(1-4), p.65.
- [2] Werling, M., Gindele, T., Jagszent, D. and Groll, L., 2008. A robust algorithm for handling moving traffic in urban scenarios. In *Intelligent Vehicles Symposium, 2008 IEEE* (pp. 1108-1112).
- [3] Makantasis K., Papageorgiou M., 2018. Motorway Path Planning for Automated Road Vehicles Based on Optimal Control Methods. *Proceedings of the 97th Annual Meeting of the Transportation Research Board (TRB), Washington, D.C., USA, paper no. 18-01437.*
- [4] Papageorgiou M., Marinaki M., Typaldos P., Makantasis K., 2016. A Feasible Direction Algorithm for the Numerical Solution of Optimal Control Problems – Extended Version. Chania, Greece: Technical University of Crete, Dynamics Sysyems and Simulations Laboratory; Report No: 2016-26.
- [5] Transport Simulation Systems, Aimsun, Version 8. 2014; software available at: <http://www.aimsun.com>.

2.6.6 Optimal control of cooperative traffic systems with Hamilton-Jacobi formulation of kinematic wave model

A. H. F. CHOW^a

^a *Systems Engineering and Engineering Management, City University of Hong Kong, Kowloon Tong, Hong Kong*

This paper presents an optimal control formulation for motorway traffic with cooperative vehicles based upon a hybrid kinematic wave model that can capture and integrate both Eulerian and Lagrangian traffic data and state variables. The kinematic wave model assumes the traffic flow $f(x,t)$ at location x and time t is related to the associated density value $\rho(x,t)$ through a flow-density mapping Φ known as the fundamental diagram:

$$f(x,t) = \Phi[\rho(x,t)], \quad (1)$$

for all (x,t) in the space-time domain of interest. The evolution of density is governed by the following hyperbolic conservation law:

$$\frac{\partial \rho(x,t)}{\partial t} + \frac{\partial f(x,t)}{\partial x} = 0. \quad (2)$$

Following Daganzo (2005), the kinematic wave model (1) and (2) can be reformulated as a Hamilton-Jacobi (HJ) partial differential equation:

$$\frac{\partial N(x,t)}{\partial t} = \Phi \left[-\frac{\partial N(x,t)}{\partial x} \right], \quad (3)$$

The $N(x,t)$ function represents the cumulative amount of traffic that has passed location x by time t . By definition, we have:

$$\frac{\partial N}{\partial t} \Big|_{(x,t)} = f(x,t); \quad -\frac{\partial N}{\partial x} \Big|_{(x,t)} = \rho(x,t). \quad (4)$$

Similar to other systems of partial differential equations, the HJ equation (4) is subject to a set of initial and boundary conditions. Given an one-directional road that starts at location x_0 and ends at x_m , we define \mathbf{B} be the function defining the initial and boundary N values at specific locations and times. Following Mazare et al. (2011), we summarise all these values as:

$$\mathbf{B}(x_{\mathbf{B}}, t_{\mathbf{B}}) = \begin{cases} B_{ini}(x, 0), & \text{for all } x \text{ at } t_{\mathbf{B}} = 0 \text{ (initial condition)} \\ B_{up}(x_0, t), & \text{for all } t \text{ at } x_{\mathbf{B}} = x_0 \text{ (upstream boundary)} \\ B_{down}(x_m, t), & \text{for all } t \text{ at } x_{\mathbf{B}} = x_m \text{ (downstream boundary)} \\ B_{intern}(c_n(t), t). & \text{(internal boundary conditions due to } C) \end{cases} \quad (5)$$

The last expression in (5) is an internal boundary condition due to a bottleneck C inside the system. The bottleneck C follows an explicitly defined trajectory function $c_n(t)$ over time t . It is noted that C can be either stationary or moving, and can be used to represent the dynamics of specific vehicles n (e.g. buses, trucks) or fixed location signal controllers. The combination of (4) and (5) is known as the Cauchy problem in the context of partial differential equation. Daganzo [1] proposes an approach for solving the Cauchy problem (4) and (5) through introducing the following cost function in wave speed $u(x,t) = \frac{\partial q}{\partial \rho}$:

$$R(u, x, t) = \sup_{\rho} (\Phi(\rho, x, t) - u(x, t)\rho). \quad (6)$$

This cost function R , which is convex in u , is recognised as a convex conjugate or Legendre-Fenchel transformation [2] of the fundamental diagram Φ . Physically $R(u)$ can be interpreted as the maximum rate at which traffic can pass an observer moving with speed u at (x,t) . The Cauchy problem (4) and (5) can now be solved as:

$$N(x, t) = \min_{u \in U} \left\{ B \left(x_B, t - \left(\frac{x - x_B}{u} \right) \right) + \left(\frac{x - x_B}{u} \right) R(u) \right\}, \quad (7)$$

where U is the set of all admissible wave speeds in Φ . Equation (7) is known as the Lax-Hopf formula in the context of HJ partial differential equations. Mazare et al. [2] present an analytical grid-free approach for solving the Hamilton-Jacobi formulation. The grid-free analytical solution approach enables easy incorporation of internal bottlenecks, either static or dynamic, without requiring introduction of 'shortcuts' as in [1]. Furthermore, Mazare et al. can generate exact solutions for arbitrary concave fundamental diagrams without linearising them. As an illustration Figure 1 shows the density map derived from the Hamilton-Jacobi formulation. Here we consider a 1-lane road section with traffic entering at $x = 0$. A traffic signal is located at $x = 180$ (m), which starts a red phase at time $r_0 = 12$ (sec) and ends at time $r_1 = 30$ (sec). There is a bus (the thick arrowed line) entering the road from a bus stop s located at $x = 25$ (m) and time $t = 15$ (sec), and exits the road at the next bus stop $s+1$ located at $x = 230$ (m). While the bus is present and if it is obstructing the surrounding traffic in case it has a lower speed than general traffic, the maximum passing rate (relative to the bus) of traffic around the bus is given. In the figure we consider two different nominal bus speeds. In Figure 25a, the nominal bus speed (v_n^*) is taken as the same as the nominal free-flow speed (v_f) of general traffic. In Figure 1b, the nominal bus speed (v_n^*) is taken as lower than the nominal speed of general traffic (v_f) and hence the bus will act like a moving bottleneck under the free-flow condition.

Figure 19. Movement of bus under influence of signal setting and its impact on surrounding traffic

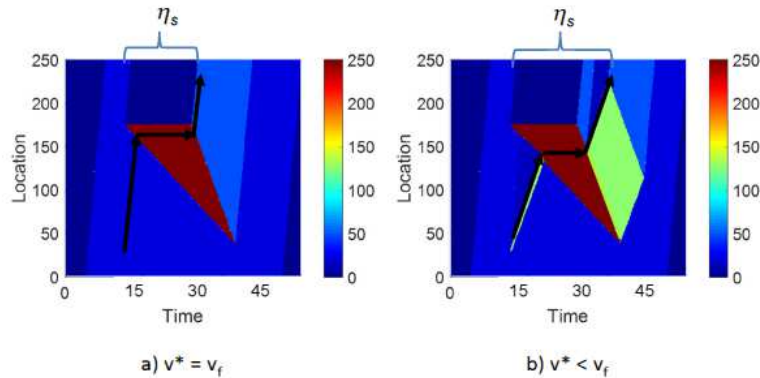

Source: Own elaborations.

This paper presents an optimal control formulation for motorway traffic with cooperative vehicles based upon this modelling framework. With the underlying Hamilton-Jacobi formulation of kinematic wave, the control framework can capture and integrate both Eulerian (macroscopic) and Lagrangian (microscopic) traffic data and quantities. Moreover, we develop a derivative based solution approach which adopts the sensitivity analysis looking at the impact on the traffic state (e.g. flow, density) distribution with respect to changes in boundary flows due to demand variations, control settings, and cooperative vehicles. We adopt a multi-objective optimisation formulation:

$$\min_{\mathbf{u}, \mathbf{h}, \mathbf{v}} Z = \sum_{j=1}^J \alpha_j Z_j(\mathbf{u}, \mathbf{h}, \mathbf{v}) \quad (8)$$

which considers J objective functions, where the notation α_j represents the weighting placed on objective function Z_j , where $j=1,2,\dots,J$, in the optimisation process. The variables $(\mathbf{u}, \mathbf{h}, \mathbf{v})$ represent respectively the control actions applied on node inflows (e.g. through ramp meters), link flow propagation (e.g. through changing fundamental diagrams by variable speed limit), and speeds of co-operative vehicles. The relationship between the control variables and the objective functions is governed by the underlying Hamilton-Jacobi formulation of kinematic wave model that captures both macroscopic (Eulerian) flows and microscopic (Lagrangian) cooperative vehicles as presented above.

Following the control formulation, the necessary conditions of optimality from which the optimal control policies are derived by Pontryagin principle (see [3]). The optimality conditions will involve prevailing values of N and c_n (i.e. trajectories of cooperative vehicles n), and derivatives of the objective functions with respect to the control variables. These derivatives will be derived by using a sensitivity analysis based upon the Lax-Hopf solution (7). With the analytical optimality conditions and derivatives, we aim to develop an analytical sensitivity-based algorithm for solving the optimal policies using a forward dynamic programming approach. The optimisation solver adjusts iteratively the control variables according to the current values of N and c_n and the derivatives such that the optimality conditions can be eventually satisfied.

References

- [1] CF, Daganzo (2005) "A variational formulation of kinematic waves: i) basic theory and complex boundary conditions; ii) solution methods". *Transportation Research Part B*, vol. 39, pp. 187-196; 934-950, 2005.
- [2] P. Mazare, et al. Analytical and grid-free solutions to the Lighthill-Whitham-Richards traffic flow model. *Transportation Research Part B*, vol. 45, pp. 1727-1748, 2011.
- [3] A. Chow, et al. Multi-objective optimal control formulations for bus service reliability with traffic signals. *Transportation Research Part B*, vol. 103, pp. 248-268, 2017.

3 Abstracts DAY 2

An overview of the agenda of Day 2 is presented below:

MFTS 2018 DAY 2 - Tuesday 12 June 2018		
09:00-10:10	Plenary Session (<i>Auditorium</i>)	
10:10-10:40	Coffee break (<i>Auditorium</i>)	
10:40-12:20	Parallel Session 3a: Modelling (<i>Auditorium</i>)	Parallel Session 3b: Projects and case-studies (<i>Building 101/1003</i>)
12:20-13:30	Lunch break and Posters Session Day 2 (<i>Building 101 Ground Floor</i>)	
13:30-15:10	Parallel Session 4a: Traffic Control with CAVs (<i>Auditorium</i>)	Parallel Session 4b: (Big) Data (<i>Building 101/1003</i>)
15:10-15:40	Coffee break (<i>Auditorium</i>)	
15:40-17:00	Parallel Session 5a: Traffic Control (<i>Auditorium</i>)	Parallel Session 5b: Traffic Management (<i>Building 101/1003</i>)
17:00-17:30	Closure of the Symposium (<i>Auditorium</i>)	

A more detailed agenda is presented next:

09:00-10:10 **Plenary Session** (Chair: C. Roncoli)

B. Ciuffo (European Commission Joint Research Centre),
U. Fugiglando (MIT, USA)

Auditorium

10:10-10:40 **Coffee break**

Auditorium

10:40-12:20 **Parallel Session 3a: Modelling** (Chair: S. Siri)

F. A. Mullakkal-Babu, P. Typaldos, S. Siri, J. Casas, M. Makridis, S. Gashaw,

Auditorium

10:40-12:20 **Parallel Session 3b: Projects and case-studies** (Chair: A. H. F. Chow)

M. Alonso Raposo, J. Vreeswijk, J. Harrod Booth, R. Akerkar, K. Mattas

Building 101/1003

12:20-13:30 **Lunch break and Posters Session Day 2** (Chair: M. Makridis, V. Punzo)

Building 101 Ground Floor

13:30-15:10 **Parallel Session 4a: Traffic Control with CAVs** (Chair: M. Wang)

K. Yang, C. Roncoli, M. Wang, A. Stevanovic, I. Cornwell

Auditorium

13:30-15:10 **Parallel Session 4b: (Big) Data** (Chair: K. Ampountolas)

E. Felici, G. Fusco, M. C. Coelho, D. Lee, F. Viti, E. Papanagiotou

Building 101/1003

15:10-15:40 **Coffee break**

Auditorium

15:40-17:00 **Parallel Session 5a: Traffic Control** (Chair: J. R. D. Frejo)

G. De Nunzio, M. TieBler, J. R. D. Frejo, V. Markantonakis

Auditorium

15:40-17:00 **Parallel Session 5b: Traffic Management** (Chair: G. Gomo)

J. Vreeswijk, E. Marlier, P. Gora, V. Cahill

Building 101/1003

17:00-17:30 **Closure of the Symposium** (B. Ciuffo, F. Viti)

Auditorium

3.1 Plenary Session

3.1.1 Cars and Cities: a Quantitative Perspective on Some Future Mobility Models

U. FUGIGLANDO^a, P. SANTI^{a,b}, C. RATTI^a

^a MIT Senseable City Laboratory, Massachusetts Institute of Technology, Cambridge MA, USA

^b Istituto di Informatica e Telematica del CNR, Pisa, Italy

The transition from traditional vehicles to autonomous vehicles (AVs) will bring several modifications to the road infrastructure, the layout of cities, the communication networks, and generally to the relationship between people, cars and city. However, even before the advent of AVs, we are witnessing to a shift from a model of owned vehicles to on-demand mobility, which will likely be fostered by the advent of AVs and progressively integrated with them. Moreover, recent advances in information and communication technologies opened the way to quantitative studies on the aforementioned phenomena and, consequently, to new solutions for urban mobility. The present contribution will focus on some recent results by the MIT Senseable City Lab in the field of future mobility paradigms.

One of the first breakthrough in the quantification on the benefit of new transportation models—specifically taxi trip sharing—is a result coming from the analysis of more than 150 million taxi trips in the city of New York [1]. Researcher showed that with a minimum discomfort for passengers (delay of few minutes with respect to the individual trip) more than 95% of the taxi trips can be shared with a reduction of more than 40% in cumulative trip lengths. This result relies on a new modelling technique called “sharability networks” that combines network science theory with traffic management and anticipates two main phenomena: the probable future reduction of the number of cars needed in a city, and the advantage of a centralized dispatching system (or a few of them).

These phenomena have been studied on the same New York taxi database, specifically characterizing the minimum number of vehicles needed to serve all the trips without incurring any delay on the passenger, even in a scenario of non-shared trips. The research [2] provides an optimal, computationally efficient solution to the problem and a nearly optimal solution that can be implemented in a real-time system, resulting in a 30% reduction in fleet size compared to the current taxi optimization. Figure 1 shows hourly and averaged fleet sizes in the current scenario and in the optimal-solution dispatching system.

Figure 20. Comparison of the actual number of New York City taxi on the road, compared to the minimum number of vehicles in the optimal solution scenario (image courtesy of the authors).

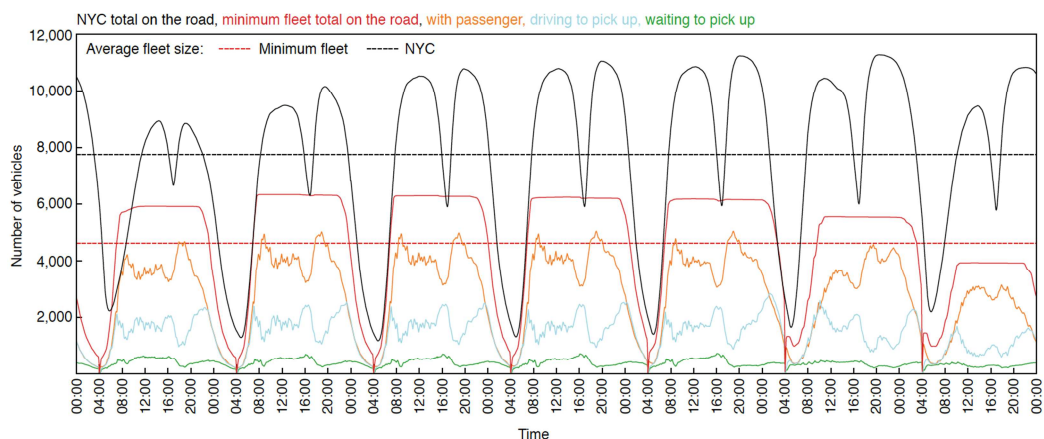

Source: courtesy of the authors of [2].

The new dispatching system is relevant as it provides an efficient solution to today's mobility model, but it could become even more valuable with tomorrow's fleets of AVs. Moreover, in order to prevent a monopolistic market by the company managing the dispatching (with lack of competition and consequent increase in prices) the study also shows that the benefits of the results still hold in an oligopolistic market.

Consequent to the reduction in size of fleets, a probable phenomenon will be the decrease in demand of parking spots in cities. The problem is multifold and has to take into account the differences in daily commuting flows, the parking spot ownership management, as well as the mobility model based on private cars, on-demand shared cars or AVs. A recent study on a real dataset of daily commutes in the city of Singapore [3] compares different mobility models and concludes estimating a 50% reduction in parking needs at the expense of an increase of less than 2% in total travelled kilometers in case of AVs fleets.

It has to be noticed, nevertheless, that the higher efficiency achieved by car-oriented mobility models might increase the total number of served people, diverting passengers from public transport services and resulting in a decrease in savings with respect to the aforementioned result. This, however, boils down to a policy problem where local administrations and policy makers could take initiatives in order to promote and prioritize certain transportation paradigms based on their political, economic and environmental agenda.

Finally, future cars can serve the city not only as means of transport, but as platforms able to sense valuable information on people, city infrastructure, and on the external environment. In fact, leveraging data acquired by in-car sensors (which are more than 2000 in current cars but will increase in AVs) through the standardized CAN bus network, it is already possible to analyze the driving behavior [4] and their interaction with the road. Moreover, beyond the well-known application of potholes detection that can map the maintenance of roads' pavement, recent studies focused on assessing the structural properties of bridges upon acceleration profiles measured with smartphones mounted on moving cars [5]. The problem of infrastructure predictive maintenance, therefore, could be addressed with low-cost measurements that can be crowdsourced by every vehicle or by specific fleets managed either by public or private companies, which could use the acquired information as a further valuable asset.

References

- [1] P. Santi, G. Resta, M. Szell, S. Sobolevsky, S. Strogatz, C. Ratti. Quantifying the benefits of vehicle pooling with shareability networks. *Proceeding of the National Academy of Sciences*, Vol. 111 (37), September 2014.
- [2] M. M. Vazifeh, P. Santi, G. Resta, S. H. Strogatz, C. Ratti. Addressing the minimum fleet problem in on-demand urban mobility. *Nature*, Vol. 557, May 2018.
- [3] D. Kondor, H. Zhang, R. Tachet, P. Santi, C. Ratti. Estimating savings in parking demand using shared vehicles for home-work commuting. *arXiv preprint*, 2017.
- [4] U. Fugiglando, E. Massaro, P. Santi, S. Milardo, K. Abida, R. Stahlmann, F. Netter, C. Ratti. Driving behavior analysis through CAN bus data in an uncontrolled environment. *arXiv preprint*, 2017. To appear on *IEEE Transactions on Intelligent Transportation Systems*.
- [5] T. Matarazzo, P. Santi, S. Pakzad, K. Carter, C. Ratti, B. Moaveni, C. Osgood, N. Jacob. Crowdsensing Framework for Monitoring Bridge Vibrations Using Moving Smartphones. *Proceedings of the IEEE*, Vol. 106 (4), April 2018.

3.2 Parallel Session 3a - Modelling

3.2.1 Submicroscopic framework to model mixed highway traffic

F. A. MULLAKKAL-BABU^a, M. WANG^a, B. VAN AREM^a, R. HAPPEE^{a,b}

^a *Department of Transport & Planning, Faculty of Civil Engineering and Geosciences, TU Delft*

^b *Department of Cognitive Robotics, Faculty of Mechanical, Maritime & Materials Engineering, TU Delft*

Introduction

The task of driving a vehicle can be hierarchically divided into three coupled levels of subtasks: strategic level (route choice); tactical level (manoeuvre planning) and operational level (control input to accomplish the manoeuvres)[1]. These subtasks are concurrently executed within the hierarchical framework to realise the vehicle trajectory. Microscopic traffic models have conventionally been used to simulate the movement of individual vehicles in traffic, and to deduce the collective performance of the traffic flow comprising several such vehicles. The microscopic models have enabled us to better understand the individual driver behaviour and effectively derive phenomenological insights; however, their representation of the driving task has been widely criticised to be over simplistic. Firstly, they depict the tactical and operational subtasks as open-loop processes; whereas in reality, there exists a closed loop interaction (to and fro information exchange) between these subtasks. Therefore they cannot model the dynamic modification of the tactical plan, such as abortion of a lane change manoeuvre. Secondly, they represent the vehicle as a point mass unit that can perfectly track the reference signal subject to static kinematic constraints. However, in reality the realised trajectory may differ from the desired trajectory due to the dynamic behaviour of the vehicle operation and due to the delays involved in cyber-physical systems. Consequently, the simulated vehicle trajectories are often unrealistic such as an instantaneous lateral jump representing a vehicle lane change. Finally, the lack of an explicit and realistic vehicle model make the microscopic models inadequate to study the performance and traceability of Driving Automation Systems (DASs) at an operational level. For instance they cannot model the in-lane lateral movement of a vehicle operating on an Automated Lane Keeping System, and they cannot accurately reproduce the trajectory of a vehicle manoeuvring on an Automated Lane Change System. Sub microscopic simulation models have been proposed to overcome these limitations; however, the existing submicroscopic simulation models solely capture the longitudinal vehicle movement [2],[7],[8] and leave out the lateral manoeuvres. To summarise, the over simplistic representation of the vehicle movement in existing microscopic models compromises their predictive validity. This presents a compelling case for the extension of the microscopic traffic modelling framework to the submicroscopic level, which can provide a high-detail description of the vehicle trajectory taking into account vehicle dynamics, driver behaviour of manually driven vehicles and control strategies of automated vehicles in highway conditions.

Model framework

This work aims to incorporate the lateral and the longitudinal manoeuvres into the traffic modelling framework and thereby formulate a submicroscopic traffic model. Figure 1 shows the hierarchical modelling framework with an upper tactical decisions layer, and a lower operational actions layer. However certain tactical decisions, such as a lane change, might be altered during the operational actions, and we therefore include a two-directional information flow between the operational and the tactical layer. The submicroscopic simulation model is implemented in MATLAB with an update time step of 0.1s.

Tactical layer

At the tactical layer we build upon the lane change decision model-Lane change Model with Relaxation and Synchronisation (LMRS)[5]. We extend LMRS to include two elementary lateral manoeuvres that are empirically observed among HDVs: Lane-keeping and Lane Change. The lane change manoeuvre is modelled as a multi-step process requiring feedback from the operational layer, so as to decide whether to proceed or abort a lane change. The time headway to be maintained w.r.t the preceding vehicle and the desired speed are regarded as the longitudinal tactical decisions.

Figure 21. The framework of submicroscopic simulation

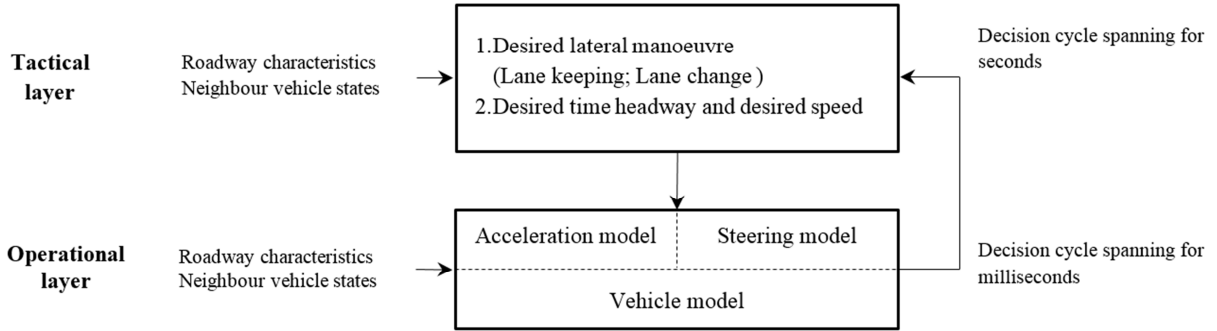

Source: Own elaborations.

Operational driver model and vehicle dynamics

The tactical decisions are operationalised via two loosely coupled operational decision models: an acceleration model and a steering model. They jointly generate a reference trajectory, which is the time series of desired longitudinal acceleration (u_x) and desired front steering angle (θ_f), to be followed by the vehicle. Thereafter the reference trajectory is passed on to the vehicle model that updates the vehicle state: longitudinal position (x), lateral position (y) and yaw angle (ψ). The vehicle model is chosen so as to describe the vehicle movement with a level of detail high enough to reproduce the collective traffic impact and low enough to avoid irrelevant system state information. In the longitudinal dimension, the reference acceleration is executed with a delay (perception time) and implemented with a lag: response time, τ . However, the actual acceleration (a_x) is constrained by limits of tyre force friction and powertrain. The longitudinal vehicle position (x) and velocity (v_x) and actual longitudinal acceleration (a_x) is manipulated by control input – desired acceleration (u_x) based on the following third order model

$$\frac{d}{dt} \begin{Bmatrix} x \\ \dot{x} \\ \ddot{x} \end{Bmatrix} = \begin{Bmatrix} v_x \\ a_x \\ \frac{a_x - u_x}{\tau} \end{Bmatrix} \quad (1)$$

In the lateral dimension, we use the classical dynamic bicycle model [6] assuming a linear relation between lateral tyre force and slip angle, which is reasonable for the typical highway conditions [7]. Accordingly, the lateral vehicle position (y) and orientation (ψ) is manipulated by front steering (θ_f) as shown in equation 2.

$$\frac{d}{dt} \begin{Bmatrix} y \\ \dot{y} \\ \psi \\ \dot{\psi} \end{Bmatrix} = \begin{bmatrix} 0 & 1 & 0 & 0 \\ 0 & -\frac{2C_{\alpha f} + 2C_{\alpha r}}{mv_x} & 0 & -V_x - \frac{2l_f C_{\alpha f} - 2l_r C_{\alpha r}}{mv_x} \\ 0 & 0 & 0 & 1 \\ 0 & -\frac{2l_f C_{\alpha f} - 2l_r C_{\alpha r}}{I_z v_x} & 0 & -\frac{2l_f^2 C_{\alpha f} + 2l_r^2 C_{\alpha r}}{I_z v_x} \end{bmatrix} \begin{Bmatrix} y \\ \dot{y} \\ \psi \\ \dot{\psi} \end{Bmatrix} + \begin{Bmatrix} 0 \\ \frac{2C_{\alpha f}}{m} \\ 0 \\ \frac{2l_f C_{\alpha f}}{I_z} \end{Bmatrix} \theta_f \quad (2)$$

where l_f, l_r represents the distance of point front and rear tire from the Centre of Gravity; m denotes the physical mass of the vehicle; $C_{\alpha f}, C_{\alpha r}$ denotes the cornering stiffness of front and rear tire, I_z denotes the moment of Inertia about the z-axis.

Figure 22. An example submicroscopic simulation of an automated lane change manoeuvre with: duration 5.1 s; lateral displacement 3.31m; average longitudinal velocity 15 m/s; reference LC trajectory is based on sinusoidal lateral acceleration; and the steering signal is generated by the lower level controller (combining state feedback and feedforward term). (a) simulated trajectory, (b) curvature of the reference trajectory, (c) reference and achieved yaw angle, (d) steering input and corresponding state feedback and feedforward, (e) vehicle lateral acceleration profile, (f) vehicle lateral velocity profile

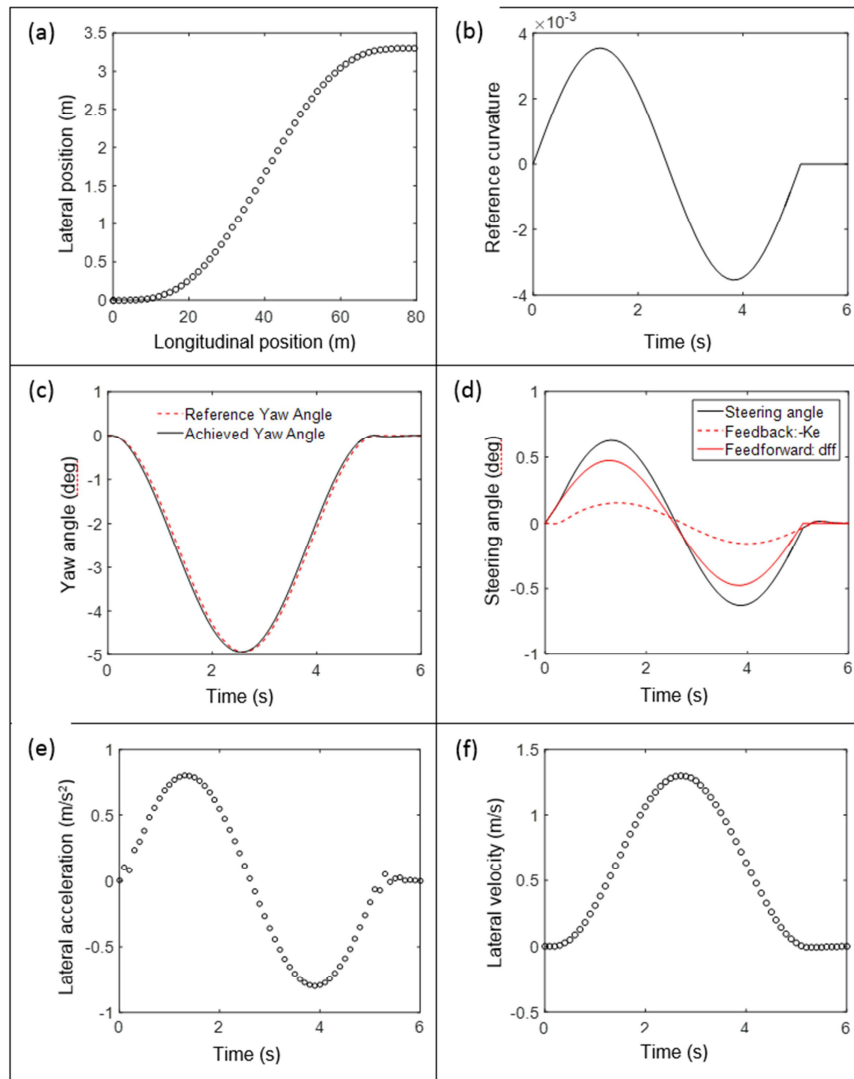

Source: Own elaborations.

Case study

An example simulation of automated lane change manoeuvre is shown in Figure 2. Similarly, we deploy the proposed submicroscopic simulation framework to evaluate few representative automated lane change control strategies. The experiment scenario is a straight 4 lane highway with a lane - drop at the downstream resulting in a 3 lane end stretch. In this experiment, the automated lane change controller performs the mandatory lane change while approaching the lane drop. The comparison is done in terms of the following measures: traceability of the reference trajectories; the comfort of the manoeuvre; safety of the manoeuvre; impact on the neighbouring vehicles; and efficiency of the overall traffic flow.

Summary

We proposed a hierarchical submicroscopic simulation framework in which the lower operational layer consists of a separate driver behavioural and a vehicle model. In comparison to the conventional traffic models, the proposed framework can simulate the vehicle trajectory with a higher level of detail and better mimic the functioning of DAS controllers.

References

- [1] J. Michon, "A critical view of driver behavior models: what do we know, what should we do?," *Hum. Behav. traffic Saf.*, pp. 485–520, 1985.
- [2] J. Ludmann, D. Neunzig, and M. Weilkes, "Traffic Simulation with Consideration of Driver Models, Theory and Examples," *Veh. Syst. Dyn.*, vol. 27, no. 5–6, pp. 491–516, 1997.
- [3] P. Kumar, R. Merzouki, B. Conrard, V. Coelen, and B. O. Bouamama, "Multilevel Modeling of the Traffic Dynamic," vol. 15, no. 3, pp. 1066–1082, 2014.
- [4] S. P. Hoogendoorn and P. H. L. Bovy, "State-of-the-art of vehicular traffic modelling," *Proc. Inst. Mech. Eng. Part F J. Rail Rapid Transit*, vol. 215, pp. 283–303, 2001.
- [5] W. J. Schakel, V. L. Knoop, and B. Van Arem, "Integrated Lane Change Model with Relaxation and Synchronization," *Transp. Res. Rec.*, no. 2316, pp. 47–57, 2012.
- [6] R. Rajamani, *Vehicle Dynamics and Control*, 2nd ed. New York: Springer Science & Business Media, 2011.
- [7] D. E. Smith and J. M. Starkey, "Effects of Model Complexity on the Performance of Automated Vehicle Steering Controllers: Model Development, Validation and Comparison," *Veh. Syst. Dyn. Int. J. Veh. Mech. Mobil.*, vol. 24, no. 2, pp. 163–181, 1995.

3.2.2 Minimization of Fuel Consumption for Vehicle Trajectories

P. TYPALDOS^a, I. PAPAMICHAIL^a, M. PAPAGEORGIOU^a

^a *Dynamic Systems and Simulation Laboratory, School of Production Engineering & Management, Technical University of Crete, 73100, Chania, Greece*

Reduction of energy and fuel consumption by road vehicles has gained high importance due to the related reduction of emissions, among other reasons. The current trend towards increased mobility seems sometimes to run counter to the purposes of controlling the greenhouse effect, local pollution and the efficient usage of fuel resources; as a result, vehicle fuel consumption has become a crucial issue. Intensive research has been carried out in order to find related optimal solutions for a number of possible settings.

The problem considered in this work is a typical case of a fuel consumption minimization problem, where a vehicle starts from a given initial state and must reach a given final state within a fixed time horizon. The objective for the vehicle is to appropriately adjust its acceleration in order to achieve the minimum possible fuel consumption, while satisfying the initial and final conditions. The fuel consumption model used for the estimation of the vehicle's fuel consumption rate is the Australian Road Research Board (ARRB) model (or Energy-Related model), which estimates instantaneous values of fuel consumption from second-by-second speed and grade information [1, 2]. The minimization problem is formulated as an optimal control problem, where the state equations reflect the simple vehicle kinematic equations for position and speed, with the acceleration acting as a control input. Initial and final states (position and speed) are fixed.

As a first approach, a simplified version of the optimal control problem is solved analytically. In order to enable the analytic solution, one may approximate the fuel consumption function with a quadratic function. The quadratic approximation can be achieved through a Taylor expansion, approximating the fuel consumption function around a given point. The approximate fuel consumption optimal control problem considers the minimization of the approximated quadratic fuel consumption subject to the state equations of vehicle motion, with fixed initial and final states. The quadratic cost criterion leads to smooth variations of the states and the control over time. For the sake of simplicity in the form of the optimal solution, no constraints are considered for the state and control variables. Such constraints would limit the speed between zero and its maximum value; and the acceleration between its minimum and maximum values. It should be noted that the numerical solution for the corresponding constrained optimization problem is also easy to obtain via efficient quadratic programming solvers.

It is important to note that a special case of the above quadratic approximation, that is often used (e.g. [3]) as a proxy for fuel consumption minimisation, is the consideration of the mere square-of-acceleration as an objective function to be minimised. This cost function is often used as a surrogate of fuel consumption, on the grounds that there is a positive correlation between acceleration and fuel consumption.

The analytic solution of optimal control problems by use of the necessary conditions of optimality is only possible for simple problems, e.g. problems with low dimension or problems with special structure (e.g. Linear-Quadratic Optimization); otherwise, numerical solution algorithms are required for the calculation of the optimal trajectories. For the purposes of this work, a very efficient feasible direction algorithm has been used [4], which exploits the notion of reduced gradient to eliminate the state variables and solve the problem in the space of the control variables. It is noted that the ARRB fuel consumption formula is a continuous, but non-smooth function, since it features discontinuous first-order derivatives when the value of the total force of the ARRB function is equal to 0. This may lead to difficulties when using gradient-based optimization methods. Hence, a smooth nonlinear cost function that is differentiable everywhere in its domain is used to approximate arbitrarily closely the ARRB formula using known techniques [5].

Several scenarios have been investigated, with different initial and final conditions [6]. The results obtained from all the solution approaches are very satisfactory, while the percentage difference of fuel consumption between them was found to be minor or even negligible. Specifically, the comparison of the resulted trajectories obtained for different time horizons shows that: (i) for limited time horizons, the square-of-acceleration approach and the numerical approach (with the full nonlinear smooth ARRB fuel consumption formula) give almost the same trajectories; as the time horizon increases, the trajectories differ, but the percentage difference of the fuel consumption values resulting from the two approaches is still less than 1.3 %.

To assess the significance of such low differences in fuel consumption, one needs to explore the range of possible fuel consumption values, while driving the vehicle from the given initial state to the given final state. To this end, we also considered the fuel consumption maximization problem and compared the resulted fuel consumption with that of the minimization problem. The value range of the fuel consumption, i.e. the percentage difference of the two obtained solutions was found to be large (220% in the scenario examined). This implies that the presented fuel consumption approximation approaches are highly efficient and may indeed be used as surrogates in place of the accurate ARRB formula within optimal control problems to derive fuel-efficient vehicle trajectories.

In summary, this work delivers two main contributions:

- It proposes a highly efficient (fractions of a second) numerical approach for the solution of the accurate fuel minimization problem.
- It demonstrates that simpler approaches deliver excellent approximations of the accurate solution.

Acknowledgement

This work was supported by the European Research Council under the European Union's Seventh Framework Programme (FP/2007-2013) within the Project TRAMAN21 under Grant 321132.

References

- [1] Akçelik, R., & Biggs, D. C. (1987). Acceleration profile models for vehicles in road traffic. *Transportation Science*, 21(1), 36-54.
- [2] Bowyer, D. P., Akçelik, R., & Biggs, D. C. (1985). Guide to fuel consumption analyses for urban traffic management, Special Report SR No. 32. ARRB Transport Research Ltd, Vermont South, Australia.
- [3] Hong, S., Malikopoulos, A., Lee, J. (2017). Development and Evaluation of Speed Harmonization Using Optimal Control Theory: Simulation-Based Case Study at a Speed Reduction Zone. Proceedings of the 96th Annual Meeting of the Transportation Research Board (TRB), Washington, D.C., USA, paper no. 17-05828.
- [4] Papageorgiou, M., Marinaki M., Typaldos P., & Makantasis K. (2016). A feasible direction algorithm for the numerical solution of optimal control problems - Extended Version. *Dynamic Syst. Simulation Lab.*, Tech. Univ. Crete, Chania, Greece.
- [5] Jamshidnejad, A., Papamichail, I., Papageorgiou, M., & De Schutter, B. (2017). Sustainable model-predictive control in urban traffic networks: Efficient solution based on general smoothening methods. *IEEE Transactions on Control Systems Technology*, to appear (doi: 10.1109/TCST.2017.2699160).
- [6] Typaldos, P., Papamichail, I., & Papageorgiou, M. (2018). Minimization of fuel consumption for vehicle trajectories. Proceedings of the 97th Annual Meeting of the Transportation Research Board (TRB), Washington, D.C., USA, paper no. 18-03953.

3.2.3 Reduction of travel times and expected number of crashes in freeway traffic systems

C. PASQUALE^a, S. SACONE^a, S. SIRI^a, M. PAPAGEORGIOU^b

^a *Department of Informatics, Bioengineering, Robotics and Systems Engineering, University of Genova, Italy*

^b *Dynamic Systems and Simulation Laboratory, Technical University of Crete, Greece*

Most of the traffic management tools developed in the last decades have been devoted to congestion reduction and prevention. Hence, traffic control algorithms for freeway networks have considered the minimization of congestion and total travel delays in the system as main goals [1-2]. Even though traffic congestion is clearly a serious issue for the mobility needs of citizens, it represents only one of the criticalities caused by the growth of traffic demand. Traffic control tools can then be applied to produce other benefits, such as the reduction of fuel consumptions and traffic emissions, as well as the improvement of traffic safety.

Freeways can be controlled in different ways, and, among the different control strategies, ramp metering is one of the most widespread solutions, regulating the access to the mainstream through traffic signals installed at the on-ramps [3]. Several ramp metering strategies have been proposed in the literature with the aim of reducing congestion, ranging from simple feedback control rules to sophisticated optimization-based control schemes [4-6]. More recent studies on ramp metering aim at minimizing the environmental impact, by reducing traffic emissions or fuel consumption [7-8].

In addition to environmental factors, another relevant issue to be considered in traffic control schemes is related to traffic safety, as it is presented in this work. It is widely recognized that traffic incidents are one of the primary causes of non-recurrent congestion: in case of accidents, the congestion occurs both because of the capacity reduction caused by the interruption of one or more lanes and because of the slowdowns of drivers [9]. On the other hand, the quantitative implications of congestion on road safety are less evident and only few studies are focused on the quantitative evaluation of safety in freeways. Among them, [10-11] correlate traffic conditions with the occurrence of road accidents, [12-13] investigate the crash likelihood as a function of traffic flow, [14] proposes a density-versus-safety relationship, [15-16] analyze the occurrence of crashes as a function of both traffic flow and density. The idea of explicitly considering safety aspects in the development of appropriate control measures has been considered by a limited number of studies, such as [17] for route guidance, [18] for variable speed limits, [19-20] for ramp metering.

The present work addresses the problem of controlling freeway traffic systems with coordinated ramp metering, in order to reduce travel times for the drivers and to improve traffic safety conditions. Specifically, the main objective concerns the investigation of a possible conflicting behavior between the minimization of the expected number of crashes and the minimization of the total time spent by the drivers in the network. In order to evaluate the safety level depending on the traffic conditions, the safety-versus-density relation developed in [14] is adopted, whereas the traffic behavior is modeled with the macroscopic second-order METANET model [21]. In this work, new safety indices are proposed for the mainstream and for the on-ramps in order to compute the expected number of crashes. The coordinated ramp metering control strategy is sought by solving a discrete-time nonlinear optimal control problem in which the objective function to be minimized is a weighted sum of the total time spent and the expected number of crashes. The nonlinear structure of the problem is due to the nonlinear state equations and the nonlinear safety-related cost function. The optimal control problem is solved by applying the feasible direction algorithm in the specific version adopting the derivative backpropagation method RPROP [22].

References

- [1] M. Papageorgiou, C. Diakaki, V. Dinopoulou, A. Kotsialos and Y. Wang. Review of road traffic control strategies. In *Proc. of the IEEE*, 91, 2043–2067, 2003.
- [2] A. Hegyi, T. Bellemans and B. De Schutter. Freeway traffic management and control. In *Encyclopedia of Complexity and Systems Science*, ed. by R.A. Meyers, 3943-3964, Springer, 2009.
- [3] M. Papageorgiou and A. Kotsialos. Freeway ramp metering: an overview. In *IEEE Transactions on Intelligent Transportation Systems*, 3, 271–281, 2002.
- [4] M. Papageorgiou, H. Hadj-Salem and J.M. Blosseville. ALINEA: A local feedback control law for on-ramp metering. In *Transportation Research Record*, 1320, 58–64, 1991.
- [5] A. Hegyi, B. De Schutter and H. Hellendoorn. Model predictive control for optimal coordination of ramp metering and variable speed limits. In *Transportation Research Part C*, 13, 185–209, 2005.
- [6] A. Ferrara, S. Sacone and S. Siri. Event-triggered model predictive schemes for freeway traffic control. In *Transportation Research C*, 58, 554–567, 2015.
- [7] S.K. Zegeye, B. De Schutter, J. Hellendoorn, E.A. Breunese and A. Hegyi. Integrated macroscopic traffic flow, emission, and fuel consumption model for control purposes. In *Transportation Research C*, 31, 158–171, 2013.
- [8] C. Pasquale, S. Sacone, S. Siri and B. De Schutter. A multi-class model-based control scheme for reducing congestion and emissions in freeway networks by combining ramp metering and route guidance. In *Transportation Research Part C*, 80, 384–408, 2017.
- [9] I.B. Potts, D.W. Harwood, J.M Hutton, C.A. Fees, K.M. Bauer, L.M. Lucas, C.S. Kinzel and R.J. Frazier. Identification and evaluation of the cost-effectiveness of highway design features to reduce nonrecurrent congestion. In *SHRP 2 Report S2-L07-RR-1*, 2013.
- [10] J. W. Hall and O.J. Pendleton. Rural accident rate variations with traffic volume. In *Transportation Research Record*, 1281, 62–70, 1990.
- [11] T.M. Zhou and V.P. Sisiopiku. Relationship between volume-to-capacity ratios and accident rates. In *Transportation Research Record*, 1581, 47–52, 1997.
- [12] G. L. Chang and H. Xiang. The relationship between congestion levels and accidents. Maryland State Highway Administration, Baltimore, United States, 2003.
- [13] T.T.F. Golob, W. Recker, Y. Pavlis. Probabilistic models of freeway safety performance using traffic flow data as predictors. In *Safety science*, 46.9, 1306–1333, 2008.
- [14] I.B. Potts, D.W. Harwood, C.A. Fees, K.M. Bauer, and C.S. Kinzel. Further development of the safety and congestion relationship for urban freeways. In *SHRP 2 Report S2-L07-RR-3*, 2015.
- [15] D. Lord, A. Manar and A. Vizioli. Modeling crash-flow-density and crash-flow-V/C ratio relationships for rural and urban freeway segments. In *Safety science*, 37.1, 185–199, 2005.
- [16] J. Kononov, C. Lyon and B.K. Allery. Relation of flow, speed, and density of urban freeways to functional form of a safety performance function. In *Transportation Research Record*, 2236.1, 11–19, 2011.
- [17] B. Abdulhai and H. Look. Impact of dynamic and safety-conscious route guidance on accident risk. In *Journal of transportation engineering*, 129.4, 369–376, 2003.

- [18] C. Lee, B. Hellinga and F. Saccomanno. Evaluation of variable speed limits to improve traffic safety. In *Transportation research part C*, 14.3, 213–228, 2006.
- [19] H.H. Salem, N. Farhi, and J.P. Lebacque. Application of multi-objective nonlinear optimization technique for coordinated ramp-metering. In *Proc. of the AIP Conference*, 1648, 2014.
- [20] C. Pasquale, D. Anghinolfi, S. Saccone, S. Siri, and M. Papageorgiou. A two-class traffic control scheme for reducing congestion and improving safety in freeway systems. In *Proc. of 19th IEEE Conference on Intelligent Transportation Systems*, 1767–1772, 2016.
- [21] A. Messner and M. Papageorgiou. METANET: A macroscopic simulation program for motorway networks. In *Traffic Engineering & Control*, 31: 466–470, 1990.
- [22] M. Papageorgiou and A. Kotsialos. Nonlinear optimal control applied to coordinated ramp metering. In *IEEE Transactions on Control Systems Technology*, 12, 920–933, 2004.

3.2.4 Holistic approach for simulation of CAVs environment

J. ARGOTE^a, J. CASAS^a, T. DJUKIC^a, A. LENOZER^a, P. RINELLI^a

^a *Aimsun S.L.*

Transport authorities at all levels, from federal to local, are exploring the implications of paradigm shifts in mobility and transport imposed by evolution of Connected and Autonomous Vehicles (CAVs) within their planning scopes. This effort will in turn involve the participation of consulting and engineering firms as well as traffic simulation developers, who play a key role in providing the necessary tools and techniques to assess the implications of CAVs. Thus, this paper assesses the readiness of the existing traffic simulation software for modelling CAVs and proposes a holistic approach in traffic simulation modelling.

Traffic simulation modeling have been established as a powerful tool to represent complex system dynamics and implications of advanced transport solutions. Since their inception during the 80s and 90s, these simulation tools have played a key role in assessing the effects of Intelligent Transport Systems, guiding authorities on how to better allocate their funding. Simulation played, and still plays, a key role in understanding the potential benefits of new infrastructure designs and impact of transport management solutions, such as electronic road pricing systems, variable speed limit or dynamic ramp metering.

Further, the current traffic simulation tools exhibit a serious limitations due to their initial architecture design and used mathematical models to mimic traffic behavioral aspects. For example, traditional microscopic traffic simulation software represents an architecture design based on universal models. These models, such as the car-following or lane-changing, are applied to all vehicles in the simulation, irrespective of their type. Behavioral variability across vehicle types is then obtained by tweaking individual model parameters or by using distinct distributions for those parameters, be it the vehicle size, desired acceleration or deceleration, desired speed, aggressiveness, etc. As a result, the kinematic, physical and behavioral aspects were integrated into a single mathematical model. Traditionally, this approach was sufficient to evaluate transport system at more aggregated level, which was the initial application domain of these simulation tools.

However, the advanced traffic solutions for transport safety, emissions and fuel consumption assessment, require to shed light on the underlying realism of individual vehicle trajectories. The domain of individual vehicle behavior is characterized by a high degree of complexity and diversity of perspectives, and existing traffic simulation tools are confronted with the challenge of formulating a simulation model that captures this complexity at finer level of detail, but in systematic manner. The need for more detailed traffic simulation models is becoming even more essential with the arrival of CAVs, where one of the major applications would be their safety assessment. Furthermore, multi-paradigm modeling of CAVs effects requires from traffic simulation models to operate at two extremes of use cases: a) cost-benefit analysis of technology deployment for transport planning and transport management, and b) cost-benefit analysis of new technology where the main aspect is safety. Both use cases have completely opposite requirements, where, for example, use case a) may have strong computational time constraints and case b) may require a high-fidelity representation of the reality. One way to tackle such a complexity of new transport system is to apply holistic approach in development of simulation models.

In this paper, we propose a modular simulation framework based on holistic approach that relies on a new architecture of the traffic simulation models. The main functionalities captured by this framework are:

- (a) the paradigm of the simulation models is based on the concept of: perception-planning and execution, already present in the robotics systems;
- (b) the vehicle dynamics are decoupled from the behavioral models or actuators;

- (c) the V2X communication is integrated into the perceptions modules;
- (d) emulation of external controllers or actuators is provided by original equipment manufacturers (OEM);
- (e) simulates various representation of communication channels, between V2X and V2V (from the physical layer of communication to the application layer);
- (f) simulates all type of agents involved (pedestrians, bikes, etc.); and
- (g) emulates the new transport management systems, both private or public.

Design of the proposed holistic approach for traffic simulation will be demonstrated for two on-going research projects: a) Flourish, that shows modelling of the V2X communication combined with traffic management based on routing, and b) C-ROADS Spain, that shows the application of V2X implementing C-ITS services.

3.2.5 MFC acceleration model – Simulating the vehicle dynamics

M. MAKRIDIS^a, G. FONTARAS^b, B. CIUFFO^c, K. MATTAS^d

^a Directorate for Energy, Transport and Climate, European Commission – Joint Research Centre, Via E. Fermi, 2749 – 21027 Ispra (VA), Italy

Car-following models try to explicitly reproduce the complex dynamics governing the actions of the driver-vehicle system while the driver is following another vehicle. New models are constantly proposed and various sources provide reviews on the topic [1]–[3]. In microsimulation software, the majority of the car-following models does not result in realistic acceleration profiles per individual vehicle. Most of them use a set of equations that do not manage to capture the dynamics of the vehicle. The vehicle, the driver and the road conditions are modeled in a deterministic way. Usually, any particularities on the driver profile or the gear shifting or any other factor are aggregated on a normal distribution error value which is appended to the acceleration output of the model. It is easy to observe that most models are based on the assumption that for a given start-desired speed all vehicles/drivers give the same response, which is also false. Finally, calibration of the models' parameters can lead to parameters over-fitting which usually does not have a clear physical interpretation and the corresponding parameter set is not capable to perform well on unpredictable conditions.

Besides the above-mentioned known limitations, traffic simulation models are frequently used to assess the effectiveness of many types of technologies and little or no discussion is usually made on the robustness of such estimations (see for example [4]–[6]). In the literature detailed and well-calibrated emissions models are directly integrated with traffic models under the false assumption that the car-following models, which are used to simulate the power required by the vehicle to move, were able to accurately reproduce the actual vehicle dynamics. In all these cases, the integration lacks a key component, the driver model. Not similar to car-following models, driver models has indeed the role to explicitly represent activities such as steering, gear-changing or break- and accelerator-pedal control. All these actions have a very strong impact on the fuel consumption and emissions and without considering, at least to the extent possible, these aspects, the entire effort of integrating the different models loses part of its meaning.

The present paper proposes an acceleration model (MFC) that is based on two calibratable parameters, gear shifting style and driver style. Both elements are very important particularly for the assessment and accurate estimation of the energy demand and efficiency of a transport system, comprised by a fleet of vehicles that can be diverse both in terms of size (small, medium, large light duty vehicles) and characteristics (hatchbacks, station wagons, pick-ups) but also propulsion and driving technology (hybrids, electric, automated vehicles etc). MFC is based on information such as the full load curve of the vehicle's powertrain and publicly available vehicle characteristics, when available, or empirical models where more detailed information is not available. MFC's main innovation is that both driver acceleration willingness and gear-shifting style are taken into account using a willingness-to-accelerate function as well as a gear shifting style function. Another point of novelty of the model is that it can be calibrated offline, it is simple to implement and has low computational cost.

For the model development and validation a series of measured data was necessary. Collection of free-flow speed-acceleration data in the field is difficult due to the inability to avoid interactions with other vehicles and the presence of substantial measurement errors. In order to overcome this, a laboratory experiment was conducted in the Vehicle Emission Labs (VELA) at the DG JRC of the European Commission.

The proposed model splits the vehicle's acceleration output in three different layers of functionality;

— The willingness to accelerate of the driver

- The gear shifting strategy of the driver (if manual) or the vehicle (if automatic)
- The acceleration potential of the vehicle.

The third layer of the MFC model is the computation of the vehicle's acceleration curve. The acceleration model is based on the calculation of the acceleration potential of the vehicle per each gear at a given velocity. In Figure 29a the three sets of forces are presented while in the Figure 23b the maximum acceleration and the acceleration potential for three different W2A values are displayed.

Figure 23. (a) Forces applied and (b) acceleration curves for various values of GSS and DS parameters

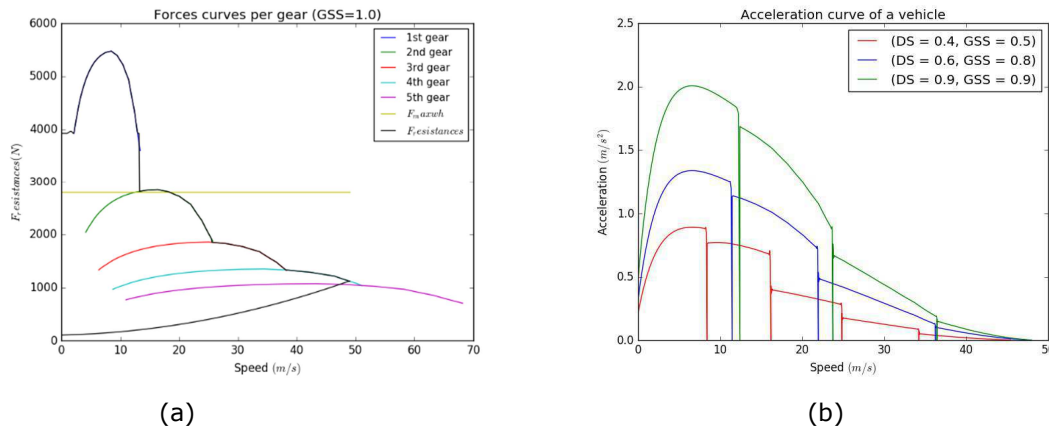

Source: Own elaborations.

The proposed MFC model has similar performance with known car-following models in terms of root mean square error in the simulated acceleration but contributes vastly in improving the accuracy when simulating the energy demand of the vehicle. More specifically, the MFC was compared with Gipps on 178 acceleration tests in total, which correspond to 66km distance traveled and the MFC underestimated the positive energy demand by 0.75%, while Gipps underestimated the same metric by 13.57%.

The advantages of MFC can be summarized as follows:

- Takes into account vehicle dynamics without dramatically increasing the computational complexity;
- In contrast to traditional car-following model it simulates with high accuracy the energy profile of a trajectory;
- Proposes a novel W2A function for the driver instead of adopting the traditional horizontal approach;
- Proposes a gear shifting strategy as an intermediate layer between the driver style and potential of the vehicle;
- Validates that vehicle dynamics play a very important role in problems where simulation of the energy profile is needed;

References

- [1] M. Brackstone and M. McDonald, "Car-following: a historical review," *Transp. Res. Part F Traffic Psychol. Behav.*, vol. 2, no. 4, pp. 181–196, Dec. 1999.
- [2] D. Helbing, "Traffic and related self-driven many-particle systems," *Rev. Mod. Phys.*, vol. 73, no. 4, pp. 1067–1141, Dec. 2001.
- [3] B. Cao and Z. Yang, "Car-Following Models Study Progress," in *2009 Second International Symposium on Knowledge Acquisition and Modeling*, 2009, vol. 3, pp. 190–193.

- [4] E. Jeong, C. Oh, and G. Lee, "Emission evaluation of inter-vehicle safety warning information systems," *Transp. Res. Part Transp. Environ.*, vol. 41, pp. 106–117, Dec. 2015.
- [5] M. Madireddy *et al.*, "Assessment of the impact of speed limit reduction and traffic signal coordination on vehicle emissions using an integrated approach," *Transp. Res. Part Transp. Environ.*, vol. 16, no. 7, pp. 504–508, Oct. 2011.
- [6] H. Abou-Senna and E. Radwan, "VISSIM/MOVES integration to investigate the effect of major key parameters on CO2 emissions," *Transp. Res. Part Transp. Environ.*, vol. 21, pp. 39–46, Jun. 2013.

3.2.6 Modeling mixed flow of two-wheelers and cars in Lagrangian coordinates

S. GASHAW^a, J. HÄRRI^a, P. GOATIN^b

^a EURECOM, 06904 Sophia Antipolis, France

^b Inria Sophia Antipolis Méditerranée, Université Côte dAzur, Inria, CNRS, LJAD, 06904 Sophia Antipolis, France

In response to the ever increasing road congestion there is a growing use of Powered Two Wheelers (PTWs). PTW commuters enjoy the advantage offered by PTWs unique dynamics such as filtering through congested passenger cars. The shift to PTWs has a perceived benefit on improving mobility. However, the effect of PTWs on the traffic flow is left unexplored. The atypical moving pattern of PTWs in conjunction with their interaction with passenger cars creates complex traffic flow characteristics. Understanding them is an indispensable step toward devising any transport solutions be it traffic safety systems, traffic management plans, traffic policies, or cooperative intelligent transport system (C-ITS) technologies. The currently available traffic models are unfit for the purpose of studying traffic features in flows involving cars and PTWs due to the big divergence between the assumption in the models and the traffic properties in mixed flow of cars and PTWs.

In recent work, we proposed a multi-class kinematic traffic flow model for a mixed flow of cars and PTWs [1]. The model is formulated following the Eulerian approach. In this paper, we provide Lagrangian formulation of the model and numerical schemes to solve the continuity equation. Lagrangian representation is more prominent than Eulerian, particularly for the flexibility and accuracy to reproduce different traffic characteristics in the real world (for instance moving bottlenecks, vehicle platoons, vehicle trajectory). In addition, the natural resemblance of Lagrangian representation to road traffic data collection methods (probe vehicles) renders it suitable for applications such as traffic motoring. Examples that illustrate the advantage of the Lagrangian approach are presented.

Using the Lagrangian representation of the model, we examine the impacts of PTWs on traffic delay. This is done through the analysis of shock-wave and vehicles trajectory. The objective of the impact analysis is to give an insight on what kind of traffic management plans should be employed for mixed flow of cars and PTWs. Hence, traffic control strategies that should be imposed on PTWs to minimize traffic delay and ensure traffic flow stability are outlined.

References

[1] Gashaw, S.M., Goatin, P. and Härrri, J., (2018, April). Modeling and analysis of mixed flow of cars and powered two wheelers, *Transportation Research Part C: Emerging Technologies*, Volume 89, Pages 148-167

3.3 Parallel Session 3b - Projects and case-studies

3.3.1 Economic implications of the transition to a Cooperative, Connected and Automated Mobility (CCAM)

M. ALONSO RAPOSO^a, M. GROSSO^a, J. KRAUSE^a, A. MOURTZOUCOU^a, B. CIUFFO^a

^a *European Commission Joint Research Centre*

Together with electrification, vehicle connectivity and automation will act as disruption factors in road transport, bringing substantial changes to a sector that has remained essentially unchanged (at least from a conceptual point of view) since the first half of the twentieth century, when the automobile became mass produced. In particular, vehicle connectivity and automation will boost a paradigm change in mobility use towards the adoption on a large scale of Mobility-as-a-Service (MaaS) travel options, which might put at risk the traditional car ownership business model. Given the central role of mobility in our society and economy, the implications of a transformation in the transport sector will not be limited to transport and mobility but will reach many other aspects of our society like public health or land use. Yet uncertainty in predicting the implications of these changes remains high, especially given the intrinsic complexity of our social and economic systems.

The term Cooperative, Connected and Automated Mobility (CCAM) illustrates the concept of a future mobility in which all the actors are connected and able to communicate and cooperate in a seamless and automated way. In this context, the objective of the present study is to analyse the possible implications of CCAM on the European society and economy. It builds upon different scenarios and tries to define the main impacts in different sectors using a combined qualitative-quantitative approach, based on existing studies and data.

The results from this study have revealed that CCAM is expected to provide profitable opportunities for sectors like automotive, electronics and software, telecommunication, data services, digital media and freight transport; mostly as a consequence of increased vehicle sales, data exchanges and services, and more efficient transport operations. However, sectors like insurance and maintenance and repair are identified as businesses that might suffer important decreases in revenues in the future, especially as a result of decreased accidents. Although new revenue opportunities are also expected to appear, the overall long term effect is expected to be negative in these sectors. The effects will go far beyond the automotive sector, into sectors like logistics, insurance, and more, eventually reaching sectors like health, construction, and land development, among others. Figure 24 shows the current state of the sectors that are most likely to be affected by CCAM, including their relative size within the present EU-28 economy.

Overall, the global impacts of CCAM on the economy and society are expected to be positive. To reap benefits, it becomes crucial to anticipate the needs that come along with new business opportunities and workforce evolution. Policymakers and industry players in Europe shall seize the opportunity of capturing these benefits within the EU by adopting different measures. The findings presented in this study contribute to the ongoing debate on the type and magnitude of potential impacts of CCAM on our economy and society.

Although the scenarios analysed do not represent a forecast of impacts, they help to illustrate a set of possible effects that could drive fundamental changes in different sectors of our economy and society. Results of this initial assessment, corroborated by additional data, will be used as input to a more thorough study where the different elements identified at this stage will be integrated in a modelling framework able to handle the dynamics and the causal loops intrinsic to the European economy.

An overview of the expected direction of change in each of the sectors is given in Table 2.

Figure 24. Current state of the main sectors affected by CCAM, showing 2015 figures on Value Added (VA), persons employed and share of Gross Value Added (GVA) in the total EU-28 (Source: Own elaborations, based on 2015 data from Eurostat SBS and NA databases)

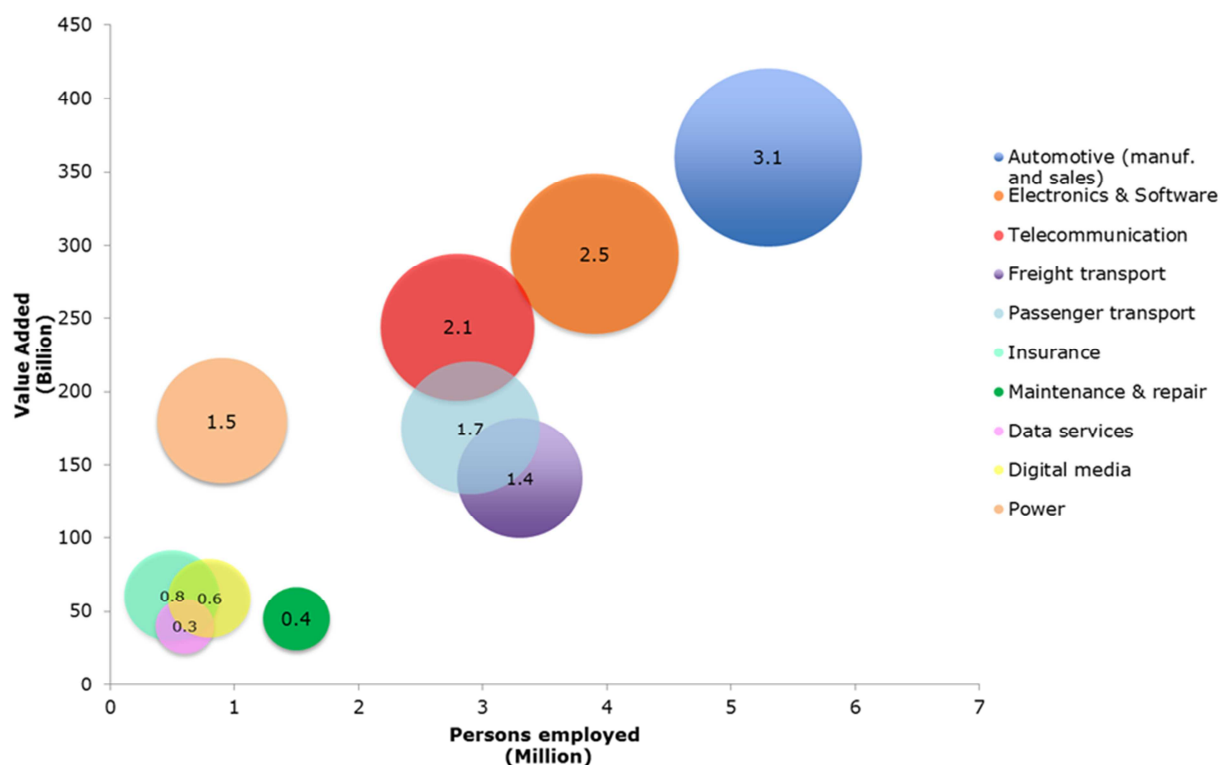

Source: Own elaborations (based on Eurostat data from 2015 [1], [2], according to the Nomenclature statistique des Activités économiques dans la Communauté Européenne (NACE) Rev. 2 classification [3]).

Table 2. Main economic effect per sector

Industries	Main effect prevailing in 2025 - 2050 scenarios
Automotive	↑
Electronics and software	↑
Telecommunication, data services and digital media	↑
Freight transport	↑
Passenger transport	↓
Insurance	↓
Maintenance and repair	↓
Power	↑

Source: Own elaborations.

References

- [1] Eurostat *Structural Business Statistics (SBS) Database*, available at: http://ec.europa.eu/eurostat/data/database?node_code=sbs_na (last accessed 9 February 2018).
- [2] Eurostat *National Accounts (NA) Database*, available at: http://ec.europa.eu/eurostat/data/database?node_code=na10 (last accessed 16 February 2018).
- [3] Eurostat, *NACE Rev.2-Statistical Classification of Economic Activities in the European Community*, 2008, available at: <http://ec.europa.eu/eurostat/documents/3859598/5902521/KS-RA-07-015-EN.PDF> (last accessed 2 April 2018).

3.3.2 Centralized Infrastructure-Assisted Management for Mixed Traffic at Transition Areas

A. WIJBENGA^a, J. VREESWIJK^a, J. SCHINDLER^b, E. MINTSIS^c, M. RONDINONE^d, A. CORREA^e, M. SEPULCRE^e, S. MAERIVOET^f, R. BLOKPOEL^g, E. MITSAKIS^c

^a MAP Traffic Management, The Netherlands

^b German Aerospace Center (DLR)

^c Centre for Research and Technology Hellas (CERTH), Greece

^d Hyundai Motor Europe Technical Center, Germany

^e University Miguel Hernandez de Elche, Spain

^f Transport & Mobility Leuven, Belgium

^g Dynniq, The Netherlands

The advent of connected and automated vehicles (CAVs) is expected to challenge mixed traffic operations on the way to full automation on the roads [1]. Market penetration of CAVs with varying level of automation and connectivity capabilities generates a complex road environment where vehicular interactions might become less smooth in the absence of infrastructure-assisted traffic management. CAVs are not expected to be fully automated in the near future [2]. Therefore, there might be situations on the road when drivers are requested to resume vehicle control due to complex traffic situations, adverse weather conditions, system failures, unexpected events, external disturbance to automation decisions or executions, or other possible sources of disturbance [3]. Moreover, there might be cases when drivers fail to take-over control from automation, and thus CAVs execute Minimum Risk Manoeuvres (MRMs) according to their capabilities to reach a safe stop [4]. Geographical areas where Transitions of Control (ToCs) (or consequently MRMs) are induced due to internal or external reasons are characterized as "Transition Areas" (Figure 25).

Figure 25. Transition Areas are characterized by vehicle automation level changes due to various reasons

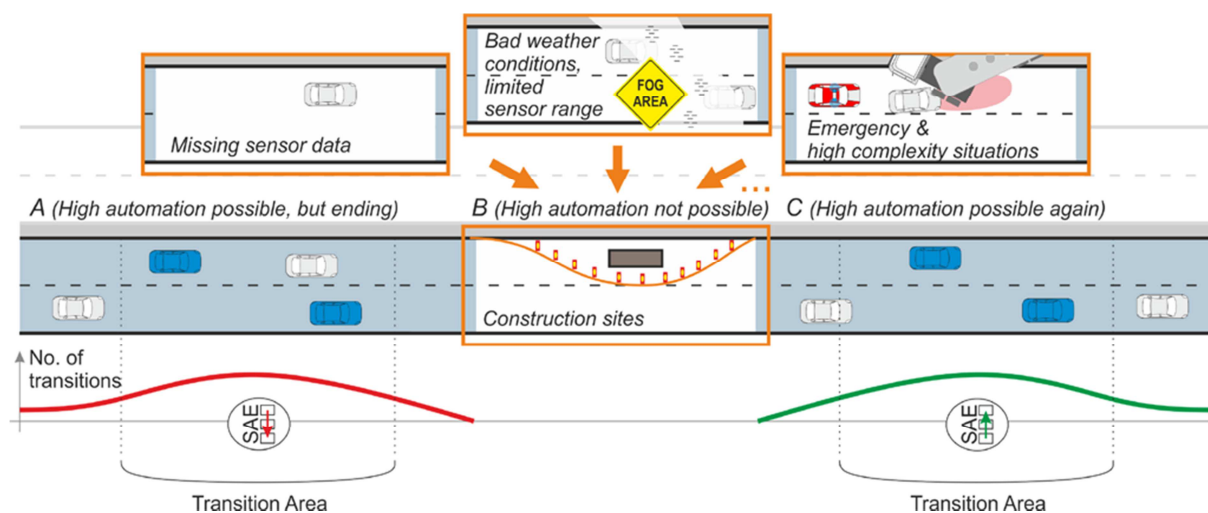

Source: Own elaborations.

The H2020 European Project TransAID (Transition Areas for Infrastructure-Assisted Driving) identifies triggering conditions (where, when, why, and how) for ToCs and thus determines "Transition Areas" based on the examination of the following factors and their interrelations: i) the environment, ii) the automated driving (AD) functions, and iii) the ToC process. Infrastructure-assisted traffic management procedures using V2X and conventional signalling are subsequently designed both for urban and highway driving,

focusing on the realization of the following objectives: i) prevent ToC or MRM (suggest manoeuvres, speed, headway and/or lane advice), ii) manage or support ToC or MRM (indicate safe spot, inform vehicles to give way, etc.), and iii) distribute ToC or MRM (spatially and temporally). Six services encapsulating the three aforementioned objectives were designed to improve traffic operations at transition areas for the upcoming 15 years (Table 3).

Table 3. Description of the proposed traffic management services.

Service No.	Service Name	Service Description
S1	Prevent ToC/MRM by providing vehicle path information.	Provide path information to CAVs that cannot continue driving due to inherent logic limitations.
S2	Prevent ToC/MRM by providing speed, headway and/or lane advice.	Provide designated speed, headway and/or lane advisory to facilitate highway merging traffic and obstacle avoidance.
S3	Prevent ToC/MRM by traffic separation.	Guide CAVs to CAV dedicated lanes to limit vehicle interaction and prevent ToC/MRM.
S4	Manage ToC/MRM through cooperative perception.	Provide environmental information to CAV to avoid a risky MRM and allow a safe execution of a ToC.
S5	Manage MRM by guidance to safe spot.	Guide CAVs to safe stop spot where traffic flow and safety are minimally impacted.
S6	Distribute ToCs by scheduling ToCs.	ToCs are distributed in time and space to prevent traffic disturbance due to collective ToCs.

Source: Own elaborations.

Several use cases were selected to study the effect of the six services. Through these use cases the proposed infrastructure-assisted traffic management schemes will be evaluated with the use of the simulation and later in the project by conducting real-world feasibility assessments. Traffic models for automated driving, and V2X communication protocols for CAVs will be developed and integrated into the open source simulation platform iTETRIS [5] that will assess safety, traffic and energy efficiency in the presence of hierarchical and centralized infrastructure-assisted traffic management. Real world experiments will show the feasibility of the simulation prototypes. Based on the project findings guidelines for infrastructure-assisted management of mixed traffic streams will be developed that will also include a roadmap defining future actions and needed upgrades of road infrastructure in the upcoming 15 years in order to guarantee a smooth coexistence of conventional, connected and automated vehicles.

References

- [1] R. J. van Loon and M. H. Martens, "Automated Driving and its Effect on the Safety Ecosystem: How do Compatibility Issues Affect the Transition Period?," *Procedia Manuf.*, vol. 3, pp. 3280–3285, 2015.
- [2] T. Litman, "Autonomous Vehicle Implementation Predictions: Implications for Transport Planning," Victoria Transport Policy Institute, Feb. 2017.

- [3] C. Gold, F. Naujoks, J. Radlmayr, H. Bellem, and O. Jarosch, "Testing Scenarios for Human Factors Research in Level 3 Automated Vehicles," in International Conference on Applied Human Factors and Ergonomics, 2017, pp. 551–559.
- [4] F. Flemisch et al., "Uncanny and Unsafe Valley of Assistance and Automation: First Sketch and Application to Vehicle Automation," in Advances in Ergonomic Design of Systems, Products and Processes, C. M. Schlick, S. Duckwitz, F. Flemisch, M. Frenz, S. Kuz, A. Mertens, and S. Mütze-Niewöhner, Eds. Berlin, Heidelberg: Springer Berlin Heidelberg, 2017, pp. 319–334.
- [5] M. Rondinone et al., "iTETRIS: A modular simulation platform for the large scale evaluation of cooperative ITS applications," Simul. Model. Pract. Theory, vol. 34, pp. 99–125, May 2013.

3.3.3 Evolving Urban ITS standards - European Traffic Management & Multi-vendor Environments

J. HARROD BOOTH^a, M. CARTWRIGHT^b, K. EVENSEN^c

^a *Harrod Booth Consulting, U.K.; Leader CEN Project Team Leader PT1709*

^b *Centaur Consulting, U.K.; Leader CEN Project Team Leader PT1710*

^c *Q-Free, Norway; Convenor CEN/TC278 WG17 Urban ITS Convenor, CEN Project Team Leader PT1706, 07, 08*

Traffic management thinking, approaches and deployments continue to evolve. Numerous external influences are also shaping societal demands for improvement of traffic management practices, including the support and enablement for connected and automated mobility, drives to provide greater access to information and data under the general open data agenda, as well as wider integration initiatives such as Smart City initiatives, etc. The European Commission is providing significant funding support to a range of CEN project teams, under the Urban ITS umbrella, to address a range of standardisation needs relating to common traffic management specifications and standardisation guidance and specifications geared to address some key urban ITS challenges such as supplier lock in.

This abstract and presentation will provide background and the latest status of developments concerning the activities of these combined CEN Project Teams and their progress towards new standards and standards guidance in this field.

ITS standards development has been progressing for a quarter of a century now, with strong developments across multiple standard development bodies covering a range of disciplines and applications. These include but are not limited to: traffic and traveller information systems, public transport systems, eCall, tolling and electronic fee collection; road data and databases; ITS digital maps, architectures, terminology, electronic automatic identification, communications, co-operative ITS, mobile ITS devices, freight and fleet management, and traffic management and control systems. Although many of the ITS standards underpin widespread transport technology service and systems deployments across a range of disciplines, much of this implementation has been focussed on the inter-urban long-distance travel corridors. Last year the European Commission sponsored a large CEN study project focussing on the standardisation needs for ITS in the urban environment. This study under the leadership of CEN's TC278 Working Group 17, undertook widespread consultation with urban authorities and stakeholders and identified a range of standardisation needs for ITS in the urban environment. This provides extensive analysis and stakeholder perspectives and laid out numerous recommendations for future standardisation work to benefit and enhance ITS deployments in the urban environment.

This study report is available at:

http://media.wix.com/ugd/a7dbd0_8cc42a2831df44f6a2e040f65036579c.pdf

Due to the wide-ranging scope and analysis of this report it is challenging to concisely summarise the findings and recommendations. However some overarching themes can be characterised in the statement – A major goal to be achieved with urban ITS standards is to assist urban administrations to implement urban ITS, and by this removing barriers for implementing urban ITS through focus on:

- Awareness of what is available
- Location referencing
- Vendor lock-in
- Standards for "new modes" and "new measures"
- Data exchange / data management

— Immaturity of some concepts.

Further clarification and prioritisation resulted in the formation of three CEN Project Teams which received funding approval in 2017. These are all progressing well.

— Location Referencing Harmonisation, creating two products:

- Location Referencing Harmonisation for Urban-ITS – Part 1: State of the art and guidelines
- Location Referencing Harmonisation for Urban-ITS – Part 2: Translation methods

— Traffic management systems — Status, fault and quality requirements (future CEN/TS 17241)

— Emissions management in urban areas - brief status report

Six more CEN Project Teams have initiated their activities in the past few weeks. These falls into three inter-related groups, that complement and build on earlier standardisation and the emerging work of the earlier three CEN Project Teams. These six Project Teams are:

— Mixed Vendor Environment

- Methodologies and Translators
- Standards
- Guides

This work will provide guidance and recommendations concerning best practice to ensure minimisation of the effect of lock in be that by vendor or client organisations. It will result in a suite of documents that draw on best practice experience from several national and regional initiatives including OCIT in german-speaking parts of Europe and UTMC in the UK.

— Traffic Management

- Data Models
- Interfaces and Information

These interlinked deliverables will specify terms and definitions as well as interface definitions and protocols seeking to clarify and encouragement common traffic management approaches for Europe. These will draw on several sources including existing standards, initiatives such as TM2.0, TN-ITS and extensions of existing models to support connected and automated mobility.

— Models and Definitions for New Modes (which includes bike schemes and sharing, car sharing and schemes, etc)

The presentation of this collected works and expected products and their impact will be given in June giving the latest state of progress, including the interactions with other important national and research and development/pre-deployment initiatives.

3.3.4 Addressing Barriers and Opportunities Engendered by Big Data in Transport: The LeMO Project

R. AKERKAR^a

^a *Western Norway Research Institute, Sogndal, Norway*

The transport sector has constantly collected and analysed large amounts of data, such as data from timetables, traffic news and air schedules. However, recent developments in the quantity, complexity and availability of such big data collected from and about transport systems, together with advances in information and communication technology, are presenting new opportunities to create more efficient and smarter transport and traffic systems for people and freight [1]. Also, 'opening up' data in transport by making it more widely available, and linking it with data from other sectors, is the part of the European strategy to improve transparency and encourage economic growth.

In transport, the *volume* of data has increased because of growth in the amount of traffic (all modes) and detectors. Also, travellers, goods and vehicles generate more data from mobile devices and tracking transponders (including trains, ships and aircraft). Infrastructure, environmental and meteorological monitoring also produces data that is related to transport operations and users. The *velocity* of data has increased in transport due to improved communications technology and media and increased processing power and speed for monitoring and processing. Some applications have experienced a step change in data velocity as technology has changed. For example, ticketing and tolling transactions that use smart cards or tags are now immediately reported, whereas paper-based ticketing depends on human processing to acquire data from the transactions. The *variety* of transport-related data has increased significantly. Modern trains report internal system telemetry in real time from anywhere in the world and it is possible to acquire information about all crew members and passengers. The *Veracity* refers to the quality, provenance and trust of the data. For deriving knowledge out of volumes of data, the accuracy of the data sources needs to be evaluated as well. Lastly, the *value* is potential gain for an organisation when exploiting the data [2, 3].

The use of big and open data in the transport sector is relevant for governments (traffic control, planning and modelling, route planning, congestion management, etc.), for the private sector (travel industry, route planning and logistics, competitive advantages, etc.) and for individuals (route and travel planning). Big data in transport will lead to improved multi-source traffic and travel data availability and processing, and to tools to enhance multi-source traffic and travel data fusion for, for instance, improved traffic and mobility management.

Big data has opened a wide spectrum of opportunities in the field of transport research. Several challenges will constitute opportunities for researchers (as well as the industry) in the foreseeable future. Observing the recent growing interest in the application of big data within urban transportation, as well as the widened scope of its applications, it is evident that most of the challenges have yet to be addressed.

A new European-funded project, *Leveraging Big Data to Manage Transport Operations (LeMO* ⁽¹³⁾) project will address these issues by investigating the implications of the utilisation of such big data to enhance the sustainability and competitiveness of European transport sector. The project will study and analyse big data in the European transport domain in particular with respect to five transport dimensions: mode, sector, technology, policy and evaluation.

The collection, use, sharing and linking of transport big data implicates a number of economic, environmental, legal, social, ethical and political issues, including those which may result in positive and negative societal impact. This presentation at the MFTS2018 focuses on the objectives of the LeMO project and presents a preliminary investigation of

⁽¹³⁾ <https://lemo-h2020.eu/>

some of the aforementioned issues that may be relevant to the consequences produced by big data. LeMO project uses this information as a springboard to further investigate research opportunities, challenges and limitations in relation to specific case studies and, based on their results, develop recommendations and a roadmap, which policy makers will be able to use to make better-informed decisions.

References

- [1] R. Akerkar. Big Data Computing. Taylor & Francis Group/CRC Press, 2013.
- [2] Danah Boyd and Kate Crawford. Critical Questions for Big Data. *Information, Communication & Society*, Vol. 15, No. 5, 2012, pp. 662-679.
- [3] Paradigm 4. (2014). Leaving data on the table: New survey shows variety, not volume, is the bigger challenge of analyzing big data. Survey. Available: <http://www.paradigm4.com/wp-content/uploads/2014/06/P4PR07012014.pdf>.

3.3.5 Assessing the impact of CAVs on network capacity, fuel consumption and emissions. A motorway scenario

K. MATTAS^{a,*}, M. MAKRIDIS^a, T. TOLEDO^b, B. CIUFFO^a

^a *European Commission Joint Research Center. Via E. Fermi 2749. 21027 – Ispra (VA)*

^b *Faculty of Civil and Environmental Engineering, Technion - Israel Institute of Technology, Haifa 32000, Israel*

The technological development in automation and connectivity is promising remarkable advances on the use of road networks, with low level automation functionalities already available in the market, and companies as Waymo expecting to introduce fully autonomous vehicles in the near future [1]. As autonomous vehicles (AVs), connected autonomous vehicles (CAVs) and conventionally driven vehicles have different capabilities, the effect of AV and CAV introduction can be substantial for the capacity of the network, safety and also on the environmental impacts. Network parameters, vehicle behaviour, traffic flow control and regulations can play an important role, supporting the potential benefits, optimizing the network if they are designed appropriately, or even bringing negative effects, deteriorating the network's condition.

To assess the global impact of the change in individual vehicle behaviour on the network, a simulation framework is needed, as real world experimentation on full scale is not feasible. This should support testing on a large network, vehicles with different behaviour in mixed scenarios, and evaluate the resulting traffic condition and the environmental impact. Under this light, a simulation framework has been developed using Aimsun commercial software. As a case study, the ring road of the city of Antwerp is modelled using real observation data. The network consists of 119km of roads, with 208 sections and 117 intersections.

The vehicle behaviour can be modelled using the microSDK and API tools provided by Aimsun. Three different types of vehicles have been defined, including AVs, CAVs and conventionally driven vehicles. Conventionally driven abide by the Gipps model [2], which is the default for the software. To simulate the cruising behaviour of AVs and CAVs a literature review was conducted and the models developed by [3] for AVs and by [4] for CAVs were chosen. The parameters have been set according to the suggestions in the literature. As for lane changing and giving way behaviour, the default Aimsun model is still applicable under the assumption that AVs and CAVs will try to imitate the lawful human behaviour, to facilitate the interaction between human drivers and controllers. This can be altered in future works, if comparing the efficiency between different lane changing strategies is desired. Also, some of the parameters as the desired time gap of the models are variable, to be able to run sensitivity experiments.

To evaluate the environmental impacts, COPERT (Computer Programme to calculate Emissions from Road Transport) emission model has been utilized as with the Handbook of Emission Factors (HBEFA) are the two reference emission models in Europe [4]. It has been shown that COPERT can estimate emissions on rural, urban or highway scenarios [5, 6]. The pollutants that are traced in the present work are CO₂ and NO_x emissions.

This work focuses on the traffic mixture, the demand and the desired time gap on AVs and CAVs as the most interesting variables in the framework. The traffic composition is significant as different penetration rate of AVs, CAVs and conventional vehicles can have different effects on the network. Demand for transport and desired time gap are examined for a low, medium and high value.

All experiments had a three hour duration, with the second hour representing the peak traffic and the first and last representing the network loading and unloading phases.

In Figure 26 the harmonic average speed is presented for the peak hour for every case in ternary plots. The AVs penetration, is shown to deteriorate the condition even for small market penetration. The CAVs can be responsible for significant benefits, apart from for

low market penetration, where they behave mostly as AVs. Larger time gaps proved to have an effect comparable to that of larger traffic demand. Specifically, forcing large time gaps for AVs, for safety or comfort my decrease drastically the capacity.

Figure 26. Harmonic speed of the network for the peak hour: (a) time gap 1.1sec and demand 80%,(b) time gap 1.1sec and demand 100%,(c) time gap 1.1sec and demand 120%,(d) time gap 1.6sec and demand 80%,(e) time gap 1.6sec and demand 100%,(f) time gap 1.6sec and demand 120%,(g) time gap 2.2sec and demand 80%,(h) time gap 2.2sec and demand 100%,(i) time gap 2.2sec and demand 120%.

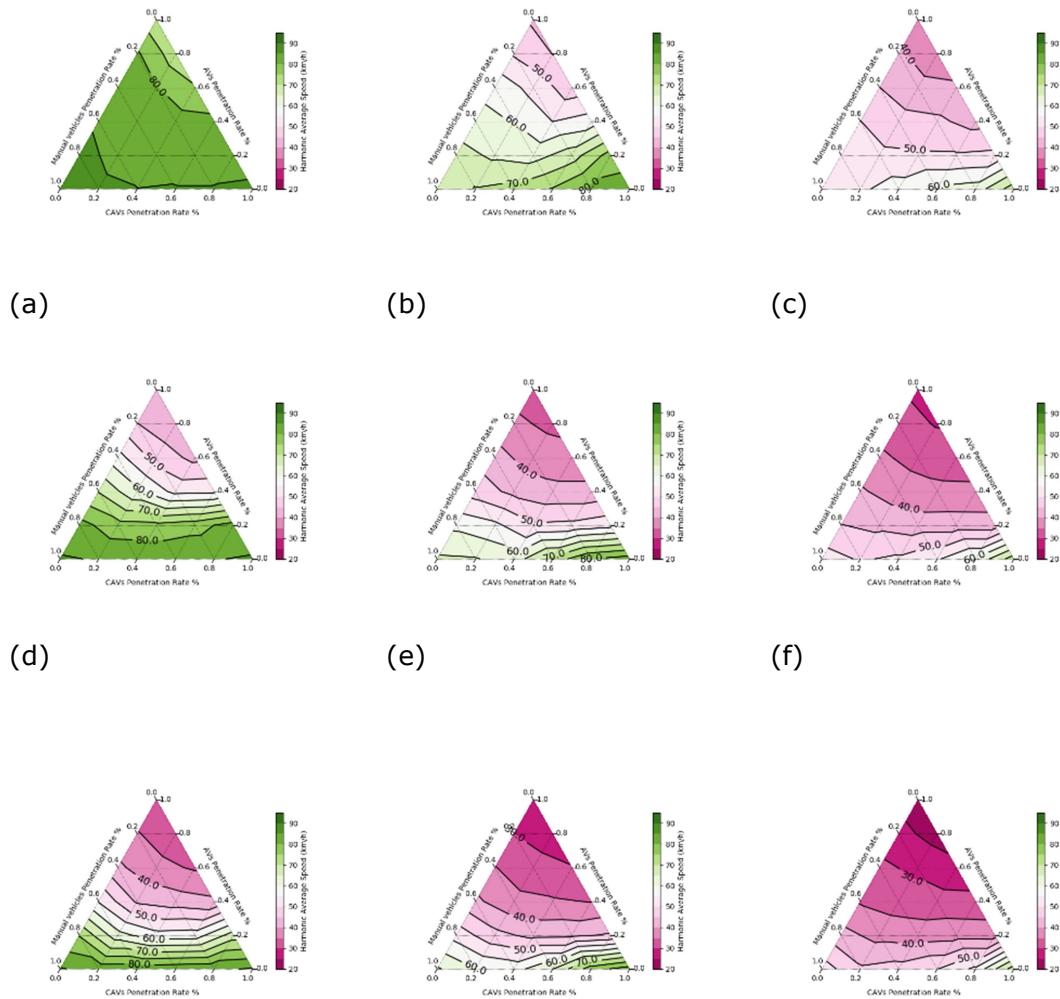

Source: Own elaborations.

The CO₂ and NO_x emissions, according to COPERT are presented in Figure 27 for the medium time gap cases. In low demand AVs have been outperforming conventional vehicles, reducing the speed used to levels that are more effective for internal combustion engine vehicles. Moreover they use smoother accelerations and decelerations. However, for high traffic demand the situation changes. Because of the reduced capacity, heavy congestion appears, with significant environmental effects.

Figure 27. Pollutant emissions calculated for time gap 1.6sec: (a) CO₂ per kilometre for demand 80%,(b) CO₂ per kilometre for demand 100%, c) CO₂ per kilometre for demand 120 %,,(d) NO_x per kilometre for demand 80%,(e) NO_x per kilometre for demand 100%,(f) NO_x per kilometre for demand 120%

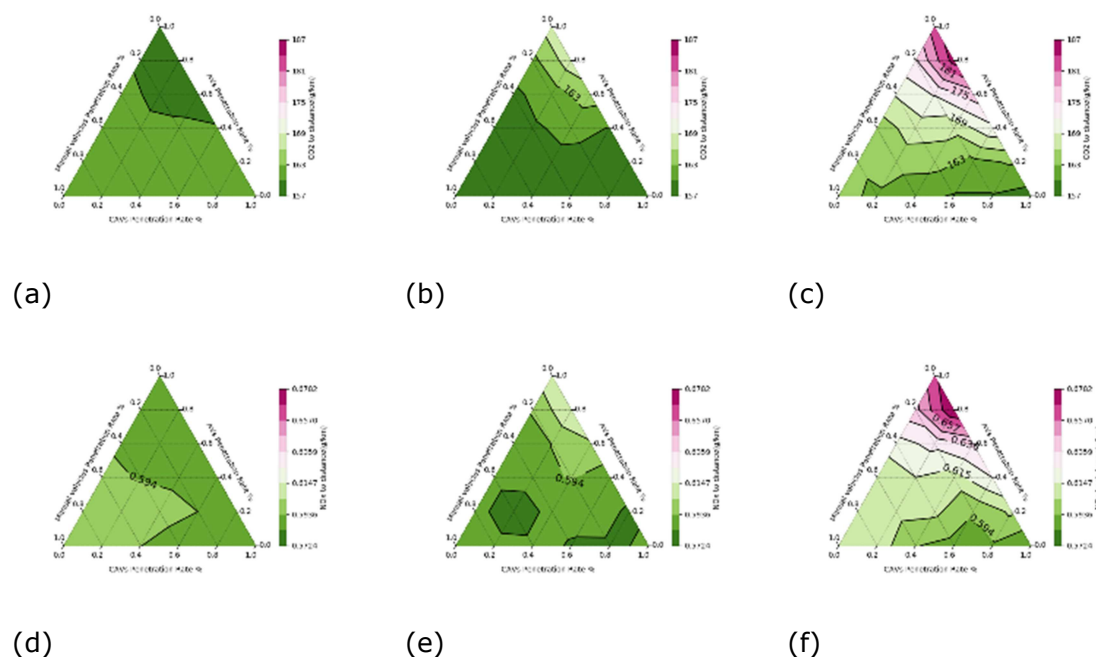

Source: Own elaborations.

References

- [1] Gibbs, S.: 'Google sibling Waymo launches fully autonomous ride-hailing service'*The Guardian*, 2017.
- [2] Gipps, P.G.: 'A behavioural car-following model for computer simulation'*Transp. Res. Part B Methodol.*, 1981, 15, (2), pp. 105–111.
- [3] Mahmassani, H.S.: '50th Anniversary Invited Article—Autonomous Vehicles and Connected Vehicle Systems: Flow and Operations Considerations'*Transp. Sci.*, 2016, 50, (4), pp. 1140–1162.
- [4] L. Ntziachristos, Z. Samaras: 'EMEP/EEA air pollutant emission inventory guidebook — 2009' (no date)
- [5] Fontaras, G., Franco, V., Dilara, P., Martini, G., Manfredi, U.: 'Development and review of Euro 5 passenger car emission factors based on experimental results over various driving cycles'*Sci. Total Environ.*, 2014, 468–469, pp. 1034–1042.
- [6] Fontaras, G., Ciuffo, B., Zacharof, N., *et al.*: 'The difference between reported and real-world CO₂ emissions: How much improvement can be expected by WLTP introduction?'*Transp. Res. Procedia*, 2017, 25, pp. 3933–3943.

3.4 Parallel Session 4a - Traffic Control with CAVs

3.4.1 Real-time adaptive signal control strategies exploiting emerging vehicle technologies

K. YANG^a, M. MENENDEZ^{b, a}

^a *Institute for Transport Planning and Systems (IVT), ETH Zurich, Switzerland*

^b *Division of Engineering, New York University Abu Dhabi, UAE*

The emerging technologies of connected and automated vehicles can be beneficial for the operations of urban intersections. Such technologies not only provide rich real-time information on the traffic systems, but also make it possible to control the motion of autonomous vehicles. To utilize the potential of these technologies, we design effective strategies for real-time intersection control at isolated intersections. Three categories of vehicles are considered to represent different stages of this technology: conventional vehicles, connected but non-automated vehicles (connected vehicles), and automated vehicles. Using the information provided by connected and automated vehicles as the only information source, we propose a joint optimization framework that simultaneously optimizes the trajectory of automated vehicles and the traffic signal timings. Simulations are conducted for different demand patterns and penetration rates of each technology stage (i.e. proportion of each category of vehicles) to evaluate the performance of the proposed strategies. Results show that the proposed strategies successfully improve the operations of the system, significantly reducing the total delay and the number of stops.

3.4.2 Optimal flow metering and lane-changing control at motorway bottlenecks

C. RONCOLI^a, F. TAJDARI^a, N. BEKIARIS-LIBERIS^b, M. PAPAGEORGIU^b

^a *Department of Built Environment, School of Engineering, Aalto University, Espoo 02150 Finland*

^b *School of Production Engineering and Management, Technical University of Crete, Chania 73100 Greece*

In the near future, the appearance of vehicle automation and connectivity will revolutionise the features and capabilities of individual vehicles. Among the wide range of potentially introduced technology, some may be exploited to interfere with the driving behaviour via recommending, supporting, or even executing appropriately designed traffic control tasks, providing unprecedented opportunities to improve traffic control performance [1]. It has been shown that, particularly at bottleneck locations (e.g., lane-drops, on-ramp merges), human drivers usually perform suboptimal lane-changes based on erroneous perceptions, which may trigger congestion, and, thus, deteriorate the overall travel time (e.g., [2], [3]). Furthermore, some of the mentioned empirical investigations indicate that, in conventional traffic, capacity flow is not reached simultaneously at all lanes, a feature that reduces the potentially achievable cross-lane capacity. For these reasons, a promising new feature that may be exploited for traffic management, independently or in combination with other strategies, is lane-changing control.

We address here the problem of maximising the outflow at motorway bottlenecks via a combined exploitation of flow metering and lane-changing control. It is well known that a bottleneck, which is a location where the flow capacity upstream is higher than the flow capacity downstream of the bottleneck location, is activated when the arriving flow is higher than the overall capacity or when the lane-changing behaviour leads to exceeding the capacity in at least one lane. In conventional traffic, in order to avoid or delay the activation of a bottleneck, and the related capacity drop phenomenon, various traffic control measures have been proposed and applied [4]. In the context of automated and connected vehicles, only a limited number of works have considered to exploit optimal lane distribution (e.g., [3], [5], [6]). We presented in [7] an optimal feedback control strategy for lane-changing control, formulated as a linear quadratic regulator, which is highly efficient in real-time even for large-scale networks. The method has been extended in [8] in order to achieve different traffic density distribution for the various lanes at the bottleneck area.

We propose here a novel coordinated and integrated approach that allows to jointly exploit mainstream or ramp flow metering together with lane-changing control, while accounting for unmeasured demand flows and incomplete measurements. The control strategy aims at regulating the on-ramp flow and the lane assignment of vehicles upstream of a bottleneck location so as to maximise the bottleneck throughput. Moreover, the proposed strategy is capable of handling efficiently the case of mixed traffic, where manual vehicles may not receive or may not follow the prescribed lane-changing commands. We first present the formulation of our strategy, which is based on a simplified linear macroscopic traffic flow model, with appropriate augmented dynamics to handle unmeasured flows. The model is employed to design a controller that aims at regulating the flow metered at an on-ramp together with the lane assignment of vehicles upstream of a bottleneck location in order to maximise the bottleneck throughput, targeting critical densities at bottleneck locations as set-points. Since the critical densities may be a-priori unknown and they may vary over time, we also employ a non-model-based real-time optimisation technique, namely, extremum seeking [9], to identify them, with the aim of minimising a performance index, namely the total time spent over a finite time horizon. Finally, we present simulation experiments, employing a first-order multi-lane macroscopic traffic flow model featuring the capacity drop phenomenon [10], in

order to evaluate the effectiveness of the developed methodology and to highlight the different traffic behaviour in terms of generated queues and per-lane flow distribution.

References

- [1] M. Papageorgiou, C. Diakaki, I. Nikolos, I. Ntousakis, I. Papamichail, and C. Roncoli, "Freeway Traffic Management in Presence of Vehicle Automation and Communication Systems (VACS)," in *Road Vehicle Automation 2*, 2015, pp. 205–214.
- [2] M. J. Cassidy and R. L. Bertini, "Some traffic features at freeway bottlenecks," *Transp. Res. Part B Methodol.*, vol. 33, no. 1, pp. 25–42, 1999.
- [3] Y. Zhang and P. A. Ioannou, "Combined Variable Speed Limit and Lane Change Control for Highway Traffic," *IEEE Trans. Intell. Transp. Syst.*, vol. 18, no. 7, pp. 1812–1823, 2017.
- [4] M. Papageorgiou, C. Kiakaki, V. Dinopoulou, A. Kotsialos, and Yibing Wang, "Review of road traffic control strategies," *Proc. IEEE*, vol. 91, no. 12, pp. 2043–2067, 2003.
- [5] W. J. Schakel and B. van Arem, "Improving Traffic Flow Efficiency by In-Car Advice on Lane, Speed, and Headway," *IEEE Trans. Intell. Transp. Syst.*, vol. 15, no. 4, pp. 1597–1606, 2014.
- [6] C. Roncoli, M. Papageorgiou, and I. Papamichail, "Traffic flow optimisation in presence of vehicle automation and communication systems – Part II: Optimal control for multi-lane motorways," *Transp. Res. Part C Emerg. Technol.*, vol. 57, pp. 260–275, 2015.
- [7] C. Roncoli, N. Bekiaris-Liberis, and M. Papageorgiou, "Optimal lane-changing control at motorway bottlenecks," in *2016 IEEE 19th International Conference on Intelligent Transportation Systems (ITSC)*, 2016, pp. 1785–1791.
- [8] C. Roncoli, N. Bekiaris-liberis, and M. Papageorgiou, "Lane-Changing Feedback Control for Efficient Lane Assignment at Motorway Bottlenecks," *Transp. Res. Rec. J. Transp. Res. Board*, vol. 2625, pp. 20–31, 2017.
- [9] K. B. Ariyur and M. Krstić, *Real-Time Optimization by Extremum-Seeking Control*. Hoboken, NJ, USA: John Wiley & Sons, Inc., 2003.
- [10] C. Roncoli, M. Papageorgiou, and I. Papamichail, "Traffic flow optimisation in presence of vehicle automation and communication systems – Part I: A first-order multi-lane model for motorway traffic," *Transp. Res. Part C Emerg. Technol.*, vol. 57, pp. 241–259, 2015.

3.4.3 Hierarchical multi-injection strategy and platoon manoeuvres at network junctions

A. DURET^a, A. LADINO^a, M. WANG^b

^a University of Lyon, IFSTTAR, ENTPE, LICIT UMR-T940

^b Department of Transport & Planning, Delft University of Technology

During the recent years, connected automated vehicles (CAV) have shown to be a crucial technology for the upcoming developments towards the improvement of traffic conditions [2]. Considerable efforts have been concentrated in the development of automated strategies for longitudinal formation, a.k.a. cooperative adaptive cruise control (CACC), where inter-vehicle distance can be shortened in order to maximize network flow and improve fuel efficiency [1, 8]. Nevertheless, one challenge prevailing in the design of such strategies is their robustness and flexibility to a variety of network configurations and traffic conditions, which implies CAV platoons should allow active platooning manoeuvres such as *split*, *merge*, *join* according to interactions with conventional vehicles in the network.

Despite all efforts on the subject, few concrete strategies have been proposed in order to tackle the interactions between vehicle platoons and traffic. Interaction protocols among CAVs for situations of merges and lane reductions were presented in [5]. The strategies herein detail two main scenarios: the first one establishes protocols mimicking human driver interaction within the V2V layer of communication in order to achieve a merge of a single vehicle. The second scenario studies the same type of protocols when lane reduction exists in the network. In [7], a decision algorithm that computes a target reference path for each vehicle and a fuzzy longitudinal controller that guarantees the merge for a vehicle approaching from the minor road tracks were proposed. More recently, a truck platoon splitting strategy at network discontinuities was proposed in [4], specifically studying the merge of a single vehicle. This work is inspired in the relaxation phenomenon after lane changing described in [6] with the Car-Following (CF) model and presents the formulation of the optimal anticipation time that allows the smooth merge of a conventional vehicle in the platoon.

Figure 28. (a) Multiple merging trajectories and (b) Bi-level strategy

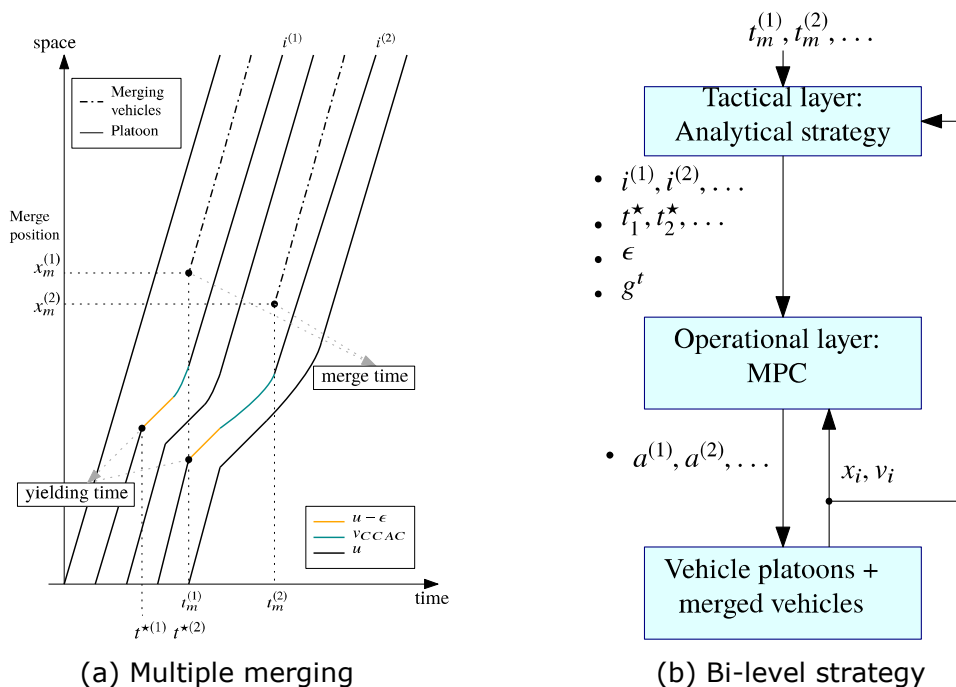

Source: Own elaborations.

For the design problem at hand, a hierarchical decision-making paradigm is often pursued [3]. One of the main issues when designing these type of strategies is the minimum information that should be transmitted from the tactical/supervisory level towards the operational/control level to perform efficient manoeuvres, particularly, in situations where merges or lane reductions are present. Under full connectivity assumptions, the proposed solution in this research formulates the multi-merging problem at motorway entrances as a bi-level strategy (See Fig. 1(b)). Assuming anticipated merging times $t_m^{(1)}, t_m^{(2)}, \dots$ of multiple vehicles from the on-ramp can be estimated by the infrastructure system or transmitted by the CAVs willing to be integrated into the platoon on the main carriageway, the tactical layer determines the yielding vehicle indices $i^{(1)}, i^{(2)}, \dots$ in the platoon that should adapt their actual vehicle-following behaviour in order to allow the merge of new vehicles. Given a merging time $t_m^{(1)}$, a desired gap g^t , and specifying the speed drop ϵ , it is possible to determine the yielding vehicle $i^{(1)}$ and the optimal anticipation time $t^{*(1)}$ to start the yielding manoeuvre. In particular, as shown in [4]:

$$t^{*(1)} = \frac{S^c - (g^t + L/u) \cdot u}{\epsilon} - \frac{\epsilon}{2 \cdot a_{\max}} \quad (1)$$

where S^c is the critical headway defined for safety at the merge, L the length of the truck, a_{\max} the maximum allowed acceleration. In this contribution, we extend in an analytical way a procedure to perform merging of multiple vehicles. Fig. 1(a) illustrates this condition. In this case, two vehicles are required to merge at positions $x_m^{(1)}, x_m^{(2)}$. In order to guarantee the secured and comfortable merge with a minimal impact on traffic conditions, the tactical layer should identify the yielding vehicles $i^{(1)}, i^{(2)}$ in the formation and yielding start times $t^{*(1)}, t^{*(2)}$, transmit these decisions to the operational layer where a constant time gap control strategy can operate in a coordinated way (a.k.a. CACC) to optimize performance indexes in the network such as flow or total travel distance. The order in which indexes $i^{(j)}$ and yielding times $t^{*(j)}$ are determined is important within the formulation since potential decisions taken by leaders may impact the actions taken upstream drivers when seeking to achieve a successful merge. In general this condition can be expressed as $t^{*(j)} \approx f(t^{*(j-1)})$.

The tactical decisions of the yielding vehicles index $i^{(j)}$, yielding start time $t^{*(j)}$, and design parameters of acceptable speed drop ϵ and desired time gap g^t are used to reformulate the optimal control problem at the operational layer. To this end, we distinguish whether the merging vehicle is a CAV or a conventional vehicle. If the merging vehicle is a CAV, the problem is transcribed into a cooperative merging problem, where the new platoon of length $N + j$ is formed virtually. If the merging vehicle is a conventional vehicle, the yielding vehicle tracks the speed of the conventional vehicle after merge as the leader. Given multiple merges are allowed we consider the condition of operation before the merging vehicles. The hierarchical framework entails using a first order car-following model to decide optimal tactical decisions and using a more detailed model to predict and control operational acceleration dynamics of vehicles to guarantee the possibility for the merging vehicle to join the platoon under safe and comfortable conditions, with limited impact on mainline traffic.

Given the nature of the problem, this model is very likely to be perturbed by stochasticity in parameters such as the leader speed u and the variables communicated to the tactical layer, in particular, the merging times $t_m^{(j)}$, (and consequently $t^{*(j)}$). Hence, they induce limitations on the full strategy performance. A study of the performance and the model limitations with respect to these conditions is also addressed in this research. The strategy is tested in different flow characterised scenarios as well as various connectivity scenarios an in-house microscopic traffic flow simulator developed by IFSTTAR. Performances are assessed regarding safety, comfort and traffic impact.

References

- [1] A. Alam, J. Mårtensson, and K. H. Johansson. "Experimental evaluation of decentralized cooperative cruise control for heavy-duty vehicle platooning". In: *Control Engineering Practice*, 38 (2015), pp. 11–25.
- [2] S. Bang and S. Ahn. "Platooning Strategy for Connected and Automated Vehicle: Transition from Light Traffic". In: *Transportation Research Record* (2017).
- [3] A. Duret, M. Wang and A. Ladino. "A hierarchical approach for splitting truck platoons near network discontinuities". Submitted to *ISTTT*, 2019.
- [4] A. Duret, M. Wang, and L. Leclercq. "Truck platooning strategy near merge: Heuristic-based solution and optimality conditions". In: *Transportation Research Board TRB 97th Annual Meeting*, 2018.
- [5] E. S. Kazerooni and J. Ploeg. "Interaction protocols for cooperative merging and lane reduction scenarios". In: *Intelligent Transportation Systems (ITSC), 2015 IEEE 18th International Conference on*, 2015, pp. 1964–1970.
- [6] L. Leclercq et al. "Relaxation phenomenon after lane changing: Experimental validation with NGSIM data set". In: *Transportation Research Record: Journal of the Transportation Research Board* 1999 (2007), pp. 79–85.
- [7] V. Milanés et al. "Automated on-ramp merging system for congested traffic situations". In: *IEEE Transactions on Intelligent Transportation Systems*, 12.2 (2011), pp. 500–508.
- [8] M. Wang et al. "Rolling horizon control framework for driver assistance systems. Part II: Cooperative sensing and cooperative control". In: *Transportation Research Part C: Emerging Technologies* 40 (2014), pp. 290–311.

3.4.4 Impact of Reservation-based Roadway Control on Capacity of Automated Vehicle Urban Traffic Systems

A. STEVANOVIC^a, N. MITROVIC^a, I. DAKIC^b

^a Florida Atlantic University, USA

^b Swiss Federal Institute of Technology, Zurich, Switzerland

Introduction

Current method of organizing traffic flows in urban networks, uses a directional Right of Way (ROW) to move traffic between urban intersections. Then, at such intersections, a conflict-resolution method is applied to safely and efficiently process traffic streams from the conflicting ROWs. A conflict-resolution method can be a set of traffic signs, signals, or road geometries combined with control rules (e.g. roundabouts, diverge-diamond and other alternative geometry intersections); all of which prioritize movements of certain traffic units (vehicles, pedestrians, etc.). Even emerging concepts, such as intersection reservation systems (Dresner & Stone, 2004), or where alternative geometry is combined with dynamic signal phasing and timing (Sun et al., 2017), do not step away from this traditional ROW concept.

However, driving rules do not have to be restricted as they currently are. So far, our thinking has been focused on: 1. Road stretches, where traffic flows are handled as directional (compressible) fluids, and 2. Road intersections, as the major 'containers' of the conflicts between traffic streams. Our ability to leave behind this traditional ROW model has been limited due to: 1. Inability to fully control human behavior, and 2. Lack of technological resources to enable full communication and interaction among vehicles, and between vehicles and infrastructure. However, emerging computational and communicational advances, often associated with Connected and Automated Vehicles (CVs, AVs) have opened new opportunities to organize traffic within the existing road infrastructure.

Our recent research efforts have resulted in the development of a system where every vehicle in the traffic stream can utilize, when not endangering the other road users, any part of the paved road surface regardless of the direction of its movement or its current speed or position (LATOM FAU, 2018). This paradigm shift, in the way we utilize road infrastructure, is motivated by the need to address everlasting increase in travel demand, it supports sustainability and preserves existing traffic-related land use.

This novel framework proposes organization of traffic flows without traditional directional restrictions. Entire available road surface can be utilized for conflict resolution and improvement of the traffic flows. For the sake of simplicity and field execution, we preserve lane discipline although some of the future scenarios can get away from this type of driving discipline as well. The proposed framework can be utilized for a number of various traffic control and management scenarios, which can allow, at the highest level, full spatial distribution of the conflicting points (between various traffic entities) in the road network. In addition, this framework can be restricted, with a set of additional rules, to mimic any of the existing traffic control scenarios (e.g. stop signs, signals (various logic types), alternative geometry intersections (with virtual instead of physical barriers), and even roundabouts (as long as the circular paths of the roundabout can be contained within physical space of an intersection box).

Objective of this paper is to document benefits of one of the possible strategies that can be implemented by using this novel concept. This strategy assumes alternative directional use of lanes where each next lane is used by traffic going in the opposite direction. Under this strategy, as illustrated in LATOM FAU (2018), the right- and left-turning vehicles use the most right and left lanes between two intersections, respectively, and thus completely avoid conflicts at the intersection. Vehicles get aligned into proper destination lanes by changing their entrance lanes early during their movements between intersections. This concept significantly reduces a number of conflicts, and waiting times,

for a significant proportion of traffic flows at the intersections. It should be noted that the through traffic is handled in a similar way as in the previous studies (Dresner & Stone, 2004). Although this strategy can be beneficial from many perspectives (e.g. number of conflicts, delays, reduced fuel/energy consumption) the focus of this paper will be to investigate impact of this concept on intersection capacity. This will be achieved by comparing throughputs of this strategy, under various demand levels, and a couple of more conventional traffic control concepts – including the basic signalized operations and reservation based intersection control similar to the one developed by Dresner and Stone (2004). The base-case study model, with traffic signals, will be validated to document similarity with commonly accepted models from traffic simulation industry (e.g. VISSIM).

Methodology

A full mathematical presentation of the key modules of an agent-based simulation, illustrated in LATOM FAU (2018), will be provided. Figure 29 illustrates a network case-study which will be used to conduct experiments. A small triangle within symbol of each vehicle in Figure 29 shows vehicle’s direction. Color of the vehicle is coded to correspond to vehicle’s destination point in the network.

Figure 29. Test network of the reservation-based roadway control in automated environment

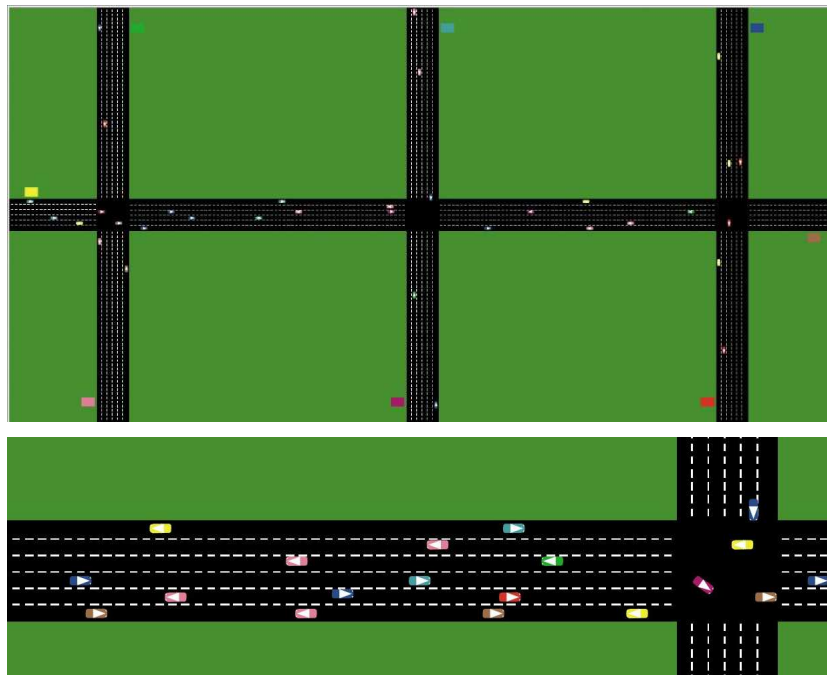

Source: Own elaborations.

Figure 30 shows high-level perspective of the combined process of network/model building and simulation execution. An agent-based modeling framework is used as a container to implement the code of the proposed system.

Future Steps

In future steps, we will perform a comprehensive calibration and validation of the proposed model to confirm its ability to replicate dynamics of common traffic flows. Then, we will develop and compare a number of strategies based on reservation systems and cooperative driving (with limited, or without, directional lane restrictions). Finally, we will investigate properties of traffic flow of such alternative driving mechanisms and report results for intersection capacities for a number of traffic demand levels. We will conclude the paper with similarities and differences between the proposed and conventional strategies.

Figure 30. High-level perspective of the combined model building and simulation execution processes

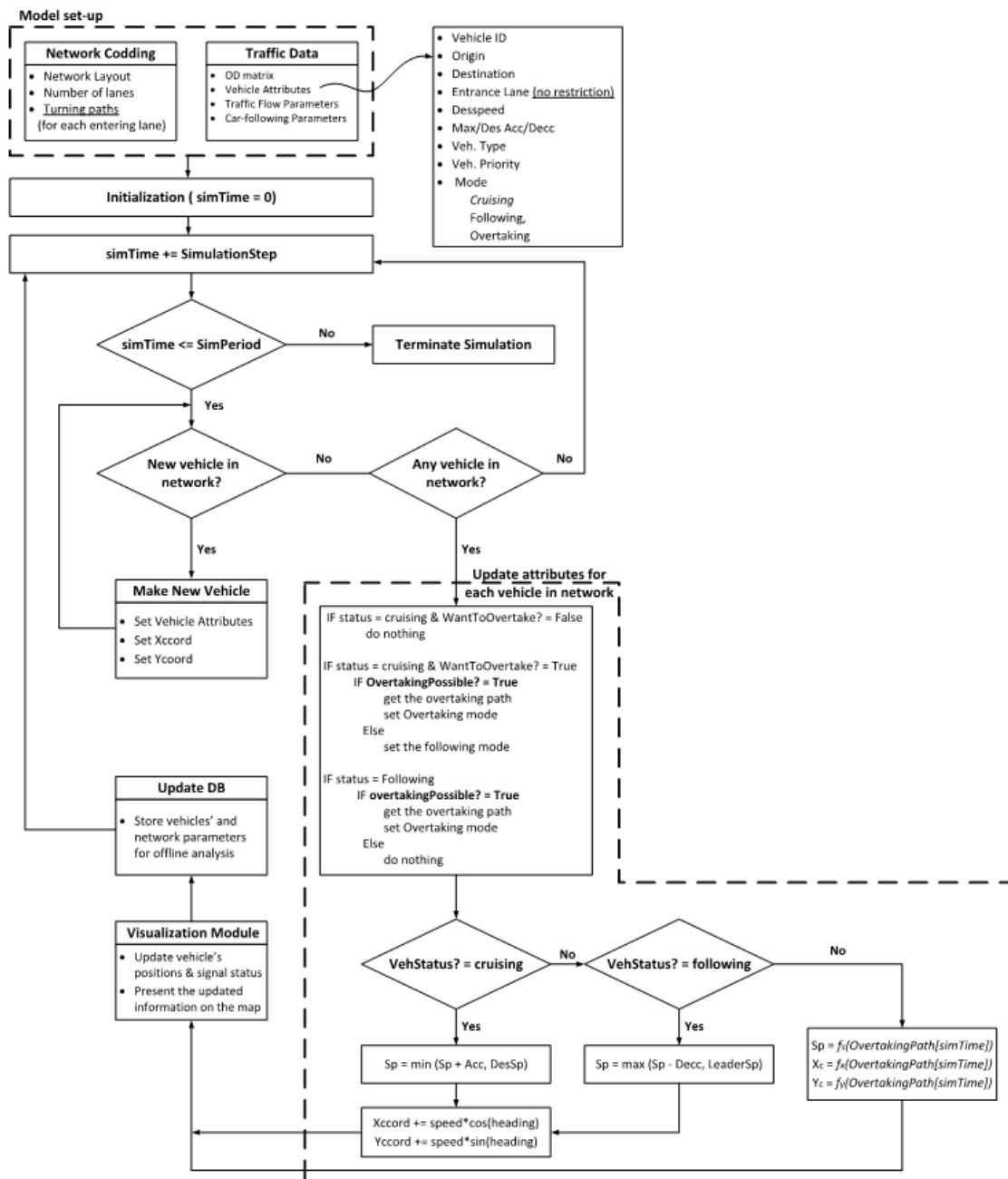

Source: Own elaborations.

References

- [1] Dresner, K., & Stone, P. (2004). *Multiagent traffic management: a reservation-based intersection control mechanism*. Proceedings of the Third International Joint Conference on Autonomous Agents and Multiagent Systems, 2004. AAMAS 2004., (July), 530–537.
- [2] Sun, W., Zheng, J., & Liu, H. X. (2017). *A capacity maximization scheme for intersection management with automated vehicles*. Transportation Research Procedia, 23, 121–136.
- [3] LATOM FAU. (2018, January 4). *Flexible Infrastructure: "Comb" Scenario (corridor and intersection view)*. Retrieved from <https://youtu.be/RXSwwJKqBQtM>.

3.4.5 Distributed Collaborative Network Management

I. CORNWELL^a

^a Mott MacDonald

This paper describes innovative methods of a module for road network management [1], and discusses how these fit the recommendations of the C-ITS Platform Working Group on Enhanced Traffic Management [2], and how collaborative features are perceived by traffic management authorities.

The “Distributed Network Manager” module is designed to support network management across layers that are normally managed by different authorities. It extends the influence of the traffic management of one authority into joining network layers. It does this by generating and evaluating traffic management responses across the layers and communicating with remote traffic management systems using an emerging standard.

Figure 31. Traffic management network layers

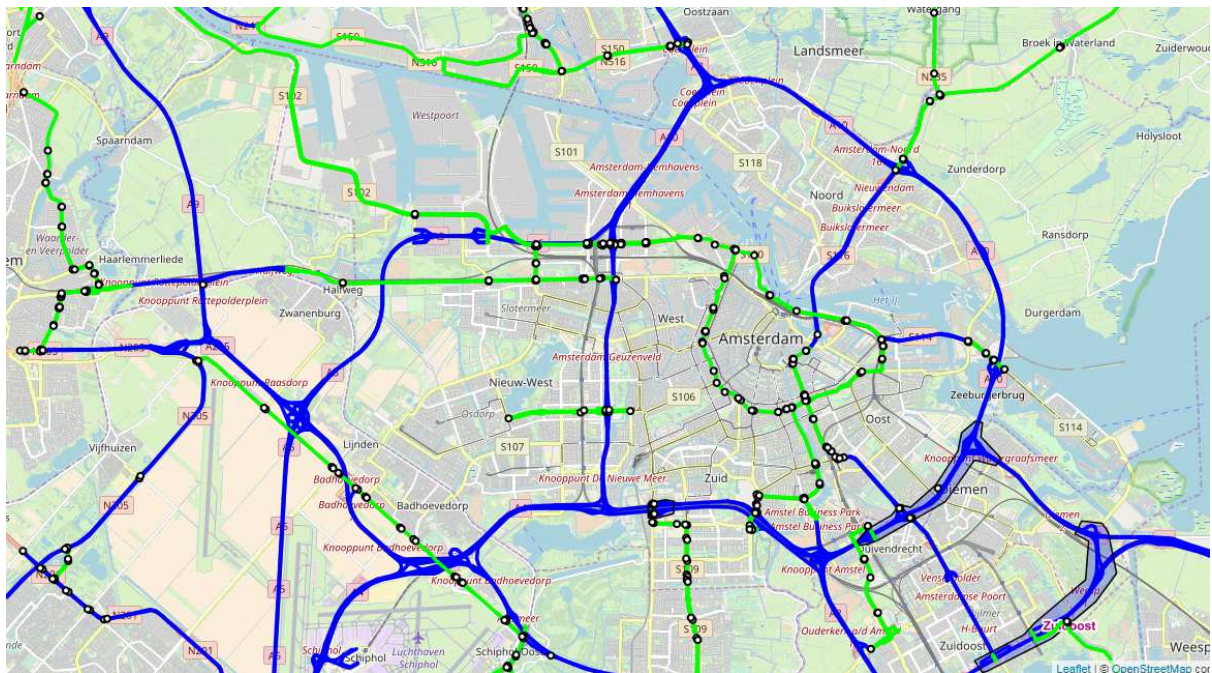

Source: Own elaborations.

In irregular situations, fixed traffic management plans can be too limited and inflexible. We developed a novel algorithm that generates potential responses dynamically based on properties of the road network. Less human analysis and configuration effort should be required to introduce new responses. The module performs a predictive evaluation of the effects of the potential response and uses a game theory algorithm to find an optimum combination of responses. Responses can be evaluated using multiple performance indicators, including delay and air quality, which can be combined through either monetisation or constraint evaluation.

When a traffic management response is selected for implementation, the traffic management systems of affected authorities are informed of details and asked for permission to implement, and approved response are implemented across the distributed systems, all using a new DATEX specification called DATEX Collaborative ITS Services (CIS).

Both collaborating authorities and in-vehicle service providers will want to know the reasons for the requested response. Our extension to DATEX CIS (which we aim to include in the specification in future) allows the publication of the detailed key

performance indicators generated by predictive evaluation. Collaborating authorities can then understand the cost or benefit of approving or declining the response. In-vehicle service providers can compare the evaluation to their own assessment and make an informed decision on the advice to their users.

The requirements for distributed collaboration and control across traffic management authorities were informed by a consultation with several traffic management authorities in UK and Netherlands. However, further consultation in UK showed that current attitudes to collaboration with in-vehicle service providers are mixed. Many city authorities do not wish to give *guidance* to individual travellers, only information, so these authorities are not currently interested in progressing a joint approach to guidance. Some city authorities are still discouraged by the well-known problem of user optimum versus system optimum. Progress of collaboration between in-vehicle service providers and these authorities will have to focus on scenarios where the outcome is clearly beneficial to both parties.

It may be instructive to consider the building blocks and recommendations of the C-ITS Platform Working Group on Enhanced Traffic Management in the context of the Distributed Network Manager as an example of a specific system.

- Classification of roads – the module uses the classifications of managing authority and road class to determine whether configurable cost weights should be applied to network links to influence their use in traffic management responses. Unless these weights are at extreme settings, the biggest influence on the use of roads is their estimated flow capacity, since any potential to overload links will be rejected by the predictive evaluation of potential effects.
- Geo-fencing mechanism (for influencing routing) – the module currently uses a basic mechanism where the cost weight of a city's links can be increased in predictive evaluation of air quality costs, which are combined with delay costs. Cost weight also increases with density of neighbouring properties. The Working Group mentioned the application of "virtual delay" to a routing algorithm; travel time is not the only performance indicator for routing.
- Network performance Level of Service, Common Operational Picture – these aspects are both about having sufficient traffic data, both historic and real-time. The Distributed Network Manager confirms this need – the predictive evaluation uses elements of traffic theory but is also data-driven.
- Trigger points – the need for conditions triggering response to be commonly agreed upon. The Distributed Network Manager shows an alternative dynamic pattern: any traffic event causing a reduction in capacity triggers predictive analysis, and any predicted overall benefit (according to the agreed evaluation criteria) triggers a request for human approval of the proposed responses, by all affected parties, in which the dynamically generated responses and their predicted performance effects are clearly explained.

References

- [1] I. Cornwell, C. van Hinsbergen, "Predictive dynamic distributed network management", 11th ITS European Congress, Glasgow, 2016.
- [2] C-ITS Platform Working Group – Enhanced Traffic Management "Final Report", <https://ec.europa.eu/transport/sites/transport/files/2017-09-c-its-platform-final-report.pdf>.

Acknowledgement

The developments described were inspired and supported by Highways England and Rijkswaterstaat in their CHARM Pre-Commercial Procurement programme.

3.5 Parallel Session 4b - (Big) Data

3.5.1 Yes we can, with CANbus data

E. FELICI^a

^a *National Data Warehouse for Traffic Information, the Netherlands*

After almost ten years of downturn, not only Europe's economy has recovered after a period of crisis: traffic congestion is growing back to levels last seen in 2007 and looking to break all records. The Minister of Infrastructure in the Netherlands has warned that despite heavy investments in infrastructure, by 2040 traffic congestion will bring the entire country to a grinding halt (1).

This asks for innovative solutions to improve traffic flow and avoid impending disaster. This can range from better utilization of roadside equipment, for instance the deployment of smart cameras which are able to detect abnormal traffic situations (2), to looking at potential new sources and uses of traffic data.

In the Netherlands, the National Data Warehouse (NDW) for traffic information works as a shared service organisation for road authorities with the goal to collect, procure and distribute traffic data on a national scale. Thanks also to the role of National Access Point, as appointed following the ITS Directive (3), NDW is a one-stop-shop for all governments and service providers for public traffic data.

With the rise of the connected car, the possibility of using data from the Controlled Area Network Bus (CANbus) of a vehicle is becoming a reality. This probe data offers insights into the inner workings of a vehicle, registering the use of sensors such as fog lights, windscreen wipers, traction control, braking behaviour and data from many more on-board sensors. Road authorities are interested to use this data for various use cases: to improve traffic safety through hyper-localized weather and slippery road warnings, for faster reaction times after the occurrence of incidents and for fine-tuning asset management strategies for more efficient road maintenance (4).

In 2017, NDW has organized a pilot with 20 government service vehicles. These vehicles have been fitted with a CANbus-reader which extracts sensor data and makes it available in real-time through a 3G/4G connection. The goal of this pilot was to test the technical characteristics and real-time delivery of the data and understand its potential value for road authorities.

Figure 32. Network coverage of 20 service vehicles for March – September 2017

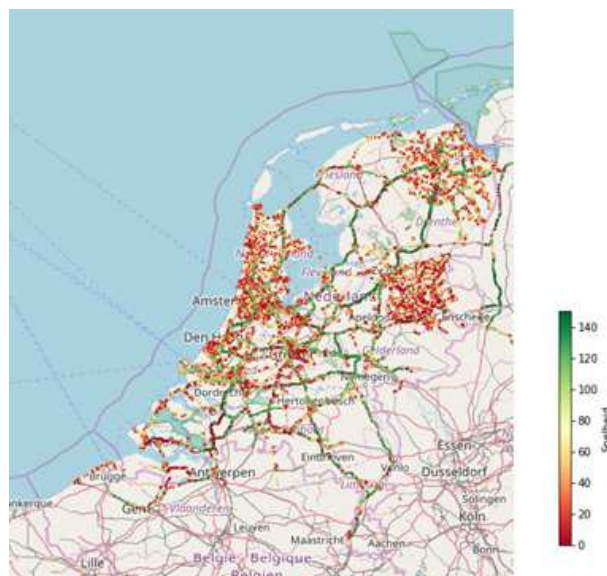

Source: Own elaborations.

The dataset included information on speed, ambient temperature, fuel consumption, hazard lights, brake pedal, windscreen wiper and fog light use. Data from these vehicles was collected for a one year period, offering valuable lessons on the necessary hardware specifications, privacy implications and the possible follow-up use-cases with the data. In phase 2 of the pilot in 2018, a larger dataset (with data from tens of thousands of vehicles) should give insights into the possibilities of national deployment of the related use-cases. Parallel to these developments, a European Data Task Force is organizing the dialogue with vehicle manufacturers for the structural deployment of safety related use-cases with probe vehicle data.

The large scale deployment of this novel data source can be considered one of the tools for future traffic management (5) and is an important input for European projects like Socrates 2.0. Especially the envisioned use-cases for traffic safety and incident management offer promising prospects to tackle the growing congestion successfully, or at least offer road authorities additional support in guiding road users to their destinations.

Figure 33. Overview of potential sensor sources from vehicles for implementation of use-cases



Source: Own elaborations.

References

- [1] "Ministerie waarschuwt: wegen worden alleen maar drukker" Volkskrant, 01/05/2017 <https://www.volkskrant.nl/politiek/ministerie-waarschuwt-wegen-worden-alleen-maar-drukker-stop-niet-met-investeren-in-infrastructuur~a4491842/> (accessed 13/02/2018)
- [2] "Slimme camera's gaan files te lijf" Telegraaf, 29/07/2017 <https://www.telegraaf.nl/nieuws/280872/slimme-camera-s-gaan-files-te-lijf> (accessed 13/02/2018)
- [3] EU EIP SA46, Annual NAP report - 2016
- [4] Felici E., (2018) *The Car as a Sensor*, presentation FCD Forum #6, 07/02/2018
- [5] Jonkers E., van Katwijk R., Wilmink I. – (2017) *TrafficQuest rapport – Alternatieve databronnen voor verkeersmanagement*

3.5.2 Analysis of Road Safety Speed from Floating Car Data and Their Possible Use in a V2V Environment

C. COLOMBARONI^a, G. FUSCO^a, N. ISAENKO^a

^a *Sapienza University of Rome*

1. Motivation

Current Intelligent Transportation Systems are addressed to improve efficiency and safety of the transportation system by acting fundamentally either on the vehicle performances through sensors, automated actuators, and V2V communication or on assisting the driver with information on the status of the vehicle and the conditions of traffic. Information on the road is usually provided by navigators that display a road map and guide drivers along the best route. Although digital road graphs are available to derive quantitative parameters that describe the road geometry, information provided usually includes speed limits and repetition of road signs. Moreover, although a huge amount of data on individual vehicle speeds and trajectories are collected as Floating Car Data (FCD), they are not combined with road parameters to derive information on how drivers perceive the infrastructure and behave when traveling on it.

The goal of the paper is to present a methodology to evaluate the level of consistency between drivers' behavior and safe speed determined by the road geometry. In the paper, a correlation analysis is conducted between the frequency distribution of vehicle speeds and the road geometry.

This method is conceived to have different applications, in the field of the analysis of current road safety conditions as well as in the field of on-board ICT applications to improve active safety. Statistical analysis of the deviance of experimental frequency distribution of individual speeds from the estimated safe speed enables to individuate critical points of the network in terms of safety behavior. It also opens new horizons to use this information in V2V environment.

2. Method

Highly detailed digital graphs available today represent road geometry with a sufficiently high accuracy to enable to identify the geometric parameters of road curves. The paper introduces an algorithm that progressively scans the road graph and computes the azimuth variation along the road line in order to detect elements with constant azimuth. Consecutive elements with the same value of the azimuth variation are identified as circular curves and their radius is computed by applying an algorithm for circle fitting.

Safe speed with respect to longitudinal stability is estimated from the fundamental equation that relates it to the minimum horizontal curve radius, the superelevation value, and the side friction factor. The side friction factor is assumed to be related to the speed by a polynomial function.

3. Experimental application

Information on drivers' behavior is available from a large set of about 200 million Floating Car Data containing individual vehicle positions and speeds. The statistical distribution of drivers' speeds is compared against the safe speed. Higher deviances identify inconsistency conditions between road geometry and drivers' perception. Vehicle trajectories detected by FCD are also used in order to determine the actual vehicle trajectories with high level of accuracy, which on their turn permit highly accurate estimation of the safe speed.

A statistical analysis of speed distribution has been carried out in a systematic study of regional roads in the Latium region. Moreover, understanding the relationship between the actual statistical distribution speed and the safe speed against the transversal stability provides additional opportunities for enhancing on-board information to drivers about not only an excessive speed but also about the deviance of current vehicle speed with respect to the statistical distribution of other drivers' speeds in the same road

segment. Because many other external factors other than curve radius affect safety, dynamic update of safety conditions can be carried out by matching static relations and real-time update of actual values of the relevant variables that are detected by vehicle sensors. Vehicle-to-vehicle communication enables a dynamic update of speed changes in consecutive road segments and information exchange of road risk assessment from one vehicle to another along the traffic stream.

In the paper, the description of the analysis method is integrated with the experimental results obtained by applying the road safety analysis to the regional road network of Latium.

An example is represented in Figure 34 that highlights the deviance between the 95th percentile of the observed speed and the safe speed against lateral stability on a segment of a regional road. The figure shows also curve radii that are computed by processing the digital graph. It is worth noticing the high deviance (highlighted by red color) revealed on the curves that follow a stretch of road composed by straight segments and curves with large radii.

Figure 34. Deviance of 95th percentile of observed individual speeds and the safe speed along a segment of a regional road in Italy

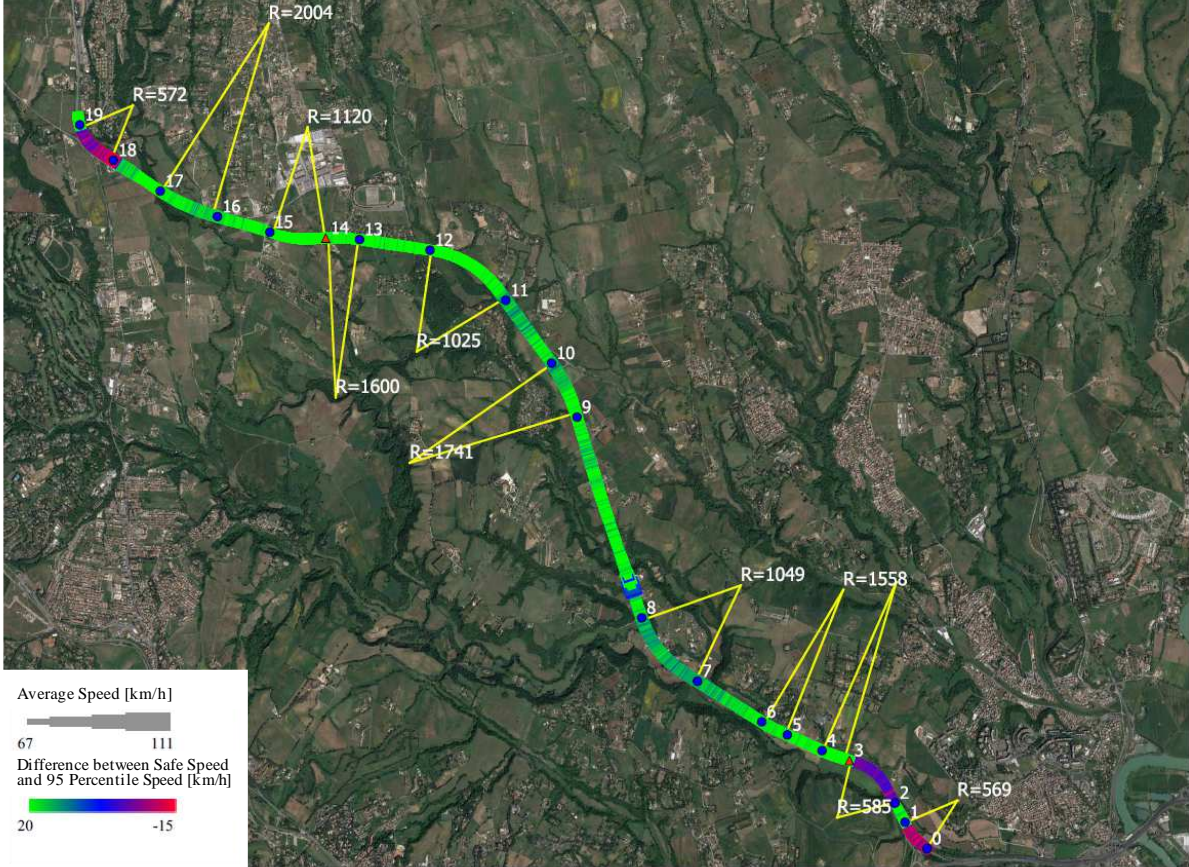

Source: Own elaborations.

3.5.3 The power of information to assess road transportation impacts for a connected and sustainable mobility

P. FERNANDES^a, J. TEIXEIRA^a, M. C. COELHO^a

^a University of Aveiro, Department of Mechanical Engineering / Centre for Mechanical Technology and Automation, Campus Universitário de Santiago, Aveiro, Portugal

In the last years, the increasing availability of diverse sources of traffic information to record massive amounts of data has prompted significant deployments in sensor technologies. Accordingly, some strategies have been proposed to take benefits of these technologies for road users. The R&D project “MobiWise: from Mobile Sensing to Mobility Advising” has the main vision to improve mobility in cities for both commuters and travelers by building a 5G platform that encompasses the infrastructure with sensors, vehicles and people (see Figure 1). The project is coordinated by the Institute of Telecommunications (IT) of the University of Aveiro and has the participation of IT from Porto University, the Center of Mathematics and the Center for Informatics and Systems of the University of Coimbra, and the Center for Mechanical Technology and Automation (TEMA) of the University of Aveiro. TEMA is responsible by the transportation impacts assessment.

Figure 35. MobiWise global overview

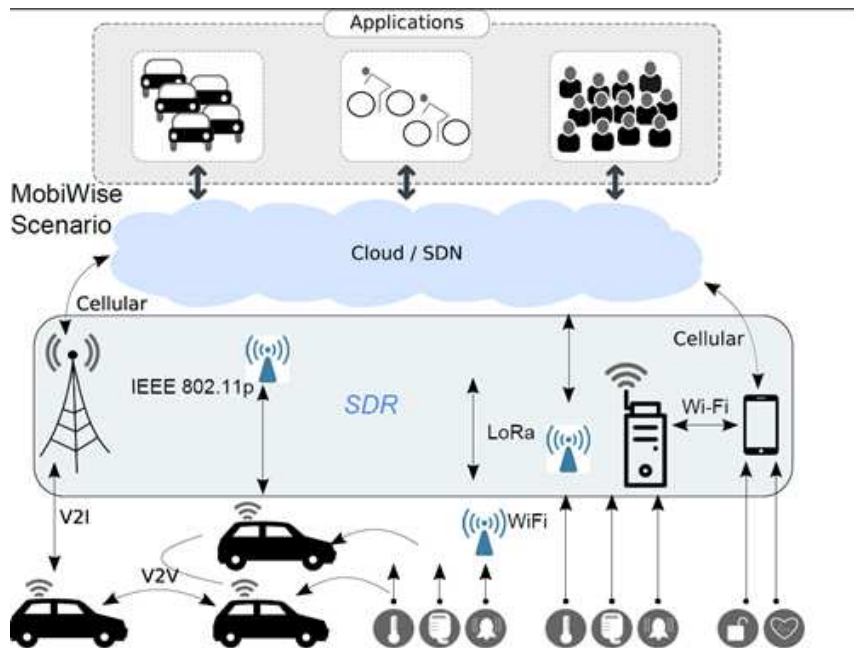

Source: ©MobiWise consortium.

The conceptual idea of MobiWise is to connect any sensor, person and vehicle, and then it uses all information to improve the user mobility, through a complete network and services platform for an Internet of Things in a smart city. One of these examples is the eco-urban routing which requires data from smartphones, sensors and road transportation facilities to select the best paths in the city both in the perspective of individual user (e.g. drivers, cyclists, motorcycles) and in the perspective of centralized management (e.g. transportation planners, decision makers).

Link-based functional relationships between speed microscale patterns data of individual vehicles are being developed in order to facilitate integration into optimization algorithms. High intra-variability of speed, road grade and acceleration profiles were analysed in detail, as well as traffic congestion hotspots. To accomplish the objective posed, Dijkstra algorithm combined with VISSIM microscopic traffic routing decision

process [1] are being adapted according to the different specificities and vulnerabilities of the study domain. VISSIM traffic simulation model [1] allows exporting full disaggregated vehicles trajectory files that can be used by external applications to assess environmental and safety impacts.

The performance analysis of different routing strategies are based on link-specific travel time, carbon dioxide, nitrogen oxides, hydrocarbons and carbon monoxide emissions, traffic noise and crash costs. Vehicle Specific Power (VSP) methodology [2, 3] is used to calculate pollutant emissions. VSP is a function of instantaneous speed, acceleration/deceleration, and road grade and allows estimating instantaneous emissions, taking as input the trajectory files given by VISSIM. This method is being refined based on vehicle-specific emissions data; an on-board portable emissions measurement is being used (see Figure 2) to explore correlation of individual driving performance (acceleration index, driving volatility) and consequences in terms of emissions.

Figure 36. On-board emissions measurements



Source: ©M.C. Coelho.

SSAM [4] and PC-CRASH [5] are used to assess road conflicts and road crashes, respectively. Dynamic noise models, which are based on traffic speed, volumes and acceleration-deceleration, are used to estimate noise levels.

This will explore how the presence of 5G technologies may help people to avoid crashes through new safety warnings, and ultimately, automated responses, in addition to explore ways to enhance traffic incident management when a crash does occur. The modeling platform will be validated using: 1) vehicle dynamic data (speed, acceleration-deceleration) from Global Navigation Satellite System (GNSS) receivers; 2) real-world vehicular emissions gathered from Portable Emission System Measurements, and 3) site-specific historical crash data. The main output is the inclusion of safety, fuel consumption/emissions and noise parameters in the integrated assessment of the road network performance [6] and to the development a joint eco-indicator to assess trade-offs between different impacts. This will be done by accurately assigning dynamic link-based eco-indicators of vulnerability, by providing instruments for evaluating traffic-related externalities and integrating multiple traffic-related externalities into a common measure.

The proposed routing platform will cover transportation stakeholders needs in different ways, as follows: City Planners who will dispose different sources of traffic data and new traffic-related prediction tools; Decision Makers who will have updated environmental, crash and traffic performance indicators. Each stakeholder will be able for adjusting a good deal of mechanisms associated to Advanced Traffic Management Systems (ATMS) to promote a distribution of traffic and use of infrastructures in a more sustainable and equitable way. Finally, Individual Users will rapidly be informed of their travel costs and associated traffic-related impacts, and then they will adopt more eco-friendly mobility solutions. Some of these include the better use of private vehicles-eco-route, responsible

behavior, shift to active modes, best departure time, and optimized speed advisory systems.

References

- [1] PTV (2014) VISSIM, <http://www.ptvamerica.com/vissim.html>.
- [2] Frey, H. C., K. Zhang, and N.M. Rouphail. Fuel Use and Emissions Comparisons for Alternative Routes, Time of Day, Road Grade, and Vehicles Based on In-Use Measurements. *Environmental Science & Technology*, Vol. 42, No. 7, 2008, pp. 2483-2489. <http://pubs.acs.org/doi/abs/10.1021/es702493v>
- [3] Coelho, M. C., H. C. Frey, N. M. Rouphail, H. Zhai, and L. Pelkmans. Assessing methods for comparing emissions from gasoline and diesel light-duty vehicles based on microscale measurements. *Transportation Research Part D: Transport and Environment*, Vol. 14, No. 2, 2009, pp. 91-99. <http://www.sciencedirect.com/science/article/pii/S1361920908001429>
- [4] FHWA (2012) Surrogate Safety Assessment Model (SSAM), <http://www.fhwa.dot.gov/publications/research/safety/08049/>
- [5] PC-CRASH (2018), <http://www.pc-crash.com>.
- [6] Paulo Fernandes, João Teixeira, Anésio Sousa, Claudio Guarnaccia, Margarida C. Coelho, Multi-Criteria Assessment of Crosswalk Location in Corridors with Roundabouts or Traffic Lights: The Importance of Noise Levels Estimation, *Transportation Research Procedia* 27 (2017), pp. 460–467.

3.5.4 Application of Hard Shoulder Lanes on Tunnels based on Studies of Driver Behavior using Virtual Reality Technologies

D. LEE^a, S. HWANG^b

^a Associate Professor, University of Seoul

^b Ph.D. Student, University of Seoul

Generally traffic congestion is generated from increased traffic demand, and the complete solution of the congestion may be to construct more highways or more lanes. However, highway construction is a work to need great budget and time. To overcome these limits, recently hard shoulder lanes have been applied and produced great efficiency on traffic flow. In Korea, there are many freeways with hard shoulder lane. However, hard shoulder lanes in many cases are disconnected due to interchange and tunnel sections. Because hard shoulder lanes started to be activated without any construction to extend the number of lanes after severe congestion occurrence freeways, hard shoulder lanes cannot be operated in tunnels, which have too narrow shoulder lane to allow vehicles to run. Due to this problem, tunnels function as bottle-neck and as cause to drop the effectiveness of hard shoulder lanes.

To apply hard shoulder lanes on tunnels as well, driver behaviors were analyzed prior to the activation. Deficient driving environment in tunnel can make drivers to drive on the hard shoulder lanes with anxiety, inconvenience, and risk due to too short shoulder lane in the tunnels, and then causes accidents. To investigate driver behaviors on tunnel hard shoulder lanes, driving simulator experiments were conducted with 30 older drivers and 30 non-old drivers in various activation speed limits. For testing driving stability and safety, lateral placement and change rates of speed were used as MOEs. Using these MOEs, effects of hard shoulder lane activation and differential of older driver and 30 non-old driver behaviors were analyzed. In addition, congestion reduction effects of hard shoulder lane extension to tunnel were investigated through traffic simulation study using VISSIM. Lateral placement can explain driving stress from relatively narrow hard shoulder lane and too nearby tunnel wall and change rates of speed can explain anxiety of driving on driving on relatively narrow tunnel hard shoulder lane. Through experiment results, it was concluded that driving on tunnel hard shoulder lane was not seriously risk and inconvenient speed of less than 50km/h. Older drivers had relatively more anxious driving behavior on tunnel hard shoulder lane were observed.

Figure 37. Driving Simulator Experiments with Electroencephalogram (EEG) Detection

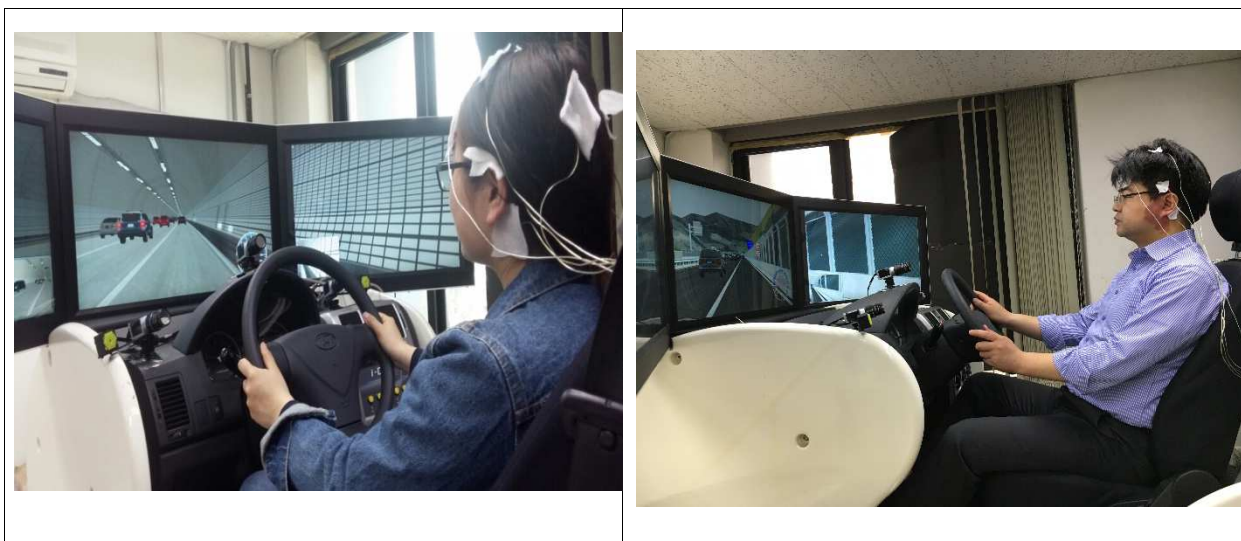

Source: Own elaborations.

Figure 38. Speeds with and without Hard Shoulder Lane in Tunnel

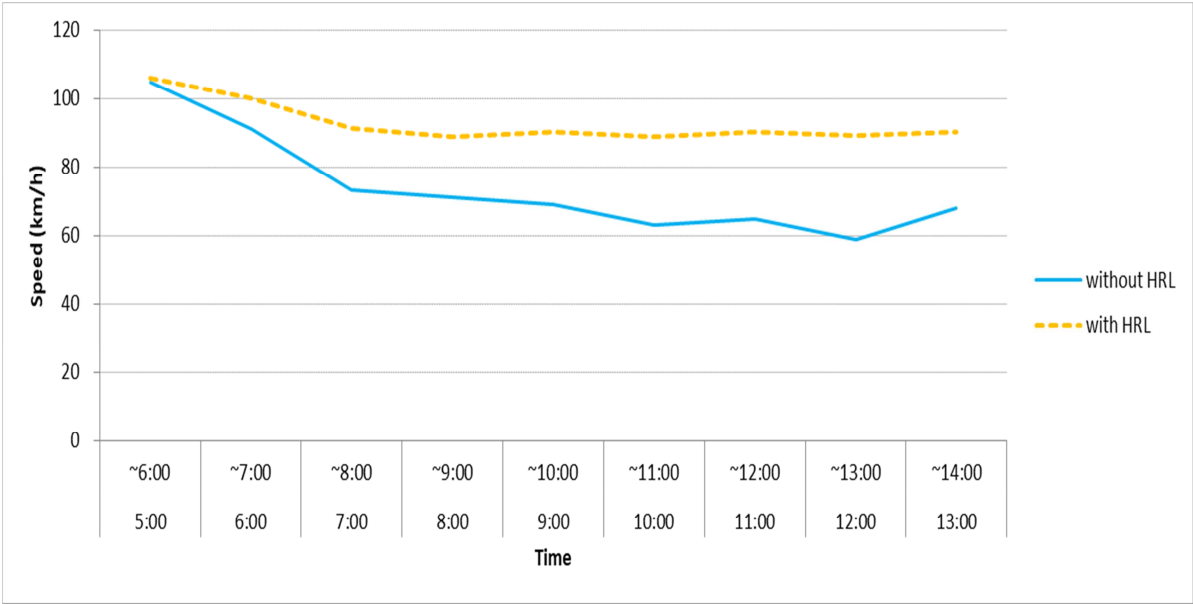

Source: Own elaborations.

3.5.5 Using mobile phone data for urban network state estimation

T. DERRMANN^a, R. FRANK^a, T. ENGEL^a, F. VITI^{a,b}

^a *Interdisciplinary Center for Security, Reliability and Trust, University of Luxembourg*

^b *MobiLab Transport Research Group, University of Luxembourg*

The ubiquity of mobile phones is producing ever-increasing amounts of data, providing invaluable information that can be used to study many aspects of our everyday life. A promising way of exploiting this data is the modelling of mobility patterns, such as the use of mobile network data, as a complementary source for estimating dynamic road traffic conditions. A major motivation for estimating urban mobility from mobile data is that transportation sensing infrastructure is costly in terms of installation and maintenance, has limited coverage and is intrusive. In a mobile network, all participants generate data, i.e. stationary and mobile users alike. From a transportation perspective, mobile network data can then be referred to as *exogenic* data, as the data encompasses not just the transportation network agents but the entire mobility of individuals.

In our research we explore how mobile data can be used for various estimation and modelling tasks in transportation. Essentially, by looking at mobile networks as distributed traffic sensors, we want to show that they can serve as a complement to the existing, traditional transportation data sources. In particular, in this study, we want to explore ways of estimating supply-related metrics in a cost-neutral and privacy-friendly way. To do so, we introduce a methodology for estimating vehicular density and flows in analogy to the concept of Macroscopic Fundamental Diagram [1], using mobile network handovers as input data. In the presentation we will show that the presented supply model works both in simulated- and real-data settings, and compare the results from both worlds. The supply models developed from mobile data enable the optimization of traffic by controlling the flows between zones, e.g. via gating [2]. Past research in this direction has focused mainly on highways and on using mobile phone data at a regional scale (e.g. [3]). The main study in urban traffic areas was done by Calabrese et al. [4], who performed analyses of the Telecom Italia dataset for the city of Rome. Our study targets urban mobility patterns and is complementary to [4] as we focus on network states rather than on the demand side.

We want to establish a model in the form of $v = q * k$, i.e. the fundamental flow-density relationship for partitions of the road network, in analogy to the concept of MFDs. Since in mobile networks the phone's precise serving cell is only known during an active data or call connection, we cannot access the density of mobile phones directly (as the majority of them typically are in a passive, disconnected state). Thus, we propose a three-stage approach:

- First, we partition the road network in areas that are large enough to capture the traffic dynamics of MFDs;
- Next, we model each partition's density using handovers within and from the partition;
- Finally, we use linear regression to estimate the traffic state from exiting flows and approximated density, thus optimizing the regression coefficients for all time intervals and partitions.

For each partition, we propose a density modeling function based on the ratio between the scaled internal and exiting flows. We propose to express this relationship using a polynomial with interaction, where the degrees and coefficients are the parameters characteristic of each partition. Details on the model formulation are given in the presentation and in the full paper.

The dataset used in this study is composed of two elements. The first is the position of LTE base stations and the corresponding cell identifiers hosted on this base station. The second is the number of handovers between any given cell pair per hour. We test the state estimation model using simulated data coming from mobile phones, while we

simulate synthetic floating car data for validation purposes. The simulation scenario we base our study on is the LuST scenario by Codeca et al. [5] for the microscopic traffic simulator SUMO [6]. Floating car data is also used as ground truth in the real data analysis, where the mobile dataset used is the LTE network data from the largest mobile operator in Luxembourg, Post.

Figure 39. Partitioning of Luxembourg City network

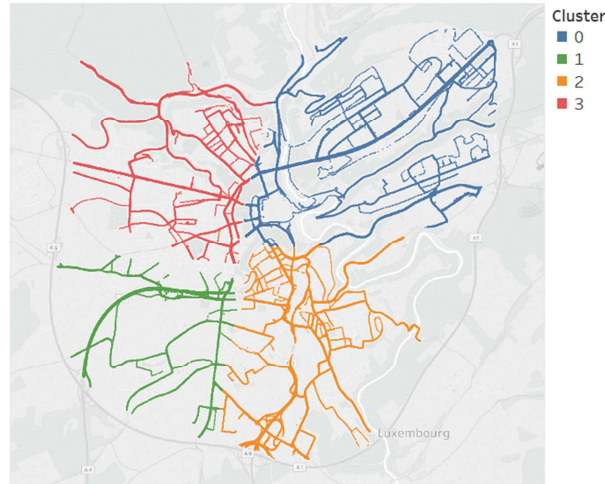

Source: Own elaborations.

Figure 39 shows the partitioning we use both in the simulation and real-data studies. We opted for 4 partitions, representing the main geographical zones of Luxembourg City, i.e. physically separated plateaus. Note, however, that road network partitioning can also be done algorithmically and depending on the flows, e.g. using spectral clustering [7].

Figure 40. Comparison of Mobile Network MFD approximations

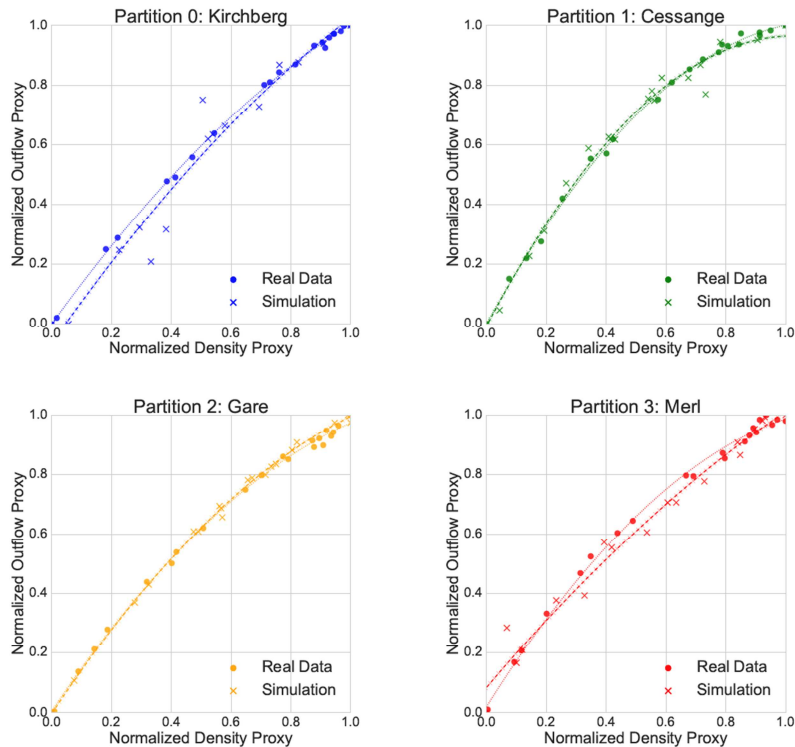

Source: Own elaborations.

Figure 40 gives a comparison of the results for both simulation and real case study. Density Proxy is estimated based on the number of handovers internal to the cluster, while Outflow Proxy is estimated using the handovers out of the cluster. As one can see, all partitions show consistent and well-defined relations. Note that the network of Luxembourg City is hardly affected by significant congestion propagation and has no gridlock issues, hence the results show only the left branch of a Macroscopic Fundamental Diagram.

These results are very encouraging as they show that the presented methodology is able to capture the traffic dynamics independently from the moving-to-stationary user ratio, at least in the low-to-moderate congestion situations given in Luxembourg City. The full paper will also show results of simulations where the demand is significantly increased to create more significant congestion patterns.

References

- [1] N. Geroliminis and C. F. Daganzo, "Existence of urban-scale macroscopic fundamental diagrams: Some experimental findings," *Transportation Research Part B: Methodological*, 42(9):759-770, 2008.
- [2] N. Geroliminis, J. Haddad, and M. Ramezani, "Optimal perimeter control for two urban regions with macroscopic fundamental diagrams: A model predictive approach," *IEEE Transactions on Intelligent Transportation Systems*, 14(1):348-359, 2013.
- [3] H. Bar-Gera, "Evaluation of a cellular phone-based system for measurements of traffic speeds and travel times: A case study from Israel," *Transportation Research Part C: Emerging Technologies*, 15(6):380-391, 2007.
- [4] N. Caceres, L. M. Romero, F. G. Benitez, and J. M. del Castillo, "Traffic flow estimation models using cellular phone data," *IEEE Transactions on Intelligent Transportation Systems*, 13(3):1430-1441, 2012.
- [5] L. Codeca, R. Frank, S. Faye, and T. Engel, "Luxembourg SUMO Traffic (LuST) Scenario: Traffic Demand Evaluation," *IEEE Intelligent Transportation Systems Magazine*, 9(2): 52-63, 2017.
- [6] D. Krajzewicz, J. Erdmann, M. Behrisch, and L. Bieker, "Recent development and applications of SUMO - Simulation of Urban MObility," *International Journal On Advances in Systems and Measurements*, 5(3&4): 128-138, 2012.
- [7] Derrmann, T., Frank, R., Engel, T., and Viti, F. (2017a). How mobile phone handovers reflect urban mobility: A simulation study. In 2017 5th IEEE International Conference on Models and Technologies for Intelligent Transportation Systems (MT-ITS), pages 486-491.

3.5.6 Traffic state estimation and prediction at signalized intersections based on connected vehicles

E. PAPAPANAGIOTOU^a, L. COCONEA^b

^a *Technical University of Munich, Arcisstraße 21, Munich 80333, Germany*

^b *SWARCO Mizar S.p.A. – Via Nizza, 262/57, Turin, Italy*

The state of the art in dynamic traffic management and control applications utilize traffic flow models to estimate, predict and optimize traffic flow [1, 2]. The emergence of vehicle connectivity and automation is expected to revolutionize the future motorway and urban traffic systems. Connected and Automated Vehicles (CAV) become potentially new data sources that can deliver new measurements of high quality, such as individual speeds, accelerations, gaps between vehicles and interaction with the surrounding environment. At the same time, these vehicles become potentially also new actuators considering the possibility to inform or even control individual vehicles. The extension of both sensors and actuators allows for new control goals that go beyond the mere minimization of total travel time (e.g. increase safety, decrease emissions etc.).

Despite the limited practical applications of Connected Vehicles (CV) as new data sources for Urban Traffic Control (UTC) systems (due to the very low penetration rates), there have been several simulation studies published on the topic [3]. Some common crucial points emerge from the literature, such as the importance of the penetration rate in the effectiveness of the developed algorithms, the challenge in estimating the position of unequipped vehicles, the significance of queue length estimation and the implications from the coordination between signalized intersections.

The research project **CENTAURO** (Connected Environments for Negotiated Traffic Control And Urban Optimization) deals with the evolution from conventional to the next generation UTC systems. The first step for this evolution and the main goal of CENTAURO is the optimal traffic state estimation and prediction for traffic signal control by capitalizing on the new sensing and communication capabilities from CV. In particular, the focus of this paper is the estimation of the queue length, the departure rate and the arrival rate at signalized intersections based on information coming from limited number of CV.

To achieve that goal, a robust sensor and data fusion methodology is needed that offers the mathematical flexibility for extensions but is at the same time relatively easy to formulate for real traffic control systems. Hence, the well-known Extended Kalman Filter (EKF) that has many successful applications in the field of dynamic traffic management and control [4] is selected to be the foundation of the developed methodology. In related work in the scope of this project, there have been already some very promising results from EKF implementations in the estimation of turning rates at signalized approaches for all vehicles (equipped and unequipped) based on information coming only from a limited number of CV [5].

This work builds on existing Queue Length Estimators (QLE), such as EVLS (Estimation of Location and Speed) proposed by Feng in [6] and other QLE based on CV proposed by Comert [7]. EVLS constructs a complete prediction arrival table for all vehicles and estimates the queue length based on CV data. The signalized approach is divided in three segments: queuing region, slow-down region and free-flow region. For higher penetration rates (>50%), the EVLS shows positive results (e.g. 10-15% reduction of total vehicle delay in comparison to actuated control). However, EVLS requires at least one connected vehicle in each region, leading sometimes to negative results (e.g. +5% increase of queue length in comparison to actuated control) in cases of lower penetration rate (25%). This paper uses the EKF approach to improve the traffic state estimation at intersections coming from existing QLE algorithms, especially for situations where CV are not constantly (i.e. every signal cycle) available at the intersection (e.g. for low penetration rates).

Moreover, in this paper the enhanced traffic state estimation and prediction is fed in the adaptive UTC system Utopia/Spot from Swarco AG. Figure 1 shows the developed technical architecture in the simulation environment. Utopia/Spot provides on the one hand a solid scientific basis since it originates from control theory and utilizes a model-based, rolling horizon, decentralized approach. On the other hand, it is a proven robust system with numerous real-world implementations. Spot contains the main intelligence and is performing the local control at intersection level, whereas Utopia is the central system that performs the network control. The traffic state estimation in Spot includes the estimation of queue lengths, predicted arrivals (2 minutes' rolling horizon), turning rates and clearance capacity at the signalized approach.

Figure 41. Technical architecture of Centauro

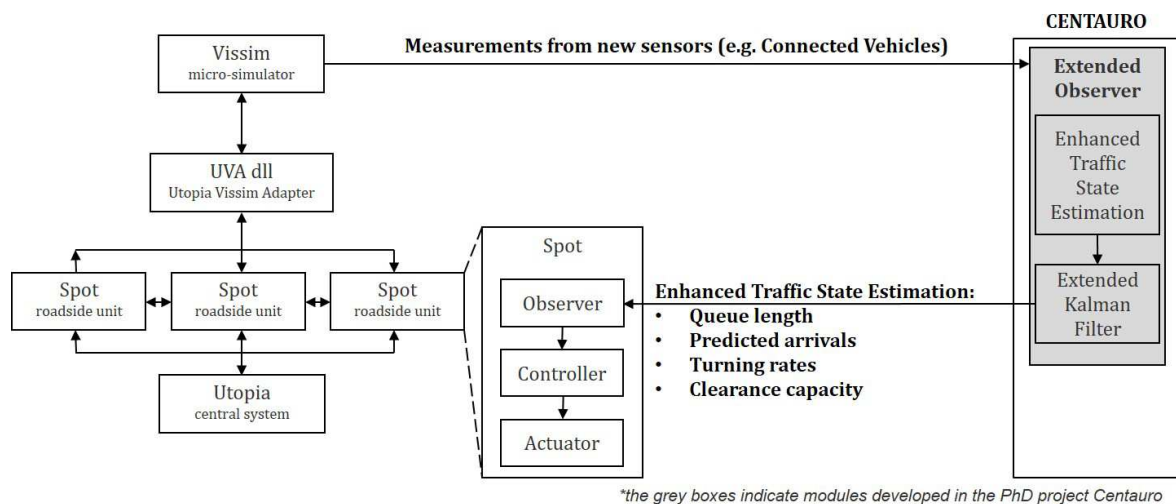

Source: Own elaborations.

The preliminary results of the developed methodology show an improved estimation in comparison to the use of the QLE algorithms without the EKF. The enhanced estimation consists of queue length, arrival rate and departure rate even for signal cycles where CV are not present. The future work includes evaluation of the estimation based on CV in comparison to the estimation coming from inductive loop detectors (from Utopia/Spot). Last but not least, the enhanced estimation will be fed in Utopia/Spot and the resulting signal control will be evaluated for different scenarios (varying traffic demand and penetration rates) in microscopic simulations.

References

- [1] Yuan, Y., van Lint, J. W., Wilson, R., van Wageningen-Kessels, F., & Hoogendoorn, S. P. (MARCH 2012). Real-Time Lagrangian Traffic State Estimator for Freeways. IEEE TRANSACTIONS ON INTELLIGENT TRANSPORTATION SYSTEMS, VOL. 13, NO. 1.
- [2] Papageorgiou, M. (1998). Automatic Control Methods in Traffic and Transportation. In M. L. al., Operations Research and Decision Aid Methodologies in Traffic and (S. 46-83). Berlin Heidelberg: Springer-Verlag.
- [3] Jing, P., Huang, H., & Chen, L. (September 2017). An Adaptive Traffic Signal Control in a Connected Vehicle Environment: A Systematic Review. Information, S. Volume 8, Issue 3.
- [4] van Lint, H., & Djukic, T. (14-17. October 2012). Applications of Kalman Filtering in Traffic Management and Control. 2012 Tutorials in Operations Research: New Directions in Informatics, Optimization, Logistics, and Production, S. 59-91.

[5] Feng, Y., Head, K. L., Khoshmaghani, S., & Zamanipour, M. (2015). A real-time adaptive signal control in a connected vehicle environment. *Transportation Research Part C*, 460-473.

3.6 Parallel Session 5a - Traffic Control

3.6.1 An application of shock wave theory to urban traffic modeling and control via dynamic speed advisory

G. DE NUNZIO^a, P.O. GUTMAN^b

^a *IFP Energies nouvelles – Control, Signal and System Department, Solaize, France, giovanni.de-nunzio@ifpen.fr*

^b *Faculty of Civil and Environmental Engineering, Technion – Israel Institute of Technology, Haifa, Israel, peo@technion.ac.il*

Introduction

The main theoretical work on kinematic waves was conducted by [1]. Given flow and density upstream and downstream from the shock wave, its propagation velocity was calculated analytically. The importance of this finding is that if the traffic states are known, then their future evolution can be easily predicted by describing the boundary (i.e. shock wave speed) between them. This insight was used by [2] for the study of shock waves on highways, and by [3] in the Cell Transmission Model (CTM) derivation. The first attempt to use shock wave theory for traffic control was presented by [4] in order to propose a quick control scheme to resolve jams on highways by means of variable speed limits. Similar ideas were also used in a variable-length CTM-like model [5] proposed for congestion regulation on highway road stretches. An adaptation of this model to the urban traffic, with boundary flows enabled by cyclic traffic signals, was proposed by [6]. However only the evolution of upstream congestion boundaries was considered, and downstream rarefaction waves were neglected. In this work, an algebraic model of the traffic evolution on urban road sections is proposed. The model is able to provide a solution of traffic density and flow distribution without solving differential equations, therefore the computational burden is drastically reduced. This is particularly desirable for large-scale traffic optimization. An energy consumption model and a travel time model have been adapted to the proposed traffic model and used for performance optimization in an urban scenario.

Modeling approach

In urban traffic, it is reasonable to assume that flows are generated by traffic lights or intersections, and inflows and outflows of a road segment are pulses starting at discrete time instants. Also, it is possible to assume that a road section represents an elementary segment of the traffic network, meaning that no exogenous flows are allowed within the segment. Under such conditions, the road segment can be decomposed into cells, then during a finite time interval each cell state (i.e. density) is defined by one point on the fundamental diagram (FD). Hence the slope between the FD points of two neighboring cells will be constant over the said finite time interval. According to the shock wave theory, this slope gives the propagation speed of the front between the cells. Note that the cell density remains constant as long as the cell exists. Furthermore, it is important to observe that signalized intersections may present very complex phases during a traffic light cycle, therefore the inflow of a particular road section may be determined by several movements. Thus, the green light duration enabling boundary flows may be thought of as an equivalent duration which comprises all the movements entering or leaving the section. To resume, in order for traffic dynamics to be described algebraically, the following assumptions must hold: the FD of the road section is known; the initial traffic conditions are known; the traffic signals timings are known. Although these assumptions may seem stringent today, future connectivity and automation in traffic and mobility will be able to easily provide such information.

Application

The proposed modeling approach is able to analytically provide the position and the evolution of the different congestion fronts. Thanks to this knowledge, macroscopic

energy consumption models and travel time models can be improved in order to take into account queuing phenomena (i.e. stop and start behavior). The objective of this work is to find the optimal speed limits in the different road sections of the road network that, given some traffic conditions, minimize a combination of the aforementioned performance criteria: energy consumption and travel time.

Preliminary results for one road segment in Figure 42 show that the proposed model is able to capture and reproduce the same traffic pattern as obtained via the CTM model used as a reference. For the two models the initial traffic state was set to have an empty cell upstream, a fully congested cell downstream, and an initial queue length of 100m. The boundary flows are enabled by equally timed traffic lights.

Figure 42. Comparison of the CTM and the proposed model in a distance-time diagram

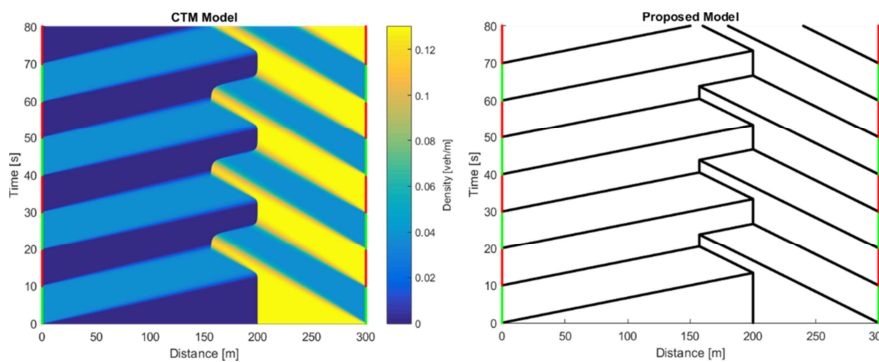

Source: Own elaborations.

In order to have an insight into the solution of the optimization problem, the evaluation of the objective function (i.e. a weighted sum of energy consumption and travel time) is displayed in Figure 43. It is interesting how the overall performance is minimized for different speed limits depending on the initial queue length inside the road section. Note that the results surface is not fully monotone due to the traffic lights offset effect, which can be captured by the proposed traffic model.

Figure 43. Overall traffic performance over a cycle time as a normalized weighted sum of mean energy consumption and travel time

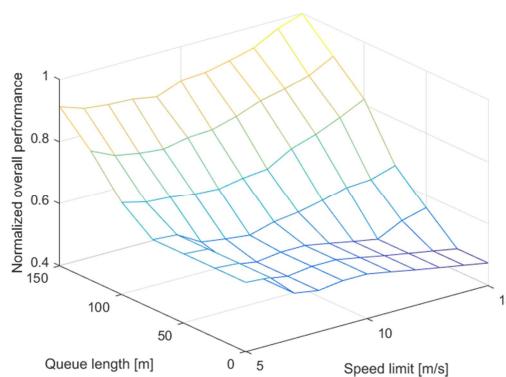

Source: Own elaborations.

References

- [1] M. J. Lighthill and G. B. Whitham. On Kinematic Waves. I. Flood Movement in Long Rivers. *Proceedings of the Royal Society A: Mathematical, Physical and Engineering Sciences*, 229(1178), 1955.
- [2] P. I. Richards. Shock Waves on the Highway. *Operations research*, 4(1): 42-51, 1956.
- [3] C. F. Daganzo. The Cell Transmission Model: A Dynamic Representation of Highway Traffic Consistent with the Hydrodynamic Theory. *Transportation Research Part B*, 28(4):269-287, 1994.
- [4] A. Hegyi, S. P. Hoogendoorn, M. Schreuder, H. Stoelhorst, and F. Viti. SPECIALIST: A Dynamic Speed Limit Control Algorithm Based on Shock Wave Theory. In *IEEE 11th Conference on Intelligent Transportation Systems*, pp. 827-832, 2008.
- [5] C. Canudas de Wit. Best-Effort Highway Traffic Congestion Control via Variable Speed Limits. In *IEEE 50th Conference on Decision and Control and European Control Conference*, pp. 5959-5964, 2011.
- [6] G. De Nunzio, C. Canudas de Wit, and P. Moulin. Urban Traffic Eco-Driving: A Macroscopic Steady-State Analysis. In *European Control Conference*, pp. 2581-2587, 2014.

3.6.2 Dynamic Emergency Lane Control

M. TIEBLER^a, B. BRACHER^a, K. BOGENBERGER^a, J. GRÖTSCH^b

^a Bundeswehr University Munich

^b Autobahndirektion Südbayern

The first minutes after an accident can be crucial. Every delay on the journey of the rescue team can have severe consequences for victims. Unfortunately, accidents often lead to congestions which impede the journey of rescue teams. To prevent emergency vehicles from getting stuck in traffic jam, German traffic regulations oblige drivers to form an emergency corridor on the right side of the leftmost lane. This means that the cars on the leftmost lane have to drive on the left side of the road and all other vehicles have to drive as far right as they can. Drivers are obliged to form an emergency corridor as soon as congestion occurs. Nonetheless, emergency teams are often facing problems getting through the congestion on their way to the accident because no appropriate emergency corridor is formed.

To improve this situation various measures are discussed. One of this measures is to display an advice to build an emergency corridor (German: "Rettungsgasse"), using the lane control systems (LCS), at the position where the emergency corridor should be formed as pictured in Figure 44. The figure shows a congested highway with dynamic emergency lane control and an ambulance using the emergency corridor.

Figure 44. Dynamic emergency lane control [1]

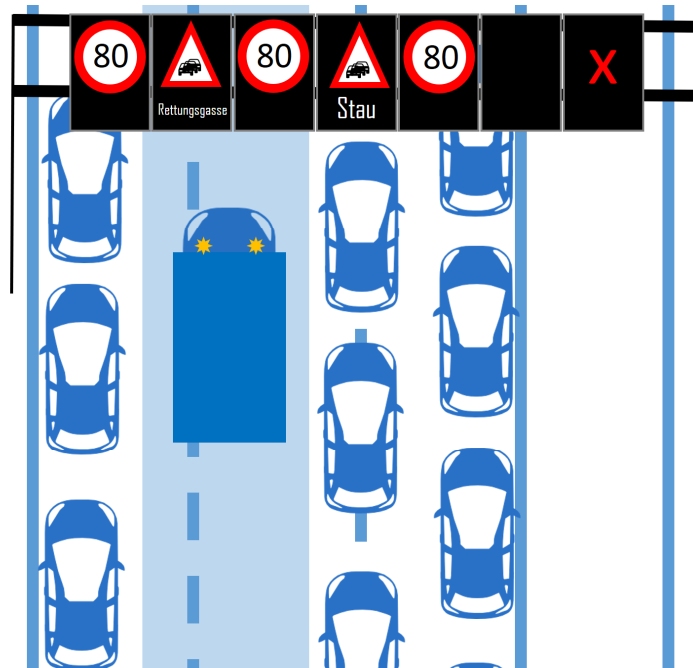

Source: Own elaborations.

According to the MARZ [2], lane control systems are controlled by a 4-step control mechanism (see Figure 45). Traffic data, like speed and number of vehicles, are measured at 60-second intervals. Based on the analysis of the traffic data and weather, the traffic control units of each cross section develop proposals for the LCS, based on predefined conditions and algorithms, calculated for each traffic lane individually. For the cross-alignment of each cross section, the proposals are prioritized and the most restrictive proposals are selected for the whole cross section. The selected proposals are then compared to the other proposals on this route. In this longitudinal-alignment, the system checks whether the arrangements of the advices comply with all given

restrictions before they are displayed in the LCS. The control procedure INCA [3] adds several mechanisms that help improving the traffic control in terms of congestion detection and traffic harmonization.

Figure 45. Control Algorithm [3]

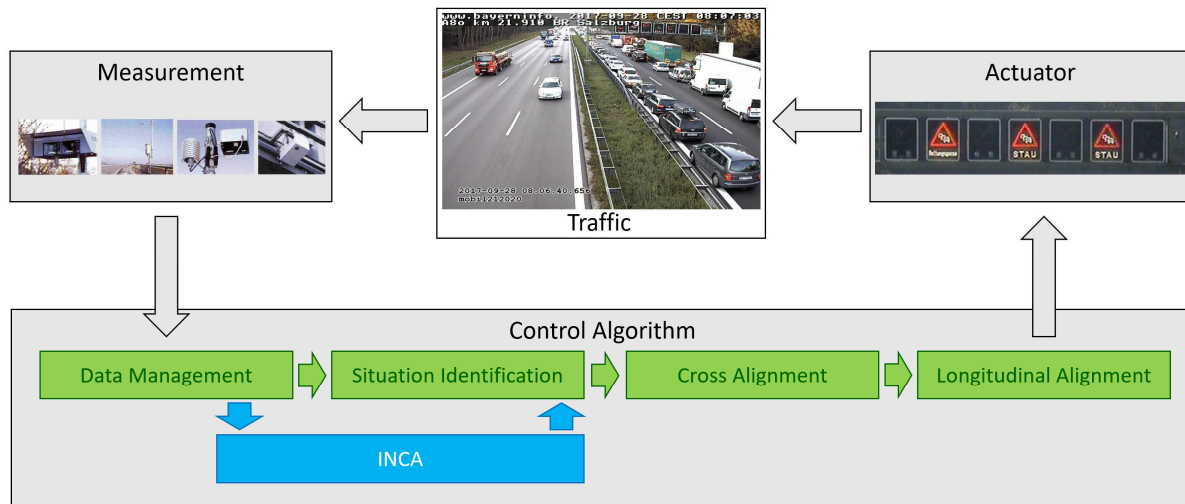

Source: Own elaborations.

The main objective of this study is to investigate whether the “Rettungsgasse” advice has a significant impact on the behaviour of drivers in congestion, and leads to an improvement of the situation. The procedure we follow to evaluate the emergency corridor in congestion is depicted in Figure 46. After relevant days with congestion are selected based on traffic data like contour plots, we analyse the emergency corridor based on webcam pictures in two minute intervals. The pictures originate from three stations on the highway A8 between the interchanges Munich and Holzkirchen, with two cameras each, one with direction of sight to Munich, the other one to Salzburg. For the analysis the range visible on the pictures is divided into 200m sections. The condition of the observed emergency corridor is classified in three categories: emergency corridor passable, conditionally passable and not passable. Additionally, we developed a short questionnaire handed out to rescue teams, in order to get their feedback and their impression how they managed to use the emergency corridor. This data is used to validate the results.

To assess the impact, the project investigates three phases. The first phase reflects the initial situation without the advice to form the corridor. In the second phase the advice is shown, but with substantial delay. In the third phase, the display speed parameter for the advice is increased so that the advice is displayed immediately when the speed drops.

In the progress of analysis, we face several problems. Due to privacy concerns, the pictures of the webcams have low resolution, which limits the visible range. In the darkness, the head- and tail lights dazzle the cameras so that the pictures show only a blaze of light. Reflections on wet streets and sunrise or sundown have similar effects. Furthermore, the speed, especially the moment congestion occurs, is hard to estimate, as the pictures are given every 60 seconds. Congestion is identified by analysing the given contour plots and the distance of the car. Since drivers in Germany do not always comply to the minimum required distance, it is hard to distinguish between slow-moving traffic and traffic jam.

Since the advice in the second phase is displayed with a large delay, traffic is already jammed when the advice is displayed, preventing the drivers to efficiently react to it.

With the expected low impact of the advice in the second phase, we finally compare the first and the third phase.

Preliminary results of the analysis are promising; final results are presented at the Symposium on Management of future motorway and urban traffic systems (MFTS).

Figure 46. Evaluation procedure

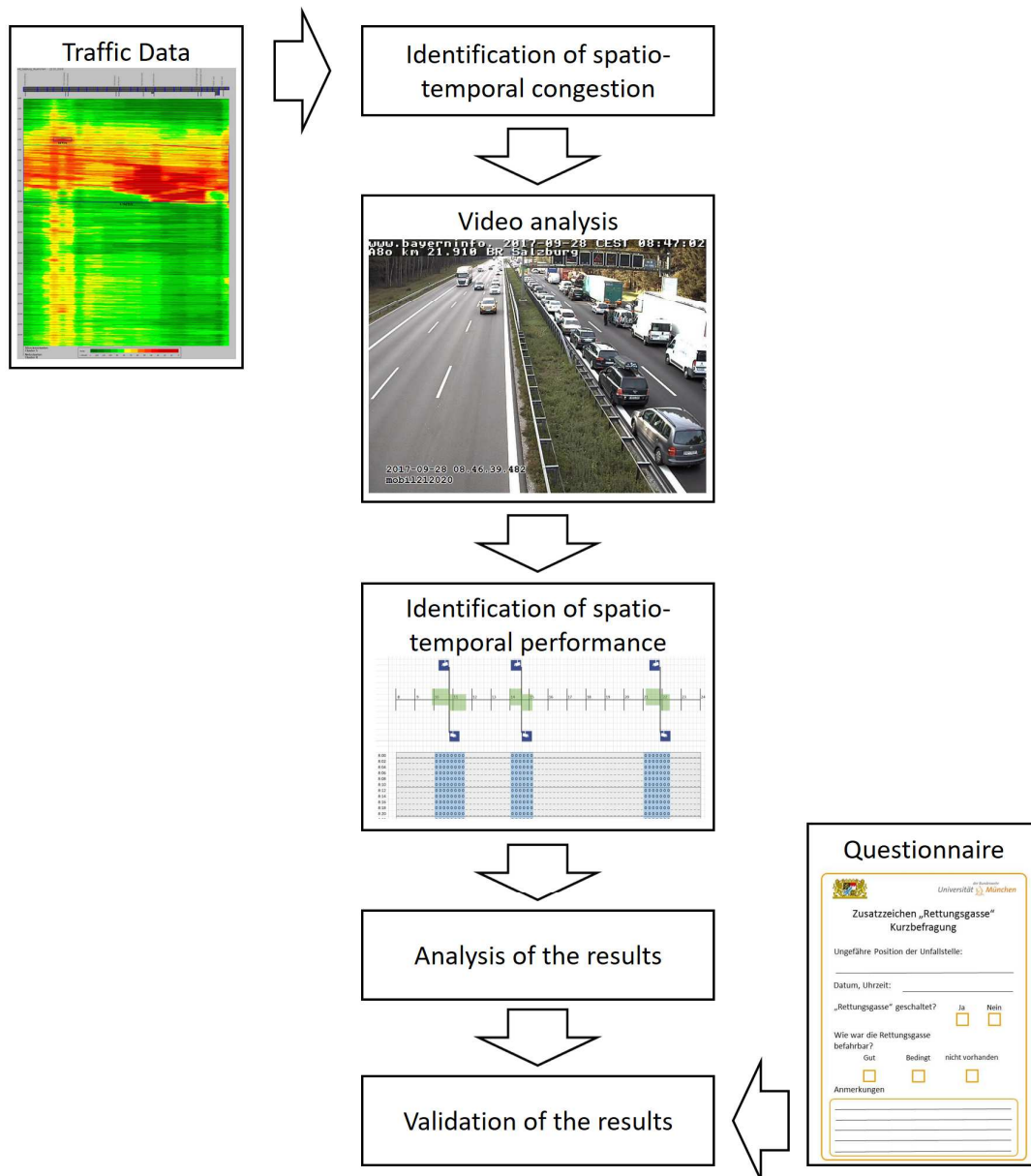

References

- [1] Icons made by [Freepik](#), [Butterflytronic](#) from www.flaticon.com is licensed by [CC 3.0 BY](#)
- [2] Bundesanstalt für Straßenwesen (1999) Merkblatt für die Ausstattung von Verkehrsrechnerzentralen und Unterzentralen (MARZ)
- [3] Samuel Denaes, Andrea Schieferstein, Stefanie Rieß, Peter Ermer (2009) Neue Methoden zur Steuerung von Streckenbeeinflussungsanlagen – Teil 2: Das neue Steuerungsverfahren INCA. Straßenverkehrstechnik 4. 2009

3.6.3 FF-ALINEA: A ramp metering control strategy for nearby and distant bottlenecks

J. R. D. FREJO^a, B. DE SCHUTTER^a

^a Delft Center of Systems and Control, Delft University of Technology

Introduction

Traffic congestion on freeways causes many social and economic problems like waste of time and fuel, a greater accident risk, and an increase in pollution. In many cases, the use of dynamic control signals such as ramp metering may be an economical and effective solution for addressing these issues.

This paper proposes a new ramp metering control algorithm, Feed-Foward ALINEA (FF-ALINEA), for bottlenecks located both nearby on an on-ramp and further away from it (i.e. more than just a few hundred meters). The formulation of the controller is based on a feed-forward modification, using the control structure shown in Figure 47, of the well-known control algorithm for ramp metering, ALINEA [1]. The feed-forward structure allows to anticipate on the future evolution of the bottleneck density in order to avoid or reduce traffic breakdowns:

Figure 47. Control structure for ALINEA (left) and FF-ALINEA (right), where $\hat{\varphi}(k)$ is a time-varying density set-point used by FF-ALINEA

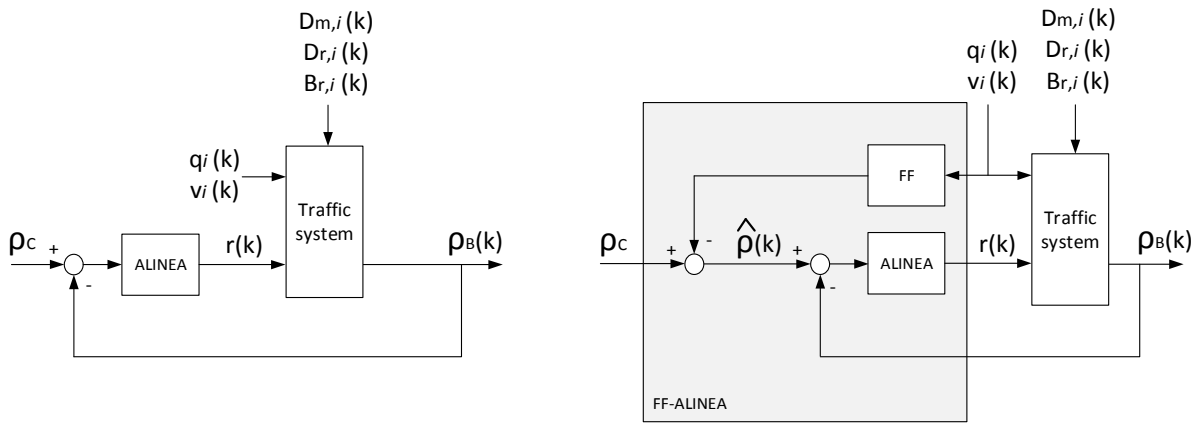

Source: Own elaborations.

FF-ALINEA

For a given on-ramp, the control law for the implementation of FF-ALINEA at time step k is:

$$r(k+1) = r(k) + K_{FF}(\hat{\varphi}(k) - \varphi_b(k))$$

where $r(k)$ is the ramp metering rate, $\varphi_b(k)$ is the density measurement collected at a bottleneck downstream of the controlled on-ramp, and K_{FF} is a positive parameter. Unlike ALINEA, the computation of the density set-point $\hat{\varphi}(k)$ used by FF-ALINEA is time-varying:

$$\hat{\varphi}(k) = \varphi_{b,c} - \max\left(\frac{L_A}{\lambda_b L_b \hat{v}_A(k)} (Q_{ib}(k) - C_b), 0\right)$$

where L_b , L_A , and λ_b are parameters that are based on the network topology, $\varphi_{b,c}$ is the critical density of the bottleneck, C_b is the capacity of the bottleneck, $Q_{ib}(k)$ is the flow entering the bottleneck during a considered period T_A , and $\hat{v}_A(k)$ is the mean speed upstream the bottleneck during T_A . Note that $Q_{ib}(k)$ and $\hat{v}_A(k)$ have to be estimated on-line using measurements available from detectors located upstream of the bottleneck.

The main advantage of FF-ALINEA, compared with previously proposed controllers such as ALINEA [1] and PI-ALINEA [2], is that the proposed controller is able to activate ramp metering before the bottleneck is congested in case that the flow arriving to the bottleneck is higher than its capacity.

Case study

The proposed controller is tested for a simple network that includes one on-ramp located upstream (7 kms) of a bottleneck and using the macroscopic traffic flow model METANET [3]. We consider 9 scenarios and compare the results with the ones obtained with ALINEA, PI-ALINEA, and an optimal controller.

Table 4. Average Total Time Spent (TTS) reduction for the 9 simulated scenarios

Uncontrolled	Optimal	ALINEA	PI-ALINEA	FF-ALINEA
0%	-31.8 %	-10.3 %	-19.4 %	-30.6 %

Source: Own elaborations.

As can be seen in Table 4 and Figure 48, the simulation results show that FF-ALINEA is able to approach the optimal behavior, thereby outperforming ALINEA and PI-ALINEA. Moreover, additional simulations indicate that FF-ALINEA is quite robust in cases where different demands are considered, there is a limited number of available detectors, or there are errors in the estimation of the capacity and/or the critical density of the bottleneck.

Figure 48. Ramp queues (left) and bottleneck densities (right) for Scenario 1

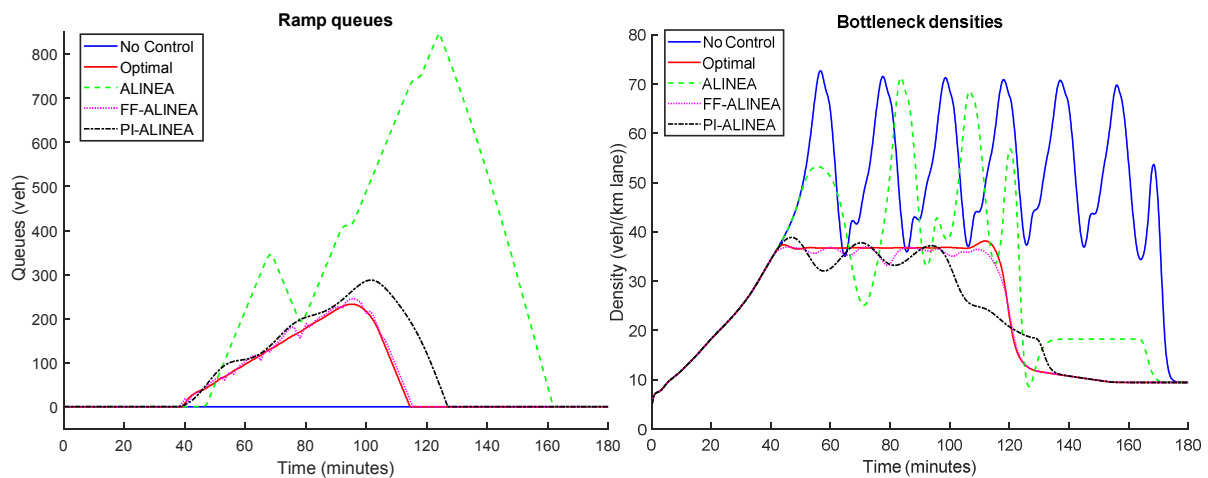

Source: Own elaborations.

Acknowledgements

This research was supported by the European Union's Horizon 2020 research and innovation programme under the Marie Skłodowska-Curie grant agreement No 702579.

References

- [1] M. Papageorgiou, H. Hadj-Salem, and J.M. Blosseville, *ALINEA: A local feedback control law for on-ramp metering*, Transportation Research Record: Journal of the Transportation Research Board, no. 1320, pp 58-67, 2001.
- [2] Y. Wang and M. Papageorgiou, *Local ramp metering in the case of distant downstream bottlenecks*, IEEE Conference on Intelligent Transportation Systems, pp. 426-431, Toronto, Canada, 2006.
- [3] M. Papageorgiou, I. Papamichail, A. Messmer and Y. Wang, *Traffic simulation with METANET*, Fundamentals of Traffic Simulation, Springer, 2010.

3.6.4 Integrated Motorway Traffic Control Using Variable Speed Limits and Lane Change Control

V. MARKANTONAKIS^a, D. SKOUFOULAS^a, I. PAPAMICHAIL^a, M. PAPAGEORGIU^a

^a *Dynamic Systems and Simulation Laboratory, Technical University of Crete, 73100 Chania, Greece*

Motorway traffic congestion, typically initiated at bottleneck locations, is a major problem for modern societies, causing serious infrastructure degradation. The most efficient way to mitigate this problem is the development and implementation of proper traffic control strategies.

Bottleneck locations can be motorway merge areas, areas with a particular infrastructure layout (such as lane drops, strong grade or curvature, tunnels or bridges etc.), areas with specific traffic conditions (e.g. strong weaving of traffic streams) or areas with external capacity-reducing events (e.g. work-zones, incidents). If the arriving demand is higher than the bottleneck capacity, the bottleneck is activated, i.e. congestion is formed upstream of the bottleneck location. It should be emphasised, however, that, according to empirical investigations, capacity flow in conventional traffic is not reached simultaneously at all lanes. Thus, traffic breakdown may occur on one lane, while capacity reserves are still available on other lanes. This implies that the potentially achievable cross-lane capacity is not fully exploited. Naturally, once congestion appears on one lane, it spreads fast to the other lanes as well, as drivers on the affected lane attempt to escape the speed drop via lane changing. After congestion has occurred, retarded and different vehicle acceleration at the congestion head causes the so-called capacity drop phenomenon, which breeds a reduction in the mainstream flow of a motorway, while a queue is forming upstream of the bottleneck location.

In the near future, Vehicle Automation and Communication Systems (VACS) are expected to revolutionise the features and capabilities of individual vehicles. The new features can be exploited via recommending, supporting, or even executing appropriately designed traffic control tasks. Vehicles equipped with VACS may act both as sensors (providing information on traffic conditions) and as actuators, permitting the deployment of strategies like variable speed limits (VSL) and lane-changing control (LCC). Note that, while VSL control is feasible by means of conventional control infrastructure, employing Variable Message Signs (VMS), LCC is not feasible with conventional means, because it calls for the possibility to communicate with few individual vehicles, rather than with the whole vehicle population as by use of VMS.

This work proposes and investigates via microscopic simulation the integrated use of two feedback control strategies utilizing VACS in different penetration rates, aiming at maximising throughput at bottleneck locations. The first control strategy employs Mainstream Traffic Flow Control (MTFC) using appropriate VSL that are communicated to all connected vehicles. The second control strategy delivers appropriate lane-changing actions to selected connected vehicles.

VSL can be used in order to regulate the mainstream flow upstream of bottleneck locations. A Proportional-Integral (PI) feedback regulator is employed, keeping the bottleneck density close to the selected set-point that maximises the bottleneck throughput [1]. Connected vehicles may directly receive the value of the speed limit that is delivered by the control strategy, according to their current location in the network, and it is expected that, for sufficient penetration of equipped vehicles, this will be sufficient to impose the speed limit to non-equipped vehicles as well; hence, no VMS-gantries would be necessary. Several practical VSL implementation aspects are taken into account.

LCC is a promising new strategy that can be exploited for traffic management [2]-[3]. This control strategy aims at the distribution of traffic flow among the lanes in the immediate proximity of a bottleneck, so as to exploit the capacity of each and every lane, thus increasing the overall (cross-lane) capacity. To this end, a linear state-feedback

control law, resulting from an appropriate linear-quadratic regulator problem formulation, is developed. The considered system under control comprises a number of interacting segment-lanes upstream of the bottleneck; while the feedback control law computes adequate lateral (lane-changing) flows for each segment-lane, thus enabling an opportune, pre-specified distribution of traffic flow among the lanes. More specifically, the feedback control law uses real-time measurements (or estimates) of the state of the system, i.e. of all segment-lane densities, and is targeting appropriate pre-specified set-points of lane-based traffic densities.

Summarizing, LCC achieves appropriate lane assignment of vehicles upstream of the bottleneck so as to increase the bottleneck capacity; while MTFC via VSL guarantees that the flow approaching the bottleneck location is not exceeding the overall (increased) capacity of the bottleneck. Investigations of the proposed integrated scheme have been conducted using a microscopic simulator (AIMSUN) for a hypothetical motorway featuring a lane-drop bottleneck. The produced results demonstrate significant improvements for all performance indexes considered.

Acknowledgement

This work was supported by the European Research Council under the European Union's Seventh Framework Programme (FP/2007-2013) within the Project TRAMAN21 under Grant 321132.

References

- [1] Papamichail, I., Papageorgiou, M. and Stamatakis, I., Feedback traffic control at highway work zones using variable speed limits. *15th IFAC Symposium on Control in Transportation Systems (CTS 2018)*, Savona, Italy, June 6-8, 2017.
- [2] Roncoli, C., Bekiaris-Liberis, N. and Papageorgiou, M., Optimal lane-changing control at motorway bottlenecks. *IEEE 19th International Conference on Intelligent Transportation Systems (ITSC)*, pp. 1785-1791, Rio de Janeiro, Brazil, November 1-4, 2016.
- [3] Roncoli, C., Bekiaris-Liberis, N., and Papageorgiou, M. (2017). Lane-changing feedback control for efficient lane assignment at motorway bottlenecks. *Transportation Research Record*, No 2625, pp. 20–31, 2017.

3.7 Parallel Session 5b - Traffic Management

3.7.1 A social community approach to traffic management

J. VREESWIJK^a, R. VAN DEN DRIES^a, N. RODRIGUES^a

^a MAP Traffic Management

Social media offers a wealth of mobility-related information and an ultimate instrument for day-to-day traffic management. Nine out of ten residents in the Netherlands are active users of social media. In 2016 the largest platforms were Whatsapp (9.8 million users) and Facebook (9.6 million users) and Twitter. More than 15.000 mobility-related messages can be filtered from these platforms on a daily basis. Using such information in day-to-day traffic management and by sharing mobility-related information through these platforms, traffic management and mobility management converge. The social community approach presented in this contribution (Livecrowd Mobility) offers a personalised traffic information service and traffic management platform, which is based on mainstream social media, and aims to best match demand and supply with the intend to improve travellers' comfort and ease road congestion. Livecrowd Mobility is also intended as a tool supporting road authorities and mobility service providers in their service provisioning interaction with travellers. The platform has a multi-modal approach, including Public Transport, bike or taxi services, to best match demand to capacity and user preferences.

Livecrowd Mobility is a personal assistant in your smartphone or on your computer. Its core purpose is to support visitors of an event, exhibition or even city with their journey. Besides offering mobility information and services, it does this by sharing content and relevant announcements tailored to the trip purpose of the travel. The rationale is to create a pleasant travelling experiences, which improves the perceived quality of, for example, an event. Compared to mass audience broadcast information services, this platform is effective because it targets a specific group of people, called a community. Communities consist of people which have something in common, e.g. they will visit the same event, live in the same area, make the same commute trip, etc.

Figure 49. Illustration approach Livecrowd Mobility



Source: Own elaborations.

Livecrowd Mobility can be configured to support a community to provide answers to community specific questions. For example, the location of entrances, Kiss-and-Ride locations, parking locations and the purchase of parking tickets, route and modality information, recommended arrival time, bars and restaurants in the area, etc. The use Livecrowd Mobility does not require a new app, but can be done through existing commonly used social media channels and communication apps like Whatsapp, Twitter, Facebook, Snapchat, Google Allo, Apple iMessage, etc. Since most people already use

these channels, Livecrowd Mobility is easily accessible. The operators at the Livecrowd Mobility centre are in constant contact with event organizers, the venue owner, road authorities and even the police, ensuring that every question can be answered quickly and with an answer that is valid for the current or upcoming situation.

Aforementioned approach was successfully applied for the first time at the ArenaPoort area in Amsterdam, which includes a football stadium (Johan Cruyff Arena) and several concert venues. The area accommodates up to 80.000 visitors at peak times when several large audience events take place simultaneously. In this case the relevant community consists of concert visitors, which could be easily identified through social media "posts" and "likes" related to the concert, activity within a geofenced area or identified during their on-line ticket purchase through the concert organizer. Through Livecrowd Mobility visitors were pro-actively informed about travel options, traffic flow, accessibility, time tables, parking options, etc. Reversely, visitors were able to contact the Livecrowd Mobility service centre to ask for specific information related to their mobility needs. Experience is that for 80% of the requests and comments, the answers can be prepared beforehand and answered in a personal way. For the remaining 20%, 1 to 1 communication by a human operator is needed to answer specific questions, such as pick-up locations, routes, finding parking areas, travel options, etc. An important added value of the traffic centre is that detailed knowledge of the traffic system of the area is available and continuously monitored in real-time. This allows to immediately anticipate to any type of delay, disruption or expected traffic flow developments and provide pre- and on-trip information to travellers.

Livecrowd Mobility also has been deployed for a large scale road maintenance and reconstruction project. During this 5-year project for the construction of a new tunnel to connect two highways while passing a urban area, Livecrowd Mobility is being used as the primary communication channel towards travellers and surrounding communities. Among others, motorists are informed on the latest road layouts, traffic information, most optimal route in space and time, while alternatives are provided. First findings are that a well informed traveller passing the worksite has a higher awareness of possible delays and obstructions, which contributes to a more positive experience and acceptance of possible delays and obstructions. Moreover, more aware and satisfactory travellers are more willing to follow recommendations and instructions, thereby adjusting their travel plans. In a later stage Livecrowd Mobility will also function as a virtual visiting centre for the project. By providing digital content of various kind people are able to experience the project and get a closer insight in the work done. In this way, a well-informed and supportive community becomes part of the project, knowing what is going on, what to expect, when to travel and when not.

Ongoing and future work to extend the platform include interactive traffic management and mobility-as-a-service (MaaS). With the right data, it is possible to know when people plan to travel, with what purpose, where they will travel to and at what time. Especially for clearly demarcated areas (e.g. the area near an event or the area affected by construction works) information can then be used to generate a short-term traffic prediction and to estimate where the bottlenecks will first appear. By triggering travellers to travel earlier, later or in a specific way, it is possible for a traffic manager to 'slot' traffic, similar to what is done by an air traffic controller. This will resolve the peak traffic and will eventually create a more fluent traffic flow. Already succesfully piloted with Livecrowd Mobility to nudge travellers to alternative behaviour is to give incentives like discounts in collaboration with local bars and restaurants around the venue or along the route, or reduced fees for public transport and parking at certain hours. Slotting traffic may also be applied for everyday commutes to avoid high traffic volumes at an enroute bottleneck. To increase the attractiveness of the Livecrowd Mobility service, the possibility to book and pay travel tickets, ultimately for any transport service, from train to shared bike to Uber taxi, will be added. Tickets will be provided as QR-codes or NFC-transactions through the same social media channels as mentioned earlier. In this way, a promising blend will be created between Livecrowd Mobility as personalised traffic information service and traffic management platform, and MaaS.

3.7.2 Traffic Management as a Service

P. MORLION^a, E. MARLIER^b

^a *Mobiliteitsbedrijf Stad Gent, on behalf of Traffic Management as a Service (TMaaS) Consortium, www.tmaas.eu*

^b *European Passenger Federation, <http://www.epf.eu/wp/>*

For over 40 years, the City of Ghent has been managing mobility through sustainable urban mobility policies. This resulted amongst other things in further expanding the large pedestrian area in the historic centre. Furthermore, in April 2017 all cross-City traffic arteries were cut to prevent car traffic from passing through the City centre. The City now plans to intensify its focus on multimodal journeys. The realisation of a multimodal traffic centre to inform citizens is a key element of the City of Ghent's latest mobility plan (Strategic Mobility Vision 2030).

A lot of small- to medium-sized cities around the world, like Ghent, want to get a grip on traffic and mobility. Building separate, traditional traffic management centres for all these cities is most likely not the answer. They require huge investments and people watching screens 24/7. On top of that, the majority of trips are not undertaken by car and cities want to encourage the use of public transport, walking and cycling in their mobility plans. How can this be achieved when the main focus of traffic management is on cars? And how can cities prepare for disruptive technologies when their traffic Control centres haven't changed a lot since the seventies? Will they be ready for Mobility As A Service (MAAS), self-driving cars and more in a hyper-connected world?

Ghent developed the Traffic Management as a Service (TMaaS) concept in order to monitor and manage traffic (for all transport modes). No lengthy investments in hardware installations are needed, the cloud-based platform processes multi-modal mobility information. The City works with world-class partners to collect and process innovative mobility data. The Traffic Management as a Service platform automatically analyses this information and notifies operators and citizens, strongly reducing the need to watch screens 24/7.

The platform will not be built specifically for Ghent, it will allow any city to connect, regardless of the stage of maturity of its traffic control centre. Once the TMaaS.eu platform has been established, the goal is that every small- to medium-sized city can subscribe and immediately get insights on mobility, manage traffic and communicate with citizens. The platform can be configured according to the city needs and local mobility policies.

The TMaaS platform will collect big data sets in the field of traffic, public transport, weather and many more sources and links cause and effect. Citizens can define their information needs and preferences by logging onto the platform. They receive up-to-date and personalised information, based on their preferences and actual location. The concept aims to deliver these messages through existing social media channels or messaging applications. The solution will include an option for citizens to send messages back to the platform, enabling the developers to better fine-tune the information and services.

As the platform will be monitoring the data as well as taking action (decision support) when things happen that deviate from the expectations, TMaaS will help save valuable time for the end user.

There is no need for large local investments, once the central platform is created that contains all the logic and makes tools available for both authorities and citizens. The single platform is always up-to-date and cheap, as it can be used by multiple authorities.

TMaaS is co-financed by the by the European Regional and Development Fund through the Urban Innovative Actions Initiative. The 3-year project is user-driven and takes a quadruple helix-approach (see Figure 50) to innovation where government, industry,

academia and civil participants work together to co-create the future and drive structural changes far beyond the scope of what any organization or person could do alone.

Figure 50. Quadruple helix approach

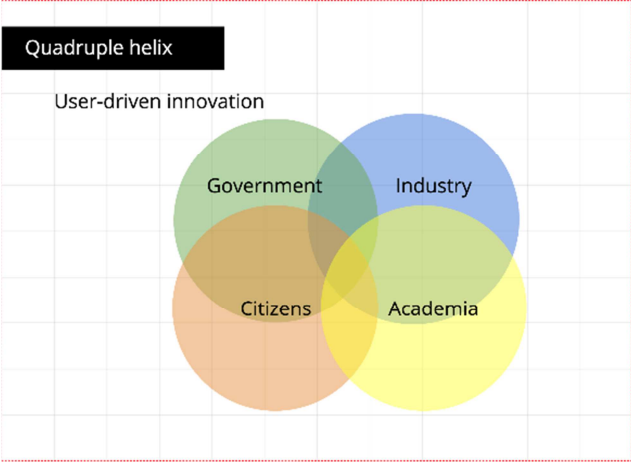

Source: Own elaborations.

3.7.3 Quantum AI-based traffic management system

P. GORA^a

^a *Faculty of Mathematics, Informatics and Mechanics, University of Warsaw*

Transport systems are becoming more and more complex: cities and numbers of roads and motorways are growing, similarly as the number of cars and devices integrated with the infrastructure, e.g., traffic detectors. In the future, the complexity will be even larger: cars will communicate with each other and with the road infrastructure, there will be more sensors and more data (transmitted and archived). Dealing with such complex systems is challenging, but the availability of traffic Big Data, growing computational power and rapid development of artificial intelligence bring also opportunities to develop innovative traffic management systems.

I propose an idea for a traffic management system harnessing the power of new technologies, e.g., modern artificial intelligence algorithms and quantum computers. The main concept is that we can use traffic simulations and machine learning algorithms to evaluate large number of traffic control settings (e.g., traffic signal control settings, offsets, route assignments, parameters controlling connected and autonomous vehicles (CAVs)), and this evaluation may be used by metaheuristics (genetic algorithms, simulated annealing etc) to find (sub)optimal settings for a given case.

To have a realistic traffic model and evaluate different settings with acceptable realism, we must collect large amount of traffic data, e.g., floating car data, traffic counts and travel speeds from cameras (installed close to roads or on drones), radars or inductive loops, weather data. From such data we can infer typical profiles of traffic (defined, e.g., as ranges of travel times on some road segments)[1]. For each identified traffic profile, we may calibrate microscopic traffic simulations able to evaluate the quality of different traffic control settings (travel times, times of waiting etc). Thanks to that, it is possible to explore a large space of possible settings, evaluate them using traffic simulations, find the one that may be (sub)optimal and set it as a default traffic control setting for a given profile. Since the size of the space of possible settings may be extremely large, we can reduce it by introducing constraints based on a domain knowledge (e.g., to have a "green wave" on some major roads), cluster settings being "close" (in a specific metric) and find optimal settings on a large area in a hierarchical way (similarly as in some existing traffic management systems [2]).

Also, in order to accelerate the evaluation procedure (done using traffic simulation), we can distribute computations on many cores, or randomly select some number of settings, evaluate them using traffic simulations run in parallel in a cluster of servers, and train machine learning algorithms (e.g., neural networks, tree boosting) aiming to approximate such outcomes very fast with a very good accuracy (there are theoretical and experimental justifications of that approach [3]). The number of outcomes should be high enough to do it efficiently (e.g., 10000 [3]), it is possible that within such large number of evaluated settings there will be already settings acceptable (e.g., ensuring with high probability that traffic jams will not occur), but they can be later even improved using metaheuristics (e.g., genetic algorithm, simulated annealing). These metaheuristics can already apply trained neural networks for evaluation of new settings, so may find optimal settings for given profiles much faster.

All the aforementioned computations can be run offline, but for a real-time traffic management, the time of computations becomes essential to respond to the changing traffic conditions efficiently. Thus, by collecting data in real-time, we may detect and predict (short-term) traffic profiles and apply default (optimal) traffic control settings (found offline) for each forecasted profile. In case of differences between real traffic and typical traffic profiles (some common traffic patterns exist, but there are also random fluctuations), we can retrain existing machine learning algorithms (e.g., using transfer learning) and find better settings for a given situation. To ensure robustness, the adaptation procedure should be run only after detecting or predicting that the current traffic control setting may be very inefficient. Therefore, it is important to have a good-

quality methods for detecting incidents and predicting traffic profiles in advance from real-time traffic data.

Experiments conducted in case of traffic signal settings proved that such approach gives very good results (e.g., finding traffic signal settings much better than random exploration) and can be applied for real-time traffic management ([3]). To accelerate the procedure, we can further apply additional techniques:

- active learning – retraining neural networks online on a small set of settings and adaptively adding new settings to the training set
- solving optimization problems on quantum computers [4]

The approach is universal, because it is data-driven and simulation-driven (domain knowledge is applied to reduce the space of possible settings, but it is possible that in the future all required constraints may be “learned” by machine learning algorithms, e.g., convolutional neural networks, just by analyzing a topology of the road network based on an image), so it can be applied in case of many scenarios, for different road network structures, different traffic signal settings, presence of electric vehicles, car-sharing, CAVs etc. Because the accuracy is dependent on traffic simulations, their calibration and conformity with the real traffic is very important. Thus, the method may be especially successful in the era of CAVs, because the knowledge of their algorithms of drive and interaction with the environment may lead to creating very accurate traffic models.

References

- [1] Liang Y., Jiang Z., Zheng Y., “Inferring Traffic Cascading Patterns”, [SIGSPATIAL/GIS 2017](#), pp. 2:1--2:10.
- [2] Mirchandani P., Head L., “A real-time traffic signal control system: architecture, algorithms, and analysis”, in “Transportation Research Part C: Emerging Technologies”, Volume 9, Issue 6, Dec.2001, pp. 415-432.
- [3] Gora P., Bardonski M., "Training neural networks to approximate traffic simulation outcomes", in "2017 5th IEEE International Conference on Models and Technologies for Intelligent Transportation Systems (MT-ITS), IEEE", pp. 889–894.
- [4] Neukart F., Compostella G., Seidel C., von Dollen D., Yarkoni S., Parney B., “Traffic Flow Optimization Using a Quantum Annealer”, DOI 10.3389/fict.2017.00029.

3.7.4 Coordination Models for Road Vehicle Automation. A Research Agenda

V. CAHILL^a

^a School of Computer Science and Statistics, Trinity College Dublin

Large-scale deployment of (semi-)autonomous vehicles (AVs) is now inevitable. However, the benefits of this deployment for traffic management in a world in which AVs and other vehicles will necessarily coexist remain unclear. Reduced congestion, greater energy efficiency, and improved resilience of the traffic system to unexpected events are expected. In this context, the hypothesis motivating our work is that full advantage of large-scale deployment of AVs for traffic management will only be achieved if AVs are designed to coordinate their behaviours with each other and with other vehicles [1].

For example, we are investigating the use of *slot-based driving* [2] as a model for coordinating connected and autonomous vehicles in order to optimize journey time predictability. In slot-based driving, each vehicle is allocated a location-based time slot in which to travel for the duration of its journey in a way not dissimilar to the way in which time-division multiple access (TDMA) is used in data communication systems to allocate slots to messages in transit.

While the use of TDMA-based scheduling is well established, a slot-based driving system must accommodate unexpected events that might impact on schedules ranging from cars that are not participating in the system or otherwise drive outside of their allocated slots, to vehicles that break down, to unexpected obstacles (e.g., pedestrians) appearing on the road. Hence, global scheduling will need to be supplemented by local real-time coordination of vehicles to accommodate rapid adaptation to such events allowing vehicles within an area to reschedule road usage in a way that is compatible with the global schedule.

Remaining within its assigned slot may be the responsibility of the driver or of an automated driving system. In the former case, the driver would be provided with feedback on the appropriate speed/lane at/in which to travel in order to remain within their slot via a driver-information system. Alternatively, a semi-autonomous approach may be adopted in which drivers retain control of vehicle steering while speed is controlled by a driver assistance system. In the case of fully autonomous vehicles, an automated driving system would be responsible for ensuring that the vehicle remains within its slot.

While our previous work considered only AVs operating in highway scenarios, we are now beginning to explore the design of vehicle coordination protocols for mixed traffic environments with the objective of optimizing journey time predictability in both highway and urban settings. We are exploring both centralised (i.e., availing of fixed infrastructure) and decentralised (self-organising) real-time coordination protocols capable of responding efficiently to perturbations in the traffic flow due to human driver behaviours and other incidents, as well as their integration with urban traffic control systems.

References

- [1] N. O'Hara, M. Slot, J. Monteil, V. Cahill and M. Bourouche, *Towards Evaluating the Benefits of Inter-vehicle Coordination* in Proceedings of the 18th International IEEE Conference on Intelligent Transportation Systems (ITSC), September 2015.
- [2] D. Marinescu, J. Curn, M. Bourouche, and V. Cahill, *On-ramp traffic merging using cooperative intelligent vehicles: A slot-based approach* in Proceedings of the 15th International IEEE Conference on Intelligent Transportation Systems (ITSC), September 2012.

GETTING IN TOUCH WITH THE EU

In person

All over the European Union there are hundreds of Europe Direct information centres. You can find the address of the centre nearest you at: <http://europa.eu/contact>

On the phone or by email

Europe Direct is a service that answers your questions about the European Union. You can contact this service:

- by freephone: 00 800 6 7 8 9 10 11 (certain operators may charge for these calls),
- at the following standard number: +32 22999696, or
- by electronic mail via: <http://europa.eu/contact>

FINDING INFORMATION ABOUT THE EU

Online

Information about the European Union in all the official languages of the EU is available on the Europa website at: <http://europa.eu>

EU publications

You can download or order free and priced EU publications from EU Bookshop at: <http://bookshop.europa.eu>. Multiple copies of free publications may be obtained by contacting Europe Direct or your local information centre (see <http://europa.eu/contact>).

JRC Mission

As the science and knowledge service of the European Commission, the Joint Research Centre's mission is to support EU policies with independent evidence throughout the whole policy cycle.



EU Science Hub
ec.europa.eu/jrc



@EU_ScienceHub



EU Science Hub - Joint Research Centre



Joint Research Centre



EU Science Hub



Publications Office

doi:10.2760/722699

ISBN 978-92-79-87680-6