

Smart Integration of Photovoltaics, Vehicle Charging, and Battery Storage in a Household

Christofer Sundström
Linköping University
Email: christofer.sundstrom@liu.se

Maximilian Kronawitter
Technische Universität München

Lorenz Viernstein
Technische Universität München
Email: lorenz.viernstein@tum.de

Abstract—The installed power of photovoltaics (PV) increases rapidly, as well as electric vehicles (EV). Most of the EV charging will occur at home, and there is a possibility to shift the charging in time to minimize the electricity cost. The reasons are for example to maximize the self-consumption of the produced electricity, and to charge the EV when the electricity price is at the lowest rate, since the electricity price is set by hourly rates one day in advance in northern Europe. To maximize the self-consumption of the generated PV power, battery storage systems (BSS) are common in Germany, but not as common in Sweden. Simulations and optimizations show that installation of PV systems significantly cuts the electricity costs for the households. Optimizing the time when to charge the EV decreases the yearly electricity cost by about 5% in Sweden, which is a good contribution since the investment of such system is small. Installing a BSS saves only about 3%, and is therefore not profitable due to the high investment. In Germany the difference between selling and buying electricity is significant, and therefore the electricity bill savings are about 1500SEK/year (6%) by installing a 5kWh BSS. Considering the investment cost, this is not yet profitable, but only a relatively small change in the market conditions will make the BSS profitable in Germany.

I. INTRODUCTION

The electricity generation on international level needs to include more renewable energy sources to decrease the green house emissions. Sweden is one of the leading nations regarding the share of renewable energies. The current nuclear power plants are however old and needs to be replaced within the coming decades. The change from liquid fuels in the automotive sector to electromobility increases the need for new renewable electricity generation. One rapidly increasing power production is photovoltaics (PV) in households. The share of the total energy production is still small, but the growth in installed PV power is significant, and the authorities subsidies investments in PV.

In Sweden it not common to install a stationary battery storage system (BSS). The reason is that when the PV produces more power than what is consumed, the energy is sold, and that there is a compensation for the energy tax and grid fee from the government resulting in that there is a small change in electricity price between selling and buying electricity. The produced energy is stored in the rest of the electricity system, primarily in the hydro power.

In Germany the installations in PV are more common compared to Sweden. This is due to several reasons, for example large subsidies and high electricity price. It is also more common to install BSS in combination with the PV system in order to be use more self-generated electricity.

Most of the electric vehicle (EV) charging will take place at home. Most of the charging will occur after work in

the evening if not a smart control scheme is introduced. This is the time of the day when the load in the electric system peaks in many places. The peak power within the household is increased using this charging strategy, since this is the time most of the power consuming activities occur during weekdays. Therefore a smart charging strategy for EV charging is needed if the share of EVs increases significantly, as is expected by many. The complexity increases further more when PV and BSS are included in the system.

and battery home storage systems (BSS) has become common in e.g. Germany. These new components can be separately controlled, but the potential of the components is even higher if a scheme optimizing the EV charging and BSS at once is used, while considering the PV generation. Here, the savings using an optimal control scheme based on dynamic programming is evaluated, as well as introducing a BSS. Three different locations in Sweden are considered, as well as Munich in Germany. The differences between these locations mainly affect the PV generation and the differences in electricity price between the countries. In Germany the electricity price is at high and at flat rate, while the electric price varies at hourly in Sweden and is cheaper.

A. Problem formulation

The aim of this paper is to investigate the electricity cost savings by installing PV and BSS systems within private houses including EV charging. The benefits of optimizing the usage of these systems in a combined optimal control problem is investigated. The pricing strategies for electricity is very different in Sweden, where the prices varies at an hourly rate, and Germany where a flat rate is used. The differences between installing PV and BSS in these two countries are compared to understand if there is reason for why BSS are more common in Germany.

II. MODEL AND INPUT DATA

The models for the vehicle charging, BSS, and PV models used in the optimizations are briefly described in this section. Furthermore, available data for the household electric appliance consumption and the data required for the calculation of solar output power is presented.

A. PV model

No data of the electric production from PV-panels from the Swedish sites considered in this paper is available. However, the solar radiation and outdoor temperature are available from the Swedish Meteorological and Hydrological Institute (SMHI) at an hourly sample rate since 1983. The solar

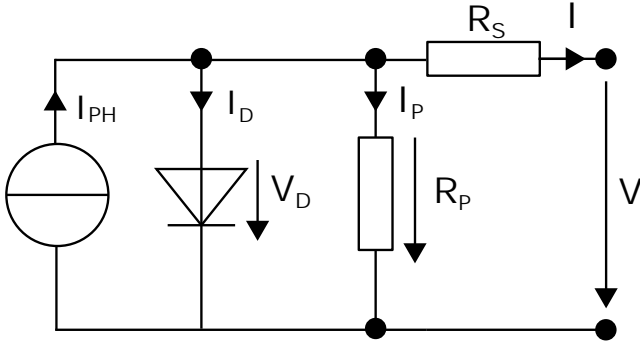

Fig. 1: Standard equivalent one diode circuit diagram of a PV cell

irradiation is separated into diffuse radiation, G_d , direct radiation, G_b , and global radiation, G_h . In addition to the possibility to model the output from the PV system based on the geographic location, it is also possible to investigate the impact of different inclination angles and positions of the panels.

Several different models for PV are presented in the literature. Here, the single diode model with both series and parallel resistors is used, as in Figure 1. This model is deemed as good balance between model accuracy and model complexity [1], [2]. The photo current, I_{ph} is computed by a reference current $I_{ph,ref}$, that is obtained by a short-circuit test at standard test conditions (STC), the cell temperature, T , the cell temperature at STC, $T_{STC} = 298K$, the irradiance, G , the irradiance at STC, $G_{STC} = 1000W/m^2$, and the temperature coefficient of short circuit current as

$$I_{ph} = \frac{G}{G_{STC}} (I_{ph,ref} + \mu_{sc} * (T - T_{STC})) \quad (1)$$

The cell temperature is computed by a static expression based on G and the nominal cell operating temperature (NOCT) as [3]

$$T_{cell}(C^\circ) = T_{amb} + \frac{NOCT - 20}{800} \cdot G \quad (2)$$

The diode current, I_D , in the model is computed by the reverse saturation or leakage current of the diode I_0 , on the diode imposed voltage, V_D , the cell current output, I , and the thermal voltage, a .

$$I_D = I_0 \left[e^{\left(\frac{V+I \cdot R_s}{a}\right)} - 1 \right] \quad (3)$$

where a is computed by the number of in series connected cells, N_s , the ideality factor, A , which is 1.2 and 1.3 for Si-mono and Si-poly respectively, the Boltzmann constant, k , the actual cell temperature, T_C , the electron charge, q , and the thermal voltage, V_T .

$$a = \frac{N_s \cdot A \cdot k \cdot T_C}{q} = N_s \cdot A \cdot V_T \quad (4)$$

The current leak, I_P , depends on the output voltage V , output current I , the internal series resistance, R_s , and the shunt resistance R_p as

$$I = I_{ph} - I_0 \left[\exp\left(\frac{V + I \cdot R_s}{a}\right) - 1 \right] - \frac{V + R_s \cdot I}{R_p} \quad (5)$$

The output current is computed by

$$I = I_{ph} - I_d - I_p \quad (6)$$

or rewritten by (1)-(5)

$$I = I_{ph} - I_0 \left[\exp\left(\frac{V + I \cdot R_s}{N_s \cdot A \cdot V_T}\right) - 1 \right] - \frac{V + R_s \cdot I}{R_p} \quad (7)$$

Some parameters like the temperature coefficient of the short-circuit current μ_{sc} , the short-circuit current I_{SC} under STC or the number of in series connected cells are provided by the manufacturer, whereas some parameters like the resistance have to be assumed or calculated.

It is common that radiation data is available for a horizontal surface. However, the global radiation G in (1) is the irradiation on the tilted surface. Therefore, G is to be computed based on the direct radiation on the horizontal surface, G_b , the diffuse radiation on the horizontal surface, G_d , the global radiation on the horizontal surface, G_h , inclination angle of surface against horizontal plane, β , incidence angle on inclined surface, θ , crown angle of the sun, θ_z , and a reflection coefficient, ρ . The global irradiance on the inclined surface is computed according to [4].

$$G = G_b \cdot \frac{\cos \theta}{\cos \theta_z} + G_d \cdot \frac{1 + \cos \beta}{2} + G_h \cdot \rho \cdot \frac{1 - \cos \beta}{2} \quad (8)$$

1) *Validation:* The PV model is validated using measurement data from the PV installation at Technical University Munich (TUM). The installed peak power is 14kW, and the output power is measured every second. The solar radiation and outdoor temperature are provided by the Meteorological Institute Munich of the Ludwig-Maximilians-University Munich at a minutely rate. Based on data from year 2016 the hourly average for these signals are computed, to match the sample time in the optimization presented in Section III. The PV and measuring station are on the roof in approximately the same height without any shading coefficient. Both are located in the same area with a distance of 500 meters.

The model is primarily parametrized using data sheets for the PV panels. However, comparing the simulation results using these parameters with the measurements of the output power from the panels results in a significant difference in the peak power produced during the year. Therefore, the parameters used in the model are tuned based on the measurement data to achieve a better fit. A comparison between the measured electric output and the simulated output is presented in Figure 2 for one week at winter and one day at summer. As can be seen the model accurately describes the physical PV system. The yearly production and peak power is computed for the model and the measurements, and is presented in Table I. See [5] for details.

TABLE I: Measured and simulated electricity generation of 14kW_p PV system in Munich. The installed PV model is First Solar FS-265

	Measurement	Simulation
Yearly electricity generation [MWh]	12.458	12.457
Maximum electricity generation [kWh/h]	10.998	11.096

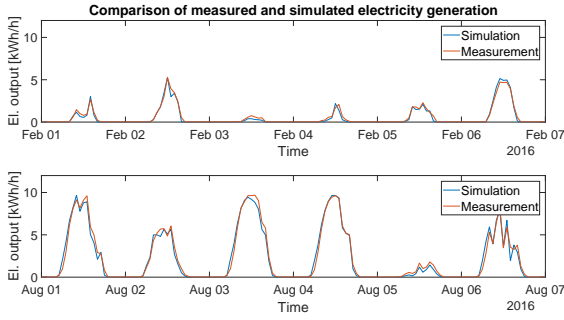

Fig. 2: Measured and simulated generated electricity of the 14 kW_p PV system located in Munich for two weeks in 2016 using PWX 500 PV module (49 W)

B. Battery storage system

The battery model is a low complexity model. The state of charge of the battery, $x_{SoC,BSS}$ is computed by the power to the battery, P_{BSS} , the storage capacity Q_{BSS} , and an efficiency, η_{BSS}

$$\frac{dx_{SoC,BSS}}{dt} = \eta_{BSS} \frac{P_{BSS}}{Q_{BSS}}, \quad x_{SoC,BSS} \in \{0,1\} \quad (9)$$

C. Electric vehicle charging

The vehicle is assumed to be used every day and the battery is discharged during the driving. Exactly how the driving mission is performed is not of interest in this investigation, since it is the household electricity usage that is of interest. Therefore, it is needed to model when the vehicle is connected to the grid and when the vehicle is out of home. No charging outside of home is assumed. Furthermore, the time for when the vehicle is to be fully charged is also to be modeled.

During the charging the battery state of charge, $x_{SoC,EV}$, is modeled as in (9)

$$\frac{dx_{SoC,EV}}{dt} = \eta_{EV} \frac{P_{EV}}{Q_{EV}}, \quad x_{SoC,EV} \in \{0,1\} \quad (10)$$

D. Available data

In the analysis data for the household appliance consumption is required. Data from 27 households is available. These houses are heated with district heating, and therefore it is assumed that no electricity is used for heating of the house. The data is sampled at an hourly rate. The yearly electric consumption for the households varies from 1.0MWh to 9.9MWh, and one household using 5.2MWh per year is selected to be used in the analysis.

As stated in above, the solar radiation and outdoor temperature is required to compute the generated power from the PV panels. The Swedish Meteorological and Hydrological Institute (SMHI) records the temperature, the solar irradiance, divided into the global radiation on a horizontal surface, G_h , diffuse radiation, G_d , and direct radiation, G_b . These data signals are sampled at an hourly basis and are provided for the investigated locations Kiruna, Visby, and Norrköping. As comparison, the solar radiation in Munich, provided by the Meteorological Institute Munich of the Ludwig-Maximilians-University Munich, is analyzed. All the used meteorological data is from year 2016.

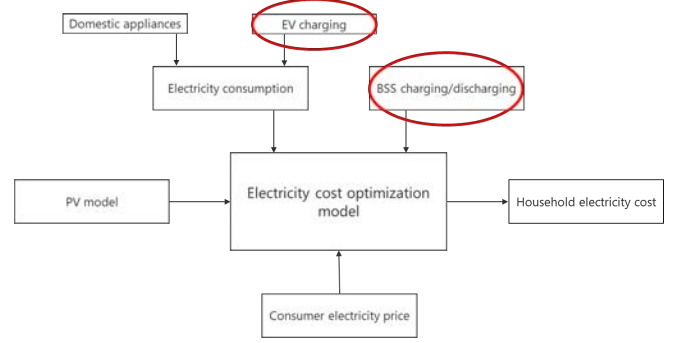

Fig. 3: Overview of implemented model and the components to be optimized.

III. OPTIMIZATION METHOD

Exploiting the full potential of a electricity cost reduction, a smart energy management system (EMS) is necessary to optimize the interaction between PV generation, household appliance consumption, EV charging and battery storage system. Figure 3 shows the structure of the components included in the EMS. The method used to find the optimal solution of the smart energy management system is dynamic programming. The basic idea using this approach will be described in this section. The optimization objective is to minimize the energy cost for a single household, and the objective function used in the optimization to achieve this is described.

A. Dynamic programming

One key advantage using dynamic programming is that the global optimal solution is found, while there is a risk finding local minimums using numerical based algorithms. The drawback, in general, is computational complexity and that the system description needs to be in discrete forum. Finding the optimal solution for the control of EV charging and the BSS is manageable from computational complexity, but the continuous model description needs to be discretized. The states in the optimal control problem $X \in \mathcal{R}^{m \times n}$ are $x_{SoC,EV}$ and $x_{SoC,BSS}$, where m and n are the number of discrete values each state can take in the optimization. The control signals $U \in \mathcal{R}^{o \times p}$ are P_{EV} and P_{BSS} , and o and p the number of discretization points in the control signal respectively. The initial values of the states are denoted $x_{SoC,EV,0}$ and $x_{SoC,BSS,0}$.

The approach is illustrated using Figure 4 considering one state, $x_{SoC,EV}$. The figure presents a matrix including information about the cost to reach the end time point, t_N , from any time t_k and state $x_{SoC,EV,k}$. This matrix is denoted cost-to-go, g . Adding an additional state, e.g. $x_{SoC,BSS}$, results in a three dimensional cost-to-go matrix, but the idea of the algorithm is the same. The first step in dynamic programming is to find a minimal cost to go values from each point in the grid of time points and states and store this value in the matrix. The algorithm starts at the end time point and the final cost, J_N , is assigned to avoid ending up

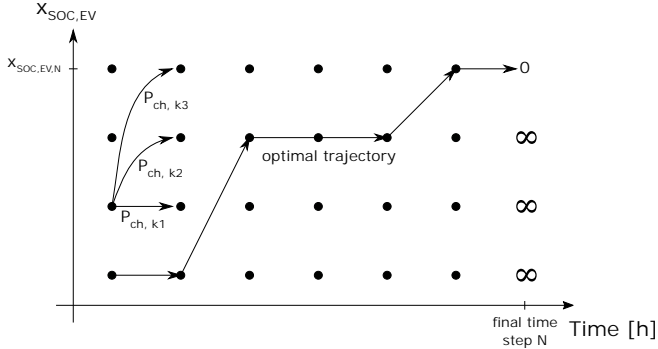

Fig. 4: Simplified description of the state grid and optimal cost-to-go trajectory for a certain time and state selection.

in a too low state value. Here

$$J_N = \begin{cases} \infty, & \forall x_{SOC, EV, N}^i < x_{SOC, EV, 0}, \quad i \in \{1, m\} \\ 0, & \forall x_{SOC, EV, N}^i \geq x_{SOC, EV, 0}, \quad i \in \{1, m\} \end{cases} \quad (11)$$

to avoid ending up with a lower charging level in the battery in the end of the optimization period.

B. Minimization criteria

The objective using the optimal control is to minimize the electricity cost for a time period T . As mentioned above, P_{EV} and P_{BSS} are the control signals to be found, and the household appliance power, P_{house} , is included as an uncontrollable disturbance. The power from the grid, or delivered to the grid, is expressed by

$$P_{grid} = P_{house} + P_{EV} + P_{BSS} - P_{PV} \quad (12)$$

The electricity price varies hourly in Sweden, but also differs when buying or selling electricity. The cost for buying and selling one kWh electricity is denoted $C_{b,k}$ and $C_{s,k}$, where k is the time index. The energy consumption per time step is found by multiplying the power with the time step Δ_k . The optimization criteria is

$$\min \sum_{k=1}^N \max \{P_{grid,k}, 0\} \cdot C_{b,k} + \min \{P_{grid,k}, 0\} \cdot C_{s,k} \quad (13)$$

where N corresponds to the time index at time T .

There are constraint in the electric system that are described below.

- 1) *Maximum power*: The magnitude of P_{grid} is limited to a maximum power \tilde{P}_{grid} to avoid blowing the fuse of the household, as

$$|P_{Grid,k}| \leq \tilde{P}_{Grid} \quad (14)$$

- 2) *Electric vehicle*: The electric vehicle is only connected to the grid at parts of the time. The assumed usage patterns of the vehicle are described in IV. The time the vehicle is connected to the grid is denoted $T_{EV,avail}$. Power can only flow from the grid to the vehicle battery, and not vice versa. The maximum charging power is denoted \tilde{P}_{EV} , and the constraint is formulated

as

$$P_{EV,k}^{Ch} \leq \tilde{P}_{EV} \quad \forall t \in T_{avail} \quad (15)$$

$$P_{EV,k}^{Ch} = 0 \quad \forall t \notin T_{avail} \quad (16)$$

The state of charge of the battery is limited as

$$0 \leq x_{SOC, EV, k} \leq 1 \quad (17)$$

Before the EV is used, the battery has to be fully charged on every day at time $T_{EV,full}$.

$$x_{SOC, EV}(t) = 1 \quad \forall t \in T_{EV,full} \quad (18)$$

- 3) *Battery storage system*: The BSS can be charged and discharged at any time, and the power is limited to the maximum power \tilde{P}_{BSS}

$$|P_{BSS,k}| \leq \tilde{P}_{BSS} \quad (19)$$

The limit $x_{SOC, BSS}$ is

$$0 \leq x_{SOC, BSS}(t) \leq 1 \quad (20)$$

IV. RESULTS

In this section the impact of different technical configurations on the total energy cost is investigated, as well as different control schemes of how these systems are used. The optimal solution depends for example on the electricity price.

The daily driving distance is randomized. Based on real driving investigations in Sweden and Germany [6], [7], [8], realistic mean driving distances are found. The mean driving distance is set to 40km at weekdays and 35km at weekends, resulting in a yearly driving distance of 14300km. According to [9] the Nissan Leaf was the most new-released electric vehicle in Sweden during the first half of 2016 and 2017. The energy consumption from The New European Driving Cycle (NEDC) is measured to 15.0 kWh/100km [10]. It is common that the energy consumption is higher at real driving compared to the certification cycle. Furthermore, climate control of the compartment significantly affects the energy consumption of the vehicle. Due to the cold climate in Sweden, it is therefore assumed that the energy consumption is between 17-22 kWh/100 km during the summer season and 29-34 kWh/100 km during the winter season. The time, when the EV is available for charging, is estimated with values of the normal distribution with a mean of 5pm for weekdays and 3pm during the weekend. The standard deviation is in both cases 1 hour. The charging process for each day over the night has to be finished between 6 and 9 am during the weeks and between 8-10 am on the weekends. In the case of $x_{SOC, EV} < 0.5$ when the vehicle is plugged in after the driving mission, the vehicle is immediately charged to 50%. The charging efficiency η_{EV} is set to 85% [11].

The yield from a PV installation is about 1MWh per installed kW peak power. To match the household appliance consumption, a PV installation of 5kWp is assumed in the analysis. A common configuration of the size of the BSS is 1kWh per MWh yearly energy production from the PV, see for example [12]. Therefore, in this study the nominal value for the BSS size is 5kWh. The efficiency η_{BSS} is set to 95%.

The cost for buying electricity, C_b , is computed based on energy price, grid fees, and taxes. The spot price, or the energy price, is denoted C_{spot} , the cost to the energy supplier C_{es} , the fee to the grid owner, C_{grid} , the energy tax C_{tax} , and VAT, γ_{VAT}

$$C_b = (C_{spot} + C_{es} + C_{grid} + C_{tax}) \cdot (1 + \gamma_{VAT}) \quad (21)$$

where the values for these parameters are found in Table II, except for C_{spot} that is time dependent.

The value of one sold kWh energy, C_s is computed by a tax reduction, $C_{tax,red}$, electric certificate, C_{cert} , and grid compensation from the grid company, $C_{grid,comp}$ as

$$C_s = C_{spot} + C_{tax,red} + C_{cert} + C_{grid,comp} \quad (22)$$

Values for these parameters are also found in Table II. The payment for the certificates varies in time, but is here assumed as a constant.

TABLE II: Parameters used in the computation of the electricity cost.

Parameter	Value [SEK/kWh]
C_{es}	0.035
C_{grid}	0.196
C_{tax}	0.33
$C_{tax,red}$	0.60
C_{cert}	0.07
$C_{grid,comp}$	0.035
γ_{VAT}	25%

There are three different pricing scenarios that are compared:

- *Current scenario*: The values for C_{spot} is the costs from 2016.
- *Future scenario*: The fluctuations in the electric prices are expected to increase in the future. Furthermore, the incentives for renewable micro production are expected to decrease. To investigate the optimal solution a future scenario is investigated, based on the spot market data from 2016, but the magnitude of the deviations from the mean electricity price are increased by 50%. The incentives are assumed to be removed and implemented by $C_{tax,red} = 0SEK/kWh$ and $C_{cert} = 0SEK/kWh$.
- *Flat rate*: In Germany the electric price is constant over the year. How this pricing strategy affects the solution is investigated using costs from Munich. The feed-in tariff is significantly lower compared to the end consumer price, but the pricing for both consumption and feed-in are still on a higher price level compared to the Swedish electricity price.

The end consumer prices and feed-in tariffs are presented in Figure 5.

A. Current scenario

The energy cost using the *current scenario* is found without any optimal control, denoted energy management system (EMS), PV, and BSS. When no EMS is available the EV is fully charged when the vehicle is plugged in. The total electric cost for household appliance electricity and EV charging is 9780 SEK. The cost reduction due to PV installation depends on the site, and the cost reduction is presented in Table III.

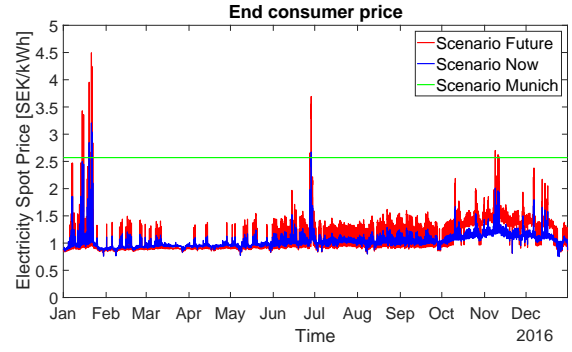

(a) End consumer price]

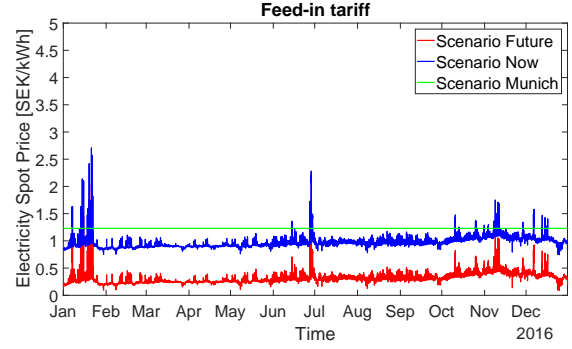

(b) End consumer feed-in tariff

Fig. 5: Different tariffs for the three scenarios.

TABLE III: Yearly electricity costs when PV generation is installed, when an optimal energy management system is included, and when a BSS is added to the system. The pricing scenario is *current scenario*.

	Yearly electricity costs (reference): 9780 SEK		
	cost PV [SEK]	cost PV & EMS [SEK]	cost PV, EMS & BSS [SEK]
Norrköping	4961 (49.3%)	4466 (54.3%)	4149 (57.6%)
Kiruna	6132 (37.3%)	5637 (42.4%)	5326 (45.5%)
Visby	4496 (54.0%)	4003 (59.1%)	3684 (62.3%)
Munich	4718 (51.8%)	4227 (56.8%)	3904 (60.1%)

The table shows the yearly electricity costs for different setups. The most simple one is the usage of only a PV system and a heuristic control algorithm for EV charging (“PV”), a setup using a PV system but optimal control of EV charging (“PV & EMS”), and the most complex system including the installation of a PV system in combination with an intelligent EMS and a BSS (“PV & EMS & BSS”). The relative savings to the reference cost are presented in the parenthesis in the table. For all sites the PV panels are south orientated and tilted 44°. In the table it can be seen that cost reduction due to PV installation is similar to all sites except Kiruna in the northern part of Sweden. Adding an EMS cuts the energy costs additionally 5%, while installation of a BSS slightly less.

The electricity cost varies with the orientation and angle of the roof of the PV installation. In Figure 6 the total electricity cost is presented when the 5kW PV installation is oriented in different directions. The directions are east, south, and west, and the roof inclination angles investigated are 22° and 44°.

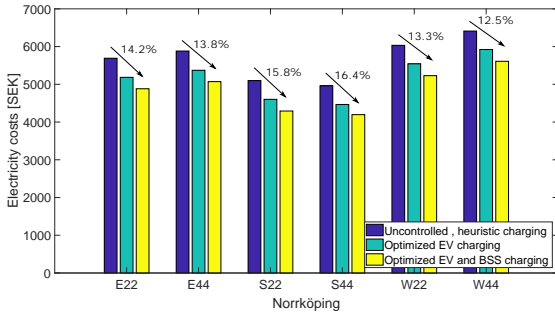

Fig. 6: Electricity costs for the heuristic, uncontrolled charging, the optimized EV charging and the optimized EV and BSS operation for Norrköping, *current scenario*.

TABLE IV: Reference and yearly electricity costs and reduction due to PV generation, EMS and BSS for south oriented PV systems, tilted by 44° , *future scenario*.

Yearly electricity costs (reference): 10815SEK			
	cost PV [SEK]	cost PV & EMS [SEK]	cost PV, EMS & BSS [SEK]
Norrköping	8066 (25.4%)	7059 (34.7%)	5650 (47.8%)
Kiruna	8729 (19.2%)	7708 (28.7%)	6471 (40.2%)
Visby	7883 (27.1%)	6902 (36.2%)	5481 (49.3%)
Munich	7746 (28.4%)	6838 (36.8%)	5375 (50.3%)

The decrease in the cost due to EMS and BSS is similar due to orientation of PV, but there is slightly higher potential for installation of EMS and BSS in the south oriented roof.

The influence on total power consumed, or feed-in, to the grid using different configurations are presented in Figure 7. The example shows the power flows from the evening of April 4 till the morning April 6 in a south oriented roof, 44° angle, in Norrköping. The blue solid line shows the case where no optimal control, household appliance electricity, and EV charging are considered. The vehicle arrives at home at 5pm April 5, and is fully charged within one hour. When adding the PV system, power is feed-in to the grid at daytime, see the yellow solid line. When adding an EMS, the EV charging is changed in time till the night when the electricity price is at the lowest rate. The vehicle is still fully charged till the morning. Adding a BSS increases the maximum power consumed when the electric price is at minimum, but also increases the feed-in power when the electricity price is at the highest rate for the day. The differences in price are for this day large enough for being optimal to use the battery, even though there are losses in the battery. Note that no cost for depletion of the battery is included in the optimal control in this case.

B. Future scenario

The assumptions in the future scenario results in a lower feed-in tariff, which results in lower profitability in PV, but also a greater profitability in investing in an EMS and BSS, as can be seen in Table IV. The reasons are that it is more important to use the self-produced electricity in this scenario, but also that the hourly price fluctuations increases.

C. Flat rate

The Munich price rate is used on all sites, and the results are presented in Table V. The electricity cost is significantly

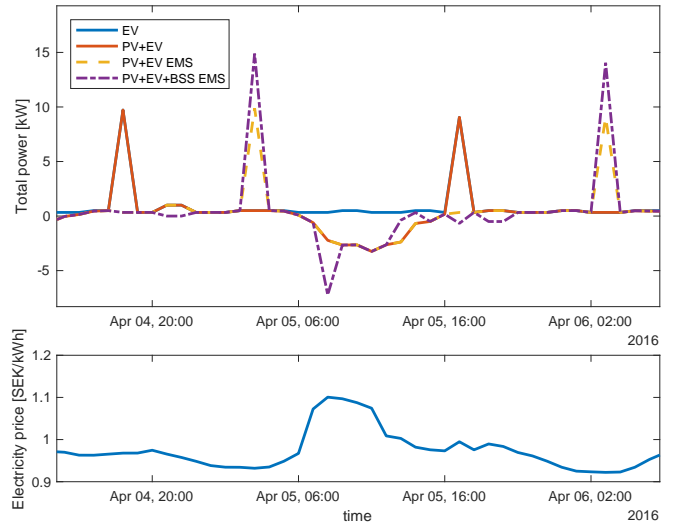

Fig. 7: The total power for the household appliance load and additional systems as presented in Table III, *current scenario*.

TABLE V: Yearly electricity costs and reduction due to PV generation, EMS and BSS for south oriented PV systems, tilted by 44° , *flat rate*.

Yearly electricity costs (reference): 23366 SEK			
	cost PV [SEK]	cost PV & EMS [SEK]	cost PV, EMS & BSS [SEK]
Norrköping	16034 (31.4)	15473 (33.7)	13998 (40.1)
Kiruna	17586 (24.7)	17132 (26.7)	16015 (31.5)
Visby	15362 (34.3)	14816 (36.6)	13353 (42.9)
Munich	15541 (33.5)	15187 (35.0)	13587 (41.9)

higher using this pricing strategy. The cost for household appliance electricity and EV charging is 23366 SEK. The cost reduction is higher installing PV compared to the *current scenario*, but the relative cost savings are smaller. The benefit of using an EMS is small due to the flat rate, but there is a small potential of charging the EV when the PVs produce power, and thereby maximizing the self-usage of the produced power. The potential of installing a BSS is significantly higher compared to the Swedish pricing strategies. The reason is that the difference between buying and selling electricity is higher in Germany, and therefore the benefit of installing a BSS is higher to be able to store produced power from the day till the night.

D. Profitability analysis

In Tables III to V the electricity cost reduction installing for example BSS is investigated using different pricing scenarios. Battery aging can be divided into calendar aging and cyclic aging. To consider the aging of the battery due to usage of the battery a cost is added for using the battery. This cost is difficult to find, since the aging of the battery depends on many parameters, for example temperature, humidity, power, and depth of discharge. An optimistic cost for storing one kWh energy in the battery is 1.7SEK, resulting in 0.7SEK/kWh considering the current subsidy from the Swedish government. Including this cost in the optimization results in that the BSS is used very little, only 70kWh are stored during the entire year using the current price scenario.

Similar result is achieved using the future scenario, and the reason is the high feed-in tariffs in the Swedish system.

Considering the flat rate scenario on the current Munich pricing level, a cost for using the BSS of 1.3SEK/kWh is profitable. Comparing this with the stated 1.7SEK/kWh above results in that further cost reduction alternatively increased spread between feed-in tariffs and buying tariffs results in that the BSS may be profitable.

V. CONCLUSION

Simulations shows that the annual electricity generation from a PV installation within a household is similar in southern parts of Sweden and southern parts of Germany. The cost reduction of installing PVs is however larger in Munich compared to Sweden due to the differences in the electricity pricing tariffs.

The benefits of installing a smart energy management system optimizing the charging of an electric vehicle given the household appliance consumption, PV generation, and electric price, are larger in Sweden compared to Germany. This is due to the hourly varying electricity price. The benefits of such a system in Germany is to maximize the self-consumption of the generated solar power.

Benefits due to installation of BSS turns out small. The optimizations show that energy cost savings can be achieved, but no profitability can be expected for all three scenarios. The current electricity pricing structure and price level in Sweden does not support the investment in a BSS. However, using the current German pricing tariff it is close to reach break even installing a BSS considering the investment cost.

REFERENCES

- [1] H. Bellia, R. Youcef, and M. Fatima, "A detailed modeling of photovoltaic module using matlab," *NRIAG Journal of Astronomy and Geophysics*, vol. 3, no. 1, pp. 53–61, 2014.
- [2] A. Senturk and R. Eke, "A new method to simulate photovoltaic performance of crystalline silicon photovoltaic modules based on datasheet values," *Renewable Energy*, vol. 103, pp. 58–69, 2017.
- [3] Gail-Angee Migan, "Study of the operating temperature of a pv module," Ph.D. dissertation, Lund University, Lund, 2013.
- [4] U. Eicker, *Solare Technologien für Gebäude: Grundlagen und Praxisbeispiele*, 2nd ed., ser. Studium. Wiesbaden: Vieweg+Teubner Verlag / Springer Fachmedien Wiesbaden GmbH Wiesbaden, 2012. [Online]. Available: <http://dx.doi.org/10.1007/978-3-8348-8237-0>
- [5] M. Kronawitter, "Household electricity cost reduction: Impact of photovoltaic and smart integration of electric vehicle and battery storage systems," Master's thesis, Technical University Munich, 2018.
- [6] Z. LIU, Q. WU, L. CHRISTENSEN, A. RAUTIAINEN, and Y. XUE, "Driving pattern analysis of nordic region based on national travel surveys for electric vehicle integration," *Journal of Modern Power Systems and Clean Energy*, vol. 3, no. 2, pp. 180–189, 2015.
- [7] T. Kaschub, *Batteriespeicher in Haushalten unter Berücksichtigung von Photovoltaik, Elektrofahrzeugen und Nachfragesteuerung*, ser. Produktion und Energie. Karlsruhe: KIT Scientific Publishing, 2017, vol. Band 23.
- [8] L.-H. Björnsson, "Car movement patterns and the phev," Ph.D. dissertation, University, Gothenburg, 2017.
- [9] Wynand Goosen, "The swedish electric vehicle market h1 2017: Sweden ev sales h1 2017, a summary," 2017. [Online]. Available: <https://wattve2buy.com/swedish-electric-vehicle-market-sweden-ev-sales-h1-2017/>
- [10] ADAC, "Autokatalog - detail: Nissan leaf (24 kwh) visia (mit batterie-miete)," 2017.
- [11] J. Sears, D. Roberts, and K. Glitman, "A comparison of electric vehicle level 1 and level 2 charging efficiency," in *2014 IEEE Conference on Technologies for Sustainability (SusTech)*. IEEE, 2014, pp. 255–258.
- [12] M. Naumann, R. C. Karl, C. N. Truong, A. Jossen, and H. C. Hesse, "Lithium-ion battery cost analysis in pv-household application," *Energy Procedia*, vol. 73, pp. 37–47, 2015.