

# Investigation of the Dynamic Loads on Tower Cranes during Slewing Operations

Manuel Stölzner<sup>1</sup>, Michael Kleeberger<sup>1</sup>, Marcel Moll<sup>1</sup> and Johannes Fottner<sup>1</sup>

<sup>1</sup>*Chair of Materials Handling, Material Flow, Logistics, Technical University of Munich,  
Boltzmannstr. 15, 85748 Garching, Germany  
{manuel.stoelzner, michael.kleeberger, marcel.moll, j.fottner}@tum.de*

**Keywords:** Tower Cranes, Static and Dynamic Analysis, Finite Element Method, Vibration Model, Dynamic Factors.

**Abstract:** For decades, tower cranes have been the most important hoisting device used in building construction. In order to avoid security risks at the construction site, it is essential to analyse the dynamic behaviour of these cranes during the work process as the crane motions cause dynamic forces on the supporting structure. According to the current standards, stress calculations for tower cranes are carried out based on static approaches. The standards stipulate the use of special dynamic factors in the static calculation to estimate the dynamic loads. This article analyses the dynamic behaviour of a tower crane during the important work process of slewing. The results of the approach according to the standards are compared with the results of the nonlinear dynamic finite element calculation. In addition, a newly developed vibration model based on a two-mass model will be presented in this paper. The model helps to estimate the dynamic loads more accurately than the methods currently used. However, the computation time required to perform the stress calculation is only slightly increased.

## 1 INTRODUCTION

Tower cranes are very versatile and widely used. A range of tower cranes is available extending from small cranes, often used for the construction of detached houses, to large tower cranes with special climbing facilities for the construction of high-rise buildings. Their field of application currently includes a hoisting capacity of about 100 metric tonnes, and a hoisting height of more than 100 metres. In order to meet the different requirements on construction sites, most tower cranes are designed modularly, which enables a large number of boom configurations. The fundamental motions of tower cranes are slewing, hoisting and they also allow either a luffing motion or load travel. During operation, crane motions cause dynamic forces on the hoist load and on the crane's structure. In order to guarantee the safety of cranes, exact calculations of the boom system are absolutely essential throughout the developing process. Consequently, one main objective of the stress calculation is to reproduce the system's dynamic behaviour as realistically as possible.

According to the current international standard ISO 8686 and the European standards EN 13001 and EN 14439, static approaches are used to perform

stress calculations for tower cranes. In order to consider the dynamic effects during the working process, rigid body approaches are used and special dynamic factors are defined. These factors are either based on the experience of the crane manufacturers or alternatively they are selected from tables in the standards. In this publication, the approaches in the international standard are evaluated by comparing the calculation results with the results of other calculation methods. Some scientific studies on tower cranes are already available in the literature. However, recent publications often deal with questions of control engineering to reduce the effects of load swing, e.g. (Le et al., 2013; Blajer and Kołodziejczyk, 2011; Doçi et al., 2016). In almost all cases, models with rigid or simple elastic bodies are used. Although these simplified modelling approaches help to solve control engineering problems, they are not adequate for investigating the dynamic effects on the structure in the stress calculation.

Only a few publications exist that deal with the dynamic behaviour of tower cranes taking into account elastic deformation, or that evaluate the approaches in the standard. Some papers (Ju and Choo, 2005; Ju et al., 2006) focus on frequency investigations for different applications. An earlier research project has al-

ready investigated the dynamic loads of tower cranes when hoisting grounded loads (Maier, 2000). For the crane analysed, this research project showed that the dynamic factor for hoisting, according to EN 13001, describes the loads more accurately than the specifications in the standard DIN 15018, which is now obsolete. However, this work provides no comparison with the standards for crane movements involving major displacement of the supporting structure, such as the process of luffing or slewing.

Since the standards for mobile cranes use similar approaches for the design, the applicability of the dynamic factors has been evaluated in some publications on mobile cranes, such as (Kleeberger et al., 2014; Stölnzer et al., 2018; Stölnzer et al., 2019). These articles have shown that the simplified approaches of the calculation methods currently used are often inappropriate for reproducing the true dynamic effects on mobile cranes. As it can be assumed that the calculation approaches of the standards have similar deficits for tower cranes as for mobile cranes, the dynamic behaviour of tower cranes is analysed in more detail below. Since the publications mentioned above show that the greatest inaccuracies occur in the calculation of slewing processes, this article focuses on the dynamic loads on tower cranes during slewing.

The nonlinear dynamic finite element method can characterise the dynamic effects on cranes very accurately. In this article, the results calculated using the approach from the international standard ISO 8686 are evaluated by means of a comparison with the results of the nonlinear dynamic finite element calculation, as this method can be considered reliable.

Although the dynamic finite element method allows exact and reliable calculations, it is very rarely used by crane manufacturers. The main disadvantage of this calculation method is the increased computing effort compared to a static calculation. There is also no reasonable way to consider the standards' partial safety factors in a dynamic calculation.

Alternatively, the standards permit the use of other methods to calculate the dynamic factors. In order to achieve a more accurate calculation of the dynamic behaviour of tower cranes without a disproportionate increase in computing time, a special vibration model is presented in this publication. This new method allows the dynamic factors for the slewing process to be calculated in a more precise way than the current methods. The applicability of the vibration model and the calculation standard is shown for a tower crane with different loads and load positions. In order to assess the accuracy of the model and the standard, several angular velocities and angular accelerations of the tower crane are taken into account.

## 2 STATE of the ART

The international standard ISO 8686-1 (ISO 8686-1, 2012) defines general rules for the stress calculation of cranes. With regard to the load assumptions, the general European standard for crane calculation EN 13001-2 (EN 13001-2, 2014) is mostly identical to the international one. The design principles for loads and load combinations of tower cranes are specified in the product-specific international standard ISO 8686-3 (ISO 8686-3, 2018) and in the European standard EN 14439 (EN 14439, 2010).

In the standards, the approach for considering dynamic loads is based on a rigid body kinetic analysis and uses quasi-static calculation methods. In order to take the effect of the dynamic forces into consideration, the use of dynamic factors is suggested. However, the standard ISO 8686-3 also allows other values to be used for dynamic factors "when determined by recognized theoretical analysis or practical tests" (ISO 8686-3, 2018). The nonlinear dynamic finite element calculation and the vibration model presented here (see Section 3) both belong to the accepted theoretical methods of analysis mentioned above.

To carry out the stress calculation of tower cranes, the version of the European standard EN 14439 that is currently valid refers to the now-obsolete standard DIN 15018 (DIN 15018, 1984) and the guideline FEM 1.001 (FEM 1.001, 1998). The international standard provides fixed values for the dynamic factors, whereas the guideline FEM 1.001 defines another method of describing dynamic loads during the horizontal movements of tower cranes. This guideline proposes an approach based on a two-degree-of-freedom model, which allows the factors to be calculated depending on the crane configuration (see Section 2.2).

In addition to the dynamic factors, both the international and the European standards prescribe the use of partial safety factors in order to compensate for uncertainties in the load assumptions. Since the aim of this publication is not to evaluate safety factors but to assess the quasi-static loads from the vibration model and the calculation standards, no safety factors are used. Nevertheless, the partial safety factors can be considered in the same way as prescribed in the standards when this vibration model is used.

## 2.1 ISO 8686

The standard ISO 8686-3 “gives specific requirements and values for factors to be used at the structural calculation” (ISO 8686-3, 2018) of tower cranes. The current draft of the product-specific European tower crane standard EN 14439 (prEN 14439, 2018) corresponds to the approaches of this standard.

Based on ISO 8686-1, the loads are classified as regular loads, occasional loads and exceptional loads. The occasional loads include all forces caused by skewing or loads due to climatic and environmental influences such as loads from wind, snow or temperature variation. Exceptional loads are test loads and other loads that occur very rarely during regular crane operations, for instance loads caused by emergency off or loads due to unintentional loss of the hoist load. Among regular loads are the forces caused by “acceleration of all crane drives including hoist drives” (ISO 8686-1, 2012). The dynamic loads resulting from slewing operations fall into this category of forces.

According to ISO 8686, the forces applied on the structure during acceleration and deceleration are calculated with rigid-body models. The calculation includes both centrifugal forces and inertial forces. Since a rigid-body analysis does not reflect the elastic effects, the changes in the forces are multiplied by a dynamic factor. To estimate the dynamic loads, the dynamic factor  $\Phi_5$  is defined and some default values of this factor are proposed in the standard. To consider the inertia forces, the general rules in the standard ISO 8686-1 provide a range between 1 and 2 for this factor. The product-specific part ISO 8686-3 defines a factor of  $\Phi_5 = 1.5$ . The centrifugal forces are considered by a factor of  $\Phi_5 = 1$ .

In addition to the proof of strength, ISO 8686-3 also requires a proof of fatigue. As the aim of this article is not to analyse fatigue, but rather to evaluate and improve the underlying load assumptions, the proof of fatigue is not considered.

## 2.2 FEM 1.001

For the proof of strength, the European standard EN 14439 refers to the FEM guideline 1.001. This guideline distinguishes between dynamic forces due to vertical and horizontal movements of the crane. For the horizontal movements, which include the slewing process, the guideline defines different dynamic factors in the stress calculation related to the hoist load and the supporting structure.

In contrast to ISO 8686, the dynamic factor for the hoist load is calculated using a two-degree-of-freedom model of the crane (see Figure 1). In this model,  $m_2$  is

the mass of all translatory and rotary moving parts of the drive system and the supporting structure, reduced to the load suspension point, while  $m_1$  represents the mass of the hoist load. The driving force  $F$  acts on  $m_2$ . The stiffness  $k_1$  of the load pendulum is calculated with the equation

$$k_1 = \frac{m_1 \cdot g}{l}, \quad (1)$$

where  $g$  is the acceleration due to gravity and  $l$  is the length of the pendulum.

Defining the coordinate  $z = y - x$  leads to the equations of motion

$$\begin{aligned} m_1 \cdot (\ddot{x} + \ddot{z}) &= k_1 \cdot z \\ m_2 \cdot \ddot{x} &= k_1 \cdot z - F. \end{aligned} \quad (2)$$

Solving and evaluating these equations gives rise to a dynamic factor by which to multiply the inertial force on the hoist load.

Furthermore, the FEM guideline prescribes a value of 2 as the dynamic factor related to the supporting structure. To determine this parameter, the square root of the square sum of the model’s two natural frequencies  $\omega_a$  and  $\omega_b$  are calculated  $\omega_r = \sqrt{\omega_a^2 + \omega_b^2}$  and compared with the time for deceleration.

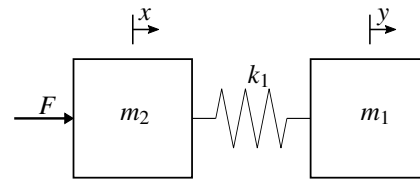

Figure 1: Model according to FEM 1.001.

When applied to the elastic lattice structures of tower cranes with modern drive systems, this simplified model has two major disadvantages:

1. The elasticity of the supporting structure is not considered.
2. The controlled drives currently used for tower cranes follow the accelerations and decelerations specified by the crane control very closely. Thus, the movement of the mass  $m_2$  is determined entirely by the crane control and the two-mass model is consequently reduced to a one-mass model of the hoist load’s pendulum.

For these reasons, this simplified model cannot accurately represent the dynamic loads on tower cranes and the approach is consequently not adopted in the current draft of EN 14439. Therefore, a modified two-mass model is presented in the following section in order to determine the dynamic loads during slewing with an increased accuracy.

### 3 VIBRATION MODEL

Figure 2 shows the modified vibration model for calculating the dynamic factors. In comparison to

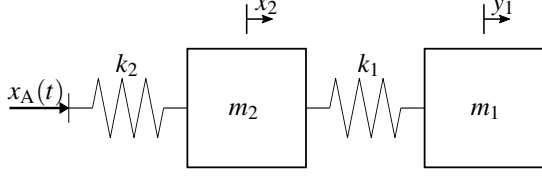

Figure 2: Modified vibration model for calculating dynamic factors of tower cranes.

Figure 1, an additional spring with the stiffness  $k_2$  is added to describe the stiffness of the supporting structure. Furthermore, the displacement  $x_A(t)$  replaces the driving force  $F$ . When the load case slewing is calculated,  $x_A(t)$  is proportional to the time course of the slewing angle of the crane slewing gear, which is determined by the crane control. The dynamic behaviour of the supporting structure and the hoist load can thus be expressed by the equations of motion

$$\begin{aligned} m_1 \cdot (\ddot{x}_1 + \ddot{x}_2) + k_1 \cdot x_1 &= -m_1 \cdot \ddot{x}_A(t) \\ m_2 \cdot \ddot{x}_2 - k_1 \cdot x_1 + k_2 \cdot x_2 &= -m_2 \cdot \ddot{x}_A(t) \end{aligned} \quad (3)$$

with  $x_1 = y_1 - x_2$ . The mass  $m_1$  again represents the mass of the hoist load, the stiffness  $k_1$  is defined by Eq. 1.

The mass  $m_2$  and the stiffness  $k_2$  are determined by the results of a frequency analysis of the crane's finite element structure. Numerical investigations about mobile cranes have shown that the vibrations caused during the slewing process of cranes contain only few natural frequencies (Stölzner et al., 2018). During the process of slewing, tower cranes exhibit a similar dynamic behaviour (see chapter 4.2). Consequently, only the first two lowest natural frequencies corresponding to the modeshapes, which are orthogonal to the plane of the supporting structure, are decisive in analysing the slewing process.  $\omega_1$  is usually the lowest natural frequency of the crane structure at which the tip of the boom and the hoist load swing in phase, while  $\omega_2$  is the lowest natural frequency at which the tip of the boom and the hoist load swing out of phase. The characteristic equation

$$\det \left( \begin{bmatrix} m_1 & m_1 \\ 0 & m_2 \end{bmatrix} \cdot \lambda^2 + \begin{bmatrix} k_1 & 0 \\ -k_1 & k_2 \end{bmatrix} \right) = 0, \quad (4)$$

with  $\lambda_1^2 = -\omega_1^2$  and  $\lambda_2^2 = -\omega_2^2$  is used to calculate the values  $m_2$  and  $k_2$ . The mass  $m_2$  and the stiffness  $k_2$  are finally determined with the equations

$$m_2 = -\frac{k_1^2 \cdot m_1}{(k_1 - m_1 \cdot \omega_1^2) \cdot (k_1 - m_1 \cdot \omega_2^2)} \quad (5)$$

$$k_2 = -\frac{k_1 \cdot m_1 \cdot \omega_1^2 \cdot \omega_2^2}{(k_1 - m_1 \cdot \omega_1^2) \cdot (k_1 - m_1 \cdot \omega_2^2)}. \quad (6)$$

The differential equations (3) of the two-mass model can easily be solved analytically. For that reason, no numerical methods are required for calculating the dynamic factor, and consequently the proposed method only needs slightly more computing time than the method proposed by the standard.

The dynamic factor related to the hoist load and the supporting structure are calculated with the solutions  $x_1(t)$  and  $x_2(t)$  of Eq. 3 for the associated working cycle. The solution of the static displacement  $x_{1,m}$  and  $x_{2,m}$  for a constant averaged acceleration  $a_m$  of the drive system results in the equations

$$x_{1,m} = -\frac{m_1 \cdot a_m}{k_1} \quad (7)$$

$$x_{2,m} = -\frac{(m_1 + m_2) \cdot a_m}{k_2}. \quad (8)$$

The displacement solution  $x_2(t)$  is proportional to the lateral deflection of the boom. As the maximum lateral deflection of the boom is again proportional to the maximum bending moment in the boom, the largest absolute value of  $x_2(t)$  at the point in time  $t = t_{\max}$  is, therefore, relevant for calculating the dynamic factor.  $x_1(t_{\max})$  is the corresponding value of the hoist load's lateral displacement. The new dynamic factors for the static stress calculation result from the quotient of the calculated dynamic displacements  $x_1(t_{\max})$ ,  $x_2(t_{\max})$  and the static solutions  $x_{1,m}$  and  $x_{2,m}$ . The dynamic factor applied on the supporting structure  $\Phi_{5,s}$  and the factor for the hoist load  $\Phi_{5,p}$  are calculated with the relations

$$\Phi_{5,s} = \frac{x_2(t_{\max})}{x_{2,m}} \quad (9)$$

$$\Phi_{5,p} = \frac{x_1(t_{\max})}{x_{1,m}}. \quad (10)$$

Both dynamic factors refer to the inertial forces acting on the crane structure and the hoist load at the constant mean accelerations  $a_m$  of the slewing drive. Based on the standard ISO 8686-3, the inertial forces are still calculated with a rigid-body kinetic model of the crane, and the dynamic behaviour is estimated by applying the determined factors  $\Phi_{5,s}$  and  $\Phi_{5,p}$  on the inertia forces. To take the centrifugal forces into account, the factor of  $\Phi_5 = 1$  recommended in ISO 8686-3 is maintained.

The basic requirement of this vibration model is a constant natural frequency during the slewing process, which is satisfied for both bottom slewing and top slewing tower cranes. In the case of the bottom slewing tower cranes, the entire structure moves, which means that the stiffness, and thus also the natural frequencies of the crane system, do not change. For top slewing tower cranes, the natural frequencies also remain constant, since the tower consists of a rectangular cross-section and the moment of inertia is constant in all directions.

## 4 NUMERICAL ANALYSIS

According to ISO 4306-3 (ISO 4306-3, 2016), the characteristics of tower cranes can be classified as assembly, slewing level, type of boom and configuration. In the following calculations, a stationary, top slewing crane with horizontal boom is analysed. The subsequent sections present the crane with its analysed parameters (see Section 4.1) and show the numerical results using different calculation methods (see Section 4.2).

### 4.1 Modelling

The calculation of the dynamic loads is based on a crane with a maximum hoisting capacity of 12 metric tonnes. In order to investigate the dynamic behaviour of different crane configurations, the evaluation comprises different vertical and horizontal positions of the hoist load. To analyse the influence of the hoist load's vertical position, four different hoisting rope lengths (0.7 m, 5 m, 10 m, 46 m) are selected (see Figure 3). No damping is considered in the numerical calculations because the objective of the investigations is to

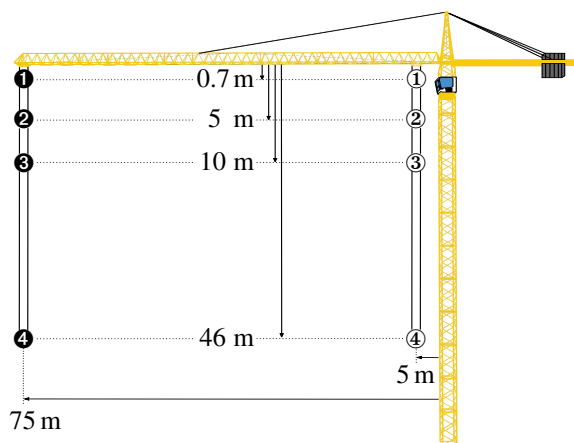

Figure 3: Modelling of the tower crane and analysed positions of the hoist load.

assess the accuracy of different approaches for the stress calculations and not to analyse the influence of damping on the supporting structure.

The finite element program NODYA, which was especially developed for the crane calculation, is used to carry out the calculations. The original focus of this software was the dynamic and static stress calculation of mobile cranes, but it is also capable of calculating the lattice boom structures of tower cranes (Maier, 2000). It provides special features for the crane calculation such as a cable element and a superelement. The load cycle for analysing the dynamic effects includes the phases acceleration, constant velocity and deceleration. Linear time courses for the acceleration and velocity are assumed, choosing the same time for acceleration and deceleration (see Figure 4).

The point in time  $t_{\max}$  of the maximum lateral movement of the boom system is detected with a chosen simulation time of 60 s. To identify the maximum stress, the calculations are carried out with 11 different time durations of constant velocity  $t_B$ , ranging from 0 s to 20 s. Crane manufacturers often only consider one acceleration phase, as the crane operator should commonly choose a convenient braking point to achieve minimal vibration of the supporting structure and the load. However, in the modelled process including the phase of deceleration, the influence of the crane operator is disregarded as this represents the more conservative load case.

As described in Section 2.1, the loads calculated according to the international standard are mainly dominated by the inertia forces and, therefore, depend almost entirely on the acceleration of the supporting structure. To verify this approach and to show possible dependencies of the dynamic loads on velocity or acceleration, different combinations of angular speed and angular acceleration are analysed in the calculations (see Table 1). As the FEM guideline recommends an acceleration time between 5 s and 10 s, a

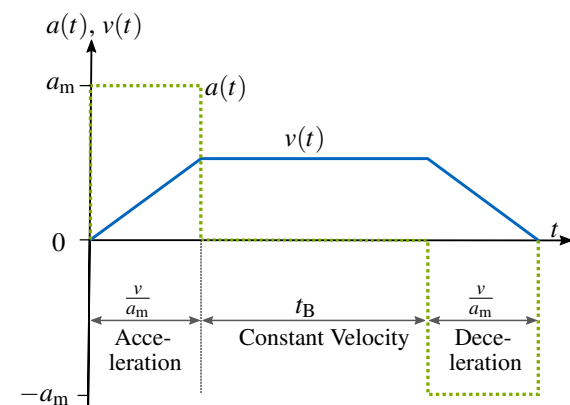

Figure 4: Analysed time course of the angular acceleration and angular velocity of the slewing drive.

time close to this range is selected. In addition, it is ensured that the drive torques do not exceed a value of about 400 kNm.

Table 1: Analysed combinations of angular velocity and accelerations.

$\omega$ in $\text{rad s}^{-1}$	$\dot{\omega}$ in $\text{rad s}^{-2}$	$\omega/\dot{\omega}$ in s
0.0105	0.0015	7
0.0105	0.0021	5
0.0105	0.0026	4
0.021	0.0021	10
0.021	0.003	7
0.0315	0.00263	12
0.042	0.0028	15

## 4.2 Results

The nonlinear dynamic finite element calculation is the calculation method that can be considered the most realistic for cranes. For this reason, the results obtained from the calculation standard and the vibration model are evaluated by means of comparison with the results of the dynamic finite element calculation.

### 4.2.1 Dynamic calculation and ISO 8686

Figure 5 shows an exemplary comparison between the dynamic calculation and ISO 8686-3. The figure shows the time courses of the lateral deformation of the boom's tip regarding 11 different times  $t_B$  between 0 s and 20 s. The maximum values depend strongly on the point in time at which breaking is initiated and on the duration of the steady state time  $t_B$ . However, it is not possible to standardise the most crucial time  $t_B$  since the time courses change for different crane configurations and different angular velocities or accelerations. The results of the static calculation according to ISO 8686-3 are shown for a positive and a negative direction of slewing. In the crane configuration considered, the results of the static calculation are lower than the absolute maximum of the dynamic calculation.

Figure 6 shows the results of the lateral deformation of the crane's boom tip for all load positions ①-④ and ①-④ of Figure 3. The diagram shows the results for the combination of velocity and acceleration at which the maximum lateral displacement of the boom tip occurs. When the angular velocities and accelerations resulting in the maximum lateral displacement of the dynamic calculation are analysed, it is noticeable that the maximum always occurs at the highest considered acceleration of  $0.003 \text{ rad s}^{-2}$ . This indicates that the

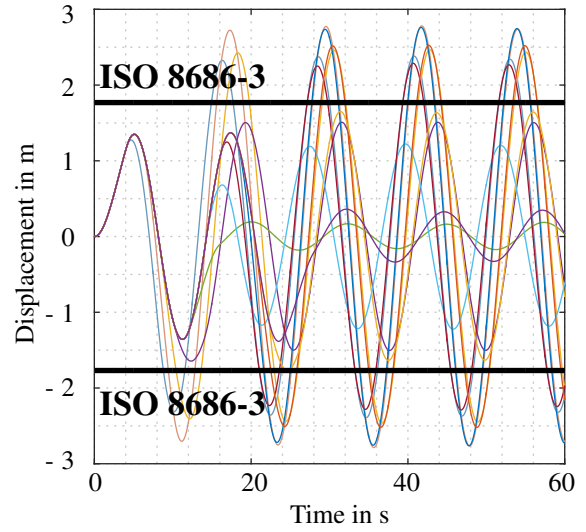

Figure 5: Time courses of the boom tip including different times  $t_B$ ,  $\omega = 0.0105 \text{ rad s}^{-1}$ ,  $\dot{\omega} = 0.0026 \text{ rad s}^{-2}$ ,  $m_1 = 12 \text{ t}$ , length of hoisting rope: 10 m, horizontal load position: 5 m.

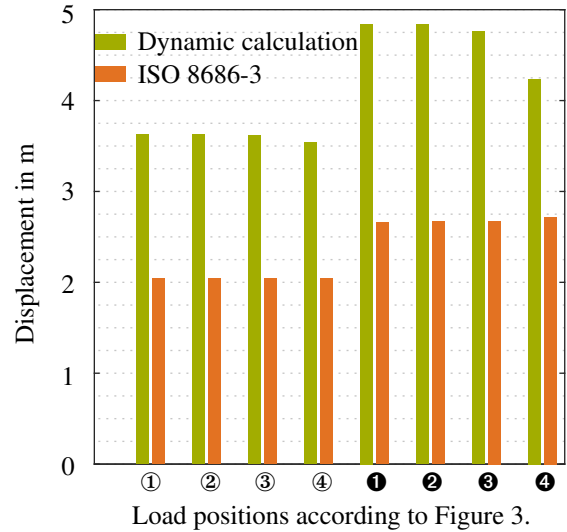

Figure 6: Maximum lateral displacement of all analysed crane systems, calculated with the dynamic calculation and according to ISO 8686-3. The maximum is always reached with  $\omega = 0.021 \text{ rad s}^{-1}$  and  $\dot{\omega} = 0.003 \text{ rad s}^{-2}$ .

dynamic crane loads depend mainly on the angular acceleration and not on the angular velocity of the tower crane, which is analysed more precisely in Section 4.2.2. For all velocities and accelerations considered, the calculation according to ISO 8686-3 results values that are too low for the dynamic loads. Furthermore, it is apparent that the differences between the calculation according to the standard and the dynamic finite element calculation occur for all investigated positions of the hoist load.

When we study the dependency of the maximum lateral displacement on the pendulum length, a decreasing crane load is obtained with increasing pendulum length. For this reason, the requirement of the standard, which prescribes a load position “at the top of the jib or immediately below the crab” (ISO 8686-1, 2012) could be confirmed by these numerical tests.

#### 4.2.2 Dynamic calculation and vibration model

Figure 7 shows a Fourier transformation of the dynamic time course of the hoist load’s lateral displacement. In the frequency domain it becomes clear that the vibration is mainly dominated by two frequencies, which correspond to the first and the fourth natural frequency of the crane. Since other frequencies influence the vibration signal only very slightly, the vibration can be simulated with the developed two mass model.

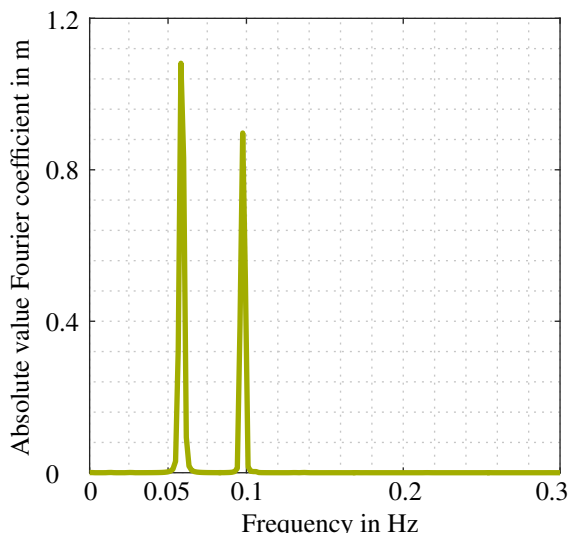

Figure 7: Fourier transformation of the hoist load’s lateral displacement,  $\omega = 0.0105 \text{ rad s}^{-1}$ ,  $\dot{\omega} = 0.0026 \text{ rad s}^{-2}$ ,  $t_B = 10 \text{ s}$ ,  $m_1 = 2.5 \text{ t}$ , length of hoisting rope: 46 m, horizontal load position: 75 m.

Figure 8 shows the time course of the lateral displacement of the hoist load’s suspension point for both the dynamic calculation and the vibration model. The vibration model reproduces the time course of the dynamic finite element calculation with high accuracy. Both frequency and amplitude are reproduced almost exactly as the higher natural frequencies make no noticeable contribution to the vibration. For this reason, the use of only two natural frequencies in the vibration model shown leads to almost the exact reconstruction of the nonlinear dynamic finite element calculation.

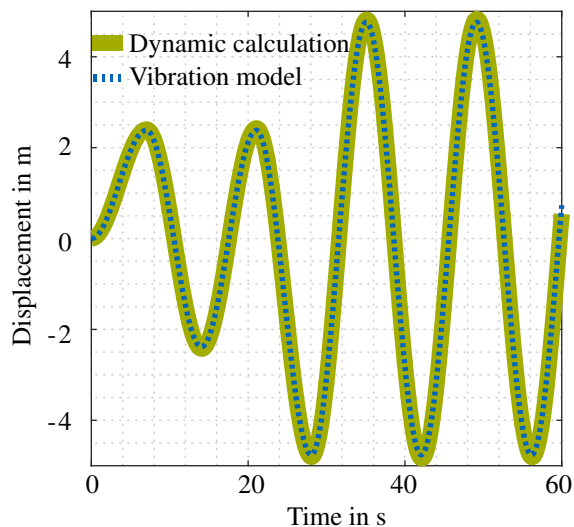

Figure 8: Time course of the hoist load’s suspension point,  $\omega = 0.021 \text{ rad s}^{-1}$ ,  $\dot{\omega} = 0.003 \text{ rad s}^{-2}$ ,  $t_B = 14 \text{ s}$ ,  $m_1 = 2.5 \text{ t}$ , horizontal load position: 75 m.

Table 2 shows the dynamic factors related to the hoist load and the supporting structure according to the Eqs. 9 and 10. The dynamic factors vary considerably, in part, when the different velocities and accelerations are used. In all cases, the dynamic factor related to the hoist load is higher than the factor for the supporting structure, as an increased inertia force acts on the hoist load due to the pendulum. Furthermore, a dependency of the dynamic factor on the angular acceleration of the crane can be derived, while the dependency on the angular velocity is considerably lower. In an earlier publication about mobile cranes, it was already possible to determine dependency conditions for velocity and acceleration based on the breaking time and the period of vibration (Kleeberger et al., 2014). Since the selected angular acceleration is relatively low in each case, the dependency on the angular acceleration is more significant in the presented analyses. The analysis of special working conditions, such as the load case emergency stop with its high ac-

Table 2: Dynamic factors calculated with the vibration model,  $m_1 = 2.5 \text{ t}$ , length of hoisting rope: 5 m, load-lifting radius: 75 m.

$\omega$ in $\text{rad s}^{-1}$	$\dot{\omega}$ in $\text{rad s}^{-2}$	$t_B$ in s	$\Phi_{5,s}$	$\Phi_{5,p}$
0.0105	0.0015	0	1.999	2.017
0.0105	0.0021	2	1.889	1.935
0.0105	0.0026	18	1.752	1.83
0.021	0.0021	12	1.889	1.916
0.021	0.003	0	1.999	2.017
0.0315	0.00263	12	1.717	1.726
0.042	0.0028	18	1.526	1.578

celerations, would result in other dependencies. Overall, it can be seen that the recommended value of  $\Phi_3=1.5$ , which is specified in ISO 8686-3, cannot lead to satisfactory results in most cases. The value 1.5 is only suitable for the longest acceleration time of 15 s. In Figure 9, the maximum lateral displacements of the boom's tip resulting from the dynamic calculation are compared with the quasi-static calculations. In order to investigate the quality of the load assumptions derived from the vibration model with those of ISO 8686-3, the results of both methods are included in the diagram. The quasi-static calculations using the vibration model are based on the dynamic factors listed in Table 2. It is obvious that the dynamic factors based on the vibration model allow a much more accurate representation of the dynamic calculation than using the default factor of 1.5 which is specified in the standard. The dynamic calculation can be reproduced with high accuracy for all angular velocities and accelerations by using the calculated dynamic factors. This clearly shows that the approach of the quasi-static calculation leads to precise results when appropriate dynamic factors are used.

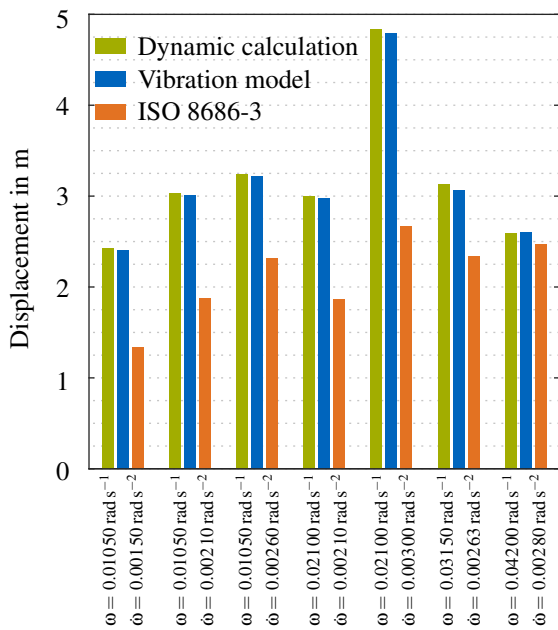

Figure 9: Maximum lateral displacement,  $m_1 = 2.5 \text{ t}$ , length of hoisting rope: 5 m, horizontal load position: 75 m.

## 5 CONCLUSION and OUTLOOK

In this paper, the dynamic loads on tower cranes during the slewing operation were analysed. The accuracy of the standard ISO 8686-3 was evaluated by comparing the results with the results of the nonlinear dynamic finite element calculation. For the crane investigated in this publication, the dynamic loads were usually underestimated with the default dynamic factor stipulated in the standard.

In order to describe the dynamic behaviour of the tower crane during the slewing operation more accurately, a newly developed vibration model, based on a two-degree-of-freedom system, was presented in this article. With the help of this model, the elastic deformations of the supporting structure could be considered in the stress calculation. It was possible to determine dynamic factors that allow a more accurate description of the dynamic loads on tower cranes than the commonly used factors from the standard. Concurrently, a similar computing time could be achieved, since the vibration model is based on an analytical solution of the two-degree-of-freedom system. The comparisons included different angular velocities and accelerations of the driving system and different positions of the hoist load to determine the influence of these parameters on the dynamic effects. By analysing typical working cycles, the risks and potentials of the current tower crane calculation during the slewing process could be shown. The knowledge of the dynamic loads on tower cranes can provide information about the quality of the standard's load assumptions.

To verify the statements on the dynamic properties and the applicability of the vibration model, systematic comparisons including different types of cranes should be carried out in the future. Furthermore, new measurements of currently used tower cranes are necessary to obtain further results regarding the accuracy of the modelled crane and the different calculation methods. An important question also arises from the applicability of the vibration model to different working processes, such as hoisting or luffing.



## REFERENCES

- Blajer, W. and Kołodziejczyk, K. (2011). Improved DAE formulation for inverse dynamics simulation of cranes. *Multibody System Dynamics*.
- Doçi, I., Hamidi, B., and Lajqi, S. (2016). Dynamic analysis and control of jib crane in case of jib luffing motion using modelling and simulations. *International Federation of Automatic Control-PapersOnLine*.
- Ju, F. and Choo, Y. S. (2005). Dynamic Analysis of Tower Cranes. *Journal of Engineering Mechanics-ASCE*.
- Ju, F., Choo, Y. S., and Cui, F. S. (2006). Dynamic response of tower crane induced by the pendulum motion of the payload. *International Journal of Solids and Structures*.
- Kleeberger, M., Schneidler, S., and Günthner, W. A. (2014). Untersuchung der dynamischen Beanspruchungen bei Gittermast-Fahrzeugkranen und Vergleich mit der quasistatischen Auslegung der Norm. In *Tagungsband 22. Kranfachtagung*. Otto von Guericke University Magdeburg.
- Le, T. A., Dang, V.-H., Ko, D. H., An, T. N., and Lee, S.-G. (2013). Nonlinear controls of a rotating tower crane in conjunction with trolley motion. *Journal of Systems and Control Engineering*.
- Maier, K. J. (2000). *Untersuchung zur nichtlinearen Berechnung dynamischer Belastungsvorgänge an Turmdrehkranen*. PhD thesis, Technical University of Munich.
- DIN 15018 (1984). German Institute for Standardization: Cranes - principles for steel structures - stress analysis.
- EN 13001-2 (2014). European Committee for Standardization: Crane Safety - General design - Part 2: Load actions.
- EN 14439 (2010). European Committee for Standardization: Cranes - Safety - Tower cranes.
- FEM 1.001 (1998). Federation Europeenne de la Manutention (FEM): Rules for the design of hoisting appliances.
- ISO 4306-3 (2016). International Organization for Standardization: Cranes - Vocabulary - Part 3: Tower cranes.
- ISO 8686-1 (2012). International Organization for Standardization: Cranes - Design principles for loads and load combinations - Part 1: General.
- ISO 8686-3 (2018). International Organization for Standardization: Cranes - Design principles for loads and load combinations - Part 3: Tower cranes.
- prEN 14439 (2018). European Committee for Standardization: Cranes - Tower cranes (Draft).
- Stölzner, M., Kleeberger, M., Günthner, W. A., and Fottner, J. (2018). Vibration model to describe the dynamic behaviour of lattice boom mobile cranes and loader cranes. In *Logistics Journal: Proceedings*. WGTL.
- Stölzner, M., Kleeberger, M., Günthner, W. A., and Fottner, J. (2019). Calculating the dynamic behaviour of lattice boom mobile cranes during hoisting with a vibration model. In *XXIII International Conference on Material Handling, Constructions and Logistics - MHCL 2019*. Vienna University of Technology (Institute for Engineering Design and Product Development) together with University of Belgrade (Faculty of Mechanical Engineering).