



Master's Thesis

Determination and analysis of power quality on-grid and off-grid in Nepal and its effect on electrical appliances

In partial fulfillment of the requirements for the degree
Master of Science
at the department Electrical and Computer Engineering
of the Technical University of Munich.

Advisor Anna-Kaarina Seppälä
 Prof. Dr. rer. nat. Thomas Hamacher
 Chair of Renewable and Sustainable Energy Systems

Submitted by Mathias Bottheim

Submitted on Munich, March, 12, 2018

Abstract

Nepal's main electricity generation is guaranteed through hydro-electrical power plants. However in more remote areas of the country the electricity supply is covered by island grids and the available capacity of the plants is not enough to satisfy the demand of the population in times of peak load. In addition, due to missing storage techniques and regulation systems, the power quality in these areas is far below western world standards.

The objective of this thesis was to record and analyze power quality data in off and on grid locations in Nepal. For that, on-site measurements in two different villages in the Manang district of Nepal and the capital city Kathmandu were performed. In addition, an on grid power quality measurement was conducted in Munich. At each location, the data was recorded over a one week period. The measurements consist of the power quality criteria voltage, frequency and sine wave-form and were stored at ten-second intervals by a number of different analyzing devices, including a self-built datalogger. For rural areas, the deviations from the nominal values were extremely high in contrast to the data collected in Kathmandu.

As a next step, the influence of variations in frequency and voltage on typical Nepali electrical appliances were investigated from a consumer standpoint in a laboratory test set-up. The output parameters of resistive loads were affected the most by voltage deviations below the nominal voltage. Frequency deviations had no mentionable impact on the output variables of the tested electrical appliances. The examined switch mode power supply appliances were immune to voltage and frequency variations from a consumer standpoint. However, they could have a negative effect on the purity of the supply voltage sine wave form in the power system, as they impose harmonic distortions on the electrical network.

Based on the collected data, the power quality in Nepal can be classified and a conclusion about the response of various electrical appliances to variations in power quality can be made.

Key words: Power quality, developing countries, Nepal, on grid, off grid, electrical appliances

Statement of Academic Integrity

I,

Last name: Bottheim

First name: Mathias

hereby confirm that the attached thesis,

Determination and analysis of power quality on-grid and off-grid in Nepal and its
effect on electrical appliances

was written independently by me without the use of any sources or aids beyond those cited, and all passages and ideas taken from other sources are indicated in the text and given the corresponding citation.

I confirm to respect the “Code of Conduct for Safeguarding Good Academic Practice and Procedures in Cases of Academic Misconduct at Technische Universität München, 2015”, as can be read on the website of the Equal Opportunity Office of TUM.

Tools provided by the chair and its staff, such as models or programs, are also listed. These tools are property of the institute or of the individual staff member. I will not use them for any work beyond the attached thesis or make them available to third parties.

I agree to the further use of my work and its results (including programs produced and methods used) for research and instructional purposes.

I have not previously submitted this thesis for academic credit.

Munich, March, 12, 2018 _____

Declaration for the transfer of the thesis

I agree to the transfer of this thesis to:

- Students currently or in future writing their thesis at the chair:
 - Flat rate by employees
 - Only after particular prior consultation.
- Present or future employees at the chair
 - Flat rate by employees
 - Only after particular prior consultation.

My copyright and personal right of use remain unaffected.

Munich, March, 12, 2018 _____

Contents

Abstract	1
Statement of Academic Integrity	3
Declaration for the transfer of the thesis	5
Contents	7
List of Figures	9
List of Tables	13
Nomenclature	17
1 Introduction	19
1.1 Motivation	19
1.2 Problem statement	19
1.3 Outline of the thesis	20
2 Theory	21
2.1 Power Quality	21
2.1.1 What is power quality?	21
2.1.2 Power quality criteria	21
2.1.3 Voltage	23
2.1.4 Frequency	25
2.1.5 Sinewave-Form	25
2.1.6 Existing power quality norms in different countries	28
2.2 Fundamentals of electrical measurement	29
2.2.1 Foundations of voltage and current measurement	29
2.2.2 Sine wave-form recording and frequency measurement	31
2.3 Classification of electrical appliances	33
2.3.1 Resistive	34
2.3.2 Inductive (with motor)	35
2.3.3 Electronics and switched mode power supply	36
2.4 Power consumption in Nepal	37
2.4.1 Facts and figures	37
2.4.2 Status quo of power quality in Nepal	41
2.4.3 Commonly used appliances in Nepal (from questionnaire)	41

3	On-site measurements of power quality	43
3.1	Equipment	43
3.1.1	Datalogger	43
3.1.2	Multimeter	46
3.1.3	Oscilloscope	47
3.2	Locations	48
3.3	Results and discussion	51
3.3.1	Validation of self built datalogger	52
3.3.2	On grid	53
3.3.3	Off grid	61
3.4	Summary	67
4	Testing of electrical consumers under varying power quality	69
4.1	Testing setup	69
4.1.1	Isolation transformer	70
4.1.2	Variable frequency drive	70
4.1.3	Test rig	71
4.1.4	Chauvin Arnoux 8336	72
4.2	Types of appliances	73
4.2.1	Lighting sources	73
4.2.2	Water boiler	73
4.2.3	Rice cooker	73
4.2.4	Mobile charger	73
4.2.5	TVs	74
4.3	Testing conditions	75
4.4	Results and discussion	76
4.4.1	Lighting sources	76
4.4.2	Water boiler	81
4.4.3	Rice cooker	82
4.4.4	Mobile chargers	85
4.4.5	TVs	88
4.5	Summary	90
5	Conclusion	91
5.1	Critical reflection and experiences	91
5.2	Summary	91
5.3	Prospect	93
6	Appendix	95
	Bibliography	111

List of Figures

2.1	Sag [6]	23
2.2	Swell [6]	24
2.3	Impulsive transient [6]	26
2.4	Oscillatory transient [6]	27
2.5	Correct voltage measurement via multimeter [13].	29
2.6	Correct electrical current measurement via multimeter [14].	30
2.7	Basic principle of a current transformer clamp meter [16].	30
2.8	Profile of current transformer (left) and hall sensor clamp meter (right) [17].	31
2.9	Map of Nepal.	37
2.10	Nepals population growth from 1960 to 2016 [3].	38
2.11	Development of Nepals GDP from 1960 to 2016 [3].	39
2.12	Share of primary energy supply sources after IEA [28].	39
2.13	Share of primary energy consumption from 1995 to 2015 in Nepal [28].	40
2.14	Sources of available energy in Nepal’s electricity grid [29].	40
3.1	Netzanalysator and Voltfox. [own illustration]	44
3.2	Stacking shield of the Arduino on the circuit board of the self-built data-logger. [own illustration]	45
3.3	Voltcraft VC 820-1 (left) and UNI-T UT61B (right) [own illustration].	46
3.4	Peaktech 1220 oscilloscope [own illustration].	47
3.5	Map showing the measurement locations (red) and the three hydro power plants (orange) of the Manang valley. [35]	48
3.6	Sabje power station and penstock [own illustration]	49
3.7	Chame power station and penstock [own illustration]	50
3.8	Voltage recording from data-logger (black) and multimeter (red) [own illustration].	52
3.9	Frequency recording from data-logger (blue) and multimeter (yellow) [own illustration].	52
3.10	One week voltage recording from Munich [own illustration].	53
3.11	One week frequency recording from Munich [own illustration].	53
3.12	One day recording of voltage (black) and frequency (blue) from Munich [own illustration].	54
3.13	Weekly probability of frequency and voltage values in Munich [own illustration].	54
3.14	Sine wave recorded in Munich and ideal sine wave for comparison.	55
3.15	One week voltage recording from Kathmandu [own illustration].	55

3.16	One week frequency recording from Kathmandu [own illustration]. . . .	56
3.17	One day recording of voltage (black) and frequency (blue) from Kathmandu [own illustration].	56
3.18	Weekly probability of frequency and voltage values from Kathmandu [own illustration].	57
3.19	Sine wave recorded in Kathmandu and ideal sine wave for comparison.	57
3.20	One day recording of voltage (black) and frequency (blue) from Pokhara [own illustration].	58
3.21	Daily probability of frequency and voltage values from Pokhara [own illustration].	59
3.22	Sine wave recorded in Pokhara and ideal sine wave for comparison. . .	59
3.23	One week voltage recording from the LBS [own illustration].	61
3.24	One week frequency recording from LBS [own illustration].	61
3.25	One day recording of voltage (black) and frequency (blue) from LBS [own illustration].	62
3.26	Weekly probability of frequency and voltage values from LBS [own illustration].	63
3.27	Sine wave recorded at the LBS and ideal sine wave for comparison. . .	63
3.28	One week voltage recording from Chame [own illustration].	64
3.29	One week frequency recording from Chame [own illustration].	64
3.30	One day recording of voltage (black) and frequency (blue) in Chame [own illustration].	65
3.31	Weekly probability of frequency and voltage values in Chame [own illustration].	65
3.32	Sine wave recorded in Chame and ideal sine wave for comparison. . . .	66
4.1	Block diagram of isolated voltage (black) and frequency (blue) experiment setup.	69
4.2	Peaktech 2235 [38].	70
4.3	Output sine wave of the synchronous generator and ideal sine wave. . .	71
4.4	Self-built test rig with 4-mm terminals and several electrical sockets [own illustration].	71
4.5	Chauvin Arnoux 8336 power & quality analyzer [40].	72
4.6	Illuminance dependent on voltage (left) and frequency (right) for three samples of incandescent lightbulb lamps.	77
4.7	Illuminance dependent on voltage (left) and frequency (right) for three samples of CFL lamps.	78
4.8	Illuminance dependent on voltage (left) and frequency (right) for three samples of DYVIA LED lamps.	79
4.9	Illuminance dependent on voltage (left) and frequency (right) for three samples of SCT LED lamps.	81
4.10	Time before water cooks dependent on voltage (left) and frequency (right) for a 300 W water boiler.	82
4.11	Time before water cooks dependent on voltage (left) and frequency (right) for a 300 W rice cooker.	83
4.12	Time before water cooks dependent on voltage (left) and frequency (right) for a 700 W rice cooker.	84

4.13	Power output dependent on voltage (left) and frequency (right) for three samples of the Samsung mobile charger.	86
4.14	Power output dependent on voltage (left) and frequency (right) for three samples of the Balaji mobile charger.	87
4.15	Power dependent on voltage (left) and frequency (right) for a LED TV.	89
6.1	Charging voltage and current from Samsung mobile charger for 230 V.	105
6.2	Charging voltage and current from Samsung mobile charger for 150 V.	106
6.3	One month voltage recording from Pokhara.	107
6.4	Voltage recording from Dhulikel.	108
6.5	Frequency recording from Dhulikel.	109

List of Tables

2.1	Classification of electromagnetic phenomena in power systems [8] . . .	22
2.2	Classification of frequency deviations in power systems.	25
2.3	Power quality norms for different countries	28
3.1	Key parameters of Sabje Power Station	49
3.2	Key parameters of Chame Power Station	50
3.3	Voltage quality indices for February 13th-measurement in Munich. . . .	54
3.4	Voltage quality indices for one day measurement in Kathmandu	56
3.5	Voltage quality indices for one day measurement in Pokhara	58
3.6	Voltage quality indices for one day measurement at LBS	62
3.7	Voltage quality indices for one day measurement in Chame	65
4.1	Voltage variations and effect on electrical parameters for an incandescent lightbulb.	76
4.2	Frequency variations and effect on electrical parameters for an incandescent lightbulb.	76
4.3	Voltage variations and effect on electrical parameters for CFL lamp. . .	77
4.4	Frequency variations and effect on electrical parameters for CFL lamp. .	78
4.5	Voltage variations and effect on electric parameters for LED lamp by DIVYA	79
4.6	Frequency variations and effect on electric parameters for LED lamp by DIVYA	79
4.7	Voltage variations and effect on electric parameters for the SCT LED lamp.	80
4.8	Frequency variations and effect on electric parameters for the SCT LED lamp.	80
4.9	Voltage variations and effect on electric parameters for water boiler . . .	81
4.10	Frequency variations and effect on electric parameters for water boiler .	82
4.11	Voltage variations and effect on electric parameters for 300 W rice cooker	83
4.12	Frequency variations and effect on electric parameters for 300 W rice cooker	83
4.13	Voltage variations and effect on electric parameters for 700 W rice cooker	84
4.14	Frequency variations and effect on electric parameters for 700 W rice cooker	84
4.15	Voltage variations and effect on electric parameters for Samsung mobile charger	85
4.16	Frequency variations and effect on electric parameters for Samsung mobile charger	86

4.17 Voltage variations and effect on electric parameters for Balaji mobile charger	86
4.18 Frequency variations and effect on electric parameters for Balaji mobile charger	87
4.19 Voltage variations and effect on electrical parameters for CRT TV	88
4.20 Frequency variations and effect on electrical parameters for CRT TV . .	88
4.21 Voltage variations and effect on electric parameters for LED TV	89
4.22 Frequency variations and effect on electric parameters for LED TV . . .	89
6.1 Voltage variations and effect on electrical parameters for an incandescent lightbulb.	95
6.2 Frequency variations and effect on electrical parameters for an incandescent lightbulb.	95
6.3 Voltage variations and effect on electrical parameters for a CFL lamp. .	96
6.4 Frequency variations and effect on electrical parameters for a CFL lamp.	96
6.5 Voltage variations and effect on electrical parameters for a LED lamp by DIVYA.	96
6.6 Frequency variations and effect on electrical parameters for a LED lamp by DIVYA.	97
6.7 Voltage variations and effect on electrical parameters for SCT LED lamp.	97
6.8 Frequency variations and effect on electrical parameters for SCT LED lamp.	98
6.9 Voltage variations and effect on electrical parameters for water boiler. .	98
6.10 Frequency variations and effect on electrical parameters for water boiler.	98
6.11 Voltage variations and effect on electrical parameters for a 300 W rice cooker.	99
6.12 Frequency variations and effect on electrical parameters for a 300 W rice cooker.	99
6.13 Voltage variations and effect on electrical parameters for a 700 W rice cooker.	99
6.14 Frequency variations and effect on electrical parameters for a 700 W rice cooker.	100
6.15 Voltage variations and effect on electrical parameters for Samsung mobile charger.	100
6.16 Frequency variations and effect on electrical parameters for Samsung mobile charger.	101
6.17 Frequency and voltage variations and their effect on electrical parameters for Samsung mobile charger.	101
6.18 Voltage variations and effect on electrical parameters for Balaji mobile charger.	101
6.19 Frequency variations and effect on electrical parameters for Balaji mobile charger.	102
6.20 Frequency and voltage variations and their effect on electrical parameters for Balaji mobile charger.	102
6.21 Voltage variations and effect on electrical parameters for CRT TV. . . .	102
6.22 Frequency variations and effect on electrical parameters for CRT TV. . .	103
6.23 Voltage variations and effect on electrical parameters for LED TV. . . .	103
6.24 Frequency variations and effect on electrical parameters for LED TV. . .	103

6.25 Voltage and frequency variations and effect on electrical parameters for LED TV.	104
---	-----

Nomenclature

<i>a.c.</i>	Alternating current
<i>CPS</i>	Chame power station
<i>d.c.</i>	Direct current
<i>f</i>	Frequency
<i>GDP</i>	Gross domestic product
<i>I</i>	Electric current
<i>IEA</i>	International Energy Agency
<i>LBS</i>	Lophelling Boarding School
<i>LDC</i>	Least developed countries
<i>NEA</i>	Nepal Electricity Authority
<i>P</i>	Active power
<i>PF</i>	Power factor
<i>Q</i>	Reactive power
<i>R</i>	Resistance
<i>S</i>	Apparent power
<i>SARI</i>	South Asia Regional Initiative for Energy
<i>SMPS</i>	Switch mode power supply
<i>THD</i>	Total harmonic distortion
<i>V</i>	Voltage

Chapter 1

Introduction

1.1 Motivation

Nepal is a developing country and ranks on 144th place of 188 countries in the Human Development Index (HDI) [1]. After the devastating earthquake in 2015, the country is still suffering in many ways. The recovery could cost over 10 billion US\$ [2], which amounts to almost half the nations GDP. The annual GDP growth in Nepal has decreased from 6.0% in 2014 to 0.4% in 2016, which obviously is a result of the tragic event.

99.8 % of electricity generation in 2014 was covered by hydroelectric power plants [3]. According to [4] only 70% of the population have access to electricity and micro hydro power plants are supplying off-grid electricity to 20% of the population, which is contributing to a growth in economy in these rural areas.

The lack of reliable and affordable electricity access is a big obstacle for the growth of businesses and the economy in Nepal [5]. Large businesses have to generate up to 40% of their electricity needs themselves in order to cope with the uncertainty of energy supply. Self generation is almost four times as expensive as accessing electricity from the national grid [5].

In order to improve the supply and reliability of electric energy supply, power quality data for Nepal has to be gathered. As there is a high percentage of off-grid applications in Nepal, both national grid and off grid locations have to be considered.

Analyzing the results could identify the biggest problems and suggest possible actions to better the power supply conditions.

1.2 Problem statement

The first task of this thesis will be to conduct power quality measurements in Nepal, as there exists a lack of such data. Two different off grid locations will be analyzed over a one week period at a sampling rate of 10 seconds with the help of the power quality criteria voltage, frequency and the sine wave form. These will be complemented by a one week on grid measurement in the capital city of Nepal, Kathmandu. In addition a one week measurement in Munich is conducted for a significant comparison between on grid locations in a developing country and a European country. Frequency and voltage data will be collected with two digital multimeter recording devices and a self built data logger. Another objective of the

thesis is to test the device under varying frequency and voltage conditions. The results will be analyzed with help of a classification of electromagnetic phenomena by the IEEE. To complement these measurements, an oscilloscope is used to record the sine wave of the electrical grid.

The second task is testing a range of electrical appliances under isolated varying voltage and frequency conditions. For instance, voltage will be altered at a constant frequency level and vice versa. The goal is to find out whether consumers are affected by these variations in power quality. The results can have an impact on whether the electrical grid has to be optimized or can stay the same because the electric loads are more or less immune to the deviations.

1.3 Outline of the thesis

Following an introduction to the topic and a short description of the main objective of this master thesis, a theoretical basis for further understanding shall be provided in chapter 2. This includes an approach to define the term power quality and the classification of three criteria to make power quality a measurable problem. For that, the most common disturbances in power systems are introduced and in addition, the fundamentals of measuring electrical parameters relevant for this thesis will be presented. After a categorization of electrical appliances, the developing country Nepal will be introduced, including a questionnaire about power quality and commonly used appliances.

Chapter 3 will cover the on-site measurements of power quality, both on- and off-grid. It comprises a short introduction of the deployed equipment and the measurement locations. Further, a graphical representation and a final analysis of the gathered data will be conducted.

Building on these results, chapter 4 deals with the testing of typical Nepali electrical appliances in a laboratory environment, simulating the deviations in power quality. This includes a brief introduction of the testing setup and the examined electrical appliances. Further the testing conditions are defined and the results will be presented and finally analyzed.

In the fifth chapter, a critical reflection on the execution of the measurements will be stated. Lastly, a summary of the achieved and a outlook for further research work are presented.

The appendix in chapter 6 features all recorded measurement data and additional plots for the voltage and frequency experiments with electrical appliances.

Chapter 2

Theory

2.1 Power Quality

2.1.1 What is power quality?

When discussing the term power quality the average end-consumer might think about the number of outages or glitches. More and more smart electrical appliances are being developed every year, adapting to all kind of amenities via different kinds of built-in sensors. In the course of fighting global warming, conventional power plants are being replaced by thousands of smaller ones feeding off renewable energy sources, resulting in distributed rather than centralized generation. Electrical energy storages among many other innovative storage methods supplying the grid with additional power in times of low frequency or high loads are being developed and connected to the grid. Hence, there are going to be great challenges and shifts to be seen in the energy sector, which will have big impacts on the electrical grid as we know it today. In order to quantify the effect of all these changes on the power grid, a notion of the quality of the distributed electricity is needed. Electrical utilities and manufacturers of electrical appliances may have different definitions for power quality, but based on Roger C. Dugan, power quality [...is ultimately a consumer-driven issue, and the end user's point of reference takes precedence]. Further he defines it as [...any power problem manifested in voltage, current, or frequency deviations that results in failure or misoperation of customer equipment] [6]. In general it is impossible to find one definition, which is applicable to every situation or problem in power supply. Therefore, a classification in different criteria can at least make the problem measurable, although it still might not cover all aspects of it.

2.1.2 Power quality criteria

According to [7] it is generally accepted to classify power quality into voltage, frequency and sine wave form. As mentioned above this classification is dependent on the point of view. Hence there is more to power quality than these three parameters, however they are the most common ones to be used when considering what the output of an electrical outlet is. It is important to mention, that these values are intimately linked to each other as you can find all of them in the oscilloscope recording of an a.c. voltage signal. Table 2.1 illustrates a multitude of different

deviations from the nominal values in electrical power systems. These are divided by the magnitude and the length of the deviation. As visible in table 2.1, there are many ways of describing variations in the power system. This glossary is based on [8] and most accordingly to IEEE standards with the exception of substantial voltage drop (3.4), which will be explained in section 3.3.

Categories	Typical duration	Voltage magnitude
1.0 Transients		
1.1 Impulsive		
1.1.1 Nanosecond	< 50 ns	
1.1.2 Microsecond	50 ns - 1ms	
1.1.3 Millisecond	> 1 ms	
1.2 Oscillatory		
1.2.1 Low frequency	0.3 - 50 ms	0 - 4 pu
1.2.2 Medium frequency	20 μ s	0 - 8 pu
1.2.3 High frequency	5 μ s	0 - 4 pu
2.0 Short-duration rms variations		
2.1 Instantaneous		
2.1.1 Sag	0.5 - 30 cycles	0.1 - 0.9 pu
2.1.2 Swell	0.5 - 30 cycles	1.1 - 1.8 pu
2.2 Momentary		
2.2.1 Interruption	0.5 cycles - 3 s	< 0.1 pu
2.2.2 Sag	30 cycles - 3 s	0.1 - 0.9 pu
2.2.3 Swell	30 cycles - 3 s	1.1 - 1.4 pu
2.3 Temporary		
2.3.1 Interruption	> 3 s - 1 min	< 0.1 pu
2.3.2 Sag	> 3 s - 1 min	0.1 - 0.9 pu
2.3.3 Swell	> 3 s - 1 min	1.1 - 1.2 pu
3.0 Long duration rms variations		
3.1 Interruption, sustained	> 1 min	0.0 pu
3.2 Undervoltages	> 1 min	0.8 - 0.9 pu
3.3 Overvoltages	> 1 min	1.1 - 1.2 pu
3.4 Substantial voltage drop	> 1 min	0.1 - 0.8 pu
4.0 Waveform distortion		
4.1 DC offset	steady state	0 - 0.1%
4.2 Harmonics	steady state	0 - 20%
4.3 Interharmonics	steady state	0 - 2%
4.4 Notching	steady state	
4.5 Noise	steady state	0 - 1%
5.0 Power frequency variations	< 10 s	+/- 0.10 Hz

Table 2.1: Classification of electromagnetic phenomena in power systems [8]

In the following, various terms for deviations from nominal values in power systems will be presented and assigned to voltage, frequency and wave form. When referring to nominal grid voltages and frequencies, 230 Volt [V] a.c. with a frequency of 50 Hertz [Hz] is assumed.

2.1.3 Voltage

1.) Sags/Swells: These two terms are referred to as so called short - duration rms variations, defined as voltage deviations less than or equal to one minute. More detailed and depending on the length of the disturbance they might be subdivided into instantaneous (0.5 - 30 cycles), momentary (30 cycles - 3s) or temporary (3s - 1 min) sags or swells [8]. When mentioning sags, a decrease in the rms voltage to between 0.1 and 0.9 per unit (pu) of the nominal voltage is meant. 1.0 pu. equals to 100% of the nominal grid voltage, hence resulting in a voltage sag moving between a 23 V and 207 V interval for when a sag occurs in a 230 Volt single phase grid system. Figure 2.1 displays a typical sag. The reason for sags often lay in system failures or the on-switching of large loads. This will obviously have a bigger impact when the system is relatively small.

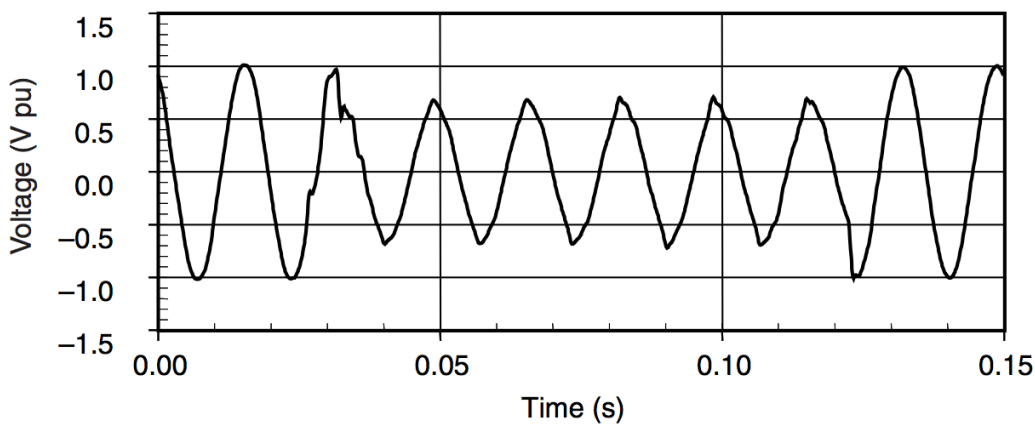

Figure 2.1: Sag [6]

Swells (see figure 2.2) on the other hand are defined as an increase in voltage level. They can range between 1.1 pu. and 1.8 pu. for instantaneous swells, thus voltage will move between 253 and 414 Volts. In contrast to sags, the magnitude of the deviation depends on the duration of the deviation, as it tends to drop the longer the duration of the disturbance is (see figure 2.1 for all details). Swells do occur more rarely compared to sags and are mostly the result of system failures. Complementary to sags, swells can emerge from switching off a large load or even from load shedding.

2.) Undervoltages/Overvoltages:

The IEEE defines undervoltages and respectively overvoltages as long-duration rms variations. These deviations will at least last longer than one minute. They appear to be similar to the previous defined sags and swells and they solely differ in duration and magnitude. Undervoltages correspond to a decrease in the rms voltage between 0.8 and 0.9 pu. That would translate to a voltage decrease ranging from 184 V to 207 V a.c., lasting longer than a minute. Undervoltages are caused by switching off a capacitor bank from or connecting a big load to the grid.

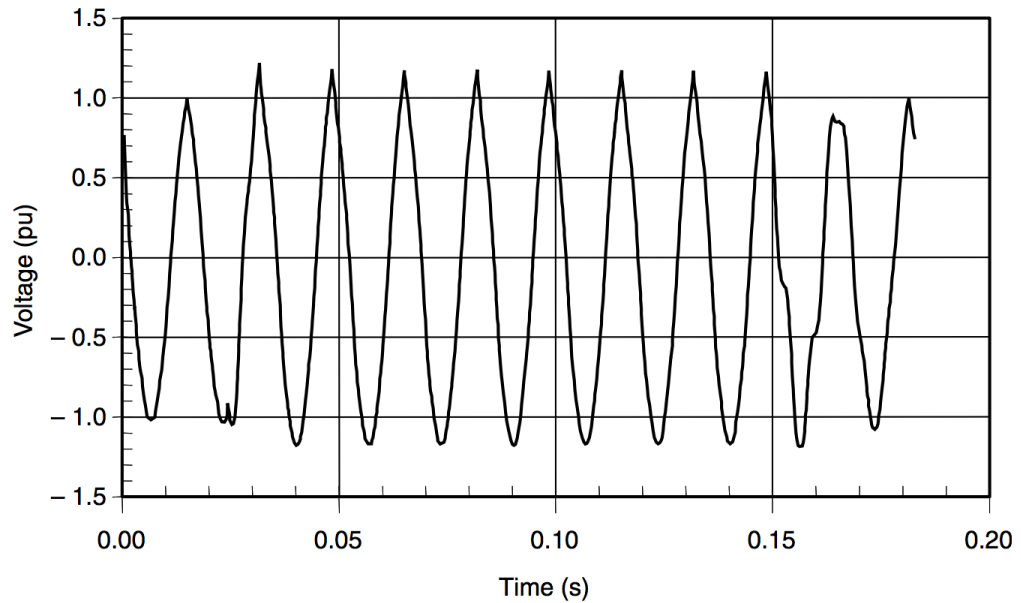

Figure 2.2: Swell [6]

In contrast to that, overvoltages are referred to as an increase in voltage level inside an interval of 1.1 pu and 1.2 pu. In relationship to the nominal voltage of 230 V a.c., that equals to a rise in voltage level between 253 to 276 Volts a.c., again lasting more than one minute. Contrary to undervoltages, overvoltages will arise when a large load is disconnected or a capacitor bank is switched on to the grid.

3.) Interruptions:

When the supply voltage drops beneath 0.1 pu (23 Volts a.c.), the voltage deviation is called interruption. Depending on the length of the disturbance, interruptions can be subclassified into three categories. These are called momentary (0.5 - 30 cycles), temporary (3s - 1 min) or sustained interruptions (> 1min). Since the duration of the first two terms is less or equal to one minute, they can be referred to as short - duration rms variations. For long-duration rms variations (sustained interruptions), voltage drops down to 0.0 pu, which results in major problems for companies/institutions/end customers etc. along the distribution network. IEEE defines the most common reasons for interruptions as power system failures, equipment failures and control malfunctions. Further, sustained interruptions are mostly caused by problems of permanent nature and need to be fixed manually.

2.1.4 Frequency

As for frequency variations, the IEEE defines the power frequency variations (see table 2.1). They are specified as an increase or decrease in frequency of 0.10 Hz appearing for a time frame of under ten seconds. As these deviations are not explained in more detail, a new set of classification is introduced in the following:

The IEEE does not cover frequency deviations in the same detail as voltage vari-

Categories	Typical duration	Frequency magnitude
1.0 Temporary interruptions	10 s - 1 min	< 0.1 pu
1.1 Sustained interruptions	> 1 min	0 pu
2.0 Overfrequency	> 1 min	1.1 - 1.2 pu
2.1 Underfrequency	> 1 min	0.8 - 0.9 pu
3.0 Temporary sag	10s - 1 min	0.1 - 0.9 pu
3.1 Temporary swell	10s - 1 min	1.1 - 1.2 pu
4.0 Substantial frequency drop	> 1 min	0.1 - 0.8
4.1 Substantial frequency peak	> 10 s	> 1.2 pu

Table 2.2: Classification of frequency deviations in power systems.

ations. Thus, a number of non existent terms will be introduced. The deviation percentage from the nominal frequency is the equivalent of the voltage deviations in table 2.1 and are summarized in 2.2. This can be viewed as a continuation of table 2.1. Sustained frequency interruptions last longer than one minute with a frequency of 0 Hz. Temporary frequency interruptions are shorter or equal to one minute with frequency below 0.1 pu which corresponds to 5 Hz. Overfrequencies and underfrequencies are deviations between 55 Hz and 60 Hz (1.1 - 1.2 pu) and respectively from 40 Hz to 45 Hz (0.8 - 0.9 pu) for more than 1 minute. Frequency sags range from 5 Hz to 45 Hz (0.1 - 0.9 pu) and swells from 55 Hz to 60 Hz (1.1 - 1.2 pu) for a duration between ten seconds and one minute.

2.1.5 Sinewave-Form

1.) Transients:

Transients occur as rapid peaks in the voltage sine wave of a power system. They are of very short duration and can be divided into two subcategories, depending on how the voltage wave form reacts to the disturbance.

The first of the two is the so called impulsive transients and is depicted in figure 2.3. These are characterized by a sudden needlelike peak in negative or positive direction. After the abrupt rise/fall of voltage it decays in a slower fashion, returning back to its original form. If the rise for instance would last 1.5 microseconds and the decay would take 50 microseconds, this can then be described as a 1.5/50 wave form transient. Depending on the duration, they are referred to as nanosecond (< 50 ns), microsecond (50 ns - 1 ms) or millisecond (> 1 ms) transients [8]. Impulsive transients usually are the result of lightning.

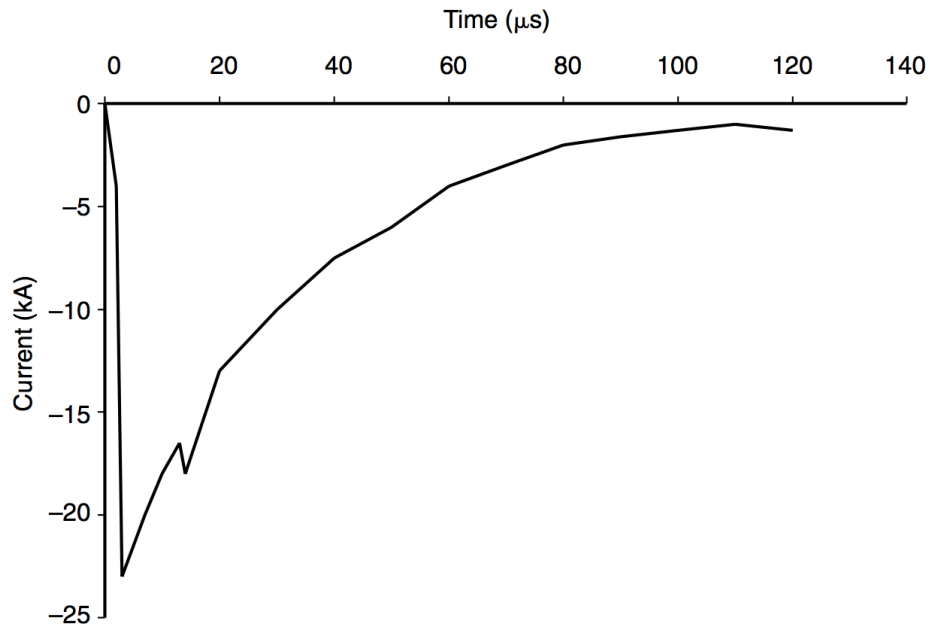

Figure 2.3: Impulsive transient [6]

The second subcategory is the oscillatory transient (see figure 2.4). Similar to the impulsive transient, a rapid peak in voltage appears in either positive or negative direction. However, as the name implies, these transients oscillate in a high frequency and gradually decrease in their magnitude until they entirely decay from the earlier sine wave before the disturbance. Just as described with impulsive ones, oscillatory transients can be sub classified depending on their duration. These are defined as low frequency (0.3 - 50 ms), medium frequency (20 μs) and high frequency (5 μs) oscillatory transients. This phenomena mostly occurs after capacitor bank energization.

The limits on voltage harmonics are thus set at 5 for THD and 3 for any single harmonic

2.) Harmonics and interharmonics:

Harmonics are sine wave formed signals with frequencies that are whole - number multiples of the nominal frequency of the power system. In the case of Germany, the fundamental wave has a frequency of 50 Hz, resulting in possible harmonics with 100, 150, 200 etc. Hz. If all of those harmonics are superimposed, a distorted sinusoidal formed wave is the result. This disturbance is also referred to as harmonic distortion and is best measured by the total harmonic distortion (THD):

$$THD = \frac{\sqrt{(V_2^2 + V_3^2 + V_4^2 + \dots + V_n^2)}}{V_1} \cdot 100\% \quad (2.1)$$

When calculating the total harmonic distortion, the rms values of the harmonic components are compared to the rms value of the fundamental of a signal. The result is a percentage, which indicates the degree of distortion by harmonics. An ideal sine wave without harmonic distortion would have no harmonic components at all,

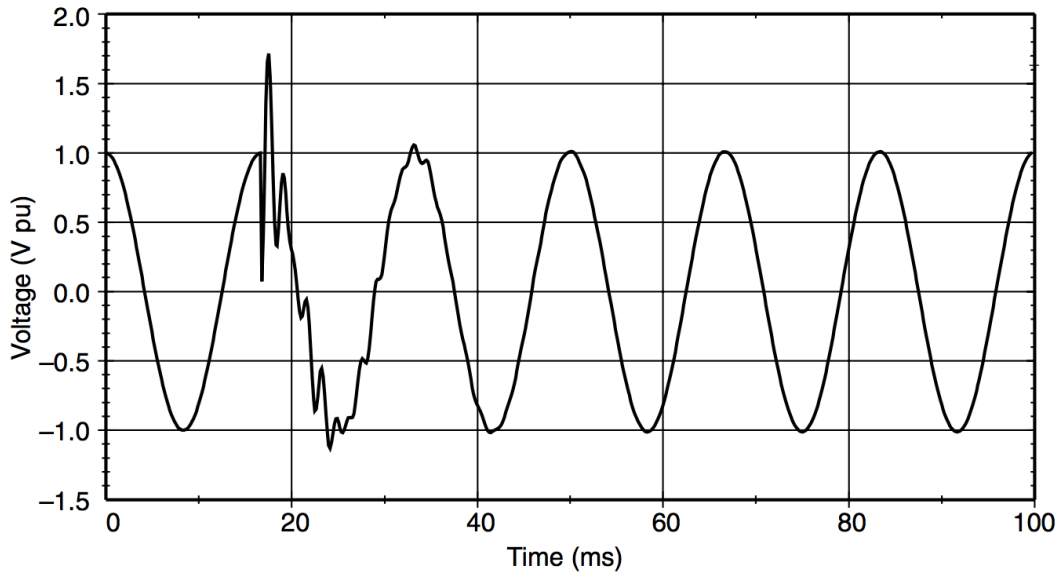

Figure 2.4: Oscillatory transient [6]

hence a THD of 0%. The THD value for power systems at 69 kV or below is restricted to 5%, according to the IEEE 519 [9]. Harmonics are mostly caused by nonlinear loads, as they impose harmonic currents into the power system, resulting in nonlinear voltage drops. The impact of this phenomenon is growing as more and more electronic appliances enter the market. For further information see SMPS in section 2.3.3.

Voltage wave components which are not whole - number multiples of the fundamental frequency are called interharmonics. They occur as discrete frequencies or as a wide-band spectrum and are caused by static frequency converters, cycloconverters, induction furnaces and arcing devices [8].

3.) Others:

There are also a few other phenomena, which can cause distortion in the wave form signal.

When a d.c. component (voltage or current) appears in the a.c. power system, it is referred to as a d.c. offset. This can be damaging to some devices connected to the power system, as additional heating in transformer components or extreme stressing of insulation material is caused. DC offsets arise from geomagnetic disturbance or as a result of half-wave rectification.

Notching is a term used to describe a periodic occurring disturbance. They appear as peaks, much like impulsive transients, in the voltage wave form and are considered a steady state phenomenon, as they repeatedly arise. Normally notching is measured by looking at the harmonic spectrum of the voltage wave. Since the frequency components of the peaks can have really high frequencies, they are sometimes hard to detect with instruments normally used for harmonic distortions. Three-phase converters producing continuous d.c. outputs are primarily responsible for notching.

Voltage signals are often disturbed by other electrical signals with other spectral frequency components. These are stated as noise and their frequencies normally move beneath 200 kHz, altering the shape of the voltage wave in a negative way. The extent of disturbance is measurable by the magnitude of the noise, which normally makes up for less than 1% of the voltage magnitude in the power system. Noise can occur because of power electronic devices, control circuits or even from switching power supplies.

As mentioned before, it is essential to keep in mind, that these parameters have a strong correlation and the allocation of the terms could easily be done otherwise. For instance a transient could be defined as a voltage - as well as a sine wave form disturbance, as it also impacts the rms voltage value.

2.1.6 Existing power quality norms in different countries

Quality norms for the consumer end of the electricity grid may differ from country to country. Table 2.3 lists the nominal voltage and frequency and the allowed deviations in percentage for some states of the world. The Australian - government owned - Essential Energy company guarantees a voltage range from 253 Volts to 225 Volts for 95% of the year when recording ten minutes average values. Further, frequency should move between 49.85 Hz and 50.15 Hz in the "normal operating frequency band" [10]. In Europe, the EN 50160 norm is valid for all members of the EU. It defines the allowed frequency deviation of 1%, meaning a frequency interval of 49.5 Hz to 50.5 Hz for 99.5% of the time. This includes, that in 44 hours of a year the interval can be widened to a range between 47 Hz and 52 Hz. For the weekly average values of the RMS voltage, the nominal value of 230 V can be exceeded or undercut by 10% (207 V to 253 V) for 95 % of the time [11]. In the Electricity Rules

Country	Australia	Europe	Nepal
Voltage [V]	+10% & -2% [10]	±10% [11]	±5% [12]
Frequency [Hz]	±0.3% [10]	±1% [11]	±2.5% [12]

Table 2.3: Power quality norms for different countries

act, the government of Nepal states that a 5% voltage and a 2.5% frequency variation from nominal values is acceptable in the public grid. That equals to a voltage interval from 218.5 V to 241.5 V and a frequency spectrum between 48.75 Hz and 51.25 Hz [12].

2.2 Fundamentals of electrical measurement

This chapter will present the physical basics of voltage and electrical current and their measurement. Further, the recording of the sine wave and frequency is introduced. Only the most common and frequently used measurement devices will be mentioned. For more detailed information on physical quantities see [7].

2.2.1 Foundations of voltage and current measurement

Voltage is the difference between two electric potentials and is measured in volts (symbol [V]). The electric potential can either be measured against a neutral grounded location or a second non-neutral electrical potential. Voltage in an electrical circuit follows Ohm's law and is equal to the product of the resistance R and the electric current I :

$$V = R \cdot I \quad (2.2)$$

The most common voltage measurement device is the digital voltmeter. By connecting the device in parallel to the desired electrical circuit, it can measure a electric potential difference without opening the circuit. After using an analog digital converter (ADC), the device shows the digital voltage value on the display. Digital voltmeters often have a high input resistance R_i , which ensures that the probe stays nearly unchanged, although the electrical circuit has been extended. Voltmeters are a standard feature of modern digital multimeters (DMM) and they are capable of measuring both d.c. and a.c. voltages. In figure 2.5 a correct voltage measurement of a electrical circuit using a DMM is displayed. The bigger the inner

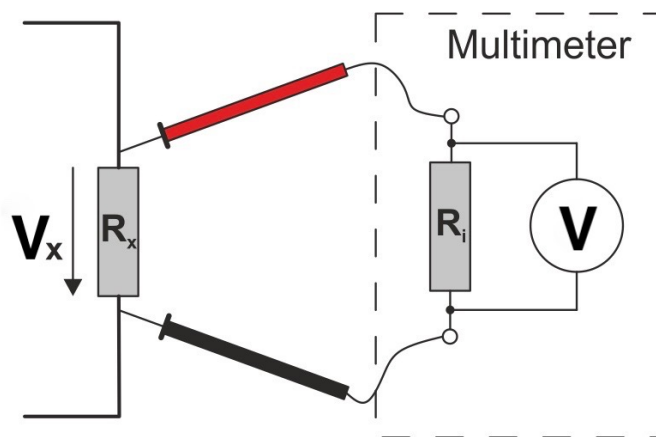

Figure 2.5: Correct voltage measurement via multimeter [13].

resistance of the multimeter, the higher the accuracy of the voltage measurement. If the resistance of the probe is near the inner resistance of the DMM, the measurements are not accurate anymore [13].

Electric current is electrical charge flowing through a conducting medium. More specific, it is the number of electrons passing by a defined point in the conductor in a certain period of time [7]. The symbol for electric current is I and it is measured in Amperes (symbol [A]). Ampere meters are devices to measure the electrical current

of a circuit. One way of displaying electrical currents is to use a DMM. In order to receive the correct values, the electrical circuit needs to be opened and the ampere meter deployed in series. Figure 2.6 shows the correct way of measuring electric current with a DMM. By deploying the device in series, the electrical current can

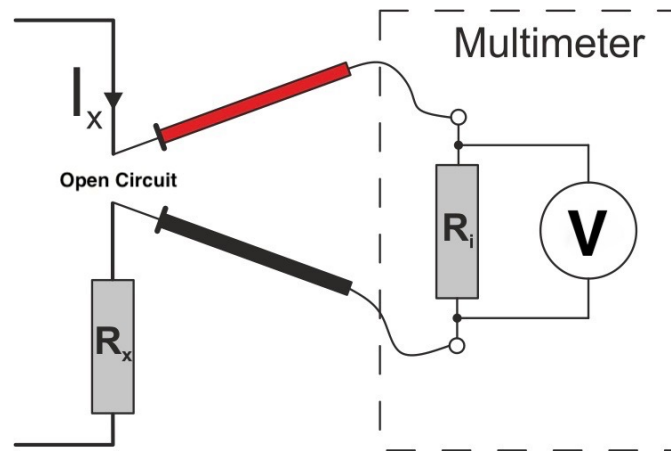

Figure 2.6: Correct electrical current measurement via multimeter [14].

flow through the low inner resistance R_i called shunt in the DMM. After measuring the voltage across the shunt and using an analog digital converter (ADC), the current can be calculated based on Ohm's law and shown on the display of the device. DMM's are capable of measuring a.c. and d.c. currents.

A different way of measuring electric currents is by using a current clamp meter. These devices are capable of measuring higher currents and enable a safe measurement, since the electric circuit does not have to be opened. A current clamp meter may be used only when measuring a.c. current [15]. As the name implies, these clamp meters work similarly to a transformer. A conductor, which mostly functions as the primary winding is positioned in between a split ring. The ring is wrapped by coils of copper and acts as the secondary winding (see figure 2.7). The alternating nature of the a.c. current in the probe will generate a changing magnetic field, which induces a current in the secondary winding. This signal often is converted into a voltage, which is dependent on the conductor current and can be interpreted and displayed on the device. For a.c. and d.c. current measurement, a

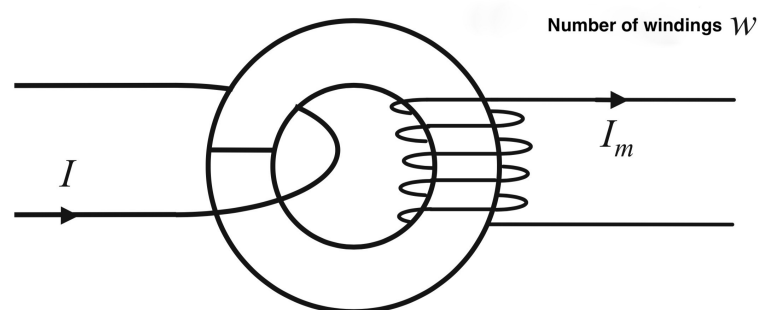

Figure 2.7: Basic principle of a current transformer clamp meter [16].

Hall effect clamp meter becomes necessary. Similar to current transformer clamp meters, Hall effect clamp meters have a split ring of iron. The ring is not wrapped by copper wires and instead focuses the magnetic field, which is induced by the conductor current in between the ring. The Hall sensor is situated in a little air gap, which will respond to changes in magnetic fields through its output voltage. This signal is dependent on the original current and can be displayed on the device after amplifying and interpreting it [17]. Figure 2.8 shows the difference between the two clamp meters by showing the profile of the split rings.

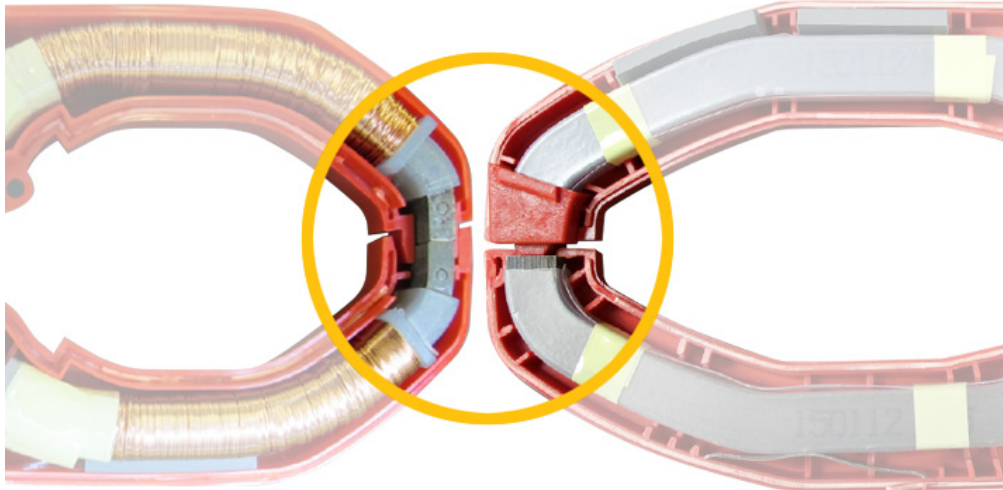

Figure 2.8: Profile of current transformer (left) and hall sensor clamp meter (right) [17].

2.2.2 Sine wave-form recording and frequency measurement

As the measurements in power systems are of alternating nature (a.c.), it becomes interesting to have a more detailed look on the run of the signal along the time axis. In order to record and analyze the waveform of a voltage or current signal, it is necessary to use an oscilloscope. These devices will show a high resolution display of the signal, including the changing magnitude along the time axis. Further, voltage and frequency are detected from that recording, essentially making up for all three power quality criteria with one measurement device. It is also possible to analyze high resolution signal disturbances like transients or harmonics in the nanoseconds region (see section 2.1.5). The devices have testing probes connected, which are either designed for voltage (test probe in figure 3.4) or current measurements (see current clamp meters) and are used for the signal input. The analog electric signal gets converted to a digital signal by an ADC, which samples the signal at a high rate. The higher the sampling rate, the higher the accuracy of the signal. Digital oscilloscopes often have a storage possibility or a pc-connection for recording and analyzing the signal [6].

Frequency is measured in cycles per second, or hertz (Hz) and is the number of events occurring in a defined time-interval. The period is the time for one cycle to be completed.

$$f = \frac{1}{T} \quad (2.3)$$

f = Frequency

T = Period

For electricity grids with a nominal frequency of 50 Hz, a period takes 20 ms and 50 cycles occur per second. As mentioned before, oscilloscopes are able to record frequency. A second option for frequency measurement is the use of a digital multimeter. The DMM is simply connected to the probe similarly to the voltage measurement. After setting the device to frequency measurement it will show the instantaneous grid frequency of the voltage signal on its display.

2.3 Classification of electrical appliances

When analyzing the behavior of electrical appliances to changes in the power system, it becomes necessary to divide them into different groups. The classification of these depends on the point of view. An electric utility might take several other criteria into account than the average electrical consumer. This thesis will mainly cover electrical loads from the consumer perspective. In that case a load is examined based on its impedance, consisting of its resistance (real part) and reactance (imaginary part).

$$Z = R + j \cdot X \quad \begin{array}{l} Z = \text{Impedance} \\ R = \text{Resistance} \\ X = \text{Reactance} \end{array} \quad (2.4)$$

In alternating current systems the overall power is divided into active (real part) and reactive power (imaginary part) and depending on what load is being investigated, the phase angle might vary between 0 and 90.

$$S = P + j \cdot Q \quad \begin{array}{l} S = \text{Apparent power} \\ P = \text{Active power} \end{array} \quad (2.5)$$

$$P = V \cdot I \cdot \cos\varphi \quad \begin{array}{l} Q = \text{Reactive power} \\ V = \text{Voltage} \end{array} \quad (2.6)$$

$$Q = V \cdot I \cdot \sin\varphi \quad \begin{array}{l} I = \text{Current} \\ \varphi = \text{Phase angle} \end{array} \quad (2.7)$$

The result of that is, that the ratio of active and reactive power might vary strongly and effectively has an impact on the so called power factor (PF), which is the result of the active power divided by the apparent power:

$$PF = \frac{P}{|S|} \quad PF = \text{Power factor} \quad (2.8)$$

If for instance the phase angle equals zero, the power factor will be 1 because the reactive power value is equal to 0 and therefore the active power is identical to the apparent power. Based on their impedance and power factor, three types of electrical appliances may be defined:

- Resistive loads
- Inductive loads (with motors)
- Electronics

Capacitive loads will only be covered as a component in electronics, because their role as a load is not significant. In the next subsections the 3 types mentioned above will be introduced based on their behavior towards changes in a.c. voltage level and its effect on the overall power consumption and the a.c. current that is being drawn from the electrical load. Further, typical values for the power factor and typical instances of the different loads will be presented.

2.3.1 Resistive

In terms of electrical behavior, resistive loads are the easiest of the three to describe since they do not comprise any capacitive or inductive components. Also, as the name implies, the impedance of resistive loads merely consist of the real part because the imaginary part (reactance) is zero. The most common resistive load is the incandescent light bulb, which generates mostly heat (90%) and only radiates light to a share of 10% of the overall consumed energy according to the U.S. department of energy [18]. In general all kinds of heating sources, such as water boilers, hot iron or toasters are of a resistive nature. These kinds of loads have in common that the electrical power is defined only through the active power equation, which can be rewritten as:

$$P = \frac{V^2}{R} \quad (2.9)$$

The reactive part of the equation equals zero (power factor = 1) and is therefore not taken into account for resistive power dissipations. When the resistance decreases, the overall power output increases for a constant voltage level. On the other hand a bigger resistance will result in less power dissipation for constant voltage. With rising voltage level, the power dissipation grows quadratically assuming the resistance stays constant and vice versa with a decrease in voltage. Referring to [7], resistive loads are the simplest of the three categories to use. The reason for that is that they tolerate big deviations in terms of voltage level and frequency. When applying really high voltages the components of the electrical circuits are in danger of irreversible failure. To put that in perspective of the classic light bulb, the coiled filament would burn out and consequently open the circuit. Resistive loads seem to be forgiving to changes in the wave form as long as the area beneath the trajectory stays almost the same overall. That means that if a curve will not look like a perfectly smooth sine but rather scraggy, it does not matter as long as the average area (rms) remains more or less the same.

$$I = \frac{V}{R} \quad (2.10)$$

As these loads follow Ohm's law, the effect of a voltage drop is a decline in current [19]. Likewise, a rise in voltage level will make the electrical appliance draw more current from the grid.

2.3.2 Inductive (with motor)

Inductive loads do not have to be devices that include a motor, but the majority of such loads have one. In the United States induction motors are the leading technology with about 90 % of the energy consumption as opposed to synchronous and d.c. motors [7]. Hence they define the second type of the electrical loads. Typical instances of these loads are motor driven fans, air conditioners or refrigerators. But also fluorescent lights and transformers are of an inductive nature. In general induction means that a device has some kind of coil implemented and as the current that flows through the windings changes (alternating current) an electromagnetic force is induced. The correlation between voltage, self-inductance and current is:

$$V = L \cdot \frac{dI}{dt} \qquad L = \text{Self-Inductance} \qquad (2.11)$$

As shown in the formula above the current is now dependent on time, which is the reason for a shift in the phase angle. Therefore all purely inductive systems have in common that the a.c. voltage will lead the ac-current in phase. Inductive appliances can have a power factor between 0 and 1. Meaning that unlike resistive loads, devices of this type can have reactive as well as active power parts. Depending on the type of device, the load may have a fixed operating voltage range, which should be respected similarly to the resistive loads to prevent damaging of electric components. For instance very high voltages will produce high temperatures in the coils, resulting in losses in the motor. When raising the voltage level, a high current will occur when the device is started and gradually decrease until a steady state is achieved. For lower voltages, the induction motor either will not start in the first place, or it will draw higher currents to compensate the missing voltage rms value. As mentioned before, these can damage the motors and should for instance be avoided through some kind of voltage stabilizer [20]. Power consumption will decrease at lower voltage and increase at higher voltage level. For some heating or cooling devices however, depending on how big the load is, efficiency will improve with rising/falling voltage until the rated voltage of the apparatus is reached. When looking at the sine wave form, inductive loads are not as forgiving to aberrations as the resistive ones. This becomes clearer when considering that the voltage supply of a motor is designed to have a mathematical sine wave voltage as input. Changing the wave form will result in a loss in efficiency, as it will lead to higher winding copper losses and therefore a dissipation in heat and additional stress for the machine, which can shorten the life expectancy of the device [7].

2.3.3 Electronics and switched mode power supply

Electronics are loads powered by d.c. voltages [7]. They either have components to alter the a.c. voltage to d.c. hidden in the device itself or in form of a charging device. A basic signal transformation would be that the a.c. grid-voltage is transformed to a lower voltage, rectified and smoothed by capacitors to get a straightened d.c. output for the appliance. These loads are not the biggest power consumers themselves, but in the great number they are represented all over the world they make up for a significant part in electrical loads. Examples for electronics would be power supplies for laptops, PCs, smartphones and basically all kinds of battery chargers and adapters. Unlike resistive loads or inductive motors, the end-appliances that are being powered are not built for heating, cooling or radiating light, but to transfer information or charge devices. That can be accomplished with small currents, resulting in lower power consumption compared to the two prior introduced types of loads. More and more electronic devices comprise a so-called switch mode power supply (SMPS). These devices use very high frequency switching and small transformers. Further, through high frequency, more efficiency is achieved, hence less heat is dissipated. The result is that electronics with SMPS can be designed significantly smaller than linear supplies with the same power output [21]. Switch mode power supplies react intelligently to changes in voltage level. When applying a higher voltage than the rated voltage, the average a.c. current consumption will decrease. On the other hand, less voltage will be compensated by a higher average current. These phenomena are based on the urge of the SMPS to keep a constant power consumption and most importantly a constant voltage output [19]. The output voltage is being regulated by a feedback control loop which compares it to a reference voltage and reacts to deviations. Frequency deviations from the nominal value are tolerated by SMPS as well as non mathematical ideal sine wave forms. That is, because the input signal to the SMPS is filtered by a rectifier and capacitor in series, changing the input signal to a constant d.c. signal before sending it to the high frequency d.c. to d.c. converter.

2.4 Power consumption in Nepal

This section will start off with an introduction to the developing country Nepal, which covers geographical and economic facts amongst other things like recent political incidents. Further, numbers and figures of the energy sector over the last decades are introduced. Ensuing, a questionnaire conducted in 2017 is presented, which gives an insight on the most commonly used electrical appliances in Nepal.

2.4.1 Facts and figures

General facts:

Nepal is a landlocked south-asian and Himalayan state. The developing country is bordered by China in the north and by India in the east, west and south. According to the World Bank, the total population has had a linear rising trend (figure 2.10) and equaled to 28.98 million people in 2016 [3]. The country is on average 885 km long from east to west and 193 km wide from north to south and the surface area amounts to 147,2 km^2 . From a geographical standpoint, Nepal is divided into three



Figure 2.9: Map of Nepal.

regions, which are arranged in vertical fashion: The mountain region in the north, which is the home of the worlds highest peaks, including the Mount Everest at 8848 meters above sea level. Only about 6.7% of the country's population live there, says a in 2011 conducted census [22]. South of the mountainous region, the Hill region is situated. The capital city Kathmandu and the second biggest city Pokhara can be found there and around 43.1% of the population lived there in 2011. Even more south, the Terai region lies, making up for the remaining 50.2 % of the population in 2011. This is the lowest situated region in Nepal and has the most fertile land in the country, thus most of the crop growing plants can be located in the Terai region.

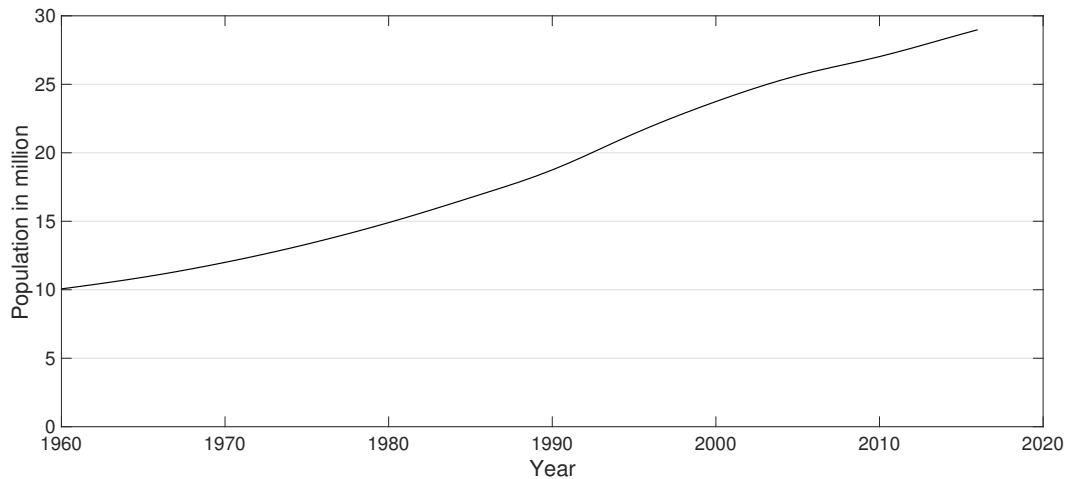

Figure 2.10: Nepals population growth from 1960 to 2016 [3].

Various languages like Maithili, Bhojpuri and Tharu are spoken in Nepal, however the national language is Nepali. The country is home of several religious groups: Based on the 2011 conducted population census, 81.34 % of the population are of Hindu belief, followed by 9.04% Buddhism, 4.39% Islam and others [23].

The gross domestic product (GDP) of Nepal in 2016 was 21.1 billion US\$. Figure 2.11 illustrates the development of the GDP over the past decades. Since 1960 the life expectancy has almost doubled to 69.87 years for a newborn to live [3]. These statistics certainly have a positive trend, but the Himalayan state still ranks on 144th place of 188 in the Human Development Index (HDI) with a HDI Index of 0.558, which is below the 0.710 world average [1]. Besides economic growth, the HDI takes other indicators like life expectancy and education into account.

Further the United Nations have declared Nepal as one of the 47 least developed countries (LDC) [24]. It has been on the LDC list since 1971 and the UN defines LDCs as "low-income countries confronting severe structural impediments to sustainable development. They are highly vulnerable to economic and environmental shocks and have low levels of human assets" [25].

Earthquake and political change:

On April 25th 2015 Nepal was hit by an earthquake of 7.8 magnitude. The epicenter was located between the capital city Kathmandu and Pokhara and almost 9,000 civilians lost their lives that day and in the course of many following earthquakes, including one of 7.3 magnitude on 12th of May. One year after the tragic incident, BBC stated that almost none of the 800,000 buildings destroyed in the natural disaster, have been rebuilt and 4 million people were still living in temporary shelters [26]. After a ten year civil war and political instability, manifested in ten different prime ministers in eleven years, Nepal was declared a federal democratic republic with seven states in the 2015 constitution. In November and December of 2017 provincial and legislative elections were held to elect 550 seats for the seven newly created provincial assemblies and the 275 members of the house of representatives. In contrast to the last decade, many hope for more stability from the new built government [27].

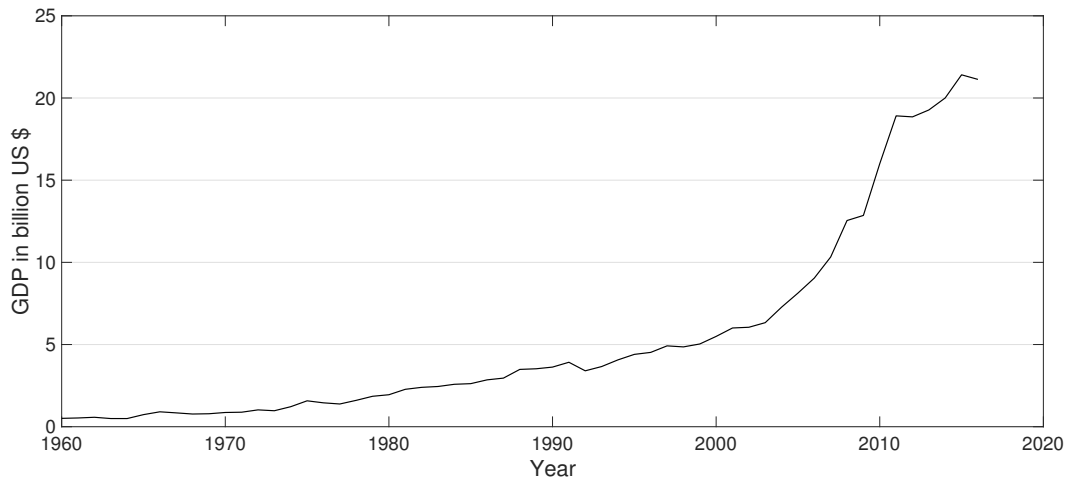

Figure 2.11: Development of Nepal's GDP from 1960 to 2016 [3].

Energy situation:

Figure 2.12 shows the breakdown of the total primary energy supply (TPES) in 2015, which summed up to 11691 ktoe in total. It can be derived that biofuels and waste make up for 82.6% of the TPES and are therefore the main energy supply in the country. Although Nepal has a big natural water reservoir for hydro energy generation, it only covers 2.6% of the TPES. Oil and Coal with 10% and 4.8% complete the chart [28].

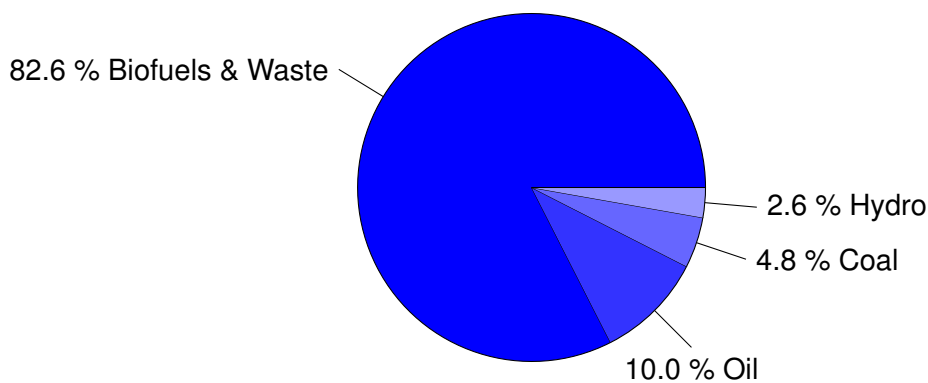

Figure 2.12: Share of primary energy supply sources after IEA [28].

The total primary energy consumption divided on the main consuming sectors (see figure 2.13) shows that the residential sector is the main consumer in Nepal from 1995 to 2015. The International Energy Agency states that energy consumption of Nepal's industrial sector amounted to 6.32% of the total energy consumption in 2015. Compared to 25.1% of a first world country like Germany, that could be one of the reasons for Nepal's slow economic growth.

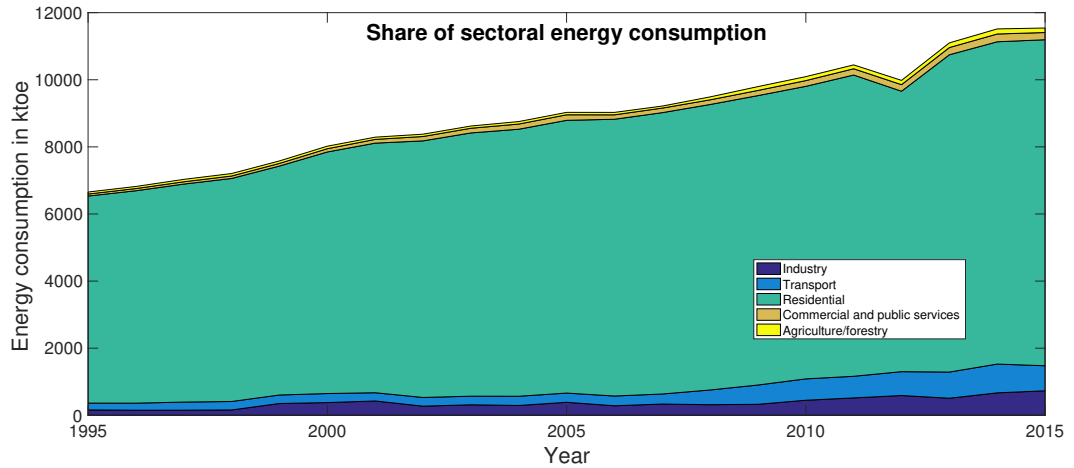

Figure 2.13: Share of primary energy consumption from 1995 to 2015 in Nepal [28].

Electricity:

Electricity consumption has more than quadrupled since 1995 [28], however according to Nepal Electricity Authority’s (NEA) annual report 2017, only around 65% of the population have access to national grid electricity [29]. The NEA is responsible for electricity generation, transmission and distribution in Nepal’s power system [30]. Most of the NEA’s electrical power plants are hydro power plants and they combine to a overall capacity of 477.93 MW. Adding the NEA’s thermal and solar power plants and the hydropower plants from independent power producers (IPP) a total power capacity of 972.49 MW is installed for the NEA to access in Nepal. The already mentioned earthquake from April 2015 caused massive delays in the construction of new power plants and many completion dates had to be postponed. These have mostly resumed and are currently under construction, including the upper Tamakoshi Hydropower Project (456 MW), which should start generation in December 2018, which would extend the overall installed capacity as of now, by 50% [29].

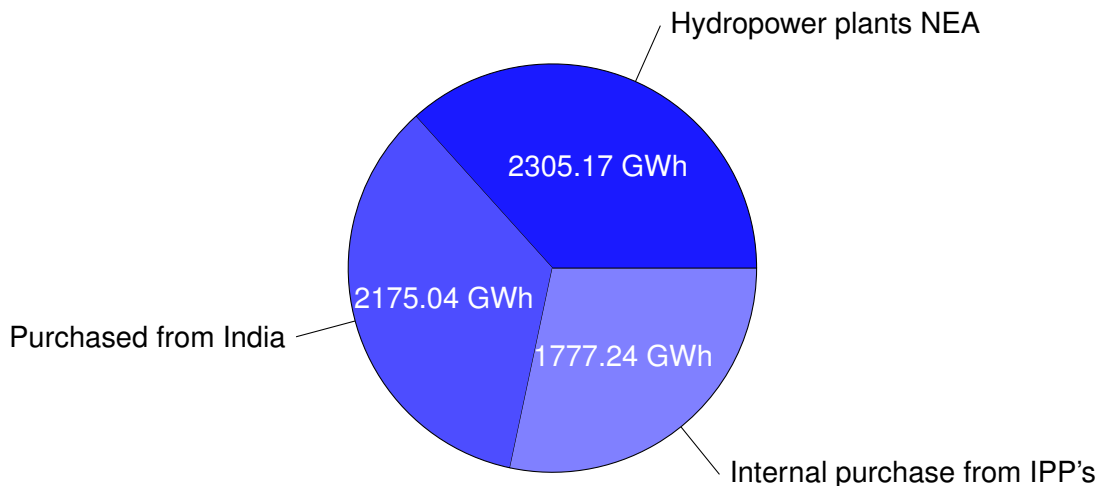

Figure 2.14: Sources of available energy in Nepal's electricity grid [29].

The sources of the overall available energy in Nepal are illustrated in figure 2.14. In total, 6,257.73 GWh energy was available in 2017, with 36.84% of it being produced by NEA's power plants. Besides purchasing 28.4 % from IPP's, the remaining 34.76 % were imported from India. In conclusion, the NEA paid for 63.16% of the available energy in 2017. In their annual report of 2017, the NEA further claims to have made the main load centers (mostly urban areas) load shedding free.

2.4.2 Status quo of power quality in Nepal

There is an existing lack for power quality data in Nepal. The only previous work found in research is a publication by the South Asia Regional Initiative for Energy (SARI) from 2003 [31]. It examines the financial impact of poor power quality on the Industry of Nepal. It was found out that the financial losses for unplanned interruptions were 3.5 times higher than those from planned interruptions. Further, the frequency of unplanned interruptions added up to almost one occurring in every two days (185.37 per year) and lasting for about 1.5 hours in average. Planned interruptions (22.51 times per year) only emerged around two times in one month, lasting 2.08 hours in average. Voltage variations, meaning a deviation of $\pm 10\%$ at transmission line (33 kV) occurred 111.93 in one year for 2.2 hours in average for all examined locations [31]. As these voltage variations have no time interval or more specific deviation range, they can not be compared to the introduced electromagnetic phenomena by the IEEE in section sec:2.1.2. The interruptions however can be compared to the data which will be recorded in Nepal.

2.4.3 Commonly used appliances in Nepal (from questionnaire)

In [32], a total of 90 different households in three different off grid locations in Nepal were surveyed about their energy consumption and typical used electrical appliances. The results are dependent on socio - economic factors like education and wealth. It was found that electricity is mostly used for lighting and entertainment appliances, however cooking is still dependent on firewood or fuels. 64% of all households use LED lamps and 39% employ CFL lamps, whereas only 34% of all households are using incandescent lightbulbs. In total 97% of the households have any of the introduced lighting sources. 66% of every household own a TV, which mostly is based on CRT technology. Only 10% own a rice cooker, however 84% desire one and there is an increasing trend for electric cooking devices. It was found out that the purchase of a rice cooker is not held back by financial background, but rather by the high power consumption of the devices, which can have a bad impact on the voltage quality of the supplying power system. The selection of electrical appliances in chapter 4, are based on the gathered data of this survey. Further, additional electric loads like mobile chargers or water cookers will be taken into account.

Chapter 3

On-site measurements of power quality

3.1 Equipment

This Chapter will shortly introduce all kinds of measurement devices used for the recording of voltage, frequency and sine wave form.

3.1.1 Datalogger

Scantronik

This data logging setup is the product of the german company Scantronik Mugaer GmbH and consists of 2 devices:

1. Netz - Analysator:

The Netz - Analysator is directly plugged into the electrical outlet and was made for the analysis of the European grid voltage. The apparatus converts the grid signal to a d.c. voltage between 0 V and 2 V. Deviations from the nominal voltage of 230 V a.c. can be recorded with up to 2000Hz sampling rate. The Netz - Analysator does not need a power supply to function, as it only converts the incoming signals.

2. Voltfox Maxi:

As a storage and logging device, the Voltfox Maxi is connected to the Netz - Analysator. It is equipped with a 12-Bit A/D-Converter, a real time clock (RTC) module and storage for up to 64.000 values. Powered by an integrated lithium-battery, the Voltfox Maxi has a battery life of up to two years, depending on usage mode and configuration. This enables a longtime and high resolution recording of values. The Voltfox Maxi is able to record voltages and currents, however in combination with the Netz - Analysator only voltage measurements are possible.

The configuration of the time interval between two recordings, start and end time of the measurements and even the setting of the internal clock are done over the Soft-Fox - analyzing software on a PC. Besides that, the program features possibilities for graphical analysis and exporting data to Microsoft Excel.



Figure 3.1: Netzanalysator and Voltfox. [own illustration]

Selfmade Arduino datalogger

In an earlier conducted 3-month internship under the supervision of Stephan Baur and Anna Seppälä at the Chair of Renewable and Sustainable Energy Systems from the Technical University of Munich, a datalogger was built from scratch based on an Arduino micro-controller. The device is able to measure the grid frequency and voltage directly out of an electricity outlet. The values are marked with a timestamp in a defined time interval and then stored to a CSV file on a SD-Card. Three major steps were performed to build the datalogger:

1. Signal transformation:

When measuring frequency and voltage simultaneously it is important to have as little interference as possible between those recordings. This is achieved by splitting the cable from the electrical outlet into two independent circuitries. For voltage measurement the 230 V a.c. voltage signal is transformed into a lower voltage, then rectified and smoothed out by using a capacitor. Finally, the voltage signal is brought down to a lower value, using a voltage divider. The frequency measurement also starts with transforming the grid voltage to a lower level. After a voltage divider, a simple diode is used to only let the positive half-wave of the sine signal pass. The result is a sine wave type signal except the negative part, which could damage further components in the micro-controller.

2. Arduino Uno:

After the grid signal is transformed and altered, the next step is to connect it to the micro controller. As this device could be rebuilt in developing countries for further grid stability assessment, the best solution is the Arduino Uno. This device is the most used one in Arduino's product portfolio, resulting in a good documentation. Additionally it has the lowest price of them. It is equipped

with 6 analog and 14 digital input pins, is running on an ATMEL processor (ATmega328P) with 16 MHz- clock rate and includes an internal 2 KB SRAM storage. In order to improve the time accuracy, a stacking shield (data logging shield V1.0 by Deek Robot) is connected on top of the Arduino. This shield provides more accuracy in time, as well as a SD-card slot for more storage capacity.

3. Signal processing:

The last and most important step is the signal processing. The source code is written on the Arduino IDE (Version 1.8.2). The language is based on C/C++ and the code is compiled using the avr-gcc compiler. For voltage measurement, the internal voltage reference is used to compare it to the input signal. The micro-controller measures 2000 voltage signals and finally computes the average value. After that, the signal is run through a calibration function. The frequency measurement is done by an algorithm, which stops the time for exactly one period. Computing the inverse of that time measurement, delivers the frequency. The algorithm reads the input pin of the Arduino on a very high clock-rate and uses virtual flags to determine whether a period has gone by or not. To get a more reliable outcome, the average value over 100 periods is computed. Voltage and frequency values are now written down to a CSV-file on the SD-card. Further, a timestamp for each measurement is written to the file. The time interval for recording is set to ten seconds but can be adjusted in the source code if needed.

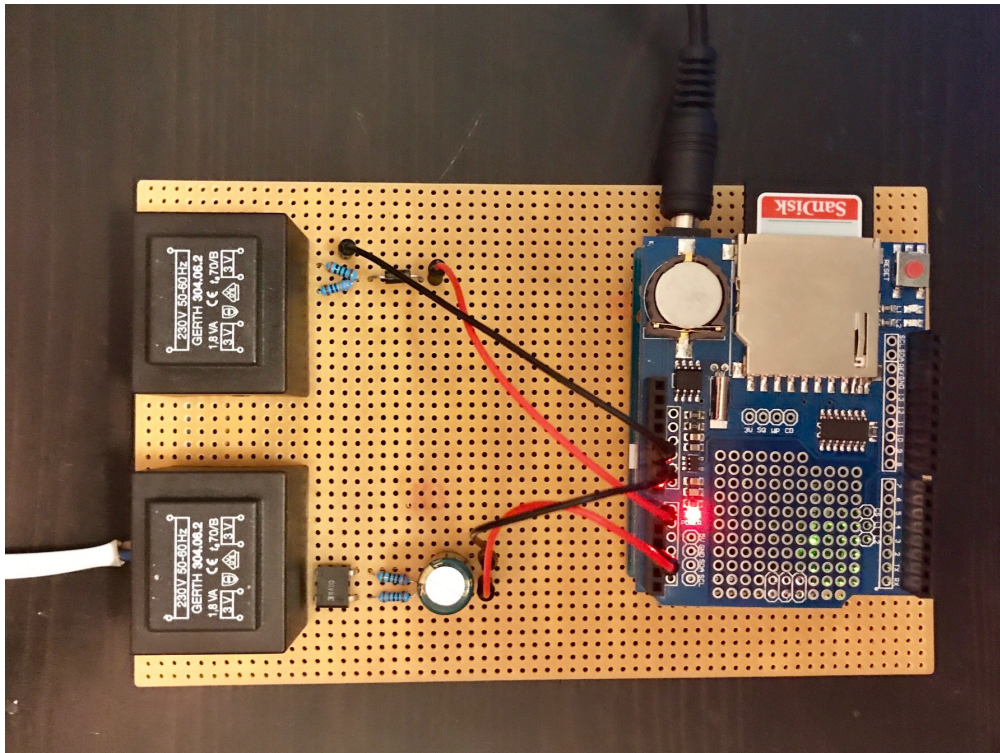

Figure 3.2: Stacking shield of the Arduino on the circuit board of the self-built data-logger. [own illustration]

The total cost for the components of the data-logger is around 50€, making it a low price alternative to existing high end data-loggers. The power supply for the Arduino is provided by an a.c./d.c. converter. To make this system independent in terms of power supply, a chargeable battery could substitute the existing supply. An implementation for island grids could be realized by a lead acid battery being charged by a photovoltaic module.

3.1.2 Multimeter

As mentioned in 2.2 one of the most common and simplest ways of measuring electrical signals is using a multimeter. As for accuracy, the price for such a device can play a big role and the quality of these can vary strongly among different developers. For this master thesis two devices were chosen:

UNI-T UT61B:

The UT 61B from UNI-T is a digital multimeter for various measurements like a.c. and d.c. voltage and current measurements. Further the device is capable of recording frequency, resistance and capacitance. Besides temperature measurement, the UT61B is able to execute diode and continuity tests. The device offers services like the hold-function, automatic or manual measurement range and max/min storage. The power supply is ensured by a 9 V battery and the multimeter features a backlit LCD Display. The optical USB-interface on the upper part of the backside enables serial data transfer to a PC. In the UT61B interface software, values are stored with a timestamp in the chosen sampling interval and can be exported as Microsoft Excel files [33].



Figure 3.3: Voltcraft VC 820-1 (left) and UNI-T UT61B (right) [own illustration].

Voltcraft VC 820-1:

Similar to the UT61B, the digital multimeter VC 820-1 from Voltcraft is capable of measuring a.c. and d.c. voltages and currents. Moreover, the device enables capacitance, resistance and frequency recording. Further, the hold-function, auto range measuring, diode and acoustical continuity tests are possible with the VC 820-1. The power supply is guaranteed through a 9 V battery and the values can be read off a LCD-Display. By connecting a optical serial interface to the upper part of the devices backside, a connection to PC becomes possible. The VC820-1 interface software records the desired measurand in the configured sampling interval and attaches a timestamp. Further, exports to Microsoft Excel are possible [34].

3.1.3 Oscilloscope

The Peaktech 1220 is a handheld digital oscilloscope and true rms multimeter at the same time. The digital multimeter is capable of recording a.c. and d.c. voltage and current, as well as resistance and capacitance. As for the oscilloscope, the device has one input channel, a sampling rate of 100 MS/s and a bandwidth of 20 MHz. Further it features alternative trigger functions, auto range adjustment and has a small internal storage capacity. It has a 3.8" backlit TFT-color display and runs on an accumulator. If needed, the power can also be supplied through an a.c./d.c converter directly connected to the grid. The data can be transferred to a PC via USB interface. The delivered software GUI enables recording and storage of the sine wave form in the desired time interval with the corresponding timestamp, frequency and peak to peak voltage. The maximum input for a.c. voltage input is around 40 V peak to peak. Therefore a test probe with 1:100 ratio is necessary to display the nominal grid voltage signal.



Figure 3.4: Peaktech 1220 oscilloscope [own illustration].

3.2 Locations

This chapter will introduce the different measurement locations. As for on grid, the recordings in Germany were conducted in the inner city part of Munich called Maxvorstadt. The measurements in the public grid of Nepal were performed in Kathmandu, more specific the inner city part of Thamel. When examining the off grid locations of Nepal, a more detailed presentation is conducted, because both places are situated in the mountains and depend on one hydro power plant only. A change in demand can therefore have a harsh impact on power quality, as there are almost no ways of controlling the power system or reacting to problems (for instance via energy storage). Both off grid locations are placed in the Manang district.



Figure 3.5: Map showing the measurement locations (red) and the three hydro power plants (orange) of the Manang valley. [35]

The first recording was conducted at the Lophelling Boarding School (LBS), near the city of Humde, which is situated on around 3350 meters above sea level. The Tibetan school is funded by the Snow Line Foundation and gets supported by the german foundation Nepal Initiative [36]. The school and various other villages in the region like Braga, Pisang and Manang get supplied by the so called Sabje Power Station (SPS). There is a second hydro power plant near the city of Manang, located further west than LBS. This plant was financed by private investors, who sell the power to the residents of the city only as the power stations are not connected to the same electricity grid. As a result, two independent energy supplies are available in most facilities of Manang, making it more flexible to react to system failures in one of the power plants. The second measurement location is Chame. The village is situated on 2650 meters above sea level along the Marsyangdi river. Power supply is ensured by the Chame Power Station (CPS), which is only responsible for the city itself.

The following figures and tables show pictures of the hydro power plants and list some of their key design parameters. The data was originally gathered through expert interviews conducted by Johannes Eisner during his semester thesis at the Technical University of Munich [37].

Table 3.1: Key parameters of Sabje Power Station

Power capacity	80 kW
Flow-rate	380 l/s
Nett head	35 m
Turbine	2 crossflow turbines by Thapa Engineering Industries (P) Ltd., Nepal
Generator	3 phase a.c. synchronous generator by Kerala Electrical and Allied Engineering Co.Ltd., India



Figure 3.6: Sabje power station and penstock [own illustration]

Table 3.2: Key parameters of Chame Power Station

Power capacity	45 kW
Flow-rate	180 l/s
Nett head	59.3 m
Turbine	crossflow turbine by Thapa Engineering Industries (P) Ltd., Nepal
Generator	3 phase a.c. synchronous generator by BHEL Electrical Machines Ltd., India



Figure 3.7: Chame power station and penstock [own illustration]

3.3 Results and discussion

This thesis will mainly cover long-time measurements of voltage and frequency. This is based on the assumption that developing countries are still struggling to uphold a reliable electrical grid and it is the main priority to minimize the number and duration of interruptions and voltage drops. Therefore only temporary deviations starting at 10 seconds will be considered. As for the sine wave-form, short time deviations and harmonics are of bigger interest, as they influence the form of the sine wave.

The following disturbances for voltage deviations will be covered: Sustained and temporary interruptions are probably the most known disturbances from the average consumer perspective. Further, over- and undervoltages will be assessed. Temporary swells and sags will also be detected. For more detailed description see table 2.1). As some of the deviations were too strong to be identified by the electromagnetic phenomena in section 2.1.2, an additional parameter called substantial voltage drop will be introduced. It covers deviations longer than one minute from 23 V to 184 V (0.1 pu to 0.8 pu).

For frequency analysis, all of the parameters introduced in 2.1.4 will be applied. Similar to voltage analysis, some of the deviations for frequency were too high to be classified by the IEEE electromagnetic phenomena. Thus, two additional terms will be introduced. A substantial frequency drop equals to a range from 5 Hz to 40 Hz (0.1 - 0.8 pu) for a duration of more than one minute. A substantial frequency rise comprises all frequencies above 60 Hz starting from 10 seconds. All of these newly introduced parameters are summarized in table 2.2.

Sine wave assessment will be done by visually comparing the deviation from the real power system output to a mathematical ideal sine wave signal with the magnitude of a 230 V rms voltage and 50 Hz frequency.

After showing an overview of the seven day measurements for frequency and voltage, both parameters will be analyzed for one day in more detail, using the power quality criteria introduced above. Finally a representative sine-wave recording and analysis of the respective locations will be presented. As this chapter features many plots, different colors for voltage (black) and frequency (blue) will persistently be applied. This should provide more clarity in the representation of both parameters.

3.3.1 Validation of self built datalogger

Besides gathering significant and non-existent power quality data in Nepal, an additional task was to test the self built datalogger (see 3.1.1) in the field under varying power quality criteria. Figure 3.8 and 3.9 show the voltage and frequency measurements from the data-logger compared to multimeter recordings in Kathmandu. The

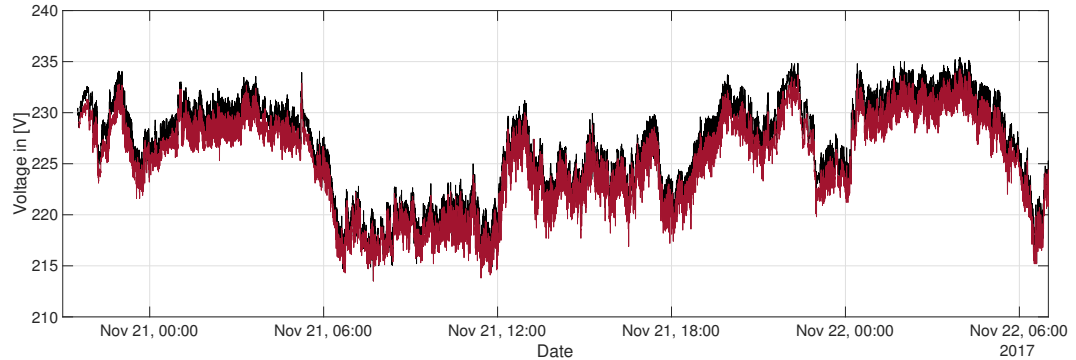

Figure 3.8: Voltage recording from data-logger (black) and multimeter (red) [own illustration].

two plots indicate a clear correlation between the recordings of the Arduino and the multimeter devices. The measurements were conducted every 10 seconds, hence the values are seldom recorded at the exact same time and can therefore vary slightly. Further, in figure 3.8 a small offset (approximately 1 V) can be seen, which is caused by a difference in the device calibration. As the correlation has been

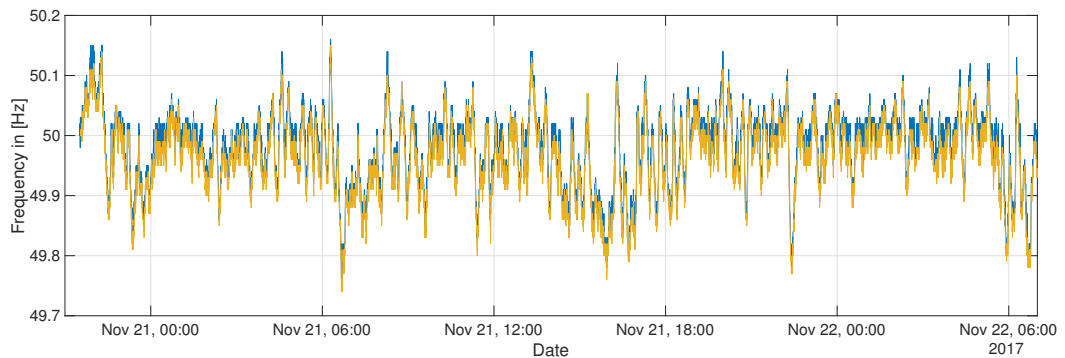

Figure 3.9: Frequency recording from data-logger (blue) and multimeter (yellow) [own illustration].

shown, the data in the following sections will be based on the self-built data-logger. The main focus of these measurements where to record trends in the stability of voltage and frequency level, which is guaranteed by both measurement alternatives.

3.3.2 On grid

This section covers all on grid power quality measurements, including recordings from Munich, Kathmandu and Pokhara.

Munich

Figure 3.10 displays the voltage trend from February 10th to 17th recorded in Munich. The Voltage trend looks stable, staying within a range of 12 V (226 V to 238

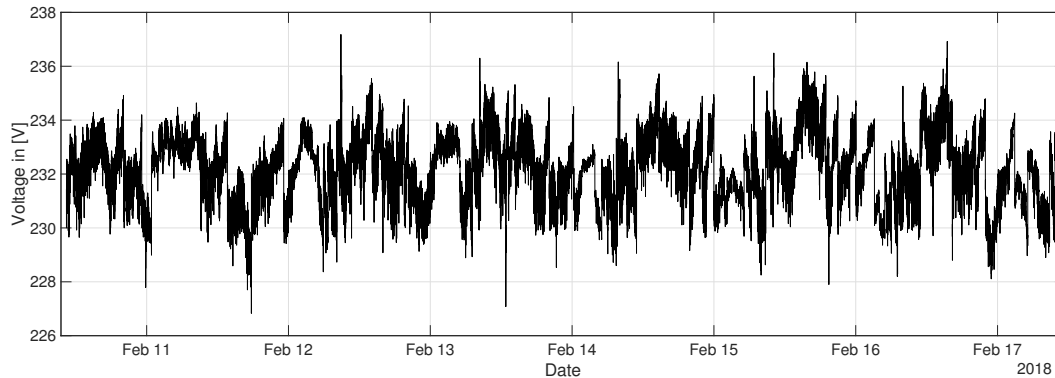

Figure 3.10: One week voltage recording from Munich [own illustration].

V) over the whole week. Further, no interruptions in power supply were detected. The matching frequency measurement is illustrated in Figure 3.11. Again, it is no-

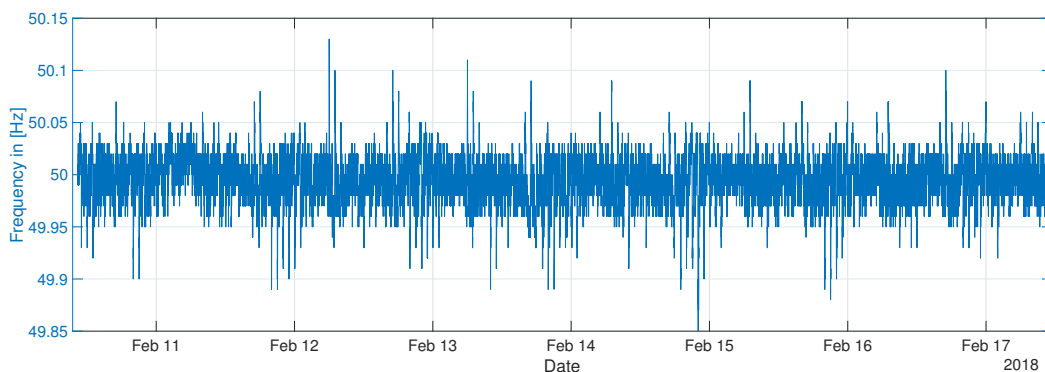

Figure 3.11: One week frequency recording from Munich [own illustration].

ticeable that the frequency looks extremely stable around the nominal frequency of 50 Hz. It moves within a 0.30 Hz interval along the course of the recording. Further, the highest share of values seem to stay within ± 0.05 Hz of the nominal frequency, which is a clear indicator for good power quality. For a more detailed look, the time-axis is narrowed down to a one day measurement in figure 3.12. The data from February 13th is now analyzed, based on the electromagnetic phenomena introduced in section 2.1.2. The results of that analysis is presented in table 3.3. No noticeable deviations from nominal voltage or frequency occurred over the measurement in Munich, which results in a good power quality. The statistical analysis of the weekly probabilities of frequency and voltage values is illustrated in 3.13.

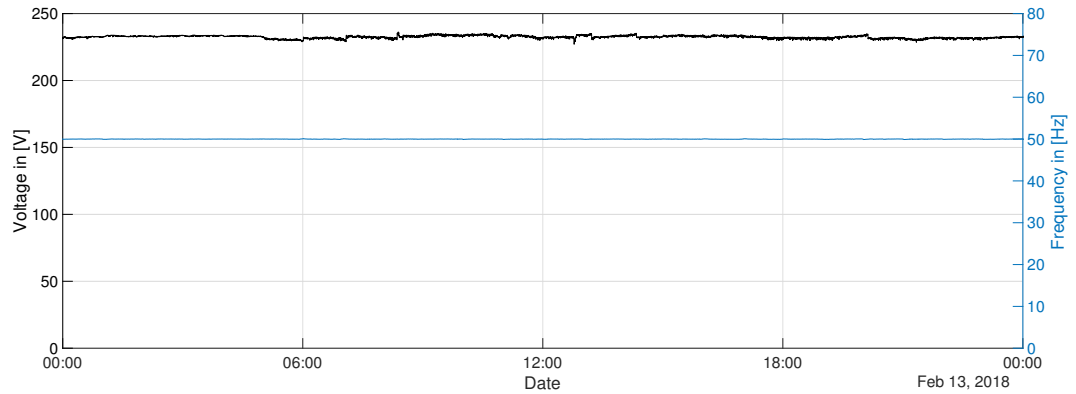

Figure 3.12: One day recording of voltage (black) and frequency (blue) from Munich [own illustration].

Voltage sags	Voltage swells	Under-voltages	Over-voltages	Temp. interruptions	Sust. interruptions	Substantial voltage drops
0	0	0	0	0	0	0

Table 3.3: Voltage quality indices for February 13th-measurement in Munich.

The expected value for frequency is 49.98 with a sigma value of 0.02. This means

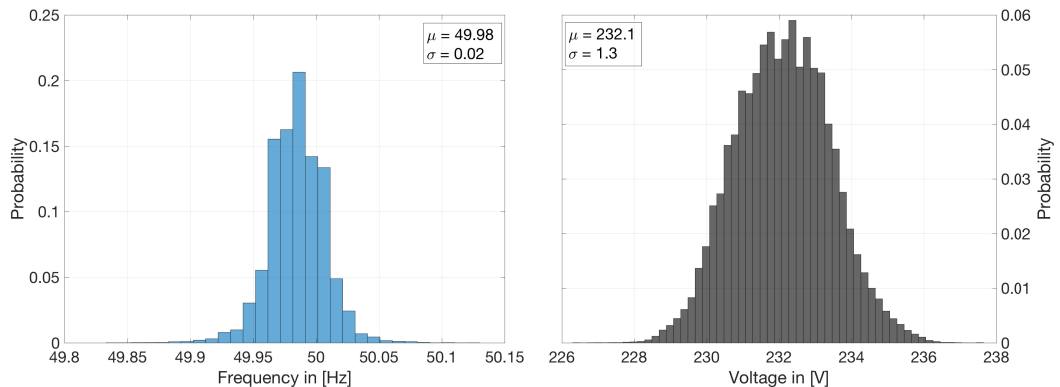

Figure 3.13: Weekly probability of frequency and voltage values in Munich [own illustration].

that after applying the 2σ -rule, between 49.94 Hz and 50.02 Hz over 95% of all values are concentrated. This is a sign for good power quality. When analyzing voltage, the expected value equals to 232.1 V with a sigma value 1.3. This corresponds to a 2.1 V deviation or 0.9% of the nominal voltage (230V). After applying the 2σ -rule ($2\sigma = 2.6$), over 95% of all values over the one week recording move in between 229.5 V and 234.7 V. Figure 3.14 displays the recorded sine wave form for Munich. The magnitude of the signal is slightly above the ideal voltage signal for most of the time, which indicates a higher rms voltage than 230 V. The zero crossings as indicator for frequency align perfectly with the 50 Hz mathematical plot. However, clear indications of harmonic distortions become visible because

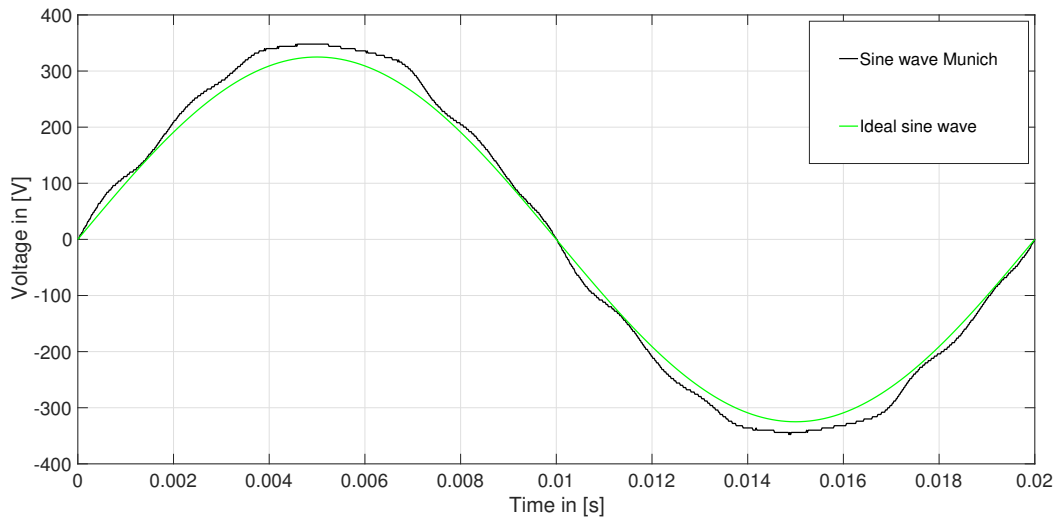

Figure 3.14: Sine wave recorded in Munich and ideal sine wave for comparison.

the voltage signal is not as smooth as the ideal sine wave and it shows oscillations of higher harmonic order within the fundamental sine wave.

Kathmandu

Figure 3.15 shows the one week recording of voltage from the 13th to the 20th of December in Kathmandu. Compared to the Munich recording, the voltage is more

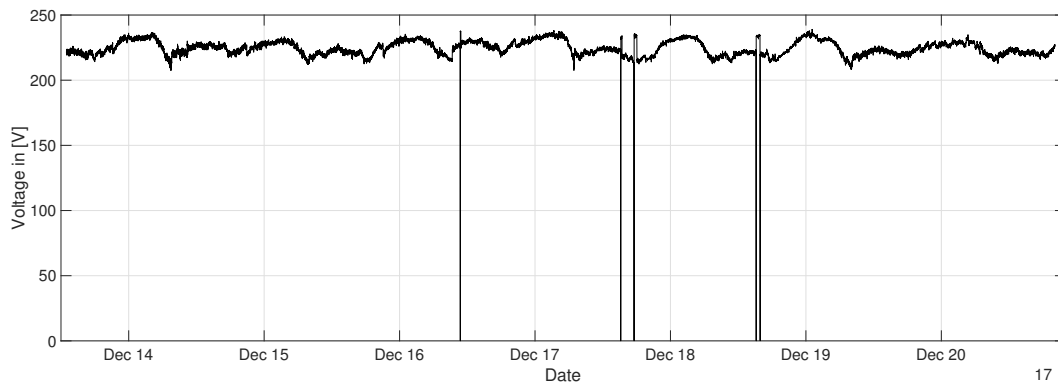

Figure 3.15: One week voltage recording from Kathmandu [own illustration].

volatile in Kathmandu, although it is held in a voltage range to a certain extent. Besides five interruptions over the course of the measurement, the voltage stays in the 200 V to 250 V interval. Figure 3.16 illustrates the matching frequency recording over the same one week period. When comparing this plot to the Munich recording, the frequency moves around the nominal value of 50 Hz for most of the time. However there are five interruptions and a couple of peaks visible in the graph. The time axis is narrowed down to a duration of one day (15th of December 2017) in figure 3.17, which enables a more detailed look on the voltage and frequency trend. The specific deviations are investigated based on power quality criteria and displayed in table 3.4. For the chosen time interval no significant deviations for

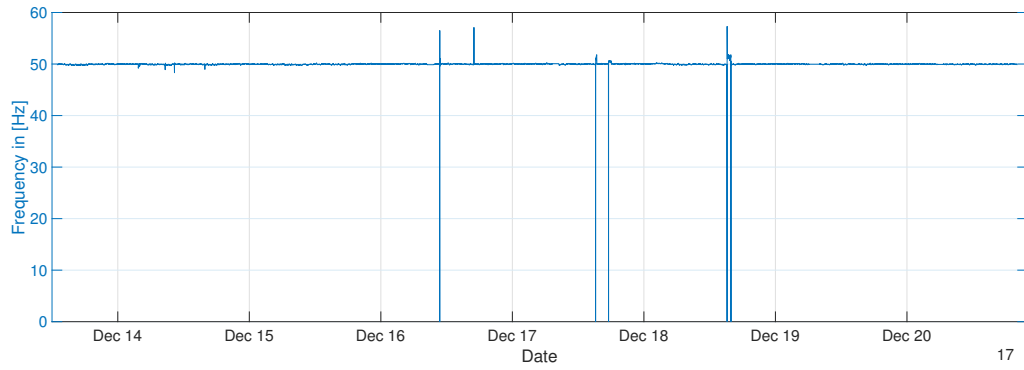

Figure 3.16: One week frequency recording from Kathmandu [own illustration].

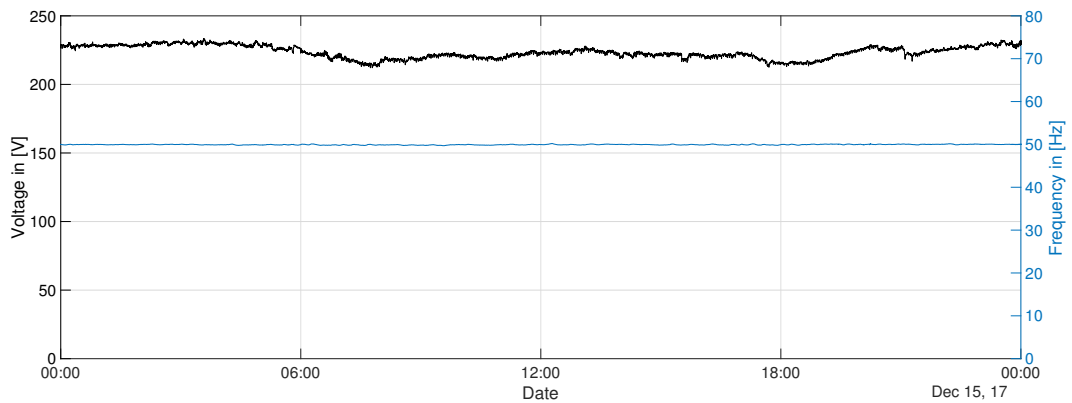

Figure 3.17: One day recording of voltage (black) and frequency (blue) from Kathmandu [own illustration].

Voltage sags	Voltage swells	Under-voltages	Over-voltages	Temp. interruptions	Sust. interruptions	Substantial voltage drops
0	0	0	0	0	0	0

Table 3.4: Voltage quality indices for one day measurement in Kathmandu

voltage or frequency did occur. Although a different day would have shown one or two interruptions, the rest of the power quality phenomena would have shown the same results. Finally figure 3.18 illustrates the occurrence probability of the specific values for frequency and voltage in a normalized histogram over the course of the recorded week. When examining the results, the expected value for the frequency is 49.9 Hz with a sigma value of 0.6. That means a deviation of 0.1 Hz or 0.2% off from the nominal frequency of 50 Hz over one week, which seems to be a good result. Considering the sigma value, it becomes clear that the deviations in both positive and negative direction are higher than first derived from the expected value, especially compared to the results from Munich. The expected value for voltage is 224.6 V with a sigma value of 6.5. Here, the deviation of the expected value from the nominal voltage is 5.4 V, which corresponds to 2.3% deviation over one

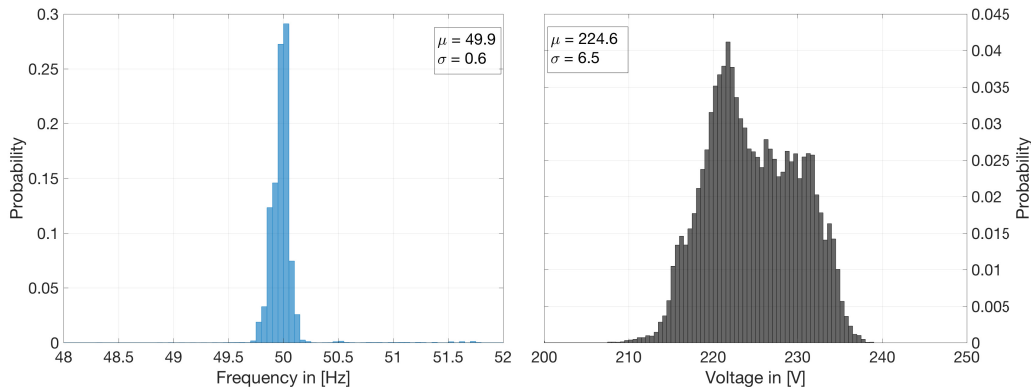

Figure 3.18: Weekly probability of frequency and voltage values from Kathmandu [own illustration].

week of recording. A sigma value of 6.5 is in an acceptable range, as the voltage will stay out of significant power quality criteria for most of the time. Even when considering the 2 sigma value (including 95.45 % of all recorded values), which equates to 13 V of deviation in positive and negative direction (211.6 V to 237,6 V), none of the considered power quality borders are violated. Figure 3.19 depicts the sine wave form recorded in Kathmandu. Especially compared to the Munich

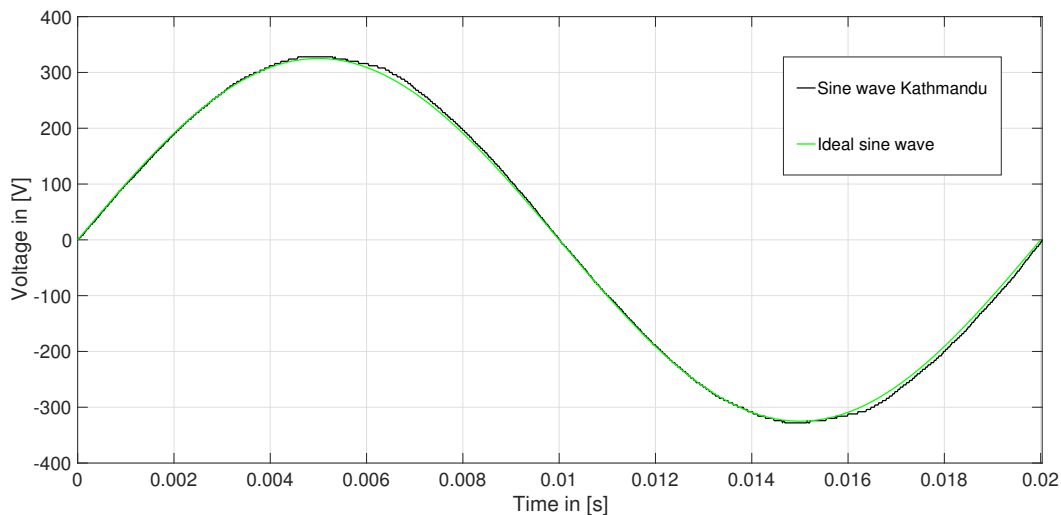

Figure 3.19: Sine wave recorded in Kathmandu and ideal sine wave for comparison.

voltage signal, the correlation between the sine wave in Kathmandu and the ideal sine wave form has significantly increased. Both zero crossings and magnitude of the two signals are well aligned.

Pokhara

Due to time constraints, power quality in Pokhara was only recorded from the evening of the 11th to evening of the 12th of December 2017. Figure 3.20 illustrates the voltage and frequency trend for the second biggest city of Nepal. The

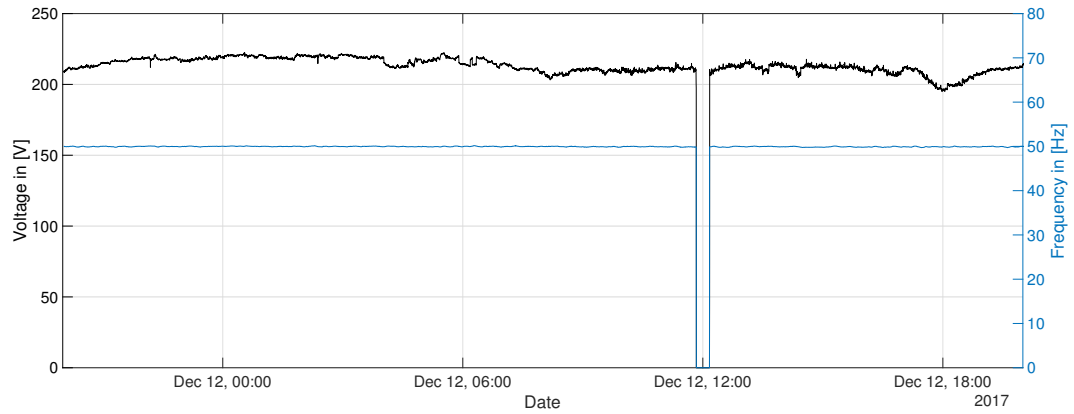

Figure 3.20: One day recording of voltage (black) and frequency (blue) from Pokhara [own illustration].

voltage trend stays in a 30 V-range for most of the time, however a long interruption occurs at around 12:00 on December the 12th. A 30 day voltage measurement from Pokhara with the Voltfox datalogger is presented in figure 6.3. The recording features a significantly increased amount of interruptions occurring per day, indicating worse power quality than in the one day measurement in figure 3.20. It has to be mentioned, that voltage was recorded in a five minute interval and there was no second measurement device deployed to verify these results. Table 3.5 lists the power quality violations over the one day recording. A total of 28 voltage sags with

Voltage sags	Voltage swells	Under-voltages	Over-voltages	Temp. interruptions	Sust. interruptions	Substantial voltage drops
28	0	12	0	0	1	0

Table 3.5: Voltage quality indices for one day measurement in Pokhara

a summed up duration of 940 seconds emerged over the recording. Further, 12 under-voltages with a total duration of 6970 seconds, which corresponds to almost two hours and one sustained interruption with 1180 seconds duration occurred. There are many power quality violations over the course of the one day recording, considering that this is the second biggest city of Nepal and it is connected to the public grid. Especially when comparing the results to Kathmandu, the number of sags and undervoltages have risen in a negative way. Figure 3.21 shows the probability of frequency and voltage values occurring over the one day measurement. The expected value for frequency equals to 49.2 Hz with a sigma of 5.8. That corresponds to a deviation of 0.8 Hz or 1.6% from the nominal frequency. These values have risen compared to Kathmandu. Comparing the expected value for voltage 209.9 V (20,1 V or 8.7% deviation from nominal voltage) with a sigma value of 25.2 with Kathmandu, the assumption that power quality in Kathmandu is better than in Pokhara is confirmed. Especially, when taking the results from table 3.5 into account. However, it should be mentioned, that the probability comparison was conducted with the one week measurement from Kathmandu. When considering the number of power quality violations in Pokhara, the overall lower voltage level seems

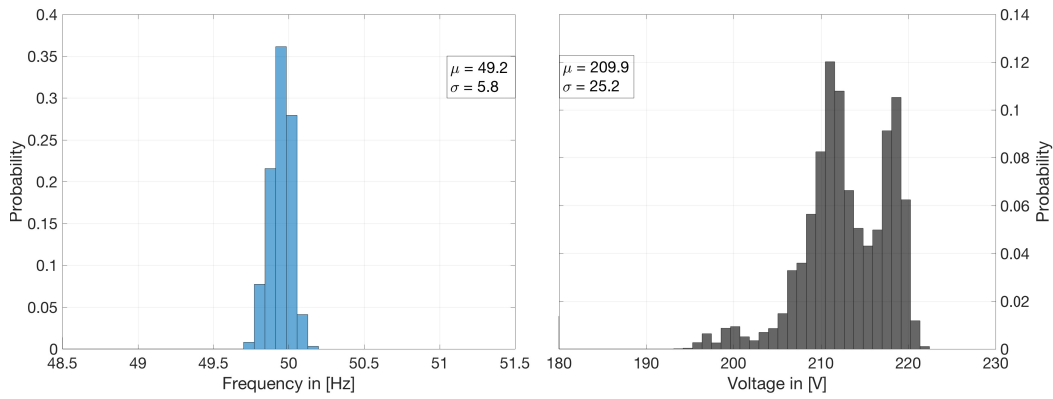

Figure 3.21: Daily probability of frequency and voltage values from Pokhara [own illustration].

to be the reason for the big number of voltage sags and under-voltages. Besides that, the voltage level stays in a 30 V-range (similar to Kathmandu) over most of the time, which could be interpreted as a type of voltage stability. Nevertheless, the effect of these deviations on electrical appliances and more importantly the end-user will be covered in chapter 4. If there are no major effects on the consumer site, a stable voltage level could be acceptable from the end-users perspective, even though voltage is shifted down to a lower level than the nominal voltage. Figure 3.22 shows the sine wave recorded in Pokhara compared to an ideal sine wave. The sine wave of the electric grid in Pokhara is well aligned with the ideal sine wave

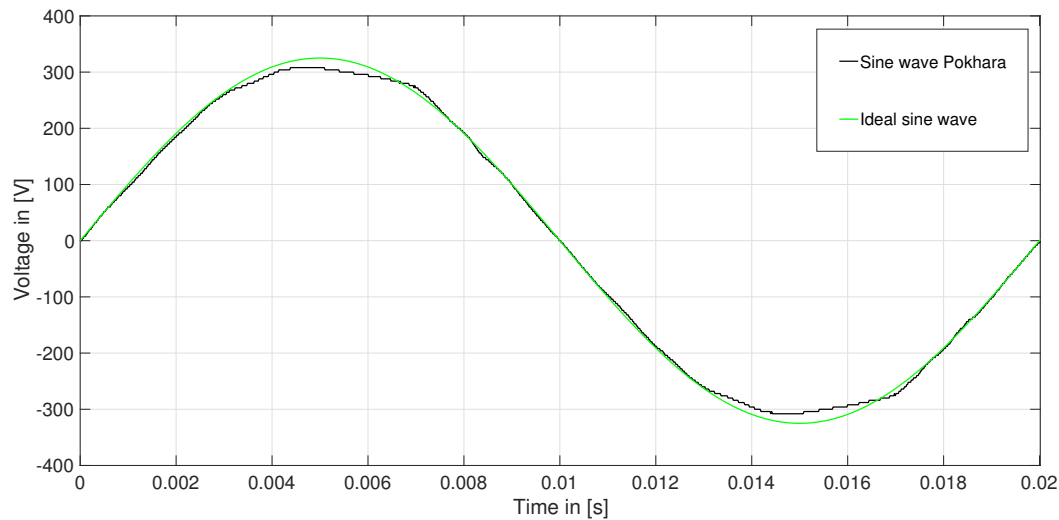

Figure 3.22: Sine wave recorded in Pokhara and ideal sine wave for comparison.

in terms of zero crossings, however the peaks of the signal look flattened out compared to the other on grid measurements, which confirms the overall lower voltage level in Pokhara found in the previous measurements. The signal looks smooth compared to the Munich sine wave, but some harmonic distortions are visible, as the voltage slightly oscillates along the signal.

An additional on grid recording in Dhulikhel, a city near Kathmandu, was conducted with the self built data logger. The one month voltage and frequency measurement is depicted in figures 6.4 and 6.5.

3.3.3 Off grid

This section covers all off grid measurements from Nepal, comprising the Lophelling Boarding School (LBS) and the mountain village Chame (see section 3.2)

Lophelling Boarding School

The one week voltage recording from the 25th of November until the 2nd of December 2017 is illustrated in figure 3.23. Compared to the on grid measurements, the

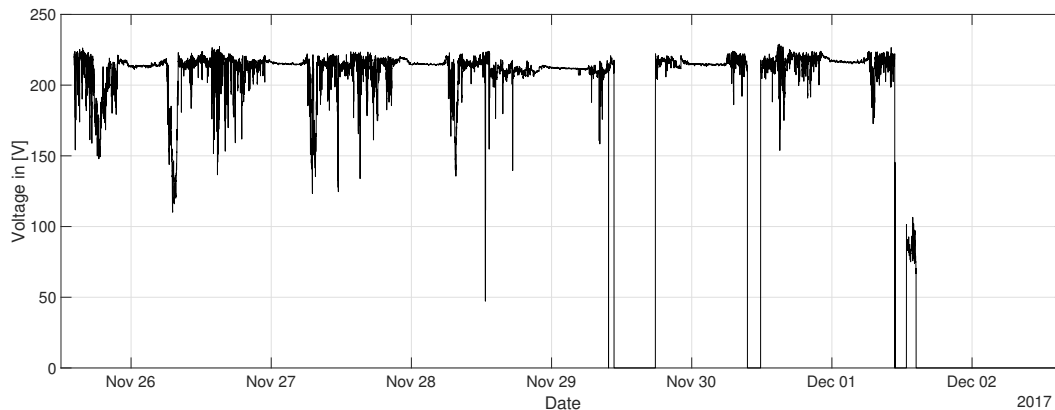

Figure 3.23: One week voltage recording from the LBS [own illustration].

voltage trend looks extremely volatile and five interruptions (four of them of longer duration) are visible. These interruptions were caused by a problem with the generator in the Sabje power station near the school. The last interruption lasted at least one week, as the headmaster of the school later confirmed. Figure 3.24 shows the matching one week frequency recording at the LBS. Similar to the voltage plot,

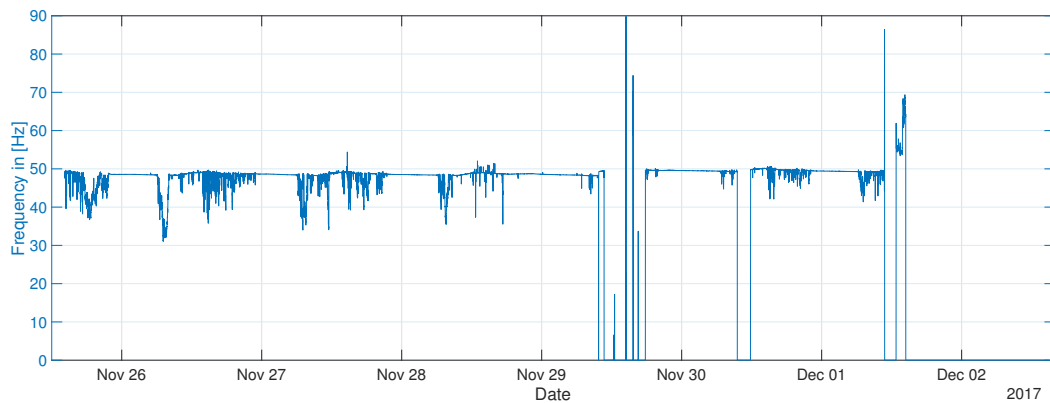

Figure 3.24: One week frequency recording from LBS [own illustration].

the frequency trend has extreme deviations in both negative and positive direction of the nominal frequency. During the long interruptions, there are some noticeable spikes in the graph. These may be failed attempts of the power station, to restart the power system. Before the longest interruption of this recording, starting in the afternoon of December the 1st, there is a period of low voltages and high frequencies. As a falling voltage otherwise is connected with falling frequency (and the

other way around) in the solely on generators-based power system, this seems to be an abnormality to normal operational mode. The generator had to be replaced by a new one according to the headmaster of the school, explaining the odd relation between frequency and voltage caused by malfunction in that specific period. Figure 3.25 shows the voltage and frequency values for November the 27th. The

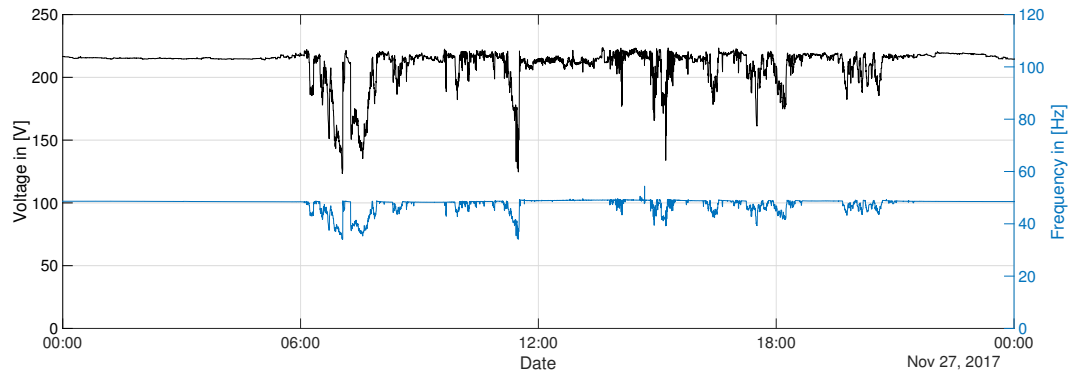

Figure 3.25: One day recording of voltage (black) and frequency (blue) from LBS [own illustration].

power quality violations originated from the 27th of November are listed in table 3.6. On this particular day, no interruptions occurred. However 37 voltage sags with a total duration of 1260 seconds and 32 under-voltages, adding up to 6410 seconds, were identified. Further, 28 frequency sags with a total duration of 830 seconds and 26 under-frequencies with a summed up duration of 4650 seconds were found. In contrast to all on grid measurements in this thesis, frequency sags and under-frequencies exist. Compared to the results from Pokhara, the number

Voltage sags	Voltage swells	Under-voltages	Over-voltages	Temp. interruptions	Sust. interruptions	Substantial voltage drops
37	0	32	0	0	0	7

Table 3.6: Voltage quality indices for one day measurement at LBS

of voltage sags and under-voltages has increased, but the plot would suggest even worse power quality. Many of these deviations are of too long duration or magnitude and therefore no nomenclature exists for them. In these periods the power quality is simply too bad to be recognized by the used power quality phenomena introduced in section 2.1.2. Therefore the new parameter called a substantial voltage drop shall be applied. In total, seven of these occurred with a total duration of 3670 seconds, which adds up to over one hour in the 24 hour recording. The corresponding substantial frequency drop (5 Hz - 40 Hz for longer than one minute) was found seven times with a total duration of 2730 seconds. The weekly probabilities in a normalized histogram for frequency and voltage values at the LBS are depicted in figure 3.26. The expected value for frequency is 41.4 Hz with a sigma value of 17. That corresponds to a deviation of 8.6 Hz or 17.2% from the nominal frequency and worse values than in any of the on grid locations. The same statement can be made for the expected voltage value, which equates to 180.2 V with

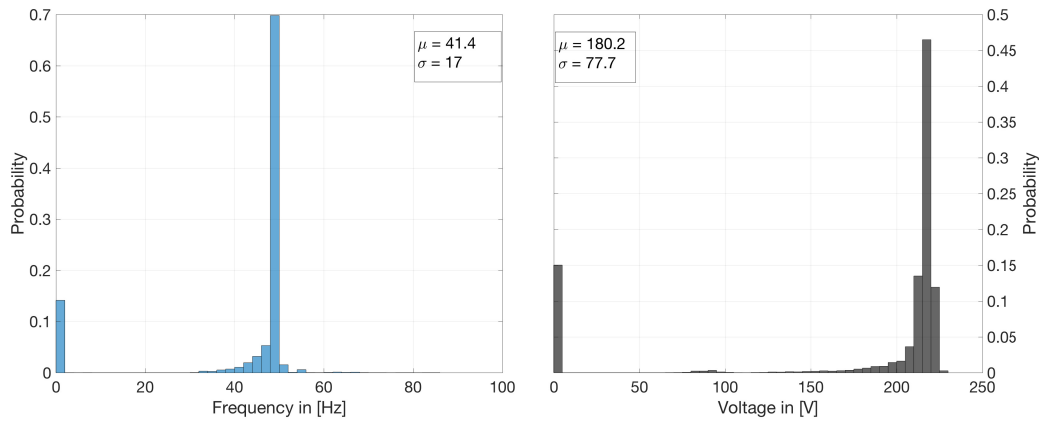

Figure 3.26: Weekly probability of frequency and voltage values from LBS [own illustration].

a σ value of 77.7. The deviation of the expected voltage value from the nominal voltage is 49.8 V or 21.6%. These high deviations from the nominal values and the extreme σ values have to be highlighted, as they are a clear index for poor power quality. Figure 3.27 shows the recorded sine wave signal for the supply voltage at the Lophelling Boarding School. Besides obvious deviations in magnitude and

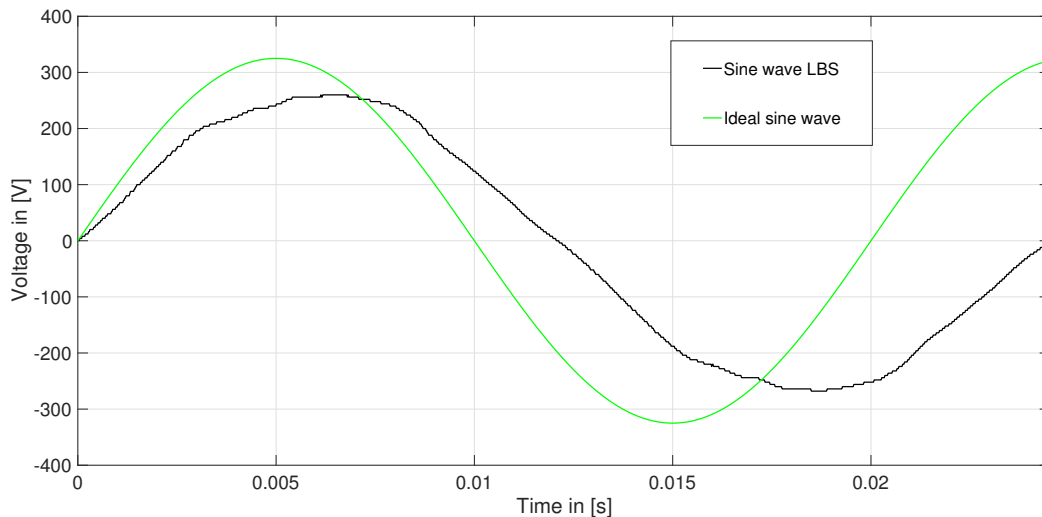

Figure 3.27: Sine wave recorded at the LBS and ideal sine wave for comparison.

zero crossings from the ideal sine wave, which essentially corresponds to lower rms voltage and frequency, the supply voltage signal shows a kink at the peak of the sine wave.

Chame

Figure 3.28 illustrates the one week voltage recording from 3rd to 10th of December 2017 in Chame. Similar to the measurements at the LBS, the voltage trend is characterized by extreme deviations from the nominal voltage predominantly in

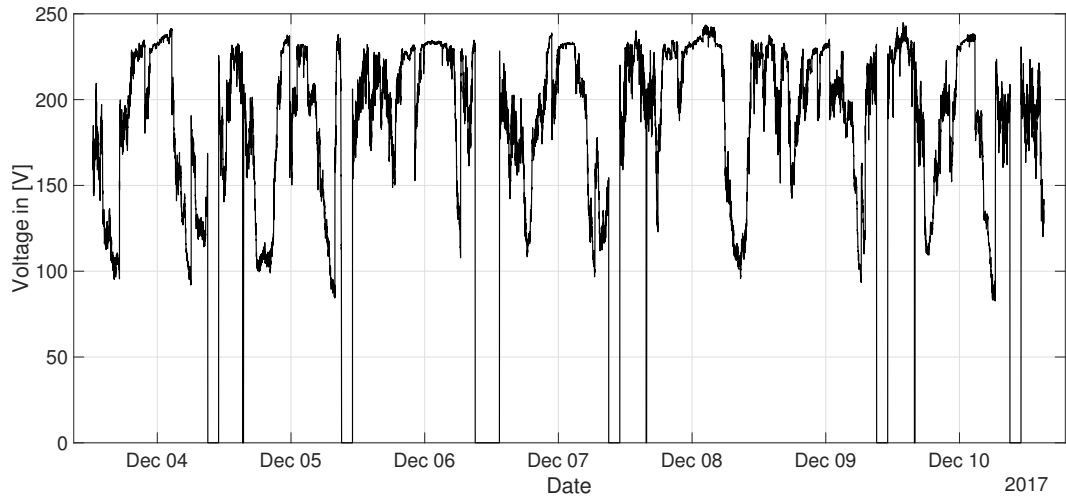

Figure 3.28: One week voltage recording from Chame [own illustration].

negative direction. Besides three short interruptions, almost every day features an interruption from around 09:00 to 11:00. These are planned by the person in authority to rest the machineries and prevent them from getting damaged. The one week frequency recording is shown in figure 3.29. Besides the above mentioned

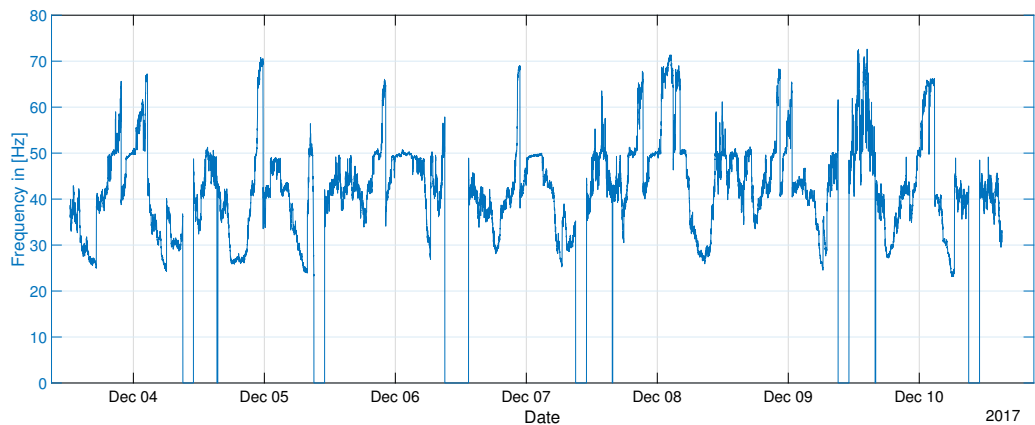

Figure 3.29: One week frequency recording from Chame [own illustration].

interruptions, frequency deviations in positive and negative direction occur. They range from 25 Hz up to over 70 Hz with the power system still being in operational mode. Frequency and voltage recordings for December the 7th are displayed in figure 3.30. All power quality violations emerging on that day are listed in table 3.7. In total, two sustained interruptions with a total duration of 7420 seconds (over two hours) and 35 voltage sags, lasting 1370 seconds occurred. Further, 32 under-voltages over a summed up duration of 9500 seconds took place. Nine substantial voltage drops emerged with a total duration of 16990 seconds (over 4.7 hours). When examining frequency, 14 frequency sags (480 s total time), 43 under-frequencies (1940 s total duration) emerged. Deviations in positive direction of the nominal value took place featuring eleven frequency swells (total: 340 s) and three

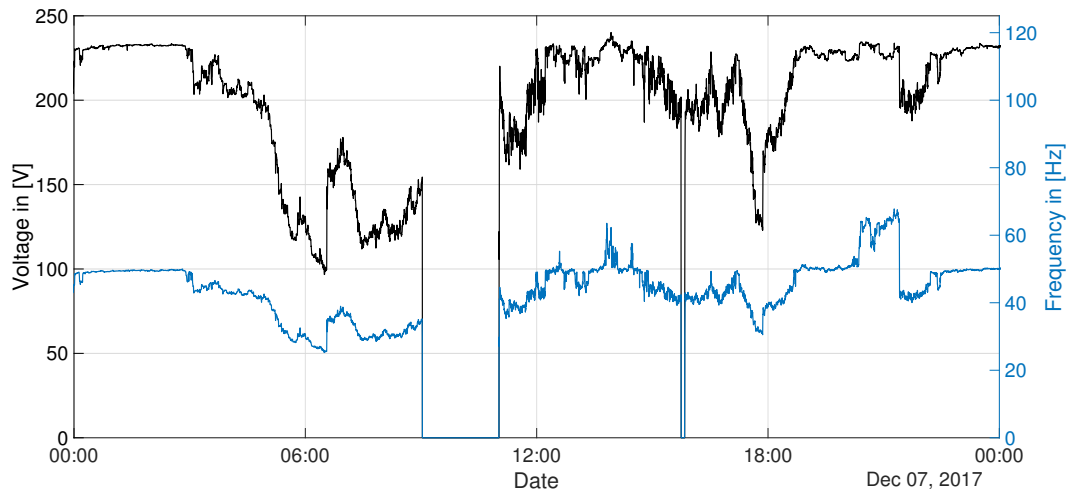

Figure 3.30: One day recording of voltage (black) and frequency (blue) in Chame [own illustration].

Voltage sags	Voltage swells	Under-voltages	Over-voltages	Temp. interruptions	Sust. interruptions	Substantial voltage drops
35	0	32	0	0	2	9

Table 3.7: Voltage quality indices for one day measurement in Chame

over-frequencies (total: 650 s). Similar to the recordings from the LBS, most of the deviations are of too big a magnitude or duration to be recognized as a violation of power quality after IEEE definitions. The substantial frequency drop however recognized nine events with a total duration of 19150 seconds (5.3 hours). Furthermore, six substantial frequency rises with a total duration of 3200 seconds were recognized. Figure 3.31 depicts the weekly frequency and voltage value probabilities for Chame. The expected value for frequency is 39.4 Hz with a sigma value of

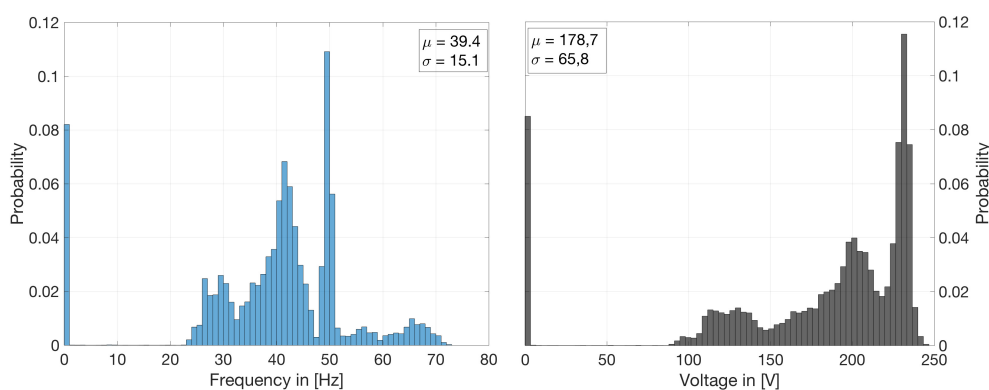

Figure 3.31: Weekly probability of frequency and voltage values in Chame [own illustration].

15.1, which corresponds to a deviation of 10.6 Hz or 21.2 % from the nominal fre-

quency and is the worst of all expected values measured. When examining voltage, the expected value equals to 178.87 V with a sigma of 65.8, meaning a deviation of 51,13 V or 22.2 % from nominal voltage. These values are obviously influenced by the planned two hours shutdown of the power system. There is no scientific proof in the habit of turning off all machineries for two hours every day for prevention of damage. Further, the end-user is affected in a negative way. Therefore, these interruptions will be taken into account when analyzing power quality in Chame. Both frequency and voltage have a probability of over 8 % to equal 0 in the course of 24 hours. Figure 3.32 illustrates the difference between an ideal sine wave for a 230 V power system with a nominal frequency of 50 Hz compared to the output signal of the supply voltage in Chame. The sine wave recording from Chame looks

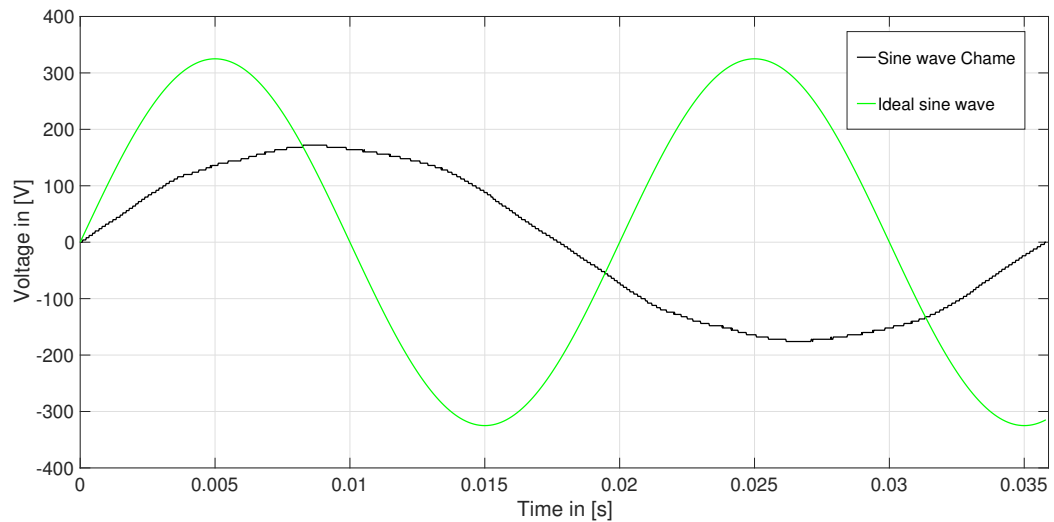

Figure 3.32: Sine wave recorded in Chame and ideal sine wave for comparison.

smoother than the one from the LBS. However the periods of the voltage signal are extremely extended compared to any of the previous signal plots, corresponding to a frequency of only about 28 Hz. Compared to the ideal sine wave, the magnitude of the voltage signal is almost twice as low, confirming the extreme deviations discovered in the long term measurements of voltage and frequency.

3.4 Summary

When comparing all measurements, Munich has the best power quality in almost every considered aspect. The difference in the expected values for voltage level between Munich (232.1 V), Kathmandu (224.6 V) and Pokhara (209.9 V) is noticeable. Kathmandu (-5.4 V) and Pokhara (-20.1 V) have a negative offset from the nominal voltage, in contrast to Munich's offset in positive direction (+2.1 V). The expected values for frequency recordings show the same order, with 49.98 Hz for Munich, 49.9 for Kathmandu and 49.2 in Pokhara. It should be mentioned, that the σ -values for frequency and voltage were the lowest in Munich. Between the two on grid locations Kathmandu and Pokhara, they differ strongly, with Pokhara having worse values for both parameters.

The investigated electromagnetic phenomena confirm the assumption, that power quality in Kathmandu is better than in Pokhara. Both sine wave recordings in the on grid locations in Nepal were of good quality when compared to a mathematical ideal signal. The smooth voltage signal of the national grid in Kathmandu even looked less disturbed by harmonics than in Munich. The good quality of the on grid sine wave recordings in Nepal could be explained with the big share of electricity imported from India (see 2.14).

Comparing the two off grid locations, the high weekly percentage of interruptions are to mention. At the Lophelling Boarding School 15% and in Chame over 8% of the week were covered by interruptions. Further, both of the locations had extreme deviations for μ from the nominal values for frequency and voltage and extremely high σ -values, especially compared to Munich and Kathmandu. The examined electromagnetic phenomena have their worst values for the two off grid locations in the Manang-district. In Chame, especially the frequency deviations in negative and positive direction were noticeable. In general, both LBS and Chame rather had deviations in negative direction of the nominal frequency and voltage. This is no surprise, as the capacity of the hydro plants in these places are under-designed to match the load-curve [37]. Many of the deviations in the off grid locations were of too long duration or high magnitude to be recognized by the utilized electromagnetic phenomena. It should be mentioned, that these are power quality measures originally designed for on grid application analysis by the IEEE. To cover all deviations in the two off grid locations, new definitions for voltage and frequency variations had to be made. Both substantial voltage and frequency drops were higher in Chame compared to LBS. Further a substantial frequency rise had to be introduced for Chame, to cover all deviations in positive direction of the nominal frequency. The sine wave recording of the supply voltage from Chame reveals smoother signal quality than the one from the LBS. However, compared to the ideal sine wave, the deviation of the signal regarding magnitude and period differ stronger for Chame than the LBS. According to the Annual Report of the NEA [29], the city of Chame is set to be included in the public grid in the course of 2018, which could result in better power quality in the village.

Chapter 4

Testing of electrical consumers under varying power quality

4.1 Testing setup

Before the electrical appliances can be tested under the established conditions from Chapter 3, the experimental setup has to be introduced in detail. A block diagram of the voltage (black) and frequency (blue) measurement assembly is depicted in figure 4.1. For the simulation of both negative and positive deviation in voltage, a isolation transformer is deployed. For frequency deviations, a variable frequency setup including a frequency inverter, an asynchronous motor and a synchronous generator becomes necessary. Further, an isolation transformer is connected to keep voltage at a constant level.

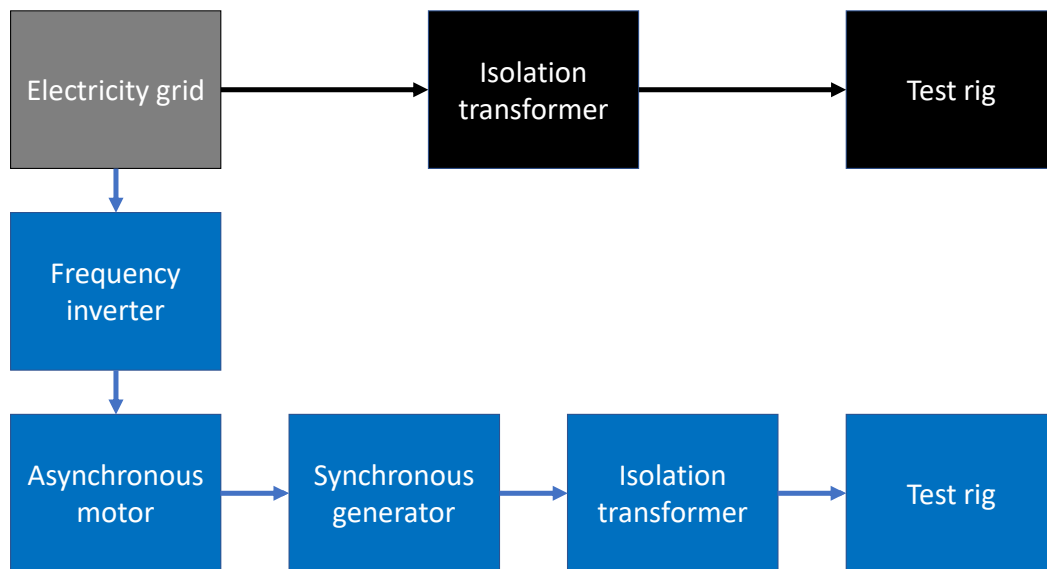

Figure 4.1: Block diagram of isolated voltage (black) and frequency (blue) experiment setup.

Voltage and frequency experiments will be conducted isolated from each other

and are linked to a test rig, which offers electrical socket outlets for different electrical appliances. Finally, for the recording of all relevant electrical parameters, a power quality measuring device is utilized.

4.1.1 Isolation transformer

The Peaktech 2235 is an adjustable isolation transformer by the company Peaktech. It is galvanically isolated from the grid and is simply plugged into a 230 V single phase electrical outlet. The output voltage is controllable and ranges between 0 V a.c. and 250 V a.c.. Output currents of 4.5 A a.c. are possible and the maximum output power is 1 kW. Further, the Peaktech 2235 has a d.c. output



Figure 4.2: Peaktech 2235 [38].

with two different operational modes. The first one has an adjustable voltage and current output. It ranges from 0 V d.c. to 30 V d.c. for the output voltage and from 0 A d.c. to 5 A d.c. for the output current. The second operating mode features a constant 3 A d.c. current and a constant 5 V d.c. voltage. The device has four digital displays, which indicate the output voltage and current for both the d.c. and the a.c. outputs [38].

4.1.2 Variable frequency drive

This setup consists of the WJ200 frequency inverter by Hitachi [39] and is supplied by a three phase 400 V electrical outlet. A 7.5 kW asynchronous motor by AC-Motoren GmbH is connected to the frequency inverter. Finally, a synchronous generator is connected with a rated power of 5 kW to generate a three phase frequency dependent output signal. When frequency deviations are tested isolated from voltage deviations, the isolation transformer introduced in section 4.1.1 is deployed after the generator, which enables constant voltage at varying frequency values. However it should be mentioned, that the output voltage of this testing setup is affected by higher THD values than normally observed in the german electricity grid. These exceed the tolerated 5% THD boarder for almost every frequency setting. Figure 4.3 shows the output of the generator at nominal voltage and frequency

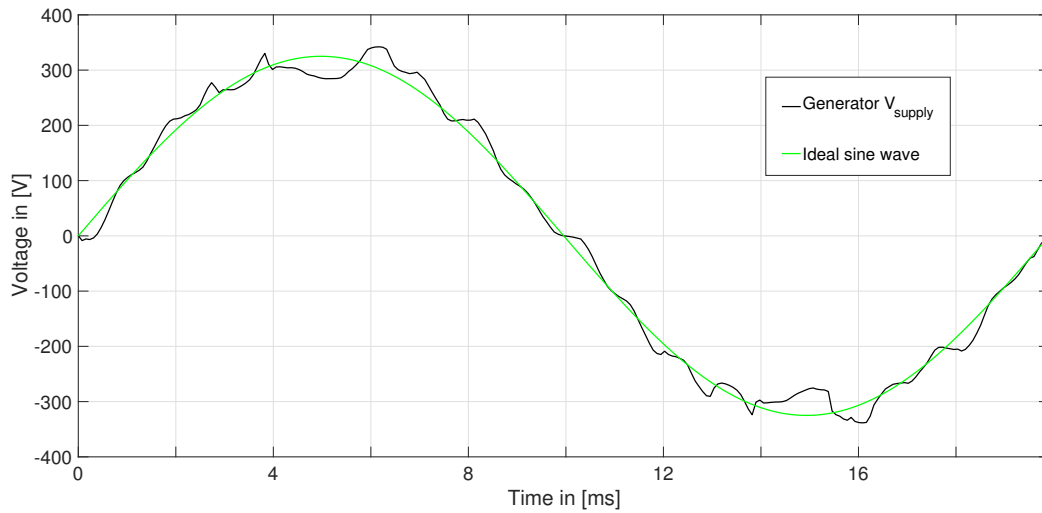

Figure 4.3: Output sine wave of the synchronous generator and ideal sine wave.

and an ideal sine wave for comparison. It was discovered, that the THD values will rise/fall when the frequency is increased/decreased. This behavior will be taken into account when the electrical devices are exposed to frequency deviations.

4.1.3 Test rig

To measure all kinds of electric parameters for a number of electrical appliances at the same time, a test rig was built. It features five parallel connected outlets, each featuring a switch, a socket and a Nepali lamp holder (see figure 4.4). Further, each

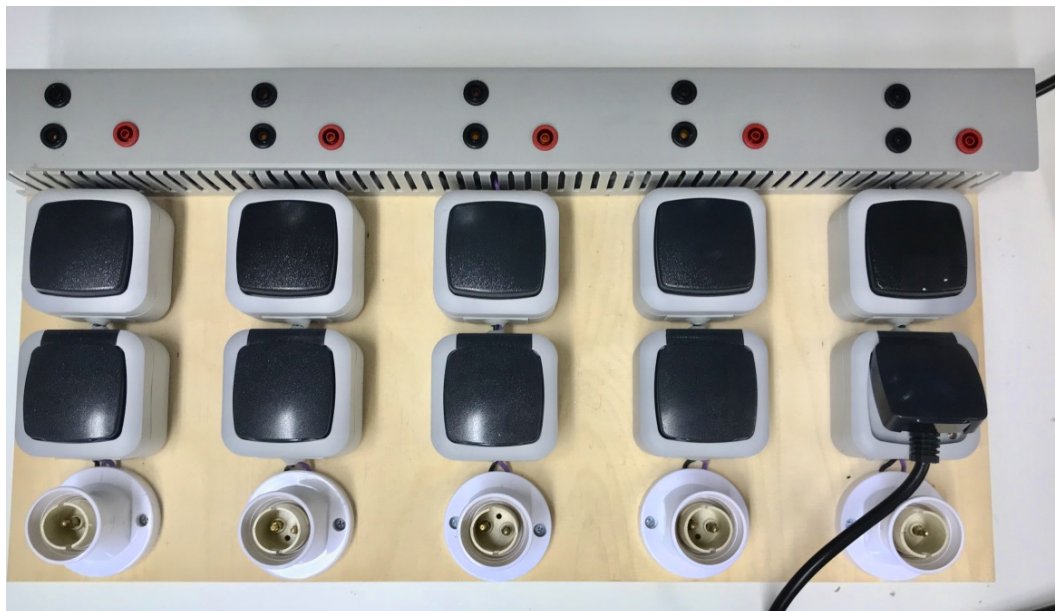

Figure 4.4: Self-built test rig with 4-mm terminals and several electrical sockets [own illustration].

of the outlets has three 4-mm terminals. The black ones are circuit interruptions of the phase, enabling electrical current measurements. The red 4-mm terminal is a neutral conductor access point, which provides the possibility of voltage measurement between the neutral and the phase potential.

4.1.4 Chauvin Arnoux 8336

The 8336 power & quality analyzer by Chauvin Arnoux combines many features of a multimeter and a oscilloscope. The device enables true rms measurement of current and voltage (4 input channels each) for a.c. and d.c, as well as sine wave form recording. With input voltages up to 1 kV and currents from 5 mA up to 10kA, the C.A 8336 is designed for a wide range of applications. Further, various power and energy values and disturbances of the sine wave, like harmonics or transients can be detected. All of these parameters can be recorded simultaneously and



Figure 4.5: Chauvin Arnoux 8336 power & quality analyzer [40].

selective parameters can be saved in adjustable sampling rates for weeks. It has a built-in battery or can be supplied by an a.c./d.c. converter for stationary usage. The values are displayed on a color TFT-display and can be saved in the internal storage of the device. Data can also be transferred to a PC through a USB interface. The software enables configuration, storage and analysis of the parameters, as well as data export [40].

4.2 Types of appliances

This section will introduce the different electrical appliances, which will be tested under varying power quality conditions. The selection is based on the questionnaire in section 2.4.3 and most of the devices were bought in Nepal's capital city Kathmandu. Therefore, the devices should be a good representation of average household appliances in the developing country in terms of costs, power and overall quality.

4.2.1 Lighting sources

Three different types of lighting sources were selected and bought in Kathmandu. Those are incandescent lightbulbs, CFL-lamps and two different types of LEDs. The lightbulb has no manufacturer print or signature on it and was simply wrapped in cardboard. Therefore, no further information on this device can be given.

The CFL-lamp claims to have a 15 W - power consumption with 710 lumen luminous flux and tolerates a voltage range from 140 V - 260 V. Both LED lamps are listed with 5 W - power consumption at a tolerated voltage range from 100 V - 240 V with an average life of 25,000 hours. The first manufacturer is called DIVYA and claims to have a Samsung LED inside. The second manufacturer is called SCT and was priced slightly above the DIVYA lamp, which would indicate better quality.

4.2.2 Water boiler

The water boiler from Home Lite has a power consumption of 300 W. It is designed for 220V - a.c. supply and has the capacity for one liter of water.

4.2.3 Rice cooker

In total, two different rice cookers were tested. The first one by the company Aftak has a power of 300W and a water capacity of 0.6 liters. The second rice cooker has a capacity of 1.8 liters and is manufactured by BRIGHT. The power consumption is listed as 700 W on the packing and the device is designed for 220 V a.c. at a frequency of 50 Hz.

4.2.4 Mobile charger

Mobile chargers by the company Balaji were bought on a market in Kathmandu. The input voltage range is listed between 100 V and 250 V a.c. on the back of the charger. Further, the output voltage shall range between 4 V and 12 V d.c. and the output current should equal to 800 mA. Original Samsung chargers were bought as well, featuring a 100 V to 240 V a.c. input voltage at a frequency range between 50 Hz and 60 Hz. The output voltage is 5 V d.c. and the output current is 2 A. Both charger - types will be tested with powerbanks by Goobay. These devices include a lithium ion battery with 3.7 V operating voltage at a capacity of 2000 mAh and should simulate a typical mobile phone.

4.2.5 TVs

As many households in rural areas still possess CRT TVs, a 14" TV of CRT technology was bought in Kathmandu. No general information about the TV could be found on the back of the device or on the internet. The second TV is manufactured by Aamaz and based on LED - technology. It is a 16" TV with a resolution of 1366·768. The tolerated input voltage ranges from 100 to 240 V a.c. at 50/60 Hz frequencies.

4.3 Testing conditions

Before presenting the results of the effect of voltage and frequency variations on electrical appliances, the testing conditions are introduced in detail. In [41] the effect of voltage swells on 62 electrical appliances was tested by rising the voltage by up to 40% of the nominal voltage (230 V) for varying time intervals. Many of the tested devices were able to survive +40% voltage deviations over 100 seconds. In [42], not only the effect of positive, but also negative deviations on electrical appliances were tested. Voltage deviations by $\pm 15\%$ of the nominal voltage were simulated for different household appliances like washing machines, dish washers and laptops. The goal was to find out, whether they would still work adequately and therefore the voltage supply range could be widened by the distribution network operator. It was found out that the tested electrical appliances and hence the end consumers were affected by the voltage variation in both positive and negative direction of the desired 230 V.

In this thesis, similar tests to [42] will be performed, however the electrical appliances introduced in section 4.2 will be exposed to higher deviations in negative direction of the nominal grid voltage, based on the results in chapter 3.3. Therefore, experiments with deviations of +10% and -50% of the nominal voltage will be conducted in 5% steps for most of the appliances. If the probe stops working at a certain voltage value, higher voltage deviations in that specific direction will not be performed as they presumably either do not have enough power to function or a system failure did occur. Some selective loads will be exposed to more extreme levels of deviation.

Frequency deviations were tested from 42.5 Hz up to 65 Hz. As the supply voltage generated by the synchronous generator reduces with decreasing frequency and the isolation transformer has a limit for transforming up the voltage, the setup for frequency deviation did not allow more deviation in negative direction. Additional tests for further deviation in negative direction of the nominal frequency were performed on some of the devices without the isolation transformer, and the results will be presented in the appendix.

The effect of voltage and frequency deviation on the electrical appliances firstly will be examined isolated from each other, meaning that voltage will be altered at almost constant grid frequency of 50 Hz and frequency deviations are monitored at constant grid voltage of 230 V. On one hand, these results are compared to each other by examining the input values of the electrical apparatus. These are input voltage, frequency, current and power. Further, power factor and the total harmonic distortion of the input current will be assessed. On the other hand, various output variables will be considered. These output values can vary from one electrical appliance to another. When looking at a water boiler, parameters like the time it takes to reach a certain temperature will be examined. In contrast, the output power will be investigated, when experimenting with mobile chargers.

4.4 Results and discussion

Due to the amount of data and for a clearer representation, some tables for electrical appliances will only display 10% steps instead of 5% steps for voltage and frequency deviation. The missing steps can be looked up in the appendix (chapter 6). All plots will be based on the 5% step - data.

4.4.1 Lighting sources

Each of the introduced lamps were bought several times and three different samples were tested to decrease the probability of production fluctuation. The output parameter, which will be examined for all lighting sources is the illumination. The results of all three samples will be presented for each lighting source.

Incandescent lightbulb

Table 4.1 lists all recorded electric parameters for an incandescent lightbulb exposed to voltage deviations between 115 V and 253 V. The electrical parameters

V_{in} [V]	I_{rms} [A]	P_{in} [W]	PF	THD(I) [%]	$E(V)$ [Lux]
252.8	0.25	62.6	1.0	1.5	1605
230.0	0.24	54.5	1.0	1.4	1140
207.2	0.22	46.6	1.0	1.4	768
184.2	0.21	39.0	1.0	1.4	482
161.1	0.20	31.9	1.0	1.3	272
138.0	0.18	25.3	1.0	1.3	138
115.1	0.17	19.4	1.0	1.3	58

Table 4.1: Voltage variations and effect on electrical parameters for an incandescent lightbulb.

for the lightbulb display the typical signs of a resistive load. As the supply voltage drops, the a.c. current and therefore the overall power consumption decreases. Further, illumination sinks with falling voltage (see 4.6 left). At 115 V, illumination equals to 58, which corresponds to only 5 % of the illumination at the nominal voltage. Table 4.2 lists the effect of frequency deviations on electrical parameters. As

f_{in} [Hz]	I_{rms} [A]	P_{in} [W]	PF	THD(I) [%]	$E(f)$ [Lux]
65.0	0.24	55.4	1.0	9.4	1465
60.0	0.24	55.3	1.0	9.0	1463
55.0	0.24	55.3	1.0	8.7	1463
50.0	0.24	55.3	1.0	8.4	1455
45.0	0.24	55.2	1.0	6.9	1449
42.5	0.24	55.2	1.0	7.0	1447

Table 4.2: Frequency variations and effect on electrical parameters for an incandescent lightbulb.

frequency changes, almost none of the electric parameters from before seem to

change significantly. Only the THD value for current seems to rise with increasing frequency, which can be explained with a rising THD for the supply voltage. It is caused by the asynchronous and synchronous machines operating at frequencies the motor/generator is not laid out for. The illuminance seems to stay about the same over all tested frequency values and is displayed in figure 4.6 on the right for better visualization. In conclusion, voltage variations have a negative impact on

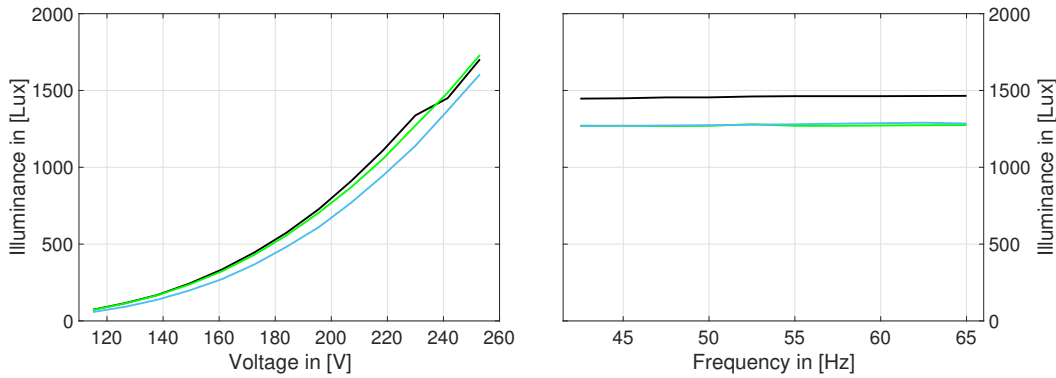

Figure 4.6: Illuminance dependent on voltage (left) and frequency (right) for three samples of incandescent lightbulb lamps.

the user experience when using incandescent lightbulbs, as rooms are illuminated worse when lower supply voltages occur. As supply voltage in Nepals off grid applications often is significantly below nominal voltage, these deviations impact the living standards in these rural areas negatively. The tested frequency deviations have no significant impact on the end user. However, more extreme frequency deviations could be conducted for more informative value, especially considering the recorded grid frequency of 25 Hz in the village of Chame.

CFL lamps

Voltage deviations conducted with CFL lamps and their effect on electrical parameters are listed in table 4.3. It is noticeable, that the input current I of the CFL lamps

V_{in} [V]	I_{rms} [A]	P_{in} [W]	PF	THD(I) [%]	$E(V)$ [Lux]
253.1	0.09	14.0	0.63	109.7	1948
230.0	0.09	12.7	0.64	104.8	1796
206.9	0.09	11.6	0.65	102.4	1669
184.2	0.09	10.6	0.64	100.8	1505
161.1	0.09	9.4	0.65	96.5	1299
138.0	0.09	8.2	0.66	88.9	1040
115.2	0.09	6.8	0.68	80.9	732

Table 4.3: Voltage variations and effect on electrical parameters for CFL lamp.

stays the same, however overall power consumption decreases with lower supply voltage. Further, the THD values for the a.c. current fall as the power factor slightly increases with decreasing voltage. Similar to the incandescent lightbulb, the illu-

mination decreases extremely with falling supply voltage level (see figure 4.7 left). Table 4.4 lists all tested frequency deviations and their effect on electrical parameters. The result of the frequency deviations is that power consumption, input current

f_{in} [Hz]	I_{rms} [A]	P_{in} [W]	PF	THD(I) [%]	$E(f)$ [Lux]
65.0	0.09	12.8	0.59	133.2	1795
60.0	0.10	12.9	0.57	135.3	1792
55.0	0.10	13.1	0.55	150.3	1804
50.0	0.11	13.3	0.51	170.8	1814
45.0	0.10	12.7	0.57	135.8	1779
42.5	0.09	12.6	0.58	132.0	1774

Table 4.4: Frequency variations and effect on electrical parameters for CFL lamp.

and illuminance (see figure 4.7 right) show no significant reactions. However, it is noticeable that the power factor increases at the same time as THD values for the input current decrease in positive and negative deviation of the nominal frequency of 50 Hz. Similar to the incandescent lightbulb, frequency variations seem to have

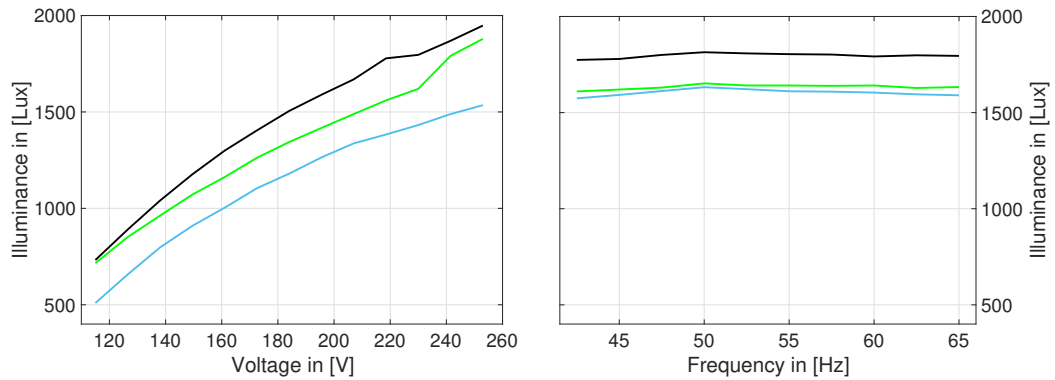

Figure 4.7: Illuminance dependent on voltage (left) and frequency (right) for three samples of CFL lamps.

no significant impact on the end user experience. Voltage deviations however, influence the illumination with falling supply voltage in a negative way, as homes will be lightened out worse than when operated at nominal voltage. THD values for both deviations have extremely high values, especially compared to the incandescent lightbulb. These can have negative impact on the sine wave form of the supplying grid, as they impose harmonic distortions on to the power system [43].

LED lamps

Table 4.5 lists all electric parameters for the LED lamp by DIVYA exposed to voltage variations from 115 V to 253 V. As supply voltage decreases, the input current increases in a way that the power consumption stays about the same for all voltage levels, which is a typical behavior for switch mode power supply appliances. Increasing supply voltage results in a decrease in power factor and increase in THD level for the a.c. current. The different voltage levels seem to have no significant

V_{in} [V]	I_{rms} [A]	P_{in} [W]	PF	THD(I) [%]	$E(V)$ [Lux]
253.1	0.04	4.6	0.48	177.7	919
229.7	0.04	4.6	0.53	155.0	916
206.9	0.04	4.6	0.53	151.5	893
184.0	0.05	4.5	0.52	154.1	882
160.9	0.05	4.5	0.52	154.7	876
138.2	0.06	4.5	0.57	128.9	855
114.9	0.07	4.5	0.56	125.0	845

Table 4.5: Voltage variations and effect on electric parameters for LED lamp by DIVYA

impact on the illumination output of the DIVYA LED lamp. The results are visualized on the left of figure 4.8. The effect of frequency variations on the electrical parameters is presented in table 4.6. Similar to the voltage variations, frequency deviations

f_{in} [Hz]	I_{rms} [A]	P_{in} [W]	PF	THD(I) [%]	$E(f)$ [Lux]
65.0	0.06	4.7	0.37	251.5	914
60.0	0.06	4.7	0.35	262.9	899
55.0	0.06	4.7	0.33	290.8	872
50.0	0.06	4.7	0.35	268.1	858
45.0	0.04	4.6	0.48	184.6	853
42.5	0.04	4.6	0.49	176.4	849

Table 4.6: Frequency variations and effect on electric parameters for LED lamp by DIVYA

result in no noticeable change in power consumption or illumination (see figure 4.8 right). THD values for the a.c. current however, seem to reach extreme levels of up to 290% at 55 Hz. These values are abnormally high, especially when compared to the THD values recorded for voltage deviations (max. THD: 177.7% at 253 V).

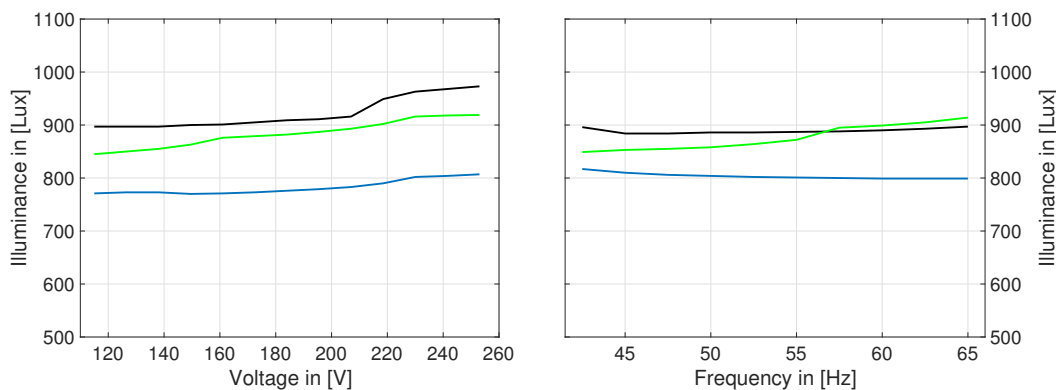

Figure 4.8: Illuminance dependent on voltage (left) and frequency (right) for three samples of DYVIA LED lamps.

Table 4.7 lists all considered electric parameters exposed to voltage variations

from 115 V to 253 V for the more expensive SCT LED lamp. It shows the identical

V_{in} [V]	I_{rms} [A]	P_{in} [W]	PF	THD(I) [%] *	$E(V)$ [Lux]
253.1	0.04	5.4	0.52	152.7	812
230.2	0.04	5.4	0.54	145.2	795
207	0.05	5.2	0.55	140.6	783
184.1	0.05	5	0.57	135.2	773
161.2	0.05	4.9	0.6	128.6	765
138	0.06	4.8	0.61	121.3	755
115.2	0.07	4.7	0.65	109.0	752

Table 4.7: Voltage variations and effect on electric parameters for the SCT LED lamp.

behavior as the DIVYA LED lamp in terms of input current rising and illumination values staying about the same (see figure 4.9 left) with decreasing voltage level. The power consumption seems to decline in a slow fashion from 5.4 W at 253 V to 4.7 W at 115 V, although it stays at a similar level, especially compared to the results of the incandescent lightbulb or the CFL lamps. The effect of frequency deviation on the considered electrical parameters is presented in table 4.8. Similar to

f_{in} [Hz]	I_{rms} [A]	P_{in} [W]	PF	THD(I) [%]	$E(f)$ [Lux]
65.0	0.05	4.6	0.44	208.5	728
60.0	0.05	4.6	0.41	220.4	721
55.0	0.05	4.6	0.39	248.1	719
50.0	0.05	4.6	0.40	234.7	719
45.0	0.04	4.5	0.52	165.9	716
42.5	0.04	4.5	0.54	155.7	716

Table 4.8: Frequency variations and effect on electric parameters for the SCT LED lamp.

the DIVYA LED lamp, the SCT LED lamps show almost constant values for power consumption, and illumination (see figure 4.9 right). Compared to voltage variations, the THD values for frequency variations are extremely high, with a maximum THD value of 248% (max. THD for voltage variation: 152.7 %).

In conclusion, the effects of the tested voltage and frequency variations have no noticeable impact on the consumer, as illumination and power consumption more or less stay the same. At 115 V, the illumination of the SCT LED lamp still equals to 94% of the illumination at nominal voltage. These smaller deviations could be explained by a higher power loss of the LEDs, generated by increasing warmth in the electronics of the lamp over the course of the recordings, as the experiment was started at 230 V and ended at 115 V. It is noticeable, that all of the three tested samples are aligned in a tighter illumination bandwidth compared to the DIVYA lamp, which indicates better production quality. Further, the THD values for the SCT LED lamp are lower than those for the cheaper DIVYA LED lamp. This thesis mainly considers the effect of changes in power quality on consumers. However, from the

*The THD values were recorded in a separate experiment under identical testing conditions.

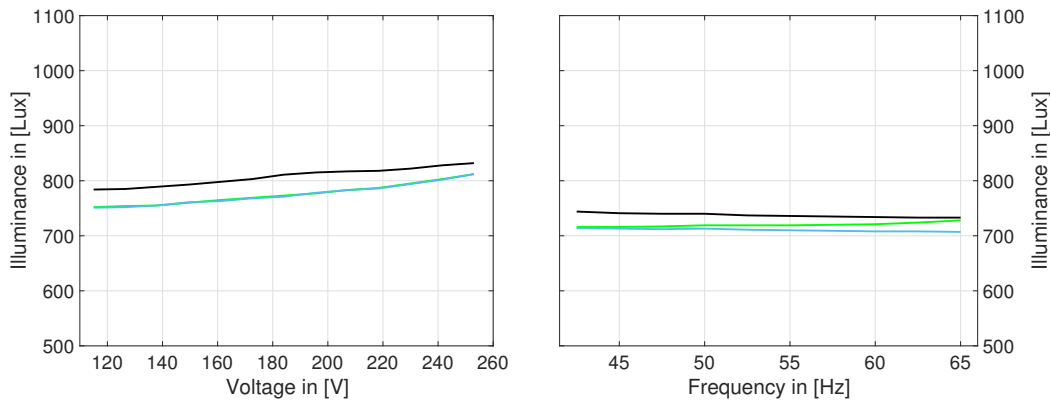

Figure 4.9: Illuminance dependent on voltage (left) and frequency (right) for three samples of SCT LED lamps.

network system operators view, high THD values, which were especially witnessed in the frequency variations, could have a negative effect on the sine wave of the supplying power system as mentioned before [43].

4.4.2 Water boiler

Table 4.9 lists the considered electrical parameters dependent on voltage variations for a 300 W water boiler. All tests were started from the same temperature level with 500 ml of water. The output parameter is the total time until the water boils. As a fully resistive load (power factor of 1.0), the water boilers a.c. current drops

V_{in} [V]	I_{rms} [A]	P_{in} [W]	PF	THD(I) [%]	t_{cook} [mm:ss]
253.1	1.28	324.9	1.0	1.38	09:07
241.5	1.23	297.2	1.0	1.38	10:11
230.3	1.16	268.1	1.0	1.46	10:57
218.7	1.11	242.0	1.0	1.42	12:45
207.3	1.05	217.7	1.0	1.42	15:28
195.6	0.99	193.9	1.0	1.47	18:47
184.0	0.93	171.7	1.0	1.55	-
172.5	0.88	151.2	1.0	1.57	-
161.1	0.82	131.8	1.0	1.59	-

Table 4.9: Voltage variations and effect on electric parameters for water boiler

as the supply voltage decreases similar to the incandescent lightbulb. As a result, power consumption will also decrease, consequently prolonging the time it takes to boil the water inside. It takes more than two times longer to boil water at 195.5 V compared to boiling water at 253 V. The measurements were performed without the closing top, as the water cooker had no opening to insert the temperature sensor through the closing top. This could explain that the water stopped boiling at 184 V. The results are graphically illustrated on the left of figure 4.10. Frequency variations from 42.5 Hz to 65 Hz and their effect on electrical parameters for the water cooker are listed in table 4.10. The a.c. current and power consumption stay almost the

f_{in} [Hz]	I_{rms} [A]	P_{in} [W]	PF	THD(I) [%]	t_{cook} [mm:ss]
65.0	1.17	270.2	1.00	11.2	10:42
60.0	1.17	269.6	1.00	10.3	10:29
55.0	1.17	269.9	1.00	9.4	11:06
50.0	1.17	269.2	1.00	8.4	10:56
45.0	1.17	268.8	1.00	6.5	11:20
42.5	1.17	267.9	1.00	6.5	11:17

Table 4.10: Frequency variations and effect on electric parameters for water boiler

same for every frequency value. As mentioned before the rising THD values for the a.c. current with increasing frequency are to be blamed on the asynchronous motor and synchronous generator causing a higher THD value for the supply voltage. The total time before the water boils, moves around 11:00 minutes and does not change significantly compared to the results of the voltage deviations (see right figure 4.10). In conclusion, the consumer will not be affected by frequency variations

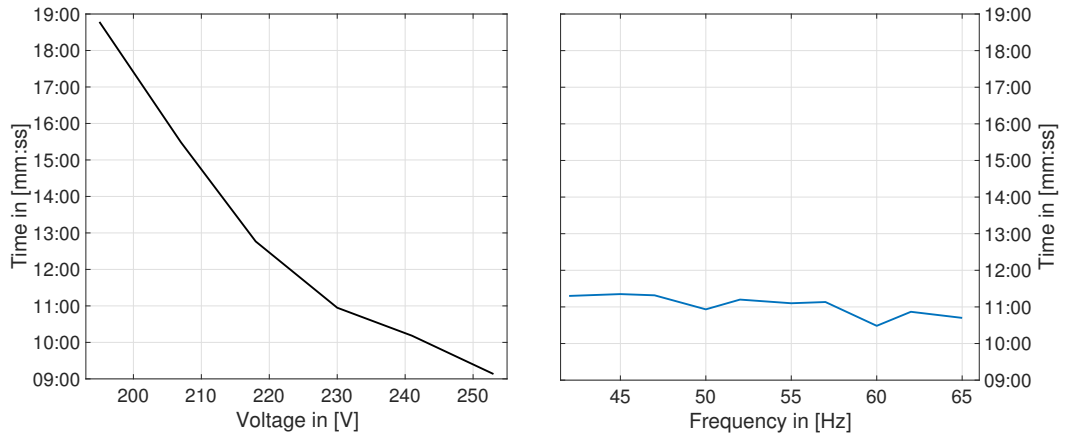

Figure 4.10: Time before water cooks dependent on voltage (left) and frequency (right) for a 300 W water boiler.

in the tested frequency interval. Voltage deviations however, will impact the end user in a negative way. When voltage drops below the nominal voltage, it will take longer to boil the water.

4.4.3 Rice cooker

The 300 W rice cooker experiments were conducted with 500 ml of water and started at the exact same temperature for every voltage/frequency level. Table 4.11 features the electrical parameters for the voltage range between 149.5 V and 253 V. The overall power consumption and the a.c. current significantly decrease with lower supply voltages. As a result, the total time until the water boils increases from 09:49 at 253 V to 31:13 at 149.5 V. Table 4.12 lists all electric parameters when the 300 W rice cooker is exposed to frequency variations between 42.5 Hz and 65 Hz. Similar to the water boiler, the examined frequency deviations do not have an

V_{in} [V]	I_{rms} [A]	P_{in} [W]	PF	THD(I) [%]	t_{cook} [mm:ss]
252.9	1.33	337.1	1.0	1.39	09:49
230.1	1.20	277.2	1.0	1.55	11:43
207.0	1.09	224.8	1.0	1.49	14:42
184.0	0.97	177.8	1.0	1.55	18:23
162.0	0.86	138.5	1.0	1.39	24:47
149.5	0.79	118.1	1.0	1.39	31:13

Table 4.11: Voltage variations and effect on electric parameters for 300 W rice cooker

f_{in} [Hz]	I_{rms} [A]	P_{in} [W]	PF	THD(I) [%]	t_{cook} [mm:ss]
65.0	1.22	280.2	1.00	11.2	11:08
60.0	1.21	279.4	1.00	10.4	11:15
55.0	1.21	279.1	1.00	9.5	11:23
50.0	1.21	278.7	1.00	8.6	11:05
45.0	1.21	278.5	1.00	6.5	11:13
42.5	1.21	277.3	1.00	6.5	11:30

Table 4.12: Frequency variations and effect on electric parameters for 300 W rice cooker

noteworthy impact on any of the considered electric parameters. This is confirmed by the cooking time staying almost the same for every frequency level, illustrated on the right side of figure 4.11. Table 4.13 features all examined voltage levels and

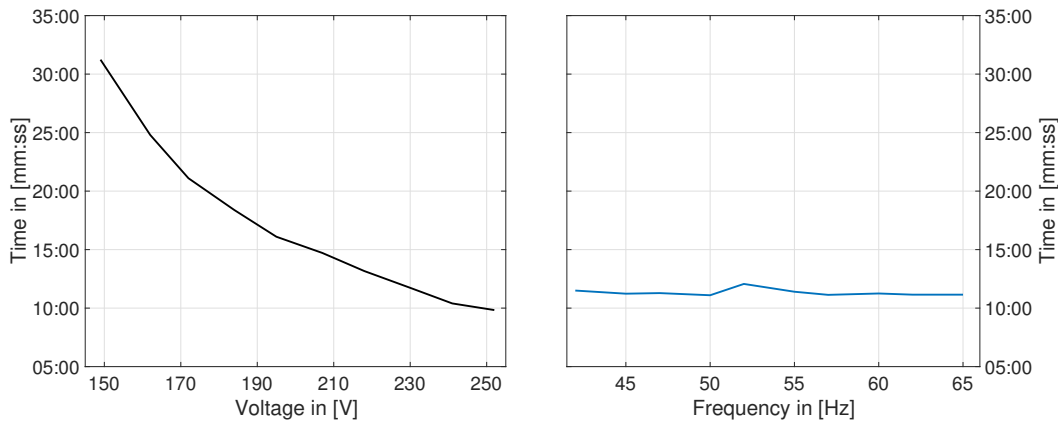

Figure 4.11: Time before water cooks dependent on voltage (left) and frequency (right) for a 300 W rice cooker.

the effect on electric parameters and the output value for a 700 W rice cooker. It was tested with 1000 ml of water, as the size of the device increased compared to the previous testing objects (water boiler and 300 W rice cooker). With a power factor of 1.0, the 700 W rice cooker is a purely resistive load. As the supply voltage drops, the a.c. current decreases as well. Similar to the 300 W rice cooker, the result is a lower power consumption with decreasing voltage levels. As mentioned

V_{in} [V]	I_{rms} [A]	P_{in} [W]	PF	THD(I) [%]	t_{cook} [mm:ss]
253.1	2.65	671.0	1	1.4	08:52
230.0	2.40	551.0	1	1.4	11:03
207.2	2.16	448.4	1	1.6	13:06
184.0	1.92	354.1	1	1.6	15:29
160.9	1.68	270.9	1	1.6	22:00
138.1	1.44	199.5	1	1.7	30:49
126.5	1.32	167.4	1	1.6	38:22

Table 4.13: Voltage variations and effect on electric parameters for 700 W rice cooker

before, this will prolong the time it takes to boil water. The cooking time dependent on the supply voltage level is illustrated on the left side of figure 4.12. Further, table 4.14 lists all frequency variations and their effect on the electrical appliances and the cooking time. The frequency deviations have no significant impact on the

f_{in} [Hz]	I_{rms} [A]	P_{in} [W]	PF	THD(I) [%]	t_{cook} [mm:ss]
65.0	2.42	556.3	1	13.3	09:33
60.0	2.42	557.1	1	12.8	09:22
55.0	2.42	556.9	1	10.9	09:25
50.0	2.42	555.8	1	8.8	09:20
45.0	2.41	554.2	1	7.3	09:25

Table 4.14: Frequency variations and effect on electric parameters for 700 W rice cooker

consumer, as power consumption and cooking time stay about the same, especially compared to the voltage deviations. The cooking time dependent on the frequency is plotted on the right side of figure 4.12. Summarizing, both rice cookers seem to

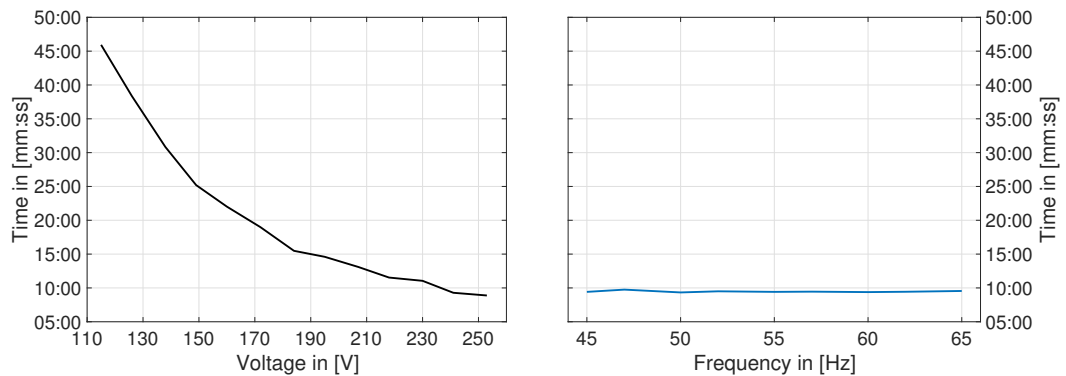

Figure 4.12: Time before water cooks dependent on voltage (left) and frequency (right) for a 700 W rice cooker.

endure frequency variations fine. However when the supply voltage decreases, the consumer will be impacted increasingly in a negative way, as water will take longer

to boil. It should be mentioned, that the measured durations are only timed until water cooks. Preparing a cooked rice meal will take even longer.

4.4.4 Mobile chargers

Similar to the lighting sources, several mobile chargers of the same type were bought. Three samples of each model were tested to minimize the effect of production fluctuation. The output parameter for the deviation experiments is the output voltage and current or respectively the output power. Both tested mobile chargers were examined by charging a powerbank, which was discharged to 0 % capacity before every experiment and simulates the accumulator of a mobile phone. Table 4.15 lists all voltage deviations for the Samsung mobile charger from 80.5 V to 253 V and their effect on the electrical parameters. As a typical switch mode power

V_{in} [V]	I_{rms} [A]	P_{in} [W]	PF	THD(I) [%]	V_{out} [V]	I_{out} [A]	P_{out} [W]
253.1	0.03	4.0	0.49	173.6	5.13	0.67	3.4
230.0	0.04	4.1	0.51	169.2	5.14	0.71	3.6
206.9	0.04	4.0	0.52	164.4	5.14	0.66	3.4
183.8	0.04	4.3	0.54	156.2	5.14	0.71	3.6
161.0	0.05	4.1	0.54	153.9	5.14	0.68	3.5
137.9	0.05	3.7	0.55	147.8	5.14	0.67	3.4
114.9	0.06	3.9	0.56	142.2	5.13	0.69	3.5
91.9	0.08	4.3	0.59	128.5	5.13	0.69	3.5
80.6	0.09	4.3	0.61	121.6	5.12	0.70	3.6

Table 4.15: Voltage variations and effect on electric parameters for Samsung mobile charger

supply load, the Samsung charger seems almost immune to voltage deviations. As voltage decreases, the input current rises and consequently keeps the power consumption in the 4 W - range. It is noticeable that the THD values for the input current rise with higher voltage values. The output power stays almost the same as well, delivering the same charging power at 80.6 V as when supplied with 230 V. In figure 6.1 and 6.2, the charging curve for voltage and current of a powerbank connected to the Samsung charger is depicted for 230 V and 150 V supply voltage. Although there are small differences in the form of the current trend, it took about the same time to charge the powerbank to 100%, which means that the end user stays unaffected by these variations. Frequency deviations between 42.5 Hz and 65 Hz can be found in table 4.16. Independent of the frequency value, the charging power stays roughly the same. The output parameters are plotted in figure 4.13 for voltage (left) and frequency (right) variations. The output power does not change significantly under the tested variations. Table 4.17 lists all electric parameters of the Balaji mobile charger when exposed to voltage deviations from 80.5 V to 253 V. In contrast to the Samsung charger, the Balaji does not react like a typical switch mode power supply, as the power consumption decreases with lower voltage levels. When looking at the output power, a different behavior is visible. From 253 V to 150 V the output power stays about the same, however it drops to low output values drastically after that. Figure 4.14 (left) depicts the charging power depen-

f_{in} [Hz]	I_{rms} [A]	P_{in} [W]	PF	THD(I) [%]	V_{out} [V]	I_{out} [A]	P_{out} [W]
65.0	0.05	4.8	0.39	231.0	5.13	0.74	3.8
60.0	0.05	4.3	0.37	245.3	5.13	0.67	3.5
55.0	0.06	4.5	0.35	267.0	5.14	0.72	3.7
50.0	0.05	4.4	0.36	260.1	5.14	0.69	3.5
45.0	0.05	5.2	0.49	180.8	5.13	0.82	4.2
42.5	0.04	5.2	0.54	155.7	5.13	0.81	4.2

Table 4.16: Frequency variations and effect on electric parameters for Samsung mobile charger

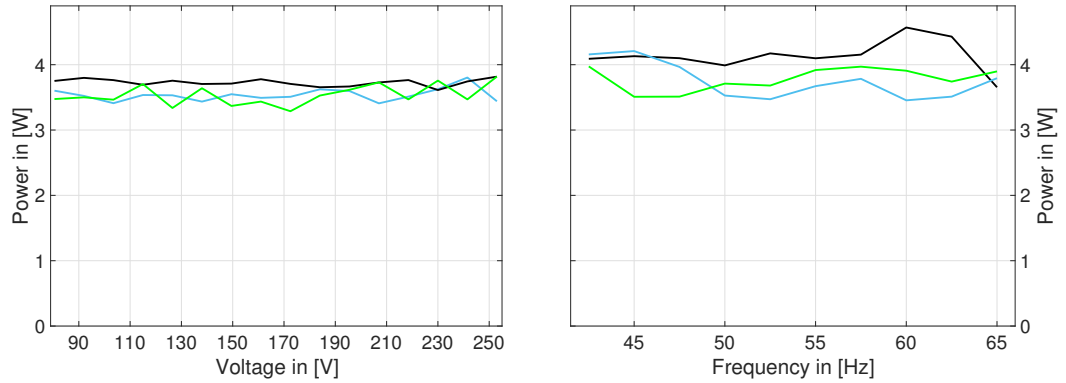

Figure 4.13: Power output dependent on voltage (left) and frequency (right) for three samples of the Samsung mobile charger.

V_{in} [V]	I_{rms} [A]	P_{in} [W]	PF	THD(I) [%] *	V_{out} [V]	I_{out} [A]	P_{out} [W]
253	0.02	2.1	0.41	158.2	4.33	0.29	1.3
229.8	0.02	2.0	0.41	135.0	4.36	0.28	1.2
207	0.02	1.8	0.37	125.7	4.39	0.32	1.4
184	0.03	1.9	0.41	116.8	4.34	0.31	1.3
160.9	0.02	1.7	0.45	108.9	4.22	0.28	1.2
138.1	0.02	1.4	0.47	101.7	4.08	0.24	1.0
115	0.02	1.0	0.42	100.7	3.98	0.19	0.7
92	0.02	0.7	0.48	100.6	3.90	0.11	0.4
80.6	0.01	0.5	0.45	100.9	3.84	0.10	0.4

Table 4.17: Voltage variations and effect on electric parameters for Balaji mobile charger

dent on the supply voltage. It should be mentioned that the 800 mA d.c. output current on the back of the Balaja mobile charger is not nearly met for any of the tested samples and conditions. Frequency deviations from 42.5 Hz to 65 Hz and the recorded electric parameters are listed in table 4.18. The frequency deviations have no mentionable effect on any of the examined electric variables, besides a rise in THD values for the a.c. current. Figure 4.14 (right) illustrates the output power

*The THD values were recorded in a separate experiment under identical testing conditions.

f_{in} [Hz]	I_{rms} [A]	P_{in} [W]	PF	THD(I) [%]	V_{out} [V]	I_{out} [A]	P_{out} [W]
65.0	0.03	2.5	0.34	241.2	4.14	0.43	1.8
60.0	0.03	2.3	0.34	243.3	4.20	0.37	1.6
55.0	0.03	2.6	0.36	225.0	4.08	0.46	1.9
50.0	0.03	2.4	0.36	230.2	4.17	0.40	1.7
45.0	0.03	2.5	0.35	217.9	4.07	0.45	1.8
42.5	0.03	2.5	0.36	210.8	4.02	0.45	1.8

Table 4.18: Frequency variations and effect on electric parameters for Balaji mobile charger

staying almost the same for all conducted frequency experiments. Additional to

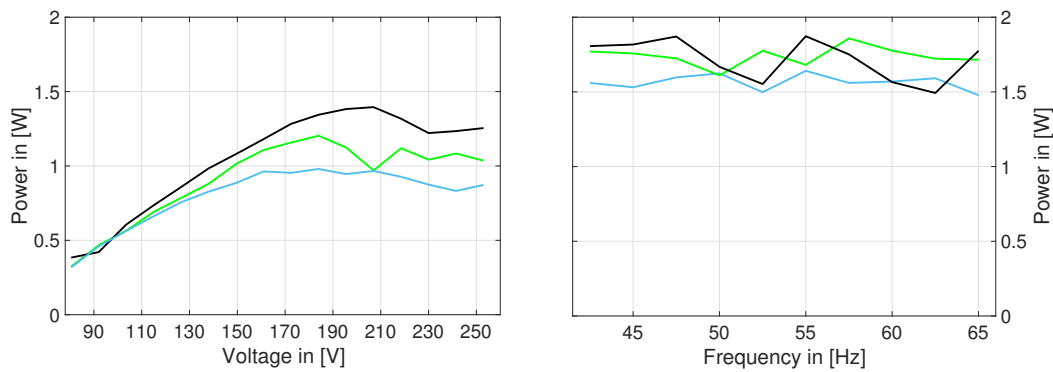

Figure 4.14: Power output dependent on voltage (left) and frequency (right) for three samples of the Balaji mobile charger.

the introduced experiments, some random tests for the two types of mobile chargers were conducted. For that, the frequency inverter, the asynchronous motor and the synchronous generator were used. Unlike the frequency tests from before, the isolation transformer was not deployed to uphold the nominal grid voltage level. The recorded values of these experiments for both charger types from 25 Hz to 40 Hz can be looked up in table 6.17 and 6.20. The results of the previous experiments were manifested by the charging power output of these tests. The Samsung charger is more or less immune to frequency and voltage deviations, even when the supply frequency is down to 25 Hz. When allowing voltage to change with altered frequency, the output power of the Balaji charger decreases as the frequency goes down. However, based on the results from before, this is mainly to blame on the decreasing voltage level, resulting from lower frequencies at the synchronous generator.

In conclusion, only the high quality Samsung charger seems to withstand the exposed variations in voltage. As the Balaji mobile charger will charge mobile phones with less power, the end user is affected when voltage deviations below nominal voltage occur, because it will take longer to charge the phone. The frequency variations on the other hand had no significant impact on the power output of any type of mobile charger.

4.4.5 TVs

The CRT TV was tested based on the question whether it would still work under certain voltage and frequency conditions. The electric parameters at varying supply voltage from 57.6 V to 253 V are presented in table 4.19. As voltage decreases, the

V_{in} [V]	I_{rms} [A]	P_{in} [W]	PF	THD(I) [%]	Status
253.0	0.24	35.5	0.59	136.1	ok
218.5	0.27	34.2	0.58	137.1	ok
184.0	0.29	31.9	0.61	127.0	ok
149.5	0.32	30.6	0.64	114.9	ok
115.1	0.38	29.4	0.68	102.2	ok
80.6	0.49	28.0	0.71	86.9	ok
57.6	0.66	27.2	0.76	70.8	ok

Table 4.19: Voltage variations and effect on electrical parameters for CRT TV

input current (a.c.) is rising, which is a typical SMPS characteristic. Although the power consumption does decline slightly, the CRT TV was working under all tested conditions. Even at 57.6 V, the TV was functioning just fine. Besides these findings, when lowering the supply voltage level, the power factor increased at the same time as the THD for the a.c. current fell. Table 4.20 lists all electric variables exposed to frequencies between 42.5 Hz and 65 Hz. When frequency is altered in negative or

f_{in} [Hz]	I_{rms} [A]	P_{in} [W]	PF	THD(I) [%]	Status
65.0	0.23	33.3	0.64	109.1	ok
60.0	0.24	33.7	0.62	114.0	ok
55.0	0.24	33.6	0.61	117.7	ok
50.0	0.25	33.8	0.59	129.4	ok
45.0	0.22	33.3	0.67	101.4	ok
42.5	0.21	32.8	0.67	99.4	ok

Table 4.20: Frequency variations and effect on electrical parameters for CRT TV

positive direction of the nominal frequency, the consequence is a rising power factor and falling THD values for the input current. Besides that, no mentionable impact on the electrical parameters of the CRT TV were found. The power consumption stays about the same and the TV was working under every applied frequency. The voltage variations for the LED TV and their effect on the electric parameters are presented in table 4.21. The LED TV by Aamaz showed typical SMPS behavior. The decreasing voltage supply is countered with rising a.c. currents, upholding the power consumption at around 11 W. The output voltage and current seem to be completely independent of voltage variations and the output power supply for the TV stays in the range between 11.9 W and 12.0 W. Table 4.22 lists the electrical parameters of the LED TV exposed to frequency variations between 42.5 Hz and 65 Hz. It is noticeable that, although the power consumption and output power are not affected by the frequency deviations, the a.c. current varies relatively strong, especially compared to previous examinations of electrical appliances. The highest THD value for the input current occurred at 50 Hz, which also is the nominal grid

V_{in} [V]	I_{rms} [A]	P_{in} [W]	PF	THD(I) [%]	V_{out} [V]	I_{out} [A]	P_{out} [W]
253.0	0.08	11.1	0.51	156.3	12.33	0.96	11.9
230.0	0.09	11.0	0.51	155.2	12.34	0.97	12.0
206.8	0.10	11.0	0.53	152.2	12.34	0.96	11.9
184.1	0.11	10.8	0.54	149.5	12.34	0.96	11.9
160.9	0.12	10.7	0.55	147.0	12.34	0.96	11.9
138.1	0.13	10.8	0.57	141.0	12.34	0.96	11.9
115.1	0.16	10.8	0.59	133.9	12.35	0.96	11.9
103.7	0.17	10.8	0.59	132.5	12.35	0.96	11.9

Table 4.21: Voltage variations and effect on electric parameters for LED TV

f_{in} [Hz]	I_{rms} [A]	P_{in} [W]	PF	THD(I) [%]	V_{out} [V]	I_{out} [A]	P_{out} [W]
65.0	0.10	11.3	0.47	184.7	12.34	0.96	11.9
60.0	0.11	11.4	0.45	193.5	12.34	0.96	11.9
55.0	0.11	11.4	0.43	211.2	12.34	0.96	11.9
50.0	0.12	11.4	0.42	217.8	12.34	0.96	11.9
45.0	0.08	11.3	0.56	142.3	12.34	0.97	11.9
42.5	0.08	11.2	0.56	143.8	12.34	0.97	12.0

Table 4.22: Frequency variations and effect on electric parameters for LED TV

frequency. The voltage and frequency variations for the LED TV are displayed on the left and right side of figure 4.15. Similar to the mobile chargers, additional tests

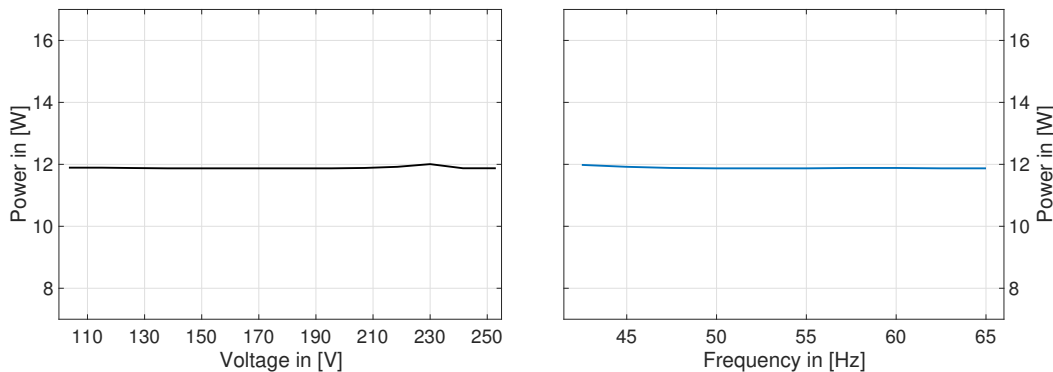

Figure 4.15: Power dependent on voltage (left) and frequency (right) for a LED TV.

for frequency deviations without a isolation transformer were conducted for the LED TV. The results are listed in table 6.25. Independent of frequency or voltage, the output power was not mentionable affected by these experiments. Even at 25 Hz and a supply voltage of 94.4 V the output power adds up to 11.8 W, which is 0.1 W below the measured output power for the isolated experiments with a voltage at 253 V and frequency at 65 Hz. In conclusion, both TV's did function perfectly under the varying voltage and frequency experiments. No impact on the consumer besides slightly lower power consumption for the CRT TV when operated at lower supply voltages were found.

4.5 Summary

All electric loads from a resistive type were affected the most by voltage variations. Incandescent lightbulbs will illuminate the room to a lesser degree and both water and rice cookers will take longer to boil water when the supply voltage decreases. This has a negative impact on the consumer, especially in off grid locations, as the voltage level can deviate extremely in negative direction of the nominal voltage for long durations. Further, the power consumption of all resistive appliances decreased when the supply voltage dropped. As the residents in off grid locations often pay a fix price for electricity every month, the lower power consumption will not even benefit the consumers in a financial way. The THD values for the resistive loads a.c. current were kept at a low level for voltage and frequency deviations. Frequency deviations for the resistive loads had no mentionable impact on any of the examined parameters.

The CFL lamp showed the same behavior to voltage deviations, as the end user will have less illuminated rooms when deploying CFL lamps, although the illumination was still of more than factor ten higher than the incandescent lightbulbs at 115 V. Frequency variations had no significant impact on any electric parameter of the CFL lamps, besides fluctuation in the TDH value of the input current. The appliances with SMPS - behavior were immune to voltage and frequency variations in terms of their output parameter. The LED lamps will stay at a certain illumination level and the TVs will function the same way as operated at nominal grid voltage and frequency. Further following discovery was made. The higher the voltage supply for the SMPS appliances, the lower the power factor gets and higher THD values occur. As mentioned before these high THD values can have a negative impact on the sine wave form of the power system [43]. Inductive loads with motors can be stressed by high THD values. This can cause overheated windings, which result in a shorter life expectancy for these applications.

Chapter 5

Conclusion

5.1 Critical reflection and experiences

As this thesis has a big share of practical work in the field, this section shall provide a critical reflection on the achieved. A big amount of measurement devices has the advantage, that all recordings can be verified with additional data. However, it also means more data editing and analysis. Besides that, throughout the one week measurements, all of the devices frequently have to be managed. The multimeter recording of the Voltcraft VC 820-1 for instance had to be split up into seven one day measurements for every location, as the device would hang up and display the exact same values after about 1.5 days. The Chauvin Arnoux 8336 (see 4.1.4), which is used for the testing of the electrical appliances could replace all five recording devices. This would provide more detailed electrical parameters like THD values of the power system without additional editing work. Due to financial limitations and as the device is reserved for other purposes, this approach could not be realized.

The voltage and frequency experiments conducted in chapter 4 show a clear trend of how different electrical appliances react to variations of these parameters. Some of them were tested with three samples to reduce the impact of production fluctuations. Nevertheless, they do not represent a significant study. Also, most of the tested appliances have been exposed to variations for a duration of one minute. It was not tested how they behave to deviations of significantly longer durations.

5.2 Summary

Power quality data in on and off grid locations was recorded and analyzed in the course of this thesis. The Nepali on grid locations Kathmandu and Pokhara revealed stable voltage and frequency levels but are still far away from the results measured in Munich. Both places featured higher deviations of the expected value from nominal voltage and frequency and had higher σ values, which indicates more variance in voltage and frequency levels. More importantly, the recordings in both places featured sustained interruptions, which still has to be improved to provide a reliable energy supply for the private and business sector. The sine wave recordings showed less harmonic distortions than Munich, which could be explained by a expected higher share of SMPS devices in Germany.

Both of the off grid locations in Nepal revealed poor power quality, as many interruptions occurred in both locations. Furthermore, the expected values deviated extremely from the nominal voltage and frequency. The bad power quality resulted in a high count of electromagnetic phenomena in both places. For a significant time of the measurement, voltage and frequency deviation were of too high magnitude or length to be recognized by the IEEE standards for power quality monitoring. It speaks for itself that new valuation criteria had to be introduced to quantify those deviations. The signal quality of the sine wave recordings in the off grid places was acceptable, compared to the frequency and voltage deviations.

A data logger, based on the Arduino microprocessor was built and recorded voltage and frequency to a more than satisfactory degree under extreme poor power quality conditions. The device could help measuring power quality in developing countries with manageable effort and costs.

Based on the results of the power quality measurements, a range of electrical appliances were investigated under isolated voltage and frequency variation. The experiments showed that resistive appliances were affected the most. With lower voltages, the power consumption fell and the output parameters suffered in the following ways: The illumination of incandescent lightbulbs decreased extremely and both water and rice cookers took longer to boil water, which obviously affects the end user in a negative way. A CFL lamp showed similar behavior, as the illumination almost decreased by factor four. However it still offered a ten times higher illumination level than the incandescent lightbulb. The tested switch mode power supply appliances showed resistant behavior when voltage was altered. The output power stayed about the same for the tested mobile chargers and the LED TV. The LED lamps showed almost constant illumination level independent of voltage level. The tested CRT TV did also function over all tested voltage ranges. However all of the SMPS loads revealed extremely high values for THD, which increased with higher voltage values. This will not have an direct impact on the consumer, however they can impose harmonics on the supply system, which can result in overheated windings in inductive appliances. As a consequence, loads like fans or washing machines can have shorter life expectancy. None of the tested appliances were affected by frequency variations in a significant way, besides SMPS appliances having high THD values for deviations in positive and negative direction of the nominal frequency.

5.3 Prospect

This section will introduce an outlook for possible future work.

The stiffness of the electrical grid could be investigated in detail as a further index of power quality. For instance, the effect of a bigger power plant being switched off and on to the power system could be examined. The assumption would be, that the lesser the impact of these actions, the more stable the power system is. As mentioned before, it would be interesting to gather data on THD for all measurement locations.

The self-built and low cost data logger proved its functionality to record both grid voltage and frequency even under extreme deviations in both parameters. However, as it is still a prototype, the following things could be improved:

The device could be designed in a more compact way and the electrical contacts should be exchanged with more tear resistant ones, as transportation of the data logger can lead to damaged components. Further, a implemented display would help to check, if the values are being recorded.

As for the tested electrical appliances, a range of more devices would be of big interest. Inductive appliances with built-in motors, like refrigerators or washing machines with bigger power consumption could be exposed to voltage and frequency variations. Further, experiments with laptop chargers could be conducted with typical laptop appliances in Nepal.

The supply voltage output of the synchronous generator for the frequency experiments had high THD values, which could be countered with line filters connected before the examined appliances. Even lower deviations in negative direction of the grid frequency would be interesting to impose on the electrical loads, as these were often found in the off grid locations in Nepal. Voltage and frequency impact on electrical appliances were tested isolated from each other. A testing setup featuring a possible way of altering the sine wave form to examine the effect on the electrical appliances isolated from the frequency and voltage, could complete the three introduced power quality criteria. Furthermore, all three power quality criteria could be altered at the same time, to simulate a more actual power system environment.

Chapter 6

Appendix

V_{in} [V]	I_{rms} [A]	P_{in} [W]	PF	THD(I) [%]	$E(V)$ [Lux]
252.8	0.25	62.6	1.0	1.5	1605
241.3	0.24	58.4	1.0	1.4	1370
230.0	0.24	54.5	1.0	1.4	1140
218.7	0.23	50.5	1.0	1.4	947
207.2	0.22	46.6	1.0	1.4	768
195.4	0.22	42.6	1.0	1.4	610
184.2	0.21	39.0	1.0	1.4	482
172.5	0.20	35.1	1.0	1.5	367
161.1	0.20	31.9	1.0	1.3	272
149.7	0.19	28.6	1.0	1.3	199
138.0	0.18	25.3	1.0	1.3	138
126.5	0.18	22.3	1.0	1.3	92
115.1	0.17	19.4	1.0	1.3	58

Table 6.1: Voltage variations and effect on electrical parameters for an incandescent lightbulb.

f_{in} [Hz]	I_{rms} [A]	P_{in} [W]	PF	THD(I) [%]	$E(f)$ [Lux]
65.0	0.24	55.4	1.0	9.4	1465
62.5	0.24	55.4	1.0	9.2	1464
60.0	0.24	55.3	1.0	9.0	1463
57.5	0.24	55.4	1.0	8.8	1463
55.0	0.24	55.3	1.0	8.7	1463
52.5	0.24	55.3	1.0	8.5	1461
50.0	0.24	55.3	1.0	8.4	1455
47.5	0.24	55.3	1.0	7.7	1455
45.0	0.24	55.2	1.0	6.9	1449
42.5	0.24	55.2	1.0	7.0	1447

Table 6.2: Frequency variations and effect on electrical parameters for an incandescent lightbulb.

V_{in} [V]	I_{rms} [A]	P_{in} [W]	PF	THD(I) [%]	$E(V)$ [Lux]
253.1	0.087	14.0	0.63	109.7	1948
241.5	0.086	13.4	0.64	106.9	1869
230.0	0.086	12.7	0.64	104.8	1796
218.4	0.089	12.3	0.64	105.1	1778
206.9	0.087	11.6	0.65	102.4	1669
195.4	0.088	11.1	0.64	101.7	1589
184.2	0.089	10.6	0.64	100.8	1505
172.4	0.090	10.0	0.64	99.5	1404
161.1	0.090	9.4	0.65	96.5	1299
149.5	0.090	8.8	0.66	93.7	1176
138.0	0.089	8.2	0.66	88.9	1040
126.5	0.088	7.5	0.67	85.3	890
115.2	0.087	6.8	0.68	80.9	732

Table 6.3: Voltage variations and effect on electrical parameters for a CFL lamp.

f_{in} [Hz]	I_{rms} [A]	P_{in} [W]	PF	THD(I) [%]	$E(f)$ [Lux]
65.0	0.09	12.8	0.59	133.2	1795
62.5	0.10	12.9	0.57	135.8	1798
60.0	0.10	12.9	0.57	135.3	1792
57.5	0.10	13.0	0.55	142.4	1802
55.0	0.10	13.1	0.55	150.3	1804
52.5	0.11	13.2	0.53	157.1	1808
50.0	0.11	13.3	0.51	170.8	1814
47.5	0.10	13.0	0.57	144.7	1800
45.0	0.10	12.7	0.57	135.8	1779
42.5	0.09	12.6	0.58	132.0	1774

Table 6.4: Frequency variations and effect on electrical parameters for a CFL lamp.

V_{in} [V]	I_{rms} [A]	P_{in} [W]	PF	THD(I) [%]	$E(V)$ [Lux]
253.1	0.04	4.6	0.48	177.7	919
241.4	0.04	4.6	0.49	171.7	918
229.7	0.04	4.6	0.53	155.0	916
218.4	0.04	4.6	0.53	151.1	902
206.9	0.04	4.6	0.53	151.5	893
195.5	0.04	4.5	0.53	152.5	887
184.0	0.05	4.5	0.52	154.1	882
172.5	0.05	4.5	0.51	156.2	879
160.9	0.05	4.5	0.52	154.7	876
149.4	0.06	4.5	0.53	146.6	863
138.2	0.06	4.5	0.57	128.9	855
126.4	0.06	4.5	0.58	122.2	850
114.9	0.07	4.5	0.56	125.0	845

Table 6.5: Voltage variations and effect on electrical parameters for a LED lamp by DIVYA.

f_{in} [Hz]	I_{rms} [A]	P_{in} [W]	PF	THD(I) [%]	$E(f)$ [Lux]
65.0	0.06	4.7	0.37	251.5	914
62.5	0.06	4.7	0.36	255.6	905
60.0	0.06	4.7	0.35	262.9	899
57.5	0.06	4.7	0.34	263.6	895
55.0	0.06	4.7	0.33	290.8	872
52.5	0.06	4.7	0.35	257.0	864
50.0	0.06	4.7	0.35	268.1	858
47.5	0.04	4.6	0.50	179.9	855
45.0	0.04	4.6	0.48	184.6	853
42.5	0.04	4.6	0.49	176.4	849

Table 6.6: Frequency variations and effect on electrical parameters for a LED lamp by DIVYA.

V_{in} [V]	I_{rms} [A]	P_{in} [W]	PF	THD(I) [%] *	$E(V)$ [Lux]
253.1	0.04	5.4	0.52	152.7	812
241.4	0.04	5.5	0.53	149.9	803
230.2	0.04	5.4	0.54	145.2	795
218.5	0.05	5.2	0.54	142.9	787
207	0.05	5.2	0.55	140.6	783
195.3	0.05	5.3	0.57	138.0	777
184.1	0.05	5	0.57	135.2	773
172.5	0.05	5	0.59	132.0	769
161.2	0.05	4.9	0.6	128.6	765
149.6	0.06	5	0.62	125.0	760
138	0.06	4.8	0.61	121.3	755
126.4	0.06	4.7	0.62	114.5	754
115.2	0.07	4.7	0.65	109.0	752

Table 6.7: Voltage variations and effect on electrical parameters for SCT LED lamp.

*The THD values were recorded in a separate experiment under identical testing conditions.

f_{in} [Hz]	I_{rms} [A]	P_{in} [W]	PF	THD(I) [%]	$E(f)$ [Lux]
65.0	0.05	4.6	0.44	208.5	728
62.5	0.05	4.6	0.42	213.9	724
60.0	0.05	4.6	0.41	220.4	721
57.5	0.05	4.6	0.40	227.3	720
55.0	0.05	4.6	0.39	248.1	719
52.5	0.05	4.6	0.40	229.0	719
50.0	0.05	4.6	0.40	234.7	719
47.5	0.04	4.5	0.52	172.4	717
45.0	0.04	4.5	0.52	165.9	716
42.5	0.04	4.5	0.54	155.7	716

Table 6.8: Frequency variations and effect on electrical parameters for SCT LED lamp.

V_{in} [V]	I_{rms} [A]	P_{in} [W]	PF	THD(I) [%]	t_{cook} [mm:ss]
253.1	1.28	324.9	1.0	1.38	09:07
241.5	1.23	297.2	1.0	1.38	10:11
230.3	1.16	268.1	1.0	1.46	10:57
218.7	1.11	242.0	1.0	1.42	12:45
207.3	1.05	217.7	1.0	1.42	15:28
195.6	0.99	193.9	1.0	1.47	18:47
184.0	0.93	171.7	1.0	1.55	-
172.5	0.88	151.2	1.0	1.57	-
161.1	0.82	131.8	1.0	1.59	-

Table 6.9: Voltage variations and effect on electrical parameters for water boiler.

f_{in} [Hz]	I_{rms} [A]	P_{in} [W]	PF	THD(I) [%]	t_{cook} [mm:ss]
65.0	1.17	270.2	1.00	11.2	10:42
62.5	1.17	270.0	1.00	10.8	10:52
60.0	1.17	269.6	1.00	10.3	10:29
57.5	1.17	269.7	1.00	9.9	11:08
55.0	1.17	269.9	1.00	9.4	11:06
52.5	1.17	269.3	1.00	8.9	11:12
50.0	1.17	269.2	1.00	8.4	10:56
47.5	1.17	269.0	1.00	7.1	11:19
45.0	1.17	268.8	1.00	6.5	11:20
42.5	1.17	267.9	1.00	6.5	11:17

Table 6.10: Frequency variations and effect on electrical parameters for water boiler.

V_{in} [V]	I_{rms} [A]	P_{in} [W]	PF	THD(I) [%]	t_{cook} [mm:ss]
252.9	1.33	337.1	1.0	1.39	09:49.87
241.5	1.27	307.5	1.0	1.34	10:23.64
230.1	1.20	277.2	1.0	1.55	11:43.89
218.5	1.15	250.3	1.0	1.59	13:10.42
207.0	1.09	224.8	1.0	1.49	14:42.92
195.5	1.03	200.6	1.0	1.55	16:06.31
184.0	0.97	177.8	1.0	1.55	18:23.04
172.5	0.91	156.2	1.0	1.59	21:05.99
162.0	0.86	138.5	1.0	1.39	24:47.70
149.5	0.79	118.1	1.0	1.39	31:13.72

Table 6.11: Voltage variations and effect on electrical parameters for a 300 W rice cooker.

f_{in} [Hz]	I_{rms} [A]	P_{in} [W]	PF	THD(I) [%]	t_{cook} [mm:ss]
65.0	1.22	280.2	1.00	11.2	11:08
62.5	1.21	279.0	1.00	10.9	11:09
60.0	1.21	279.4	1.00	10.4	11:15
57.5	1.21	278.9	1.00	9.9	11:07
55.0	1.21	279.1	1.00	9.5	11:23
52.5	1.21	278.9	1.00	9.0	12:03
50.0	1.21	278.7	1.00	8.6	11:05
47.5	1.21	278.8	1.00	7.2	11:16
45.0	1.21	278.5	1.00	6.5	11:13
42.5	1.21	277.3	1.00	6.5	11:30

Table 6.12: Frequency variations and effect on electrical parameters for a 300 W rice cooker.

V_{in} [V]	I_{rms} [A]	P_{in} [W]	PF	THD(I) [%]	t_{cook} [mm:ss]
253.1	2.65	671.0	1	1.4	08:52
241.6	2.54	613.0	1	1.4	09:17
230.0	2.40	551.0	1	1.4	11:03
218.7	2.28	498.8	1	1.6	11:32
207.2	2.16	448.4	1	1.6	13:06
195.5	2.04	399.5	1	1.5	14:35
184.0	1.92	354.1	1	1.6	15:29
172.6	1.81	311.6	1	1.6	18:59
160.9	1.68	270.9	1	1.6	22:00
149.6	1.57	234.2	1	1.6	25:11
138.1	1.44	199.5	1	1.7	30:49
126.5	1.32	167.4	1	1.6	38:22

Table 6.13: Voltage variations and effect on electrical parameters for a 700 W rice cooker.

f_{in} [Hz]	I_{rms} [A]	P_{in} [W]	PF	THD(I) [%]	t_{cook} [mm:ss]
65.0	2.42	556.3	1	13.3	09:33
62.5	2.42	557.2	1	13.6	09:26
60.0	2.42	557.1	1	12.8	09:22
57.5	2.42	557.4	1	11.9	09:27
55.0	2.42	556.9	1	10.9	09:25
52.5	2.42	557.7	1	10.0	09:30
50.0	2.42	555.8	1	8.8	09:20
47.5	2.41	555.7	1	7.6	09:44
45.0	2.41	554.2	1	7.3	09:25

Table 6.14: Frequency variations and effect on electrical parameters for a 700 W rice cooker.

V_{in} [V]	I_{rms} [A]	P_{in} [W]	PF	THD(I) [%]	V_{out} [V]	I_{out} [A]	P_{out} [W]
253.1	0.03	4.0	0.49	173.6	5.13	0.67	3.4
241.4	0.04	4.7	0.51	165.0	5.13	0.74	3.8
230.0	0.04	4.1	0.51	169.2	5.14	0.71	3.6
218.5	0.04	4.1	0.51	166.5	5.14	0.68	3.5
206.9	0.04	4.0	0.52	164.4	5.14	0.66	3.4
195.5	0.04	4.3	0.53	159.1	5.14	0.70	3.6
183.8	0.04	4.3	0.54	156.2	5.14	0.71	3.6
172.4	0.04	4.2	0.54	155.3	5.14	0.68	3.5
161.0	0.05	4.1	0.54	153.9	5.14	0.68	3.5
149.4	0.05	4.4	0.55	150.8	5.14	0.69	3.5
137.9	0.05	3.7	0.55	147.8	5.14	0.67	3.4
126.5	0.06	4.2	0.56	144.9	5.13	0.69	3.5
114.9	0.06	3.9	0.56	142.2	5.13	0.69	3.5
103.5	0.06	3.9	0.58	136.5	5.13	0.67	3.4
91.9	0.08	4.3	0.59	128.5	5.13	0.69	3.5
80.6	0.09	4.3	0.61	121.6	5.12	0.70	3.6

Table 6.15: Voltage variations and effect on electrical parameters for Samsung mobile charger.

f_{in} [Hz]	I_{rms} [A]	P_{in} [W]	PF	THD(I) [%]	V_{out} [V]	I_{out} [A]	P_{out} [W]
65.0	0.05	4.8	0.39	231.0	5.13	0.74	3.8
62.5	0.05	4.3	0.37	239.8	5.13	0.68	3.5
60.0	0.05	4.3	0.37	245.3	5.13	0.67	3.5
57.5	0.06	4.6	0.37	243.9	5.13	0.74	3.8
55.0	0.06	4.5	0.35	267.0	5.14	0.72	3.7
52.5	0.05	4.3	0.36	253.7	5.14	0.68	3.5
50.0	0.05	4.4	0.36	260.1	5.14	0.69	3.5
47.5	0.05	4.8	0.46	198.3	5.14	0.77	4.0
45.0	0.05	5.2	0.49	180.8	5.13	0.82	4.2
42.5	0.04	5.2	0.54	155.7	5.13	0.81	4.2

Table 6.16: Frequency variations and effect on electrical parameters for Samsung mobile charger.

V_{in} [V]	f_{in} [Hz]	I_{rms} [A]	P_{in} [W]	PF	V_{out} [V]	I_{out} [A]	P_{out} [W]
190.4	40.0	0.06	5.8	0.52	5	0.97	4.9
58.8	35.0	0.07	6.3	0.55	4.97	0.98	4.9
127.4	30.0	0.10	6.7	0.52	4.96	1.03	5.1
94.5	25.0	0.11	6.2	0.62	4.97	1.00	5.0

Table 6.17: Frequency and voltage variations and their effect on electrical parameters for Samsung mobile charger.

V_{in} [V]	I_{rms} [A]	P_{in} [W]	PF	THD(I) [%] *	V_{out} [V]	I_{out} [A]	P_{out} [W]
253	0.02	2.1	0.41	158.2	4.33	0.29	1.3
241.4	0.02	1.9	0.41	153.0	4.33	0.29	1.2
229.8	0.02	2.0	0.41	135.0	4.36	0.28	1.2
218.6	0.02	1.9	0.39	130.3	4.38	0.30	1.3
207	0.02	1.8	0.37	125.7	4.39	0.32	1.4
195.4	0.03	2.1	0.44	121.6	4.38	0.32	1.4
184	0.03	1.9	0.41	116.8	4.34	0.31	1.3
172.7	0.03	1.8	0.43	112.8	4.26	0.30	1.3
160.9	0.02	1.7	0.45	108.9	4.22	0.28	1.2
149.5	0.02	1.5	0.43	103.8	4.17	0.26	1.1
138.1	0.02	1.4	0.47	101.7	4.08	0.24	1.0
126.3	0.02	1.2	0.51	100.7	4.03	0.21	0.9
115	0.02	1.0	0.42	100.7	3.98	0.19	0.7
103.4	0.02	0.9	0.51	100.6	3.96	0.15	0.6
92	0.02	0.7	0.48	100.6	3.90	0.11	0.4
80.6	0.01	0.5	0.45	100.9	3.84	0.10	0.4

Table 6.18: Voltage variations and effect on electrical parameters for Balaji mobile charger.

*The THD values were recorded in a separate experiment under identical testing conditions.

f_{in} [Hz]	I_{rms} [A]	P_{in} [W]	PF	THD(I) [%]	V_{out} [V]	I_{out} [A]	P_{out} [W]
65.0	0.03	2.5	0.34	241.2	4.14	0.43	1.8
62.5	0.03	2.2	0.32	268.5	4.22	0.35	1.5
60.0	0.03	2.3	0.34	243.3	4.20	0.37	1.6
57.5	0.03	2.5	0.35	237.9	4.13	0.42	1.8
55.0	0.03	2.6	0.36	225.0	4.08	0.46	1.9
52.5	0.03	2.2	0.35	236.9	4.20	0.37	1.6
50.0	0.03	2.4	0.36	230.2	4.17	0.40	1.7
47.5	0.03	2.6	0.35	222.9	4.05	0.46	1.9
45.0	0.03	2.5	0.35	217.9	4.07	0.45	1.8
42.5	0.03	2.5	0.36	210.8	4.02	0.45	1.8

Table 6.19: Frequency variations and effect on electrical parameters for Balaji mobile charger.

V_{in} [V]	f_{in} [Hz]	I_{rms} [A]	P_{in} [W]	PF	V_{out} [V]	I_{out} [A]	P_{out} [W]
190.4	40.0	0.02	2.0	0.41	4.01	0.36	1.5
158.8	35.0	0.02	1.4	0.43	3.94	0.27	1.1
127.4	30.0	0.02	0.9	0.46	3.65	0.19	0.7
94.5	25.0	0.01	0.6	0.54	3.23	0.12	0.4

Table 6.20: Frequency and voltage variations and their effect on electrical parameters for Balaji mobile charger.

V_{in} [V]	I_{rms} [A]	P_{in} [W]	PF	THD(I) [%]	Status
253.0	0.24	35.5	0.59	136.1	ok
241.2	0.25	35.1	0.59	135.3	ok
230.1	0.25	34.2	0.59	135.1	ok
218.5	0.27	34.2	0.58	137.1	ok
207.1	0.27	33.2	0.59	133.9	ok
195.5	0.28	32.5	0.60	131.9	ok
184.0	0.29	31.9	0.61	127.0	ok
172.5	0.30	31.6	0.62	123.7	ok
161.0	0.30	30.8	0.63	118.7	ok
149.5	0.32	30.6	0.64	114.9	ok
138.1	0.34	30.4	0.66	110.7	ok
126.4	0.36	29.9	0.67	106.8	ok
115.1	0.38	29.4	0.68	102.2	ok
103.6	0.42	29.8	0.69	98.2	ok
92.2	0.42	27.3	0.70	92.0	ok
80.6	0.49	28.0	0.71	86.9	ok
69.3	0.55	27.8	0.75	79.9	ok
57.6	0.66	27.2	0.76	70.8	ok

Table 6.21: Voltage variations and effect on electrical parameters for CRT TV.

f_{in} [Hz]	I_{rms} [A]	P_{in} [W]	PF	THD(I) [%]	Status
65.0	0.23	33.3	0.64	109.1	ok
62.5	0.23	33.8	0.63	111.4	ok
60.0	0.24	33.7	0.62	114.0	ok
57.5	0.24	33.9	0.61	115.3	ok
55.0	0.24	33.6	0.61	117.7	ok
52.5	0.25	33.8	0.60	120.6	ok
50.0	0.25	33.8	0.59	129.4	ok
47.5	0.24	33.9	0.61	123.9	ok
45.0	0.22	33.3	0.67	101.4	ok
42.5	0.21	32.8	0.67	99.4	ok

Table 6.22: Frequency variations and effect on electrical parameters for CRT TV.

V_{in} [V]	I_{rms} [A]	P_{in} [W]	PF	THD(I) [%]	V_{out} [V]	I_{out} [A]	P_{out} [W]
253.0	0.08	11.1	0.51	156.3	12.33	0.96	11.9
241.5	0.09	11.1	0.51	155.8	12.33	0.96	11.9
230.0	0.09	11.0	0.51	155.2	12.34	0.97	12.0
218.7	0.10	11.3	0.52	152.9	12.34	0.97	11.9
206.8	0.10	11.0	0.53	152.2	12.34	0.96	11.9
195.4	0.10	10.8	0.53	151.7	12.34	0.96	11.9
184.1	0.11	10.8	0.54	149.5	12.34	0.96	11.9
172.5	0.11	10.7	0.54	148.6	12.34	0.96	11.9
160.9	0.12	10.7	0.55	147.0	12.34	0.96	11.9
149.5	0.13	10.9	0.56	144.6	12.34	0.96	11.9
138.1	0.13	10.8	0.57	141.0	12.34	0.96	11.9
126.5	0.14	10.7	0.58	137.7	12.35	0.96	11.9
115.1	0.16	10.8	0.59	133.9	12.35	0.96	11.9
103.7	0.17	10.8	0.59	132.5	12.35	0.96	11.9

Table 6.23: Voltage variations and effect on electrical parameters for LED TV.

f_{in} [Hz]	I_{rms} [A]	P_{in} [W]	PF	THD(I) [%]	V_{out} [V]	I_{out} [A]	P_{out} [W]
65.0	0.10	11.3	0.47	184.7	12.34	0.96	11.9
62.5	0.10	11.4	0.46	188.4	12.34	0.96	11.9
60.0	0.11	11.4	0.45	193.5	12.34	0.96	11.9
57.5	0.11	11.3	0.44	193.2	12.34	0.96	11.9
55.0	0.11	11.4	0.43	211.2	12.34	0.96	11.9
52.5	0.11	11.4	0.43	207.2	12.34	0.96	11.9
50.0	0.12	11.4	0.42	217.8	12.34	0.96	11.9
47.5	0.10	11.3	0.49	181.5	12.34	0.96	11.9
45.0	0.08	11.3	0.56	142.3	12.34	0.97	11.9
42.5	0.08	11.2	0.56	143.8	12.34	0.97	12.0

Table 6.24: Frequency variations and effect on electrical parameters for LED TV.

V_{in} [V]	f_{in} [Hz]	I_{rms} [A]	P_{in} [W]	PF	V_{out} [V]	I_{out} [A]	P_{out} [W]
190.0	40.0	0.10	11.0	0.55	12.30	0.98	12.0
158.6	35.0	0.12	10.9	0.54	12.31	0.97	11.9
127.3	30.0	0.16	10.9	0.53	12.31	0.97	11.9
94.4	25.0	0.18	10.5	0.60	12.31	0.96	11.8

Table 6.25: Voltage and frequency variations and effect on electrical parameters for LED TV.

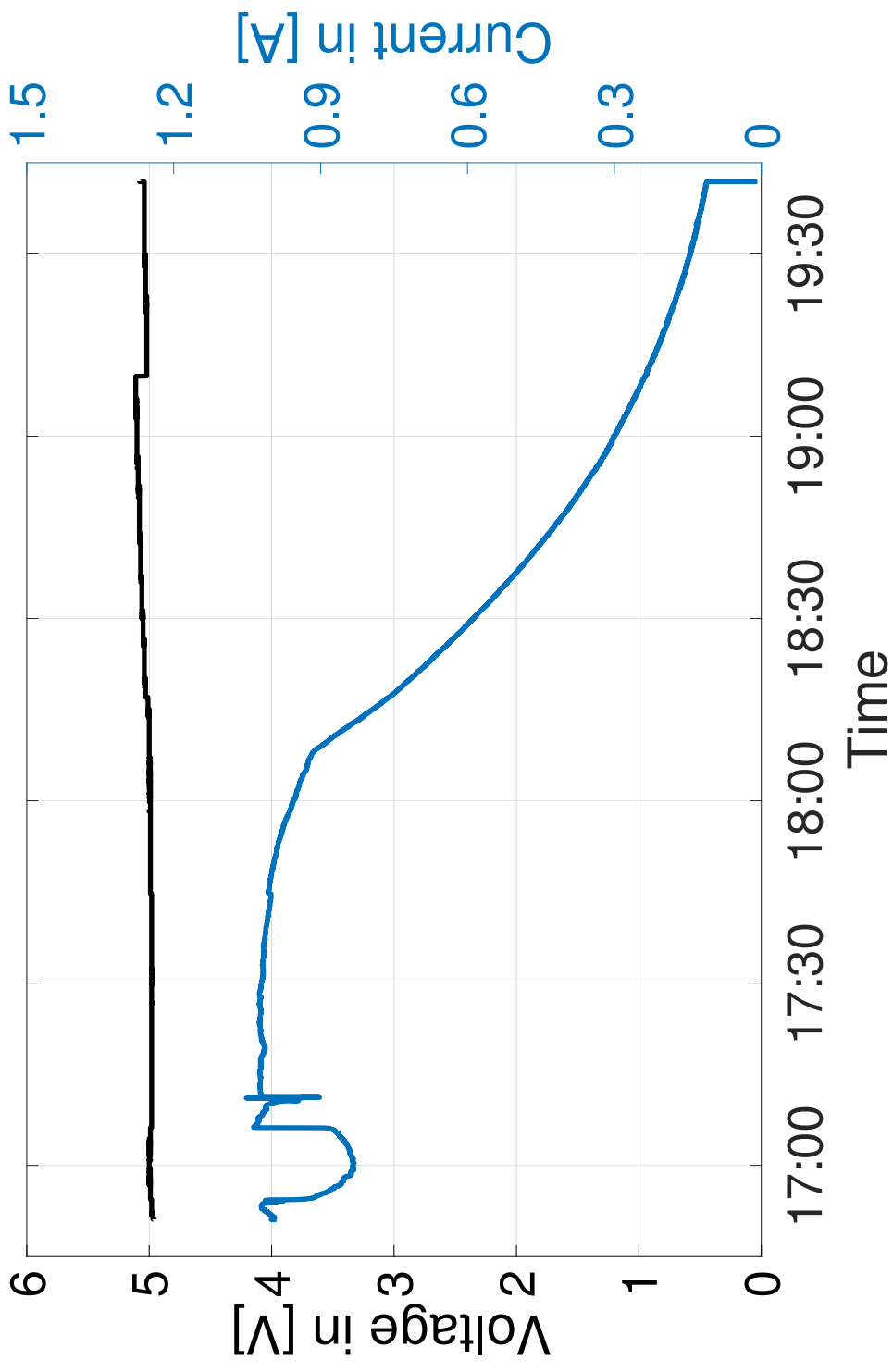

Figure 6.1: Charging voltage and current from Samsung mobile charger for 230 V.

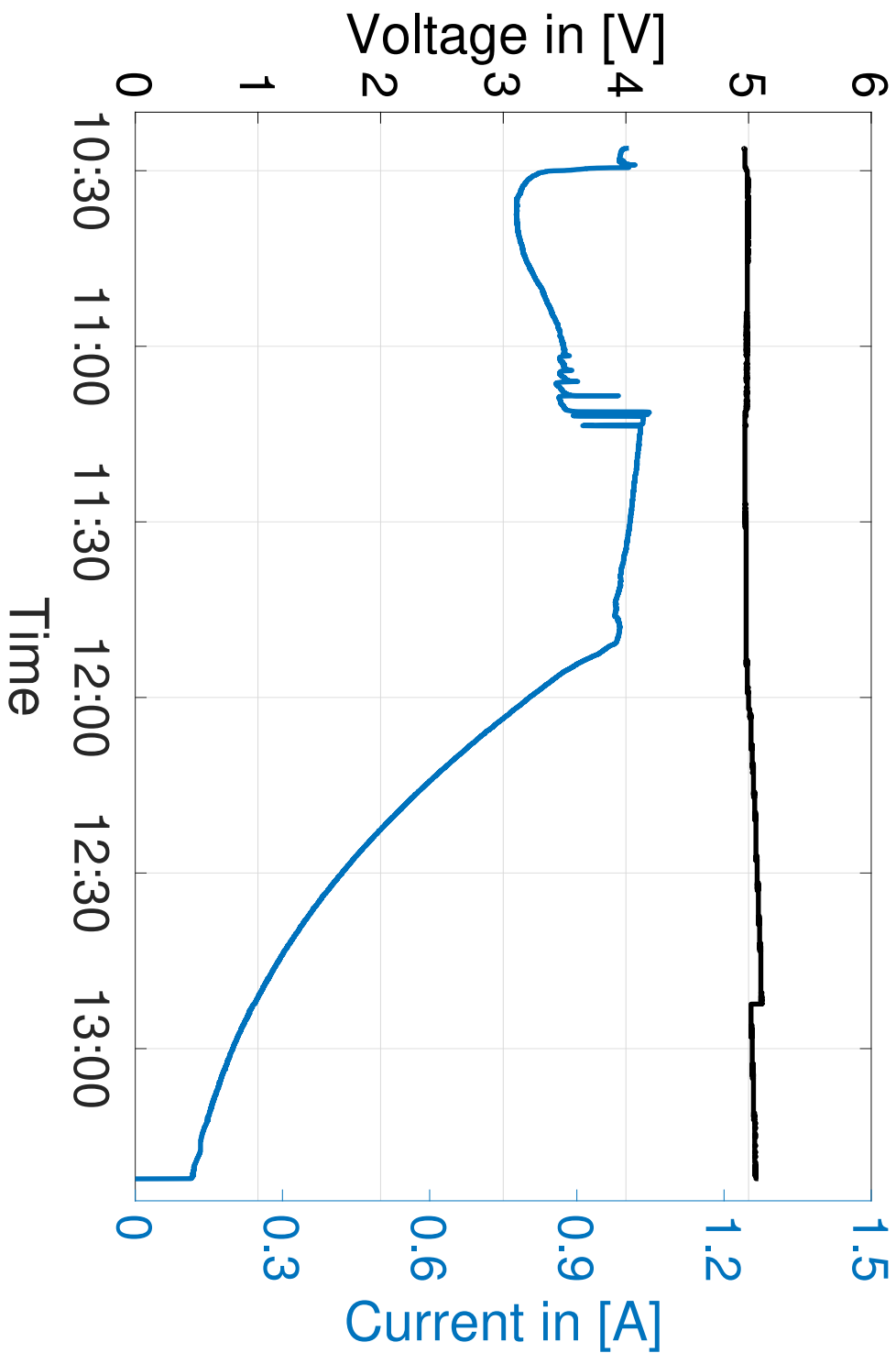

Figure 6.2: Charging voltage and current from Samsung mobile charger for 150 V.

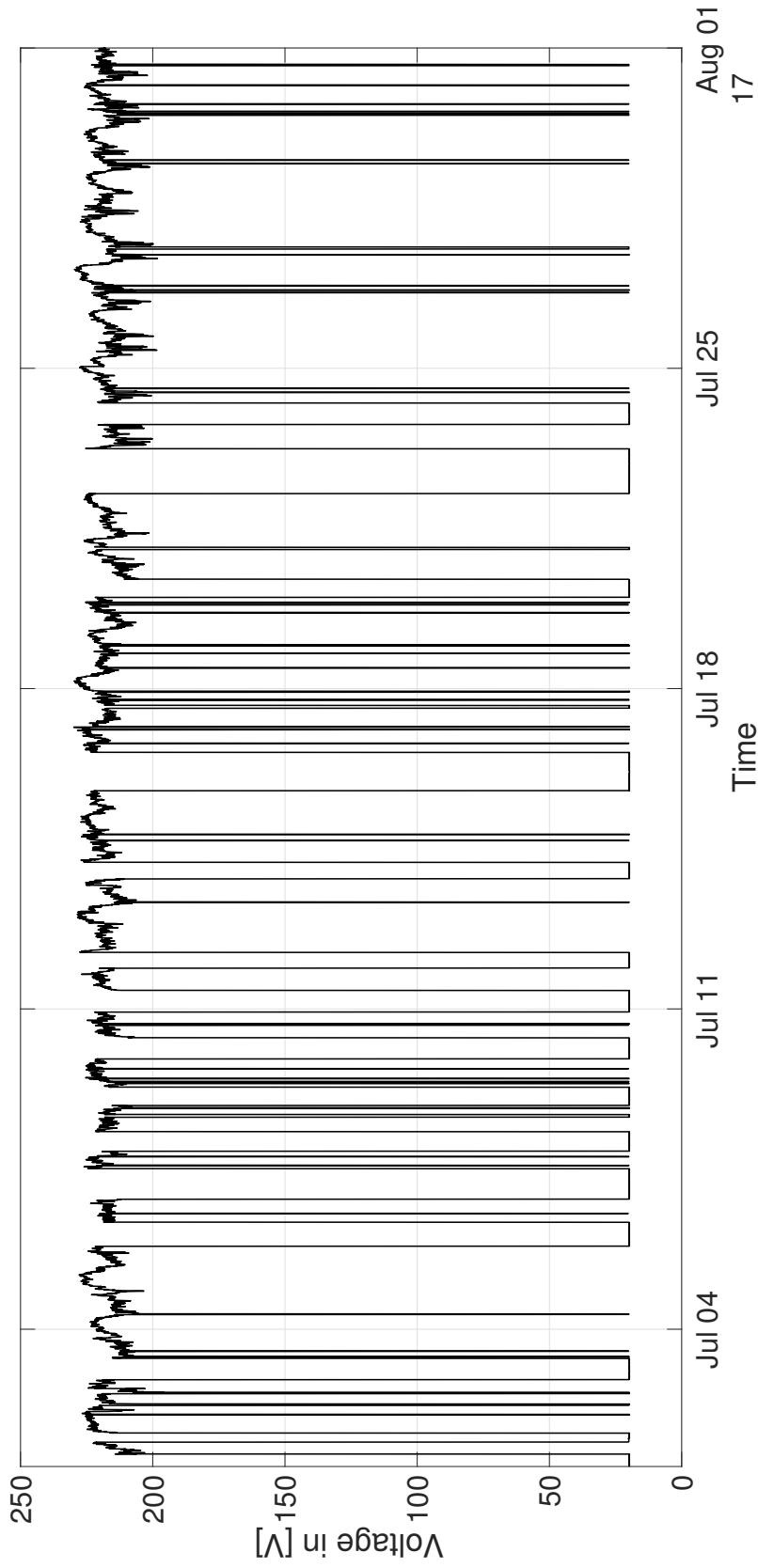

Figure 6.3: One month voltage recording from Pokhara.

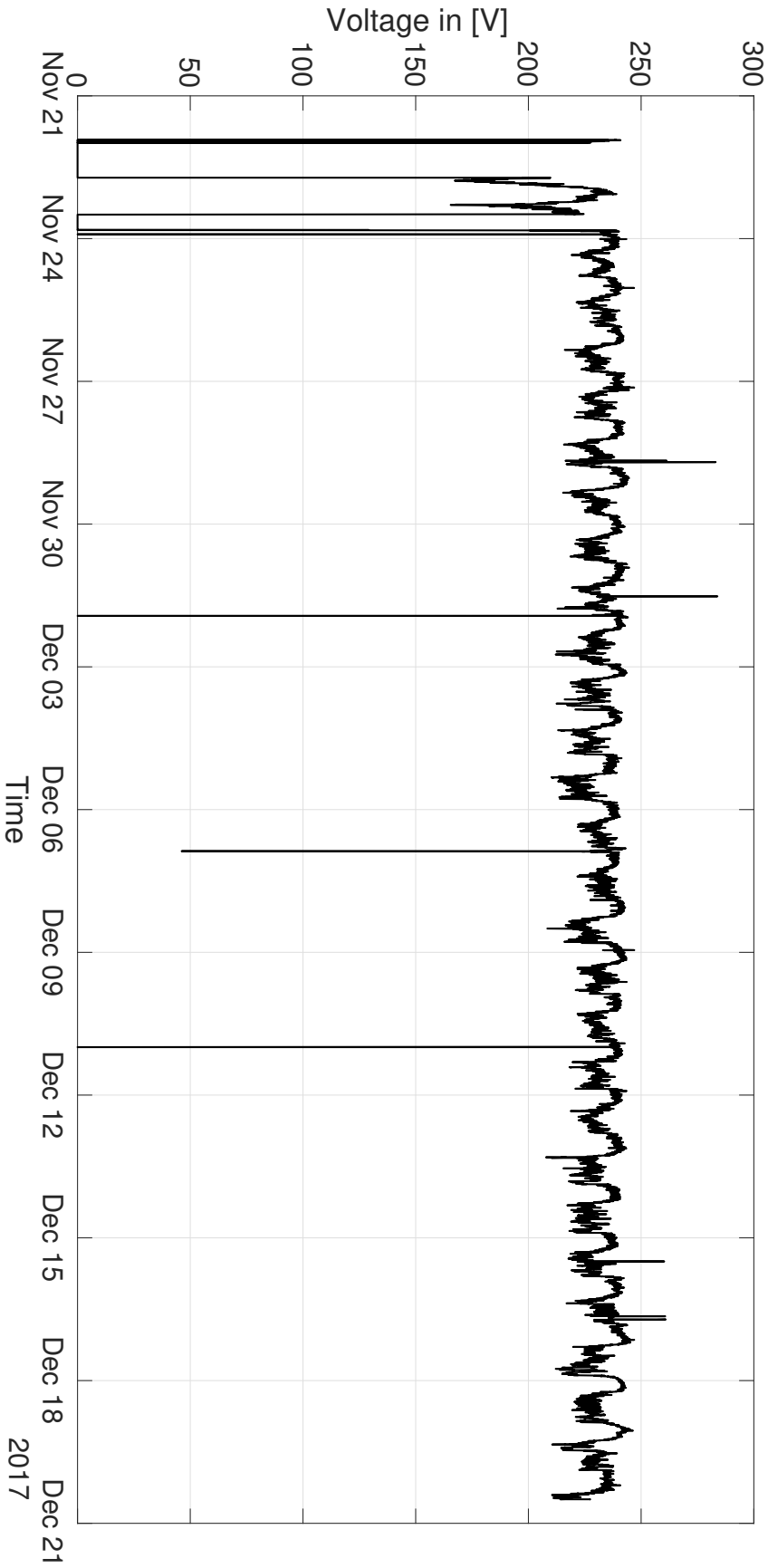

Figure 6.4: Voltage recording from Dhulikel.

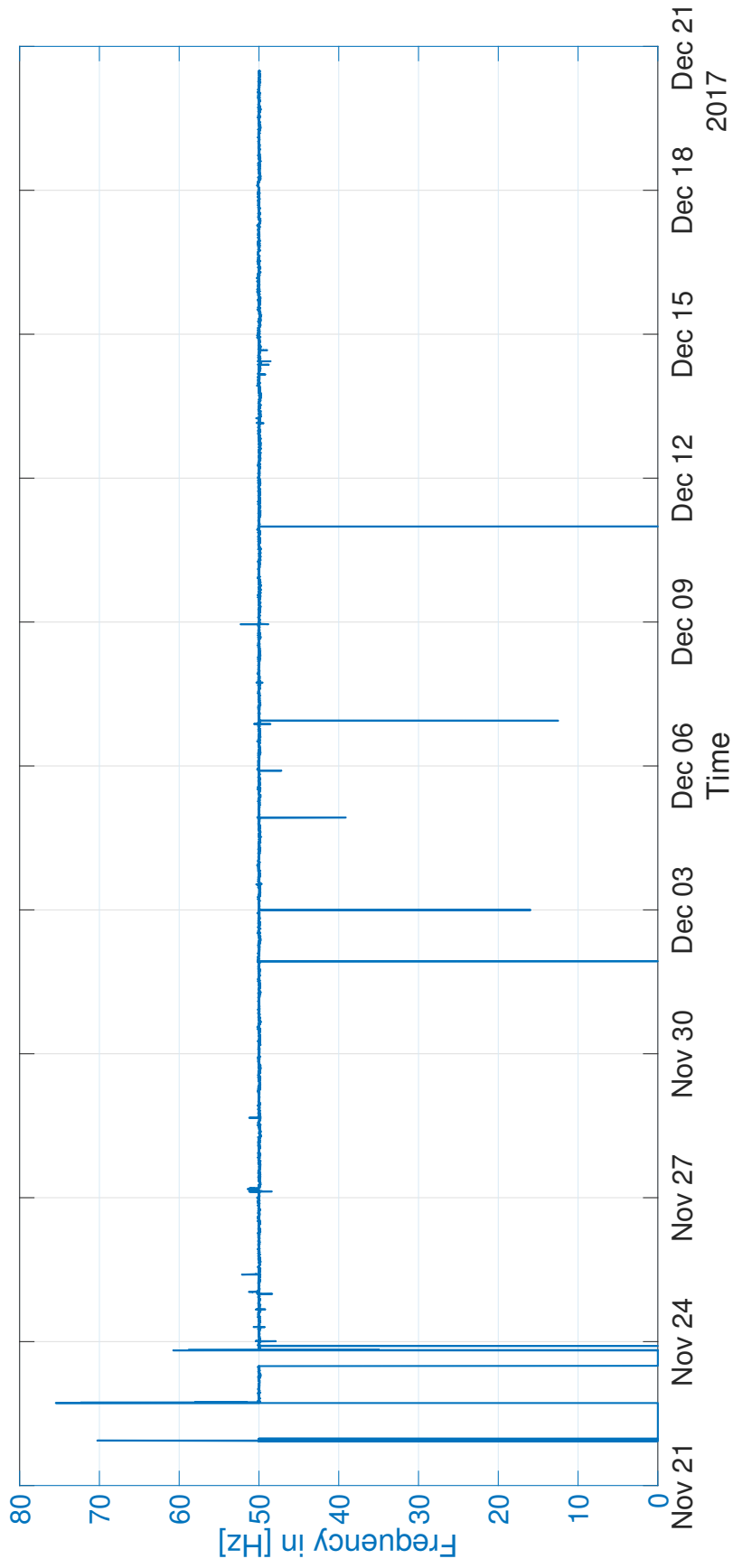

Figure 6.5: Frequency recording from Dhulikel.

Bibliography

- [1] Jan. 2018. URL: <http://hdr.undp.org/en/countries/profiles/NPL> (cit. on pp. 19, 38).
- [2] Feb. 2018. URL: <http://time.com/3837817/nepal-earthquake-economic-business-financial-impact/> (cit. on p. 19).
- [3] Jan. 2018. URL: <https://data.worldbank.org/country/nepal> (cit. on pp. 19, 37–39).
- [4] Feb. 2018. URL: <http://www.worldbank.org/en/news/feature/2015/09/26/ensuring-sustainable-rural-electrification-in-nepal> (cit. on p. 19).
- [5] CDC. “What are the links between power, economic growth and job creation?” In: *Development Impact Evaluation* (2016) (cit. on p. 19).
- [6] Roger C. Dugan. “Electrical Power System Quality”. In: 0-07-138622-X. McGraw - Hill, 2003, pp. 1–7, 15–30, 475 (cit. on pp. 21, 23, 24, 26, 27, 31).
- [7] Alexandra von Meier. “Electric Power Systems”. In: John Wiley & Sons, Inc., 2006, pp. 3–8, 127–136, 250–258 (cit. on pp. 21, 29, 34–36).
- [8] IEEE Power & Energy Society. *IEEE Recommended Practice for Monitoring Electric Power Quality*. Vol. IEEE Std 1159TM-2009. IEEE, 26 June 2009 (cit. on pp. 22, 23, 25, 27).
- [9] Daniel J. Carnovale Thomas M. Blooming. “APPLICATION OF IEEE STD 519-1992 HARMONIC LIMITS”. In: () (cit. on p. 27).
- [10] “Supply Standards: Electricity Supply Standard”. In: Essential Energy, 2011, pp. 6–7 (cit. on p. 28).
- [11] Antoni Klajn Henryk Markiewicz. *Voltage Disturbances*. URL: <http://www.cdtechnics.be/542-standard-en-50160-voltage-characteristics-in.pdf> (cit. on p. 28).
- [12] “Electricity Rules, 2050 (1993)”. In: Government of Nepal, 1993. Chap. 4 (cit. on p. 28).
- [13] Jan. 2018. URL: <http://www.multimeter-vergleich.de/messen/spannung-messen-mit-einem-multimeter/> (cit. on p. 29).
- [14] Jan. 2018. URL: <http://www.multimeter-vergleich.de/messen/strom-messen-mit-einem-multimeter/> (cit. on p. 30).
- [15] Jan. 2018. URL: <http://en-us.fluke.com/training/training-library/test-tools/clamp-meters/types-of-clamp-meters.html> (cit. on p. 30).

- [16] Thomas Muehl. "Elektrische Messtechnik: Grundlagen, Messverfahren, Anwendungen". In: Springer Verlag, 2016, p. 109 (cit. on p. 30).
- [17] Jan. 2018. URL: <http://en-us.fluke.com/training/training-library/test-tools/clamp-meters/inside-hall-effect-clamp-meters.html> (cit. on p. 31).
- [18] Jan. 2018. URL: <https://energy.gov/energysaver/save-electricity-and-fuel/lighting-choices-save-you-money> (cit. on p. 34).
- [19] Jan Carlsson Urban Lundgren Jan Welinder. "Analysis of Electrical Appliance Power Supplies and a Potential Impact on the Electrical Grid Stability". In: (2013) (cit. on pp. 34, 36).
- [20] Durga Sharma Vishwanath Prasad Kurmi Vijay Prakash Gupta. "Impact Of Voltage Variation On Electrical And Electronic Loads And Their Power Consumption". In: *International Journal of Science, Engineering and Technology Research (IJSETR)* Volume 4, Issue 2 (2015) (cit. on p. 35).
- [21] Emre Ozbey Indrit Myderrizi. "A low power multiple output switch-mode power supply with wide input range". In: *Analog Integr Circ Sig Process* (2014) (cit. on p. 36).
- [22] Government of Nepal National Planning commission Secretariat. *2015 STATISTICAL YEAR BOOK NEPAL 2015*. 9789937-0-1707-7. Central Bureau of Statistics, July 2016 (cit. on p. 37).
- [23] Government of Nepal National Planning commission Secretariat. "Nepal in Figures 2016". In: (2016) (cit. on p. 38).
- [24] Jan. 2018. URL: https://www.un.org/development/desa/dpad/wp-content/uploads/sites/45/publication/ldc_list.pdf (cit. on p. 38).
- [25] Jan. 2018. URL: <https://www.un.org/development/desa/dpad/least-developed-country-category.html> (cit. on p. 38).
- [26] Jan. 2018. URL: <http://www.bbc.co.uk/newsround/36129992> (cit. on p. 38).
- [27] Jan. 2018. URL: <http://www.bbc.com/news/world-asia-42126210> (cit. on p. 38).
- [28] Jan. 2018. URL: <http://www.iea.org/statistics/statisticssearch/report/?year=2015&country=NEPAL&product=Indicators> (cit. on pp. 39, 40).
- [29] "Annual Report 2017". In: Nepal Electricity Authority, Aug. 2017, pp. 11–13, 19, 75, 144, 161 (cit. on pp. 40, 67).
- [30] Jan. 2018. URL: <http://www.nea.org.np/aboutus> (cit. on p. 40).
- [31] South Asia Regional Initiative for Energy. *Economic Impact of Poor Power Quality on Industry*. 2003. URL: http://pdf.usaid.gov/pdf_docs/Pnacx076.pdf (cit. on p. 41).
- [32] Anna-Kaarina Seppälä & Stephan Baur & Sudhir Jha & Emmanuel Benjamin. "Simple Regression Model for Energy Demand: Case Study in Rural Areas of Nepal". In: (2018) (cit. on p. 41).

- [33] reichelt.at. Dec. 2017. URL: <https://www.reichelt.at/Multimeter-digital/UT-61B/3/index.html?ACTION=3&GROUPID=4058&ARTICLE=97147> (cit. on p. 46).
- [34] Dec. 2017. URL: <https://www.conrad.de/de/hand-multimeter-digital-voltcraft-vc820-1-kalibriert-nach-werksstandard-ohne-zertifikat-cat-iii-600-v-anzeige-count-1090522.html#downloadcenter> (cit. on p. 47).
- [35] Dec. 2017. URL: <https://www.google.ca/maps> (cit. on p. 48).
- [36] 2018. URL: <http://www.nepal-initiative.de/lophel-ling-boarding-school/> (cit. on p. 48).
- [37] Johannes Eisner. "Analysis of the Energy Demand for Designing Off-Grid Energy Systems for Developing Countries Based on the Example of Nepal". MA thesis. TUM, 2017 (cit. on p. 49, 67).
- [38] Dec. 2017. URL: <https://www.reichelt.de/Labornetzgeraete/PEAKTECH-2235/3/index.html?ACTION=3&LA=446&ARTICLE=101936&GROUPID=4952&artnr=PEAKTECH+2235&SEARCH=Labornetzger%25E4t> (cit. on p. 70).
- [39] Feb. 2018. URL: <http://www.hitachi-ds.com/en/Products/Automation/Inverters/WJ200.html#technicalData> (cit. on p. 70).
- [40] Dec. 2017. URL: <http://www.chauvin-arnoux.com/de/produit/c-a-8336.html> (cit. on p. 72).
- [41] Kjell Erik FOSSEN Helge SELJESETH Kjell SAND. "LADORATORY TESTS OF ELECTRICAL APPLIANCES IMMUNITY TO VOLTAGE SWELLS". In: *20th International Conference on Electricity Distribution* (2009) (cit. on p. 75).
- [42] Jan Desmet Jan Descheemaeker Michiel van Lumig. "Influence of the supply voltage on the performance of household appliances". In: *23rd International Conference on Electricity Distribution* (2015) (cit. on p. 75).
- [43] IISTE. "Effects of Total Harmonic Distortion on Power System Equipment". In: *Innovative Systems Design and Engineering* (2015) (cit. on pp. 78, 81, 90).