

Technische Universität München
Lehrstuhl für Messsystem- und Sensortechnik

Automated system for combinatorial synthesis and high-throughput characterization of polymeric sensor materials

Valentin Kulikov

Vollständiger Abdruck der von der Fakultät für Elektrotechnik und Informationstechnik der Technischen Universität München zur Erlangung des akademischen Grades eines

Doktor-Ingenieurs

genehmigten Dissertation.

Vorsitzender: Univ.-Prof. Paolo Lugli, Ph.D.

Prüfer der Dissertation:

1. Univ.-Prof. Dr.-Ing. habil. A.W. Koch
2. Univ.-Prof. Dr.phil. Otto S. Wolfbeis,
Universität Regensburg

Die Dissertation wurde am 05.05.2004 bei der Technischen Universität München eingereicht und durch die Fakultät für Elektrotechnik und Informations-technik am 13.9.2004 angenommen.

*to my family
for their endless love and support*

Abstract

In this thesis, an automated system for combinatorial synthesis and high throughput investigation of electrical properties of conductive polymers is described. The equipment provides a polymerization of defined mixtures of monomers into a thin layer on the addressed work electrodes of a direct electrode array. It is followed by high-throughput screening of current voltage characteristics according to the developed measurement protocol. The electrodes with an interdigital configuration were specially designed for simultaneous four- and two point conductance measurements. Programmed addition of analytes provided automated investigation of influence of gases on the synthesized polymers. The results of experimental test of the system are presented with investigation of materials for gas sensors. This equipment can be used for synthesis and electrical characterization of conductive polymers and multilayer polymer structures, for development of chemical sensors, bio-sensors, organic electronic devices and other thin film functional structures.

The present work describes the whole design and realization of the electropolymerization in details, measurement and analysis concept, set-up, software, measurement protocol. The developed measurement protocol provides fast but comprehensive investigations. The software includes three parts, i) software for electropolymerization, ii) software for measurement and iii) data analysis. The equipment has been verified by the investigation and optimization of sensors for gaseous hydrogen chloride based on synthesized conductive polymers (aniline based). The developed sensors can be used in fire alarm systems.

Zusammenfassung

In dieser Arbeit ist das erste automatische System für kombinatorische Synthese und Hoch-Durchsatz-Untersuchungen elektrischer Eigenschaften von leitenden Polymeren beschrieben. Diese Anordnung ermöglicht die Polymerisation von definierten Mischungen von Monomeren zu einer dünnen Schicht auf den adressierten Arbeitselektroden eines direkten Elektrodenarrays aus 96 interdigitalen Elektroden. Im folgenden werden nach einem dafür entwickelten Messprotokoll mittels Hochdurchsatz-Screening die jeweiligen Strom-Spannungs-Charakteristika bestimmt. Dies geschieht mittels gleichzeitiger Zwei- und Vier-Punktmessung der Leitfähigkeit. Die Optimierung von Sensoren zur Detektion von Chlorwasserstoffgas, hergestellt aus Anilinderivaten, zeigt exemplarisch das Anwendungspotential. Das System kann zur Synthese und elektrischen Charakterisierung von leitenden Polymeren and Multischicht-Polymerstrukturen, zur Entwicklung von Chemosensoren, Biosensoren, organischen elektronischen Bauteilen und vielen anderen funktionellen Dünnschichtstrukturen eingesetzt werden.

Table of content

1	INTRODUCTION.....	1
1.1	OBJECTIVE OF THE WORK	2
2	ELECTROPOLYMERIZATION CONCEPT	5
2.1	ELECTROCHEMICAL SYSTEM	15
2.1.1	<i>Reference electrode.....</i>	<i>16</i>
2.1.2	<i>Counter (Auxiliary) electrode</i>	<i>20</i>
2.1.3	<i>Electrochemical cell with central auxiliary and reference electrode</i>	<i>22</i>
2.1.4	<i>Work electrodes for single experiments</i>	<i>26</i>
2.1.5	<i>Direct electrode array with 96 interdigital electrodes.....</i>	<i>29</i>
2.2	PREPARATION OF TARGET ANALYTE, DOSING STATION	31
2.3	INTERFACE BOARD	37
2.4	ELECTRONIC SYSTEM, ELECTRICAL ADDRESSATION	41
2.4.1	<i>Multiplexer 96 (electrical addressation).....</i>	<i>45</i>
2.5	REMOTE CONTROL OF THE MULTIPLEXER 96.....	55
2.5.1	<i>Thermo-stabilization of experiment, electronic thermostat</i>	<i>57</i>
2.6	COMBINATORIAL ELECTROPOLYMERIZATION SOFTWARE, CEP.....	63
2.7	GENERAL REMARKS AND POSSIBLE IMPROVEMENTS	70
3	MEASUREMENT CONCEPT	73
3.1	MEASUREMENT PROTOCOL	77
3.2	ELECTRONIC SYSTEM OF THE MEASUREMENT CONCEPT	83
3.3	MULTIPLEXER 96	84
3.3.1	<i>Thermo-stabilization.....</i>	<i>88</i>
3.4	ANALYTE ADDITION, GAS FLOW SYSTEM	91
3.4.1	<i>Gas flow cell for combinatorial screening.....</i>	<i>93</i>
3.5	AUTOMATED ELECTRODE ARRAY MEASUREMENT SOFTWARE, ARYMS	95
4	ANALYSIS SOFTWARE.....	101
5	APPLICATION FOR DEVELOPMENT OF HCL GAS SENSORS.....	109
5.1	EXPERIMENTAL DETAILS, CHEMICALS AND PREPARATION	110
5.2	VALIDATION OF THE ELECTROPOLYMERIZATION CONCEPT	110
5.3	ANALYSIS OF BULK AND CONTACT CONDUCTANCE OF POLYMER LAYERS	112
5.4	INFLUENCE OF EP CHARGE ON ANALYTICAL PROPERTIES OF POLYMER LAYER	115
5.5	INFLUENCE OF CHEMICAL CONTENT ON ANALYTICAL PROPERTIES OF POLYMER LAYER.....	118
5.6	COMPARISON OF PANI BASED SENSOR WITH COMMERCIAL FIRE SENSORS.....	121

6	CONCLUSION.....	122
6.1	SUMMARY.....	124
7	OUTLOOK.....	125
7.1	COMBINATORIAL SYNTHESIS OF BIOCHEMICAL SENSORS	125
7.2	COMBINATORIAL SYNTHESIS OF ORGANIC ELECTRONIC DEVICES	126
8	BIBLIOGRAPHY	129
9	LIST OF ABBREVIATIONS.....	143
10	APPENDIX.....	145
10.1	MULTIPLEXER 96 - ASSEMBLER SOURCE CODE.....	147
10.1.1	<i>Assembler code, main.asm.....</i>	<i>148</i>
10.1.2	<i>MX96 assembler code, HD44780.inc</i>	<i>153</i>
10.1.3	<i>MX96 assembler code, 96chann.inc</i>	<i>157</i>
10.1.4	<i>MX96 assembler code, pout.inc.....</i>	<i>160</i>
10.2	THERMOSTAT FOR ELECTROCHEMICAL CELL.....	163
10.3	ELECTROPOLYMERIZATION LIBRARY FILE DESCRIPTION (CEP).....	164
10.4	MEASUREMENT PROCEDURE FILE DESCRIPTION (ARYMS).....	167
10.5	COMBINATORIAL RESULTS	169
10.5.1	<i>Results on P(ANI+4ABA), library: 04-06-03-4ABA-5.....</i>	<i>170</i>
10.5.2	<i>Results on P(ANI+3ABSA), library: 09-06-03-3ABSA.....</i>	<i>172</i>
10.5.3	<i>Results on P(ANI+3ABA), library: 09-07-03-3ABA.....</i>	<i>174</i>
10.5.4	<i>Results on P(ANI+AA), library: 24-05-03-AA1.....</i>	<i>176</i>
11	ACKNOWLEDGMENT.....	179

1 Introduction

A call for novel technologies, new ideas, applications and techniques is still and will be challenging all the time. The increased development of the semiconductor industry allows one to use new technologies and advances for faster progress of science including development of computer and measurement technology and a high-throughput search for novel materials that could give positive feedback, not only to the semiconductor industry but to many other areas of life as well.

Nowadays, the polymer science is attractive due to the unique properties of polymers such as, material structure, mechanical properties (they are also called plastic materials), low production cost, friendly recycle (compared to inorganic materials standardly used in the semiconductor industry) and have many other advantages. The idea of utilizing the conducting properties of polymers was first proposed in 1964 by Naarmann [1, 2]. Since that time, polymers have been used as active components in variety of applications. For instance, the use of polymers as light emitting materials was proposed in 1969 [3]. Thereafter, carbon and metal filled polymers were used as moldable semiconductors, as photoreceptors in electrophotographic copying machines and in others applications.

In 1977, the conductive properties of the alternating-bond conjugated polymer trans-polyacetylene were discovered. It was found that the polymer could be n- or p- doped either chemically or electrochemically (respectively by light or other) to the metallic state and thereby transformed into a good electrical conductor almost comparable to that of one single copper crystal. This led to the Nobel Prize in Chemistry 2000 being awarded to Profs. A. J. Heeger, A. G. MacDiarmid and H. Shirakawa [4]. Thereby, motivated development of conducting polymers has continued to accelerate at a rapid rate. A variety of new polymers and their derivatives have been discovered and applied in a really impressive application range [5-7] for different fields.

In 1990, results based on poly(p-phenylenevinylene - PPV) as the appropriate material for a layer of a light emitting diode was published [8] and laid down the stepping stone for applications of conducting polymers in lighting emitting electronics.

Currently, conductive polymers are used as antistatic coatings [9], as anti-corrosion coatings [10, 11] for protection of iron, in the fabrication of electrochromic windows [12], for the production of conducting textiles [13].

Other application fields they have found in bio-sensors [14, 15], for example as selective filters [16], as amperometric sensors [17], as potentiometric sensors [18], then for preparation of pH [19] and reference electrodes [20-22], for DNA detection and recognition [23], in sensors for the food industry [24, 25], in chemical-sensors [26, 27] as gas sensors [28-

30] where a set of sensors sensitive to different target gases can be collected and used as an electronic nose [25, 31].

However, the main application field of organic polymers in the future is most probably organic electronics, they are currently used as conductors in light emitting devices with unique mechanical, optical and electrical properties (organic OLEDs or polymer PLEDs, organic displays) [32-35], where some of them have already found industrial application [36-38]. They are also used in micro-systems [39] and electronic devices [40, 41]. Typically, due to their low cost and easy recyclability they can be involved in devices such as thin-film transistors [42-47], p-n photo diodes [48], Schottky diodes [49-52], memories [53] and whole integrated circuits [54, 55]) and in their packaging [56]. There was an idea to use inkjet printing in order to create whole electronic circuits, such as printing slides, but inks will be replaced by polymers [57]. Another application fields of conductive polymers are in power cells - rechargeable batteries, which have small volumes, low weight and offer high capacity [58, 59], in portable electronics (mobile phones, notebooks and others), in solar cells [60] on the Earth and in the Cosmos, in capacitors with ultrahigh capacitance [61, 62], printed circuit boards [63-65] and in many other fields.

The requirements on polymer materials are quite different or even opposite for the wide application range. To fulfill them, a technology of fast and cheap synthesis and high-throughput screening of novel polymers should be established. One possible way is described in this thesis.

1.1 Objective of the Work

The aim of this work is to show one of possible designs and realization of i) a concept for combinatorial electrochemical synthesis, ii) a concept for high-throughput screening of electrical properties of the synthesized polymers and iii) a concept for their complex characterization. In other words the main task was to create fully automated equipment for electropolymerization, based on an addressed work electrode, and for measurement and analysis of novel synthesized materials for application in gas sensors. According to the specification of the Kombisens project, which financially supported this work, the search for appropriate sensor materials that can be used in the detection of gaseous hydrogen chloride (HCl) was performed. It is known that during burning of plastic insulation (usually made of PVC, Polyvinyl Chloride) on electric cables, the HCl gas is released. Therefore an applications of fast response, sensitive, selective, regenerative and reliable HCl gas sensors are necessary in fire alarm systems. Such systems could stop the fire already in the beginning, therefore avoiding catastrophically situations that have happened in the past. However, some HCl sensors are available on the market (summarized in [66]), they have a poor response and reversibility.

The responsibility for the chemical part of this project, for planing of the combinatorial experiments, and selection of chemical components (previously proved on single electrodes) was given to C. Swart [67] and Q. Hao[66]. They have done rough selection of appropriate materials (monomers and aditives). Their work was based on verification of prospective electropolymerization processes by basic measurements under gas atmosphere on single electrodes [66, 67]. Results on single electrodes were obtained on similar instrumentation as used for combinatorial approach (however, the parts of a set-up for single experiments are not described here, the software and technical documents e.g. for electrode holder, cabling, etc. can be found in [68]). These results gave the basics for further combinatorial investigations performed by the electropolymerization set-up described in this thesis. For the first time, this concept was introduced at numerous conferences [69-72] the review on this topic can be found in [7], short technical description in [73], analysis concept in [74], application results in [75] and others, not published yet.

However, the developed electropolymerization set-up was designed for the search of appropriate materials for gas sensors it also opened new application ranges for many other fields (this is summarized in the outlook chapter 7).

The thesis is organized as follows:

- The electropolymerization concept is described in chapter 2. This chapter deals with the design and realization of a corresponding EP set-up.
- The concept of the high-throughput screening with developed measurement protocol is shown in chapter 3. Please take into account that the identical instrumentation was used for both mentioned concepts.
- The analysis is shortly outlined as a software part in chapter 4. The analysis of the sensor properties was performed according to the measurement protocol described in chapter 3.1.
- This concept was involved for evaluation and optimization of novel polymeric sensors for gaseous hydrogen chloride. Several combinatorial results performed on the designed EP set-up are given as an illustration in chapter 5 together with the summary on commercial application.
- At the end of the work appendix part can be found. Because of the large volume of this work it was shorted only to cover most significant parts. Anyway, the extended version can be found in electronic form in [68].

Regensburg 11.03.2004

2 Electropolymerization concept

A short summary of existing techniques and corresponding works for combinatorial research with description of a novel concept and instrumentation for electrochemical deposition, based on electrical addressation is given in this chapter. This gives an example how an electrochemical deposition could be automated. There are several publications, mentioned below, which motivated the development of the novel electropolymerization (EP) concept described here. This EP concept performed combinatorial synthesis of polymer single- or multi-layer structures and realizes high-throughput screening of their electrical properties as the second step.

An electrochemical polymerization of organic molecules on electrodes was observed first more than 50 years ago. Possible mechanisms of the electrochemical synthesis were reviewed in numerous publications [76-84]. An electropolymerization in the presence of several monomers can lead to formation of copolymers and block copolymers [85-92]. In many cases, a synthesized polymer (or essential amount of it) remains to be adsorbed on the electrode surface. This phenomenon led to a simple technology of formation of thin polymer layers on conductive surfaces. An intensive investigation of conductive polymers [4] in 1970's and 1980's was an additional motivation for further development of electropolymerization. It had been shown that most of the conductive polymers, including substituted and non-substituted polythiophene [93], polypyrrole, polyaniline, polyazulene, polycarbazole, polyindole, polytriphenylene, poly(3,4-ethylenedioxythiophene)-poly(styrene sulfonate) (PEDOT) [94], polyazine [95-97] and many others, could be very simply synthesized by electrochemical oxidation of the corresponding monomers [98]. The oxidized conductive polymers could be electrochemically (chemically or physically) reduced, it corresponds to the loss of counter-ions and to dramatic changes in their optical and electrical properties. If the polymer was conductive, electrochemical synthesis could lead to formation of very thick polymer layers (the authors obtained thickness of about 1 mm). If the polymer was poor conductive, a gradual decrease of electrical conductivity of the organic layer suppressed electropolymerization, this led to a principal limitation of the layer thickness.

Most technologies of combinatorial chemistry were based on a solid-phase synthesis. They could be realized in different formats and addressation techniques. Typically, a dispensing of reagents into micro- or nano-titerplates were used frequently [99]. Further investigation was performed by different techniques, including binding and inhibitor assays [100], screening of biological activity, mass-spectroscopy, chromatography, optical [99, 101] or electrochemical [102-107] methods. Several exceptions, described in literature, included a light-directed immobilization [108] and an addressation by use of micro fluidic systems [109, 110]. Only few authors described electrical addressation [111-115].

The possibility to control polymerization on solid conductive surfaces by application of corresponding electrochemical potentials suggested a natural realization of this process as an automated technology.

Generally, one has to focus on an appropriate addressation technique, reagent preparation and transportation, on an automated deposition of materials, its monitoring and several other tasks.

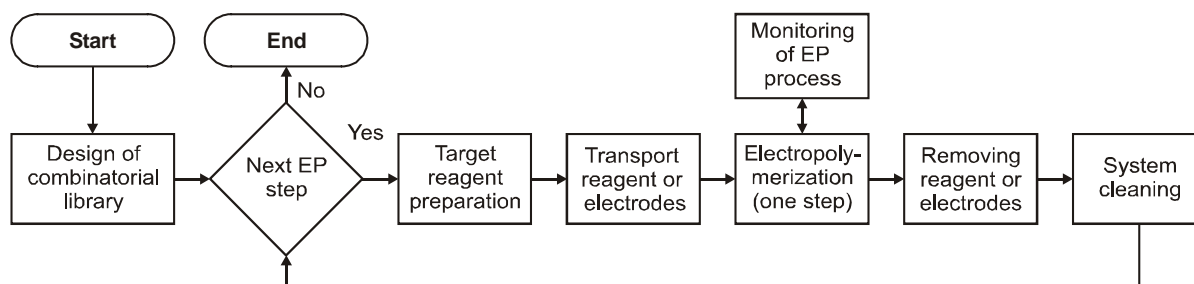

Fig. 1. Flow diagram of the combinatorial electropolymerization

The simplified flow diagram of a possible automated electrochemical synthesis is shown in Fig. 1. Usually, the combinatorial experiment began with definition of the combinatorial library. The user determines the library, which included all electropolymerization conditions, used target reagents and others, separately for each work electrode involved in the experiment. It means that (following flow diagram Fig. 1) the preparation of one work electrode included following steps; i) the preparation of the target reagent, ii) its transportation into an electrochemical cell respectively transportation of electrochemical system (electrodes, involving reference, counter and work electrodes) into the cell filled by a target reagent, iii) electrochemical synthesis and iv) removing reagents respectively electrodes and cleaning of the system.

The preparation and transport of reagents was usually realized by expensive commercial robotic systems (mechanical). However, they did not limit amount of reagents, they had low reliability because of involved moving parts what required surveillance.

The electropolymerization was performed and monitored taking in to account specified (in library) border conditions such as a defined final electropolymerization charge or time respectively resistance (pulse electropolymerization with structure resistance monitoring on single electrode, introduced in [116]). If one of the specified border conditions was reached during the EP, the process was stopped and the target reagent / respectively the electrochemical electrodes was / were removed. It was followed by cleaning of the electrochemical system (fluidic system, tubes, electrodes and cell) and preparing it for electropolymerization on a next work electrode. These EP steps could be repeated until all working electrodes involved in the experiment were covered by polymers of specific content, according to the combinatorial

library. This was the outline of the simplified flow based on the combinatorial experiment, involving dispensing systems with different addressation techniques, based on electrochemical deposition.

The combinatorial synthesis and high-throughput screening was the point of view in the last time period for variety applications. This resulted in new techniques published in numerous papers [103-107, 114, 115, 117-122]. Several of them, most interesting, are outlined below. Some of them motivated the presented work and others were published just after realization of this electropolymerization set-up.

Glass et. al. [115] reported multi-element microelectrode arrays for electrochemical sensors. The electrode array was fabricated on a single insulated silicon substrate using photolithographic methods (electrode materials were used: Pt, Au, V, Ir, and C). They developed fabrication methods for multi-element microelectrode array detectors and for evaluation of their voltametric characteristics. Their work performed deposition on electrode spots, so it did not allow creating chemo-resistors, only to perform amperometric and voltametric measurements.

Sullivan et. al. [106] used a 64-electrode array immersed in a single electrochemical cell and relied on a serial measurement of electrochemical current at each electrode of an electrode array. They used an electrode array fabricated on a silicon wafer that was oxidized to render the surface insulating. The electrode array involved a 64-single spot work electrodes (square-shaped 1x1 mm) interconnected with a self-made multiplexer to a commercial potentiostat. They used the electrical addressation of the work electrode. The each electrode of the array was modified with a single organosulfur reagent. The cell was illuminated by UV light and images were recorded in a darkened room using a 35-mm camera (fluorescent screening). However, authors mentioned that it is possible to build automated dispensing, their instrumentation allowed only manual additions of reagents. This concept was developed for optical screening, where square electrode spots, not applicable for chemo-resistors, were introduced. The authors noted that the method could easily be adapted to create array libraries based on combinations of organosulfur components on each individual electrode of the array. Such libraries could be created by a customized dispenser in which reagent mixtures are introduced simultaneously to every single electrode of the array. Each electrode of the prefabricated electrode array could be addressed and controlled individually by the computer-controlled multiplexer.

Schuhmann et. al. [123] used a robotic system for combinatorial preparation and screening of biosensors. Their set-up was based on a fixed reagent platform and movable electrochemical electrodes. The eight-channel electrochemical deposition was performed simultaneously in standard 64 hole micro-titerplate used as fixed volume of the electrochemical cells. The robotic system moved eight independent single work electrodes with corresponding

counter and reference electrodes and dipped them into the holes of the micro-titerplate filled by specified reagents or cleaning solvents. Their micro-titerplate was divided into twelfth columns (each column had eight rows = eight independent electrochemical systems), where the holes of the identical column were filled by the reagent of a specific chemical content or by cleaning solvents. It means that each single EP step occupied one column of the micro-titerplate. Eight independent potentiostates were used, this allowed simultaneous electropolymerization and amperometric respectively voltametric measurements for eight different work electrodes. Author's aim was to create an automated system for the synthesizing and screening of the biosensors where as small volumes of the reagents as possible were used because of their expense. However, their concept could be easily expanded to more experimental steps and electrodes by adding of other micro-titer plates or by its replacing, they used robotic system which moved numerous work, auxiliary and reference electrodes. If such channel expansion would be required it is necessary to introduce additional potentiostates and whole electrochemical electrode systems. The preparation of target reagents was done by robotic system respectively manual as an option. Note that all reagents were under laboratory atmosphere all time during experiment; this could be a problem for long time experiments taking in to account amount of experimental steps and stability of target reagents.

Jiang et. al. [107] reported an indirect electrode array and a screening method with an electrolyte probe for combinatorial electrochemical analysis. Their indirect electrode arrays were built on a single substrate with numerous single spot electrodes formed by round wires (fixed each next to other by help of epoxy glue where one side of array was polished). They shown this technique as relatively accurate and easy to use with diverse features for studying catalysts, electrolytes, and reactants in either half or full electrochemical cells, with no requirements for special instrumentation. However, they method gave reliable results, the direct electrode array and corresponding screening method offered more accurate electrochemical measurements. According to the authors' notes, direct arrays were more difficult to use as the number of electrodes in the array increased. Authors used robotic system for movement of screening probe arm. However, they mentioned that there is no problem with increase of number of work electrodes, the further increase required precise movement around bigger electrode array area. On the other hand this technique was limited to amperometric or voltametric screening, therefore chemo-resistors with specific interdigital structure could not be formed using this technique.

Our electropolymerization concept is based on the direct electrode array with electrically addressed work electrodes. The electrodes are formed on silicon or glass substrate with a fixed number of single work electrodes equals to 96. This organization of the electrodes as an array (EA) and using the electrical addressation allowed us to exclude complicated and expensive robotic dispensing systems.

The realized concept [7, 73] could be functionally presented as consisting of three parts. The first one provided addressable electrochemical deposition of materials on predefined electrodes of the electrode array (so called electropolymerization) this is outlined in current chapter. The second one provided electrical measurements and basic characterization of the synthesized materials or multilayer structures and is described in chapter 3. The third one extracted important parameters from the electropolymerization and measurement data set, calculates, visualized of properties of synthesized polymer structures (gas sensors); this is described in chapter 4.

The block schematic of the electropolymerization concept instrumentation is shown in Fig. 2. It included a dosing station, an electronic system involving a potentiostat, a self-made multiplexer with an interface board (IB). The interface board mechanically and electrically connected the electrode array (EA) to the 96-channel multiplexer (MX96). The dosing station, described in the following chapter, provided a mixing of polymerizable substances and additives (in order to prepare a required target reagent), a delivery of the target reagent into the electrochemical cell (EC) and finally a cleaning of the whole liquid-flow system. All processes of the DS were synchronized by a computer according to a programmed EP library, through the power output module of the MX96. This library (in ASCII format) described all steps of the combinatorial electropolymerization: amount of reagents to be mixed subsequently for deposition on each work electrode of the EA (i.e. 96 steps for the used electrode array), physical parameters of polymerization (equilibrium conditions before EP, duration, temperature, electrode potential, final electropolymerization charge) and each cleaning procedure. In a nutshell, each line of the library file defined single electropolymerization step (involved only one work electrode), cleaning or other supported procedure.

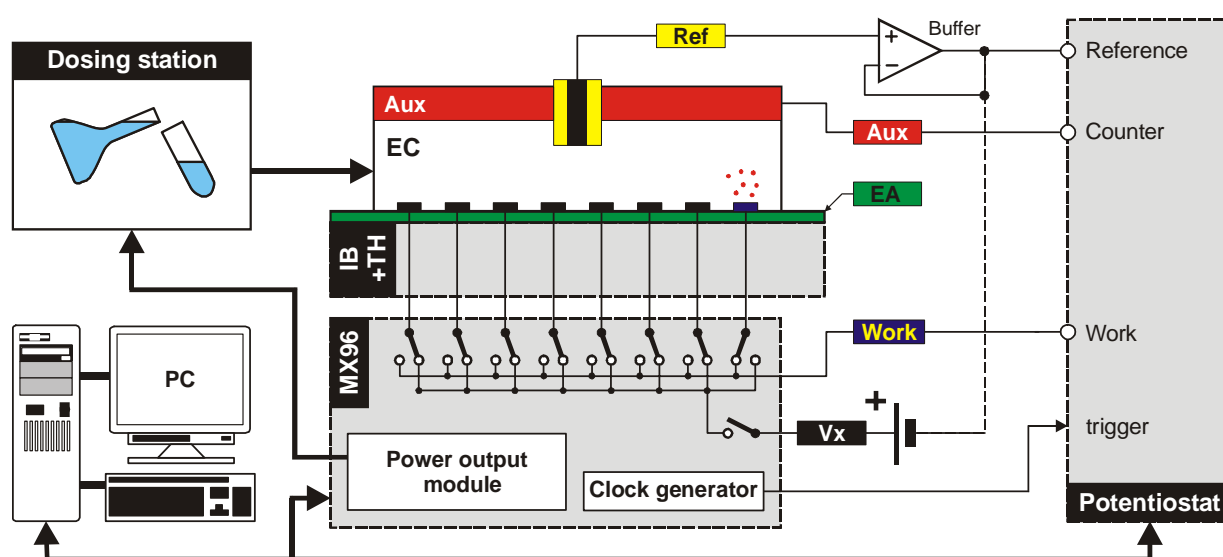

Fig. 2. Electropolymerization concept - instrumentation part

The electrochemical synthesis was performed in the electrochemical cell (EC), attached to the electrode array, shown in Fig. 3. A self-made reference electrode (saturated silver/silver chloride electrode with salt bridge) and an auxiliary electrode (platinum wire around the reference electrode) were placed in the middle of the EC. The practical realization of the EC, the principles of the reagent transportation and cleaning of the cell was completely automated; this is described in details in chapter 2.2.

The electrode array (EA) was produced, by use of standard lithographic process, on an oxidized silicon wafer with the thickness of the metal layer (platinum) 250-500 nm. The unused metal surface (including the wiring from the contact pins to IDT electrodes) was protected by an additional mask layer made of silicon oxide. This mask layer was used in order to exactly specify the active area of each single electrode (because the EP current is strong dependent on the electrode area). So 96 work electrodes with an four-strips interdigital topology were situated in the place of less than 20x20 mm. However, the active area was only 400 mm², the usage of a standard clamp socket with more than 384 (= 4 x 96) contact pins (YAMAICHI) required an increase of the EA area up to 60 x 60 mm (3600 mm²), shown in Fig. 3. At this time, this solution offered the simplest realization and there were no special requirements, however, currently many other appropriate contacting techniques could be applied (outlined in chapter 2.1.5).

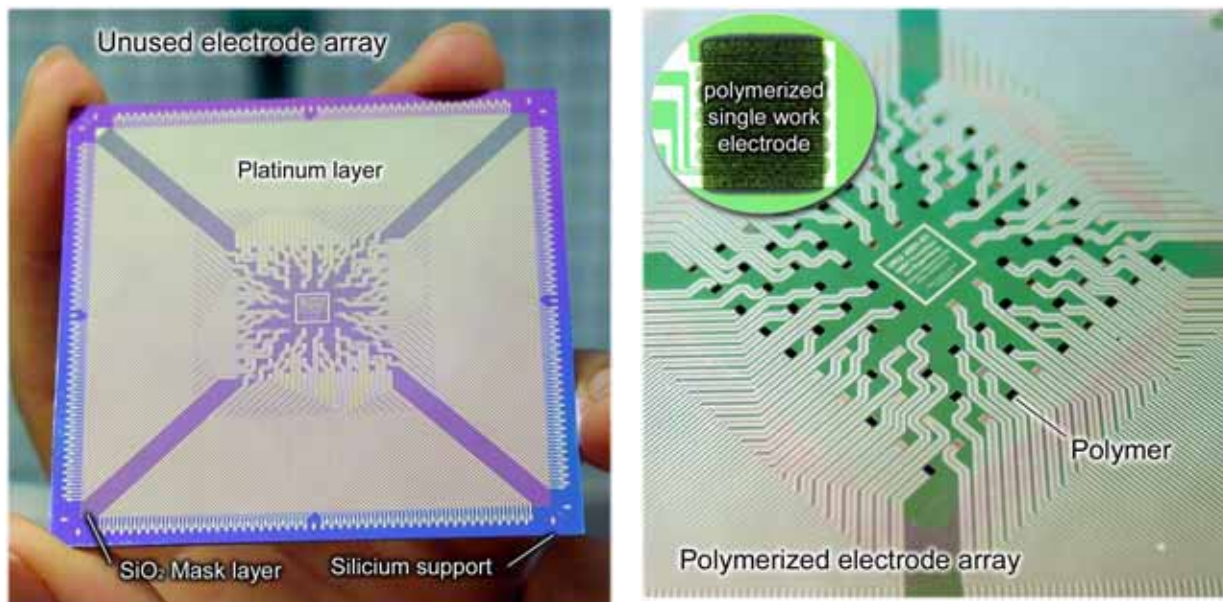

Fig. 3. Electrode array for combinatorial electropolymerization, before electropolymerization (left), detail of the middle part (active part) with electropolymerized electrodes (right)

The electronic system consisted of a high-impedance electronic multiplexer (MX96 self-made instrument), a source monitor unit (SMU, Keithley K2400), the interface board (IB) with the test clamp socket (YAMAICHI). The special switch configuration for the concept was

required. In the reality the MX96, was extended instrument (not only multiplexer), it involved combined switch configuration, and additional parts not corresponding to the “multiplexing”, which are described in the following chapters. Because of the strong dependence of the electropolymerization rate on temperature (described in chapter 2.5.1), the back side of the electrode array was attached to a miniature thermostat (TH), designed for temperature stabilization during experiments.

The Keithley company produced switching cards with 64 channels for two-point (32 for four-point, with 4A contact configuration) measurements. However, this did not satisfy our requirements (not supported 96 channels with special 4A+2B switch configuration). Because, there were other requirements that were not covered by commercial instrumentation (chapter 2.4.1), the electronic multiplexer was self-designed and produced. It included 96 channels of a 4A switch configuration (four normally open contacts based on high impedance reed relays MEDER) together with a 2B switch configuration (two normally closed contacts based on solid state relay AD4C212). However, the size of the multiplexer was bigger, comparing to switches implanted directly on a wafer (on chip) [23] because of numerous reed relays, it had many advantages that could not be reached by mentioned semiconductor switches (low leakage currents, high impedance, cheap prototype development, and others). The 4A configuration provided four-point electrical measurements and during the electropolymerization these four contacts were just interconnected. An additional 2B switch configuration could be used to fix the potential (V_x) of the currently unused electrodes out of the polymerization potential thus protecting them from undesirable electropolymerization (described in chapter 2.4). Because of defects in the insulating layer of the EA and other artifacts, if this potential was not fixed (the non polymerized electrodes were not connected), a polymerization on a specified electrode could lead to polymerization on neighboring electrodes too.

The circuit for electropolymerization copied the classical circuit of the three electrode electrochemical potentiostat with multiplexed work electrode. This allowed the voltage to be fixed between the reference and the work electrode and to measure the current through the work electrode (due to high impedance of the buffered Ref input, the current through the reference electrode was negligible).

During the electropolymerization, four interconnected strips of the addressed work electrode were wired to the potentiostat through the multiplexer. Other work electrodes of the array were held at the potential V_x (only outer strips – 2B configuration), which should be lower than the polymerization one or identical to the potential of the auxiliary electrode (V_x directly connected to the Aux electrode through appropriate resistance). The buffer amplifier (Fig. 2) was used to create an artificial system ground to fix the “zero” level for the optional voltage source V_x . The multiplexer subsequently connected each of the 96 electrodes with the SMU, thus provided their addressation. The electropolymerization could be done

galvanostatically, potentiostatically or by potential cycling, where only the last two modes were relevant for synthesizing of copolymers and therefore involved in this EP concept. The electropolymerization was synchronized by a clock generator (2Hz, 2 samples per second) in order to get a exact time scale for measured EP kinetics.

The electropolymerization set-up was completely automated, controlled by CEP software. The CEP (Combinatorial Electro-Polymerization) software was written under Agilent VEE 6.01 (Visual Engineering Environment) [124]. As was mentioned before, the electropolymerization was ruled by the library definition. This library (text file) could be generated automatically by combinatorial software (for standard experiments) or written by the user itself (for unique non-standard experiments). The library included all polymerization conditions for each of the 96 work electrodes of the electrode array. The user could select desirable reagents - monomers and additives (presented in reservoirs of the dosing station), variations of its concentrations, final electropolymerization charge or time, polymerization temperature, cleaning procedures, and polymerization order including a formation of single polymer layers or multilayer structures. During the polymer synthesis, the software monitored electropolymerization process and stored all electropolymerization data.

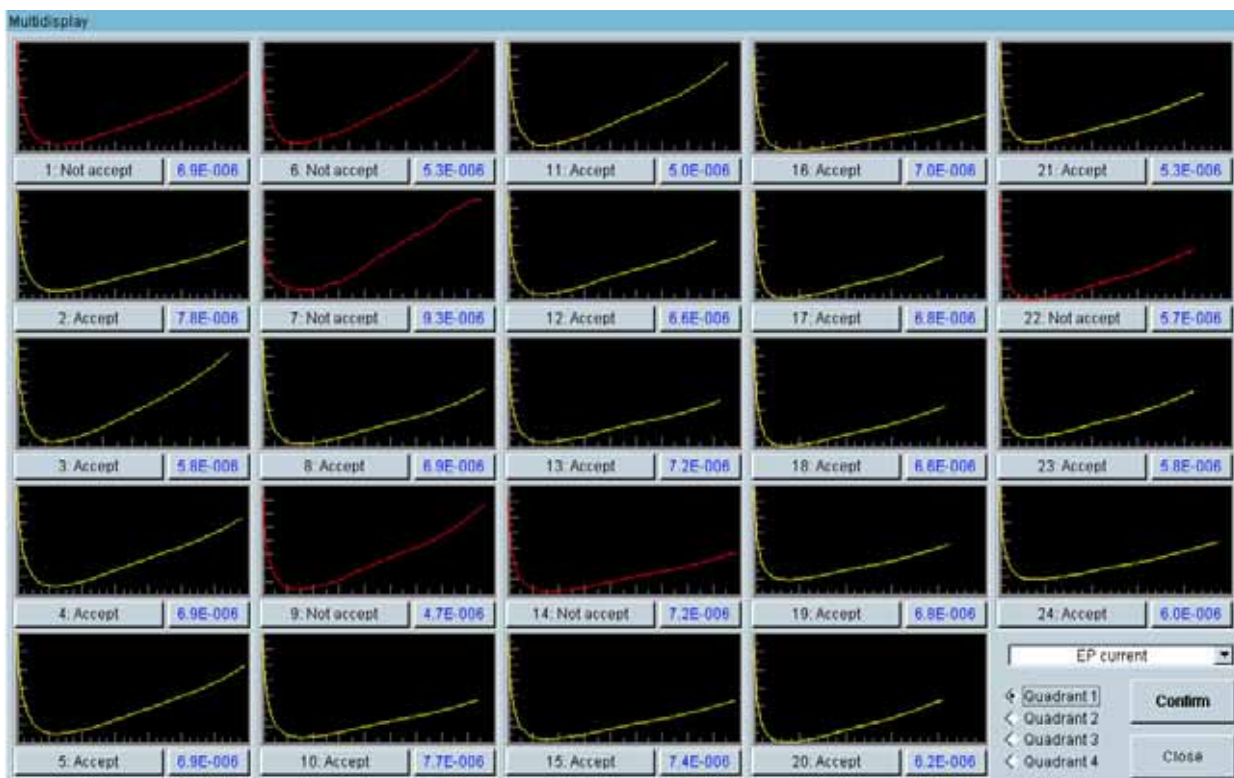

Fig. 4. Multi-display window of the CEP software, displayed one quarter of electropolymerization current kinetics - involved 24 single working electrodes (optional several other characteristics)

Example of quarter amount of the current kinetics for monitored electropolymerization, displayed by this software is shown in Fig. 4. All electropolymerization results were stored in special format (VEE container form) in the internal computer hard disk. After completion of high-throughput screening (electrical measurement of synthesized structures, measurement part of the concept, described in chapter 3) they all were used by the analysis software (described in chapter 4).

Finally, the view on the completed electropolymerization and high-through screening set-up is shown in Fig. 5. The following subchapters describe the individual parts of the electropolymerization setup (prototype); how it was completed and how it was working. Before you continue reading, please note that the described instrumentation is the only existing prototype with a lot of possible improvements, the written software was many times modified therefore it was not possible to keep all its functions actualized especially for loading of the previous measurements, these were realized in different formats during the search for the final measurement protocol.

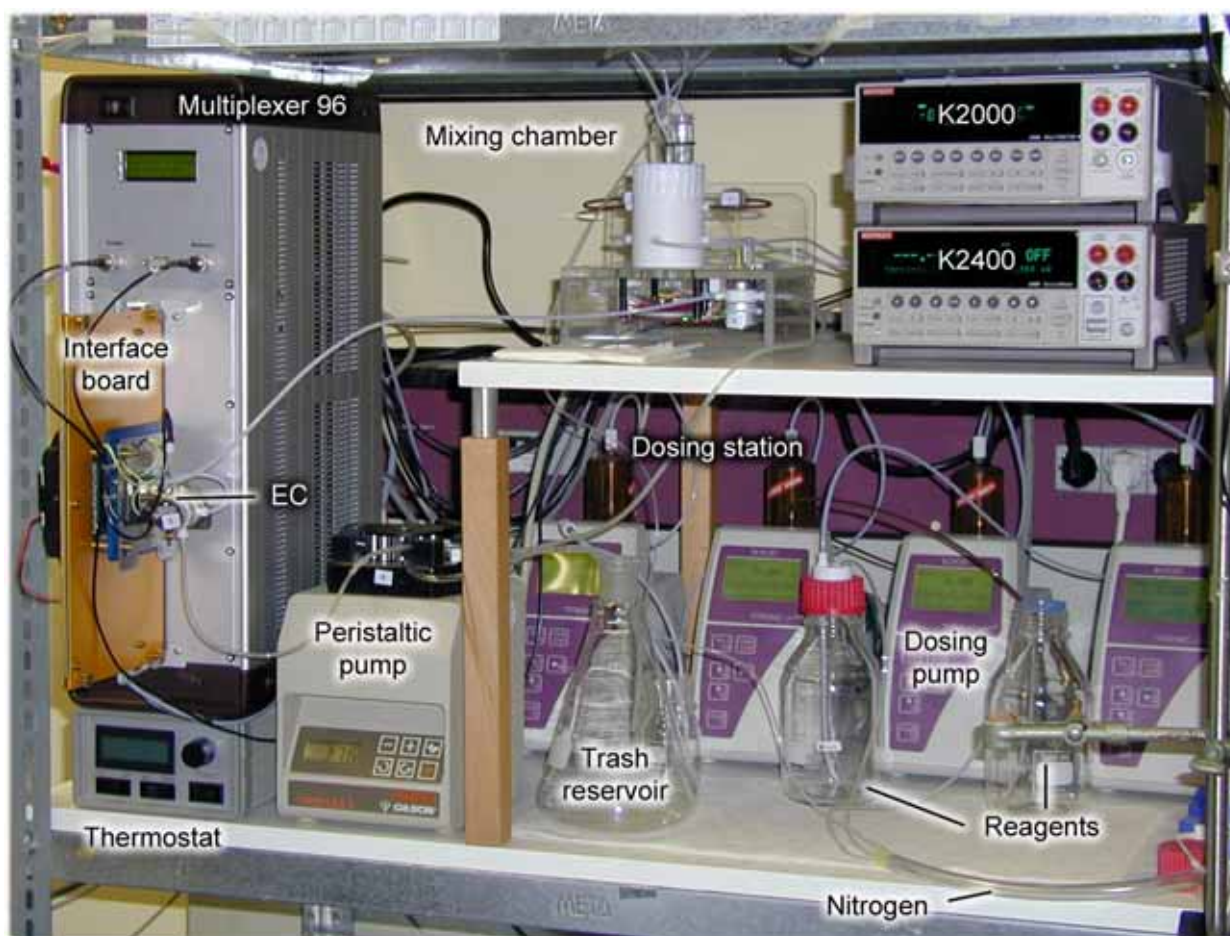

Fig. 5. Completed electropolymerization and measurement set-up for high-throughput evaluation of novel polymer materials and structures

However, the old versions of the CEP software are not available, the old libraries contains ASCII files that could be easily imported into the Microsoft Excel or Microcalc Origin or other appropriate software for further data evaluation. Many of results are not involved in this work, nevertheless, they are presented in [68] and can be further used and evaluated. Other parts of the main concept such as the measurement part (high-throughput screening), which included the same electronic components as the electropolymerization part but with a different configuration and software are described in details in relevant chapters. However, the presented set-up was designed primarily for the screening of materials dedicated for gas sensors, it could expanded to a variety other applications. Therefore the usage of the set-up for different application as described here will require not only software but also hardware modifications to fulfill of new application requirements. As an example, the presented concept was used also for two different strategies for development of enzymatic biosensors, but this is out of the frame of this work.

2.1 Electrochemical system

The main part of the electrochemical system is an electrochemical cell (EC), which typically consists of the sample dissolved in an electrolyte, and electrochemical electrodes [125, 126]. Generally there are two possible configurations; in two- or three-electrode system. The two-electrode system (also called galvanostatic mode), where only a work and a counter electrode are involved, is used usually for coulometric analysis in electrolysis or in galvanostatic experiments when the charge passed (or the number of electrons transferred) is of more interest than the applied potential. The total current through the electrodes, in this case, is kept constant that means if there is a fluctuation of the potential drop between these electrodes, the total current will be adjusted to reach the set one. The galvanostatic mode (galvanostat) realized by means of the K2400 source monitor unit (SMU) is shown in the block diagram, including electrochemical cell (EC), in Fig. 6, left. The SMU was set in the current source / voltage sense mode in order to keep the constant current flow (by the source part of the SMU) and to measure a potential drop between the work and the counter electrodes (by the sense part of the SMU). Simultaneously, the SMU limited (protected) the maximum potential between these electrodes [127] (specified by the user) to avoid unwanted electrochemical processes. The galvanostatic mode could be simply realized on circuit base by using several differential amplifiers with A/D and D/A converters for controlling and signal acquisition by a computer. However, it can be simply realized it was not required due to availability of the commercial SMU.

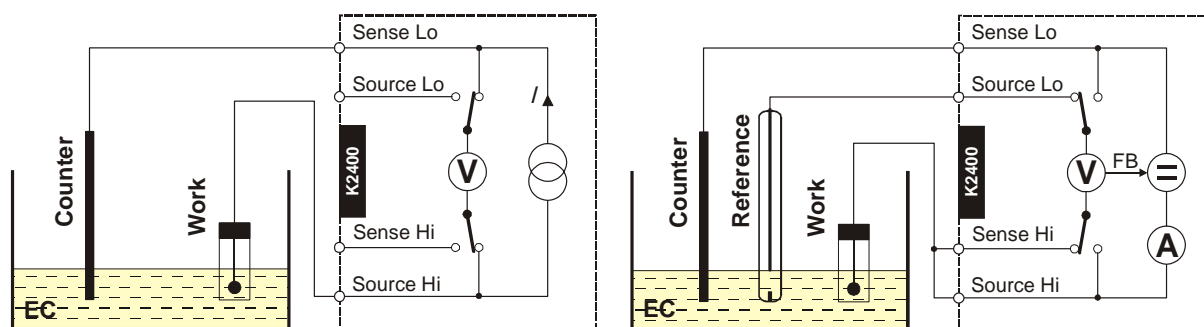

Fig. 6. Galvanostatic method (left), voltametric method (right), (EC – electrochemical cell)

Although, the galvanostatic method could be easily applied, in many electrochemical experiments, commonly only processes occurring at the work electrode defined by the electrode potential are of interest. The precise measurement of a potential at the work electrode required the three-electrode system [128], schematically shown in Fig. 6, right. The measured potential between the reference and the work electrode was kept the same as the set one by adjustment of the current flow between the work and the third electrode, called counter or auxiliary. This was controlled via a feedback loop (FB, Fig. 6, right), where the potential was measured and if

not matching the set value, the current was adjusted until the desired potential was reached. In ideal case, there was no current flow between the reference and the work electrodes due to high impedance input for reference electrode (it could be simply realized by appropriate buffer amplifier with high input impedance and if necessary with low offset). In order to minimize ohmic drop in the electrolyte, the reference electrode should be positioned in close vicinity to the work electrode.

The potentiostat, instrumentation, for three-electrode system was, with the previous case (galvanic), based on the K2400 SMU. In this case, the SMU was configured in voltage source / current sense mode, shown in Fig. 6, right. The circuit limited the maximum current, defined by user, to protect the electrochemical system against overload.

2.1.1 Reference electrode

The purpose of the reference electrode in the electrochemical system is to provide a stable, well-known and reproducible potential between an input of the measurement device (REF input of potentiostat) and an electrolyte. This potential cannot be measured directly, but being constant, can be used to referencing of the potential of the work electrode. The electrode can be imagined as a battery with voltage value (potential) defined by electrochemistry between a solid conductor (usually salt) and the electrolytic solution around it. The reference electrode usually has electrical resistance of about 1 M Ω (dependent on junction used), therefore, it must be connected to a high impedance input of a potentiostat in order to minimize a deviation from equilibrium. Ideally, if the small current passed through the reference electrode, the potential change is negligible.

There are several types of reference electrodes used in aqueous electrochemistry. Few of them are listed with specific potential values in Table. 1 as refereed in [129]. Most popular, stable and reliable are saturated calomel electrode (SCE) and Ag/AgCl electrode [125, 126, 130]. They have very low temperature coefficient and can be easily constructed to have different housings from a robust to miniature one [131-135]. They can be realized as microelectrodes close to the work electrode [136, 137] in order to minimize IR drop in the electrolyte.

However, these electrodes cannot be used in solutions where cations may form complex with chloride, or where leakage of chloride may interfere with analyte. In addition, they may be problematic when used in nonaqueous analyte solution, especially where contamination by water should be avoided. In these cases, a pseudoreference electrode can be used. This Ag/AgCl (without salt bridge) electrode is the simplest and the most compact (just piece of silver wire) in comparison with other types, but not as stable or as well defined. It requires calibration by spiking the solution with a small amount of a well-behaved reversible redox species like ferrocene. On the other hand they can be easily produced and implanted on wafer

level (on-chip) [136, 137]. Taking in to account the facts mentioned above, easy production, low costs, high stability and low temperature coefficient, the Ag/AgCl/KCl electrode (with liquid junction - salt bridge reference electrode) was used in the presented electropolymerization concept. A glass tube with length of 90 mm with outer diameter of 5 mm, bent 90° in ~60 mm of its length, formed the electrode body, shown in Fig. 7.

Table. 1. Specific potentials of several reference electrodes

Electrode type	Electrode reaction	Potential (V) at 25°C		junction	Ref.
		vs. NHE	vs. SCE		
Normal Hydrogen Electrode (NHE)	(Pt)/H ₂ , H ⁺ (a=1)	0	-0.2412		[126, 130]
Nonaqueous	Ag/AgNO ₃ (0.01 M) in MeCN	NA	0.3*	Liquid	[130]
	Ag/AgNO ₃ (0.1M) in MeCN	NA	0.36*	Liquid	4
Silver / silver chloride	Ag/AgCl, KCl (0.1 M)	0.2881	0.047		[130]
	Ag/AgCl, KCl (3.5 M)	0.205	-0.039	Liquid	[125]
	Ag/AgCl, KCl (sat)	0.197	-0.045		[126]
		0.199	-0.045	Liquid	[125]
		0.1988	-0.042		[130]
Ag/AgCl, NaCl (sat)	0.197	-0.047	Liquid	[130]	
Calomel	Hg/Hg ₂ Cl ₂ , KCl (0.1M)	0.3337	0.0925		[126, 130]
		0.336	0.092	Liquid	[125]
Normal Calomel Electrode (NCE)	Hg/Hg ₂ Cl ₂ , KCl (1 M)	0.2801	0.0389		[126, 130]
		0.283	0.039	Liquid	[125]
Calomel	Hg/Hg ₂ Cl ₂ , KCl (3.5M)	0.25	0.006	Liquid	[125]
Saturated Calomel Electrode (SCE)	Hg/Hg ₂ Cl ₂ , KCl (sat)	0.2412	0		[126, 130]
		0.244	0	Liquid	[125]
Sodium Saturated Calomel Electrode (SSCE)	Hg/Hg ₂ Cl ₂ , NaCl (sat)	0.236	-0.0052		[126]
Shaded = calculated values, where SCE assumed to be 0,2412 V for conversions					
Note: Liquid junction: A potential difference between two solutions of different compositions separated by a membrane type separator, MeCN = acetonitrile, * vs. liquid junction SCE					

The end of the shorter part occupied the highest seat of the electrode position (in order to avoid the formation of air bubbles in the filling solution of electrode), shown in Fig. 7, right. The ceramic junction with diameter of 1,2 mm, shown in Fig. 7, left was fitted with the help of a PTFE transition element. The transition element was inserted into the end of the longer part of the electrode body and together with the ceramic junction were situated in the electrochemical cell (in direct contact with reagents). Note, a small amount of KCl could leak through the porous ceramics and this led to salt crystallization on the reference electrode. The porous ceramics could be replaced by other suitable materials such as Vycor® porous glass [138] or Agar gel [137], moreover just Pt wire can form the electrode junction and could be

easily produced [136]. The silver wire with diameter 0,8 mm, fitted by a PTFE bar surrounded by silicone tube, was attached to the opposite end of the electrode body, shown in Fig. 7. The wire was dipped into the filling solution (saturated KCl) inside the electrode body.

The silver wire could be cleaned (and old AgCl coating could be removed) by soaking in concentrated ammonium hydroxide. Nitric acid could be used to roughen the silver surface. The wire should be rinsed after cleaning with water and then coated with AgCl by anodic galvanization, where a platinum counter electrode was the opposite part of the galvanization circuit [125]. The recommended current was about 10 μA and galvanization time several hours (e.g. over night). It could be by done by higher currents for shorter time, but smaller current densities over longer times were creating more stable AgCl coatings. The current could be generated by galvanostat or voltage source with serial resistance (e.g. 9 V with serial resistance 1 M Ω). The silver wire should be at positive potential with respect to the counter electrode. The result was a smooth, dull and slightly off-white (dark brown) coating film on the wire. Completion of the electrode; the body of the electrode was filled by saturated KCl, air bubbles were removed and electrochemically modified silver wire with the PTFE bar were attached. Finally, the electrode was kept in KCl solution (overnight) for equilibrating to obtain better stability. In the case of “low resistance” junction (specific by “high leak rate”, used in this concept), the disassembling of the electrode was not necessary, it was enough to deep reference electrode into the sat. KCl solution and make anodic galvanization as described above.

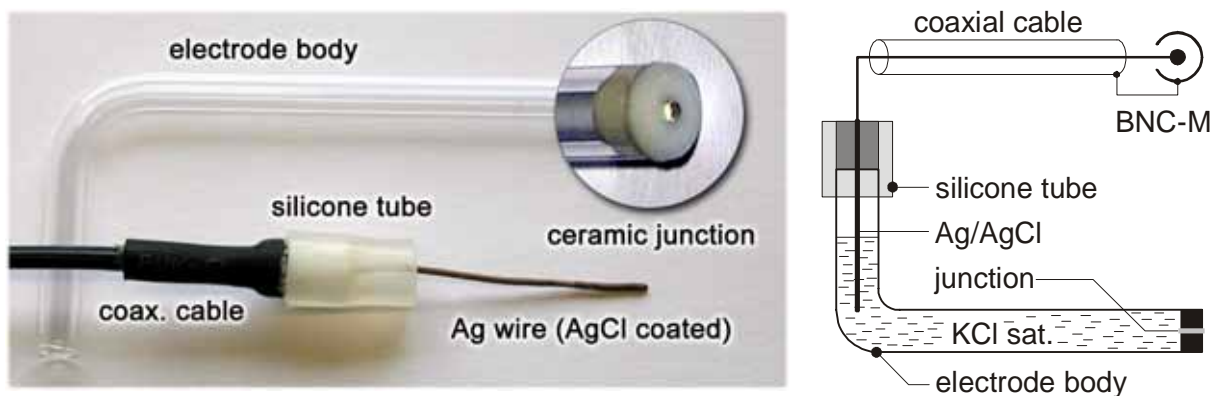

Fig. 7. Ag/AgCl/KCl electrode (with liquid junction) used in EP concept

To check the electrode functionality, the $\sim 3\text{M}$ KCl solution, voltmeter and additional reference electrode (in best case of the same type) was required. In this case, the potential between the dipped electrodes should be zero. However, in reality there are some differences between the electrodes (different ion concentrations etc.) the measured differential value should be 0 ± 20 mV. If the difference for the electrode pair is significantly higher, another electrode in best case of the same type is required to help distinguish which one of the previous two was functionless. When comparing voltage drift between Ag/AgCl and the SCE electrode,

the value should be -45 ± 20 mV, where SCE was connected to negative voltmeter input. It was recommended to store the Ag / AgCl electrode in the filling solution or deionized water, if “high leak rate” or Vycor® junctions were employed this storage was not appropriate since that can lead to the dilution of the filling solution (our case). This electrode required filling up by saturated KCl periodically. The electrode should be stored out of UV light (out of day light), because it decomposes AgCl to give silver that gives the electrode a black appearance.

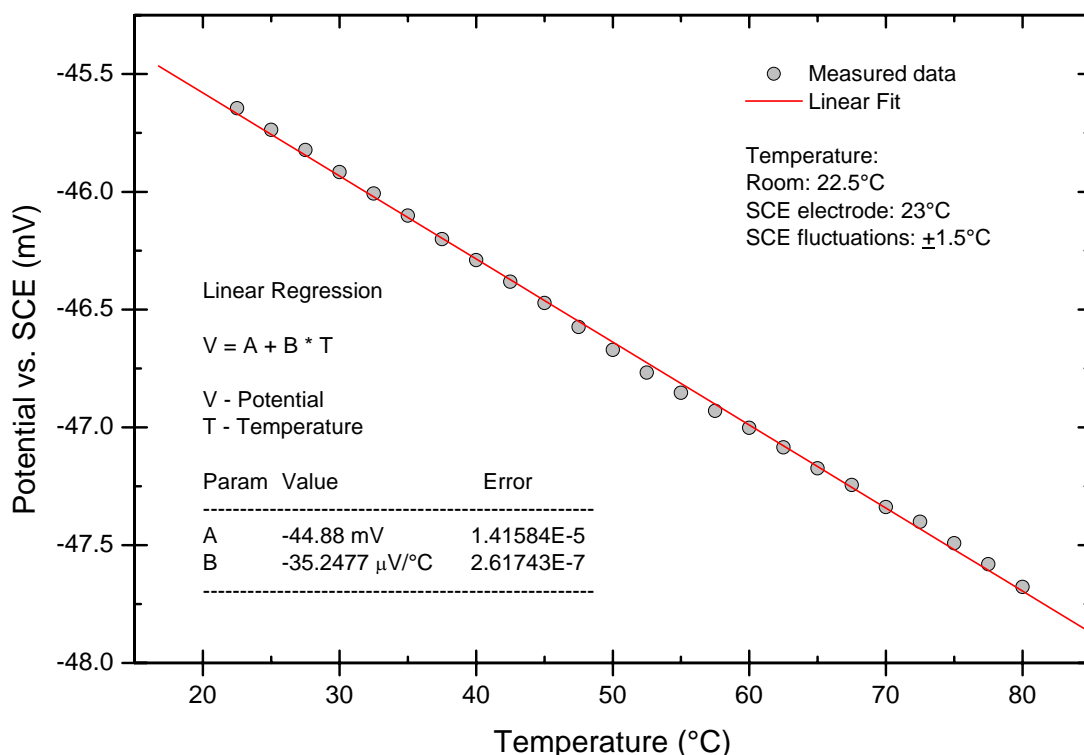

Fig. 8. Influence of temperature to electrode potential (measured versus SCE) of the self-made Ag/AgCl, KCl (sat).

The operating temperature of the reference electrode mainly depends on materials used for the electrode body. The realized electrode was made of glass and PTFE parts this allowed to extend the electrode operation temperature up to 80°C (operating range was from room temperature up to 80°C). The potential for $T=25^\circ\text{C}$, shown in Table. 1 was not completely describing the real situation, because in the cited references [125, 126, 130], they presented standard potentials Ag/AgCl electrodes at temperature range from 0°C up to 95°C (they generally refer to the potential of a cell without a liquid junction). The electrode potential including junction potential, estimated from the linear approximation for temperature range from 0-40°C was refereed in [125].

The constructed reference electrode was exposed to an experiment where the potential drop versus temperature was measured to prove the dependence of the electrode potential on

temperature. The potential was measured versus saturated calomel electrode (SCE) by the K2000 electrometer with input resistance higher than 10 G Ω . The whole experiment was controlled by the computer according to the program [139] for temperatures from 22,5°C (room temperature) up to 80°C with step of 2,5°C.

The potential kinetics for each temperature step was recorded for 10 minutes with 1 sample per second and the measured data were presented as average value of last 100 samples (last 100 seconds) for each applied temperature (so excluding the beginning kinetics). The SCE electrode was placed outside of the heating volume (away from the Ag / AgCl, KCl (sat) electrode) and kept at the constant temperature. The SCE electrode was electrically interconnected with the Sense Lo input of the K2000 voltmeter. The HCl / KCl = 0.01 / 0.1M solution was used as a conducting electrolyte. Fig. 8, shows the potential / temperature dependence of the constructed reference electrode, involving additional interface effects and temperature gradient across electrolyte solution, on temperature. For most experiments, it could be neglected because the potential drop is only about 35 $\mu\text{V}/^\circ\text{C}$ and potential shift of 46.75 mV good corresponded to the value of 45 mV mentioned in literature [125]. The initial shift of 1,75 mV was introduced by long distance (additional resistor) of the two reference electrodes. Practically, the SCE electrode was placed in the mixing chamber (MC) of the dosing station filled by the above mentioned electrolyte. The tested Ag / AgCl, KCl (sat) electrode, placed in the electrochemical cell (EC, filled by the same electrolyte), was in electrochemical contact with the reference SCE electrode through the liquids-junction formed in transport tubes between the EC and the MC. The SCE electrode was kept at room temperature ($T=23^\circ\text{C}$) and the fluctuation of its temperature was less than $\pm 1,5^\circ\text{C}$. Note that the Ag / AgCl, KCl (sat) electrode body did not reach the defined temperature completely due to a temperature conductivity of electrode body and heat dissipation.

2.1.2 Counter (Auxiliary) electrode

The counter electrode, alternatively referred as the auxiliary electrode, acts to source or sink electrons in the electrochemical circuit formed by the working electrode. The current in the three-electrode electrochemical circuit flows between the counter and the work electrode without passing in or out of the reference electrode. Thus, variation of the reference potential due to electrode polarization or IR drop (drop caused by current on a electrolyte resistance) of the electrode are eliminated. If the surface area of the counter electrode is small, relative to the area of the work electrode, then inaccuracies may occur due to the additional resistance in charge transfer reactions. Therefore, the area of the counter electrode should be relatively large compared to the work electrode. The material of the counter electrode should be chemically inert, in the whole potential scale, for instance appropriate materials are platinum or graphite. An inexpensive counter electrode could be made from pencil lead (graphite-impregnated clay).

Occasionally, in this case it is necessary to separate the counter electrode from an analyte solution by a porous junction to avoid interference by redox active contaminants generated at the graphite electrode.

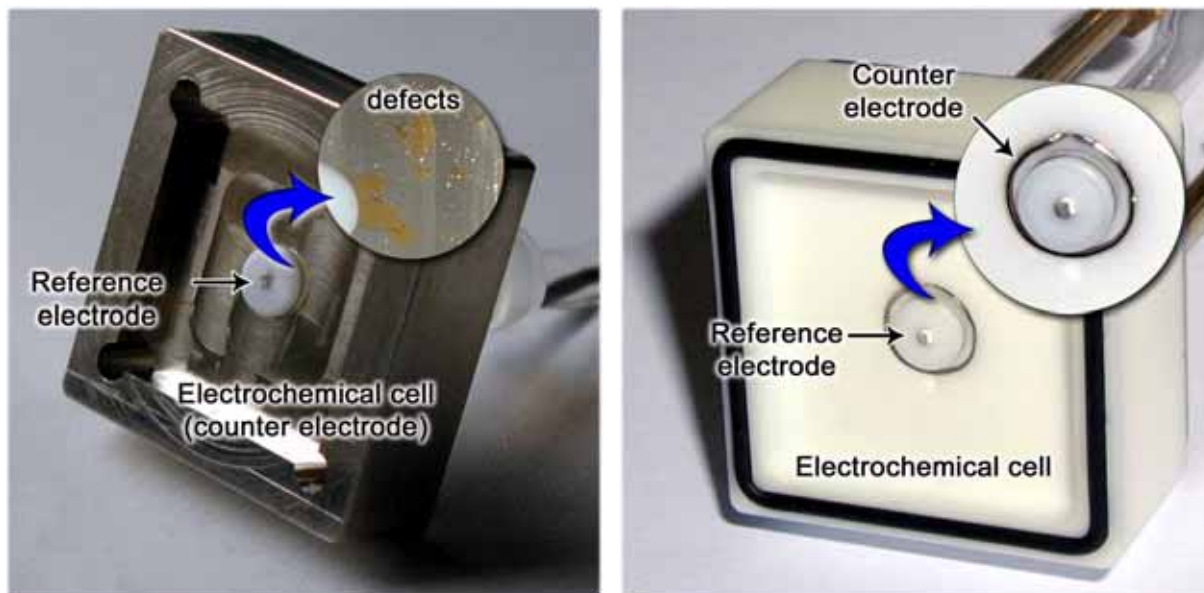

Fig. 9. Counter electrode (old design V2) formed by whole body of the electrochemical cell (left), new designed electrochemical cell made of PTFE with wire counter electrode (right)

The counter electrode used in presented electropolymerization setup was in the beginning formed by the whole inner part of the electrochemical cell (inner part of the cell body) being made of stainless steel, electrochemically coated by a platinum layer (over gold adhesion layer), shown in Fig. 9, left. The main idea was to use an electrochemical cell also as a thermo-reservoir for the electronic-thermostat, due to the strong dependence of electrochemical reactions on temperature. This design additionally offered the sufficiently large electrode (Counter) area. The stainless steel was used due to its low costs and stability for electrochemistry, relative to other materials appropriate for thermo-reservoirs such as aluminum and copper. The design was developed when the electrode arrays based on glass substrates were planned. The disadvantage of this counter electrode is described in the previous chapter.

The platinum layer stability problem and decision to use silicium instead of glass wafers as a support material for electrode arrays, gave the possibility of redesigning of the electrochemical cell and a counter electrode. Due to the excellent temperature conductivity of silicium, the thermo-reservoir formed by the body of the electrochemical cell was not required. The temperature stabilization was realized by the heating of the back side of the electrode array directly (not through an analyte solution as planned in previous design V2). The electrochemical cell was made of PTFE, where a piece of platinum wire with diameter 0,6 mm and active

length of about 20 mm, formed the counter electrode. The counter electrode surrounded the reference electrode, shown in Fig. 9, right. The area of the new counter electrode was about $12,3 \text{ mm}^2$, this was more than the area of the single work electrode of the electrode array (type: VKU2001-S1). Nevertheless, the area of the counter electrode was significantly increased by the electrochemical platinization, when the electrode surface was porous and black colored.

2.1.3 Electrochemical cell with central auxiliary and reference electrode

The whole electrochemistry is performed in an electrochemical (reaction) cell (EC), which is a key part of each electrochemical set-up. The initial idea, in this project, was to design and produce an electrochemical cell with the simplest liquid system and low technical requirements. Several designs were realized, in the beginning, when the use of non conductive (glass) substrates was planned, the cell was made of stainless steel with the hole for the reference electrode in the middle. The metal was used due to requirement to preheat the inner cell volume as well as all electrodes with and the electrode array (mentioned above). The metal surface of the cell was electrochemically coated by a platinum layer (gold adhesive layer 150 mg over Pt layer 150 mg for whole cell surface) to form the platinum counter electrode.

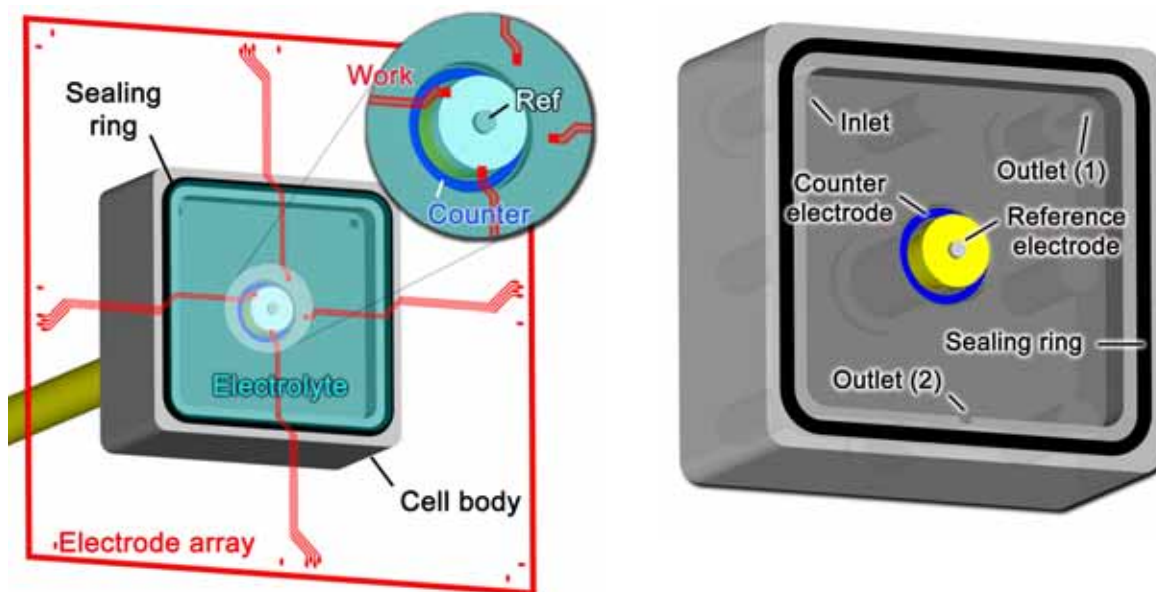

Fig. 10. Alignment of the body of the electrochemical cell and electrode array (left), 3D transparent model of the electrochemical cell (right)

This cell had a big advantage, due to sufficiently large counter electrode formed by the whole inner part of the cell body; this minimized the potential drop in the electrolyte. Because of defects in the platinum layer, it was damaged, after several experiments, especially after cleaning with piranha solution (1:3 mixture of 30% H_2O_2 / conc. H_2SO_4), shown in Fig. 9, left.

Therefore, the new EC cell was designed and realized. The newly designed cell was based on the previous design with several changes (material of the cell body, additional mechanical modifications and a new auxiliary electrode). The stainless steel was replaced by chemically inert PTFE (Teflon) material [140] that formed the cell body and minimized reactions with the reagents.

The cell was vertically positioned and being attached to the electrode array, its inner part formed a closed volume of about 1,6 mL, shown in Fig. 10, left (the inner part of the EC body (Fig. 10, right), was during experiments filled by reagents). It had a shape of cuboid (23 x 23 x 3 mm and was sealed by a Viton® ring (DuPont). Its volume should be relatively small to minimize consumption of reagents but large enough to cover consumption of reagents during an experiment. The mentioned volume of 1,6 mL used in this work came from the used electrode array (exactly from its active area), dimensions of the reference electrode and from some construction parts.

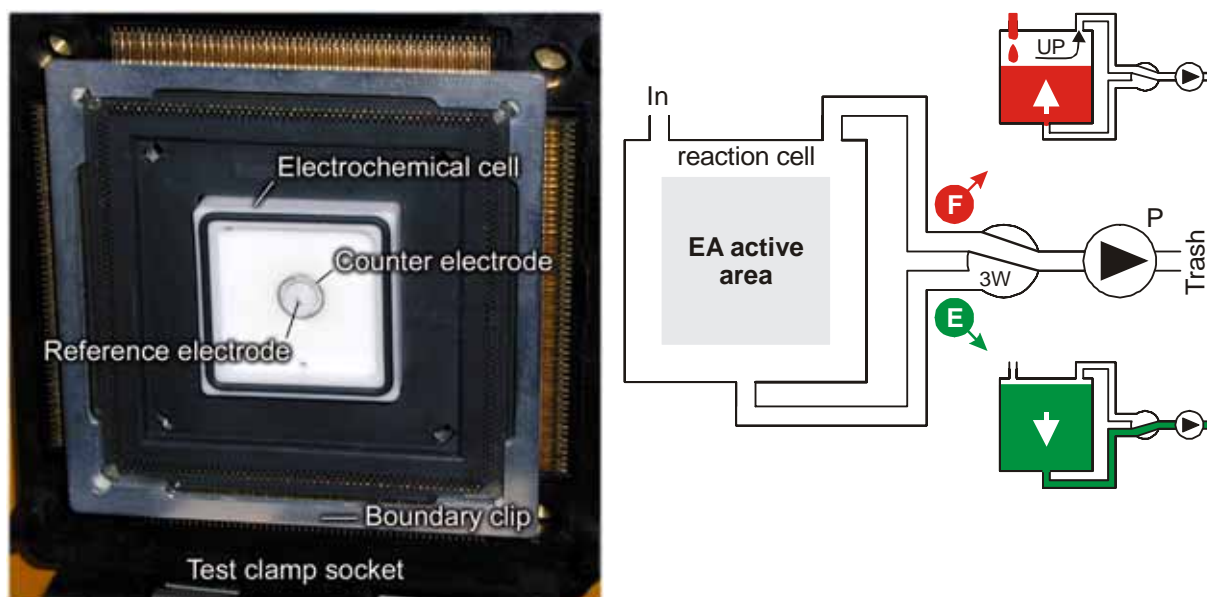

Fig. 11. Opened electrochemical cell (without electrode array) inserted in the test clamp socket (left), control of the liquid flow in the electrochemical cell (right)

Both, the reference electrode (described in chapter 2.1.1) and the auxiliary electrode (described in chapter 2.1.2) were situated in the middle of the cell. The reference electrode (described in chapter 2.1.1) was inserted into the hole in the middle part of the cell through the sealing ring. The auxiliary electrode made of platinum wire \varnothing 0.6 mm was bent to form the circle with diameter of 6 mm with area app. of 41 mm². It was situated behind the reference electrode and additionally platinized to increase its area. Generally, in most cases, the reference electrode should be as close to the working electrode as possible. However, sometimes to avoid contamination, it may be necessary to place the reference electrode in a separate compartment,

that means the placement of electrodes depended on the recent situation. The presented design did not allow one to place the reference electrode close to each out of the 96 work electrodes of the array; therefore, one had to limit applications by highly conductive electrolytes and low polymerization currents, where the voltage drop in the electrolyte is not significant.

The electrochemical cell had one inlet, connected to the output of the dosing station and two outlets, both connected to the 3-way valve (3W, PTFE-NR Research), shown in Fig. 11, right. The 3W valve switches between two modes; i) filling and ii) emptying of the electrochemical cell. If the valve was in the position F (filling, 3W valve in default position), shown in Fig. 11, right, the peristaltic pump created underpressure in the cell and in the transport tubes, the target reagent (mixture of chemicals) was injected from the dosing station (directly from mixing chamber) into the EC. The cell was filled as long as the liquids were coming from the mixing chamber through the inlet tube (In) and remaining reagents from the MC were transferred directly into trash reservoir. When the mixing chamber was empty, the underpressure disappeared and the liquids stayed in the cell. The valve switched to the position E (empty) led to removal of the liquid from the cell through the lower outlet (Fig. 11, right). This principle allowed one to control filling of the cell without switching the pump direction and without precise control of the liquid volume or using a liquid level sensor on an outlet tube of the EC. The practical realization of the EC (opened, without the electrode array) inserted in the test clamp socket is shown in Fig. 11, left.

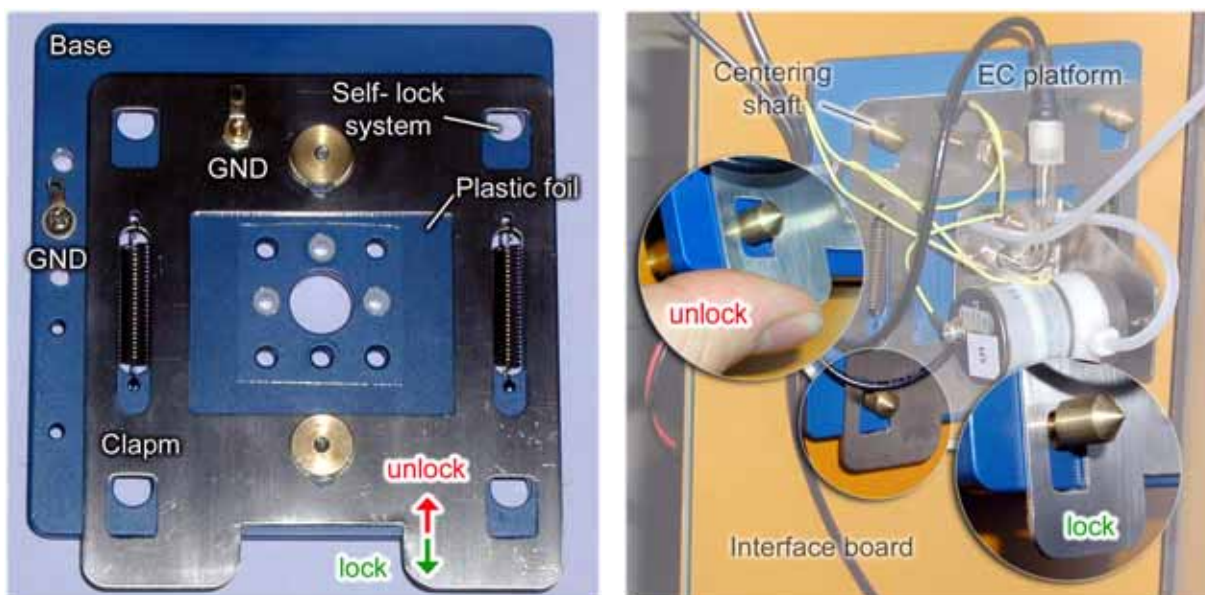

Fig. 12. Self-locking mechanism of the EC platform (left), EC platform locked in the EC set-up, principle (right)

The EC body was attached to the set-up and to the EA by a platform shown in Fig. 12. The EC platform consisted of three main parts; a base, a clamp and a stand. Two screws

mounted the clamp, made of stainless steel plate (1 mm), to the platform base (made of aluminum plate 5 mm). Thus, the construction allowed its one-way movement as indicated by arrows (lock, unlock) in Fig. 12, left. Two side strings, returned the clamp to its initial (lock) position, this can be seen as four lapped holes (in all corners) of the base (Fig. 12, left). By pressing the clamp against the base, as outlined by “unlock” arrow in Fig. 12, left the platform with the EC was unlocked from the interface board (set-up). In this case, the previously lapped holes of the base were completely opened; this allowed detaching the platform with the electrochemical cell, by one-way movement across centering shafts, shown in Fig. 12, right. The self-locking principle used four centering shafts mounted on the rear panel of an interface board. The distribution and shape of the centering shafts determined the position of the EC platform according to the electrode array.

The EC body was attached to the platform by three long-screws crossed PTFE transitions (Fig. 13, left used to decrease friction during the EC body one-way shift) this allowed its one-way movement (outlined by two arrows in Fig. 13, right) of the EC body across the axis perpendicular to the surface of the EA. The shape of the centering shafts determined the distance of the EC platform from the surface of the EA and also adjusted the pressure, which was applied by EC body to the electrode array in order to create a hermetically sealed volume (closed electrochemical cell). This pressure was created by four strings around these long-screws, and PTFE tube (EC output), which pushed the EC body against the EC platform (Fig. 13). More technical details can be found in [141].

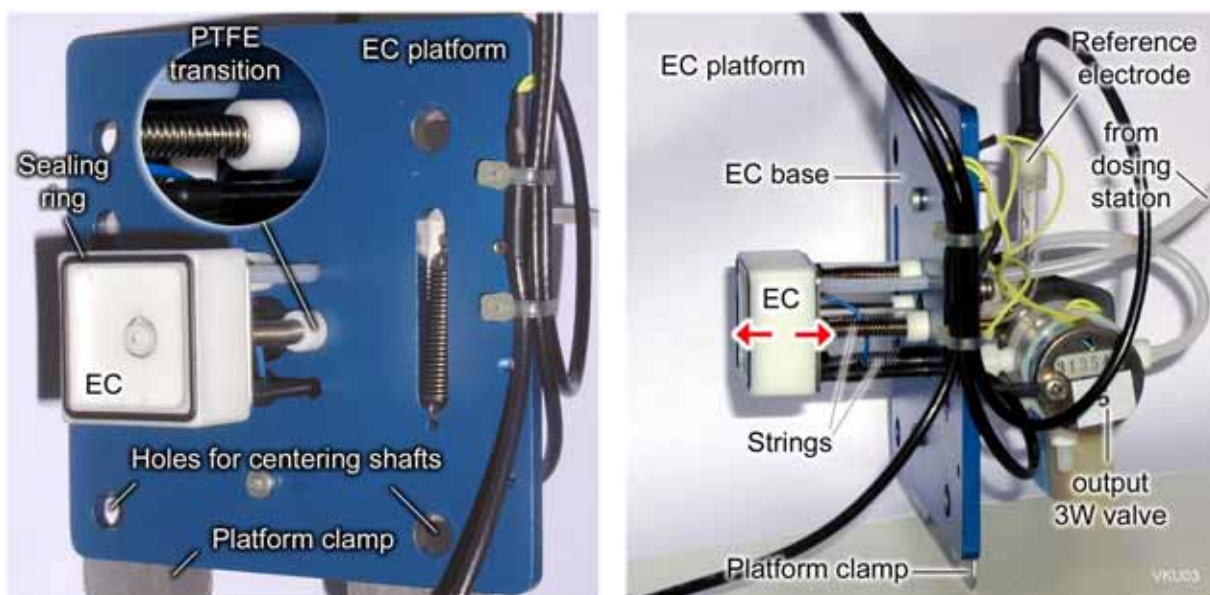

Fig. 13. Front view of the EC platform with the electrochemical cell body (left), side view of the EC platform with outlined one-way movement of the EC (right)

2.1.4 Work electrodes for single experiments

The work electrode was another important part of each electrochemical set-up. The work electrode could have different shapes and dimensions, from a single wire up to integrated planar structures. Its area should be relatively small, in order to minimize the consumption of reagents electrolyzed at its surface compared to that remaining in bulk solution to exclude change of concentration in the solution during the experiment. Due to the development in the semiconductor industry, the most popular were planar electrodes, consisting of support material, electrode layer and optional mask layer. There were various appropriate materials for the electrode support, for instance silicon specific by good thermal conductivity, glass with good optical and insulating properties, plastics with appropriate mechanical properties and several others. Usually, gold, platinum, steel (research on corrosion protection [10, 11]), low cost carbon electrodes [142-144] were frequently used as a conductive material for the electrode layer. All of them had different limitations, advantages, disadvantages and they were appropriate for different applications.

Because of each electropolymerization was specific by different target reagents, which required different electropolymerization conditions, it was necessary to perform experiments on single electrodes before a combinatorial approach. These experiments were important to find limits and appropriate electropolymerization conditions.

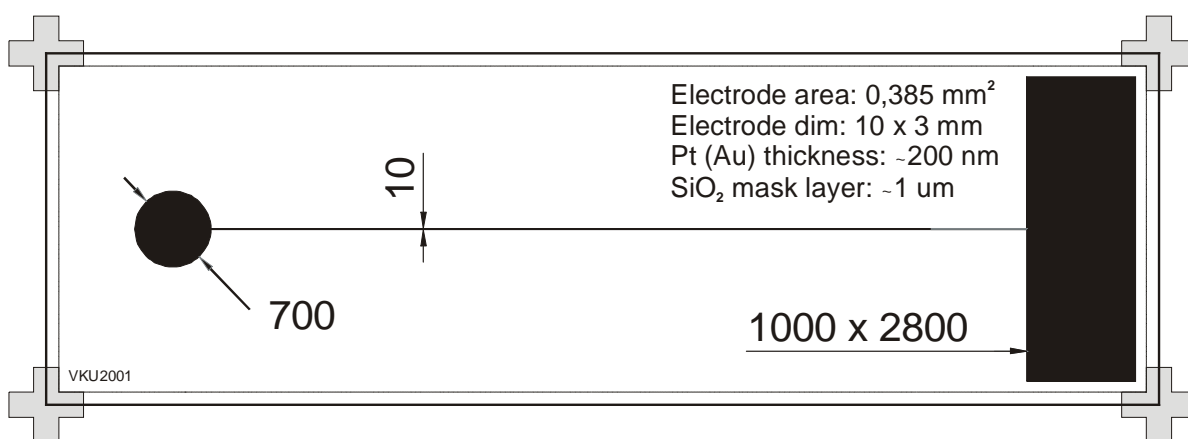

Fig. 14. Topology of single round electrode, dimensions in μm

This was the reason why the design of single work electrodes was required. In the beginning single work electrodes were designed and produced on glass support. The Pt layer with thickness of about 150 nm (Au with adhesive layer) was sputtered onto the glass wafer with thickness of about 0,8 mm. The insulating glass support was chosen due to its transparency for possible optical measurements. Because of a poor thermal conductivity of the used glass wafers the difficulties with dicing occurred. Therefore, the glass support was

exchanged by silicon wafers (N-type) commonly used in the semiconductor industry. The thickness of the wafer was about 600 μm . Its surface was thermal oxidized to create an insulating layer of SiO_2 with a thickness of about 0,5 μm . The metallic layer Pt or Au (there were two kinds of electrodes produced, Pt and Au) with the adhesive layer were sputtered on the oxidized surface and formed by standard lithographic techniques to the shapes of required electrode topology.

The first designed electrode had a round shape with active area of 0,385 mm^2 , shown in Fig. 14. The connecting wire, between the active part of the electrode and the contacting pin was 10 μm thin in order to obtain a negligible addition of its area into the active electrode area (by dipping into solution). On the other hand, the serial resistance was higher and typically for this electrode it was about 60 Ω (this electrode was initially designated on glass substrates, where was no possibility to form a mask layer and to determine the active area of the work electrode). This electrode was designed especially for amperometric and voltametric measurements (usually performed in aqueous electrolytes or solutions, where the electrode area influenced electrochemical currents (capacitance) flowing through these electrodes, thus the currents were higher for electrodes with larger active area).

Other kind of work electrodes with rather different topology determined for chemoresistors and conductivity sensors [30, 31, 145] were interdigital electrodes. These electrodes were used for measurement of electrical conductance (resistance). The most used topology of the interdigital electrode was standard interdigital electrode for two-point measurement (IDT2), its topology is shown in Fig. 15. The interdigitated strips had a thickness of about 5 μm and the gap between them was about 5 μm , shown in Fig. 17, right. The several doubled strips with thickness of about 10 μm (2 x 5 μm), corresponded to the interdigital electrode for four-point measurement (IDT4) shown in Fig. 16 (in order to get similar topology of IDT2 and IDT4, for easier comparison).

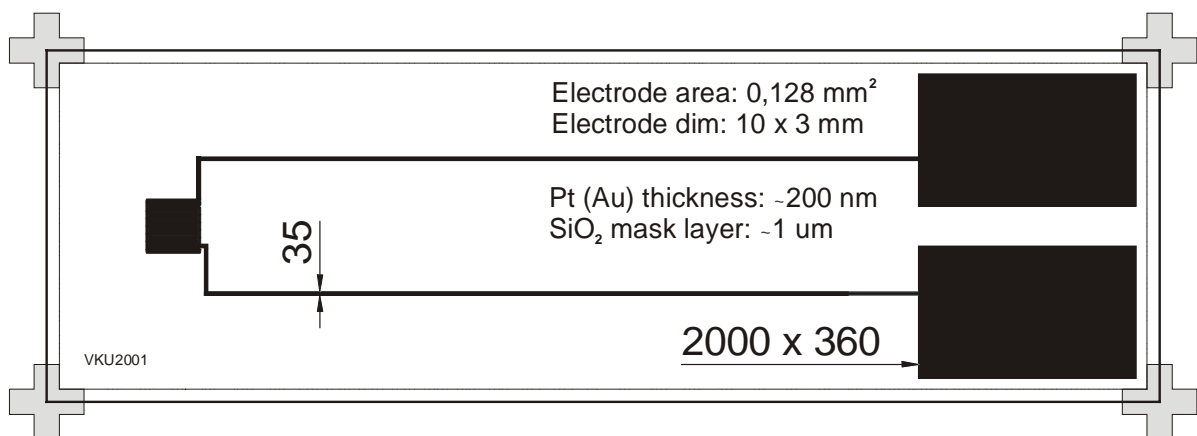

Fig. 15. Topology of interdigital electrodes for two-point conductivity measurements (IDT2), dimensions in μm

The improved IDT4 electrode gives the possibility to monitor the polymer/electrode interface effects and to distinguish between the bulk conductance (material property) and contacts. The “folding” of the traditional four-strip structure into the interdigital structure [146] provided the most effective use of the electrode area. The layout of the IDT4 electrode was similar to the IDT2 only two additional strips were added for sense connection (measurement). The measured capacitance between neighbor electrode strips was about 60 pF and capacitance between the single strip and semi-conducting support was about 130 pF (so the capacitance of about 500 pF was measured between support and all interconnected electrode strips). These values corresponds to the topology of the IDT4 electrode, including contact pads, and to the thickness of the oxide layer. The electrode topology was performed under AutoCAD 2000. Design of mentioned single electrodes and their technical design can be found in [147]. The measurement of material conductivity involving the IDT2 and IDT4 is described in chapter 3.

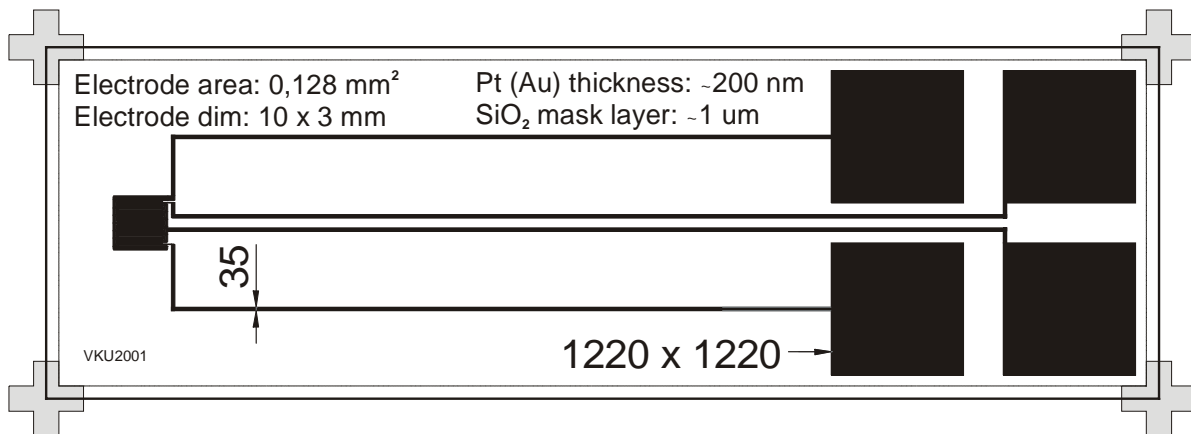

Fig. 16. Topology of interdigital electrodes for four-point conductivity measurement (IDT4), dimensions in μm

These single electrodes allowed performing only single experiments, where each of them was done individually. This involved longer preparation time, higher probability to make mistakes and also the experimental conditions could be different even for repeated experiments (because of different pressure, temperature, air contamination etc.). Therefore, in order to decrease experiment time and to keep nearly the same experimental conditions for all experiments, the electrode array with numerous electrodes based on the single IDT4 electrode topology was the best choice.

2.1.5 Direct electrode array with 96 interdigital electrodes

The single interdigital electrode for four-point measurement mentioned above was used as the base element for the electrode array. The number of single electrodes formed on the array support and the EA dimension corresponded to the specification of the YAMAICHI, IC51-4364-1221-1 test clamp socket [148]. This test clamp socket, placed on the interface board (described in chapter 2.3), was used to connect the array to the electrical part of the set-up. According to the socket specifications the electrode array had square size of 60,8×60,8 mm, this corresponded to the surface area of about 36,97 cm².

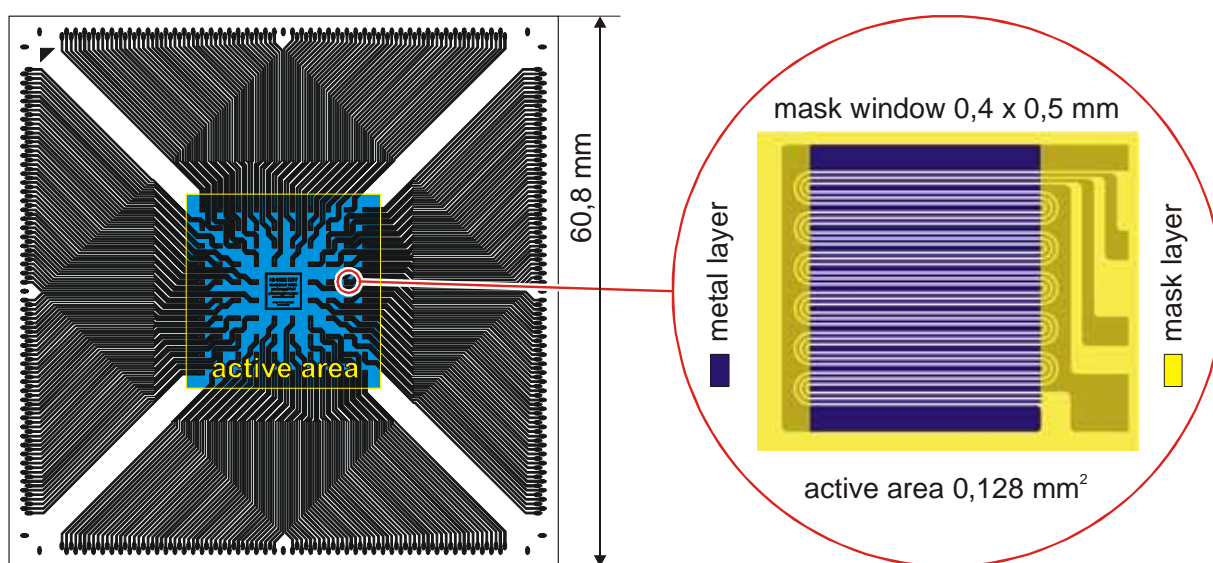

Fig. 17. Topology of electrode array, involving 96 interdigital electrodes for four-point measurements

However, the total area of the electrode array (EA) was 36,97 cm², only area of about 4 cm² was used. It corresponded to the active area of the EA (20×20 mm, shown in Fig. 17, right, the area which was in direct contact with reagents in the electrochemical cell).

The electrode array was fabricated similar as single electrodes described above by standard lithographic techniques used in the semiconductor industry. The support material, n-type silicon wafer with diameter of 150 mm and thickness of 500-600 μm, was thermally oxidized to create an insulating SiO₂ layer on its surface (several μm). Then the platinum layer was sputtered onto the oxidized surface and lithographically modified to form required topology of the electrode (metal) layer for all electrodes, shown in Fig. 17. The previously used platinum layer with thickness of about 150 nm was too thin; this resulted in the considerable damage of contact pins (round, on the electrode array) after first contacting. Therefore, the thickness of the platinum layer was further increased up to 250-500 nm. Nevertheless, it would be better to use even thicker metal layer especially for contact pins to improve their mechanical

properties and so getting possibility of re-using of electrode arrays for more then several experiments (avoiding mechanical damage of contact pins). Finally, the mask layer (SiO_2) with thickness of about $1 \mu\text{m}$ covered the whole electrode array and protected not active regions of the EA (including interconnection wiring of the strips of the electrodes with contact pins around). Etched holes in the mask layer had defined size (Fig. 17) so opened and defined area of the each single electrode. Thus all electrodes had an identical area, this was important for electrochemical synthesis, because the electrochemical charge (related to the thickness of the polymer layer) was dependent on the electrode area. Here, the area of about 4 cm^2 involved 96 interdigital electrodes for four-point measurements topology, organized in ten rows and ten columns, with the spacing of 2 mm among each other (four electrodes in the middle of the electrode array were missing). It meant $96 \times 4 = 384$ single pins and corresponding contacts were presented on the EA.

Two electrode arrays and more than 170 single electrodes (various) covered by the mask layer fitted onto the single 150 mm wafer. This design replaced the old one designated to produce only the single electrodes without the mask layer separately. The topology of the improved wafer that involved two electrode arrays and batch of single electrodes is shown in Fig. 18. Detailed technical documentation with AutoCAD® 2000 source files and GDSII patterns can be found in [147].

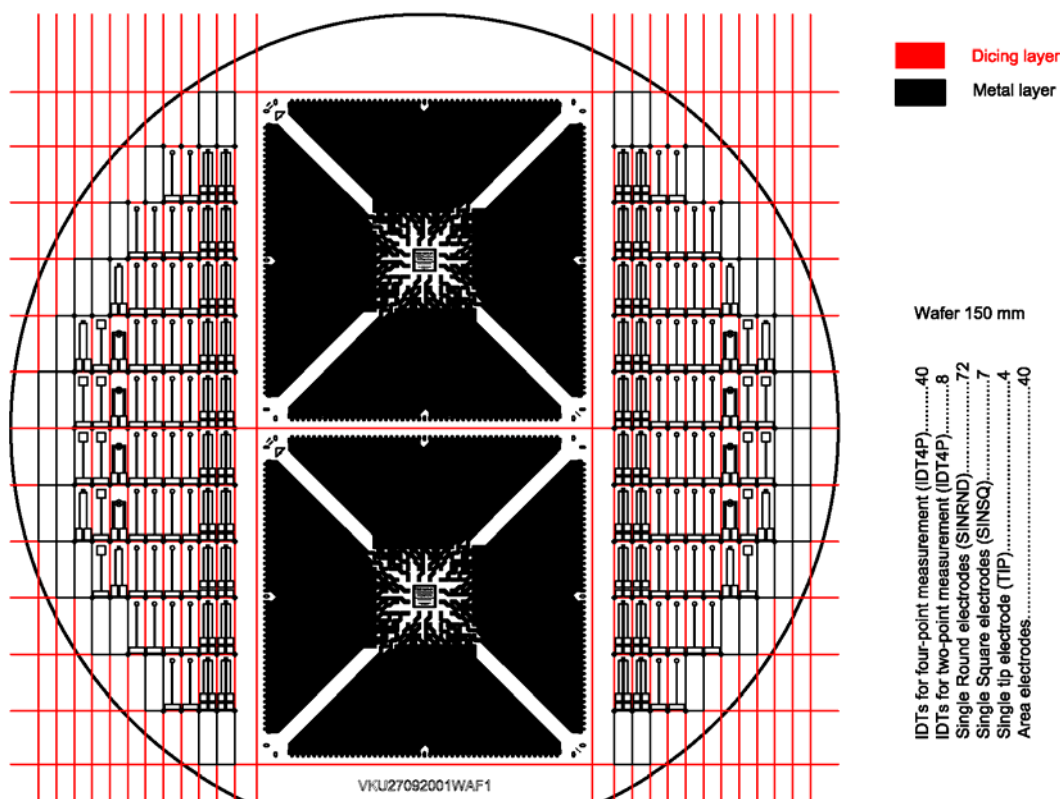

Fig. 18. Topology of the improved wafer involving two electrode arrays and single electrodes

2.2 Preparation of target analyte, dosing station

The dosing station, schematically shown in Fig. 19, provided a mixing of polymerizable substances and additives, a delivery them into the electrochemical cell (EC) for electropolymerization and finally, after completion of an electropolymerization step, a cleaning of the liquid-flow system. Dosing pumps (DP) from reservoirs (A, B, C, and D) individually injected up to four different monomers or additives into the mixing chamber (MC). Then the mixture was driven by underpressure formed by the peristaltic (P1, Gilson Minipuls 3) pump into the electrochemical cell (EC), where the electropolymerization process occurred. The electropolymerization was gradually repeated for each single interdigital electrode of the electrode array (EA), until a polymer of specific chemical content, defined in the library file coated every electrode.

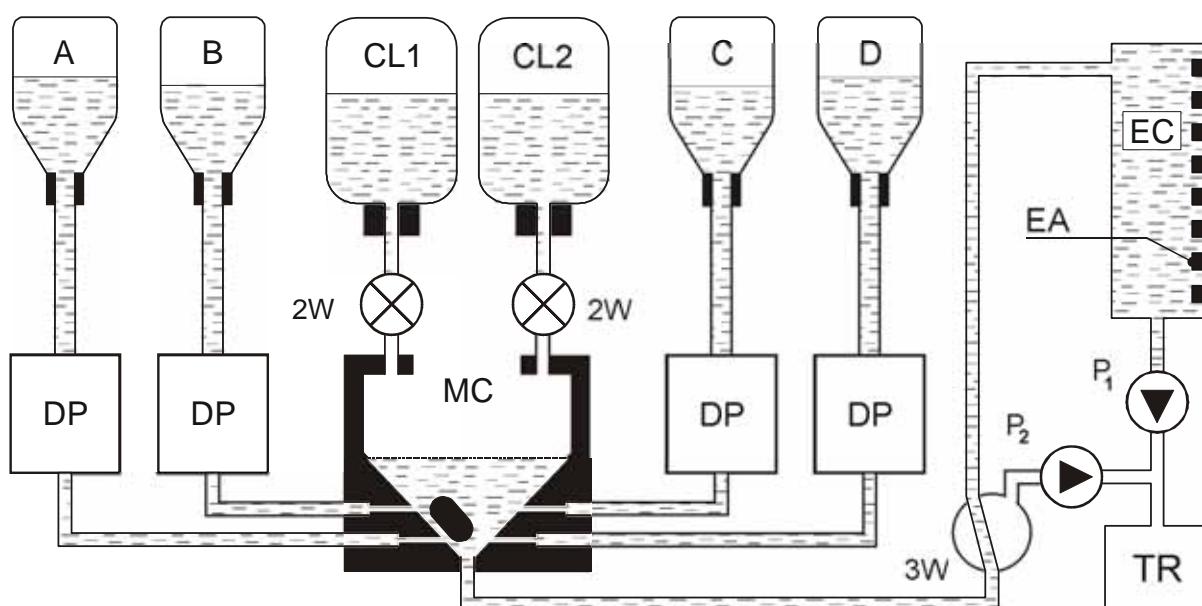

Fig. 19. Electropolymerization set-up including the dosing station, the electrochemical cell (EC) and the electrode array (EA)

The dosing pumps used in presented design were syringe type, low cost Schott Titronic Universal 20 mL (delivered by Schott Germany). The syringe volume was 20 mL and its step motor had 2000 positions so the minimum dosing volume was limited to 0.01 mL. One had to take in to account that the dispensing precision depended on the dosed volume. Therefore, one had to plan an experiment with care and search for optimal volume and concentrations of analytes involved in the experiment even before their preparation. It was possible to use higher volumes up to 5ml (currently optimized for 2 ml) that could be mixed in the MC, only the timing should be adjusted in the electropolymerization software (chapter 2.6) to prevent leakage of chemicals from the MC. The dead volume of the pump was approximately 4-5 ml,

this corresponded to the rest of the solvents remained in the vertically oriented syringe after emptying the pump. These chemicals would have to be manually removed after each combinatorial experiment (e.g. by water vacuum pump- non toxic analyte, or carefully with a syringe). It was possible to unplug the syringe for cleaning purposes, see the Schott Titronic manual [149] for more details. In general, each combinatorial experiment was followed by cleaning procedure, when the used pumps were rinsed with 100 mL of Millipore water (5 times by the full volume of 20 ml). The remaining water from the syringe was removed by water vacuum pump. If the following experiment used different analyte, the syringe was unplugged and cleaned in a mixture of conc. KOH and isopropanol. The practical realization of the dosing station before mounting in to the set-up rack is shown in Fig. 20 (the flask CL1 and CL2 are not in the right position, shown only for illustration purpose). The final design of the dosing station integrated into the electropolymerization set-up is shown in Fig. 19 (chapter 2).

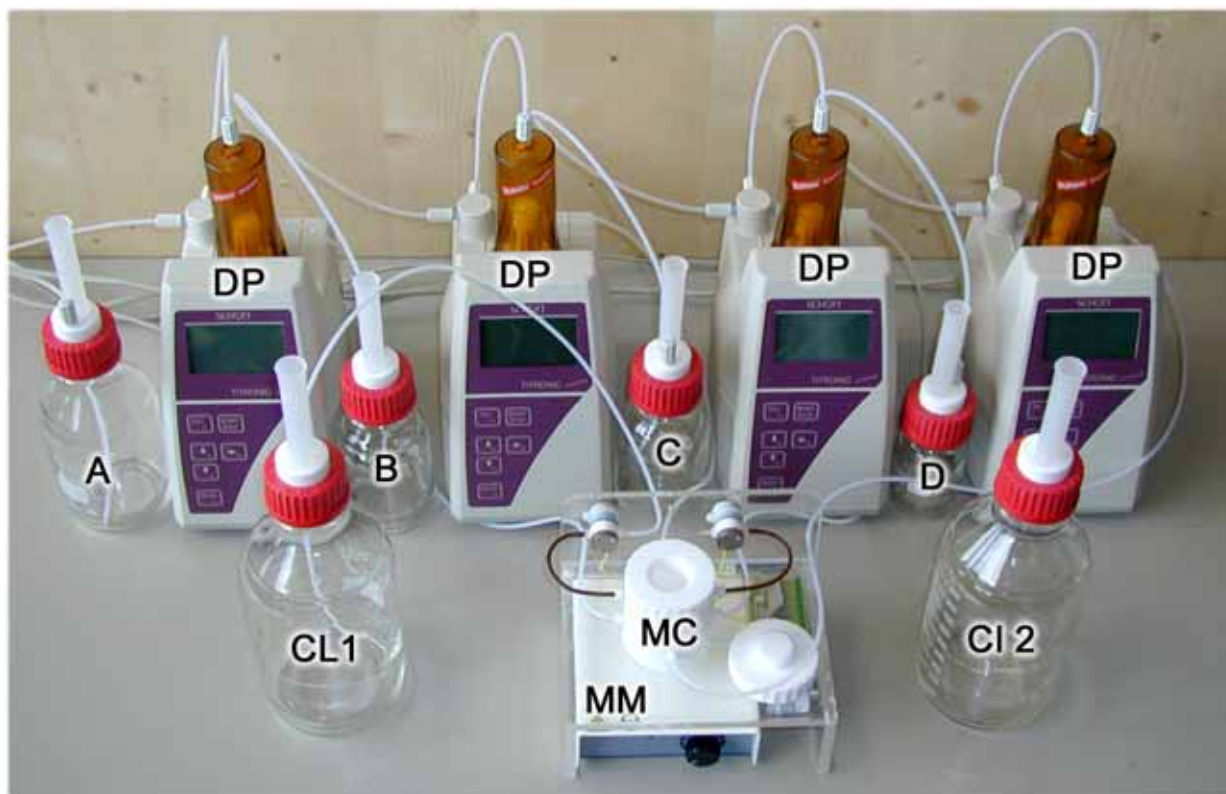

Fig. 20. Initial design the dosing station with all components

All operations of the dosing station, involving transport of defined volumes of reagents from the reservoirs, with the help of precise dosing pumps, to the mixing chamber, followed by stirring and transport of final analyte, by underpressure created by peristaltic pump P_1 (Fig. 19), into reaction cell were completely synchronized by the electropolymerization software (described in chapter 2.6).

The dosing station removed the remaining liquids from the reaction cell (and from the MC and tubing) and cleaned the liquid system, including the mixing chamber, reaction cell and transporting tubes by two cleaning liquids (usually, organic solvent and water from reservoirs CL1 and CL2, placed higher than the MC level, shown in Fig. 20) after completing of each electropolymerization step. The peristaltic pump P_2 provided a fast removal of the remaining polymerization solutions from the mixing chamber, when the valve 3W (1,6 mm from NR Research) was switched in lower position. The valves and peristaltic pumps were controlled through a power module of the Multiplexer 96 instrument (chapter 2.4.1), which increased the output current up to the required values.

Mixing chamber (MC), shown in Fig. 21, was made of Teflon; it had two inputs (CL1, CL2 IN) in upper part for cleaning solvents, four inputs (A-D IN, B, C not visible) in lower part for analytes and one output (OUT). The inputs for analytes had diameter 0,6 mm in order to minimize diffusion process during the mixing, because they were positioned under the liquid level, shown in Fig. 19 and Fig. 21, left. The inner part of the MC had lower tip oriented pinnacle shape. The output (OUT) of the MC was at the top of the pinnacle, in order to optimize for appropriate transfer of reagents from the MC and to minimize chemicals remaining in the EC during its emptying. The technical drawings of the mixing chamber can be found (with several views and source files) in [150].

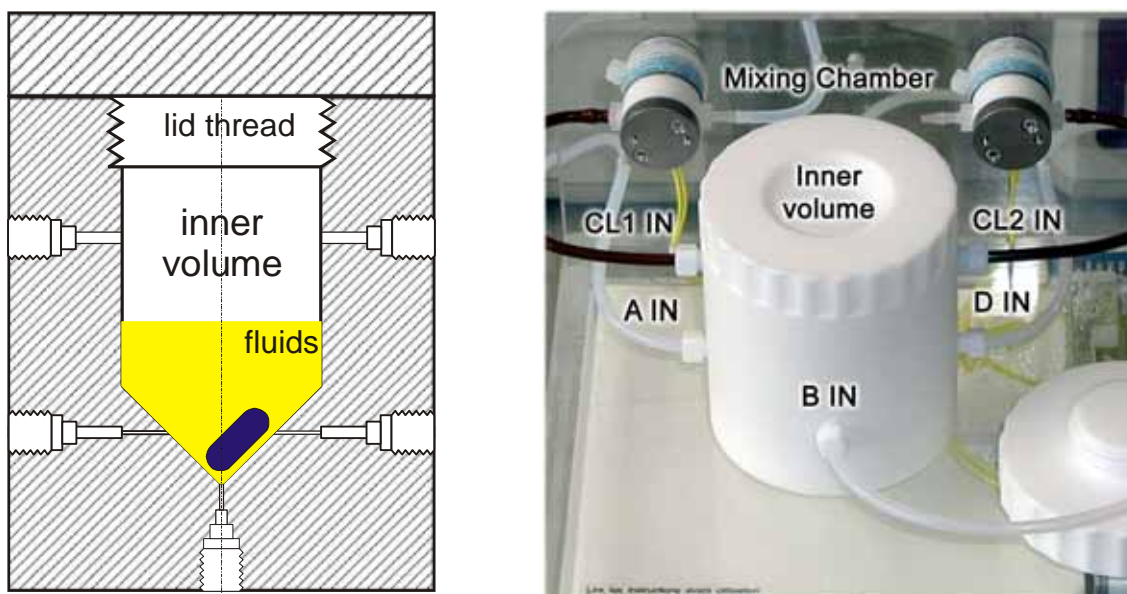

Fig. 21. Mixing chamber, inputs B, C are not visible (left), practical realization of the MC (right)

Solvents were mixed by magnetic stirring in the MC involved in the current electropolymerization step. In the first design of the dosing station a commercial stirrer was used. However, the magnetic field (stirrer too small) was not strong enough to rotate the

stirring bar inside the MC. A stronger stirrer with an appropriate dimension was built from an old motor from a floppy disk drive of an old computer. The magnets were removed from a broken hard disk (head positioning motor). These parts were most appropriate (the motor had constant turns, adjustable by resistor at the PCB and magnets from HDD were strong enough considering their size) for such stirrer. The magnets were glued on the plastic part, which separated the magnets from the metal surface of the disk motor. The magnets affected the motor therefore the distance should be larger than 5 mm, the larger distance meant the less interference and longer stirrer life. The disk motor required DC 12 V for operation, its current was less than 200 mA (this depended on mixed volume, and motor type). The magnetic stirrer (disk motor plate) was fixed to the dosing station stand (Plexiglas) through the distance shafts of 20 mm, under the MC, shown in Fig. 22, right. The opposite part of the magnetic stirrer, the stirrer bar, placed in the EC was made of a magnet covered by Teflon (standard stirrer bar used in chemistry).

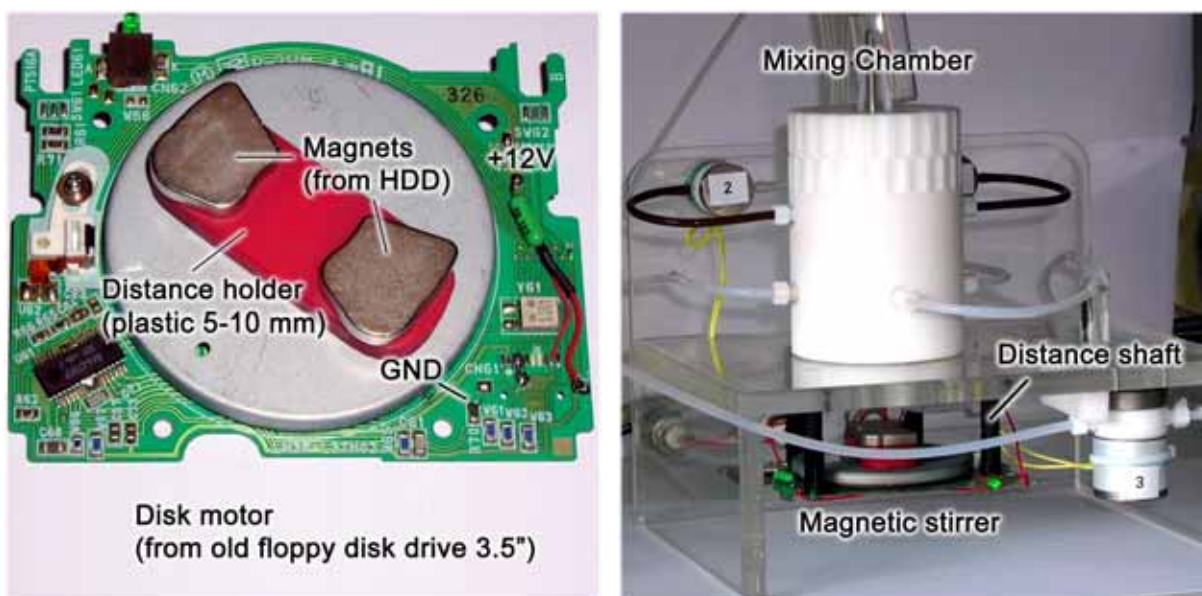

Fig. 22. Disk motor of the self-made magnetic stirrer (left), placement of magnetic stirrer in the dosing station (right)

The cleaning solvents were hydrostatically driven through valves 2W (0,8 mm NR Research). The volume of the solvent involved in one cleaning step was approximately determined by the time during which the corresponding 2W valve was left open. The timing was adjusted in the electropolymerization software so that the software compensated differences caused by different volumes of solvents in the cleaning reservoirs during an experiment.

The precise dosing of cleaning solvents was not required for as much as this was not as critical as the dosing of analytes, and fluctuations of several mL were not significant. Each cleaning reservoir was connected to the corresponding 2W valve through the silicon tubing with inner diameter of 1,6 mm and outer diameter of 3,2 mm, similarly to other liquid-connection of the dosing station. The glass flasks for analytes and cleaning solvents were obtained from Schott, they had different volumes and their size depended on requirements of a certain experiment. In general, the maximum amount of solvents was limited mainly by the volume of the trash reservoir (a flask with volume of about 1 liter). For instance, the minimum amount of chemicals, when each of 96 sensors was polymerized in new analyte is $1,6 \times 96$, this was approximately 154 mL for analytes, and approximately 300 mL for cleaning solutions (when 3 mL per cleaning was used after electropolymerization of each electrode). However, one could make electropolymerization with just one (to create 96 identical polymer structures) or several analytes (to create of groups of identical structures, when statistical scattering was point of interest and the analyte was expensive).

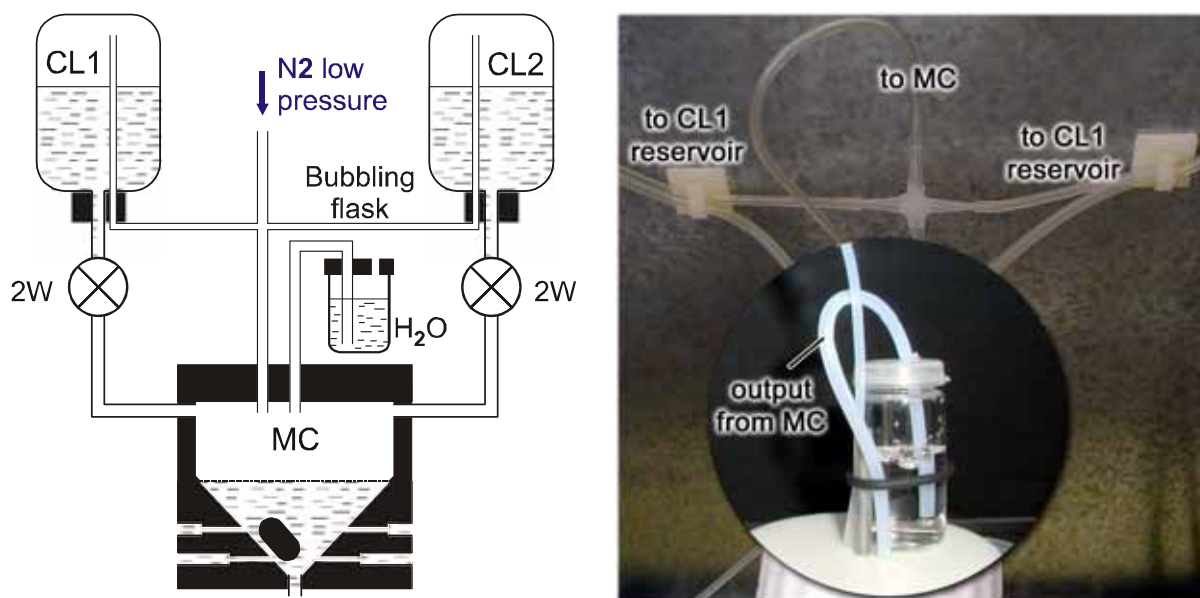

Fig. 23. Nitrogen flow diagram (left) and lead of the mixing chamber with the bubbling flask (right)

The first experiments were performed under the laboratory atmospheric conditions. At that time, the MC was open and reagents were in direct contact with laboratory air during their preparation. To exclude the influence of oxygen and pollution in the air to reagents an MC lid with “bubbling flask” was designed. The lid was screwed to the top of the MC and closed its inner volume. The input of the lid was connected to low pressure nitrogen flow and output ended under the water level in the “bubbling flask”, attached to the lid (shown in Fig. 23). If the MC lid was attached to the MC, the MC volume was flushed by nitrogen (pressure was

kept at low level by the output placed under water level in the bubbling flask). This modification led to a major improvement of the set-up especially the reproducibility of the sensors (which was poor before). From this time, the electropolymerization was always performed under low pressure of nitrogen flow. The cleaning reservoirs were connected to the input tube of the MC lead in order to create the identical pressure in the reservoirs CL1 and CL2 as in the MC, shown in Fig. 23, left. The reservoirs (reagents and cleaning solvents) were kept at the nitrogen atmosphere too by additional pressure reducers (self-made from syringe needles).

The main advantage of the described flow system was that the liquids were driven by underpressure created by peristaltic pump; this excluded the leakage of liquids from the reaction cell, when the sealing was not appropriate. If the electrochemical cell was not hermetically sealed (closed), the underpressure could not occur and the liquids from the MC were not transported.

2.3 Interface board

The name already reveals that the part of the EP set-up described in this chapter presents the interface between chemistry and electronics. In general, the interface board was the platform where the body of the electrochemical cell was attached to the electropolymerization set-up. It consisted of a printed circuit board with all electrical interconnections between a test clamp socket and the multiplexer 96, surrounded by two shielding-aluminum plates. The test clamp socket YAMAICHI, IC51-4364-1221-1, shown in Fig. 24, left, electrically interconnects all working electrodes of the electrode array with the Multiplexer 96 through this interface board. The socket had 436 independent contact pins (made of Beryllium Copper (BeCu), gold-plated over Nickel) with a pitch of 0,25 mm (considering neighbor pins) organized in two rows around the sides of the socket, shown in Fig. 24, right.

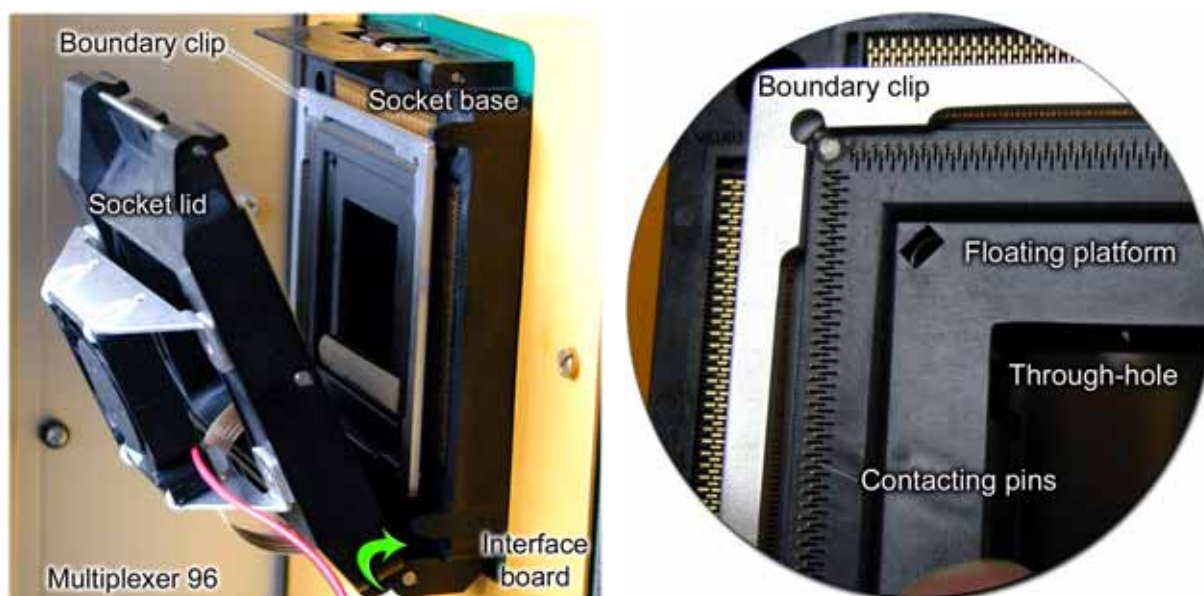

Fig. 24. Test clamp socket (left), detailed view of contact pins of the socket (right).

The socket consisted of three main parts:

i) The base part fixed all contact pins and held the whole socket lid. The base was mechanically attached to the printed circuit board (PCB) by four M3 screws from the front side. The screws passed through the base of the socket and the PCB to the corresponding centering shafts. The centering shafts shown in Fig. 25, right were necessary for attaching the electrochemical cell (EC) platform to the electrode array (EA), this is described in chapter 2.1.3. All contact pins were brazed to the PCB board, thus interconnected with a straight connector with 392 gold-plated pins, formed directly on the PCB, shown in detail C of Fig. 26,

right (it was similar to the mail straight connector used as PCI connector in computers; this is described in detail in chapter 2.4.1).

ii) The floating platform fixed positions of all contact pins, maintaining exact distance of each pin from other and allowing movement of the pins across the axis perpendicular to the EA surface. This part could be removed for cleaning of the contact pins, in the case of leaking of liquids from the electrochemical cell (EC), (please refer to the YAMAICHY support).

iii) The socket lid pushed the electrode array against the contact pins as well as electrically attached the EA array to the socket. The clam determined the pressure, applied to the contact pins / the EA interface and also made electrical interconnections of all working electrodes of the EA with the multiplexer 96. This pressure (when socket lid was locked) led to shift of about 0,2-0,5 mm (considering the unlocked state) of all contacts of the socket, perpendicular to the EA surface. The lid construction is described in detailed in the thermostat chapter 2.5.1. The lid was fixed from the bottom side to the socket base allowing its turning, around the bottom axis shown in Fig. 24, left, in angle of 0-100° considering the EA surface (Fig. 24, left the lid opened to about 30°).

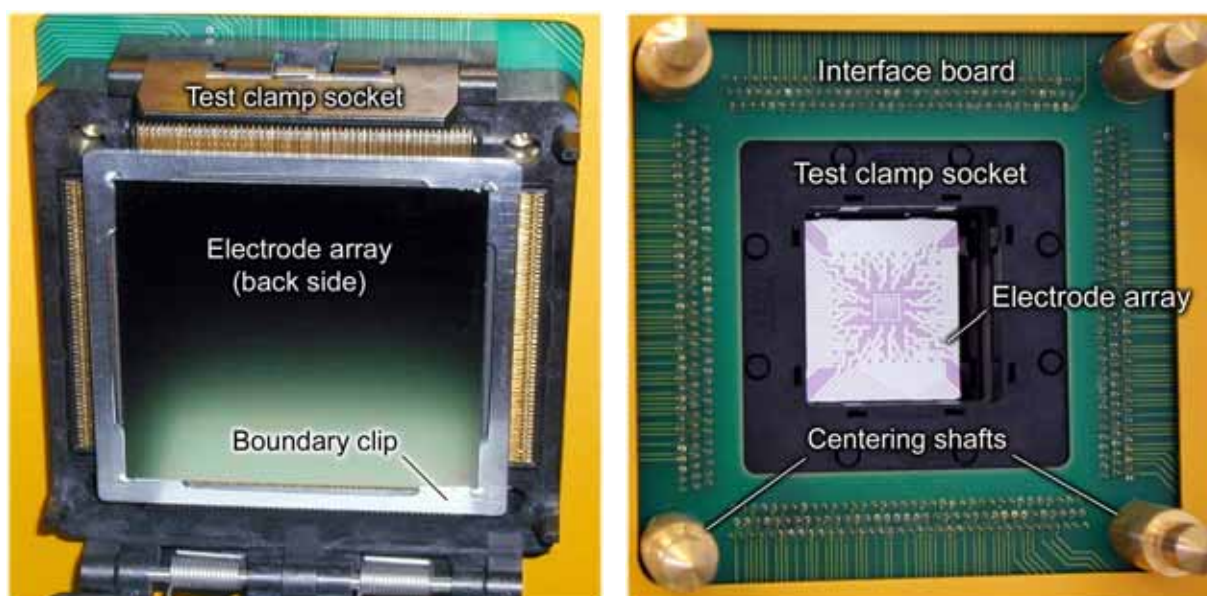

Fig. 25. Detailed view of the interface board, front view with the inserted electrode array (left) and rear view with attached electrode array without electrochemical cell (right)

The square shaped through-hole crossed the base and floating platform of the socket, shown in Fig. 25, right (the previous floating platform was mechanically modified; four guide pins in the corners were removed and its through-hole was enlarged because it had had smaller dimensions comparing to the base part). The modified through-hole had dimensions of 30 x 30 mm, this determined the active area of the EA to be 20 x 20 mm. It means that the through hole was the only limitation for determining the active area of the EA. The EA was

centered in the socket with the help of a boundary clip, shown in Fig. 24, right and Fig. 25, left, designed for dimensions of the electrode array of 60,8 x 60,8 mm. Therefore, the dimension of the electrode array should be 60,7 mm \pm 0,1 mm. If the EA was larger then the mentioned dimensions, it did not fit also if the array was too small contact problems occurred. (electrode arrays were diced in production this gave them sharp edges, this caused problems during inserting the EA in to the boundary clip of the socket. Therefore it was necessary to polish the sides before cleaning the EA). The boundary clip was made of aluminum plate, due to its simple treatment and low weight. Presented clip was already the second design, it was found that the special shape of the boundary clip was important because of previous problems with inserting of the EAs. Therefore, the inner sides of the boundary clip touched the EA only in the corners, this can be detailed seen in Fig. 24, right. The boundary clip was attached in corners by double-sided adhesive tape to the floating platform of the socket, this allowed easier detachment of the clip in case of needed replacement.

As mentioned above the interface board was electrically interconnected with the Multiplexer 96 through the PCB connector with more than 300 pins. It required a lot of force to plug the interface board in to the Multiplexer 96. To prevent the damage of the interface board and simplifying of plug and unplug processes the handling system was designed. Briefly, there were two handles, shown in Fig. 26, right used to reduce strength for plugging and unplugging the IB. The handles fixed to the shielding of the IB allowed its possible to turn around the axis situated in the corners of each handle, shown in Fig. 26, right (upper and lower handle are in unplug position).

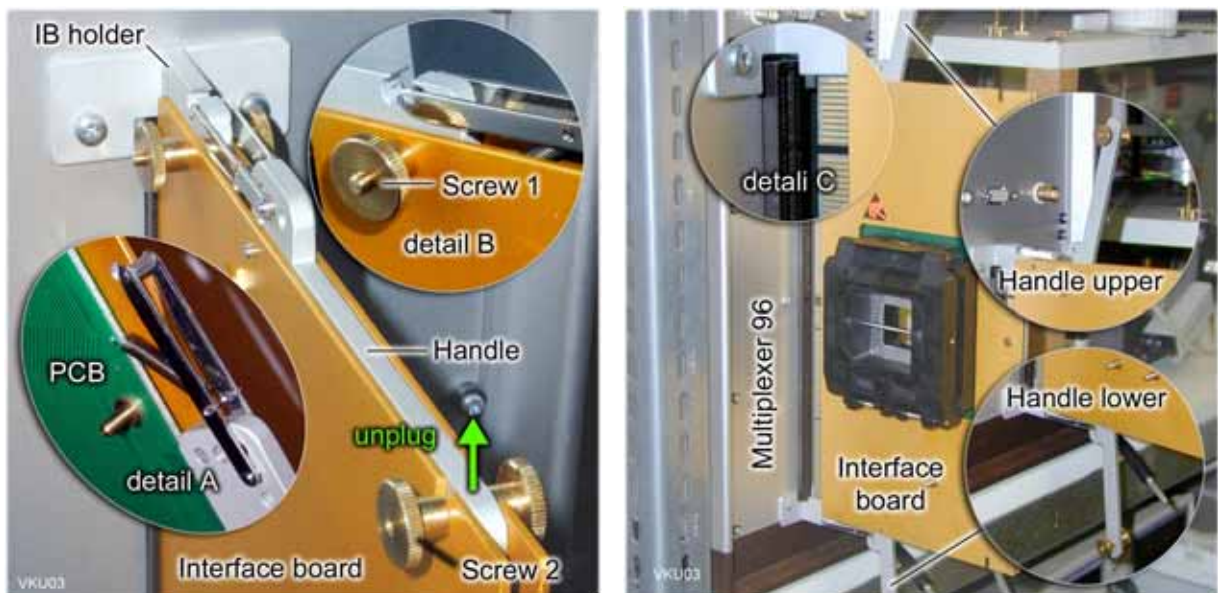

Fig. 26. Handling system of the interface board with detailed views (left), unplugged interface board with detailed view of positions of both handles (right)

The special construction of handles shown in details A, B of Fig. 26, left allowed removal of the whole IB after unplugging from the set-up. The Fig. 26, right remarks the unplugged IB with detailed view of positions of both handles and detailed view of the straight IB connector (detail C). Short advance for the handling system (upper handle); The screw 1 and the similar one in lower part of the IB (Fig. 26, left) should be removed before plugging or unplugging the IB. The screw 2 (Fig. 26, left) fixed the handle, if it was screwed against clock rotation the handle could be released and shifted in direction indicated by arrow (unplug) and so unplug the IB from the Multiplexer 96, shown in Fig. 26, right. Warning: during unplugging / plugging both handles must be used simultaneously. More detailed views can be found in [151], PCB design in [152].

2.4 Electronic system, electrical addressation

The electronic system consisted of a high-impedance electronic multiplexer (MX96), a source monitor unit (SMU), the interface board (IB) with the test clamp socket (YAMAICHI) and a miniature thermostat for stabilization of the electrode array (EA) temperature. The circuit for electropolymerization corresponded to the classical circuit of the three electrode electrochemical potentiostat with the multiplexing work electrode, already mentioned before. The Keithley K2400 (SMU) was used instead of a commercial potentiostat due to the expansion of the electropolymerization (EP) concept to four-point measurements. The configuration, shown in Fig. 27 outlines the connection of the SMU to build-up the potentiostat in the EP set-up. The SMU output (Source Hi) was attached to the SMU input (Sense Hi) and so formed the electrical connection for the work electrode, electrically addressed by the MX96. The SMU output (Source Lo) was connected to the auxiliary electrode and the SMU input (Sense Lo) to the output of a buffer amplifier. The buffer amplifier was used to create high impedance input for the reference electrode; however, it is already implanted in the K2400, the signal from the buffer amplifier created an artificial system ground used for referencing of the voltage source V_x .

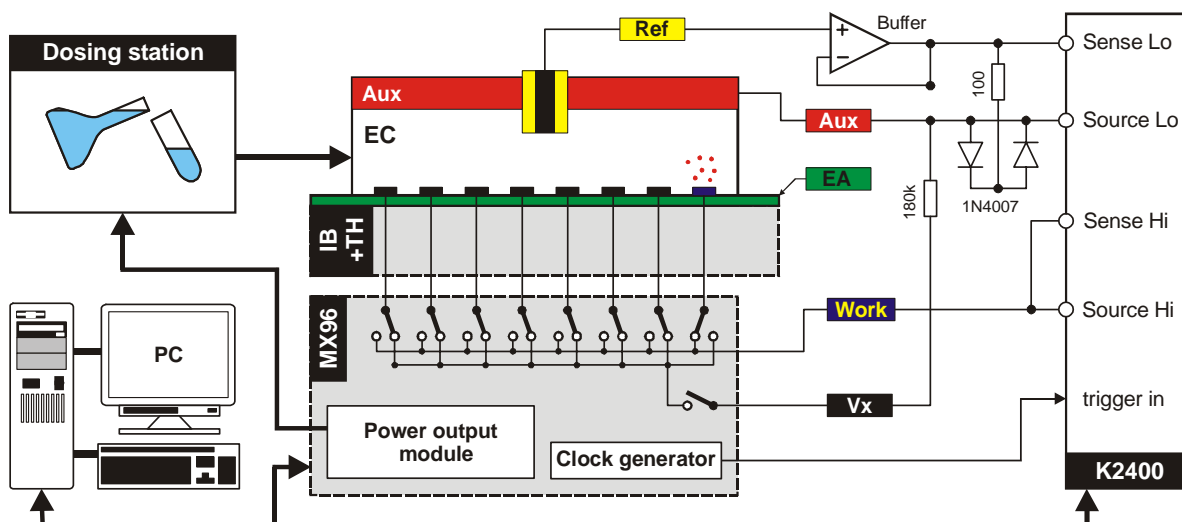

Fig. 27. Source monitor unit as the potentiostat in the electropolymerization set-up

This configuration allowed to use the SMU as the standard potentiostat, where the voltage between the reference electrode and the work electrode was kept constant and the current that flowed through the work electrode was measured. Additionally, it was possible to apply other electrochemical methods such as galvanostatic, potential sweep (cyclic voltammetry), pulse and others. This required only different software to control the EP set-up (due to the circuit covered all requirements, no hardware reconfiguration was necessary).

Because the electrode array was formed on the semi-conducting support and the insulating SiO₂ layer between the support and metal electrode layer was in range of micrometers, it resulted in unexpected artifacts during the electropolymerization. Especially, polymerization on single work electrode affected neighbor electrodes so they were polymerized too. It was necessary to protect the electrodes where the electropolymerization should be avoided. The initial idea (how to protect these electrodes) was to connect them together and apply a potential (so called protective potential V_x) out of the electropolymerization range to them. The protective potential should be referenced to the artificial ground, this potential corresponded to the potential of the reference electrode. The first experiments with high conductive electrolyte were based on electropolymerization of aniline ($V_p=+0.9$ V, $V_x=0$ V vs. reference electrode). They demonstrated the application of the protective potential (or connection of protected electrodes to the artificial ground, $V_x=0$ V), but did not help as expected before. Problems were caused by the potential distribution in the electrochemical system, which is outlined for two different systems (aniline and Prussian blue [153]) in Fig. 28, right.

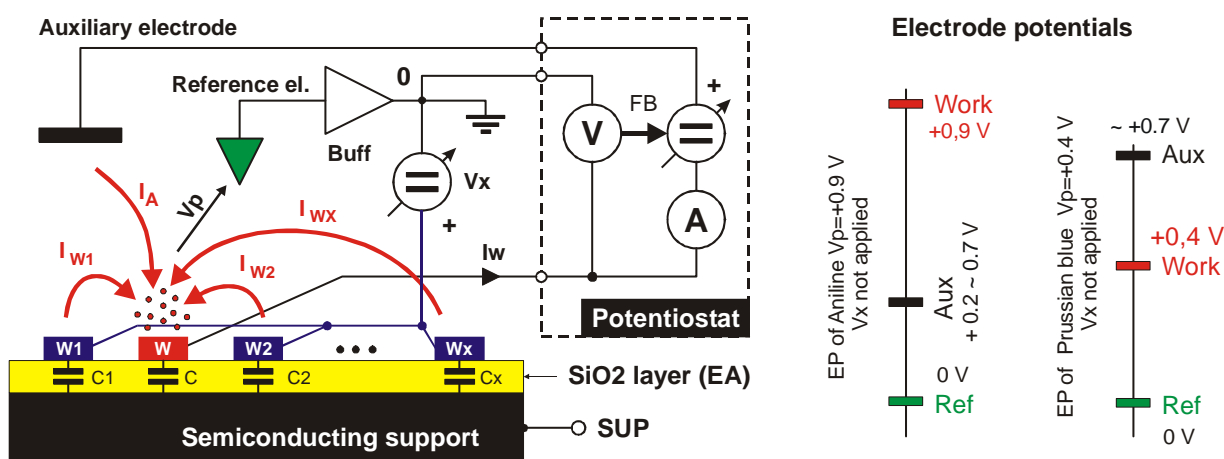

Fig. 28. Model of the electrochemical cell with the electrode array, central reference and auxiliary electrode (left), potential distribution for two electrochemical systems (right)

The potential of the auxiliary electrode (for experiment with aniline) was above the reference level unlike the expected situation where the auxiliary level should be below the reference one. It could be overcome by application of a different suitable potential V_x , as schematically shown in Fig. 29 for the single two strip electrode. Generally, it was difficult to find an optimal potential for different target reagents. Rather different situation occurred for the EA, where the distribution of the electrodes in the designed electrochemical system (with the central reference and auxiliary electrodes) was not homogeneous for all work electrodes (Fig. 28, left). The application of a non corresponding V_x potential, in most cases, led to the damage of the mask layer of the protected electrodes, shown for single work electrode in Fig. 29, left.

Another idea was to apply the potential of the counter electrode directly to the protected electrodes. It was based on the fact that the current flowed between the auxiliary and the addressed work electrode. If other (not addressed) electrodes were connected just to the auxiliary one, there should be no current flow between these electrodes and the auxiliary electrode. However, in the reality the situation was rather different. Because of the non homogenous distribution of the work electrodes and because of defects in the EA, the current flow was influenced by work electrodes connected to the auxiliary electrode, illustrated in Fig. 28, left. The distance of the auxiliary and the reference electrodes from a random work electrode was not constant. This distance increased from the middle to the sides of the EA and in fact, it was several times bigger then the distance of two neighboring work electrodes. The work and the auxiliary electrodes were made of the same metal therefore the protected work electrodes acted together as an extended auxiliary electrode. On the other hand, because of the mentioned defects in SiO₂ layer between semi-conducting support and the metal electrode layer (scratched, holes in insulating layer etc. Fig. 61, right in chapter 3.3), they modified the potential distribution in the electrochemical system and thus affected whole experiment. Therefore, to apply this idea, the protected electrodes were connected to the auxiliary electrode through the electrical resistor (180k), shown in Fig. 27.

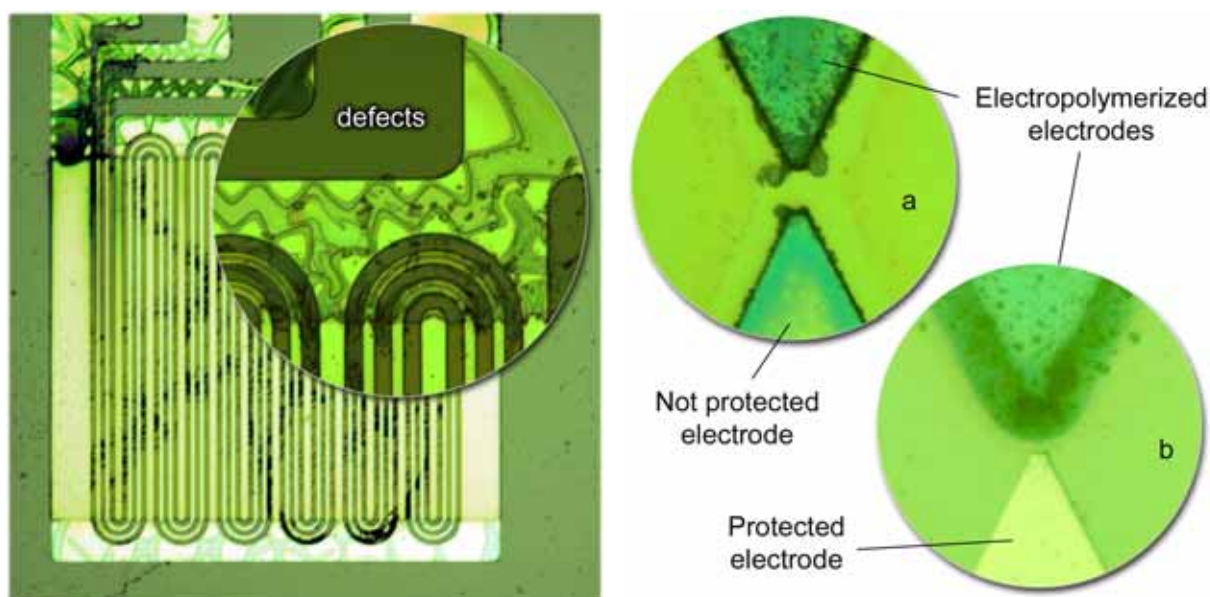

Fig. 29. Defects on EA after application of protective potential V_x (left), electropolymerization under different conditions (a – not protected neighbor electrode, b – protected electrode connected to auxiliary electrode)

This resistor kept the potential of the protected electrodes, outside of the electropolymerization range, close to the potential of the auxiliary electrode (this involved a small current flowed throughout the protected electrodes, caused by defects).

Two diodes (Fig. 27, used 1N4007, threshold voltage in forward direction app.0.75 V) limited the maximum voltage difference between the reference and the auxiliary electrodes in the range ± 0.75 V, in order to protect the electrochemical system against electrolysis and other non expected electrochemical reactions. The value of 0.75 V was observed from previous experiments (Fig. 28, right) based on aniline (0.1 M in 0.5 M H₂SO₄). This limitation voltage varied and could be different for other monomers, electrolytes and for target reagents, especially during formation of copolymers.

To illustrate the real situation, the experiment on a single electrode was done. The electropolymerization was performed on two single fingers of a tip electrode. The monomer involved in this experiment was aniline (0.1 M in 0.5 M H₂SO₄). If the neighbor finger, that should be not polymerized, was not protected (just left unconnected) the polymerization occurred not only on the addressed finger but on the unconnected one too, shown in Fig. 29, right-a. If the protected electrode was electrically connected to the auxiliary electrode, the electropolymerization did not occur on it, so the electrode was protected from undesirable electropolymerization, shown in Fig. 29, right-b.

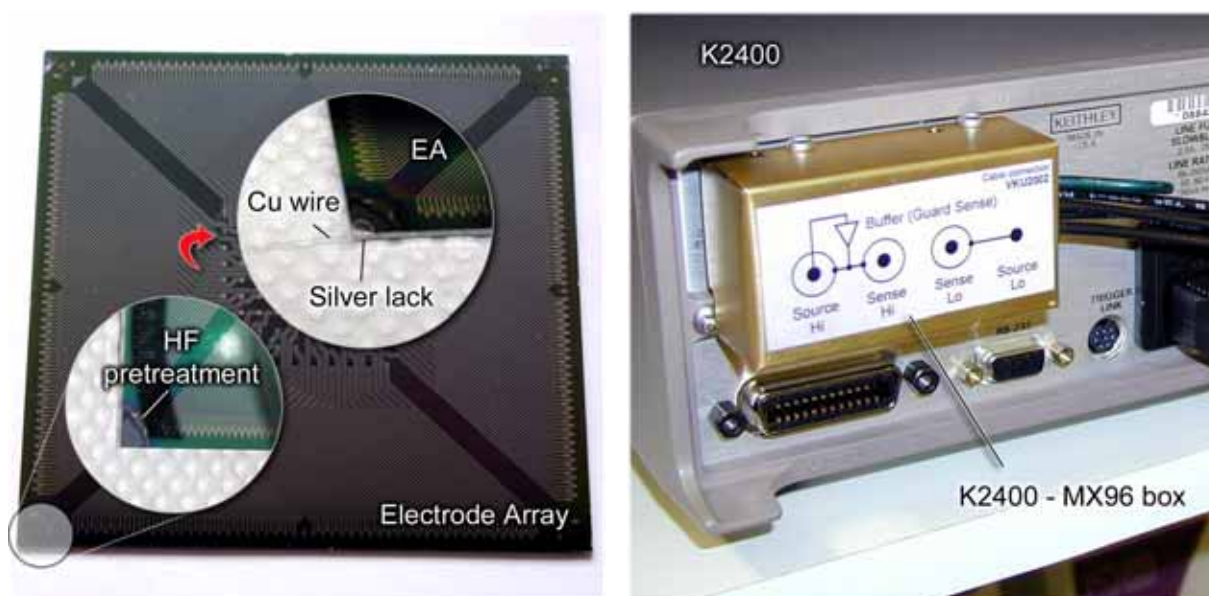

Fig. 30. Electrical connection to the semi-conducting support of the EA (left), K2400-MX96 shielding box (right)

In the case of application of the protective potential to non polymerized electrodes, one had to limit applications by high conductive electrolytes and low electropolymerization currents. This limitation could be overcome by the application of an auxiliary potential to the semi-conducting EA support, to “SUP” connection shown in Fig. 28. Here, according to the electrical model of the EA shown in Fig. 28, left, each work electrode represented one electrode of the disk capacitor and the second electrode was formed by the semi-conducting

support (for all electrodes on the EA). It should be sufficient to connect only the EA support to the auxiliary electrode and protected electrodes just left unconnected or connect them through a high ohmic resistance to the auxiliary electrode. This method was briefly proved, in the end of the project, on an electrochemical deposition of Prussian blue [153], where the first protecting method did not work correctly.

The electrical connection to the EA support was done by a copper wire glued on the back side of the EA by silver lack (paint), shown in Fig. 30, left. Before gluing, the back side (one corner) of the EA was pretreated by hydrogenfluoric acid (HF) for 30 seconds to remove thermal oxide from its surface. Additionally, a new scanning method was involved in the preliminary software, which potentiostatically monitored the modification of the protected electrodes after several electropolymerization steps (could be defined in library file), but this is out of the frame of this thesis.

The multiplexer (MX96) was interconnected with K2400 (the inexpensive version of K238 offered only banana connectors instead of BNC or triax-cable) through the coaxial connections and a K2400-MX96, shown in Fig. 30, right. The box was made of brass plate, which was electrically connected to the K2400 ground, this increased distortion immunity of analog signals. The coaxial cables used that time would be better to be replaced by triax-cables. However, the realized connection partially covered requirements on low current measurements.

2.4.1 Multiplexer 96 (electrical addressation)

The electronic multiplexer included 96 channels, each of them involved a 4A plus a 2B switch configuration, shown schematically in Fig. 31. The 4A configuration (four independent contacts - normally open) was realized by high impedance reed relays MEDER MRE12-4A79-HI. These relays offered the high insulation and off-state resistance - higher than $10^{12} \Omega$, low on-resistance (better than 200 m Ω), high switching current (up to 1 A), switching-on time better than 1 ms, long life-time and high reliability. The 4A switch configuration was used for four-point electrical measurements of already synthesized polymeric combinatorial libraries (described in chapter 3). During electropolymerization experiments, the 4A configuration was not fully used. Additional 2B switch configuration, two contacts - normally closed, was based on solid state relays AD4C212 [154]. They connected outer strips of non addressed electrodes of the electrode array (already coated or still uncoated) with the voltage source (outside of EP range), thus protecting them from undesirable electropolymerization, focused on in the previous chapter. This meant, if one of the electrodes was polymerized (addressed), the other 95 electrodes of the EA were interconnected through the 2B configuration to the potential V_x (exactly, only outer strips of each protected electrode were interconnected). Note, that the potential V_x was applied only if the Multiplexer 96 was set into the electropolymerization mode, this additionally gave the possibility to control the application of the V_x potential to the

protected electrodes. If the MX96 was placed into the measurement mode (after reset or in start-up), then the V_x terminal was electrically disconnected from the non-polymerized work electrodes, however, they stayed interconnected together.

The 4B configuration should be used instead of the 2B in order to interconnect all four strips of the single IDT electrode with the protective potential V_x . The used 2B switch configuration, was a compromise, it interconnected only outer strips of each protected interdigital electrode and left the inner two strips unconnected. Due to the dimensions of the IDT electrode, where the gap between neighbor strips was only $5\ \mu\text{m}$, the potential distribution on inner strips should be close to that one on the interconnected outer strips (due to leakage currents and capacity effects). The solid state relays (based on opto-MOS-FETs) were used due to their size (DIP page), low leakage currents ($<500\ \text{nA}$ max) in off-state, simple implantation into the system (this option was implemented additionally) and low costs.

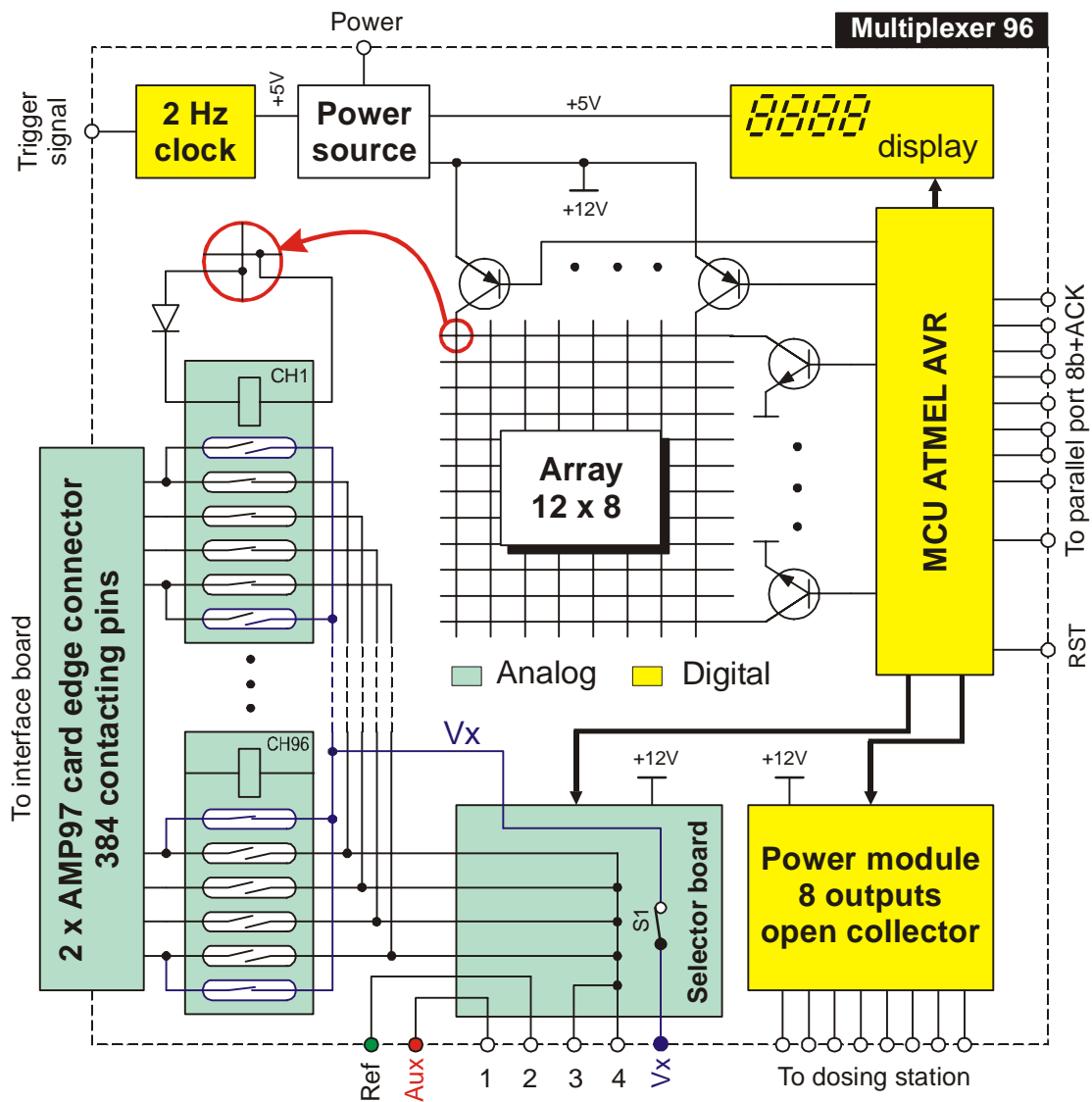

Fig. 31 Multiplexer 96 block schematic, terminals 1, 2, 3, 4 were connected to the SMU

It was possible to build the 4B switch configuration from the solid state relays, but even low leakage currents in sense circuit could affect the four-point measurements. To avoid these leakage currents solid state relays should be replaced by 4B reed relays. In ideal case, it would be better to use 4A+4B switch configuration in one package. However, it was possible to apply single 1A+1B reed relays four times for each channel, the concept was that time still under evaluation and it gave the requirement to apply protective potential as late as the 4A relays were purchased. Therefore, the compromise (2B) solution was used.



Fig. 32. Multiplexer 96, rear and front view (left), detail of MX96 front panel (right)

All interdigital (IDT) electrodes of the electrode array (EA) were connected through the relays 4A+2B, described above, to a selector board. The selector board, which was a part of the MX96, configured the inputs and outputs of the SMU to create electropolymerization, measurement or other supported circuit. If the electropolymerization mode was activated all four strips of the addressed IDT electrode were interconnected and attached to the signal corresponding to the work electrode. Practically, this meant that only the single 4A relay, corresponding to the addressed electrode (channel), was switched on and one 2B relay corresponding to the same electrode was switched off (all other 2B relays were in default on-state, according to the state of relay contacts). This situation is illustrated in Fig. 31, where the channel 1 (Fig. 31-CH1) is activated and the electrode connected to this channel is polymerized, all other electrodes are connected to the protective potential V_x (outlined for one channel 96, Fig. 31-CH96). The selector board connected the inputs / outputs, numbered by 1-4 (Fig. 31) with the SMU and such separated the signals for the work, reference and auxiliary electrodes. Referring to Fig. 27, the reference electrode was connected through the buffer amplifier to the MX96 output “2” (SMU Sense Lo) and auxiliary electrode was connected to

the MX96 input “1” (SMU Source Lo). The terminals for reference and auxiliary electrode (BNC connectors) were situated on the front panel of the MX96, shown in Fig. 32, right, and during EP they were connected to the electrodes of the electrochemical cell. Practically, the MX96 was the key instrument for the electropolymerization set-up where fulfilled not only switching requirements, but also several other tasks. The description of its parts and their practical realization follows.

The electronic multiplexer consisted of following parts; power source, micro-controller unit (MCU), power module, selector board, eight relay boards, clock generator and LCD display, main board and data board.

The MX96 was built in 19” aluminum housing designated for Euro-cards, shown in Fig. 32 and Fig. 33. Because of numerous interconnections, especially for analog modules, the whole design of the analog part was built on the main board shown in Fig. 33, left. This main board (MB) performed the electrical connection between the interface board and each of the eight relay boards. Two card edge connectors AMP97 (female, similar to the connectors used for PCI slots in PCs) were mounted on the front side of the MB. They offered 388 contact pins in two rows to which the interface board was connected. The main board was mechanically fixed to the front plate of the MX96 housing so that the AMP97 connectors were standing-out of the MX96 front panel, shown in Fig. 33, right.

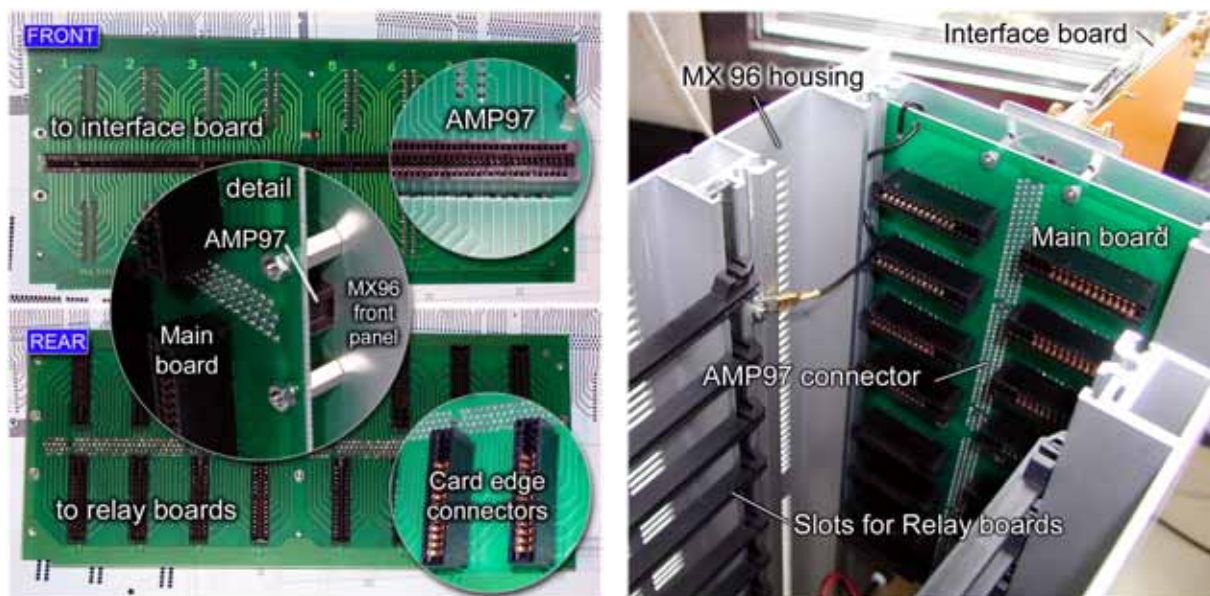

Fig. 33. MX96 main board PCB front and rear sides (left), its implementation into the MX96 housing with the plugged-in interface board (right)

On the opposite side (rear) of the MB, eight pairs of standard card edge connectors (female) with 2x24 contact pins (similar used as ISA slots in PCs, 2,54 mm) were mounted. One relay board occupied one pair of these connectors so that 8 pairs allowed the connection of

eight relay boards. The electrical specifications for the used connectors, especially their insulating resistance was better than $10^9 \Omega$, this was sufficient for building of the MX96 prototype. In the future, the insulation resistance could be improved by using superior connectors and components, but at the expense of the instrument costs.

RELAY BOARDS

Each of the eight relay boards included 12 reed relays of 4A and 12 solid state relays of 2B configuration, schematically shown in Fig. 31 and practically in Fig. 34, left. Standard holders for euro-cards fixed the relay boards to the MX96 housing. The male card edge connectors were formed directly on both sides of the printed circuit board (gold plated copper pads). One side of the board was plugged into the main board and the opposite side, was interconnected with the selector board and with the MCU by flat cables through the female card edge connector, shown in Fig. 34, right. One flat cable, connected parallel all relay boards together with the selector board (analog bus, 4 x signal line and 1 x Vx line) and another connected these boards with the MCU (digital bus). The MCU individually controlled relays on the relay boards through the digital bus. Each relay board had the unique board address configured by the soldering connector (Column selector) shown in detail in Fig. 34, left.

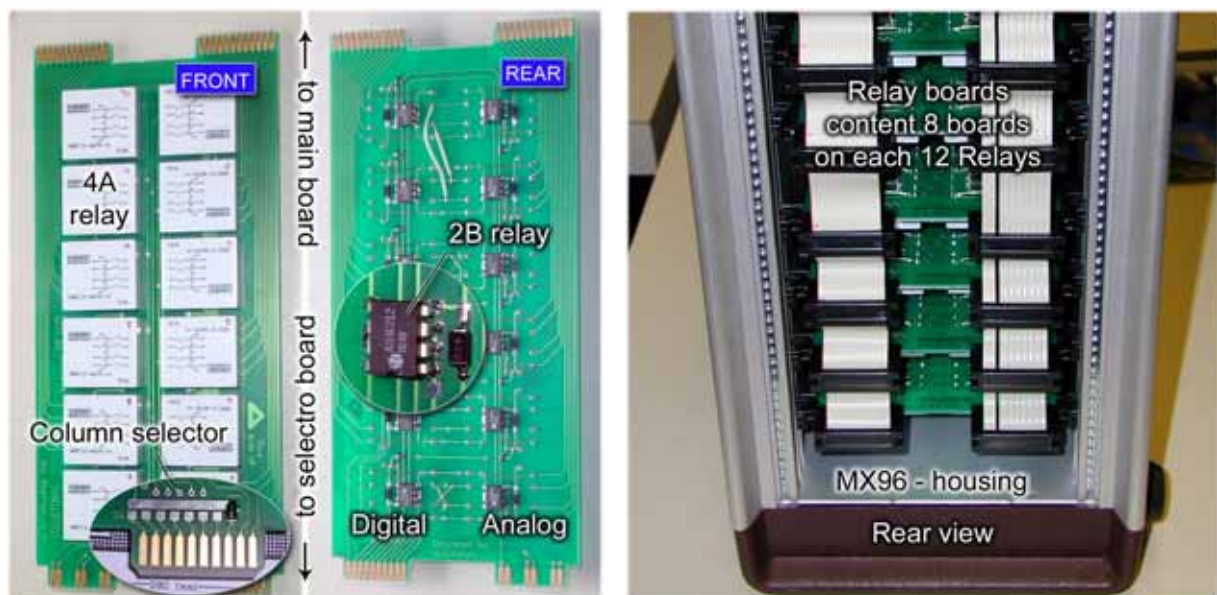

Fig. 34. Relay board PCB front and rear view (left), placement of relay boards in MX96 – rear view (right)

The interconnection of a single of eight pins with the common one of the column selector determined the address of one relay board in the MX96 hierarchy. Thus each board occupied a unique column (only single pin should be soldered, no crossing addresses allowed). If two boards used the same column, two channels of MX96 were activated simultaneously.

SELECTOR BOARD

Similar relays, for relay boards with 4A configuration, were used also in the selector board. The V_x potential was controlled by the MCU with an independent 1A reed relay. The buffer amplifier for the reference electrode was situated on this board additionally (therefore, the recent PCB design did not correspond to the real situation). This buffer amplifier required a bipolar power source, which was realized by a DC-DC converter (Traco Power). The converter generates bipolar voltage $\pm 15\text{ V} / 100\text{ mA}$ from a unipolar 12 V voltage source (MX96). The offset voltage of the buffer amplifier, if required, could be compensated in the EP software (usually it was less than 20 mV for used TL072 differential amplifier with unipolar transistor inputs). Another possibility was to use a self-compensating (zero-offset) amplifier (for instance from Analog Devices, Texas Instruments, Maxim etc.). The flat cable of the analog bus was connected to the selector board through the card edge connector (similar to that one used for the relay boards) where the male part was on the selector board. The opposite side of the selector board, shown in Fig. 35, left (with another male card edge connector) was plugged into the data board, illustrated in Fig. 35, right (note, that photo was done in the beginning of this work, therefore the boards were not completed that time). So the selector board was interconnected through the data board with all required modules of the MX96, especially with the power source and the MCU. Two SMC (Straight plug) connectors (from Radiall) with coaxial cables (length of about 30 cm) were used for interconnection of the selector board with the BNC connectors for the auxiliary and the reference electrode, placed on the front panel of the MX96, labeled by symbols Ref and Aux in Fig. 35, left.

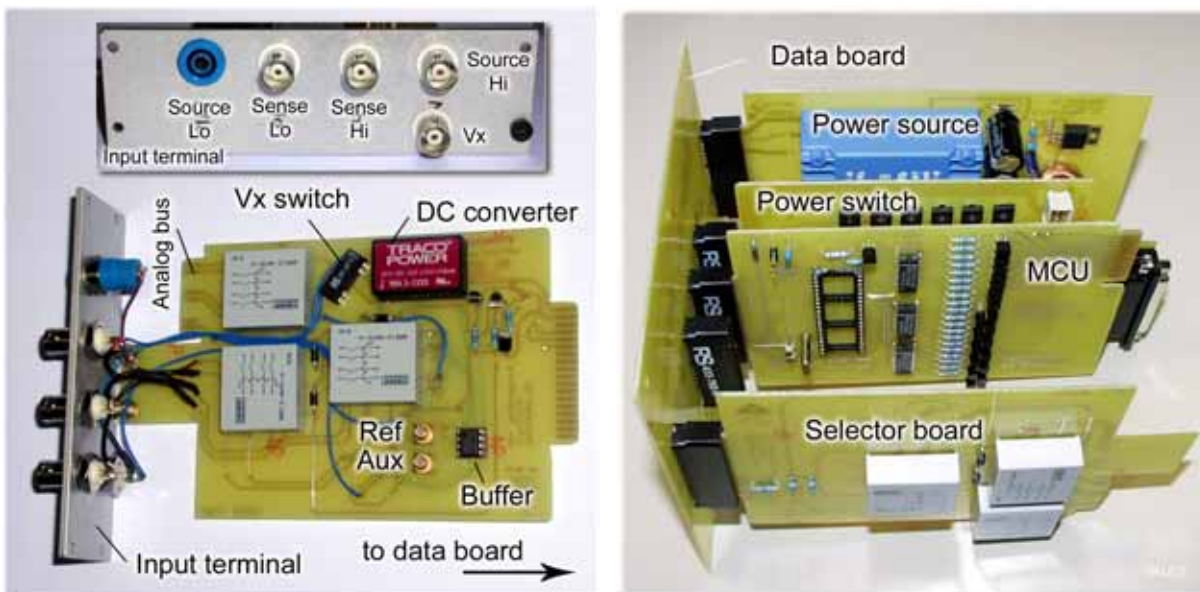

Fig. 35. Selector board, practical realization with rear panel description (left), data board with several single boards plugged-in (right)

DATA BOARD

The data board electrically interconnected the power source, MCU, selector board, power module, LCD display and expansion module (not used). The signals on this board were mainly digital instead of the power lines for +5 V and +12 V. The data board was mechanically attached to the front panel of the MX96 housing and supported the standard euro-card format. All boards were plugged-in and mounted from the back side of the MX96 (Fig. 32, left).

MICRO-CONTROLLER UNIT

The core of the MX96 was realized on an AVR (8 bit) micro-controller AT90S4414 [155] and additional circuitry, placed on the MCU PCB. Its schematic and PCB design can be found in electronic form in [152]. The MCU controlled the whole MX96 according to the communication with PC through the one-directional 8bit parallel port. The data was sent from the computer to the MX96 (the backward communication was not applied, it could be additionally implemented, this was not required that time due to the high stability of the realized prototype). The self-designed communication protocol, completely described with signal specification in chapter 2.5, was not compatible with any standard protocol. It was optimized for one-character instructions in order to decrease communication time. The used one-directional parallel interface could be easily in-system reprogrammed (by supported ISP interface) to another, for instance to standard parallel, serial (RS232), or USB, GP-IB, TCP/IP, etc. Note that the interface change required not only software upgrade but hardware modifications as well.

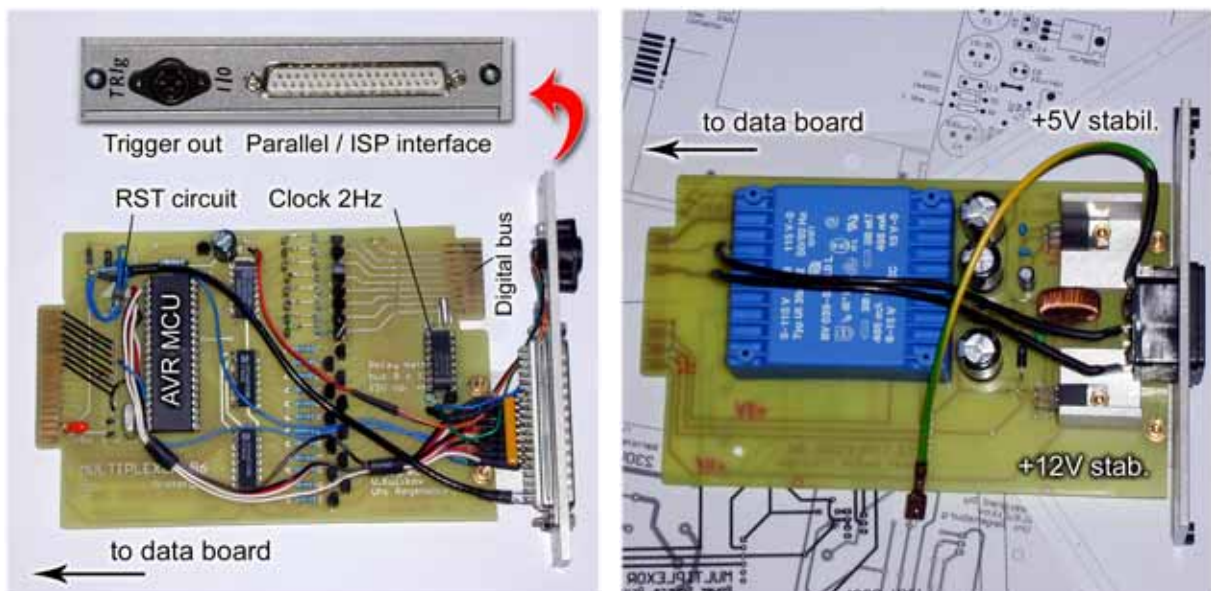

Fig. 36. Practical realization of the MCU (left), power module (right)

The program memory of the MCU (Flash) containing an assembler code (program) could be in-system reprogrammed by ISP interface. This could be done in order to implement new features or improve the MX96 instrument. In this case only ISP programmer AT Mega [156] and the ISP cable with RST switch (both was included with MX96) were required. The latest self-written assembler code (version 0.13) is listed completely in appendix 10.1 and in the electronic form in [152]. It was found that the realized design of the MX96 was optimal due to simple upgrades and implementation of new features. This was done several times during this work, what completely attested the aptitude of the selected MX96 design.

The MCU board, shown in Fig. 36, left, included quartz clock generator with frequency of 2Hz, which was important for time synchronization of the electropolymerization. The generator triggered the SMU, thus synchronized the EP software and allowed data acquisition of two samples (current or voltage kinetic) per second.

The MX 96 was designed for serial synthesis only, where only one out of 96 channels could be addressed simultaneously. It decreased requirements on power consumption of the MX96, which was limited only by consumption of several components and one relay channel (ideal for non-stop operation). The power source, shown in Fig. 36, right, was built on a toroid transformer 40 VA, estimated for coverage of power consumption of the Multiplexer 96 and external valves of the dosing station. The source offered unipolar voltage of two levels of +12 V for relay boards and +5 V for the MCU. Step-down regulator stabilized the 12 V power line with high efficiency (above 80%) and 5 V level was obtained from the 12 V line by continual stabilizer 7805. The limitation current of the source was set to 1 A (limited by step-down regulator) for 12 V power line, this included the consumption from the 5 V level too.

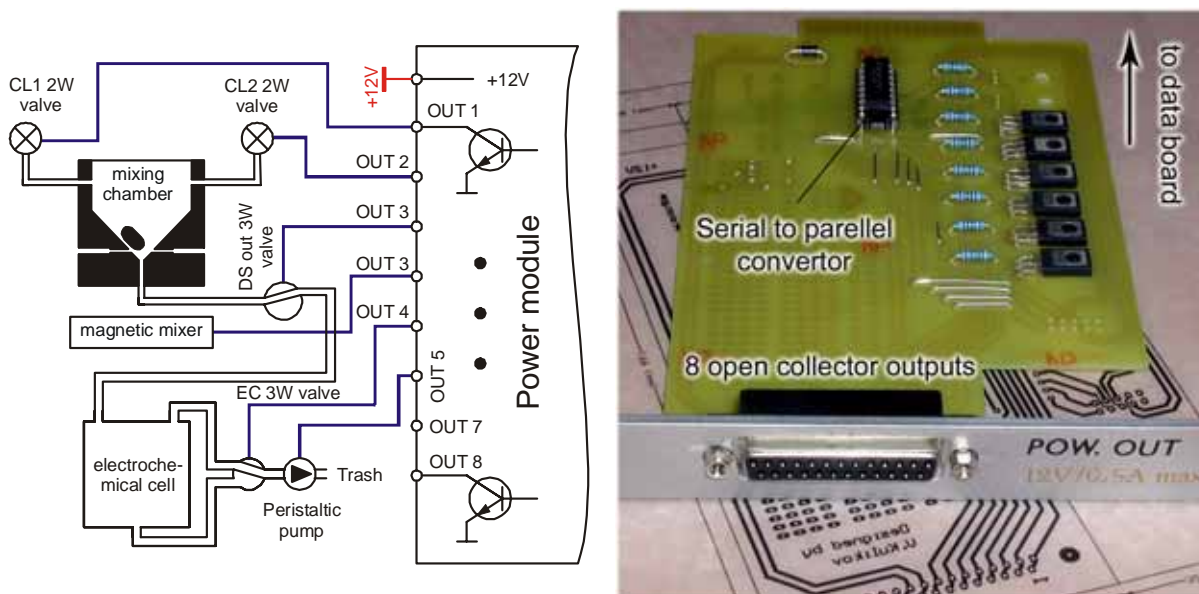

Fig. 37. Power module of the MX96, interconnection with dosing station (left), practical realization (right)

If the parallel synthesis will be point of interest, then the Multiplexer 96 must be completely redesigned and rebuilt. In this case the power source should be stronger (then the maximum current will be specified by the number of channels multiplied by the current consumption of each channel, e.g. 100 relays where each consumed 50 mA required the power source of about 60 W). Additionally, the new communication (data bus) among the relay boards and the MCU should be adapted.

POWER MODULE

The power module, shown in Fig. 37, was used for the switching of valves and peristaltic pump of the dosing station. The module used the de-multiplexer IC, which was controlled by serial data flow from the MCU. The eight open collector outputs (connected to SUB25 pin connector) with +12 V common line allowed the switching of inductive loads up to 300 mA for each channel (max summary current should be less than 600 mA, limited by the source of the MX96). The power channel distribution for the dosing station is shown in Fig. 37, left.

TECHNICAL SPECIFICATION OF THE MULTIPLEXER 96

Nearly all boards of the MX96 could be easily removed from the multiplexer in order to replace, repair or modify them (service purposes). The assembler software for Multiplexer 96 was written under ATMEL AVR Studio 3.2, the electrical design and PCB layouts were performed under Protel 99SE and most of the mechanical designs were drawn by hand (source files including many photos can be found in [152]). The boards for analog parts such as relay boards, main board were ordered, from external PCB provider, according to the design specification and others PCBs (MCU, data board, power module, selector board) were manufactured in the university workshop. Each part of the Multiplexer 96 was self-designed and constructed.

This chapter outlined the electrical system including the MX96 with brief description of its practical realization. Please note that this instrument was the only existing prototype, which was designed and realized. It passed through numerous modifications and improvements, therefore the recent PCB layouts (in the electronic form) do not correspond to the reality, even though the schematics were kept actualized and can be found in [152]. The electrical specification of the realized prototype of the MX96 (only one exists) is shown in Table. 2.

Table. 2. Multiplexer 96 specification

Electrical	Unit	Value
Switching elements	-	Reed relays
Relay Configuration	-	4A+2B
Operational mode	-	serial (1)
Maximum operating voltage	V	200
Maximum operating current	A	0,5
Switching time	ms	< 50
Triggering signal	ms	50 / 2 (2)
ON resistance	mOhm	< 400
OFF resistance	Ohm	> 10E9
Shunt capacitance Source HI –LO	pF	< 100 pF
Shunt capacitance Sense HI – LO	pF	< 200pF
Supply voltage	V / Hz	230 / 50
Power consumption	W	< 40
Operational temperature	°C	5 – 50°C
General	Unit	Value
Remote data communication	-	Parallel 8 bit
Manual remote	-	optional
Indication of actual state		LCD display
ISP interface for MCU flash update	-	Atmel ISP
Supported modes		electropolym measurement Short circuit Zero offset optional
Optional power output module	-	8bit (3)
Additional module	-	supported
Mechanical		
MX signal terminals		4 BNC + banana jack
Signal In/Out		384 in/out signal lines (4)
Positioning		vertical or horizontal
Dimension		520 x 250 x 320
Weight (no accessories)		< 8 kg

Notes:

1. Serial mode, only one channel can be active in one time
2. Triggering signal, after sending command and switching on required channel, the 50 ms delay is applied and after 2 ms pulse is forced on the output of the trigger line
3. Output module for switching of valves and others required accessories was 8bit (output channels). The maximum current from one channel was 0,3A and the total current < 0,6A!
4. 4-point measurement, each sensor 4 pins, 4 x 96 =384 contacts

2.5 Remote control of the multiplexer 96

A simple one-directional 8bit communication with ACK (acknowledge) signal was used for the prototype of the Multiplexer 96 instrument. The instrument could be upgraded (by flashing with new Assembler code) to any possible interface RS232, USB, TCP/IP etc, for some interfaces the hardware upgrade would be necessary. The self-designed protocol, based on one character commands in order to minimize the communication time used in this prototype was not compatible with any existing protocol. Commands in Table. 3 and synchronization diagram in Fig. 38 describe in a nutshell this protocol and requirements on communication with the Multiplexer 96.

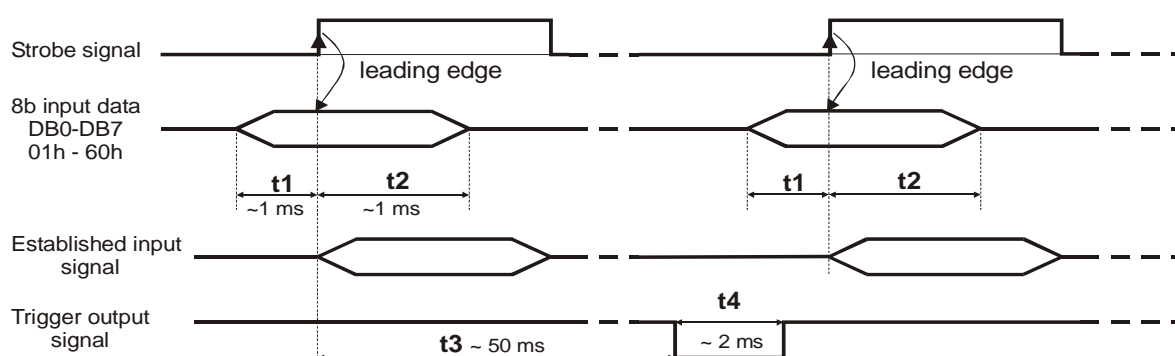

Fig. 38. Signals on the communication bus of the Multiplexer 96

Table. 3. Multiplexer 96 command-set summary

MX 96 Command	hex	bin	dec	Description
0	0x00	00000000	0	numerical value (channel or power signals determination)
1	0x01	00000001	1	
*	*	*	*	
96	0x60	01100000	96	
p	0x70	01110000	112	Electropolymerization mode, 3-electrode system
m	0x6D	01101101	109	Measurement mode, 2-point & 4-point
o	0x6F	01101111	111	Set to power output mode 8bit (1)
r	0x72	01110010	114	MX96 internal software reset
i	0x69	01101001	105	MX96 Information message
s	0x73	00110011	115	Short circuit test, 4-point=2-point (2)
z	0x7A	00111010	122	Zero - for offset compensation (3)

Notes:

1. The “o” command should be followed by the set Byte, which determined the value that was set to the power output (o) and so the required channel respectively channels out of eight was/were switched on.
2. It was based on the measurement mode with interconnected two outlet and two inlet input analog terminals of the K2400 SMU. Designed for short-circuit test of the interdigital electrodes of the electrode array.
3. It was based on the electropolymerization mode. Designed for zero-offset calibration of the measurement instruments; K2000 and K2400. Simple realized by interconnection of all input terminals of the Multiplexer 96.

2.5.1 Thermo-stabilization of experiment, electronic thermostat

Experiments on single electrodes showed that the electropolymerization rate was strong dependent on temperature. Quantitatively for some reactions several hundred times difference was observed [67] (Fig. 1). Increasing the temperature led to increase the mobility of molecules. This induced higher number of the monomers reaching the surface of the work electrode, associated with thickness of the grown polymer layer. This was not the only reason; there could be side reaction of the radical molecules with a solvent too. An example of a temperature dependence of the electropolymerization of aniline from aqueous solution with the HClO_4 electrolyte [67] is shown in Fig. 39. In order to stabilize the reaction temperature, the electronic thermostat was built and is described in this chapter. The thermostat was based on proportional regulation (P) with continual power out [157], allowing thermo-stabilization in range from room temperature up to 80°C .

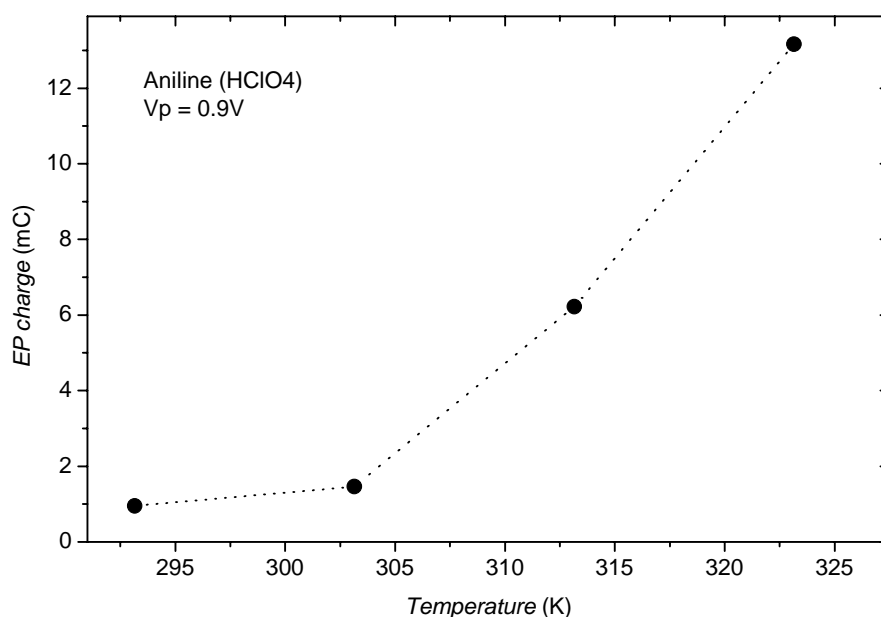

Fig. 39. Temperature dependence of the electropolymerization of aniline from aqueous solution with HClO_4 electrolyte at a potential of 900 mV (C. Swart)

In the beginning, there was thought to use a commercial water bath thermostat, but it required building a special flow-through thermo-cell and an additional liquid system. Based on requirements to keep the temperature always above room temperature a simple electronic thermostat was realized. The usage of commercial PID regulators was excluded because of the pulse switching that could generate an electromagnetic field around the heating element, thus disturbing measurements (the heating element was placed only about 3 mm behind the electrode array).

The temperature range was determined first to be from room temperature up to 80°C for electropolymerization, but further investigations required increasing up to 125°C for measurements (because of the already realized thermo-reservoir (TR) it was not possible to increase the heating power and therefore the thermo-dynamics was slower for temperature above 80°C).

The described thermostat had many advantages such as low power consumption when compared to water bath thermostats, it was quiet because there were no compressors involved, offered precise thermo-stabilization and low temperature fluctuation due to continuous regulation, it had fast response (this was dependent on heating power) and was controlled by computer.

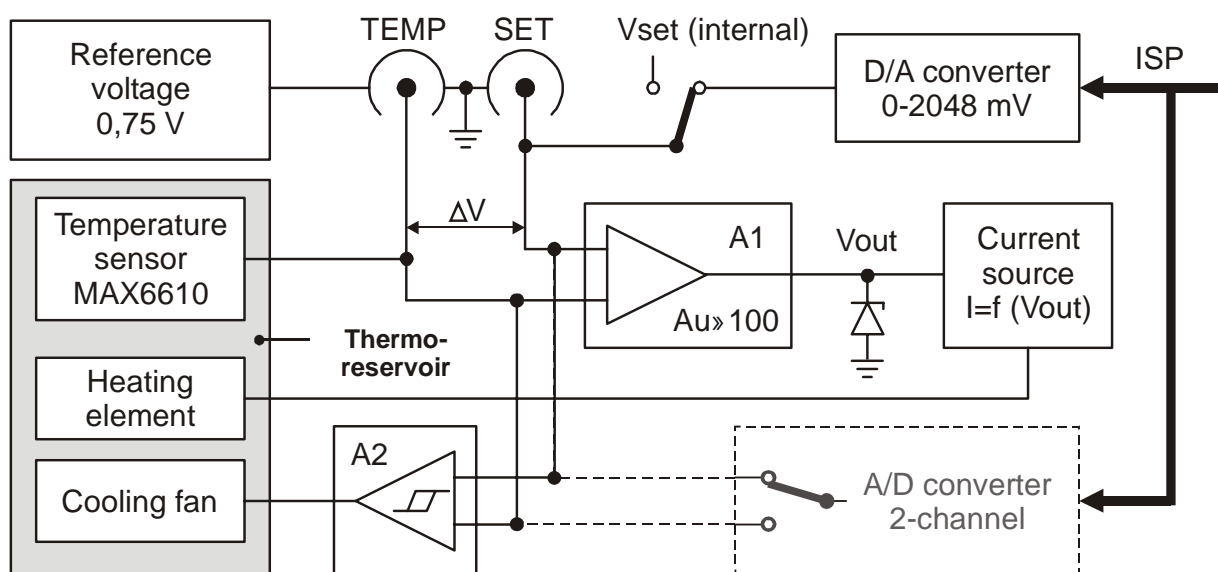

Fig. 40. Block diagram of the realized proportional thermostat

The block diagram of the thermostat is shown in Fig. 40. The temperature sensor was built on the MAX6610 [158] circuit, which included precise analog temperature sensor with voltage output and built-in reference source. To compensate the sensor zero-offset a reference source of 750 mV was used. The signal from the temperature sensor “TEMP” was compared with the reference “SET” by differential amplifier A1 with amplification around 100 amplified the difference. The “SET” value corresponded to the value of the required thermo-stabilized temperature (1°C = 10 mV) and it was adjusted by D/A converter (computer control) or by internal reference (manual control). The amplified signal (Vout) controlled the power current source interconnected with the heating element. If the measured temperature was lower than the “SET” one, the differential voltage ΔV , higher than zero, was amplified by A1 to the Vout level and converted to current. The heating was applied until the measured temperature reached the “SET” value ($\Delta V = 0$). When the difference ΔV was larger than approximately 7 mV (corresponded to 0,7°C difference), the maximum current was applied, limited only by Zener

diode on the input of the current source. The Zener diode limited the maximum current to the heating foil and thus protected the power source and circuitry of thermostat against overload. If the temperature difference decreased, ΔV was less than 7 mV, the continuous regulation was activated. The current linearly decreased with the decrease of ΔV . The difference between the measured “TEMP” and “SET” temperature was stabilized and kept at one level, close to the reference “SET” value.

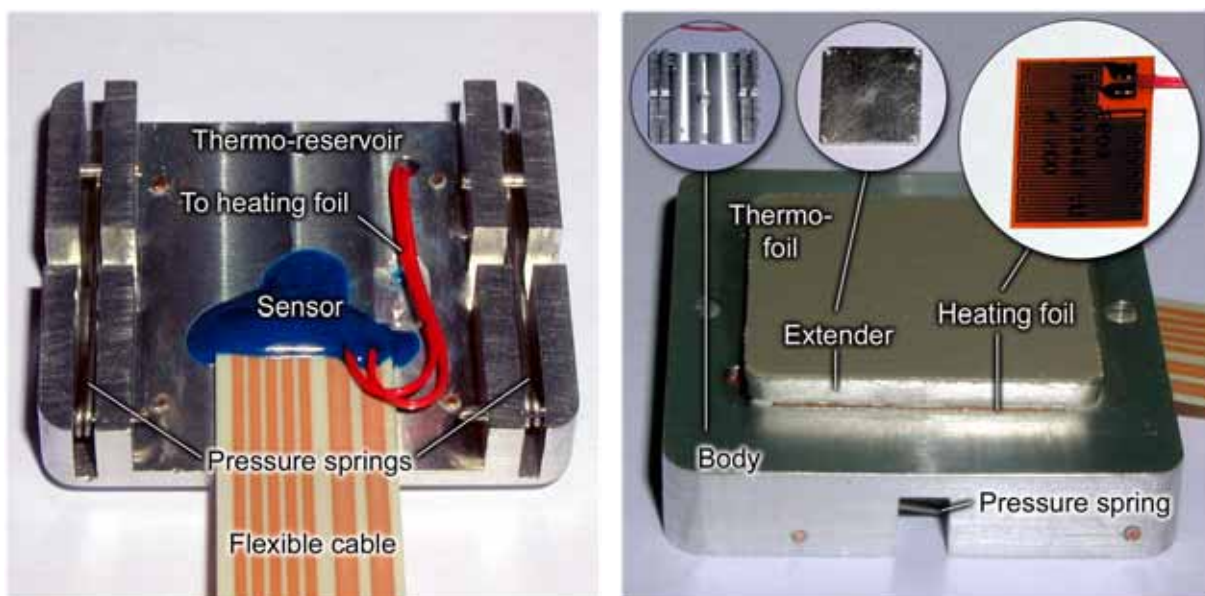

Fig. 41. Practical realization of the thermo-reservoir for electropolymerization set-up, rear view (left), front view (right)

The A1 amplification (Au) influenced the dynamics of the thermostat. When a low Au (~ 10) was used, the system reached the reference value over a longer time and the stabilized temperature was usually lower (difference up to 1°C) than the reference “SET” one, but on the other hand the temperature fluctuations were lower. In ideal situation, the reference and the measured values should be equal during stabilization, but in reality when the cell was in a laboratory surrounding, the stabilized temperature did not reach the reference value within a reasonable time because of air fluctuations, temperature changes and others. To get this situation very close to the ideal, one should thermo-isolate the electrochemical setup, for instance by covering the heating element and electrodes with an appropriate thermo-isolating material respectively by involving integration (I) principle. This case is appropriate for thermo-stabilization of thermo-closed cells where low temperature fluctuations are required. When a higher Au was used, the heating power was able to compensate surrounding fluctuations.

This principle was applied in the presented design and the amplification of A1 was set to be ~ 100 . The thermo-foil made of aluminum was used, due to its uniform heat distribution around the surface of the EA. It had an electrical resistance of about 75 Ohm; therefore, the

higher voltage of about 34 V was used in order to get power of about 15 W. It was enough for heating and good dynamics in the temperature range up to 80°C. The final stabilized temperature was mainly dependent on the room temperature and construction of thermo-reservoir. The placement of the heating element and sensor was important for appropriate regulation with low hysteresis, as close as they were placed each to other as low hysteresis was obtained.

The realized thermo-reservoir, shown in Fig. 41 had two mechanical parts both made of aluminum, a body and an extender. Between the extender, which was fixed to the body (Fig. 41, right), the heating foil was inserted. To increase thermo-conductivity throughout the base, heating foil and extender a thermo-conductive paste was used.

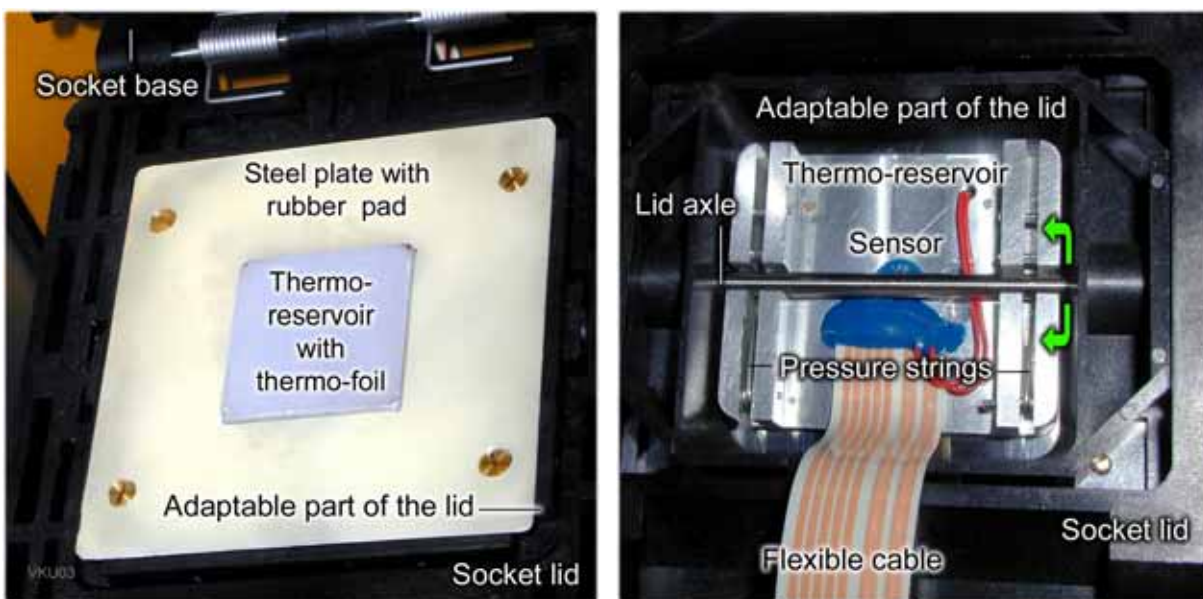

Fig. 42. Front view of the socket lid with adaptable part and the thermo-reservoir (left), rear view of the thermo-reservoir fixed to the adaptable part of the socket lid (right)

The temperature sensor was attached (by thermo-conductive glue) to the middle of the thermo-reservoir body from its back side and electrically interconnected with the flexible flat cable, shown in Fig. 41, left. The sensor was situated in a distance of 0,5 mm from the heating foil and about 4 mm from the EA surface; this resulted in low hysteresis. Copper with higher thermo-conductivity could replace the aluminum material, used for its simple treatment, thus minimize the temperature drop in the material, and increase absolute precision of thermo-stabilization.

The thermo-reservoir (TR) was fixed directly to the test socket lid, shown in Fig. 42, right. The socket was made of glass-filled Polyethersulphone (PES), appropriate for operating temperatures in range from -40°C up to $+170^{\circ}\text{C}$. The lid of the socket pushed the electrode array (EA) to the contact pins and held the thermostat module. The adaptable part was fixed to

the lid allowing the adaptable part to turn its position around the axle (illustrated by arrows in Fig. 42, right). In order to adapt itself to the EA surface [148]. The stainless steel plate (0.5 mm) with a through hole for TR in the middle was mounted by four 2,5 mm screws from the inner side of the lid, shown schematically in Fig. 43, left and practically in Fig. 42, left. On the top of the steel plate, a rubber pad was glued (with similar through-hole as for the steel plate). This pad was important because its thickness determined the pressure applied by contact pins (of the socket) to the EA after locking the lid (its thickness was about 0.5 mm). If the pad was too thin the pressure was low, then contact problems occurred. On the other hand, if the pad was too thick then the contact pins scratched the contacting pads on the EA. The thickness of the pad was dependent mainly on thickness and softness of the steel plate and could be individual for different sockets even of the same type.

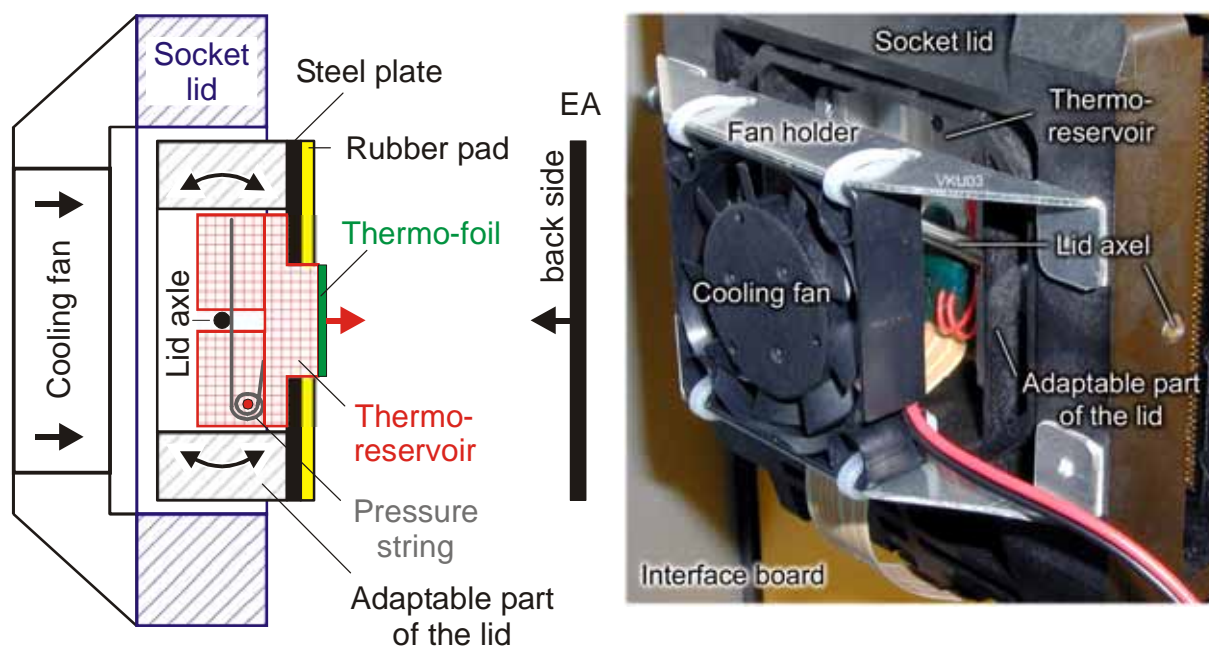

Fig. 43. Schematic of placement the thermo-reservoir and other elements in the adaptable part of the socket lid (left), rear view on the closed socket lid with attached thermo-reservoir overlapped by cooling fan (right)

The detailed-front view of the adaptable part with fixed TR is shown in Fig. 42, left. In order to decrease self-cooling time, especially during temperature pulses described in measurement chapter 3.1, (not important for electropolymerization) a computer-cooling fan was placed parallel to thermo-reservoir so that the fan blows air on the rear surface of the TR, shown in Fig. 43, left. The cooling circuit helped during self-cooling of the already preheated TR with electrochemical or measurement cell. The cooling fan was controlled by comparator A2 (Fig. 40) with hysteresis of 1°C between the measured and the “SET” value. The cooling time could be decreased by using of a bigger cooling fan or involving of water flow instead of

blowing air (the water valve instead of the cooling fan and cooling by the water flow in the flow-through cell should be used). It is similar to the water bath thermostat, but only one valve and water source are required. Another possibility was Peltier element, but in this case the maximum temperature was limited to 80°C.

The thermostat was controlled by computer (using the data output K2499) through the ISP communication protocol. Its detailed description can be found in [158], example program written under Agilent VEE 6 in software folder for V3 of [157]. Designed thermostat allowed only adjustment of the temperature but not the reading of actual values, optionally the A/D converter could be added for scanning of the temperature, shown in Fig. 40. The time required for heating during experiment was determined experimentally according to the required thermo-stabilized temperature and room temperature (usually 2 minutes for thermo-stabilization to 40°C, taking into account the room temperature of 20°C, reagents were kept on the same room temperature).

The successful prototype design V3 resulted in the production of the second thermostat for single experiments. Here a different heating cell was used, with stronger point heater based on MOS-FET transistor and different distribution of the sensor and the MOS-FET. The outlying placement of the sensor and heating element resulted in overheating pulses, after reaching the thermo-stabilized value, this is described in remarks in documentation for V3.1 in [157].

The electronic design was performed under Protel SE99 and mechanical design under AutoCAD 2000.

2.6 Combinatorial electropolymerization software, CEP

Once, the EP set-up is prepared, the fully automated electropolymerization (EP) software is required. The self-written combinatorial EP software (CEP), described in this chapter, controlled, synchronized and stored all EP results. Generally the whole software package for EP set-up consisted of three main parts; i) control of electropolymerization, which is described in this chapter ii) control of measurements and (described in chapters 3.1) iii) data evaluation (described in chapters 4).

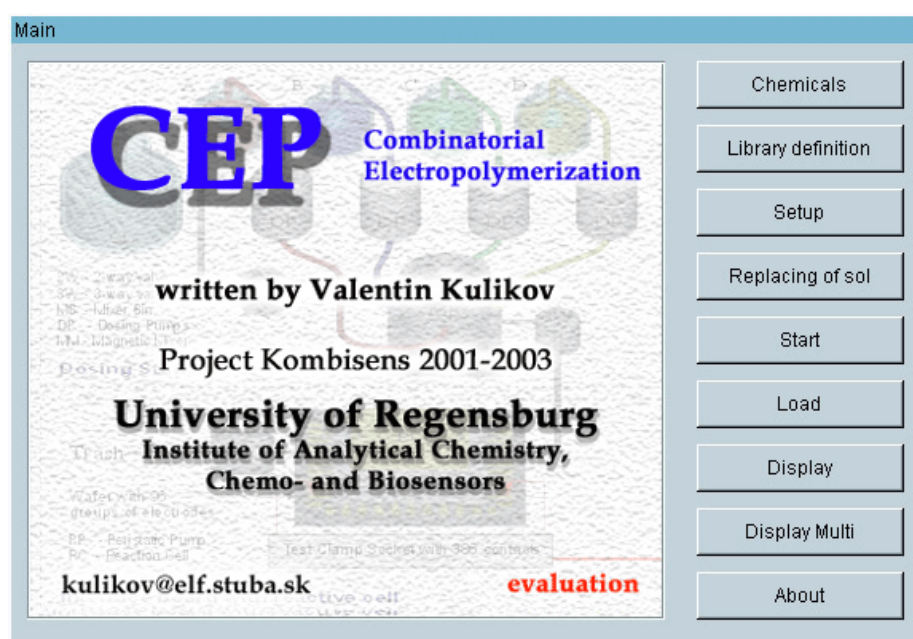

Fig. 44. Main window of the CEP software

The CEP controlled all operations of the dosing station, electronic system and performed whole data acquisition according to a EP library. The library, presented as an ASCII text file, could be generated automatically by combinatorial or another appropriate software (for standard experiments) or written by user itself (for unique non-standard experiments). The library file could be written in notepad or by "Library definition" tool (part of CEP) according to commands described in appendix 10.3. The library file specified all EP conditions, steps including cleaning procedures. The user should select desirable monomers and additives, variations of their concentration, final electropolymerization charge and time, polymerization temperature, cleaning procedures, and polymerization order. The aim of the CEP was to provide and control the whole electropolymerization on each electrode of the EA following the library file. During the polymer synthesis, the software monitored electropolymerization process and stored all electropolymerization results.

The CEP software was started by a “main” window, shown in Fig. 44. Here, several options for experiment planning, specification of used reagents, settings, viewing EP results in single or multi form and several others were offered.

Fig. 45. Set-up & Options window of the CEP software

The electropolymerization flow diagram is outlined in Fig. 46. The experiment began by activating the “Start” button in the CEP “main” window. The software loaded, verified the library file, and simultaneously displays all library lines and errors (if presented) in the “Load & Verify experiment Library” window, shown in Fig. 47. If any error(s) or out of range condition(s) was(were) detected from the library file, the software listed all errors, deactivated the “Continue” button and thus disabled the starting of an experiment. If all lines of the library file were correct, the software summarized channel distribution and calculated required volumes of involved reagents. In this window user should specify the library name, which was further used as the target directory for the combinatorial experiment (more details could be found in appendix 10.3). All experimental data, not only from the electropolymerization but also from following measurement and analysis, will be written into the library folder (library name “9-03-3ABA-32” shown in Fig. 47). The option “...Add date” pasted the actual date in to the library name. The option “Channel distribution” graphically displayed the state of all 96 work electrodes of the EA with color indication of used, not used (empty) and crossed electrodes. The indication of crossed electrode(s) occurred only if two or more electropolymerization steps were applied to an identical work electrode. It should not be a problem because this crossing could be used to form multi-layer structures.

The “Set-up & Options” window shown in Fig. 45 followed the “Load & Verify experiment Library”, after pressing "Continue" button. Here, the description of the electrode array, used in the recent experiment, could be noticed (this information was important for

reused EAs). Note that the EA entry was activated only in the presence of the previous EP results (previous experiment - loaded) or after starting of a new experiment. All timings for dosing station could be adjusted in the “Dosing set-up” window (it should be noticed that not appropriate settings could lead to a damage of the set-up, leakage of chemicals and destruction of the electrical system).

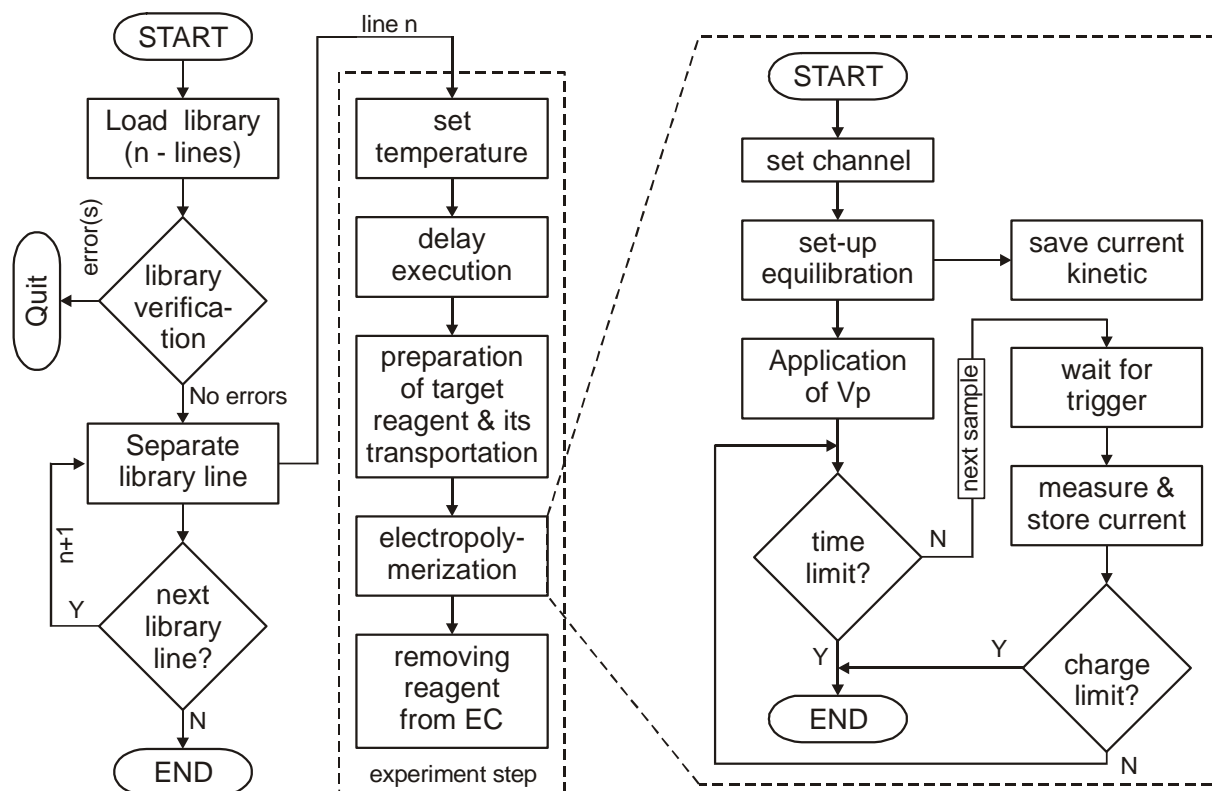

Fig. 46. Flow diagram of the potentiometric electropolymerization followed by the CEP software

The confirmation in the “Set-up & Options” window initiated the electropolymerization experiment as indicated in the flow diagram in Fig. 46. Every single line of the library file was individually executed; this resulted in electrochemical synthesis on a specified work electrode of the EA respectively in cleaning of the fluidic system or performing another supported procedure (appendix 10.3). Each single EP step began with temperature adjustment activating the built-in thermostat. The values for temperature and the delay time were extracted from the loaded library line. It was followed by preparation of target reagent, taking into account amount of involved chemicals corresponding to values specified by the recent library line. Then, the target reagent was transported into the electrochemical cell (EC) and the set-up executed one single EP step (according to the specification given by the corresponding library line). Optionally the preparation of target reagent and its transportation could be lapped by cleaning procedures. The electropolymerization, ruled by the flow diagram, shown in Fig. 46,

right, was completed by removal of reagents (fluids) from the EC and their transportation into the trash reservoir. Application of the next library line also called experimental step was repeated until each involved electrode was covered by the polymer of specific content. All parameters defined, measured or calculated were displayed during each experiment step in the “PCV-polymerization, constant voltage” window, shown in Fig. 48.

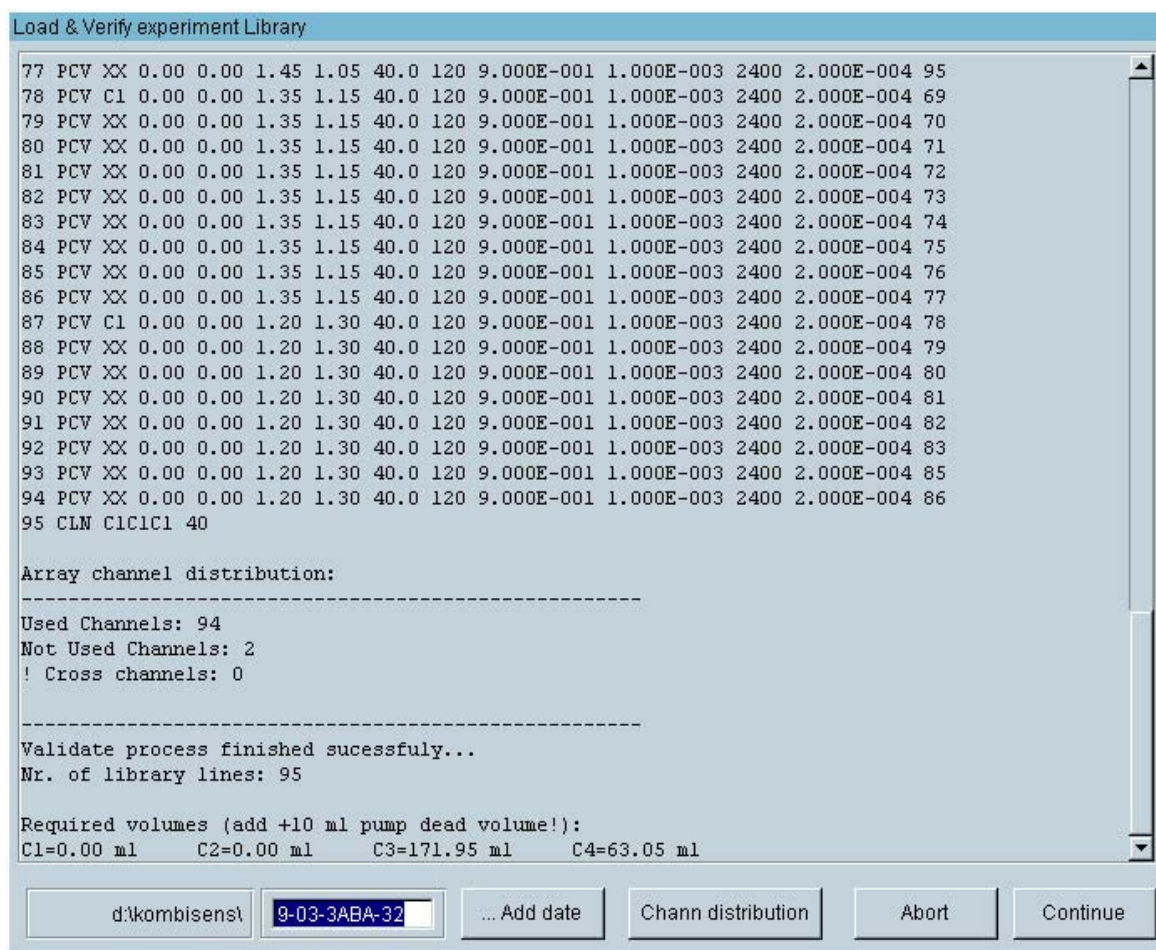

Fig. 47. Load library window of the CEP software

The detailed view of the single voltametric electropolymerization, shown in Fig. 46, right, started by equilibration of the electrochemical system. The equilibrium time was specified in library file for each single EP step and equilibrium voltage could be adjusted in the “Set-up & Options” menu (Fig. 45). During the equilibration, the CEP software recorded current kinetic. Then the electropolymerization voltage (V_p) (specified in the corresponding library line) was applied and the EP current kinetic was recorded. The electropolymerization was performed till the charge or time limit was reached. Both conditions should be specified in the executed library line before the experiment. In the end, the final potential was applied in the presence of target reagent; this affected the final state of the polymer layer. The final potential and its duration could be specified in the “Set-up & Options” window (Fig. 45).

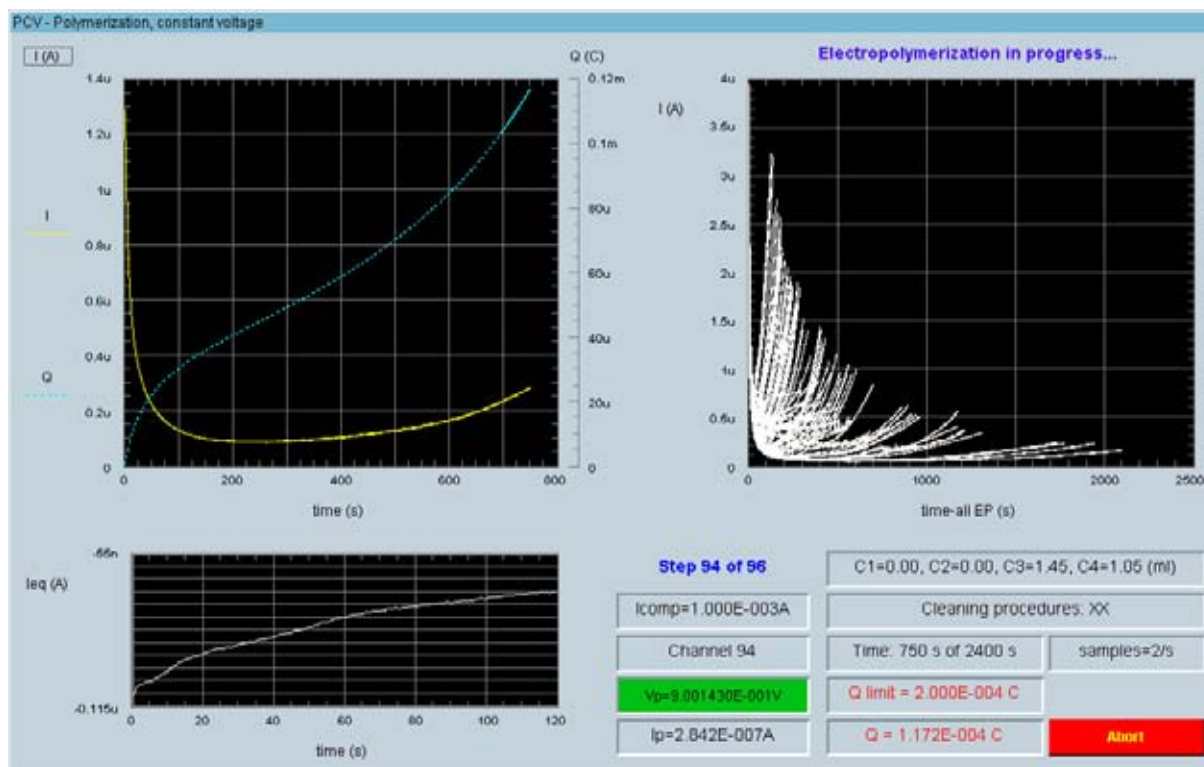

Fig. 48. Voltametric EP window of the CEP software

The CEP offered several additional options, available from the “main” window, as outlined below:

Option “Chemicals” allowed creation of a list of used reagents with their specifications, shown in Fig. 49. The reagents were divided into four groups displayed as “Solution 1 (up to 4)”. The amount of groups corresponded to the number of different solutions available in the EP set-up (it corresponded to four reservoirs and four dosing pumps). Each group could be recognized as consisting of several compounds, which amount was not limited (tested up to ten compounds, more not required that time). The CEP software stored complete information about involved solutions into “subst.dat” file (database of reagents) situated in the library sub-folder (see appendix 10.3 for detailed specification). It could be created, in the CEP software, before or after experiment (its content could be further edited or modified). After measurement, this database was used by an analysis software. The “Characterization of reagents” window included several options as follows:

The “Add” button extended the database of reagents by new compound, defined by its name, concentration, solution group and others optional parameters, into. The unique ID - identification number was assigned to each new compound (it could be anytime modified or removed). The “Save” button stored respectively updated all new entries or modifications into the “subst.dat” file. The compound, indicated in the drop-down list on the right side of the “Characterization of Reagents” window (Fig. 49), could be removed by “Remove” or modified

by the “Change” button. The “Cancel” button discharged all changes and entries. The “Load” button allowed re-use of an existing database of reagents from an previous experiment and modify it for the new one. A record format supported by Agilent VEE was applied in order to store database of reagents.

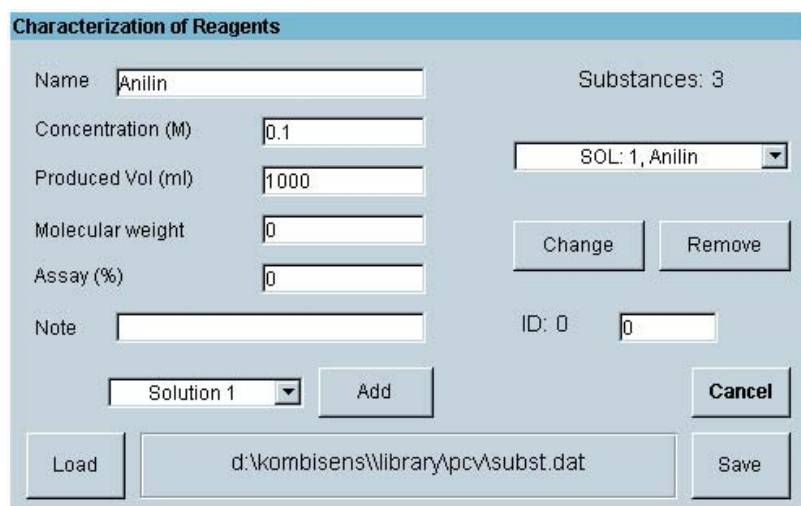

Fig. 49. Characterization of reagents window of the CEP software

The „Replacing chemicals“ panel shown in Fig. 50, helped during the cleaning of the dosing pumps and the whole EP fluidic system. It included following options:

- The “Empty syringe” option removed reagents from the syringe of the dosing pump specified by the radio-button (DP1-DP4) on its left side. However, after removal there were still reagents remaining, caused by dead volume of the pump, they should be removed manually.
- The “Fill syringe” option performed filling of the dosing pump (specified by the radio-button DP1-DP4) by solution from the corresponding reservoir. The syringe was not filled completely, there was still about 1 mL of volume, in the upper part, filled by air. Therefore the “Dosing” option was implanted to compensate the dead volume of the dosing pumps.
- The “Dosing” option was similar to the previous one. It allowed manually dose of specified volume (“Dosing (ml)”) by the corresponding dosing pump directly into the mixing chamber.
- The “EC fill (dosing)” option performed transport of content of the mixing chamber into the electrochemical cell.
- The “Empty EC” option removed fluids from the EC and transported them into trash reservoir.
- The “Regenerate Ref” option regenerated the reference electrode, used in the case of a new experiment when the set-up was not used during a long time.

- The “Cleaning C1, C2” options executed cleaning procedures using cleaning solvents from reservoir CL1 respectively CL2.
- The “Start / Stop pumping” options activated / deactivated the peristaltic pump of the dosing station.
- The “Low level remote” option opened a low level remote panel of the dosing station. It allowed control of individual valves and components of the dosing station. Note, that not adequate control in the low level remote could damage the fluidic system.

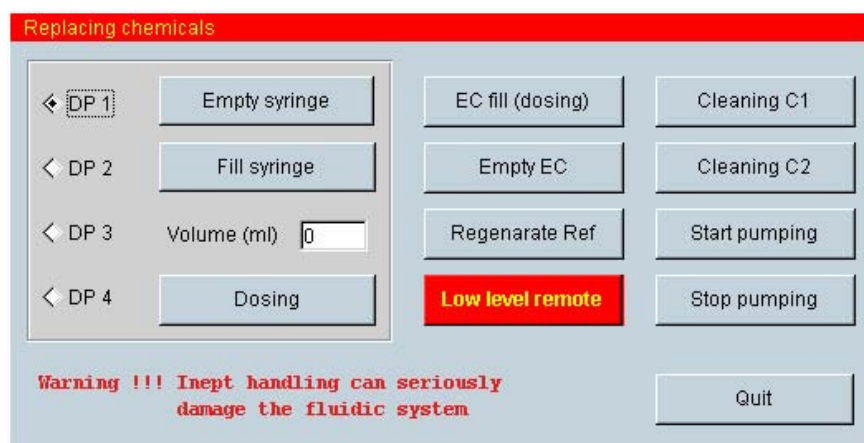

Fig. 50. Replacing chemicals window of the CEP software

The galvanostatic mode used for experiments based on biosensor, where constant current was required instead of constant voltage was available in the CEP software too. The library definition for this mode is shown in appendix 10.3. The CEP software could be improved by implementation of new modes and functions. For detailed description of the CEP software please refer to the source code and documentation files [159]. The CEP software was written under Agilent VEE 6.01, which offered the simplest and most accurate way to build this measurement set-up. The CEP software involved three self-written libraries (dstation.vee, setup.vee and main.vee [160]). The “dstation.vee” library covered all procedures necessary for control of the dosing station. The “setup.vee” library involved all functions for the remote of the electronic system and the “main.vee” library included the rest general functions and procedures. The libraries were used in open-source code, their compilation in the further versions could increase the CEP response time. The CEP could be easy updated and modified due to the visual object programming properties of the used VEE platform, therefore any extended documentation is given.

2.7 General remarks and possible improvements

Electropolymerization concept

The used geometry of the electrode array alone does not guarantee that the polymerization occurs only on the addressed work electrode (connected to a potential source with a corresponding potential value). The problem could be the distance between work electrodes. If the electrodes were too close to each other (this was favorable to minimize the active area of the array in order to minimize a consumption of reagents), the electrical potential of the actually polymerized electrode could influence the potentials of non polymerized electrodes, thus leading to undesirable electropolymerization (on electrodes not involved in the current EP step of the experiment). This problem was most significant for electrode arrays based on semi-conducting substrates (silicon) and could be overcome by the fixing of the potential of all non involved electrodes or by fixing the potential of the semi-conducting EA support, shown in Fig. 30.

Electropolymerization cell

However, the inner part of the EC body formed by PTFE material was hydrophobic, it was found that droplets of reagents remaining after finishing of an experiment and removal of reagents (from the EC) were still presented in the EC. The dead volume was formed especially around the hydrophilic sealing ring (Viton®) and in the bottom corners of the cell. This artifact was taken into account in the electropolymerization software (chapter 2.6), where the possibility to define repetition of EC filling with the same target reagent was implanted to get most accurate target solution in the EC. There are other possibilities how to minimize dead volume of the EC. One of them was redesigning of the EC to form the inner volume with another shape, or to the cell oriented different (for instance turn the square based EC to 45° angle so that one corner was at the lowest level and opposite corner at the highest level (the inlet and upper outlet will be very close each other). In this case the layout of the interface board need to be changed corresponding to the turned cell. To minimize the EC dead volume caused by hydrophilic sealing, a thin planar sealing or another appropriate hydrophobic one could be used (similar was used in the first design of the electrochemical cell [150]). The highest quality seal can be achieved by underpressure, in this case no special rubber sealing is required.

There were still problems with the Viton® sealing ring (it was not stable in organic solutions), especially with used or older rings. It was required to wash the sealing ring in ethanol (to refresh it) before re-using it. If the EC volume was not closed (hermetic) enough, the solutions might leak from the EC, this led to damage of the contacts of the socket and the interface board. It is recommended to replace Viton® sealing ring by another material

determined for low-pressure-sealing, but this is dependent on used reagents (e.g. soft silicon sealing ring or other appropriate one).

Other improvements of the EC, assuming cleaning, is to apply a magnetic stirrer respectively ultrasonic cleaning directly inside of the EC. This would be suitable for experiments where large amounts of different target reagents were used during a long time.

Reference electrode

To reduce an electrical noise of the EP set-up, the electrode body can be covered by transparent conductive layer electrically connected to the outer shield of the electrode connection cable (guard). This layer can be made for instance of a copper wire orbbed around the electrode body still keeping the electrode transparent for visual inspection of the filling solution (its amount, and undesirable air bubbles inside). Several mechanical modifications can be done to improve the electrode construction. The glass body can be replaced by PTFE tube (improvement of sealing of the reference electrode with the electrochemical cell) and it can make the electrode flexible. The body must have the similar shape as had the electrode previously described. The electrode junction can be replaced by Vycor® glass [138].

Electrode array

In order to improve mechanical properties of the contact spots of the electrode array it is necessary to increase their thickness from 250 nm to more than 1 μm . This can be done by increasing of the thickness of the whole platinum layer, but it may affect the precision of the electrode topology. The best appropriate possibility is to form an additional metal layer only for contact spots, which will be thicker than that one used for electrodes. The material of this layer should be similar to the material used for electrodes (because of the need for chemical cleaning of the electrode array). By changing the array topology it is possible to increase the number of single electrodes up to 384 and even more (theoretically up to 436). The formed single electrode spots can be used for amperometric, potentiometric or voltametric measurements for application in biosensors, DNA recognition and many others.

To decrease IR drop in the electrolyte the Ag/AgCl reference electrode must be situated directly on the electrode array, next to each work electrode, as reported in [132-135].

Other support materials for the electrode array, for instance plastic supports used for organic displays, can be involved to minimize costs. The size of the EA can be reduced by application of novel contacting methods.

Dosing station

One can suggest several improvements of the dosing station prototype, for instance, using of tubing with smaller diameter to minimize the dead volume, which was about 1 mL for each of four analyte channels (from the dosing pump up to the MC), this could decrease consumption of reagents. Another useful improvement can be the implementation of a flow-through sensor that can detect the presence or absence of liquids in the system during filling and emptying cycles. The flow-through sensor was missing in presented design and all transport operations were realized by prolonged time in the EP software, this means that the pumps were working longer than was really necessary. The implementation of the flow-through sensor could decrease transport times and prevents the leakage of liquids from the MC when the peristaltic pump is not working properly because of broken tubing. In the future, for commercial application, it will be necessary to use a level sensor in the MC (security arrangement), to prevent the overfilling of the MC (leakage of liquids from the EC) and to protect the whole electropolymerization set-up against contamination. This situation could occur while removing of remaining fluids from the dosing pumps after experimental step and during an experiment too, when a pump malfunction occurred.

The new design, based on current knowledge, can be realized by unifying the reaction cell and the mixing chamber. This solution can rapidly decrease the dead volume of the dosing station and thus improve the cleaning of the cell due to implemented stirring directly in its volume, as proposed before. In addition, the two-level sensor (e.g. optical) can control the liquid-transportation and detect leakages of liquids from the electrochemical system.

3 Measurement concept

The strong position of combinatorial chemistry, established in pharma-technology of drug discovery, was provided not only by the development of combinatorial techniques, but also by the development of the whole technology of high-throughput characterization of novel synthesized compounds; that was primary, secondary screening and analysis of absorption, distribution, metabolism and excretion. Moreover, typically the characterization was the rate-limiting step of the whole process. An application of combinatorial techniques in material science [7, 117, 161-163] also required development of new technologies not only for combinatorial synthesis [7, 73, 161, 164-166] but also for comprehensive characterization of synthesized materials. Respective methods, included an attenuated total reflection FT-IR spectroscopy [167], Raman spectroscopy [168], methods to study mechanical behavior [168-170], viscosity [169], ^1H NMR spectroscopy [171], gas and liquid chromatography [171, 172], MALDI-TOF-mass-spectroscopy [171, 173], scanning probe microscopy [174], fluorescence [143], IR thermography [169, 175] and many others [117, 166], were adapted and applied for high-throughput characterization of combinatorially synthesized materials. The variety of available methods had a strong impact on the development of corresponding commercial instrumentation [164]. This chapter outlines techniques and principles applied in this work for automated screening of synthesized polymers by means of combinatorial electrochemistry.

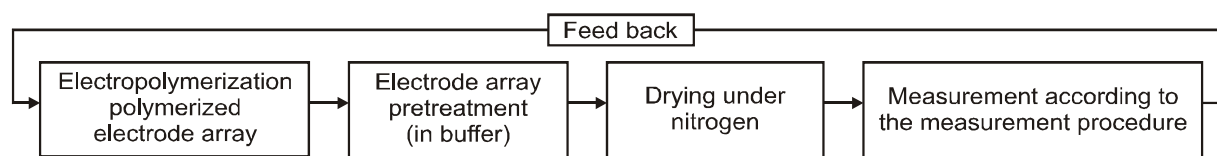

Fig. 51. Flow diagram of the combinatorial experiment

The measurement concept, described here, presents the next step after electropolymerization and pretreatment phases, outlined in Fig. 51. Usually, after electropolymerization the synthesized structures had typically high electrical conductance. Therefore, the pretreatment by buffer was applied (chemical un-doping) to decrease their background conductance. Then, the drying phase was used to remove fluids presented in the polymer layers and on the electrode array (EA) surface after removal of the buffer solution. The main measurement concept was based on direct current conductance measurements involving the two- and four-point technique simultaneously [146]. The system similar to described one, which used these techniques consequently was presented in [116]. According to our knowledge, the presented concept is the first application of this simultaneous technique for the screening of polymer structures. The total electrical conductance of an electrode / polymer structure and its dependence on exposure to different analytes was mostly measured by the

common two-point technique [5, 27-30, 176-178]. Because, the two-point technique did not give any information about the interface effects, the four-point technique was additionally involved. Due to the simultaneous application of the two- and four-point technique it was possible to distinguish between a bulk conductance of the polymer layer and contact resistance by a single measurement. The simultaneous measurement resulted in the characterization of the material properties, excluding interface effects, and also in characterization of the contact (polymer/metal interface) resistance as modeled in Fig. 52. It was also possible to use standard two-point technique individually (voltmeter V4 was not used during measurements), but this resulted only in measurement of the total conductance as mentioned above. Typical electrode geometry for measurement of two-point conductance commonly used a strip interdigital electrode (IDT). This provided an effective use of the area of the electrode support, increased the polymer/electrode interface area and decreased the absolute value of the polymer conductance. Usually, two-point IDT consisted of two metal strips used simultaneously for current flow and sensing. Application of the four-point technique [179] required modification of the electrode topology. Two additional metal strips divided measurement signals into two paths, one for current flow and one for sensing, shown in Fig. 52. Due to the high impedance of the V4 (sensing path), the current flow in this sense part was negligible thus the value of $G_4 = I / V_4$ corresponded to the bulk conductance of the polymer layer (material properties).

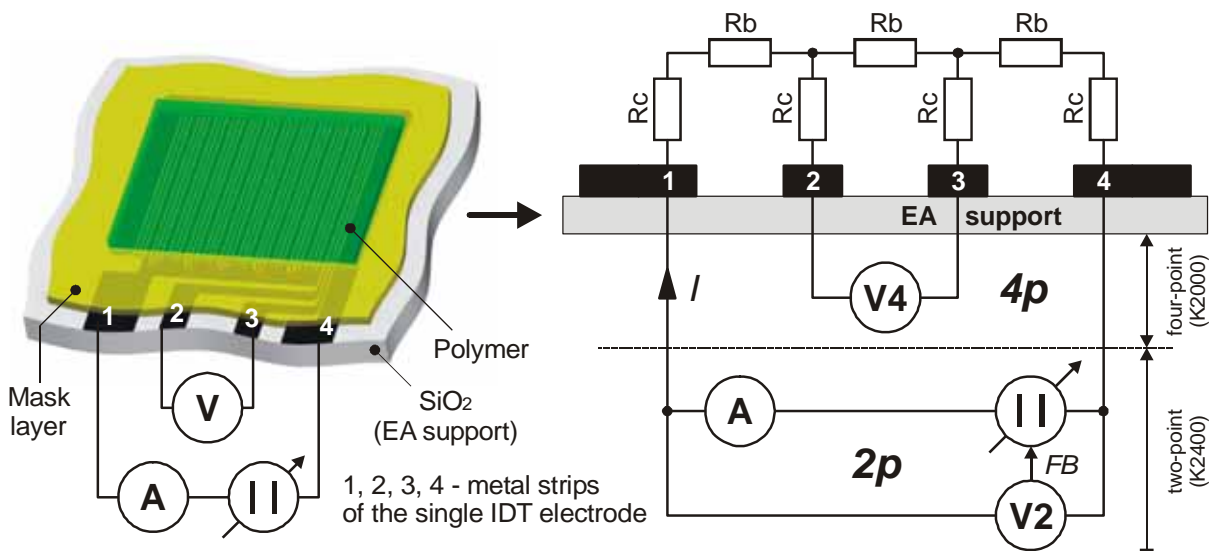

Fig. 52. Model of the designed conductometric chemo-resistor, measured by simultaneous application of the two- and four-point technique

The contact resistance R_c could be, in this model, extracted with a value corresponded to $R_c = \frac{1}{2} ((1 / G_2) - (3 / G_4))$. If the contact resistances $R_c=0$ (in the ideal case), then the ratio of G_4 / G_2 equaled to the constant k , this was given by the geometry of the modified IDT

electrode (usually, $k_0=3$). However, in the reality the k constant was dependent especially on the reached accuracy of the EA topology ($k_0 = 3,1 \pm 0,1$ obtained experimentally). If the value of $R_c > 0$, then the ratio G_4 / G_2 was higher than the constant k_0 .

The measurement concept involved the same instrumentation as the electropolymerization (EP) concept. Only, in addition, the multimeter Keithley K2000 [180], was used for the sense path. This was necessary for simultaneous four-point conductivity measurement. The dosing station and fluidic system was substituted by a gas flow system and the electrochemical cell (EC) was replaced by a gas cell. Nevertheless, the EC could be used for experiments with liquid analyte (for biosensor applications etc.). The gas cell was connected to the gas flow system, which diluted and delivered the required concentration of gaseous analyte.

The multiplexer (MX96) was configured in the “Measurement mode“. It can be applied only to electrodes (sensors) with linear properties and cannot be used to polymer / metal structures behaving non-linear. Assuming the model, shown in Fig. 52, the connection of the K2400 and 2000 instruments to the MX96 is schematically shown in Fig. 53. Here, contrary from the EP concept, the single strips, of the recently measured single electrode, were not interconnected, thus each channel of the MX96, schematically outlined in Fig. 53, consisted of 4A (four normally opened contacts) switch configuration. The 2B switch configuration previously applied during EP for protective potential was not used during measurements. The MX96 connected a single 4-strip IDT electrode, out of 96, with the measurement instruments thus allowed serial screening of materials deposited on this electrode.

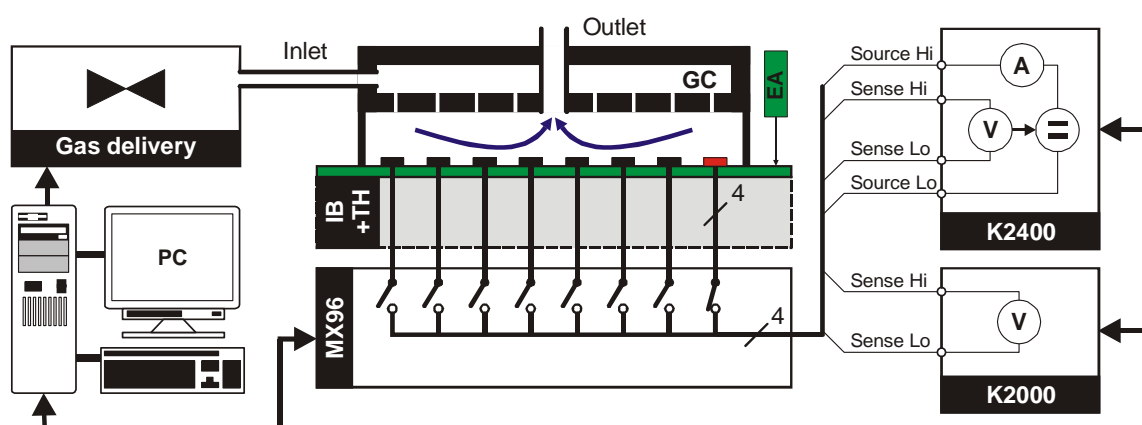

Fig. 53. Block diagram of the measurement concept

Generally, two measurement modes were designed and programmed; i) the pulse and ii) the sweep. Both of them supported simultaneous two- and four-point technique.

The pulse mode was based on the DC conductance measurement and further modified to eliminate polarization effects, especially for measurements in presence of liquid analytes (in biosensor applications). The measurement was performed for two opposite voltage pulses

+50 and -50 mV (Fig. 54, left). Each voltage was applied for time period of about 350 ms thus forming two opposite voltage pulses, shown in Fig. 54, left. This method was used in order to separate functionless electrodes (sensors). The measured sensor was marked as functionless, if its absolute response was higher than 10%. The functionless sensors, characterized by rather different absolute values of current pulses, occurred because of a polymer did not fill gaps between electrode strips, during the electropolymerization (e.g. rectification effects etc.). The absolute voltage value of 50 mV was used in order to prevent modifications of the polymer layer caused by high potentials and in order to avoid self-heating effects of the layer. The measurement of a single IDT electrode consumed time of about 700 ms, which was not constant for all electrodes due to the K2400 (SMU) measurement technique [127]. For instance if the measurement on a low conductive or functionless electrode was performed after measurement on a high conductive electrode, the measurement time increased because the SMU was adapting an appropriate measurement range. Therefore, to full-fill synchronization requirements, the constant time window (Fig. 56, left) was implemented into the measurement. The principle was based on the fixed time period to which passed sufficiently all 96 pulse measurements of the single measurement step. The remaining time after completion of one measurement step (96 electrodes) was filled up until the fixed time (time window 120 seconds) was reached. The pulse mode was used as a compromise for fast measurements, typically specified by short measurement time and low information content.

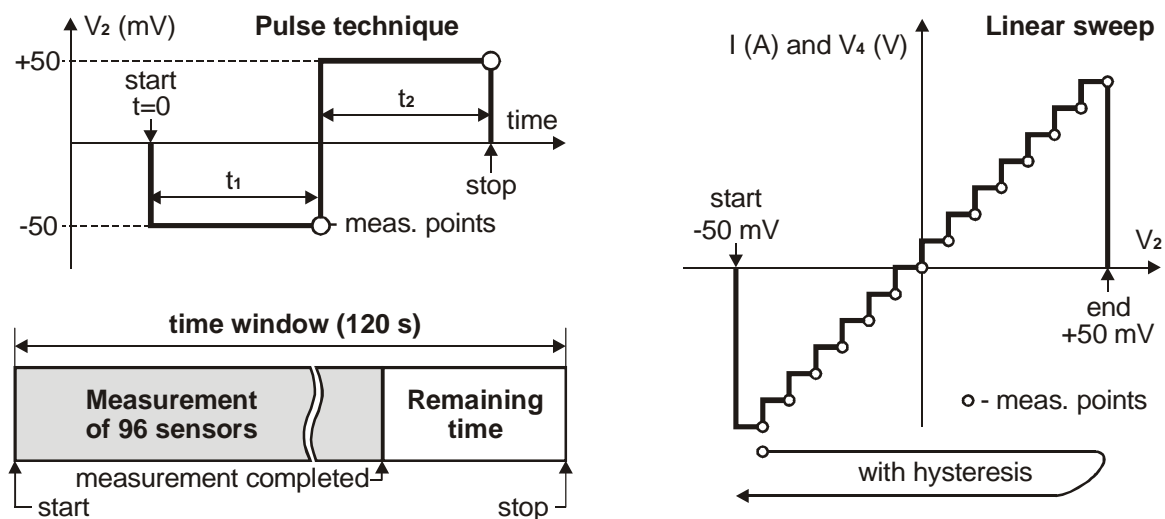

Fig. 54. Pulse measurement mode, $t_1=t_2=350$ ms, and time window principle (left), sweep mode (right)

The sweep mode allowed measurement of current-voltage characteristics of each single IDT electrode consequently with involvement of hysteresis as an option (Fig. 54, right). The number of points was limited to max. 2500 (limited by the buffer memory of the K2400 and K2000 instruments). The measurement time depended on the number of measured points,

instrument settings [127] and varied for different electrodes. In this case the time synchronization was not applied so each sweep measurement required a different time. The time synchronization could be improved by application of another source monitor unit, which supports the pulse measurement technique. The sweep mode, outlined in Fig. 54, right, was designed for detailed DC characterization. It was typical by long measurement times and high information content. Although, the sweep measurement offered high informative content, it was time consuming and therefore not applied for all measurement steps.

The whole measurement process (involving automated screening, temperature and analyte control) was performed by the same hardware as during electropolymerization, only different software was used. The screening software ARYMS (Automated aRraY MeaSurement Software) executed measurements according to the predefined measurement procedure (ASCII file, similar to the library file for EP). The measurement procedure included all measurement steps (defined by measurement protocol, described in chapter 3.1) required for further analysis.

Because of the amount of single measurements, the measurement time was the main limiting factor. A comprehensive characterization of sensors was required, where not only sensor sensitivity was the point of view. Other important parameters such as reproducibility, selectivity, reversibility, response time and recovery time of synthesized sensors were of importance. Therefore, it was essential to specify all necessary measurements as a compromise between reasonable investigation time and comprehensiveness of characterization (described in the following chapter 3.1)

Following this measurement protocol, the unique measurement procedure (ASCII file, appendix 10.4) consisting of single measurement steps was written, applied for screenings of all synthesized polymers and involved in further analysis.

3.1 Measurement protocol

High throughput characterization of combinatorial libraries demands a compromise between completeness of the study and reasonable investigation time. This compromise could be found by the development of test protocols consisting of a minimal number of most informative measurements. Multi-parameter high throughput characterization of sensitive materials, parameters including response time, regeneration time, reversibility, reproducibility, sensitivity, linearity, are described in this chapter. However, despite of use of high parallelization and complete automation of most combinatorial approaches, the characterization of different chemical and physical properties of combinatorial libraries was still time consuming. For example, in the development of chemical sensors not only sensitivity, but also reproducibility, selectivity, reversibility, response time and recovery time were of importance. Therefore, it was necessary to search for a compromise between reasonable investigation time and comprehensiveness of characterization. This compromise could be found by the

development of measurement protocols consisting of the minimal number of the most informative measurements. The report of the high throughput characterization [74], involving response time, regeneration time, reversibility, reproducibility, sensitivity, linearity of conductometric gas sensitive materials, prepared as chemical micro-arrays by means of developed combinatorial electropolymerization [7] is described below.

Table. 4. Measurement steps of the developed measurement procedure

Procedure step	HCl conc. (ppm)	Conductance measurement	Slow kinetics	Fast kinetics	I-V sweep	Measurement time (min)
1	0	-	-	-	✓	~12
2	2,5	✓	✓ 2 times	✓ 2 times	-	~230
3	3,5	✓	-	-	-	4
4	5	✓	-	-	-	4
5	7	✓	-	-	-	4
6	10	✓	-	-	-	4
7	14	✓	-	-	-	4
8	20	✓	-	-	-	4
9	28	✓	-	-	-	4
10	40	✓	✓ 2 times	✓ 2 times	-	~230
11	40	-	-	-	✓	~12
Note: ✓ presented, - not presented					Total procedure time	~12:15

Practically, the whole measurement procedure consisted of several steps summarized in Table. 4. There, two measurement techniques were involved; i) simultaneous four- and two-point conductance measurement and ii) simultaneous four- and two-point I-V sweep (linear voltage sweep from -50 mV to +50 mV, 40 points, described in previous chapter)).

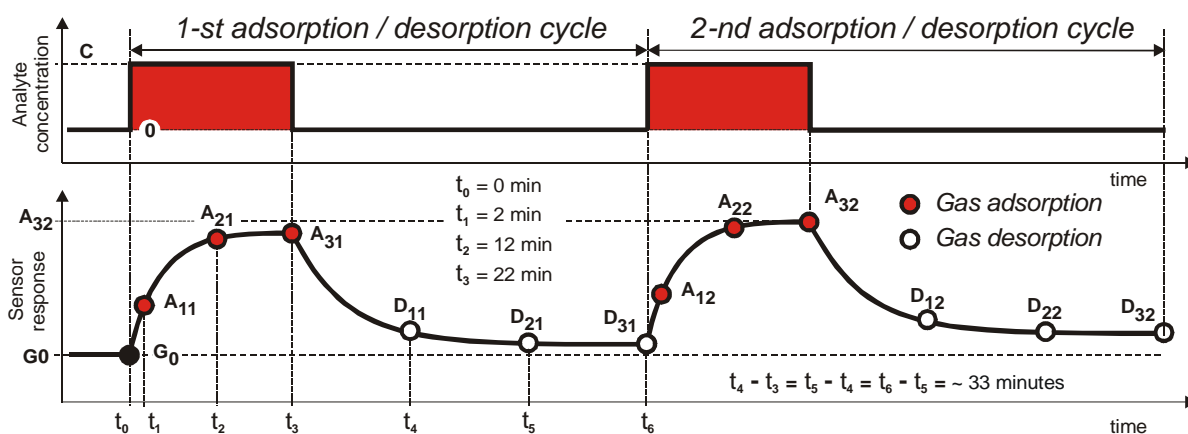

Fig. 55. Measurement of material sensitivity to an analyte in two subsequent adsorption / desorption cycles.

In the beginning, step 1, the initial conductance (G_0) without presence of analyte was measured by the I-V sweep and the conductance measurement. It was followed by two slow

kinetics at lowest analyte concentration (2,5 ppm) is shown in Fig. 55 (where process from time t_0 up to t_6 presents single slow kinetic) and then by two fast kinetics (step 2) shown in Fig. 57. The sensor response was monitored on different concentrations of the target gas from 3,5 up to 40 ppm, performed by steps from 2 to 10, shown in Fig. 57. The analyte (gaseous HCl) was diluted by nitrogen gas to obtain the required analyte concentration and total flow rate of about 600 mL / minute (taking in to account an ideal gas behavior for used concentrations and temperature). In the end, step 10, slow kinetics and fast kinetics were measured again similar to the beginning and the whole procedure was finished by measurement of I-V sweep for the maximum gas concentration of 40 ppm (step 11). The flow diagram of the described measurement procedure is schematically shown in Fig. 56.

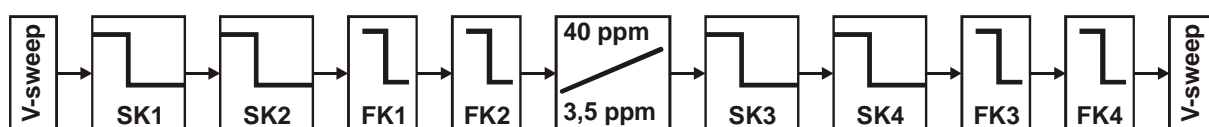

Fig. 56. Flow diagram of the measurement procedure for characterization of gas sensors

The sensitivity of polymeric materials to gas exposure, their response time, recovery time and reversibility of the effect could be tested in a single adsorption / desorption cycle. In order to obtain statistically reliable results, a simultaneous experiment with a number of identically prepared materials (rather than repeating the current experiment) could be applied. However, a test of reproducibility should include at least two adsorption / desorption cycles under identical conditions.

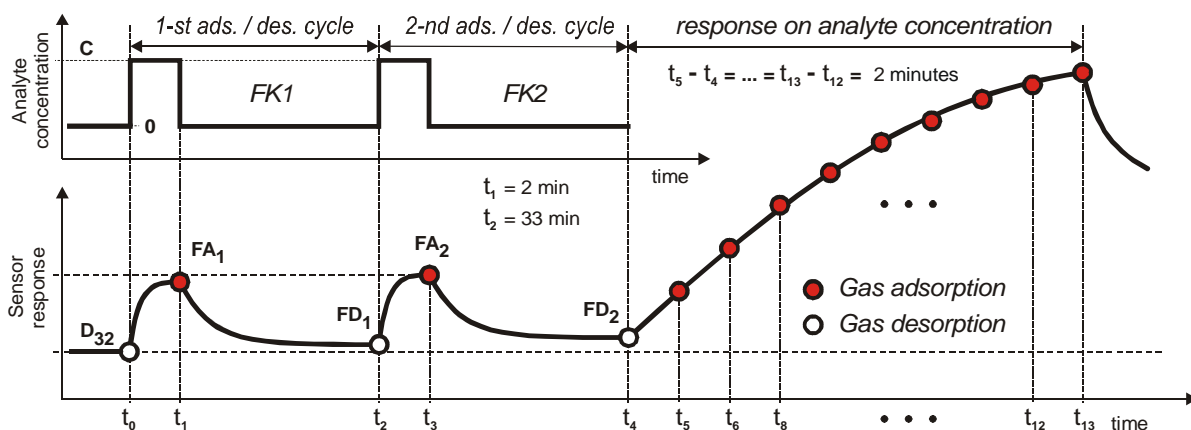

Fig. 57. Measurement of material sensitivity to an analyte in two fast subsequent adsorption/desorption cycles

Ideal mono-exponential adsorption / desorption behavior is observed relatively seldom. Rather, a non-exponential adsorption / desorption kinetics including fast and slow components, were more typical for polymeric sensitive materials. To get information on the behavior of

sensitive materials in the wide time scale, the investigation of response time, recovery time, reversibility and reproducibility should be done for short and long concentration pulses of the analyte. Some sensitive materials had poor recovery properties after exposure to high analyte concentrations. In order to get information also on unstable materials, the test should be first performed for low analyte concentration and then repeated for high analyte concentration. The time course of measurements with two subsequent adsorption / desorption cycles is shown in Fig. 55 (process from time t_0 up to t_2 presents single fast kinetic), and the data analysis in Table. 5.

It was found [66] (outlined in chapter 3.3.1) that the thermo-desorption essentially improves sensor effect reproducibility, therefore the thermo-desorption was involved into the set-up and into the measurement protocol. The single thermo-desorption consisted of four steps outlined in Fig. 58. It began with nitrogen refreshment (600 ml / min, 40°C) in order to remove the rest of analyte in the gas flow system. This step was followed by high temperature heating, what took 12 minutes for the set-up to reach the stabilization temperature. Sensors were kept at this temperature (125°C) for 10 minutes under low nitrogen flow about 10 mL / min. The third step (cooling) involved the air cooling simultaneously with nitrogen flow 600 mL / min until the temperature was stabilized at 40°C, this took about 8 minutes. The last step was conductance measurement of all 96 sensors.

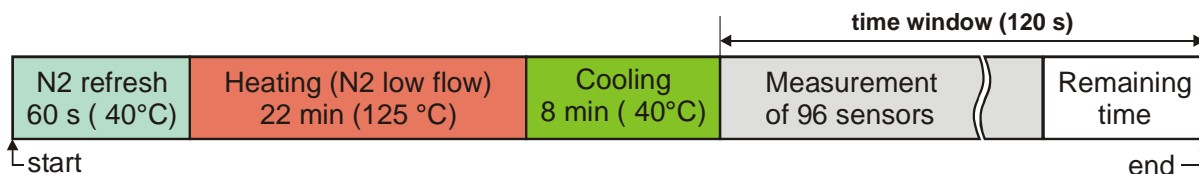

Fig. 58 Thermo-desorption principle diagram

The experimental data, measured considering the above described protocol, were analyzed in order to get parameters shown in Table. 5 and expressed below:

- The ratio of sensor signals for two subsequent measurements during the analyte addition ($KA_1=A_{11}/A_{21}$, $KA_2=A_{21}/A_{31}$) was used to characterize the response time, and during desorption (desorption efficiency). Ideal values were 1 for both cases. For mono-exponential processes, these values could be recalculated into characteristic times. In addition, even for non mono-exponential processes, where this recalculation could not be done, these parameters allowed one to make comparison of different sensitive materials.
- The ratio of these kinetic parameters was calculated for subsequent pairs of signal measurements (for example, KA_1/KA_2). It was used to characterize changes of the drift rate and ratio of small and fast components in the sensor response.

- The ratio of background sensor signals before analyte addition and after regeneration (RVS, RVF) was used to characterize reversibility of sensor materials from fast and slow kinetics.
- The ratio of sensor signals in two subsequent cycles of analyte addition (RPS, RPF) was used to characterize the reproducibility of sensor responses to analyte.

Table. 5. Description of analysis parameters

Characteristics	Calculations (measurements)	Ideal	presentation
General			
Current	I	-	I vs. x
Four-point voltage	V4	-	V4 vs. x
Conductance two-point	$G2 = I/V2$	-	G2 vs. x
Conductance four-point	$G4 = I/V4$	-	G4 vs. x
Absolute conductance	$\Delta G = G - G0$	-	$\Delta G2, \Delta G4$ vs. x
Relative conductance*	$\Delta G/G0$	-	$\Delta G/G0$ vs. x
Conductance (from I-V sweep)*	GAP init (absence of analyte)	-	GAP init vs. x
Conductance (from I-V sweep)*	GAP max (max analyte conc.)	-	GAP max vs. x
Parameters related to slow kinetics (c=1 for minimal and c=3 for maximal analyte concentration)			
Drift during gas exposure:	$KA1 = A2c/A1c; KA2 = A3c/A2c$	1	KA1, KA2 vs. x
Drift trend during gas exposure:	$KA3 = KA2/KA1$		KA3 vs. x
Drift without gas:	$KD1 = D2c/D1c; KD2 = D3c/D2c$		KD1, KD2 vs. x
Drift trend without gas:	$KD3 = KD2/KD1$		KD3 vs. x
Reversibility of gas effects			
Reversibility in slow kinetics (RVS)	$RVS1 = (D31 - G0)/G0;$	0	RVS1 vs. x
	$RVS2 = (D32 - D31)/D31$		RVS2 vs. x
Reversibility in fast kinetics (RVF)	$RVF1 = (FD1 - D32)/D32$		RVF1 vs. x
	$RVF2 = (FD2 - FD1)/FD1$		RVF2 vs. x
Reproducibility of gas effects			
Reproducibility in slow kinetics (RPS)	$RPS = (A32 - D31)/(A31 - G0)$	1	RPS vs. x
Reproducibility in fast kinetics (RPF)	$RPF = (FA2 - FD1)/(FA1 - D32)$		RPF vs. x
Analysis of the concentration dependence in Langmuir model			
Fitting of concentration dependence of the analyte effect by Langmuir isotherm and determination of isotherm parameters.	Langmuir Fitting: $\Delta G = \alpha * C / (C + C1/2), k = 1/\alpha$	max ΔG_{max}	G-G0 vs. x
			$(G - G0)/G0$ vs. x
			k vs. x
			Good vs. x
Analysis of the concentration dependence in Linear model (Linear fitting of conductance changes on the analyte concentration.)			
Slope related to absolute sensitivity	dG/dc	max	dG/dc vs. x
Slope related to relative sensitivity	$d(\Delta G/G0)/dc$	max	$d(\Delta G/G0)/dc$ vs. x
Correlation coefficient	Good	1	Good vs. x

Note, x was the parameter to be varied (for example, concentration of a dopant, its ratio, EP charge etc.), Good = R-squared or "goodness of fit" coefficient (for linear regression), Total gas flow was 600 mL / minute.

The analytical sensitivity of the material (slope of signal vs. concentration curve) could be investigated in a single experiment. However, one cannot exclude non-linear signal dependence on the analyte concentration or even the effect of combinatorial material variation on this linearity; as latter observed in many systems. In addition, a single and arbitrary selected concentration of analyte might be too low to get reliable response or, oppositely, might cause sensor saturation. Additionally, an increase of data points in the signal vs. concentration dependence allows one to perform more detailed analysis; for example distinguishing different adsorption models, calculation of binding constants, or even characterization of homogeneity of binding sites. The designed protocol involved response measurement of the polymer structures under nine analyte concentrations. The data could be analyzed by Langmuir adsorption isotherm or by linear Henry model. In the first case, a maximum response and a binding constant could be calculated. In the second case, an absolute sensitivity according to the IUPAC definition (the slope of the dependence of the absolute signal change on the analyte concentration), the relative sensitivity (the slope of the same dependence but for relative signal values) and the linearity (correlation coefficient) could be obtained.

3.2 Electronic system of the measurement concept

The electronic system was similar to the one used for electropolymerization (EP) concept. The system consisted of the same instruments and compounds; the high-impedance electronic multiplexer (MX96), the source monitor unit Keithley 2400 (SMU), the multimeter Keithley K2000 (it was additional instrument referring to the EP concept), the interface board (IB) with the test clamp socket (YAMAICHI) and of the miniature thermostat. The SMU [127] was configured in constant voltage / current sense mode, so it generated constant voltage on the outer strips of the corresponding IDT electrode and monitored the current flow through them. The multimeter K2000 [180], with the specific input resistance of 100 M Ω , was used during simultaneous two- and four-point measurements as the voltmeter V4, shown in Fig. 59 (the measurement principle was described in the chapter above). The V4 voltmeter was connected parallel to the sense lines (Hi and Lo) of the SMU by two BNC T-adapters, on the back side of the MX96 (additionally implemented). It was possible to perform separate four- or two-point measurements by involving only the SMU configured in remote sense mode [127] (V4 voltmeter was not required). However, the remote four-point measurements offered better sensitivity due to the measurement principle, which was based on the retention of the voltage V4 on inner strips of the IDT electrode constant by adjustment of the current flow through the outer strips (current flow was monitored), the V2 voltage could be in this case limited only by the K2400 circuit, which supported only several fixed limits (the 20 V limit was the lowest possible) [127]. This limit was too high for several applications, therefore the measurement circuit for simultaneous four- and two-point measurements was designed in order to fix the V2 voltage on defined level (in our case to 50 mV) as outlined in Fig. 59 and mentioned in previous chapters.

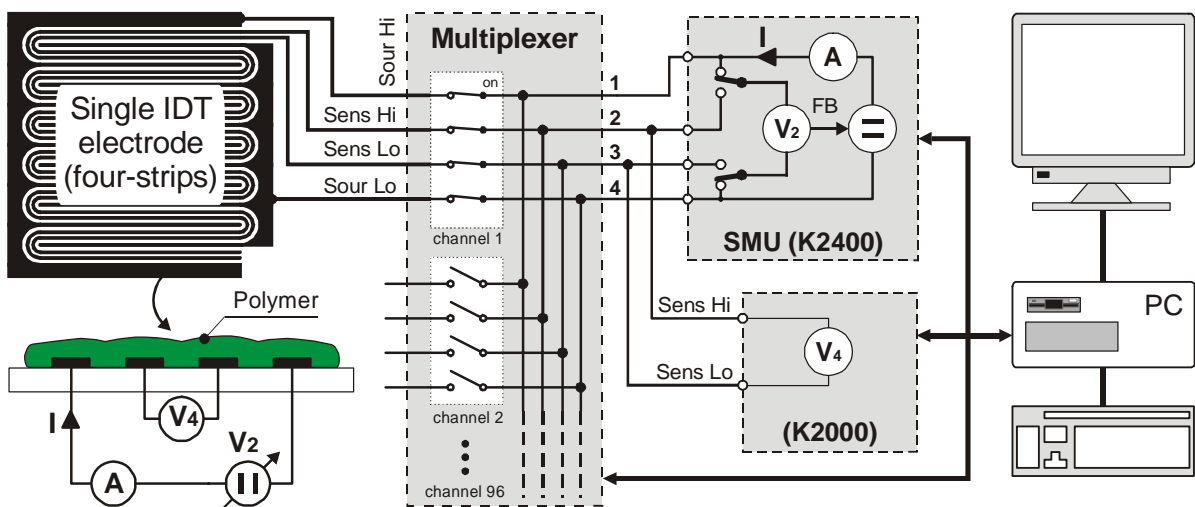

Fig. 59. Block schematic, electronic system

If the limitation of the V2 voltage was not important and could reach 20V, the simultaneous measurement could be performed with K2000 connected as V2 voltmeter and SMU configured in remote mode (for four-point measurement, opposite switch direction of two switches K2400 in Fig. 59). In this case the measurement sensitivity was improved (the standalone protection circuit could be implanted to keep the V2 voltage below specified level). The MX96, connected four analog signals, two sense and two source lines, of the measurement instruments with corresponding IDT electrode so allowed consequent screening of IDT electrodes on the electrode array (EA).

The K2000, similar as K2400 SMU, was controlled through GP-IB interface from the computer involved in the EP concept too. All cable connections corresponded to the connections of the EP concept, therefore their replacements and modifications were not required when EP mode was changed to the measurement one and back. The used instrumentation, including the MX96, the interface board, the electrode array, the thermostat are described in chapter 2.

3.3 Multiplexer 96

During screening, the MX96 was configured in the measurement mode, which corresponded to the simplified schematic in Fig. 60, Fig. 59. The 4A relay switch configuration was completely employed here and the 2B configuration was not used (in opposite from the EP mode). The 2B configuration could not be used during measurements because it was electrically unconnected from the MX96 output terminal (BNC). If it was required, even during measurement (for instance during amperometric method), a hardware and software modification was necessary. The multiplexer supported two additional modes such as short circuit test and zero offset:

- Short circuit test mode (switch S2 in Fig. 60), connected measurement signal lines so that 1+3 and 2+4 lines (according Fig. 59 and Fig. 60) were interconnected and then used for offset compensation of the SMU to the voltmeter K2000 in order to improve of the measurement precision (usually K2400 offsets less than 300 μV were observed at 50 mV, this presented error of about 0,6%).
- Zero offset mode (switch S3 in Fig. 60), interconnected all signal lines in the MX96 and created the shortcut. This mode was used for zero compensation of the SMU and the K2000 voltmeter, thus decreasing measurement error. Typically the offset of the K2000 voltmeter was less than 20 μV (at range 200 mV, when auto zero was involved) and the SMU offset was less then 200 μV (at range 200 mV). Note, that the offset values related to last calibration of the instruments and used measurement modes. The introduction of this mode into the measurement improved the measurement concept (for example at V4=1mV, 20 μV of the V4 voltmeter offset gave error of about 2%).

The mentioned modes were implemented into the set-up hardware and the measurement software and applied in last realized combinatorial experiments. The presence of the offset mode in a measurement could be recognized in the measurement status file (chapter 10.4), where calibration values were stored.

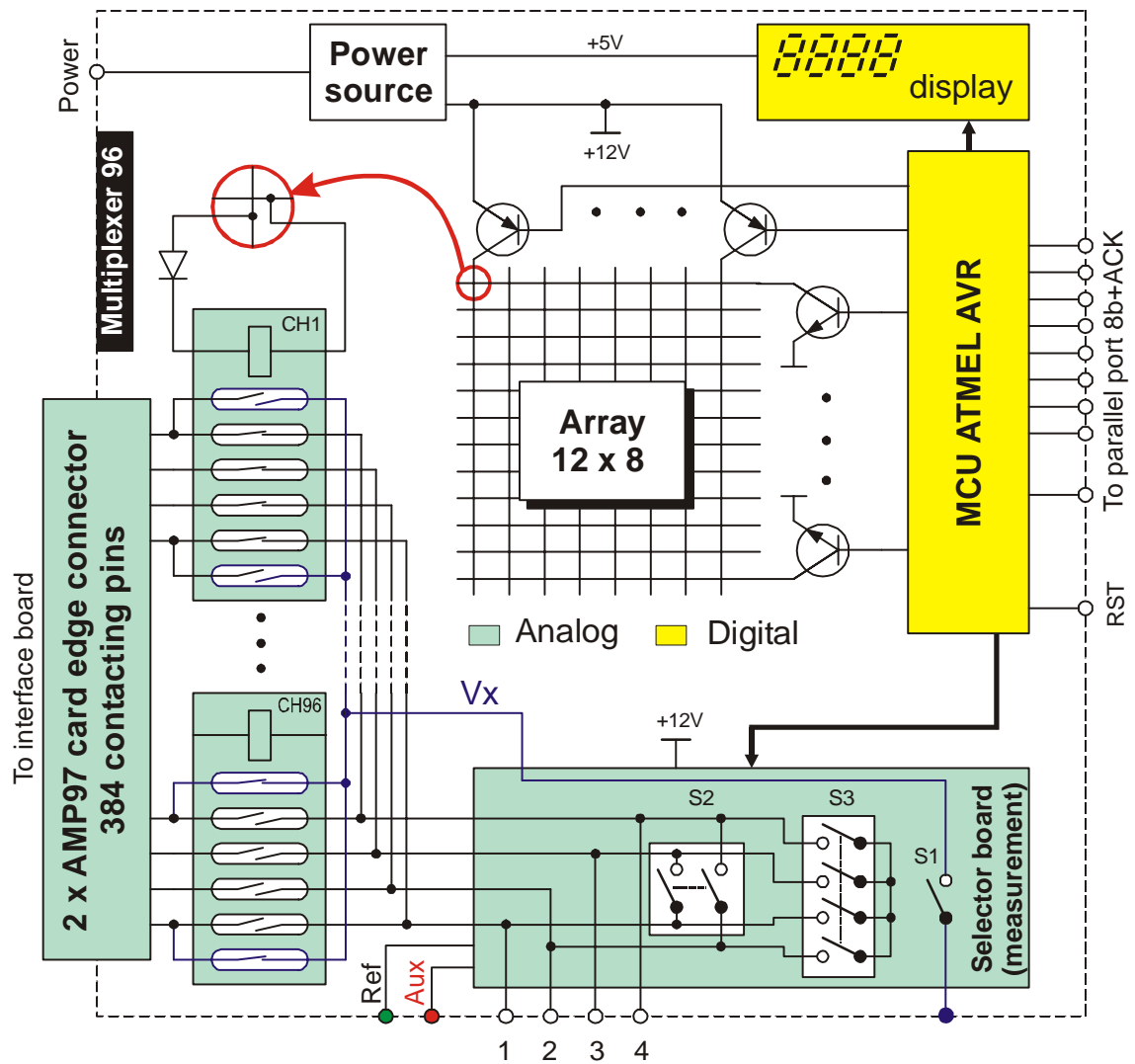

Fig. 60. Multiplexer 96, configured in measurement mode

The zero offset mode was performed for each scan (single measurement step-line in the measurement procedure file = 96 electrodes, independent from the measurement mode). The short-circuit mode was basically programmed but not fully implemented. The offset values were recorded for each scan (96 electrodes) individually in the measurement status file; this is described in the software chapter 3.5.

The measurement error could be further decreased by use of more precise instruments and techniques (lock-in amplifier). Also other measurement methods as capacitance measurements, optical and others could be of interest.

Table. 6. Capacitance measured on the MX96 terminals

circuit / capacity	no EA	with EA	note
Source Lo - Snese Lo	129-140pF	130-200pF	all channels incl. OFF (MX96, channel 0) state
Sense Lo - Sense Hi	100-120pF	<170pF	
Source Hi - Sense Hi	129-140pF	130-200pF	
Source Hi - Source Lo	<80pF	<100pF	

The characteristic capacitances, that could help in further improvements, measured on terminals of the multiplexer MX96, are listed in **Error! Reference source not found.** The capacitance measurement was performed at room temperature by the RLC meter Hewlett Packard 4261A, configured in parallel circuit mode, with AC test signal level of 1 V (1 kHz) and DC bias voltage of 0 V.

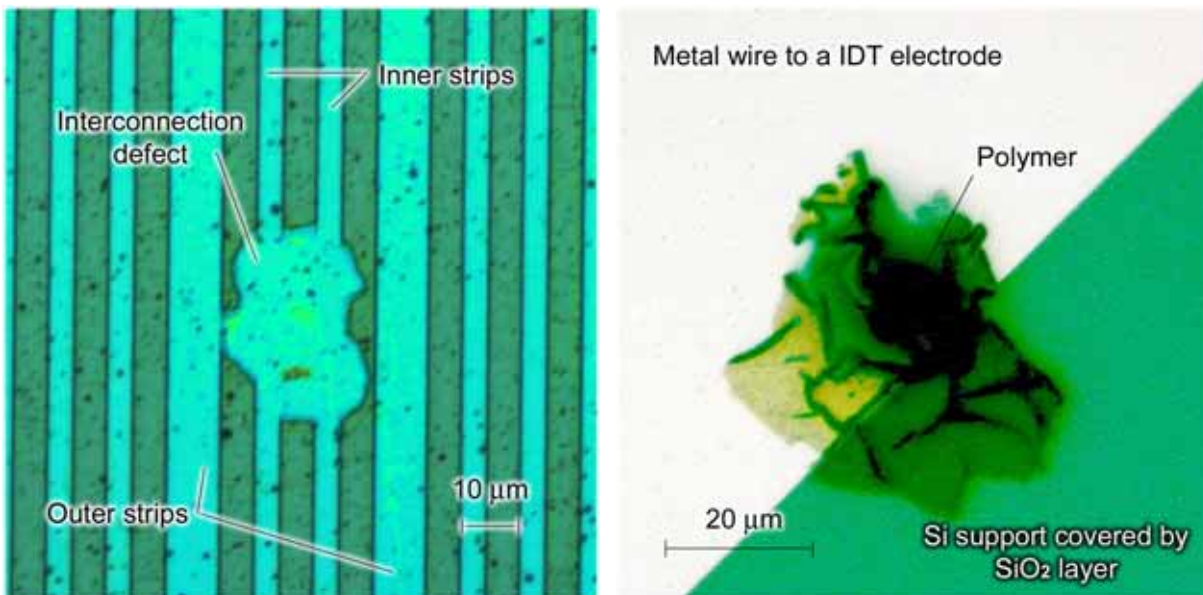

Fig. 61. Defects observed on electrode arrays, short circuit defect (left), break-through defect (right)

However, during the EP, most of electrodes were covered by polymer of specific content, not all of them were functional. Therefore, the additional modes were implemented into the MX96 hardware as summarized below.

- Short circuit test mode (switch S2 in Fig. 60), connected measurement signal lines so that 1+3 and 2+4 lines (according Fig. 59 and Fig. 60) and thus measured the electrical resistance between neighboring strips of the IDT electrode. This mode was used to check the insulation properties of IDT electrodes. Short circuit or increased conductance between neighbor strips (caused for instance by a defect shown in Fig. 61, left) indicated defects of some electrodes of the array. This test should be performed before electropolymerization (experiment) to exclude defected electrodes thus saving the experimental time.

- Measurement of the insulation resistance between the metal electrode layer and the semi-conducting EA support. It was found that the defects shown in Fig. 61, right, occurred in few cases, this led to electrical interconnection of the metal layer, by growing polymer in the defected area, with the semi-conducting support. This affected electropolymerization on the defected electrode and could result in modification of the protection potential (affecting whole EP). It occurred occasionally, therefore that time it was not a point of concern. To implement this detection technique, the MX96 hardware and software upgrade will be necessary.

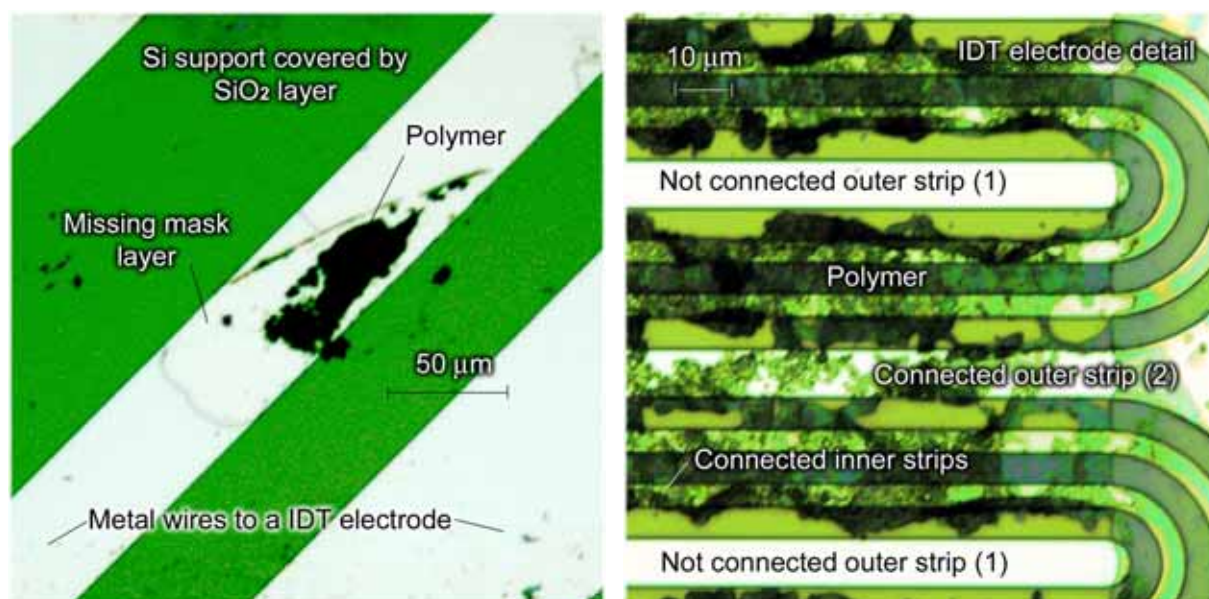

Fig. 62. Defects observed on electrode arrays, mask defects (left), connection defects (right)

- Interconnection test, electrical test of the electrical connections between the electrode strips and the MX96. Because this test should be performed as amperometric measurement, an appropriate electrolyte was required. It happened that the connection wires between strips and connecting pads of the EA were interrupted (scratched, etched, etc.) respectively contact pads were damaged or the masking layer was not etched completely, thus the EA was functionless. It usually resulted in a not complete electropolymerization as illustrated in Fig. 62, right, where one electrode strip (1) in Fig. 62, right was not connected so no polymer was attached to its surface.
- Electrode area comparison test. Due to the dependence of the amperometric current on the electrode area, this previous mode could also be used for comparison of the active areas of IDT electrodes. Thus separated electrodes with defected mask layer, when the area of electrode was smaller (the mask layer was not pretreated correctly) or bigger as defined (the mask layer was missing, shown in Fig. 62, left).

3.3.1 Thermo-stabilization

The thermo-stabilization during measurements was necessary, similar as in the case of the EP. Not only adsorption (Fig. 63, left) depends strongly on temperature, but also desorption (Fig. 63, right) was found faster at higher temperatures. This was important point for general improvement of HCl polymer sensors designed for detection of gaseous HCl [66]. The relative conductance of PANI based sensor was increased with increasing temperature, however, the absolute sensitivity was decreasing (not presented here), shown in Fig. 63, left. This resulted from the influence of temperature on the equilibrium between an adsorption and desorption in the gaseous–solid phase [66]. The similar studies have been done for desorption process. An influence of temperature on the relative conductance of a PANI based sensor (after doping with gaseous HCl, 80 ppm) was observed. After adsorption the sensor was kept at constant temperature (heated) and thermo-desorption kinetics for various temperatures were recorded, shown in Fig. 63, right. This facts led to involving of the thermo-stabilization and also the new thermo-desorption technique into the combinatorial screening process.

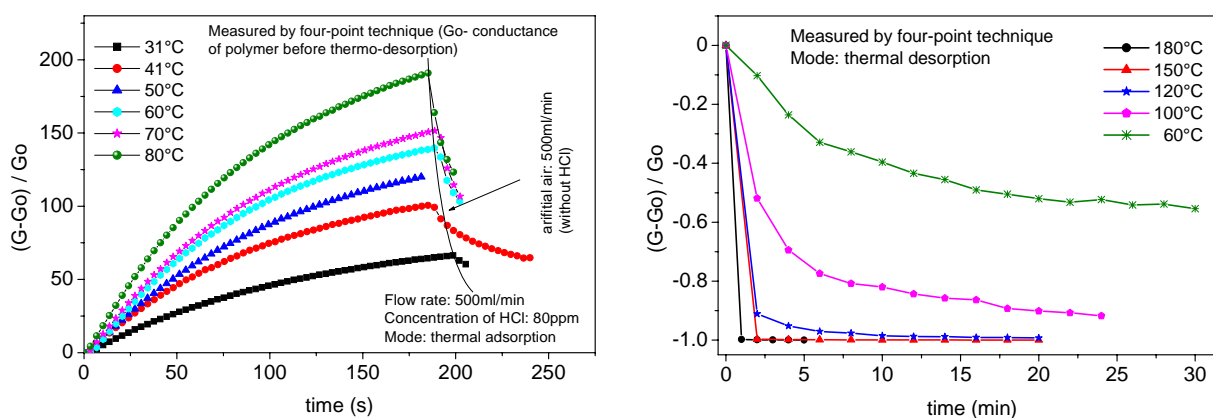

Fig. 63. Response of PANI based sensor on exposure to gaseous HCl (left) at different temperatures, kinetics of PANI based sensor involving thermo-desorption of gaseous HCl in temperature range from 60°C to 180°C (right) [66]

The same thermostat and its functional parts as used for EP concept were involved. Only thermo-stabilization range was increased up to 125°C, because of requirement by the adapted thermo-desorption principle (described in the measurement protocol 3.1). However, later was found that the temperature even higher than 125°C (tested with 150-170°C) was preferable for the faster thermo-desorption, the maximum temperature of the thermostat was limited by the involved thermo-sensor. The temperature range could be increased up to 170°C (limitation of the test clamp socket used) by a new thermostat based on a different thermo-sensor (for instance PT1000 or similar). The functional parts of the electronic thermostat included an additional cooling circuit that is described in chapter 2.5.1. The thermostat was

controlled similarly as in the EP case by the computer (Fig. 64) according to the measurement procedure. It was found that the heating from room temperature (about 30°C) up to 125°C took less than 15 minutes (because of heating power of the thermo-element, previously not designed for temperature pulses and because of the gas cell, socket and EA mass). The cooling back to room temperature required less than 7 minutes, in the case when the 600 mL / minute gas flow (gas cylinder at room temperature) and air cooling were involved. The heating time could be decreased by application of a stronger heater or by preheating the gas flowed through the gas cell. This case was taken into account during the thermostat design, it allowed implementation of one additional heating channel for gas preheating as outlined in Fig. 64. The heating element could be realized on the base of dissipation power of a transistor (Bipolar, MOSFET – as used in the thermostat version 3.1 [157] for single experiments.), respectively of a power resistor (foil), etc.

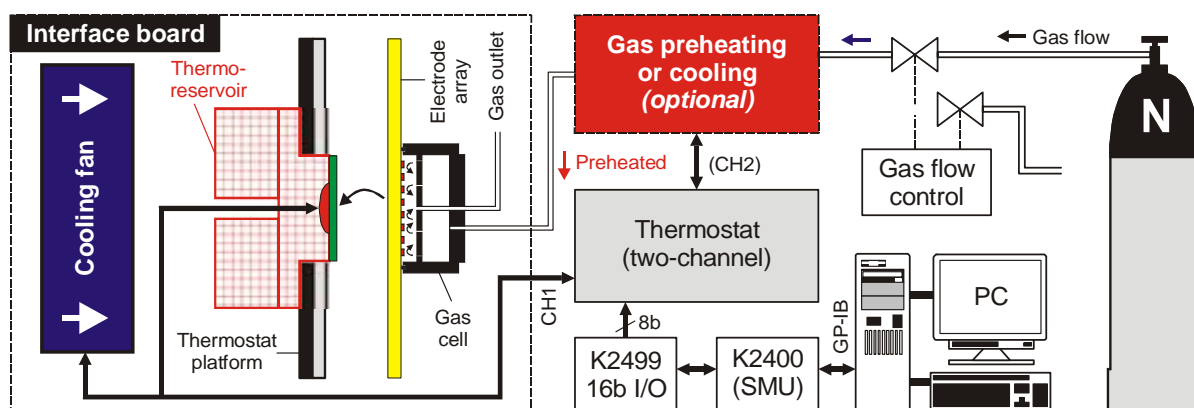

Fig. 64. Block diagram of the thermo-stabilization set-up for measurement concept, with optional gas preheating improvement

To decrease the self-cooling time the gas flow and the external cooling fan were used (Fig. 64). Anyway, the most efficient cooling was observed by the gas flow through the gas cell (nitrogen respectively artificial air with flow rate of 600 mL / minute, gas cylinder was at room temperature).

The measured dynamic of the thermostat, according to the conditions specified in the measurement protocol (described in chapter 3.1) is shown in Fig. 65. It was performed at room temperature of about 24°C ±1°C (including the gas cylinder filled by nitrogen). During the heating up to 125°C the gas cell was permanently flushed by nitrogen with flow of about 10 mL/minute (due to removing of remaining gases from the polymer layer after adsorption). Approximated time constant for heating (tau, according to the exponential model) was about 280 seconds, but it was depending on room temperature. The cooling back to 40°C±1°C was additionally advanced by nitrogen flow of about 600 mL/minute, thus the cooling constant (tau, according to the exponential decay model) was about 53 sec. These results were involved

during development of the measurement protocol. Note that the integrated temperature sensor (the same was used for temperature feed-back of thermostat) was also used for these measurements. According to the simple proportional (P) regulation, the temperature error was increased with the stabilization temperature. It was observed that the absolute error (at maximum temperature of 125°C) was less than 0.4°C, this was not significant for our purposes. Anyway, it can be resolved by application of the PI (proportional, integral) in hardware or in software.

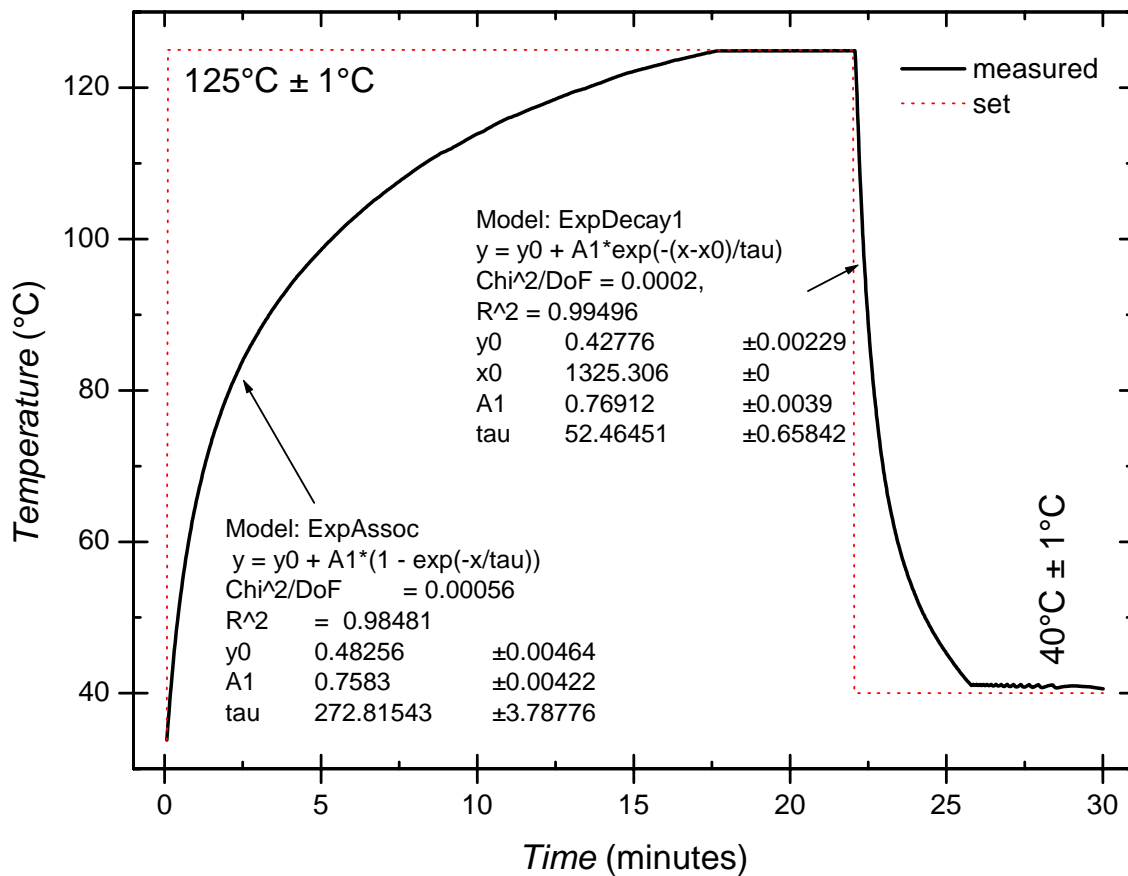

Fig. 65. Thermo-dynamic of the realized thermostat (according to the conditions specified in the measurement protocol)

Due to the application of the continual regulation, temperature fluctuations were less than $\pm 0.02^\circ\text{C}$ for the stabilized temperature of $100 \pm 1^\circ\text{C}$, and even less than $\pm 0.005^\circ\text{C}$ for the stabilized temperature $40 \pm 1^\circ\text{C}$. These results were measured as average values for mentioned temperatures within 60 sec. after temperature stabilization (performed at room temperature of about $24 \pm 1^\circ\text{C}$).

3.4 Analyte addition, Gas flow system

This chapter deals with design and realization of a separate part of the EP set-up, responsible for preparation and transport of target gas into a cell where the electrode array (EA) was placed during measurements. The gas flow system, was not the point of view of this thesis, therefore only its outline and principles are mentioned below. The gas flow system consisted of several precision gas flow valves from KMS instruments connected through the pressure reducers with target and diluting gases. Only two valves were used in this project, shown in detail in Fig. 66. A separate computer (GPC) controlled the gas valves electrically, where the software with implemented TCP/IP communication was installed. The software was written under the National Instruments (Lab View 5.0) software and it presented an interface between the EP set-up and the gas valves. The EP set-up controlled these valves by the GPC computer through TCP/IP connection (computer network) using one string commands. Single string command consisted of four numbers, where each gave value to corresponding gas valve it controlled. This realization was done because this work was performed parallel with another work on measurements of optical properties (different set-up). However, this system worked correctly, it required additional computer (more energy consumption), network connection and additional software. It could be easier to control these valves directly by the EP setup, only two-channel D/A converter should be used (the gas valves were controlled by voltage in range of 0 – 1 V, which corresponded to floodgate marked on valves).

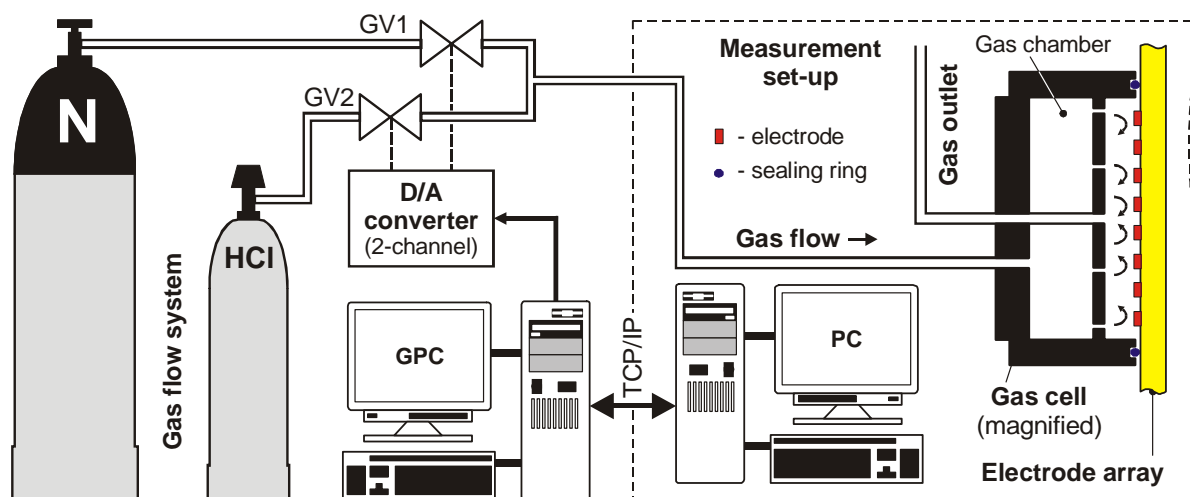

Fig. 66. Gas flow system connected to the measurement set-up

Most of the experiments were performed under gaseous hydrogen chloride (HCl). It was diluted by nitrogen to get required concentrations according to previously described measurement protocol; therefore, only two gas channels were required. However, additional channels could be added in order to adapt humidity control (such tests were performed on

single electrodes). The flow of the HCl with initial concentration of 200 ppm was adjusted by the gas valve “GV2” (Fig. 66) with the maximum flow rate of 200 mL / minute and resolution of 1 mL / minute. The nitrogen was adjusted by the valve “GV1” with maximum flow rate of 5000 mL / minute (decreasing its maximum flow rate led to an increase of the dilution precision). The total flow (fr_{TOTAL}) was kept constant at 600 mL / minute for each HCl concentration so the concentration was calculated according to equation

$$c(HCl) = \frac{fr(HCl)}{fr_{TOTAL}} \cdot c_0(HCl), \quad \text{Eq. 1}$$

where $c(HCl)$ was the required concentration (ppm), $c_0(HCl)$ was initial HCl concentration in cylinder (about 200 ppm) and $fr(HCl)$ was the flow rate of HCl in range 0-200 mL / minute. The complete measurement of one EP library (one EA) consumed about 14,4 liters of HCl and about 110 liters of nitrogen respectively artificial air ($N_2/O_2=4/1$) at room temperature and pressure of about 1 Bar.



Fig. 67. Practical realization of the gas flow system

The 10 liter cylinder of HCl (pressure 150 Bar) covered more than 100 measurements and a 50 liter cylinder (pressure 200 Bar at room temperature) of nitrogen covered more than

90 measurements according to the developed measurement procedure. The gas consumption could be reduced by decreasing of the total gas flow, in this case the flow rates of the valves and initial concentration of HCl should be optimized. The practical realization of the gas flow system, involving gas cylinders pressure reducers and electronic gas valves is shown in Fig. 67. The number of analytes could be simply increased by adding other valves, the only limitation was the number of channels of the D/A converter (in this case four channels for different analytes). The diluted gas was flushed throughout the gas cell closed by the EA, described in the following sub-chapter.

3.4.1 Gas flow cell for combinatorial screening

The cell had one input and one output, shown in Fig. 66. The gas flow was redistributed from the inner chamber of the cell with volume of about 1,44 mL through several holes with diameter of about 0,7 mm into the inner cell volume with volume of about 1,38 mL around the EA. The gas was flowed out through the outlet with diameter of about 2 mm, situated in the middle part of the cell, into the gas ventilation system. The cell was completely made of stainless steel (resistive to corrosive gases) with outer dimensions of 29,5x29,5x7, the Viton sealing ring was inserted between the cell and the EA, thus creating a closed volume for gas flow. The practical realization of the gas cell (opened, without the electrode array) is shown in Fig. 68, left. This optimized gas cell replaced old designed cell which had no inner chamber and with direct input in to the inner cell volume.

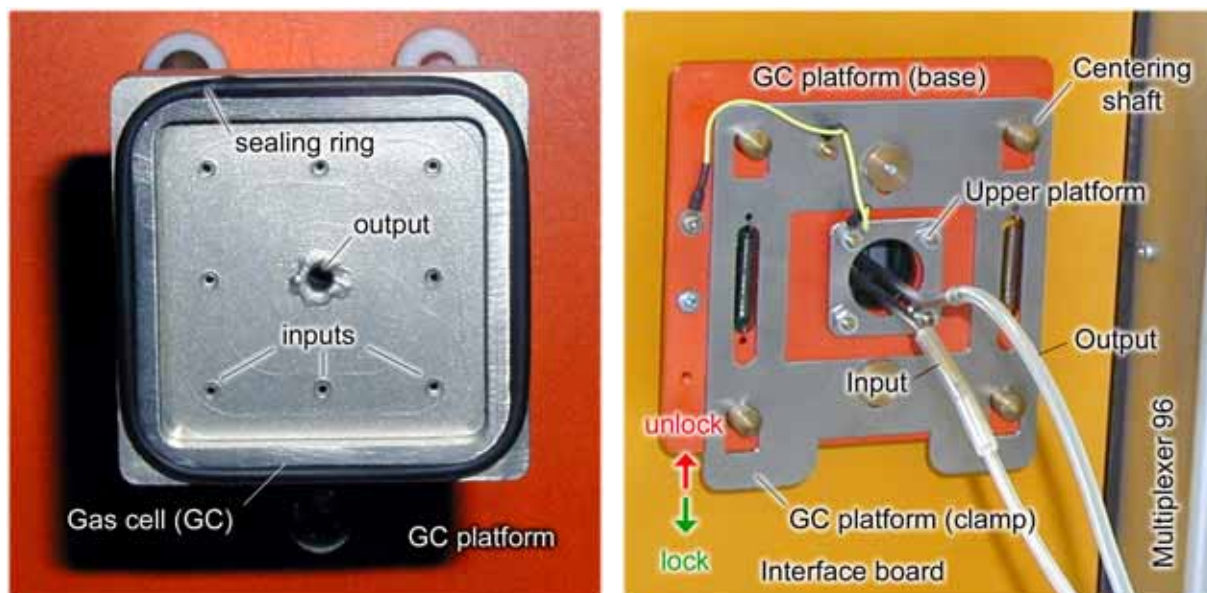

Fig. 68 Gas cell – front view (left), self-locking mechanism of the gas cell platform (right)

The gas cell was attached by a platform shown in Fig. 68, right to the measurement set-up similar as the EP cell in the previously described electrochemical concept. The gas cell

platform (GC platform) consisted of three main parts; a base, clamp and upper platform. Two special screws were mounted through the clamp to the platform base (made of aluminum plate 5 mm). Thus, the construction allowed one-direction movement the clamp as outlined by arrows in Fig. 68, right. Two side strings, returned the clamp to its initial (lock) position. The upper platform fixed positions of long screws. By pressing the clamp against the base, platform was unlocked from the set-up (interface board). In this case, the previously lapped holes for centering shafts of the base were completely opened, this allowed the gas cell to be detached. The self-locking principle was the same as for electrochemical cell platform described in chapter 2.1.3. It used same centering shafts mounted on the rear panel of the interface board. The gas cell was attached to the platform by four long-screws crossed PTFE transitions used to decrease friction during the gas cell one-directional shift, allowing one-way movement (same as in the case of electrochemical cell) across the axis perpendicular to the surface of the EA. The shape of the centering shafts determined the distance of the platform from the surface of the EA and thus adjusted the pressure, which was applied to the electrode array by the gas cell in order to create with the EA hermetically, sealed volume (closed gas cell). Four strings around four long-screws, which pushed the gas cell against the platform, realized this pressure. For description that is more detailed refer to the description of the electrochemical cell. The technical drawings can be found in [181].

3.5 Automated electrode array measurement software, ARYMS

Because the screening of one combinatorial library (EA) took around 12 hours, by application of the developed measurement protocol, it was necessary to create an autonomous software. ARYMS (ARraY MeaSurements), which took control over the screening processes. The software executed all measurements of all IDT electrodes according to the steps (single lines) defined by the user in the procedure file. All screened results were stored into files of an appropriate form placed in the library folder (defined by previous EP). Several options were available in the software main window (Fig. 69), such as “Study definition”, “Start”, “Help” and “About”. The ARYMS did not offer user’s settings in the main window, because all important parameters and settings were specified in the procedure file.

A “Study definition” tool, simplified generation of the ASCII procedure file, described in detail in appendix 10.4. Its structure was similar to the library file used by the electropolymerization software (CEP). In contrast with CEP, where each experiment (library, EA) had its own unique library file, the screening was performed by using only one. It was the same procedure file for all screened libraries, which in detail copied the developed measurement protocol. The rules how this file should be written (its form) could be also found under “Help” option of the software.



Fig. 69. Main option window of the ARYMS software

The main window of the ARYMS software (Fig. 69) indicates that only one button was important. It activated complete screening process of the recent library, shown in the simplified flow diagram in Fig. 70.

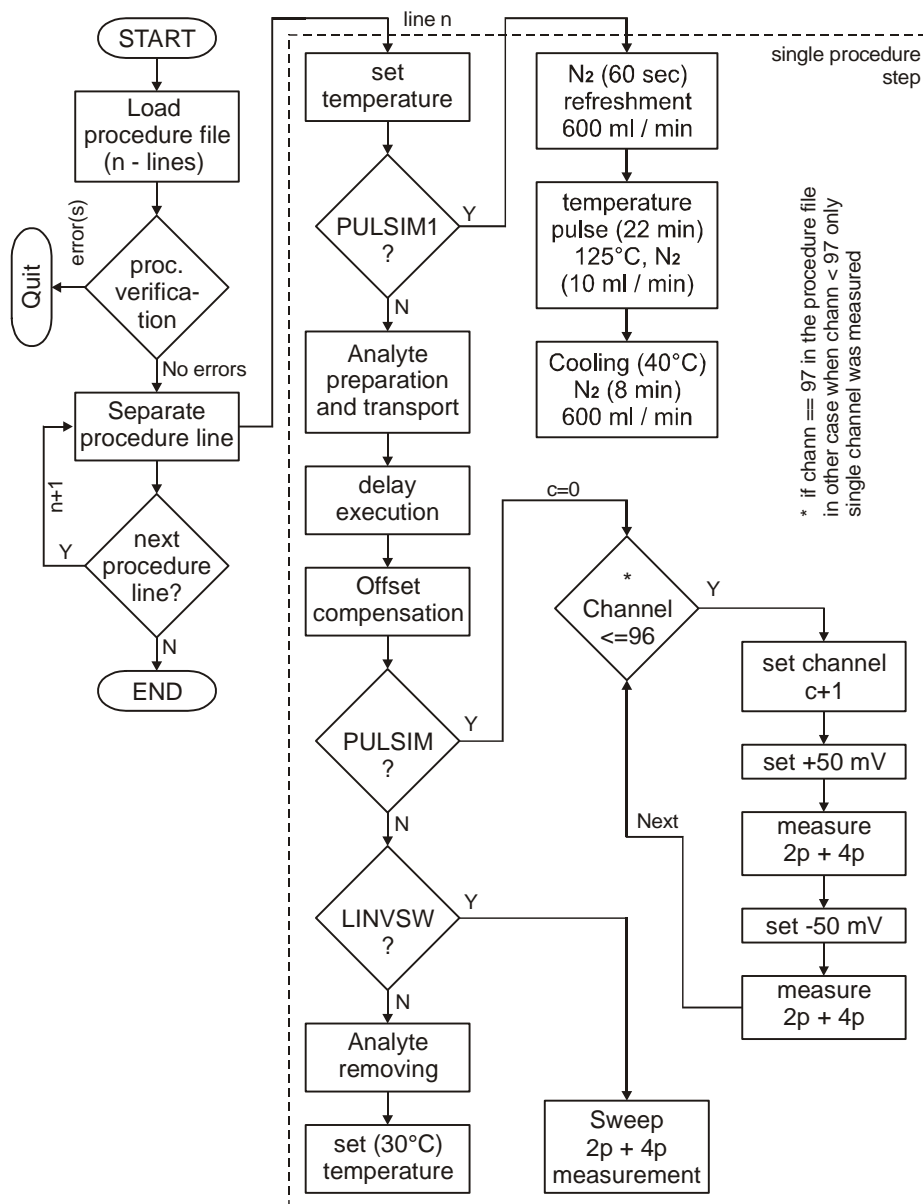

Fig. 70. Flow diagram of the automated screening, performed by the ARYMS software

The screening began with loading of the procedure file, indicated in the “Load procedure measurement file” window shown in Fig. 71. During the loading the content of the each single line (42 lines) of the procedure file was verified. If the content of any procedure line did not correspond to the definition of the procedure file and / or to supported ranges, a list of errors occurred and the screening process stopped. In the load procedure window, the “Browse” button should specify the library name of a previous EP (exactly its library folder). This library name specified the library folder where all measured data was written, after screening, into the specific folders, described by the directory structure in appendix 10.4. Usually, the ARYMS software offered the folder of the last EP library and the “Browse” option could be used for re-screening of an older library. Finally, gas settings such as initial

HCl concentration and total flow rate should be adjusted in this window. Default, the option “Use external parameters” should be enabled, in order to use external analytes (gases) during experiment. When no analyte (measurement of the initial EA state, etc.) was required, the option “Use external parameters” should be disabled.

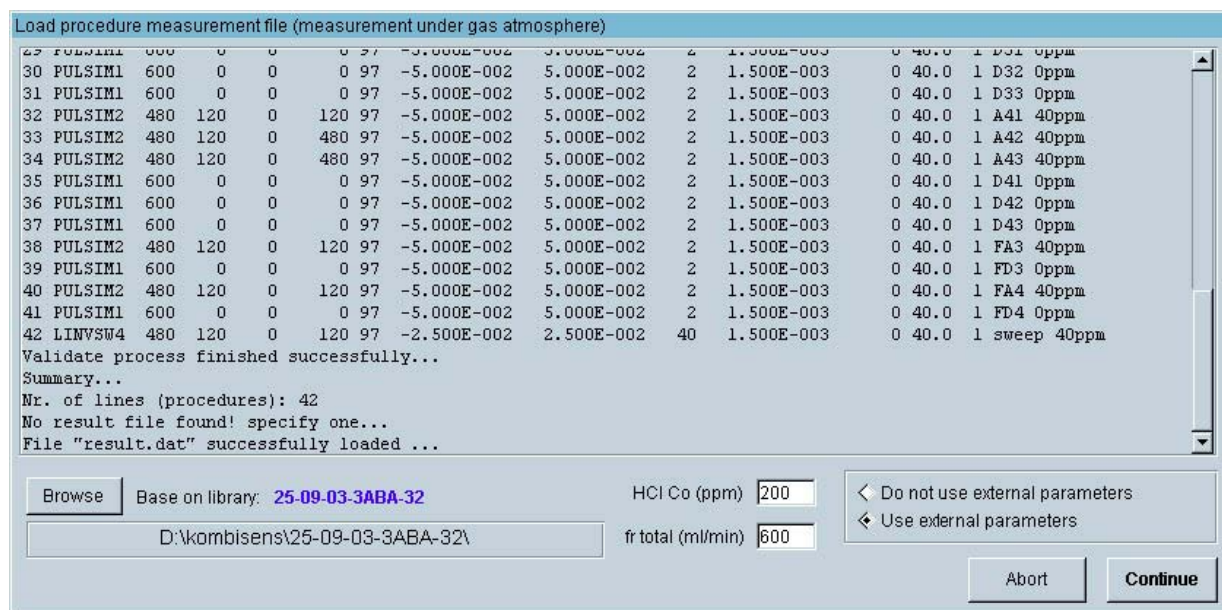

Fig. 71. Load procedure window of the ARYMS software

Successful loading and analyte settings (in the load window) were followed by execution of each single line of the procedure file separately according to the flow diagram in Fig. 70. Each screening step was performed by adjusting the temperature, defined in the corresponding procedure line. Then the thermo-desorption was used and the target analyte (target gas HCl) was diluted and transported into the EC. This was controlled by sending configuration strings, involving the TCP/IP protocol, to the client program executed on the neighboring computer (used for gas dilution). After receiving acknowledge string from the client computer the delay (specified by the procedure line) was applied, so the EA was kept under gas flow for the delay time. Then the offset compensation was performed, consisting of three steps, i) the zero offset for both K2000 and K2400 was applied, ii) +50 mV was set by K2400 (Source) and the measured value by the K2400 (Sense) was adapted to the one measured by the K2400 voltmeter, iii) the previous step was repeated for -50 mV. The new offset values were used during screening (single step) and re-offset with the beginning of next procedure step. The offsetting was followed by the measurement. The ARYMS software supported two measurement modes, the linear voltage sweep and the pulse measurement mode, both involved simultaneous two- and four-point technique, as described in chapter 3.

The linear voltage sweep results, configured by the corresponding procedure file, were displayed during screening in the “Linear Voltage Sweep 2p & 4p simultaneous” window,

separately for two (Fig. 72, left) and four-point (Fig. 72, right) measurements. The Resistance indicated in this window was calculated from the linear approximation of the screened I-V characteristics. However, the software allowed the use of hysteresis in linear sweep, it was not involved due to the low voltage range of 50 mV, where any non-linearity and hysteresis effects were observed. The linear sweep was applied in measurement of an initial state of the library (after EP, without analyte) and in last step (with maximum gas concentration of HCl, 40 ppm), this represented less than 5% of its application during automated screening.

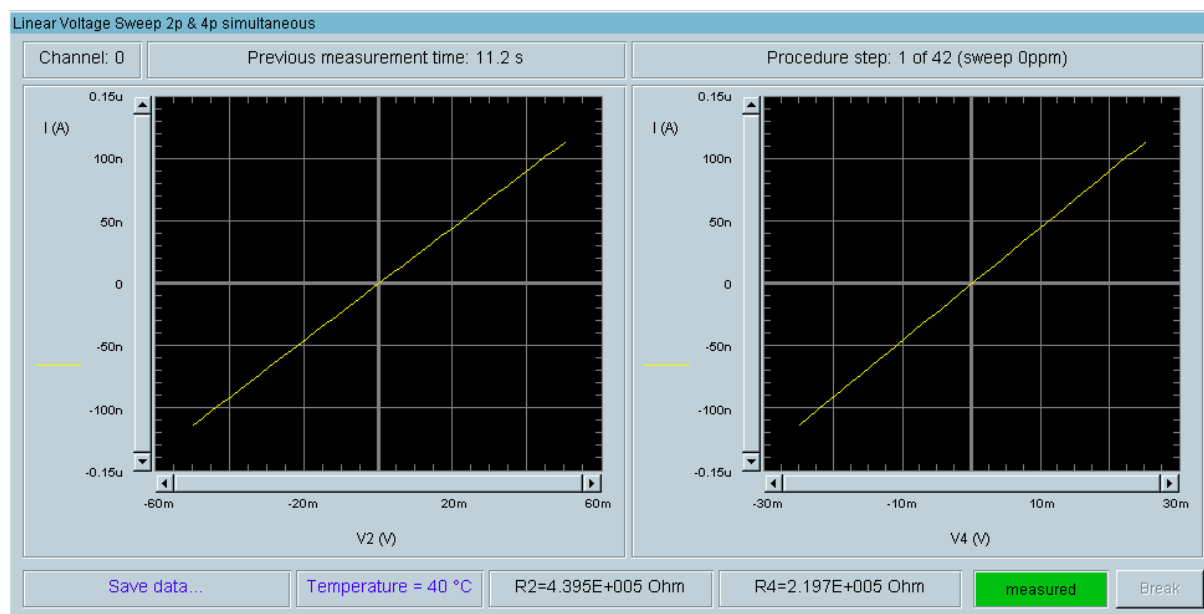

Fig. 72. Linear Voltage Sweep 2p & 4p window of the ARYMS software

The pulse mode, described in chapter 3, used by most of the procedure steps (95%), was performed for all 96 IDT electrodes of the library (EA) consequently. The measured results were displayed simultaneously with the recent measurement in the “Pulse measurement 2p & 4p simultaneous” window shown in Fig. 73. In the chart on the left hand side, the measured data consisted of current and voltage values displayed separately for positive and negative pulses. Thus each sensor was represented by four measured (two current and two voltage) values. The chart had two scales, one for current and one for four-point voltage. Ideally, the stairs should land in the circles of the corresponding color, this referred to the good fit of the absolute values of the positive and negative pulse (in the linear case). Note, that the data presented in Fig. 73, was taken without applying the offset compensation technique. In this case the error for four-point voltage was about $\pm 0,1\%$ and $\pm 0,3\%$ for current values. The error varied with electrical properties of screened IDT electrodes and was minimized around 2-5 times by application of the mentioned offset technique. The average of the absolute values (positive and negative pulse) corresponded to the two-point voltage and it was indicated in the right bottom corner (“V=5.017E-002”, Fig. 73). The pulse mode had an implanted data filter

for four-point measurements, which separated screened electrodes with a difference of the average pulse value less than 5% and displayed them in the chart on the right hand side (Fig. 73). It allowed graphical separation of working, functionless respectively non-linear behaving electrodes. The resistance values (R2, R4, bottom) were continuously calculated only for working (accepted) electrodes as the average of their absolute values.

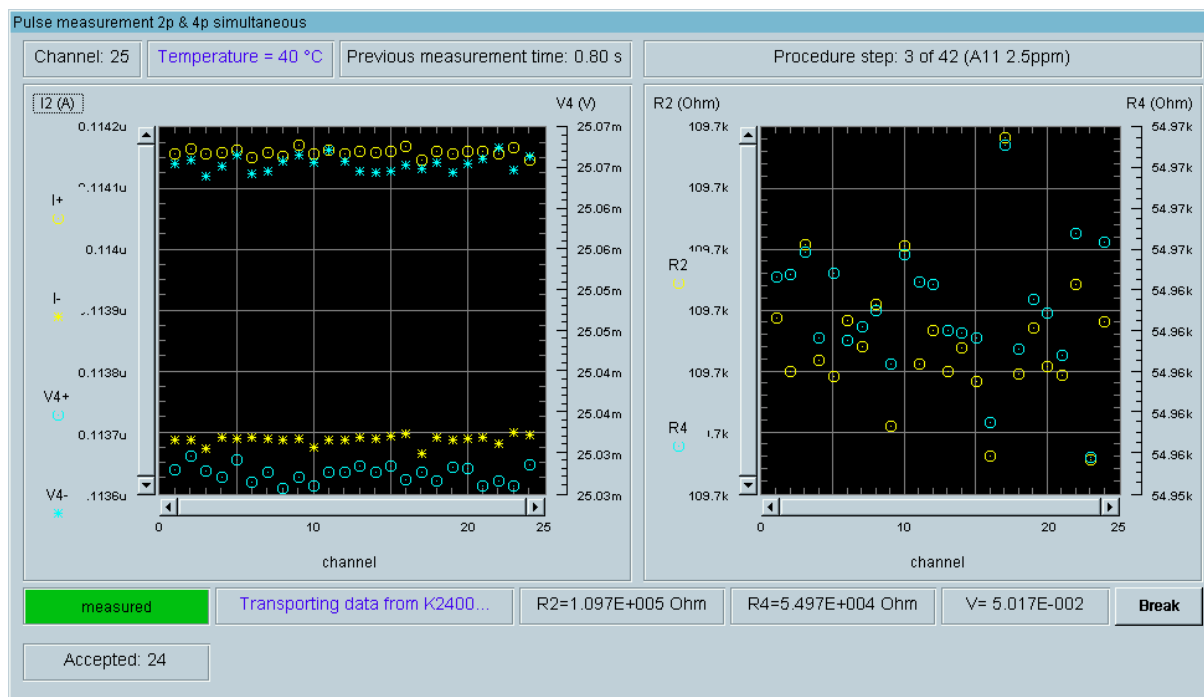

Fig. 73. Pulse measurement 2p & 4p simultaneous window of the ARYMS software

The initial version of the ARYMS software involved only separated two and four-point techniques, this was later improved to simultaneous technique. It was found that application of pulse technique could give the first information about the electrode functionality and also about linearity of its I-V characteristic. Note that ARYMS was an open source evaluation software similar to the CEP software, therefore only a short description was given in this chapter. For detailed operation of the software please refer to the source code and documentation files [182]. The software was written under Agilent VEE 6.01 and it involved two self-written library files (setup.vee and main.vee) [160]. The “setup” library included all procedures and functions of the electronic system and the “main” library covered the rest general functions. The libraries were used in open-source code, their compilation in the future could increase the ARYMS response time during its loading. The ARYMS could be easily updated and modified due to the visual object programming properties of the VEE platform.

The ARYMS software was designed only for operation with gaseous analyte, especially with gaseous HCl (required by the Kombisens project), but parallel with this software, ACMS (Automated Conductance Measurements) was written. The ACMS software was able of

measurement involving fluidic analytes. This software was used as a first adaptation of the developed EP setup for bio-sensor screening. It allowed to screen conductance kinetics (simultaneously by two- and four-point technique) of IDT electrodes, and saved the data into ASCII files. The software code and flow diagram can be found in [182].

The automated screening resulted in numerous data files that could be loaded together with the electropolymerization results into the analysis software and further evaluated in order to characterize the electrical properties of screened combinatorial libraries (outlined in the following chapter).

4 Analysis software

Previous versions of the measurement software (ARYMS) generated text files that could be easily imported into the Microcalc Origin, Microsoft Excel and others. Such data treatment was time consuming and therefore was used only in the beginning, when the search for optimal measurement procedure was performed. Note, that in order to get specified parameters for all 96 electrodes (sensors) and for example their statistic deviation to calculate, it usually took several days only for data proceeding. Therefore, after finalization of the final measurement procedure (chapter 3.1) the analysis software was developed and named Kombisens, Gas sensor analysis tool, shown in Fig. 74, left. This software essentially simplified data evaluation that was necessary for characterization of combinatorial libraries (synthesized sensors) within a reasonable time.

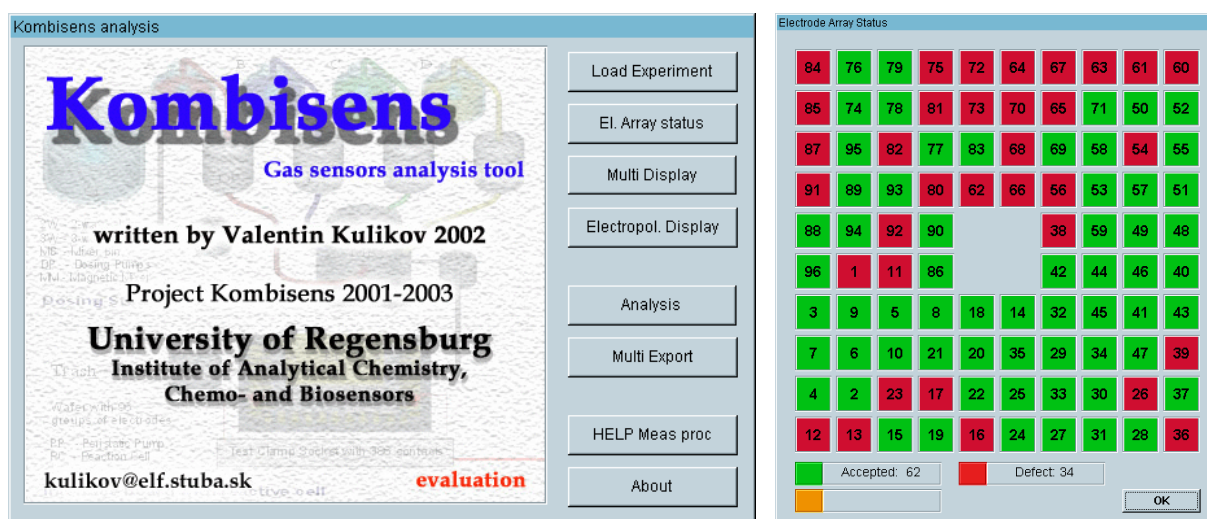

Fig. 74. Main window of the analysis software (left), EA status window (right)

The analysis software performed:

- import of the electropolymerization and measurement data and settings,
- supported a graphical presentation of a combinatorial library state (Fig. 74, right),
- displayed all required characteristics in single or in multi-window for electropolymerization (Fig. 76),
- calculated all specified parameters vs. various X variables in real-time (according to the designed measurement procedure) and
- displayed, exported selected single or multi characteristics into ASCII text file(s) for Origin (that could be further used for data presentations).

The hierarchy of the “Analysis” software can be seen in the Fig. 74 and in flow diagram in Fig. 75. Buttons on the right side of the main analysis window represent all options. Buttons in the main window (besides of "HELP" and "ABOUT") were deactivated until the data was loaded. After successful loading of an experimental data set (one library), the software directly performed fitting to the Langmuir and Henry (linear) model and actualized electrode array (EA) status. Immediately after that, it was possible to get the state of the electrode array in the “Electrode Array Status” window shown in Fig. 74, right. It gave an overview on the amount of working electrodes and their distribution around the EA. Other options, their brief description of the Analysis software follows.

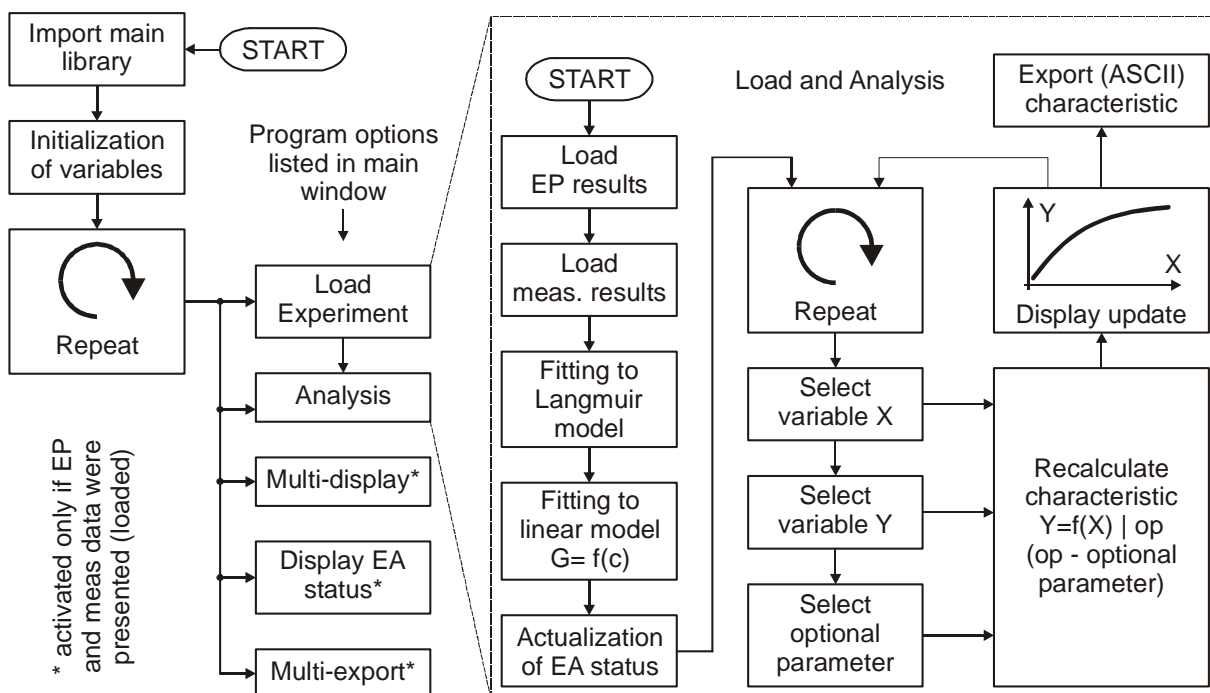

Fig. 75. Simplified flow diagram of the Analysis software

“Elektropol. Display” was designed to show EP kinetics of all accepted sensors, illustrated in the left chart (Fig. 76) and also individually for selected electrode, outlined in the right chart of Fig. 76 (corresponding characteristic was chosen by pull down menu below this chart). It was possible to display kinetics of current, charge, voltage (should be constant, small deviation), equilibrium current (equilibrium of the system before EP) and current after application of the final potential. It could be chosen in the list menu in the upper left corner of the EP display window (Fig. 76). If some of EP kinetics was not appropriate or out of range, it could be removed by the “Remove channel” button. Closing the EP display window led to a new info box (Fig. 81 Detail A), where changes could be accepted or ignored. If the change(s) was(were) accepted, the software wrote them into the “result.dat” file, situated in the library folder (Fig. 79, right, appendix 10.4) and used them for further data evaluation.

The “Refresh” button actualized the left chart (Fig. 76) for all kinetics. This could be used in the case of sensor(s), channel(s) removing in order to get an actual view. Refreshment was not automatic because it usually required longer time (dependent on number of measured points and number of accepted sensors). For illustration, it redisplayed around 200.000 points (taking in to account the situation in Fig. 76). The export option could be used for save of all accepted kinetics (for chosen Y variable, where X variable was EP time) into a single ASCII text file (file size around 600 kB).

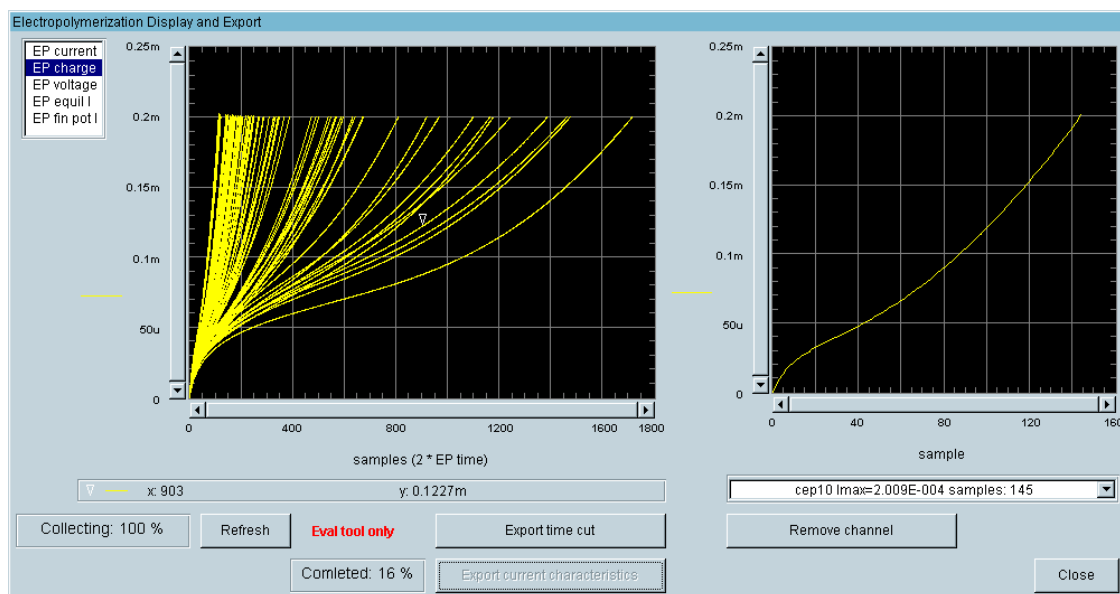

Fig. 76. Electropolymerization Display and Export window of the Analysis software (shown during export of all EP charge kinetics)

Each column in this file represented a single sensor and each line of any column was one measured point defined in time. However, not all channels were represented by the same amount of points, missing data were filled by TAB (\t) signs in order to create corresponding columns and unify the file structure into the form accepted by Origin. Additionally, the software was able to export a specific time cut, a dependence of a selected Y variable on channel number and polymerization order.

“Multidisplay”, visualized characteristics of most sensors in a single window, each next to another. The required characteristics could be chosen in the pull down menu in the lower right corner of the “Multidisplay” window (multi-display options). Because, the screen resolution was 1024x768 (pixels) all channel (sensor) characteristics were divided into four quadrants, so on one screen 24 sensor characteristics could be seen simultaneously. The sensor state (accepted-displayed yellow, not accepted- displayed red) could be adjusted by corresponding (acceptance) button below the corresponding chart (e.g. “7: Accepted”, where the name of the button depended on the state of the corresponding channel and 7 indicated the

channel number equivalent to the channel of MX96). The value displayed on the button next to the acceptance button, indicated the maximum value, found in the corresponding characteristic. By activation of this button, a properties box, shown in Fig. 77 was activated. Here, the EP conditions for corresponding channel, were summarized.

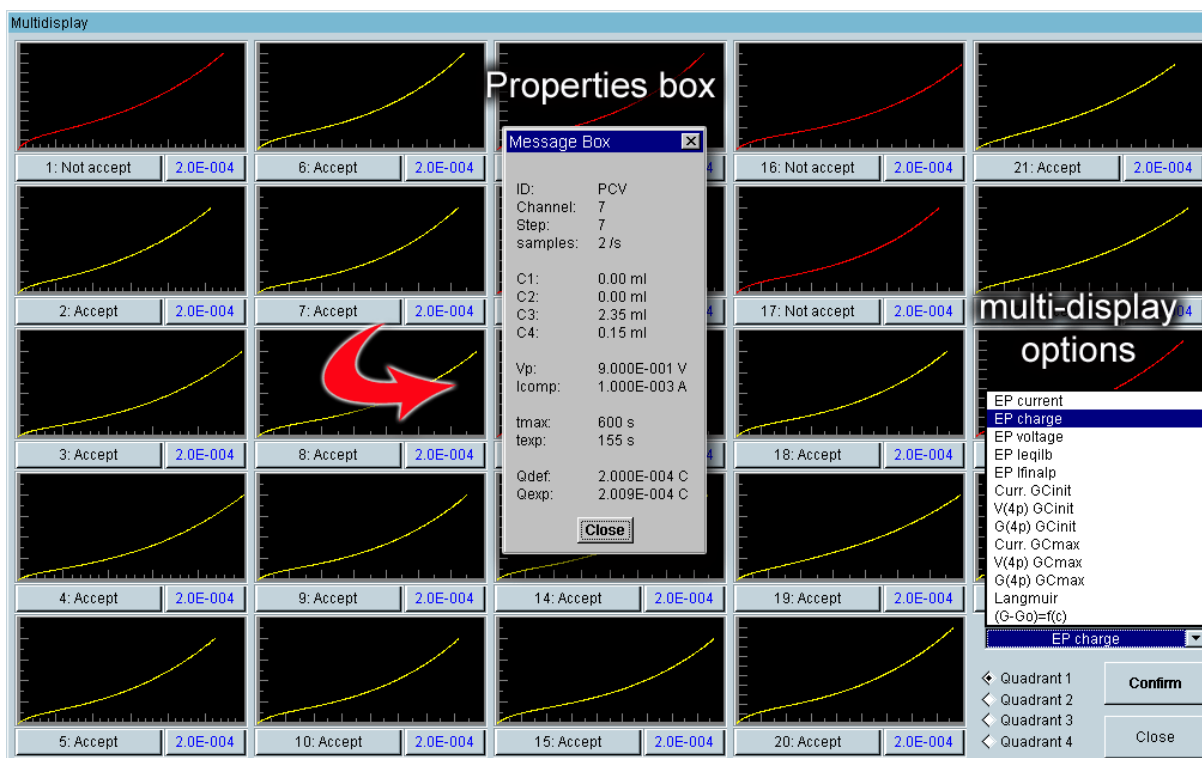

Fig. 77. Multi-display window of the Analysis software

“Analysis” window was the main part of the software. It calculated, displayed and exported required characteristics (dependencies on various variables) defined in the measurement protocol (chapter 3.1). So behind the analysis window in Fig. 78, a lot of programming work, based on procedures for calculation of numerous parameters for numerous electrodes (sensors) was hidden. If a new experiment (one library) was loaded, involved reagents should be assigned before own characterization (not necessary for reloaded experiments). It could be done by option “Chemical def.” in the “Assign of used substances” window shown in Fig. 79, left. In this window the reagents, previously defined in the “CEP” software and stored in the chemical database, could be easily allocated to corresponding reagent group (together 4 groups, chapter 2.2). It was further indicated in the upper right part of the analysis window (“Assignment of reagents” in Fig. 78) and used for calculation of individual volume and molar parts determined as the X variable (X - axis variable in Fig. 78).

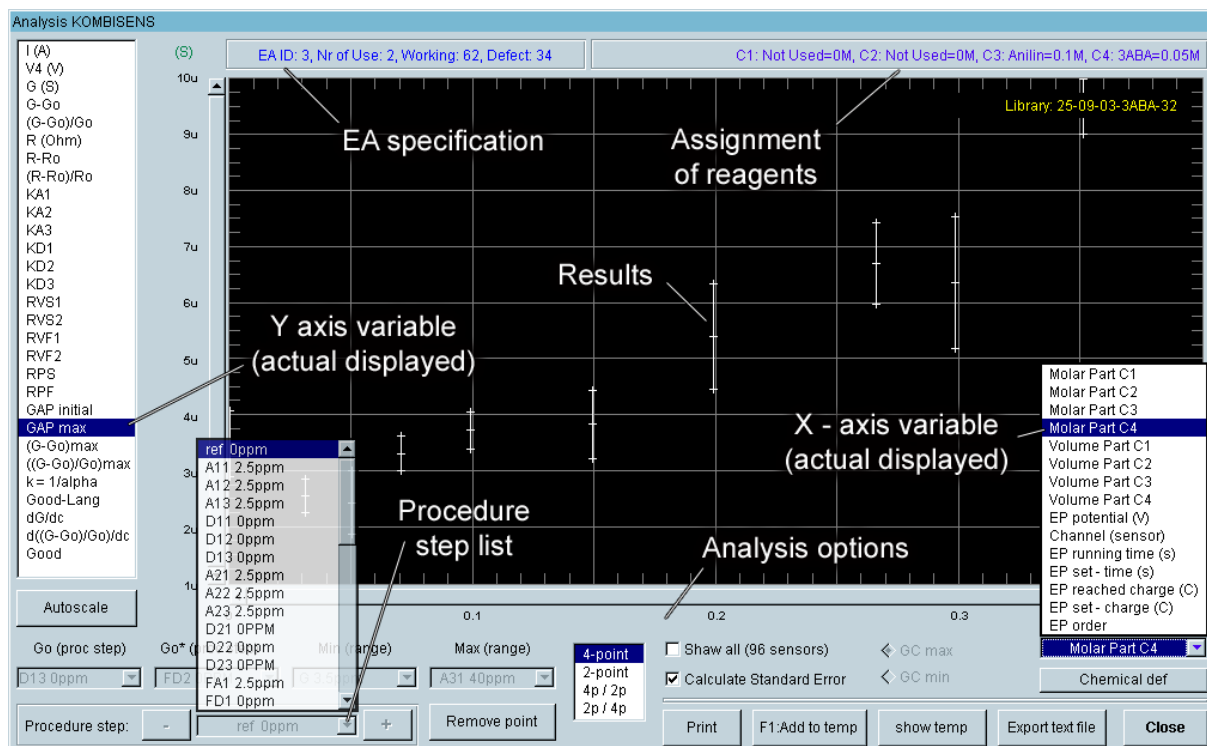

Fig. 78. Analysis window

The X variable could be chosen from the pull down menu in the bottom right corner of the analysis window (X – axis variable in Fig. 78). The molar part (for reagent A as an example) was calculated by

$$\text{Molar part (A)} = \frac{V(A) \cdot c(A)}{\sum_{i=A,B,C,D} V(i) \cdot c(i)}, \quad \text{Eq. 2}$$

where i corresponds to reagents A-D, $V(A, i)$ are volumes of reagents A-D, and $c(A, i)$ are their concentrations. The molar parts of reagents B-D were calculated similar with the same fragment denominator. The volume part (for reagent D as an example) was calculated by

$$\text{Volume part (D)} = \frac{V(D)}{\sum_{i=A,B,C,D} V(i)}. \quad \text{Eq. 3}$$

Note that the mentioned X variable was coming mostly from the electropolymerization results (settings) and the Y variable from the measurements. So the “Analysis” software interconnected them in order to calculate and display specified characteristics. The Y variable could be chosen from the list on the left hand side (Fig. 78). Most of these variables and parameters were already defined in the measurement protocol in Table. 5 (chapter 3.1). The GAP variable presented the linear regression of I-V characteristics, obtained by sweep measurement for two states without analyte GAP initial (in the beginning of the measurement

procedure) and for maximum analyte concentration (40 ppm, in the end of the measurement procedure) GAP max.

Two mathematical models, previously mentioned in the measurement protocol, were implemented in the software. The goal was to characterize sensor behaviors according to their response on gas (analyte) concentration. The Langmuir model, graphical outlined in Fig. 80, right and described by

$$Y = \frac{\alpha \cdot C}{C + C^{1/2}} \rightarrow \frac{1}{Y} = \frac{C^{1/2}}{\alpha} \cdot \frac{1}{C} + \frac{1}{\alpha}, \quad \text{Eq. 4}$$

where, Y is the signal level, α corresponds to the maximum signal level and C is the gas (analyte) concentration could be applied for sensors with exponential response to gas concentration. To fit these response-concentration characteristics to this model, other coordinates should be used. New coordinates, described by Eq. 4, right, allowed involvement of linear regression that led to the extraction of parameters $C^{1/2}$ and α ($k=C^{1/2}$ and $(G-Go)_{\max}$ in Fig. 78).

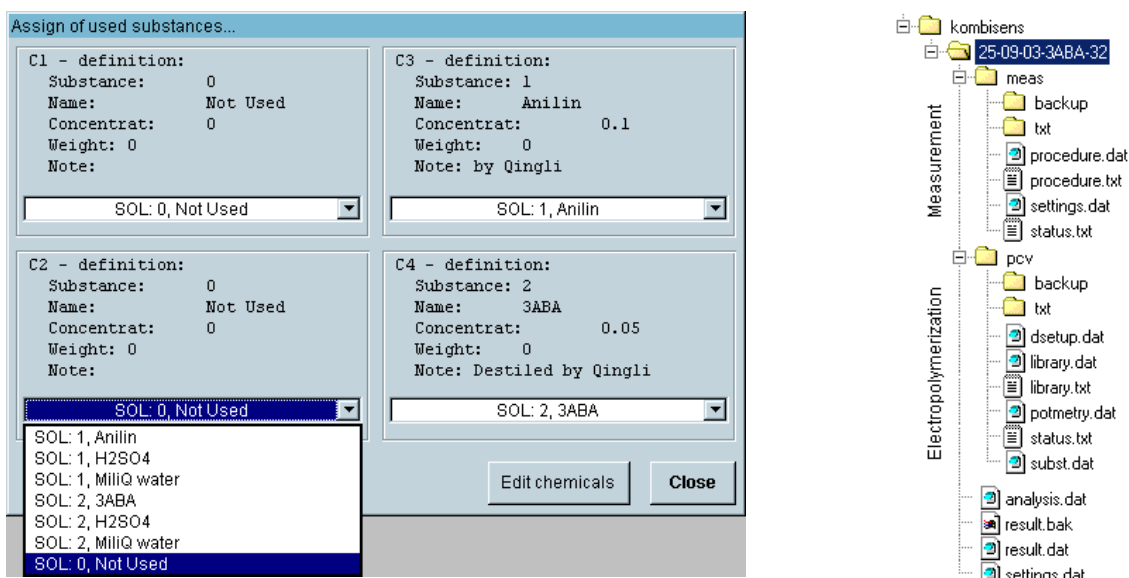

Fig. 79. Assignment of reagents window (left), Kombisens directory structure (right)

However, the low concentrations (below 40 ppm gaseous HCl) used in this work kept the sensor response mostly in the linear range, this model was not used. Therefore, the Henry (linear) model shown in Fig. 80, left was applied. Using this model an absolute sensitivity according to the IUPAC definition (the slope of the dependence of the absolute signal change on the analyte concentration, dG/dc in Fig. 78), the relative sensitivity (the slope of the same dependence but for relative signal values, $d((G-Go)/Go)/dc$) and the linearity (correlation coefficient, Good) were calculated. The R-squared or "goodness of fit" coefficient ranges

between -1 and 1. A fit of -1 or 1 is an exact fit and numbers in between -1 and 1 represent varying degrees of goodness of fit [124, 183].

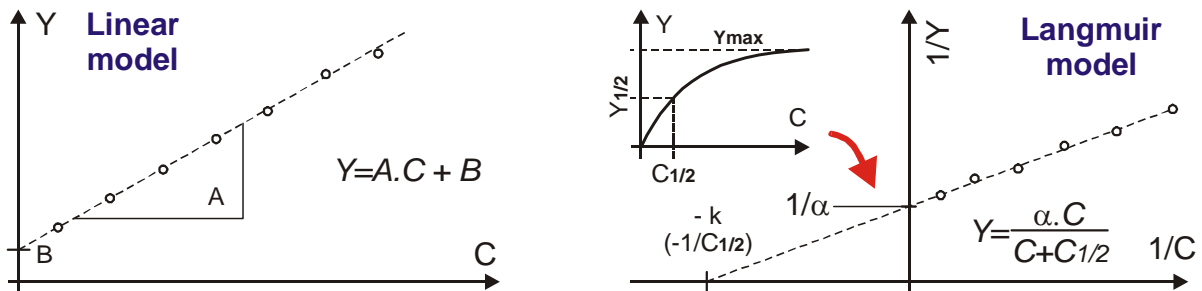

Fig. 80. Outline of the linear, Henry model (left) and Langmuir model (right)

If an experiment was completed of several groups consisting of identical sensors (sensors with the same chemical content and EP conditions), the analysis software allowed to calculate and display (export) mean (average) values and corresponded standard errors (statistical scattering). This option could be activated by “Calculate Standard Error” button for “Volume, Molar ratios”, “EP potential” and X variables containing “set” string in its name (e.g. “EP set-time(s)”, shown in Fig. 78). Note, that specific options in the analysis window which were not allowed for some variables were just hidden. The standard error was calculated using implemented VEE [183] functions by

$$serror = sdev(x) / \sqrt{numPts} , \quad \text{Eq. 5}$$

where numPts is the amount of elements in the group (identical sensors) and sdev(x) is the standard deviation, defined as the square root of the vari(x). The variance of the data, vari(x) is defined as

$$vari(x) = \sum_{numPts}^{i=1} (Xi + Xmean)^2 / (numPts - 1), \quad \text{Eq. 6}$$

where Xi is the individual data point, Xmean was the mean of all data points [124, 183]. The software displayed this statistical scattering as the mean \pm standard error value, shown in Fig. 78.

“Channel removing tool window” simplified modification of the channel status, when it was necessary to remove (not accept) some sensors(s) (channel(s)) with a value wide from an average range of a corresponding group. It could be done easily by pressing the “Remove” button (Fig. 78) in the analysis window, this opened the “Channel removing tool” window. The unacceptable channel (sensor) should be marked by the triangle cursor (Fig. 81). If the “Remove point” button was pressed the marked channel was removed (assigned as not accepted). If this option was not correct the tool allowed the retrieval of one previously removed channel. After leaving this window the software asked for changes (if they were

done), shown in Detail A in Fig. 81. Only after accepting the state of the experiment (EA) it was written into the “result.dat” file and kept for further analysis of the corresponding library. Note “result.dat” file was generated consequently by CEP and ARYMS software, so broken and not functional electrodes were filtered (stored in file directory shown in Fig. 79, right). On the other hand, the state of the EA array could be modified in the Multi-display window, therefore if the user disabled some channels they could be retrieved in the future.

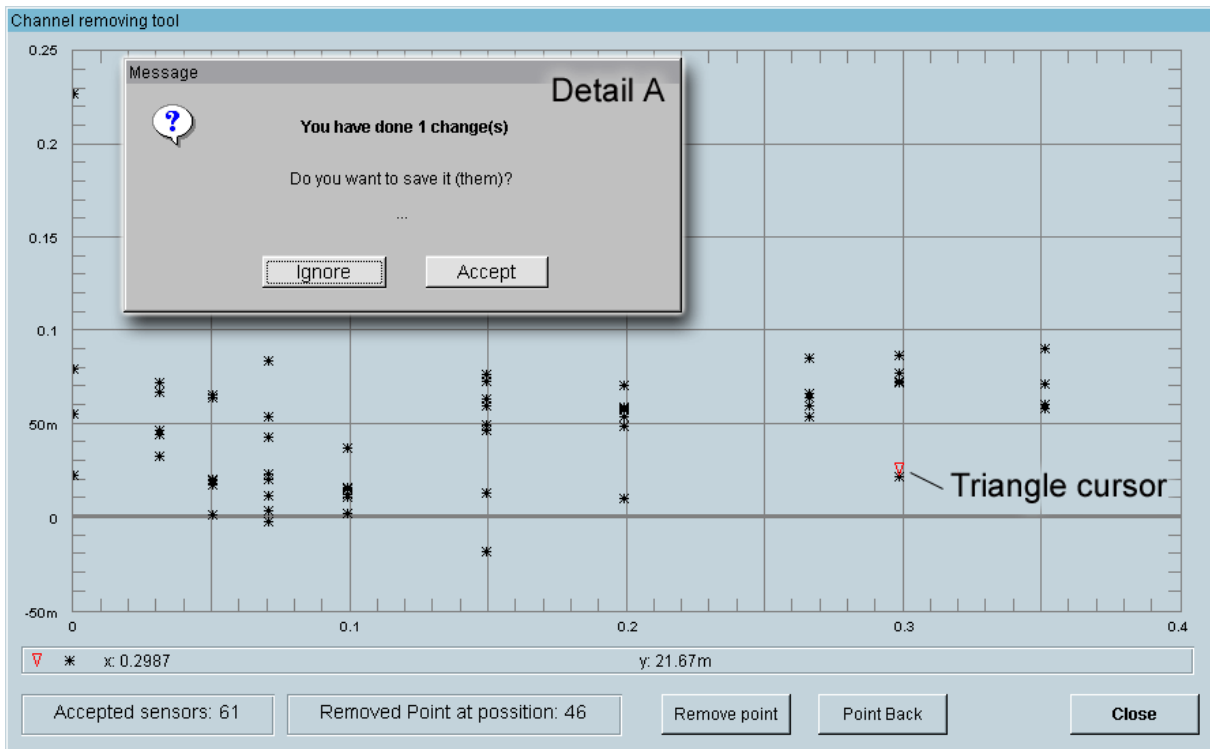

Fig. 81. Channel removing tool window

5 Application for development of HCl gas sensors

Hydrogen chloride (HCl) is one of the byproducts released during burning of electrical cable insulation (made of PVC). Fire alarms based on sensitive reversible and reproducible sensors can help to detect a fire in its beginning stages, and so prevent huge fire disasters. Promising materials suitable for such sensors are organic (conductive) polymers. Effort of the investigation, described in this chapter, was focused on the application of the combinatorial approach for the electrochemical synthesis of polymerizable materials for the detection of gaseous HCl [66]. To our knowledge, this was the first application high-throughput screening in electrochemistry.

A variation of physical parameters, especially of the layer thickness (described in the chapter below), determined an optimal thickness of the polyaniline (PANI) layer for further combinatorial experiments. It was found that the optimal EP charge, should be kept at about 0.2 mC, this corresponded to the layer thickness of about 1 μm . Generally, there were two limiting factors corresponding to the thickness of the polymer layer; i) the charge should be large enough to cover the gaps between strips of the interdigital (IDT) electrode by polymer, but ii) not too large to observe contact damage (described in chapter 5.3), which led to a significant decrease of the sensor response time. Therefore all further experiments based on aniline were limited by charge to value of about 0.2 mC in order to obtain appropriate structures with the nearly similar thickness of the polymer layer [75]. In this experiment, the pure aniline (in 0.5 M H_2SO_4) with concentration of 0.1 M was used.

A variation of chemical parameters has been performed on co-polymerization of aniline with its non-conductive deviates and the corresponding results are presented in chapter 5.5 as an illustration of one of many possible utilizations of the designed electropolymerization concept. In this investigation, the ratio of monomers at constant polymerization charge was varied. Each variation was repeated on the same electrode array about 10 times (to get statistical scattering). After electropolymerization, the synthesized polymers were treated 1 hour by incubation in 100 mM Na_2CO_3 buffer pH 9.0 and then measured according to the measurement protocol (described in chapter 3.1). The aniline (in 0.5 M H_2SO_4) with a concentration of 0.1 M was mixed with its non-conductive derivates, described in subchapter 5.5.

5.1 Experimental details, chemicals and preparation

All combinatorial experiments were performed at constant potential of 900 mV vs. built-in Ag/AgCl sat. salt bridge reference electrode at 40°C (thermo-stabilized).

Aniline was distilled under reduced pressure and stored in a refrigerator at about 4°C, other chemicals were used as received. Sulfuric acid was from Aldrich, gaseous hydrogen chloride from Linde, other chemicals from Merck. Water was purified with Millipore “Mili-Q” equipment. All experiments were performed at 40°C; the temperature was stabilized within 0.1°C by home-made electronic thermostat (chapters 2.5.1 and 3.3.1). Electrode arrays (chapter 2.1.5) were prepared by standard photolithography on oxidized silicon wafers, the metal electrodes were from Pt (500 nm). Four single electrode strips (10, 5, 5, and 10 μm wide) were placed with a gap of 5 μm between each pair of strips; the strips were folded into square-formed interdigital-like structure [14] with the size of each electrode group being 400 x 500 μm. The electrode array was coated with 1 μm silicone oxide layer with open windows corresponding to the square formed by interdigital-like structures. Before performing experiments, the electrode arrays were cleaned with chloroform in an ultrasonic bath for 3 minutes, dried and treated by hot piranha solution (1:3 v:v mixture of H₂O₂ (30%) and conc. H₂SO₄) for 3 minutes. *Caution: this solution reacts violently with most organic materials and must be handled with extreme care.* Then the arrays were rinsed thoroughly with water (ultrasonic bath, 5 minutes) and dried under nitrogen flow.

Immobilization of glucose oxidase (Sigma) was performed by the addition of dried EDC (Aldrich) with the concentration of 50 mg / mL into the solution of 140 mM NaCl with 2 mg / mL of glucose oxidase and subsequent incubated for 1 hr. at room temperature.

5.2 Validation of the electropolymerization concept

The experiment, involving 0.1 M aniline (in 0.5 M H₂SO₄), was performed to find influence of the fixed physical parameters (distance of work electrodes from reference electrode, polymerization order, channel) to electropolymerization. Results are shown in Fig. 82 and indicates that there were no systematic dependencies of electropolymerization current (Fig. 82, A-D) and charge (Fig. 82, A1-D1) on electropolymerization channel (Fig. 82, B and B1), electropolymerization order (Fig. 82, C and C1). In addition, there was not systematic influence on the distance of a work electrode from the central reference electrode (Fig. 82, D and D1, chapter 2.1.3). The parameter scattering in Fig. 82 could be caused mainly by different active areas of the working electrodes, because of defects in the insulating SiO₂ layer of the electrode array, pressure changes (experiment took 12 hours 30 minutes), and others. Note that numPts in Fig. 82 is number of data points (sensors) in cut (250 seconds), SD is standard deviation and SE is standard error.

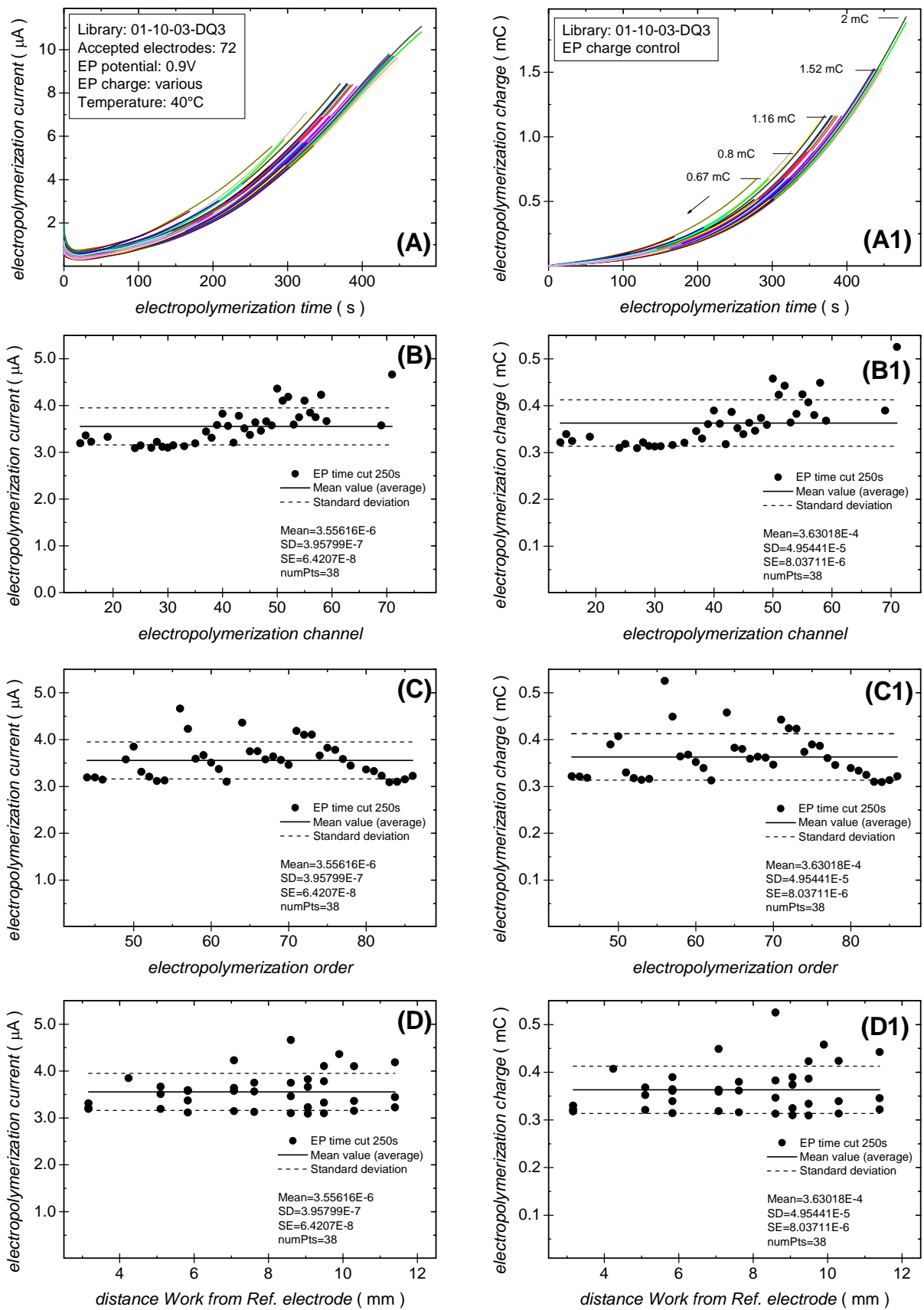

Fig. 82. Electropolymerization of aniline

5.3 Analysis of bulk and contact conductance of polymer layers

Electrical investigation of electrochemically synthesized polymer libraries was performed by simultaneous application of 2- and 4-point techniques (G_2 and G_4 conductance, respectively). While the 2-point technique provided the sum value of bulk resistance and two contact resistances, the 4-point technique measured the bulk resistance between two inner electrodes only (chapter 3). Taking in to account the electrode geometry, one could expect about a 3-5 fold difference in the bulk resistance contributing into the 2-point resistance ($R_2=1/G_2$) measurements and being measured by the 4-point technique ($R_4=1/G_4$). The ratio of R_2/R_4 (or $G_4/G_2 = R_2/R_4$) higher than 4 indicated on the contribution of contact resistance. This analysis of electrical properties of electrode groups coated by different polymers was performed step by step for all electrode groups in the array; the total measurement time was within 120 s for 96 electrode groups. Then the results were analyzed and presented as a function of varying parameters (polymerization charge, molar ration of monomers, etc.).

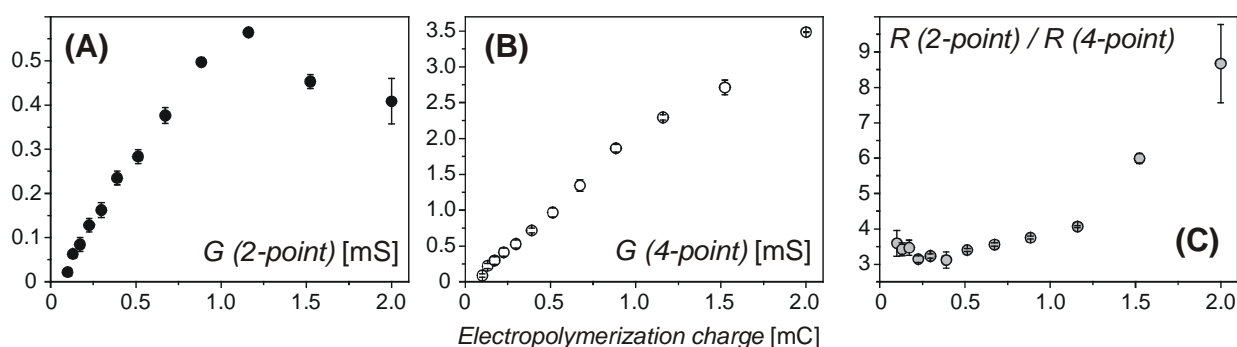

Fig. 83. Effect of the electropolymerization charge on the conductance of polyaniline measured by 2- and 4-point techniques ($G_{2\text{-point}}$ and $G_{4\text{-point}}$ correspondingly) and on the ratio of resistances measured by 2- and 4-point techniques ($R_{2\text{-point}}/R_{4\text{-point}}$). Polyaniline was synthesized electrochemically, on the array consisting of 96 spots (electrode groups) by means of the device for combinatorial electropolymerization. All measurements were performed in a nitrogen atmosphere

The dependencies of conductance between the electrodes, as measured by the G_2 and G_4 on polymerization charges of electrochemically synthesized polyaniline, are presented in Fig. 83. At low polymerization charge (up to 1.2 mC) the conductance values for both techniques display very similar behavior. At polymerization charges less than 0.1 mC, the conductance is zero, indicating that there is no overlap of polymer layers synthesized on the neighboring strips of electrode groups. The overlap at 0.1 mC led to a step increase in the conductance. Further increase of the polymerization charge resulted in a linear increase of the conductance; this obviously meant linear increase of the layer thickness. This linear dependence was observed up to the polymerization charge of 1.2 mC. At higher charge values,

the dependence of the conductance measured by the G4 remains linear with a slightly different slope (Fig. 83, B) while the dependence measured by the G2 is changed dramatically (Fig. 83, B). This strong difference in the behavior of conductance values measured by 2- and 4-point techniques indicated the decrease of contact / polymer conductance: the loss of the polymer adhesion to metal led to the blocking of G2 increase (even G2 decreased, shown in Fig. 83, A). The small break of linear dependence for G4 might be caused by changes of the polymer structure after release of its adhesion.

The modification of the contact resistance during electropolymerization was confirmed by the dependence of the ratio of G4/G2 (which is equal to the ratio of resistances R2/R4) on the polymerization charge (Fig. 83, C). This ratio was about 3 - 4 for the charge variation between 0.1 and 1.2 mC. It corresponded to the ratio estimated from geometrical consideration of polymer length between inner and outer electrodes of the interdigital structure, if the resistance of electrode / polymer interface was much less than that of the polymer. Further increase of the polymerization charge led to an increase of this ratio up to 10, thus indicating the contribution of total resistance of two such interfaces. The same analysis was applied for investigation of conductance of bulk polymer and electrode / polymer interface for the series of polyaniline based copolymers prepared by combinatorial electropolymerization. The polymerization charge was fixed at the value of 0.2 mC thus providing overlap without affecting of polymer / metal contacts. The results are presented in Fig. 84. An increase in the molar fraction of 3-aminobenzoic acid in the electro-copolymerization of aniline and 3-aminobenzoic acid (3ABA) led to some increase in the bulk polymer conductance (Fig. 84, A). The ratio G4/G2 remained at 3.1 ± 0.1 . This demonstrated that the resistance of the metal/polymer interface remains so small that this ratio is not affected by the increased incorporation of 3ABA into the polymer.

Quite different behavior of G4 and G2 was observed for increased incorporation of 4-aminobenzoic acid (4ABA) into polyaniline (Fig. 84, B): both G4 and G2 decreased strongly, thus demonstrating a decrease in bulk polymer conductance due to addition of a poorly conductive additive. The ratio G4/G2 remained in the range between 3.5 and 5, therefore one could not detect any effect of the resistance of the polymer / metal interface. The incorporation of low conductive anthranilic acid (AA) decreased the bulk polymer conductance too, but it also increased the resistance of polymer / metal interfaces (Fig. 84, C).

The polymers prepared by copolymerization of aniline and 3-aminobenzenesulfonic acid (3ABSA) displayed non-monotonous dependence of G2, G4 and G4/G2 on 3ABSA concentration (Fig. 84, D). At low concentrations, 3ABSA led to an increase of G2, G4 and G2/G4, therefore the bulk conductance increased and the conductance of the metal / polymer interface decreased. At higher concentrations, 3ABSA led to decrease of the bulk conductance, accompanied by an increase of conductance of metal / polymer interfaces.

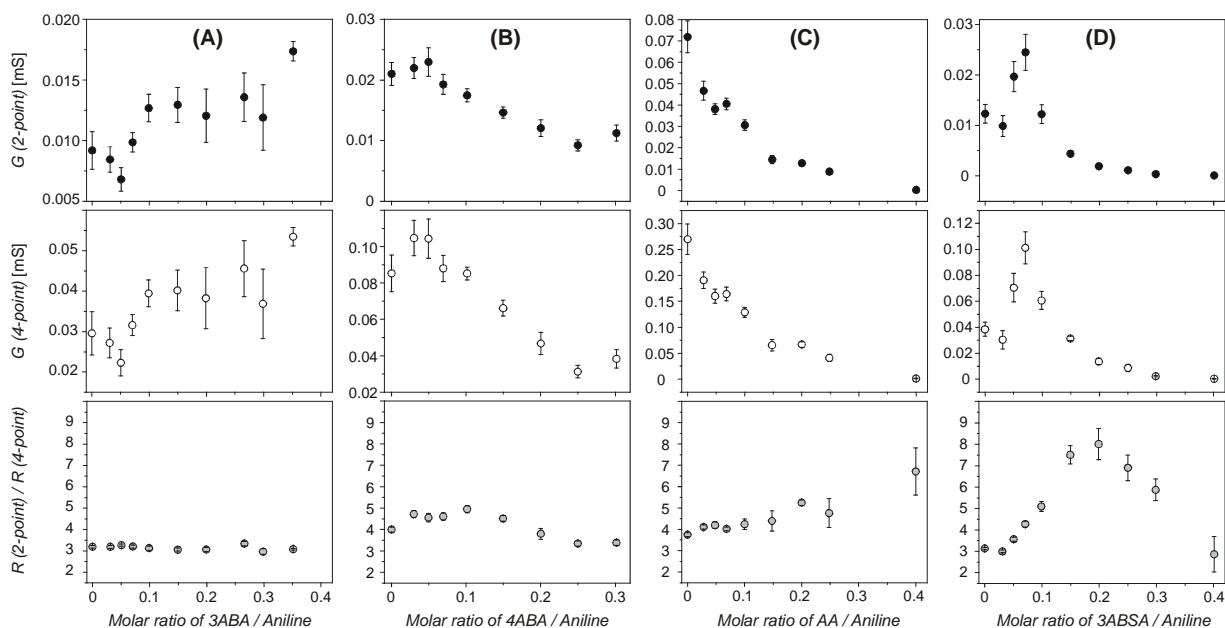

Fig. 84. Simultaneous high-throughput investigation of electrical conductance of platinum / polymer interface and of bulk polymers by 2- and 4-point techniques. Polymer: copolymer of aniline with 3-aminobenzoic acid (A), 4-aminobenzoic acid (B), anthranilic acid (C), and 3-aminobenzenesulfonic acid (D). The results present conductance values obtained by 2-point technique (upper), 4-point techniques (middle) and the ratio of resistance measured by 2- and 4-point techniques (down). The measurements were performed in nitrogen atmosphere

The high-throughput monitoring of the conductance of polymer/metal interfaces was also used to detect damage of these contacts due to subsequent modifications of the polymer layer. These modifications could involve covalent immobilization of enzymes, one of the most important procedures for the preparation of biosensors. The covalent immobilization was often performed by the reaction involving 1-ethyl-3-(3-dimethylaminopropyl)carbodiimide (EDC) [15-16]. An application of our approach to this system demonstrated that such immobilization on the polymer layer, made from copolymer aniline and anthranilic acid, led to dramatic modification of the bulk conductance as well as of the conductance of the polymer / metal interface (Fig. 85, compared with Fig. 84, C). Surprisingly, an increase of concentration of non-conductive anthranilic acid in the polymer led to the increase of the polymer conductance; the reason could be an electrostatically induced shift of local pH near the polymer chain to more acidic value leading to strong increase in the polyaniline conductivity. The ratio R_{2}/R_{4} became about 100 which clearly indicated a dominant contribution of the metal / polymer contacts to the resistance measured by the 2-point technique.

Combinatorial approaches possess two important features: extremely fast data acquisition and a high probability of obtaining not only expected, but also unexpected results, having, in general, the higher scientific value than the expected ones. The present data demonstrate both advantages. The combination of simultaneous 2- and 4-point techniques with high-throughput measurement techniques was recognized to be a powerful tool for analysis of

polymer properties. The observation of a strong influence of polymer content and modification on the contact properties, especially non-monotonous behavior, was unexpected.

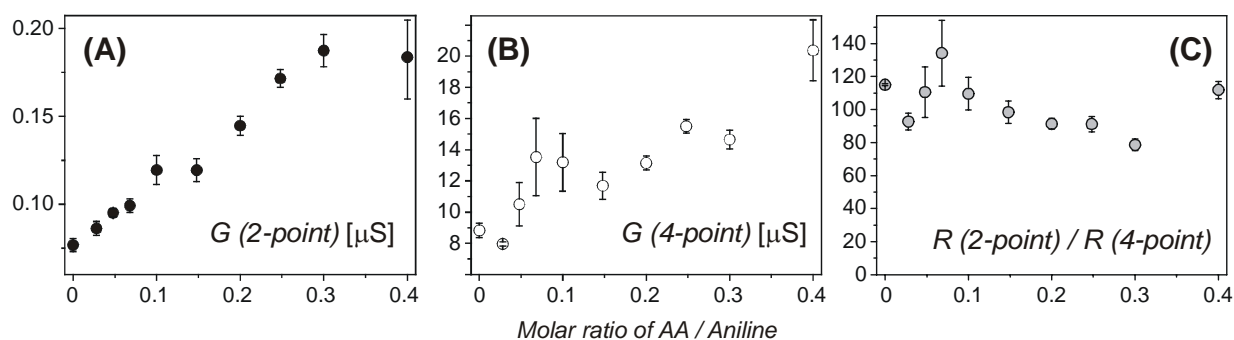
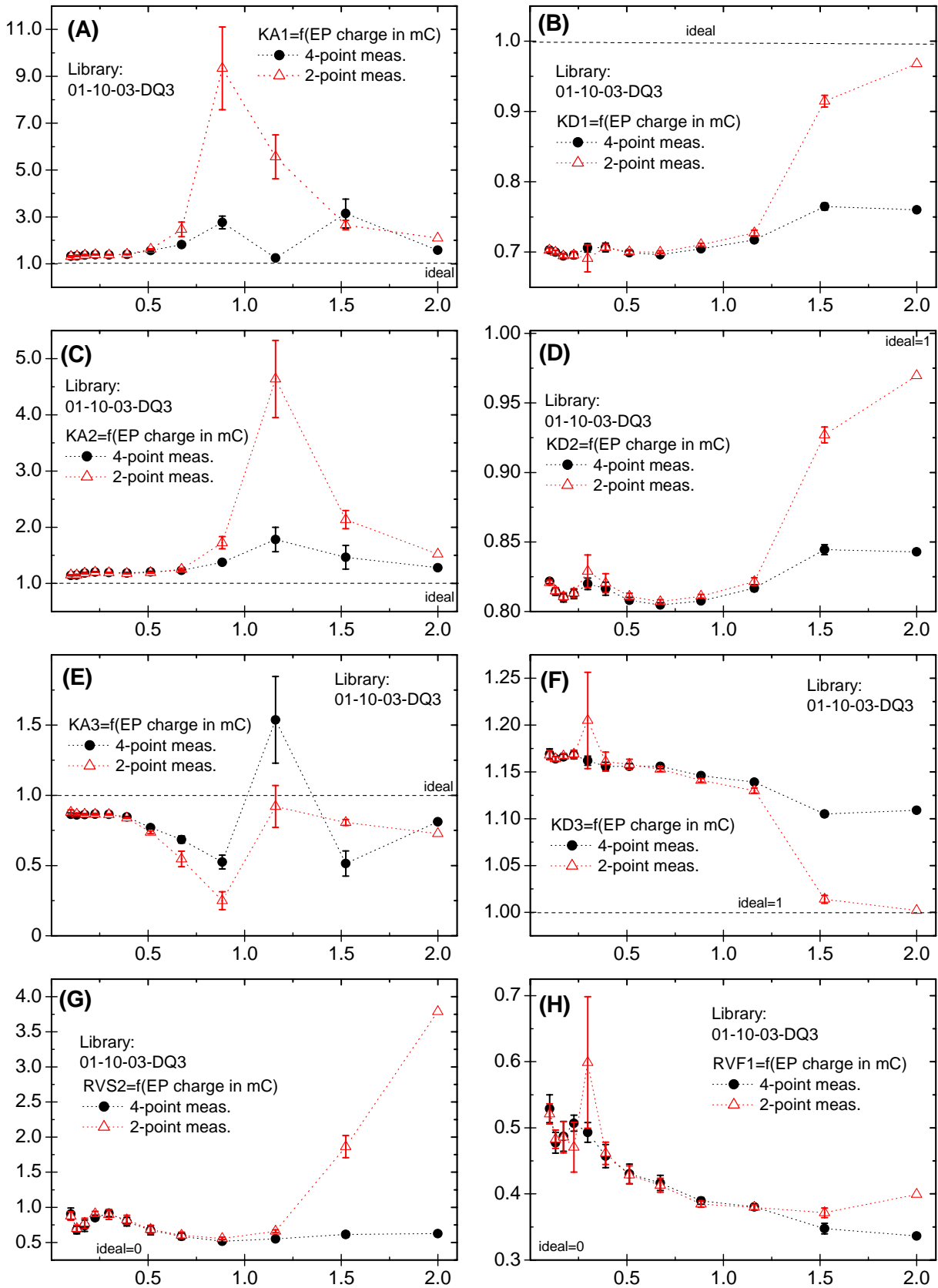

Fig. 85. Simultaneous high-throughput investigation of electrical conductance of platinum / polymer interface and of bulk polymers by 2- and 4-point techniques after treatment with EDC. Polymer: copolymer of aniline with anthranilic acid. The results present conductance values obtained by 2-point technique (left), 4-point techniques (middle) and the ratio of resistance measured by 2- and 4-point techniques (right). The measurements were performed in the aqueous electrolyte of 140 mM NaCl and 25 mM phosphate at pH 7

These results are important for further combinatorial optimization of polymer materials for conductometric gas sensors and biosensors: the approach allowed us to detect artifacts because of influence on polymer / metal contacts. However, the same approach can be used for investigation of current-voltage characteristics. Therefore, it can also be applied for analysis of polymer / metal junctions having a dominant place in organic Schottky diodes, chemo-diodes and other devices.

5.4 Influence of EP charge on analytical properties of polymer layer

Others parameters, not shown in previous sub-chapter are outlined in Fig. 86. They demonstrates an influence of the electropolymerization charge (corresponded to the thickness of polymer layer) to selected parameters according the measurement protocol, described in chapter 3.1. The adsorption coefficients KA1, KA2 and their ratio KA3 were increased (Fig. 86, A, C, E) with an increase of EP charge. However, the adsorption coefficients changed for the worse, the desorption coefficients KD1, KD2 and their ratio KD3 (Fig. 86, B, D, F) were improved, this occurred due to the fact that as small amount of HCl molecules was adsorbed as small amount should be than desorbed. Similarly, the EP charge negatively affected the reversibility and reproducibility of aniline based sensors (Fig. 86, G-J). The conductance of sensors (Fig. 86, K) was increased with EP charge, this affected (for the worse) the ratio of the conductance measured by four- and two-point technique (Fig. 86, L). The absolute (Fig. 86, O) and relative (Fig. 86, M, N) sensitivity were increased with an increase EP charge (till the sensors were damaged, found for electropolymerization charge higher than about 0.9 mC).



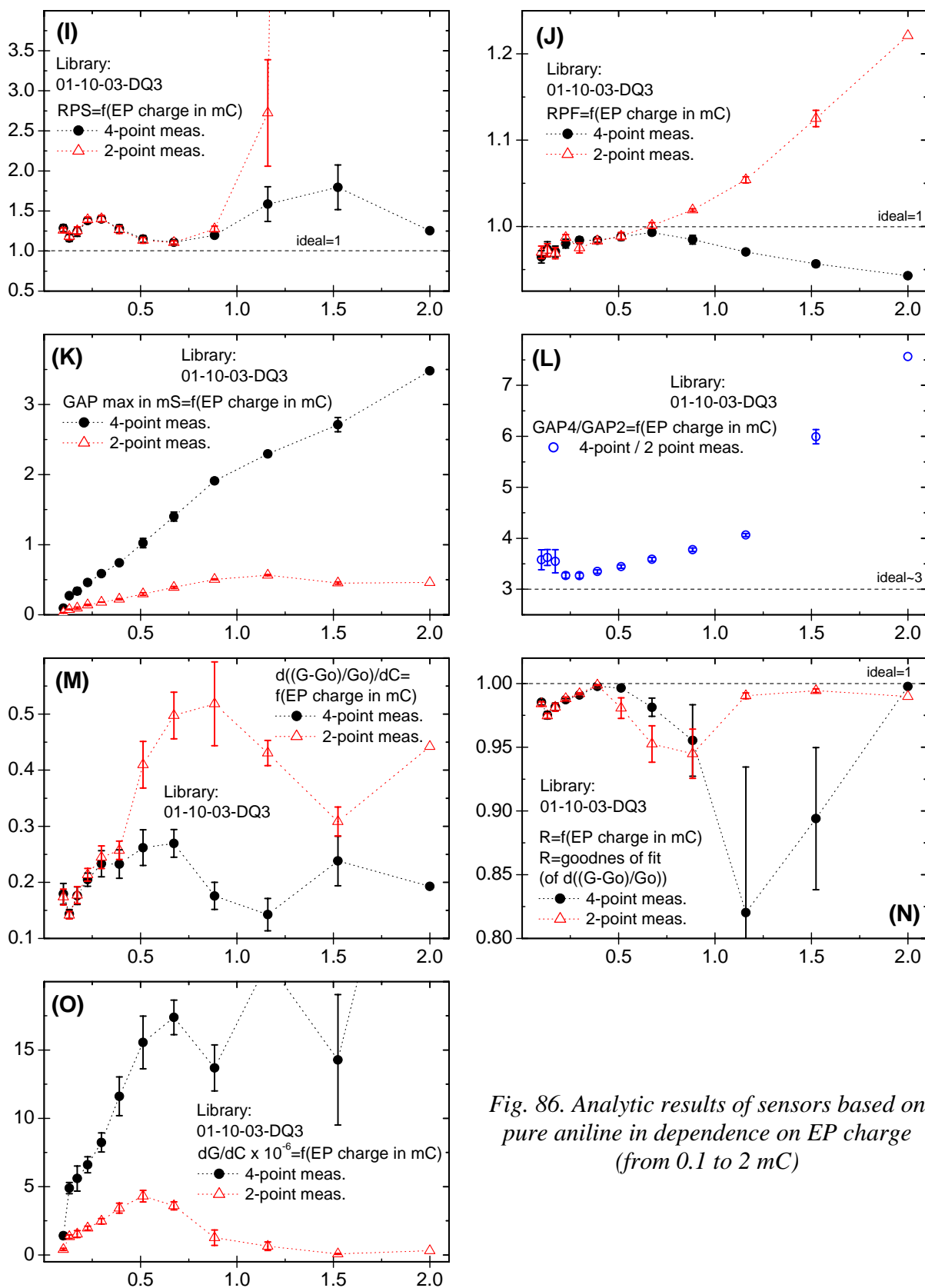

Fig. 86. Analytic results of sensors based on pure aniline in dependence on EP charge (from 0.1 to 2 mC)

5.5 Influence of chemical content on analytical properties of polymer layer

The investigation presented in this sub-chapter has been performed with monomers listed below (mixed with 0.1 M aniline (in 0.5 M H₂SO₄), P(ANI+X)):

- 4-aminobenzoic acid (4ABA), (0.067 M, 0.5 M H₂SO₄)
- 2-aminobenzoic acid (AA), (0.1 M, 0.25 M H₂SO₄)
- 3-aminobenzoic acid (3ABA), (0.05 M, 0.25 M H₂SO₄)
- 3-aminobenzenesulfonic acid (3ABSA), (0.05 M, 0.25 M H₂SO₄)

The detailed results of this investigation are presented in appendix 10.5. These results were procured from the combinatorial data of EPs and screenings involving the analysis software described in chapter 4. The most interesting parameters were exported from the analysis software and inter-compared to find the best behaved sensor material. The summary results were calculated from the mean value of those parameters for four copolymers with molar ratios corresponding to the best value of the studied parameter.

The comparison of mentioned parameters, measured simultaneously by four- and two-point technique, is shown in Fig. 87. In these plots, the values above the columns indicate an optimal molar part of the aniline derivate C2, in the polymerization mixture with pure aniline C1. These results can be summarized as follows:

- The incorporation of aniline derivates into the target reagent for EP, increased the relative sensitivity (Fig. 87, A) of the polymer layer. It meant that addition of a non-conductive derivate could improve sensitivity of the gas sensors several times compared to the pure aniline. These results were confirmed by the relative response linearity (Fig. 87, B), where the R-coefficient (correlation coefficient) was higher than 95% for corresponding sensors, this fitted well with to Henry (linear) model. The absolute sensitivity (Fig. 87, G) was decreased with additions of non-conductive compounds.
- However, the P(ANI+AA) indicated the higher sensitivity its response was poor compared to others (Fig. 87, A). The best response reached sensors based on co-polymer P(ANI+4ABA) (Fig. 87, C, the ideal value was one).
- The best desorption coefficient was achieved with sensors based on pure aniline (Fig. 87, D, the ideal value was one). The other co-polymers achieved the best desorption coefficient only for higher molar ratios.
- The best reversibility was reached with sensors based on co-polymer P(ANI+4ABA). They reached RVS2 value lower than 0,2 (Fig. 87, E), this was close to the ideal one (zero).

- Similarly, the sensors based on P(ANI+4ABA) indicated nearly the best reproducibility (Fig. 87, F) characterized by value of RPS lower than 1.5 (ideal value one).
- The best adhesion of the polymer layer to the electrode surface (strips) was observed for the sensors based on P(ANI+3ABSA) and P(ANI+3ABA), shown in Fig. 87, H. In this case the ideal value should be about 3, however, its exact value depends on precision of the EA topology (IDT) which was different for an individual electrode arrays.

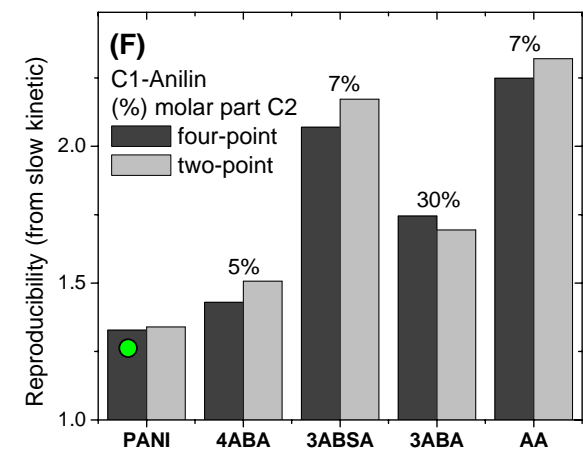
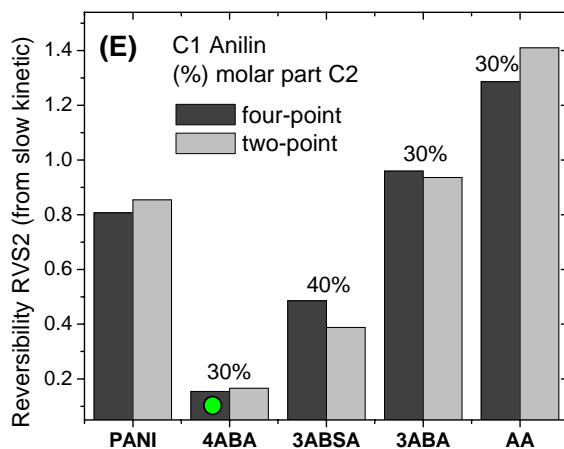
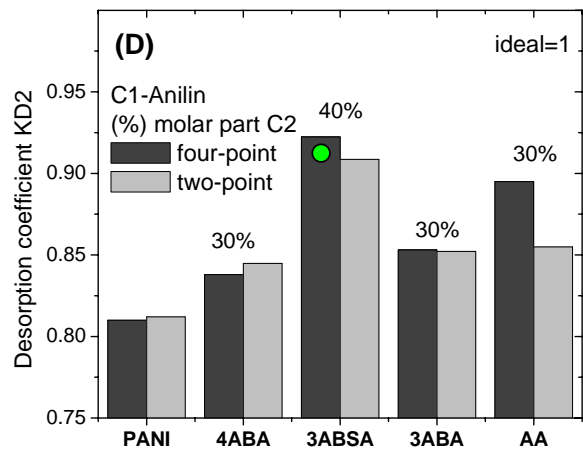
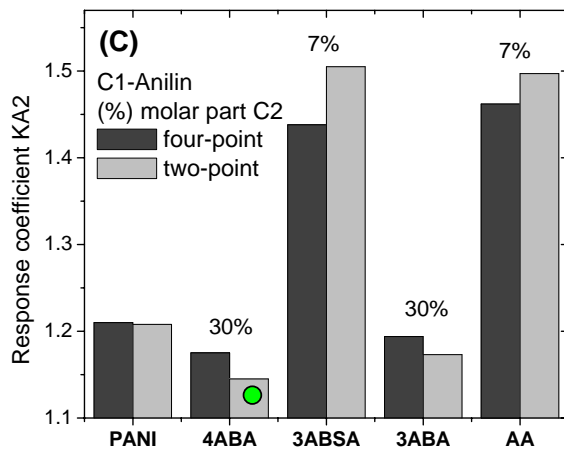
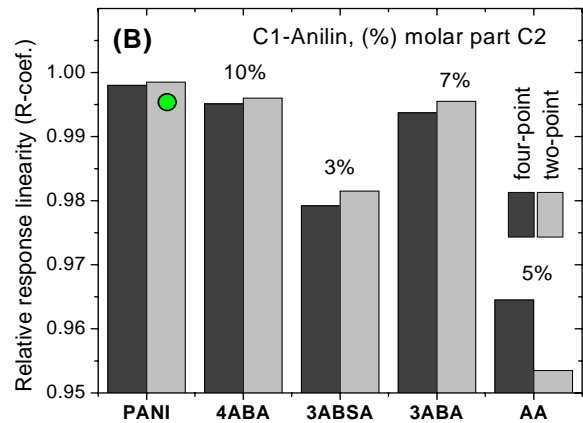
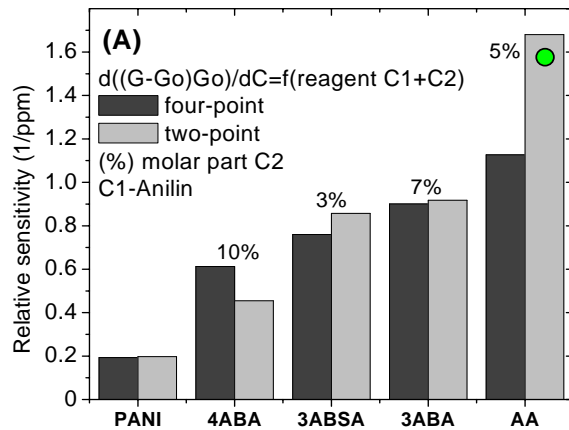

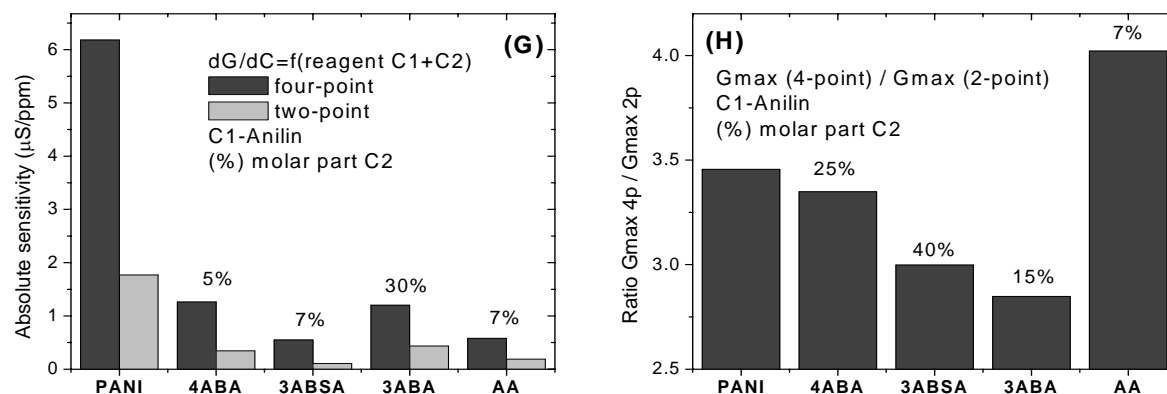

Fig. 87. Comparison of the best results

Taking into account these results, the most sensitive material, presented here, was the copolymer deposited from a mixture of aniline and AA with molar part of 5%, but this material showed the worst response, reversibility and reproducibility. The material with the best reversibility, reproducibility, fast response and low desorption coefficient was the mixture of aniline with 4ABA with the molar ratio of 30%, but the sensitivity of this material was only 0.085 ppm^{-1} (not presented here, can be found in [184]). Therefore, the material selection depends on the requirements, if a highly sensitive sensor is required and the reversibility, reproducibility, response and desorption properties are second of interest then the most appropriate material is P(ANI+30%AA). To achieve all necessary parameters, the compromise material is p(ANI+30%3ABA); however it indicated the relative sensitivity about 0.2 [184], (compared with pure aniline), it offered other appropriate characteristics and can be considered as the promising material in sensors for gaseous HCl.

5.6 Comparison of PANI based sensor with commercial fire sensors

The optimized sensors were tested according to DIN (Deutsche Industrie Norm for cable burning) by Robert BOSCH (Germany) in 2003. The polymer sensors resulted in excellent sensitivity, reversibility and reproducibility compared to two other commercial sensors for detection of gaseous hydrogen chloride. The results of comparison (received from BOSCH) of designed PANI sensor (regeneration with N₂ and with involving thermo-desorption principle) with two other commercial sensors (available in Germany 2003) are shown in Fig. 88. Note the axis and names are not corresponding, because the data are internal properties of Robert BOSCH GmbH. As illustrated, the conductive polymers are promising materials for commercializing in fire sensors and many other applications.

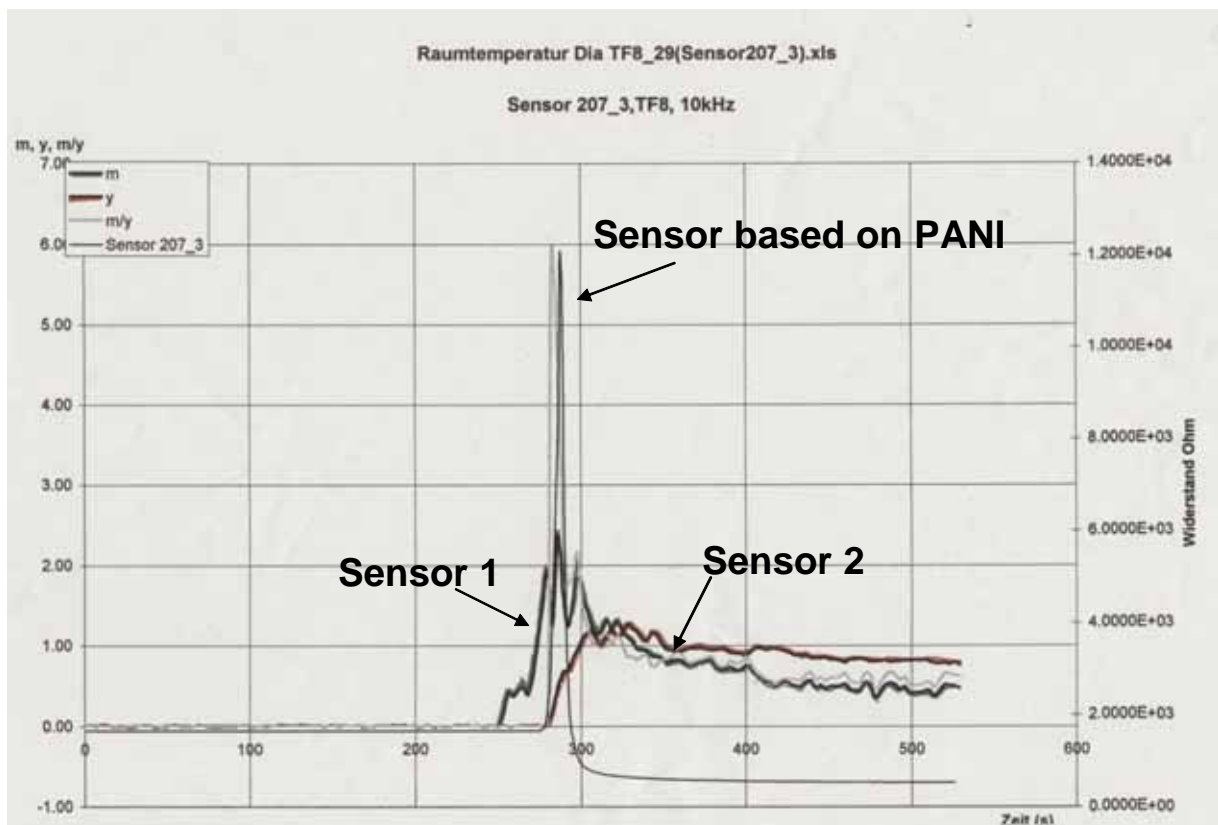

Fig. 88. Comparison PANI based HCl sensors with two commercial sensors (German market 2003) [66]

6 Conclusion

This thesis deals with the design and realization of a completely automated set-up for i) electrochemical synthesis, ii) high-throughput screening of previously synthesized polymer structures iii) and the comprehensive analysis of the obtained results. The proof and investigation of polymer materials for gaseous hydrogen chloride are presented.

The electrochemical synthesis was realized by principle of electrical addressation of the work electrode. A goal to create a common platform for different applications and a simple approach to make the first prototype not too complicated being resulted in some restrictions. The tree-electrode system with the central reference and auxiliary electrode was developed and used. Because of such electrode distribution, it did not allow to place the reference electrode close to each of the 96 work electrodes of the electrode array. Therefore, one had to limit applications by highly conductive electrolytes and low polymerization currents, where the voltage drop in the electrolyte was not significant. However, this limitation was not important for investigation of gas sensors, it could be overcome by placement of reference electrodes (96 corresponding to amount of work electrodes) directly on the electrode array next to each work electrode, mentioned in chapter 2.1.1 reported in [132-135]

The developed electrode array involved 96 interdigital structures [185] designed for four point measurements (electrical conductance). The arrays were formed on a silicon support, used in the semiconductor industry. The electrode layer (platinum) was formed by standard lithographic processes in order to get described interdigital topology. To determine the exact area of the electrodes additional mask layer was involved, described in chapter 2.1.5.

During the electropolymerization all four strips of the corresponding interdigital electrode were interconnected to form the single work electrode (that addressed one). The polymer grew on the electrode strips and filled the gaps between them, thus forming a chemo-resistor structure. It was found that the polymer (aniline) grew faster in the lateral direction (between strips) than perpendicular to the electrode surface. According to the investigation of the influence of the electropolymerization charge to polymer properties, it was found that the optimal charge for aniline based chemo-sensors should be 0.2 mC; this corresponded to the thickness of the polymer layer of about 1 μm (described in chapter 5.4). The higher EP charge led to damage of the polymer layer. This charge was kept constant for further investigations on copolymerization of aniline with its non-conductive derivatives (described in chapter 5.5).

The combinatorial electropolymerization was controlled by the computer with the corresponding software (chapter 2.6). For illustration, the time required by one combinatorial experiment was, (in the case of pure aniline), about 12 hours (for some copolymers more than 20 hours). Therefore, the automated and autonomous equipment for synthesis was the point of

this thesis. The combinatorial experiment resulted in numerous (defined by combinatorial library) chemo-sensors (with recorded kinetics), which were subjects of further screening and analysis.

The second part of the thesis describes the equipment for high-throughput screening of the previously synthesized chemo-resistors. Practically the same set-up was involved for electropolymerization and for screening, only few additions were made and different software was used. The main measurement concept was based on direct current conductance measurements, which involved simultaneously the two- and four-point technique. While the two-point technique provided the sum value of bulk resistance and two contact resistances, the four-point technique measured the bulk resistance (material properties) between two inner electrodes only (chapter 3). According to our knowledge, this was the first application of this simultaneous technique for the screening of polymer structures.

The software, described in 3.5, completely controlled the measurement set-up, adhering to the involved measurement protocol. The user could specify all measurement steps for each synthesized chemo-sensor. The developed thermo-regeneration of the sensors was also implemented, it rapidly decreased the regeneration time of polymer based chemo-sensors (chapter 3.3.1). Because the measurements were time consuming and the obtained data set was large, it was necessary to find a compromise between the measurement time and comprehension of measurements. Therefore the general measurement protocol was developed. The protocol characterized all important parameters of the sensors, such as reproducibility, selectivity, reversibility, response time, recovery time and others.

The measurement protocol, described in chapter 3.1, is the third part of the thesis. According to this protocol, the measurement required about 12 hours for characterization of one combinatorial library (one electrode array). The results of this high-throughput screening were recorded and further used together with electropolymerization results in the analysis tool. This tool calculated, visualized and exported all defined parameters (specified in the developed protocol). Due to the analysis tool, the data evaluation time, which before took more than several days (without the analysis tool), was decreased to minutes. The calculations of defined parameters were done in real-time and results were available immediately (described in chapter 4).

Finally, the application results on the investigation of materials for detection of gaseous hydrogen chloride, involving combinatorial approach, are presented. This investigation was based on former experiments using single electrodes. Their goal was to find appropriate electropolymerization conditions. This work was performed by C. Swart [67] and Qingli Hao

[66]. The presented results were obtained by common investigation with Dr. Qingli Hao, and combinatorial results are also partially shown in [66]. This investigation resulted in the determination of appropriate materials (co-polymers) for detection of gaseous hydrogen chloride. Highly sensitive, reversible and selective sensors for applications in alarm systems for cable fires were developed. The thermo-desorption principle was involved for regeneration of HCl sensors, this improved the reversibility and reproducibility of the gas detection. The comparison of the developed sensor with commercially available sensors is shown in chapter 5.6. According to the information from the industrial partner (which had performed this comparison, the data is not presented completely, because they are property of the industrial partner). The sensor tests under DIN conditions confirmed that the properties of developed polymer sensor essentially exceed properties of currently available sensors. The developed sensors and involved techniques are promising for further commercialization.

6.1 Summary

The developed equipment, presented in this thesis, provide about a 100-fold increase of throughput of polymer synthesis and investigation. In the future, it can be extended by combination with photochemical polymerization techniques or with optical investigation methods.

By changing the topology of the used electrode array to single spots it is possible to increase the number of work electrodes up to 384 and even more (theoretically up to 436). The formed electrode spots can be used for amperometric, potentiostatic or voltametric measurements for instance in research of amperometric chemo-sensors, biosensor, DNA applications and many others. This approach can be used widely for almost every technology, where electrical properties of polymers or polymeric structures are points of interest. Several challenging applications for biosensors and organic semiconductors are concluded in the outlook, which follows.

7 Outlook

7.1 Combinatorial synthesis of biochemical sensors

For more than 20 years, conductive polymers prepared by electropolymerization, are widely used for preparation of enzymatic biosensors (Fig. 89) [6, 100, 186-195]. It is performed by polymerization of appropriate monomers (typically, pyrrole) in the presence of enzyme [196]; the enzyme can be preliminary modified by pyrrole- or by another electrochemically polymerizable group [197]. To accelerate the electron transfer between polymer and redox site within the enzyme, redox mediators can be added or copolymerized [198, 199].

An optimization of enzymatic biosensors requires a variation of many parameters including a type of enzyme or a combination of enzymes, redox mediators, polymerization conditions and others. Taking in to account high-throughput methods which were already established in molecular biology, a fast combinatorial synthesis of redox mediators and a wide range of several physical parameters (concentrations of all reagents, polymerization time and conditions), one can design huge combinatorial libraries to be screened. A development of multienzymatic biosensors results in further increase of the order of these libraries.

It has been proven in preliminary experiments, the developed equipment can be used for screening of all reagent concentrations and physical parameters without any modifications; a screening of different preformed compounds (libraries of enzymes and mediators) demands a combination of this equipment with an automated probe sampler. A further screening of the libraries can be performed on the same device; in this case instead of the reagents for synthesis, the reservoirs are filled with analytes (enzyme substrate) and possible interferents. The device dilutes substances, deliver them into the cell with the library of sensors and measures dependence of the electrode currents on the analyte (or interferent) concentration; these data can be further used for programmed analysis of biosensors parameters. Depending on the polymerization time and screening program, an estimated throughput of one device in such experiments can be about 100 - 300 spots (i.e. 1 - 3 libraries) per day.

Besides optimization of biosensors, the set-up can be used for synthesis and screening of an outer filter layer. The layer can be formed by means of electropolymerization, as an additional polymer layer after biosensor synthesis [16]. The sensor based on electrochemically synthesized polymers can explore also non-electrical detection. For example, sensors for DNA analysis, based on electrochemical polymerization with a subsequent fluorescent detection were described [195, 200]. In this case, the polymer matrix has a mechanical function only; therefore nonconductive polymers can also be used. Possibilities to use the approach for synthesis of corresponding combinatorial libraries do not require any explanations. Other fields

of possible applications of combinatorial electropolymerization for development of chemical and biological sensors include combinatorial electrochemical synthesis of molecularly imprinted polymers (without combinatorial approach it has been published in [201-205]), optimization of embedding of biomolecules into the polymer matrix, development of impedometric biosensors based on electrochemically polymerized films [206, 207] and many others.

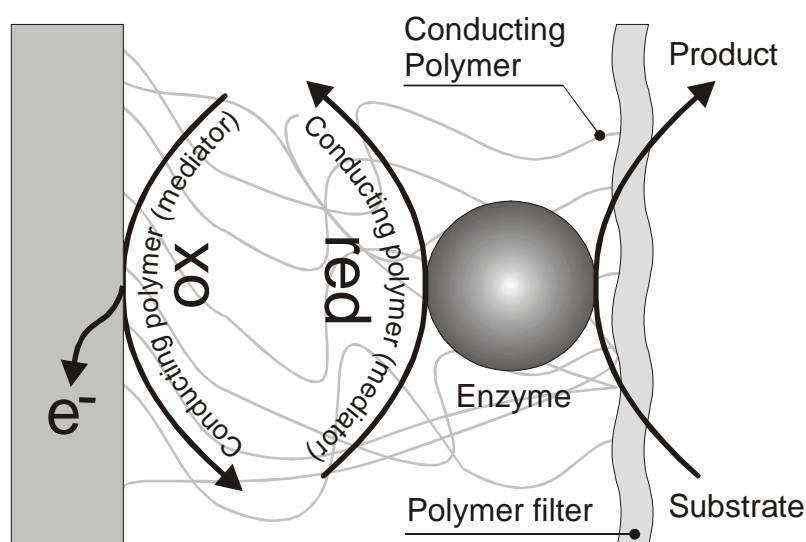

Fig. 89. A typical enzymatic amperometric biosensor based on conductive polymers. An additional electrochemically synthesized polymer layer can be used as a filter

7.2 Combinatorial synthesis of organic electronic devices

Unique mechanical (flexibility and low weight), electrical and optical properties of electrochemically synthesized polymers and inexpensive fabrication technology make them very attractive for applications in electronics. Particularly important is a use of organic materials in display technology (OLEDs or organic displays), in formation of Schottky contacts, diodes, field effect transistors and ultra-capacity capacitors [57].

Organic Light Emitting Diodes (OLEDs) [32] are typically formed on glass or plastic substrate with ITO (indium tin oxide) electrodes [32, 32, 208-210]. Such electrodes are transparent and provide a good emission of holes. The electrodes are covered by a thin protective layer (for example, cooper phthalocyanine), then by polymer layers with *p*- and *n*-types of conductivity. Finally, a cathode alloy is added. Other types of OLEDs use organic emitter. The OLEDs based on fluorene polymers [35, 208, 211] have as good electrical and light-emitting properties comparing to traditional (inorganic) light-emitting diodes, however, their temporal stability is still rather poor. Some types of OLEDs are already commercialized by *Cambridge Display Technology* [38], *DuPont Displays* [36], *IBM* [37] and by other companies. A fast search for novel polymeric materials and their combinations for OLEDs

development can be performed by combinatorial electropolymerization. The preparation technique is outlined in Fig. 90.

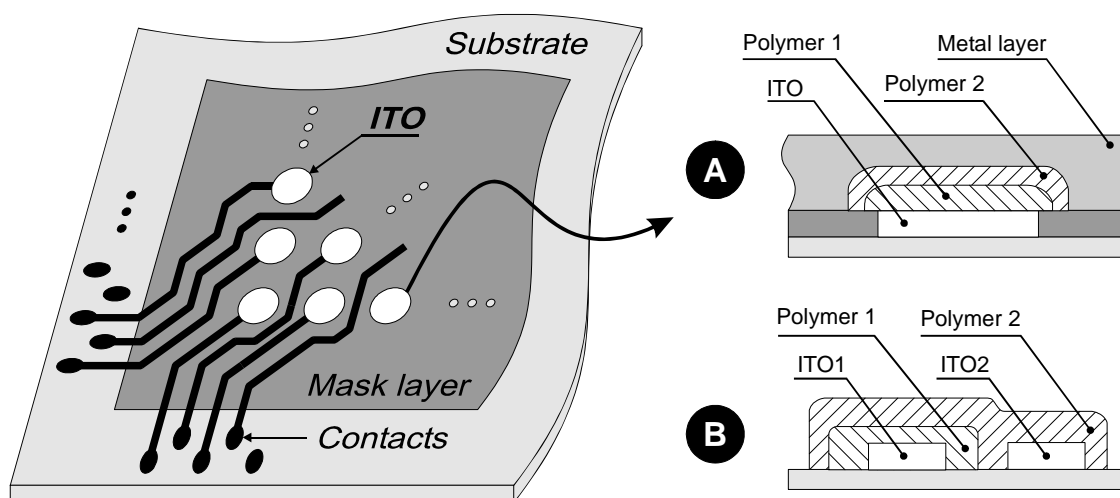

Fig. 90. Suggestive approaches for preparation combinatorial libraries of organic light-emitting diodes (OLEDs) and possible structures for these devices

Two possible structures for preparation OLEDs structures are shown in Fig. 90, right. The first one (Fig. 90) includes a deposition of a common metallic anode formed on the OLED structure (by electroplating *in-situ*, by sputtering or by evaporation). In the second approach (Fig. 90), both cathode and anode are placed on the electrode array. A combination of serial and parallel combinatorial electropolymerization leads to formation of combinatorial library of OLEDs. The current configuration of the set-up allows one to form libraries containing up to 96 basic structures for OLEDs but can be easily increased up to 384.

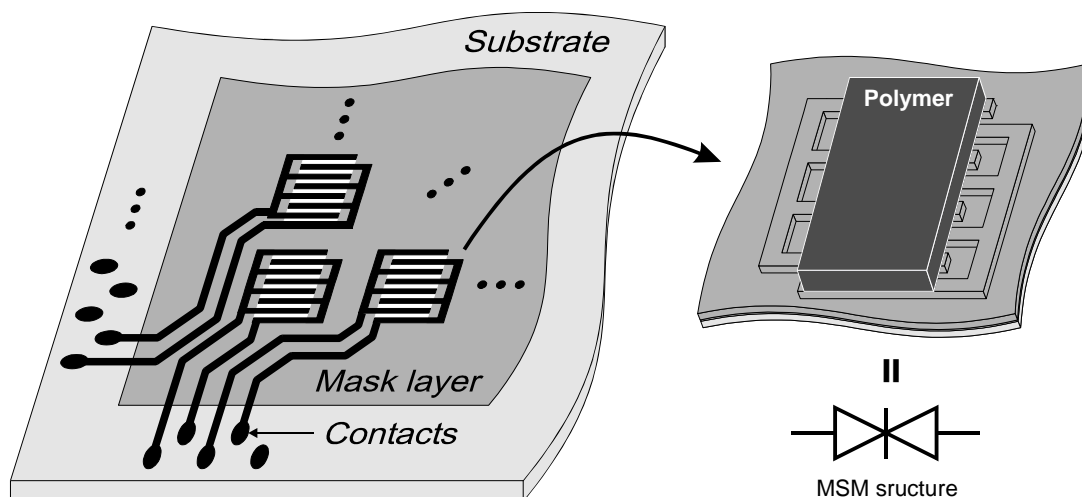

Fig. 91. Electrode array for preparation MSM (metal/semiconductor/metal) structures (left) and a single interdigital electrode with polymer layer (right)

Schottky diodes formed by a metal / semiconducting polymer can be easily prepared by electropolymerization [212]. The preparation approach is similar to that of OLEDs (Fig. 90), but the electrode material can be different [50, 51, 212, 213]. The same principles can be also used to prepare classic *p-n junction diodes* [213]. Especially simple is a combinatorial synthesis of MSM (metal / semiconductor / metal) structures consisting of two Schottky contacts (Fig. 91); such structures are often used in high speed photo-detectors. Many light sensitive polymers can be used in these devices [48]. Additionally, the MSM structure can be used as simple transducers in chemical sensors.

Organic field effect transistors are described in [42, 44-47, 55, 212, 214]. Although several operating devices were described, a search for new materials and structures is still in the beginning stages, and the combinatorial approach can essentially accelerate technological development in this field. A typical structure of organic field effect transistors [40, 43] can be prepared by electropolymerization on the source and drain electrodes formed on highly doped silicon substrate coated by the oxide layer (Fig. 92, A). It is known that electrochemical synthesis leads to much faster growth of polymers in lateral direction than in the transversal direction; it makes possible a formation of the polymeric gap operating as a conductive channel. Another topology (Fig. 92, B) can be used for preparation of organic field effect transistors for applications in chemical sensors and biosensors [55] instead of traditional non-organic ISFETs [215-217]. Other applications of the combinatorial approach in organic electronics can include a development of capacitors [61], high-efficiency solar cells [60], batteries, printed circuit boards [65] and many other.

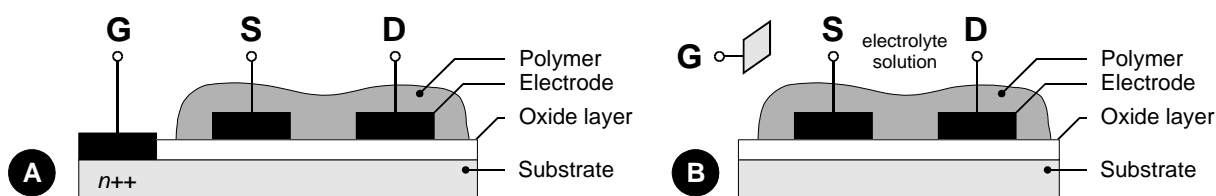

Fig. 92. Structures of organic field effect transistors for applications in electronics (A) and with a gate contacting with solution for applications in transducers of chemical and biological sensors (B)

8 Bibliography

- [1] Naarmann H., Beck F. and Kastning E., "Organic semiconductors", 3-19640924, 1964
- [2] Naarmann H., "Polymeric organic semiconductors", *Naturwissenschaften* **56**, 308-313, 1969
- [3] Dresner J., "Double injection electroluminescence in anthracene", *RCA Rev.* **30**, 322-334, 1969
- [4] MacDiarmid A.G., "Synthetic metals: A novel role for organic polymers (Nobel Lecture)", *Angewandte Chemie, International Edition* **40**, 2581-2590, 2001
- [5] Inzelt G., Pineri M., Schultze J.W. and Vorotyntsev M.A., "Electron and proton conducting polymers: recent developments and prospects", *Electrochimica Acta* **45**, 2403-2421, 2000
- [6] Gerard M., Chaubey A. and Malhotra B.D., "Application of conducting polymers to biosensors", *Biosensors & Bioelectronics* **17**, 345-359, 2002
- [7] Mirsky, V. M. and Kulikov, V., "Combinatorial electropolymerization: concept, equipment and applications", in book: High Throughput Analysis: A Tool for Combinatorial Materials Science, 2004, 431-446
- [8] Burroughes J.H., Bradley D.D.C., Brown A.R., Marks R.N., Mackay K., Friend R.H., Burns P.L. and Holmes A.B., "Light-emitting diodes based on conjugated polymers", *Nature (London, United Kingdom)* **347**, 539-541, 1990
- [9] Khan M.A. and Armes S.P., "Conducting polymer-coated latex particles", *Advanced Materials (Weinheim, Germany)* **12**, 671-674, 2000
- [10] Spinks G.M., Dominis A.J., Wallace G.G. and Tallman D.E., "Electroactive conducting polymers for corrosion control - Part 2. Ferrous metals", *Journal of Solid State Electrochemistry* **6**, 85-100, 2002
- [11] Garces P., Lapuente R., Andion L.G., Cases F., Morallon E. and Vazquez J.L., "Electropolymerization of phenol on carbon steel and stainless steel electrodes in carbonate aqueous medium", *Polymer Journal (Tokyo)* **32**, 623-628, 2000
- [12] Heuer H.W., Wehrmann R. and Kirchmeyer S., "Electrochromic window based on conducting poly(3,4-ethylenedioxythiophene)-poly(styrene sulfonate)", *Advanced Functional Materials* **12**, 89-94, 2002
- [13] Kuhn H.H., Kimbrell W.C., Fowler J.E. and Barry C.N., "Properties and applications of conductive textiles", *Synthetic Metals* **57**, 3707-3712, 1993
- [14] Zhang S., Wright G. and Yang Y., "Materials and techniques for electrochemical biosensor design and construction", *Biosensors & Bioelectronics* **15**, 273-282, 2000
- [15] Kurzawa C., Hengstenberg A. and Schuhmann W., "Immobilization method for the preparation of biosensors based on pH shift-induced deposition of biomolecule-containing polymer films", *Analytical Chemistry* **74**, 355-361, 2002
- [16] Christie I.M., Rigby G.P., Treloar P., Warriner K., Maines A., Ashworth D., Eddy S., Reddy S.M. and Vadgama P., "The use of chemical sensor systems for sampling, selectivity and speciation", *NATO ASI Ser. , Ser. 2* **38**, 41-56, 1997

- [17] Palmisano F., Zambonin P.G. and Centonze D., "Amperometric biosensors based on electrosynthesised polymeric films", *Fresenius' Journal of Analytical Chemistry* **366**, 586-601, 2000
- [18] Karyakin A.A., Bobrova O.A., Lukachova L.V. and Karyakina E.E., "Potentiometric biosensors based on polyaniline semiconductor films", *Sensors and Actuators, B: Chemical* **B33**, 34-38, 1996
- [19] Kaden H., Juttner K., Jahn H., Berthold M., Mangold K.M. and Schafer S., "New polypyrrole-modified potentiometric sensors", *Chemie Ingenieur Technik* **72**, 1534-1538, 2000
- [20] Mangold K.M., Schafer S. and Juttner K., "Reference electrodes based on conducting polymers", *Fresenius' Journal of Analytical Chemistry* **367**, 340-342, 2000
- [21] Mangold K.M., Schafer S. and Juttner K., "Reference electrodes based on conducting polymer bilayers", *Synthetic Metals* **119**, 345-346, 2001
- [22] Kaden H., Jahn H., Berthold M., Juttner K., Mangold K.M. and Schafer S., "Polypyrrole as the active material for potentiometric sensors", *Chemical Engineering & Technology* **24**, 1120-1124, 2001
- [23] Livache T., Bazin H., Caillat P. and Roget A., "Electroconducting polymers for the construction of DNA or peptide arrays on silicon chips", *Biosensors & Bioelectronics* **13**, 629-634, 1998
- [24] Prodromidis M.I. and Karayannis M.I., "Enzyme based amperometric biosensors for food analysis", *Electroanalysis* **14**, 241-261, 2002
- [25] Ampuero S. and Bosset J.O., "The electronic nose applied to dairy products: a review", *Sensors and Actuators, B: Chemical* **B94**, 1-12, 2003
- [26] Haupt K., "Molecularly imprinted polymers in analytical chemistry", *Analyst (Cambridge, United Kingdom)* **126**, 747-756, 2001
- [27] Partridge A.C., Jansen M.L. and Arnold W.M., "Conducting polymer-based sensors", *Materials Science & Engineering, C: Biomimetic and Supramolecular Systems* **C12**, 37-42, 2000
- [28] Schaller E., Bosset J.O. and Escher F., "'Electronic noses' and their application to food", *Lebensm. -Wiss. Technol.* **31**, 305-316, 1998
- [29] Barisci J.N., Conn C. and Wallace G.G., "Conducting polymer sensors", *Trends Polym. Sci. (Cambridge, U. K.)* **4**, 307-311, 1996
- [30] Gardner J.W. and Bartlett P.N., "Design of conducting polymer gas sensors: modeling and experiment", *Synth. Met.* **57**, 2665-2670, 1993
- [31] Jurs P.C., Bakken G.A. and McClelland H.E., "Computational methods for the analysis of chemical sensor array data from volatile analytes", *Chemical Reviews (Washington, D. C.)* **100**, 2649-2678, 2000
- [32] Bernius M.T., Inbasekaran M., O'Brien J. and Wu W., "Progress with light-emitting polymers", *Advanced Materials (Weinheim, Germany)* **12**, 1737-1750, 2000
- [33] Salaneck W.R. and Logdlund M., "Conjugated polymer surfaces and interfaces in polymer-based light-emitting diodes", *Polymers for Advanced Technologies* **9**, 419-428, 1998

- [34] Birgerson J., Fahlman M., Broems P. and Salaneck W.R., "Conjugated polymer surfaces and interfaces: a mini-review and some new results", *Synthetic Metals* **80**, 125-130, 1996
- [35] Jung B.J., Lee J.I., Chu H.Y., Do L.M. and Shim H.K., "Synthesis of Novel Fluorene-Based Poly(iminoarylene)s and Their Application to Buffer Layer in Organic Light-Emitting Diodes", *Macromolecules* **35**, 2282-2287, 2002
- [36] Organic displays, DuPont Displays, Internet address:
<http://www.dupont.com/displays/oled/>
- [37] Organic displays, IBM, Internet address:
<http://www.almaden.ibm.com/st/projects/oleds/fabrication/index.html>
- [38] Organic displays, Cambridge Display Technology, Internet address:
<http://www.cdtltd.co.uk/>
- [39] Gardner J.W. and Bartlett P.N., "Application of conducting polymer technology in microsystems", *Sensors and Actuators, A: Physical* **A51**, 57-66, 1995
- [40] Mitzi D.B., Chondroudis K. and Kagan C.R., "Organic-inorganic electronics", *IBM Journal of Research and Development* **45**, 29-45, 2001
- [41] Blom P.W.M., De Jong M.J.M. and Liedenbaum C.T.H.F., "Device physics of polymer light-emitting diodes", *Polymers for Advanced Technologies* **9**, 390-401, 1998
- [42] Garnier F., "Thin-film transistors based on organic conjugated semiconductors", *Chemical Physics* **227**, 253-262, 1998
- [43] Kagan C.R., Mitzi D.B. and Dimitrakopoulos C.D., "Organic-inorganic hybrid materials as semiconducting channels in thin-film field-effect transistors", *Science (Washington, D. C.)* **286**, 945-947, 1999
- [44] Jones E.T.T., Chyan O.M. and Wrighton M.S., "Preparation and characterization of molecule-based transistors with a 50-nanometer source-drain separation with use of shadow deposition techniques. Toward faster, more sensitive molecule-based devices", *J. Am. Chem. Soc.* **109**, 5526-5528, 1987
- [45] Koezuka H., Tsumura A., Fuchigami H. and Kuramoto K., "Polythiophene field-effect transistor with polypyrrole worked as source and drain electrodes", *Appl. Phys. Lett.* **62**, 1794-1796, 1993
- [46] Lovinger A.J. and Rothberg L.J., "Electrically active organic and polymeric materials for thin-film-transistor technologies", *Journal of Materials Research* **11**, 1581-1592, 1996
- [47] Tsumura A., Koezuka H. and Ando T., "Polythiophene field-effect transistor: its characteristics and operation mechanism", *Synth. Met.* **25**, 11-23, 1988
- [48] Kudo T., Kimura M., Hanabusa K. and Shirai H., "Fabrication of p-n junction diodes from phthalocyanine and electropolymerized perylene derivatives", *Journal of Porphyrins and Phthalocyanines* **2**, 231-235, 1998
- [49] Uehara K., Ichikawa T., Maekawa A., Serikawa T., Nishiyama N. and Tsunooka M., "Control of electron transfer direction in an organic two-layer diode based on a lightly-

- doped poly(3-methylthiophene)/9-fluorenone derivatives junction", *Thin Solid Films* **266**, 263-266, 1995
- [50] Singh R., Srivastava D.N. and Singh R.A., "Schottky diodes based on some semiconducting polymers", *Synthetic Metals* **121**, 1439-1440, 2001
- [51] Narasimhan M., Hagler M., Cammarata V. and Thakur M., "Junction devices based on sulfonated polyaniline", *Applied Physics Letters* **72**, 1063-1065, 1998
- [52] Tsutsumi H., "Synthesis of post-polymerizable polyaniline-p-styrenesulfonic acid composite and its application to Schottky diode", *Synthetic Metals* **69**, 143-144, 1995
- [53] Moeller S., Perlov C., Jackson W., Taussig C. and Forrest S.R., "A polymer/semiconductor write-once read-many-times memory", *Nature (London, United Kingdom)* **426**, 166-169, 2003
- [54] Gelinck G.H., Geuns T.C.T. and de Leeuw D.M., "High-performance all-polymer integrated circuits", *Applied Physics Letters* **77**, 1487-1489, 2000
- [55] McCoy C.H. and Wrighton M.S., "Potential-dependent conductivity of conducting polymers yields opportunities for molecule-based devices: a microelectrochemical push-pull amplifier based on two different conducting polymer transistors", *Chemistry of Materials* **5**, 914-916, 1993
- [56] Yoda N., "Recent developments in advanced functional polymers for semiconductor encapsulants of integrated circuit chips and high-temperature photoresist for electronic applications", *Polymers for Advanced Technologies* **8**, 215-226, 1997
- [57] Organic ICs, Plastic Logic, Internet address:
<http://www.plasticlogic.com/>
- [58] Oyama N., "Polymer batteries", *Kogyo Zairyo* **47**, 26-27, 1999
- [59] Nishizawa M., "Microelectrode-based characterization systems for advanced materials in sensor and battery applications", *Chem. Sens.* **16**, 139-141, 2000
- [60] Fahlman M. and Salaneck W.R., "Surfaces and interfaces in polymer-based electronics", *Surface Science* **500**, 904-922, 2002
- [61] Andrieu X., "Ultracapacitors for portable electronics", *New Trends in Electrochemical Technology* **1**, 521-547, 2000
- [62] Arbizzani C., Mastragostino M. and Soavi F., "New trends in electrochemical supercapacitors", *Journal of Power Sources* **100**, 164-170, 2001
- [63] Goodenough M. and Whitlaw K.J., "The use of conductive organic coatings for metallization of printed circuit boards", *Trans. Inst. Met. Finish.* **70**, 135-140, 1992
- [64] Hupe J., Wolf G.D. and Jonas F., "A known principle with a novel basis. Through-hole contacting of printed circuit boards using conductive polymers", *Galvanotechnik* **86**, 3404-3411, 1995
- [65] Goosey M., "Polymers in printed circuit board (PCB) and related advanced interconnect applications", *Plastics for Electronics (2nd Edition)*, 293-332, 1999
- [66] Qingli Hao, "Thesis: Development of Conductometric Polymer Sensor for Gaseous Hydrogen Chloride", University Regensburg, Institute for Analytical Chemistry, Chemo- and Biosensors, 2003

- [67] Claudia Swart, "Diploma work: Electrochemically Prepared Conductive Polymers as Materials for Sensing HCl Gas", University Regensburg, Institute for Analytical Chemistry, Chemo- and Biosensors, 2001
- [68] Kulikov, V., "Automated system for combinatorial synthesis and high-throughput characterization of polymeric sensor materials, documentation DVD-R", Directory: DVD-R:\, Availability: University of Regensburg, contact person: Prof. V. M. Mirsky
- [69] Valentin Kulikov, Vladimir M.Mirsky, Claudia Swart and Otto S.Wolfbeis, "Combinatorial Electropolymerization", *Conference (Poster presentation) EUROCOMBI*, 2000
- [70] Valentin Kulikov, V.M.Mirsky and O.S.Wolfbeis, "Automated Set-up for Formation and Investigation of Thin Polymer Films", *Conference (oral presentation) APCOM ISBN 80-8040-160-8*, 2004
- [71] Valentin Kulikov, Qingly Hao and Vladimir M.Mirsky, "Combinatorial investigation of organic semiconductors", *Conference (Poster presentation) ASDAM*, 2002
- [72] Valentin Kulikov, Qing-li Hao, Vladimir M.Mirsky and Otto S.Wolfbeis, "Set-up for Combinatorial Electropolymerization and Investigation of Polymer Properties", *Conference (Poster presentation) EUROSENSORS*, 2002
- [73] Kulikov V. and Mirsky V.M., "Equipment for combinatorial electrochemical polymerization and high-throughput investigation of electrical properties of the synthesized polymers", *Measurement Science and Technology* **1**, 2004
- [74] Vladimir M.Mirsky, Valentin Kulikov, Qingli Hao and Otto S.Wolfbeis, "Multiparameter High Throughput Characterization of Combinatorial Chemical Microarrays of Chemosensitive Polymers", *Molecular Rapid Communication* **25**, 2004
- [75] Valentin Kulikov, Vladimir M.Mirsky, Tanya Delaney, Daniel.Donoval, Alexander W.Koch and Otto S.Wolfbeis, "High-throughput analysis of bulk and contact conductance of polymer layers prepared by combinatorial electropolymerization", *Measurement Science and Technology* **16**, 95-99, 2005
- [76] Breitenbach J.W., Olaj O.F. and Sommer F., "Polymerization initiation by electrolysis", *Fortschr. Hochpolym. -Forsch.* **9**, 47-227, 1972
- [77] Subramanian R.V., "Electroinitiated polymerization on electrodes", *Adv. Polym. Sci.* **33**, 33-58, 1979
- [78] Wolf M.O. and Zhu Y., "Electropolymerization of oligothiénylferrocene complexes", *Advanced Materials (Weinheim, Germany)* **12**, 599-601, 2000
- [79] Mengoli G. and Musiani M.M., "Phenol electropolymerization: a straight route from monomers to polymer coatings", *Progress in Organic Coatings* **24**, 237-251, 1994
- [80] Yuan W. and Iroh J.O., "Electropolymerization of olefinic monomers", *Trends in Polymer Science (Cambridge, United Kingdom)* **1**, 388-394, 1993
- [81] Mengoli G. and Musiani M.M., "An overview of phenol electropolymerization for metal protection", *J. Electrochem. Soc.* **134**, 643C-652C, 1987
- [82] Waltman R.J. and Bargon J., "Electrically conducting polymers: a review of the electropolymerization reaction, of the effects of chemical structure on polymer film properties, and of applications towards technology", *Can. J. Chem.* **64**, 76-95, 1986

- [83] Sabouraud G., Sadki S. and Brodie N., "The mechanisms of pyrrole electropolymerization", *Chemical Society Reviews* **29**, 283-293, 2000
- [84] Guerra, G. D., "Electroinitiated Polymerization.", in book: Chain Polymerization, Part II, 2002, 453-458
- [85] Rifi M.R. and Covitz F.H., "Introduction to organic electrochemistry", 1974
- [86] Ye S.Y., Do N.T., Dao L.H. and Vijh A.K., "Electrochemical preparation and characterization of conducting copolymers: Poly(aniline-co-N-butylaniline)", *Synthetic Metals* **88**, 65-72, 1997
- [87] Chen J., Burrell A.K., Collis G.E., Officer D.L., Swiegers G.F., Too C.O. and Wallace G.G., "Preparation, characterisation and biosensor application of conducting polymers based on ferrocene substituted thiophene and terthiophene", *Electrochimica Acta* **47**, 2715-2724, 2002
- [88] Hosseini S.H. and Entezami A.A., "Chemical and electrochemical synthesis of homopolymer and copolymers of 3-methoxyethoxythiophene with aniline, thiophene and pyrrole for studies of their gas and vapor sensing", *Polymers for Advanced Technologies* **12**, 524-534, 2001
- [89] Glidle A., Swann M.J., Hadyoon C.S., Cui L., Davis J., Ryder K.S. and Cooper J.M., "XPS assaying of electrodeposited copolymer composition to optimize sensor materials", *Journal of Electron Spectroscopy and Related Phenomena* **121**, 131-148, 2001
- [90] Aubert P.H., Neudeck A., Dunsch L., Audebert P., Capdevielle P. and Maumy M., "Electrochemical synthesis and structural studies of copolymers based on the electrooxidation of pyrrole and some salen compounds", *Journal of Electroanalytical Chemistry* **470**, 77-88, 1999
- [91] Lee J.Y., Su X.H. and Cui C.Q., "Characterization of electrodeposited copolymers of aniline and metanilic acid", *J. Electroanal. Chem.* **367**, 71-78, 1994
- [92] Nofle R.E. and Pletcher D., "The mechanism of electrodeposition of composite polymers including polypyrrole", *J. Electroanal. Chem. Interfacial Electrochem.* **227**, 229-235, 1987
- [93] McCullough R.D., "The chemistry of conducting polythiophenes", *Adv. Mater. (Weinheim, Ger.)* **10**, 93-116, 1998
- [94] Groenendaal L., Jonas F., Freitag D., Pielartzik H. and Reynolds J.R., "Poly(3,4-ethylenedioxythiophene) and its derivatives: past, present, and future", *Advanced Materials (Weinheim, Germany)* **12**, 481-494, 2000
- [95] Karyakin A.A., Karyakina E.E., Schuhmann W. and Schmidt H.L., "Electropolymerized azines. Part 2. In a search of the best electrocatalyst of NADH oxidation", *Electroanalysis* **11**, 553-557, 1999
- [96] Karyakin A.A., Karyakina E.E. and Schmidt H.L., "Electropolymerized azines. A new group of electroactive polymers", *Electroanalysis* **11**, 149-155, 1999
- [97] Schlereth D.D. and Karyakin A.A., "Electropolymerization of phenothiazine, phenoxazine and phenazine derivatives: characterization of the polymers by UV-visible difference spectroelectrochemistry and Fourier transform IR spectroscopy", *Journal of Electroanalytical Chemistry* **395**, 221-232, 1995

- [98] Bloor, D., "Electrical Conductivity.", in book: Polymer properties., 1989, 687-705
- [99] Beck-Sickinger A. and Weber P., "Kombinatorische Methoden in Chemie und Biologie", 1999
- [100] Cosnier S., "Biosensors based on immobilization of biomolecules by electrogenerated polymer films. New perspectives", *Applied Biochemistry and Biotechnology* **89**, 127-138
- [101] Schiedel M.S., Briehn C.A. and Bauerle P., "Single-compound libraries of organic materials: parallel synthesis and screening of fluorescent dyes", *Angewandte Chemie, International Edition* **40**, 4677-4680, 2001
- [102] Briehn C.A., Schiedel M.S., Bensen E.M., Schuhmann W. and Bauerle P., "Single-compound libraries of organic materials: from the combinatorial synthesis of conjugated oligomers to structure-property relationships", *Angewandte Chemie, International Edition* **40**, 4680-4683, 2001
- [103] Vermeulen C., Pellaud J., Gijs L. and Collin S., "Combinatorial Synthesis and Sensorial Properties of Polyfunctional Thiols", *Journal of Agricultural and Food Chemistry* **49**, 5445-5449, 2001
- [104] Baeck S.H., Jaramillo T.F., Braendli C. and McFarland E.W., "Combinatorial Electrochemical Synthesis and Characterization of Tungsten-Based Mixed-Metal Oxides", *Journal of Combinatorial Chemistry* **4**, 563-568, 2002
- [105] dem Bussche-Hunnefeld C., Balkenhohl F., Lansky A. and Zechel C., "Combinatorial chemistry", *Fresenius' Journal of Analytical Chemistry* **359**, 3-9, 1997
- [106] Sullivan M.G., Utomo H., Fagan P.J. and Ward M.D., "Automated Electrochemical Analysis with Combinatorial Electrode Arrays", *Analytical Chemistry* **71**, 4369-4375, 1999
- [107] Jiang R. and Chu D., "A combinatorial approach toward electrochemical analysis", *Journal of Electroanalytical Chemistry* **527**, 137-142, 2002
- [108] Gallop M.A., "Solid-phase synthesis of compound libraries and their applications in drug discovery.", 1-36, 2000
- [109] De Mello A.J., "Miniaturization", *Analytical and Bioanalytical Chemistry* **372**, 12-13, 2002
- [110] Salimi-Moosavi H., Tang T. and Harrison D.J., "Electroosmotic Pumping of Organic Solvents and Reagents in Microfabricated Reactor Chips", *Journal of the American Chemical Society* **119**, 8716-8717, 1997
- [111] Yudin A.K. and Siu T., "Combinatorial electrochemistry", *CURRENT OPINION IN CHEMICAL BIOLOGY* **5**, 269-272
- [112] Pilard J.F., Marchand G. and Simonet J., "Chemical synthesis at solid interfaces. On the use of conducting polythiophenes equipped of adequate linkers allowing a facile and highly selective cathodic S-N bond scission with a fully regenerating resin process", *Tetrahedron* **54**, 9401-9414, 1998
- [113] Niyazymbetov M., "Use of electrochemical methods in synthesis of organic compounds for biological screening", 1996

- [114] Green M., "Electrically addressable electrochemical cell array" **2001-16057**, 21-20021231
- [115] Glass R.S., Perone S.P. and Ciarlo D.R., "Application of information theory to electroanalytical measurements using a multielement, microelectrode array", *Analytical Chemistry* **62**, 1914-1918, 1990
- [116] Partridge A.C., Harris P. and Andrews M.K., "High sensitivity conducting polymer sensors", *Analyst (Cambridge, United Kingdom)* **121**, 1349-1353, 1996
- [117] Jandeleit B., Schaefer D.J., Powers T.S., Turner H.W. and Weinberg W.H., "Combinatorial materials science and catalysis", *Angewandte Chemie, International Edition* **38**, 2494-2532, 1999
- [118] Liu H., Felten C., Xue Q., Zhang B., Jedrzejewski P., Karger B.L. and Foret F., "Development of Multichannel Devices with an Array of Electrospray Tips for High-Throughput Mass Spectrometry", *Analytical Chemistry* **72**, 3303-3310, 2000
- [119] Nagale M.P. and Fritsch I., "Individually Addressable, Submicrometer Band Electrode Arrays. 2. Electrochemical Characterization", *Analytical Chemistry* **70**, 2908-2913, 1998
- [120] Nagale M.P. and Fritsch I., "Individually Addressable, Submicrometer Band Electrode Arrays. 1. Fabrication from Multilayered Materials", *Analytical Chemistry* **70**, 2902-2907, 1998
- [121] Reddington E., Sapienza A., Gurau B., Viswanathan R., Sarangapani S., Smotkin E.S. and Mallouk T.E., "Combinatorial electrochemistry: a highly parallel, optical screening method for discovery of better electrocatalysts", *Science (Washington, D. C.)* **280**, 1735-1737, 1998
- [122] Zou L., Savvate'ev V., Booher J., Kim C.H. and Shinar J., "Combinatorial fabrication and studies of intense efficient ultraviolet-violet organic light-emitting device arrays", *Applied Physics Letters* **79**, 2282-2284, 2001
- [123] Schuhmann W., "Amperometric enzyme biosensors based on optimized electron-transfer pathways and non-manual immobilization procedures", *Reviews in Molecular Biotechnology* **82**, 425-441, 2002
- [124] Agilent Technologies I., "Advanced programming with HP VEE" **5**, 2003
- [125] Sawyer, Donald T., Sobkowiak, Andrzej, Roberts, Julian L., and Sawyer, Donald T., "Electrochemistry for chemists", in book: 1995,
- [126] Bard A.J. and Faulkner L.R., "Electrochemical methods fundamentals and applications" **2nd ed**, 2001
- [127] Keithley, "Model 2400 Series SourceMeter User's Manual" **Rev.F**, 2001
- [128] Busoni L., Carla M. and Lanzi L., "A comparison between potentiostatic circuits with grounded work or auxiliary electrode", *Review of Scientific Instruments* **73**, 1921-1923, 2002
- [129] Reference Electrodes, Research Solutions & Resources, Internet address:
<http://www.consultrsr.com/>
- [130] Meites, Louis, "Handbook of analytical chemistry", in book: 1963,

- [131] Hassel A.W., Fushimi K. and Seo M., "An agar-based silver|silver chloride reference electrode for use in micro-electrochemistry", *Electrochemistry Communications* **1**, 180-183, 1999
- [132] Suzuki H., Shiroishi H., Sasaki S. and Karube I., "Microfabricated Liquid Junction Ag/AgCl Reference Electrode and Its Application to a One-Chip Potentiometric Sensor", *Analytical Chemistry* **71**, 5069-5075, 1999
- [133] Suzuki H., Hiratsuka A., Sasaki S. and Karube I., "Problems associated with the thin-film Ag/AgCl reference electrode and a novel structure with improved durability", *Sensors and Actuators, B: Chemical* **B46**, 104-113, 1998
- [134] Suzuki H., Hirakawa T., Sasaki S. and Karube I., "An integrated three-electrode system with a micromachined liquid-junction Ag/AgCl reference electrode", *Analytica Chimica Acta* **387**, 103-112, 1999
- [135] Tu Y.F., Fu Z.Q. and Chen H.Y., "The fabrication and optimization of the disposable amperometric biosensor", *Sensors and Actuators, B: Chemical* **B80**, 101-105, 2001
- [136] East G.A. and Del Valle M.A., "Easy-to-make Ag/AgCl reference electrode", *Journal of Chemical Education* **77**, 97-, 2000
- [137] Vaireanu D.I. and Simion A., "A novel silver/silver chloride - saturated gel reference electrode for electrochemical measurements used in connection with pollution monitoring systems", *Science and Technology of Environmental Protection* **7**, 31-36, 2000
- [138] Koslow Scientific Company, Koslow Scientific Company, Internet address:
www.koslow.com
- [139] Kulikov, V., "Automated system for combinatorial synthesis and high-throughput characterization of polymeric sensor materials, documentation DVD-R", Directory: DVD-R:\Software\REFEL, Availability: University of Regensburg, contact person: Prof. V. M. Mirsky
- [140] Teflon material, DuPont, science company, Internet address:
<http://www.dupont.com/teflon/>
- [141] Kulikov, V., "Automated system for combinatorial synthesis and high-throughput characterization of polymeric sensor materials, documentation DVD-R", Directory: DVD-R:\Design\Electrochemical Cell, Availability: University of Regensburg, contact person: Prof. V. M. Mirsky
- [142] Paolesse R., Di Natale C., Burgio M., Martinelli E., Mazzone E., Palleschi G. and D'Amico A., "Porphyrin-based array of cross-selective electrodes for analysis of liquid samples", *Sensors and Actuators, B: Chemical* **B95**, 400-405, 2003
- [143] Potyrailo R.A. and Pickett J.E., "High-throughput multilevel performance screening of advanced materials", *Angewandte Chemie, International Edition* **41**, 4230-4233, 2002
- [144] Vostiar I., Tkac J., Sturdik E. and Gemeiner P., "Amperometric urea biosensor based on urease and electropolymerized toluidine blue dye as a pH-sensitive redox probe", *BIOELECTROCHEMISTRY* **56**, 113-115, 2002

- [145] Albert K.J., Lewis N.S., Schauer C.L., Sotzing G.A., Stitzel S.E., Vaid T.P. and Walt D.R., "Cross-reactive chemical sensor arrays", *Chemical Reviews (Washington, D. C.)* **100**, 2595-2626, 2000
- [146] Hao Q., Kulikov V. and Mirsky V.M., "Investigation of contact and bulk resistance of conducting polymers by simultaneous two- and four-point technique", *Sensors and Actuators, B: Chemical* **94**, 352-357, 2003
- [147] Kulikov, V., "Automated system for combinatorial synthesis and high-throughput characterization of polymeric sensor materials, documentation DVD-R", Directory: DVD-R:\Design\Electrodes, Availability: University of Regensburg, contact person: Prof. V. M. Mirsky
- [148] Test clamp socket, Yamaichi Electronics USA, Inc., Internet address:
<http://www.yamaichi.com/>
- [149] Schott, "Piston Burette TITRONIC universal, Operating instructions" **Version 990709 M**, 2001
- [150] Kulikov, V., "Automated system for combinatorial synthesis and high-throughput characterization of polymeric sensor materials, documentation DVD-R", Directory: DVD-R:\Design\Dosing Station, Availability: University of Regensburg, contact person: Prof. V. M. Mirsky
- [151] Kulikov, V., "Automated system for combinatorial synthesis and high-throughput characterization of polymeric sensor materials, documentation DVD-R", Directory: DVD-R:\Design\Interface board, Availability: University of Regensburg, contact person: Prof. V. M. Mirsky
- [152] Kulikov, V., "Automated system for combinatorial synthesis and high-throughput characterization of polymeric sensor materials, documentation DVD-R", Directory: DVD-R:\Design\Multiplexer 96, Availability: University of Regensburg, contact person: Prof. V. M. Mirsky
- [153] Yang R., Qian Z. and Deng J., "Electrochemical deposition of Prussian blue from a single ferricyanide solution", *Journal of the Electrochemical Society* **145**, 2231-2236, 1998
- [154] Solid-state relays, Solid State Optronics, Internet address:
www.ssousa.com
- [155] Microcontrollers, Atmel Corporation, Internet address:
www.atmel.com
- [156] AT Mega AVR-ISP programmer, Microcomputer Technology (Mite), Internet address:
<http://www.mite.cz>
- [157] Kulikov, V., "Automated system for combinatorial synthesis and high-throughput characterization of polymeric sensor materials, documentation DVD-R", Directory: DVD-R:\Design\Thermostat, Availability: University of Regensburg, contact person: Prof. V. M. Mirsky
- [158] ANALOG & MIXED SIGNAL ICs, Maxim Integrated Products, 120 San Gabriel Drive Sunnyvale CA 94086 408-737-7600, Internet address: www.maxim.de

- [159] Kulikov, V., "Automated system for combinatorial synthesis and high-throughput characterization of polymeric sensor materials, documentation DVD-R", Directory: DVD-R:\Software\CEP, Availability: University of Regensburg, contact person: Prof. V. M. Mirsky
- [160] Kulikov, V., "Automated system for combinatorial synthesis and high-throughput characterization of polymeric sensor materials, documentation DVD-R", Directory: DVD-R:\Software\library, Availability: University of Regensburg, contact person: Prof. V. M. Mirsky
- [161] Hoogenboom R., Meier M.A.R. and Schubert U.S., "Combinatorial methods, automated synthesis and high-throughput screening in polymer research: Past and present", *Macromolecular Rapid Communications* **24**, 15-32, 2003
- [162] Schultz P.G. and Xiang X.D., "Combinatorial approaches to materials science", *Current Opinion in Solid State & Materials Science* **3**, 153-158, 1998
- [163] Koinuma H., "Combinatorial materials research projects in Japan", *Applied Surface Science* **189**, 179-187, 2002
- [164] Schmatloch S., Meier M.A.R. and Schubert U.S., "Instrumentation for combinatorial and high-throughput polymer research: A short overview", *Macromolecular Rapid Communications* **24**, 33-46, 2003
- [165] Lam K.S. and Renil M., "From combinatorial chemistry to chemical microarray", *Current Opinion in Chemical Biology* **6**, 353-358, 2002
- [166] McFarland E.W. and Weinberg W.H., "Combinatorial approaches to materials discovery", *Trends in Biotechnology* **17**, 107-115, 1999
- [167] Tuchbreiter A., Marquardt J., Kappler B., Honerkamp J., Kristen M.O. and Mulhaupt R., "High-output polymer screening: Exploiting combinatorial chemistry and data mining tools in catalyst and polymer development", *Macromolecular Rapid Communications* **24**, 47-62, 2003
- [168] Gabriel C., Lilge D. and Kristen M.O., "Automated Raman spectroscopy as a tool for the high-throughput characterization of molecular structure and mechanical properties of polyethylenes", *Macromolecular Rapid Communications* **24**, 109-112, 2003
- [169] Iden R., Schrof W., Hädeler J. and Lehmann S., "Combinatorial materials research in the polymer industry: Speed versus flexibility", *Macromolecular Rapid Communications* **24**, 63-72, 2003
- [170] Sormana J.L. and Meredith J.C., "High-throughput screening of mechanical properties on temperature-gradient polyurethaneurea libraries", *Macromolecular Rapid Communications* **24**, 118-122, 2003
- [171] Hoogenboom R., Fijten M.W.M., Meier M.A.R. and Schubert U.S., "Living cationic polymerizations utilizing an automated synthesizer: High-throughput synthesis of polyoxazolines", *Macromolecular Rapid Communications* **24**, 92-97, 2003
- [172] Pasch H. and Kilz P., "Fast liquid chromatography for high-throughput screening of polymers", *Macromolecular Rapid Communications* **24**, 104-108, 2003
- [173] Hoogenboom R., Fijten M.W.M., Brundli C., Schroer J. and Schubert U.S., "Automated parallel temperature optimization and determination of activation energy for the living

- cationic polymerization of 2-ethyl-2-oxazoline", *Macromolecular Rapid Communications* **24**, 98-103, 2003
- [174] Neffati R., Alexeev A., Saunin S., Brokken-Zijp J.C.M., Wouters D., Schmatloch S., Schubert U.S. and Loos J., "Automated scanning probe microscopy as a new tool for combinatorial polymer research: Conductive carbon black/poly(dimethylsiloxane) composites", *Macromolecular Rapid Communications* **24**, 113-117, 2003
- [175] Maier W.F., "Combinatorial chemistry in catalysis and materials research", *Chemie Ingenieur Technik* **75**, 1048-, 2003
- [176] Miasik J.J., Hooper A. and Tofield B.C., "Conducting polymer gas sensors", *J. Chem. Soc., Faraday Trans. 1* **82**, 1117-1126, 1986
- [177] Ingleby P., Gardner J.W. and Bartlett P.N., "Effect of micro-electrode geometry on response of thin-film poly(pyrrole) and poly(aniline) chemoresistive sensors", *Sensors and Actuators, B: Chemical* **B57**, 17-27, 1999
- [178] Harris P.D., Arnold W.M., Andrews M.K. and Partridge A.C., "Resistance characteristics of conducting polymer films used in gas sensors", *Sensors and Actuators, B: Chemical* **B42**, 177-184, 1997
- [179] Keithley Instruments.Inc., "Low Level Measurements, Precision DC Current, Voltage and Resistance Measurements" **5**, 1998
- [180] Keithley, "Model 2000 Multimeter User's manual" **Rev.G**, 2003
- [181] Kulikov, V., "Equipment for combinatorial electropolymerization and high-throughput screening of electrical properties of the synthesized polymers and polymeric structures, documentation DVD-R", Directory: DVD-R:\Design\Gas Cell, Availability: University of Regensburg, contact person: Prof. V. M. Mirsky
- [182] Kulikov, V., "Automated system for combinatorial synthesis and high-throughput characterization of polymeric sensor materials, documentation DVD-R", Directory: DVD-R:\Software\ARYMS, Availability: University of Regensburg, contact person: Prof. V. M. Mirsky
- [183] Agilent Technologies, Inc., "HP VEE 6 Windows ® Help", Directory: -, Availability: Agilent VEE software package
- [184] Kulikov, V., "Automated system for combinatorial synthesis and high-throughput characterization of polymeric sensor materials, documentation DVD-R", Directory: DVD-R:\Kombisens, Availability: University of Regensburg, contact person: Prof. V. M. Mirsky
- [185] Scheying G., Schulte T., Brinz T., Kulikov V. and Mirsky V., "Procedure and device for the production and examination of group arrangements [Machine Translation]" **2001-10131581**, 10-20020321, 2002
- [186] Trojanowicz M., Lewenstam A., Krawczyk T.K.V., Lahdesmaki I. and Szczepek W., "Flow injection amperometric detection of ammonia using a polypyrrole-modified electrode and its application in urea and creatinine biosensors", *Electroanalysis* **8**, 233-243, 1996
- [187] Krawczynski vel Drawczyk T., Trojanowicz M., Lewenstam A. and Moszczynska A., "Lactate solid-state biosensor with multilayer of electrodeposited polymers for flow-injection clinical analysis", *Biosensors & Bioelectronics* **11**, 1155-1165, 1996

- [188] Trojanowicz M., Geschke O., Krawczynski vel Krawczyk T. and Cammann K., "Biosensors based on oxidases immobilized in various conducting polymers", *Sensors and Actuators, B: Chemical* **B28**, 191-199, 1995
- [189] Silber A., Hampp N. and Schuhmann W., "Poly(methylene blue)-modified thick-film gold electrodes for the electrocatalytic oxidation of NADH and their application in glucose biosensors", *Biosensors & Bioelectronics* **11**, 215-223, 1996
- [190] Dequaire M. and Heller A., "Screen Printing of Nucleic Acid Detecting Carbon Electrodes", *Analytical Chemistry* **74**, 4370-4377, 2002
- [191] Emr S.A. and Yacynych A.M., "Use of Polymer-Films in Amperometric Biosensors", *Electroanalysis* **7**, 913-923, 1995
- [192] Panasyuk T.L., Mirsky V.M., Piletsky S.A. and Wolfbeis O.S., "Electropolymerized molecularly imprinted polymers as receptor layers in a capacitive chemical sensors", *Analytical Chemistry* **71**, 4609-4613, 1999
- [193] Situmorang M., Gooding J.J., Hibbert D.B. and Barnett D., "Electrodeposited polytyramine as an immobilisation matrix for enzyme biosensors", *Biosensors & Bioelectronics* **13**, 953-962, 1998
- [194] Barisci J.N., Conn C. and Wallace G.G., "Conducting polymer sensors", *Trends Polym. Sci. (Cambridge, U. K.)* **4**, 307-311, 1996
- [195] Bidan G., Billon M., Galasso K., Livache T., Mathis C., Roget A., Torres-Rodriguez L.M. and Vieil E., "Electropolymerization as a versatile route for immobilizing biological species onto surfaces - Application to DNA biochips", *Applied Biochemistry and Biotechnology* **89**, 183-193, 2000
- [196] Quinto M., Losito I., Palmisano F. and Zambonin C.G., "Disposable interference-free glucose biosensor based on an electropolymerised poly(pyrrole) permselective film", *Analytica Chimica Acta* **420**, 9-17, 2000
- [197] Yon-Hin B.F.Y., Smolander M., Crompton T. and Lowe C.R., "Covalent electropolymerization of glucose oxidase in polypyrrole. Evaluation of methods of pyrrole attachment to glucose oxidase on the performance of electropolymerized glucose sensors", *Analytical Chemistry* **65**, 2067-2071, 1993
- [198] Reiter S., Habermuller K. and Schuhmann W., "A reagentless glucose biosensor based on glucose oxidase entrapped into osmium-complex modified polypyrrole films", *Sensors and Actuators, B: Chemical* **B79**, 150-156, 2001
- [199] Schuhmann W., "Amperometric enzyme biosensors based on optimized electron-transfer pathways and non-manual immobilization procedures", *Reviews in Molecular Biotechnology* **82**, 425-441, 2002
- [200] Bidan G., Billon M., Livache T., Mathis G., Roget A. and Torres-Rodriguez L.M., "Conducting polymers as a link between biomolecules and microelectronics", *Synthetic Metals* **102**, 1363-1365, 1999
- [201] Panasyuk T.L., Mirsky V.M., Piletsky S.A. and Wolfbeis O.S., "Electropolymerized molecularly imprinted polymers as receptor layers in a capacitive chemical sensors", *Analytical Chemistry* **71**, 4609-4613, 1999

- [202] Panasyuk T., Dall'Orto V.C., Marrazza G., El'skaya A., Piletsky S., Rezzano I. and Mascini M., "Molecular imprinted polymers prepared by electropolymerization of Ni-(protoporphyrin IX)", *Analytical Letters* **31**, 1809-1824, 1998
- [203] Cheng Z., Wang E. and Yang X., "Capacitive detection of glucose using molecularly imprinted polymers", *BIOSENSORS AND BIOELECTRONICS* **16**, 179-185
- [204] Peng H., Zhang Y., Zhang J., Xie Q., Nie L. and Yao S., "Development of a thickness shear mode acoustic sensor based on an electrosynthesized molecularly imprinted polymer using an underivatized amino acid as the template", *Analyst* **126**, 189-194
- [205] Malitesta C., Losito I. and Zambonin P.G., "Molecularly Imprinted Electrosynthesized Polymers: New Materials for Biomimetic Sensors", *Analytical Chemistry* **71**, 1366-1370, 1999
- [206] Farace G., Lillie G., Hianik T., Payne P. and Vadgama P., "Reagentless biosensing using electrochemical impedance spectroscopy", *Bioelectrochemistry* **55**, 1-3, 2002
- [207] Lillie G., Payne P. and Vadgama P., "Electrochemical impedance spectroscopy as a platform for reagentless bioaffinity sensing", *Sensors and Actuators, B: Chemical* **B78**, 249-256, 2001
- [208] Bernius M., Inbasekaran M., Woo E., Wu W. and Wujkowski L., "Light-emitting diodes based on fluorene polymers", *Thin Solid Films* **363**, 55-57, 2000
- [209] Bernius M.T., "Organic light emitting diodes on plastic substrates" **2002-US2886**, 16-20020822
- [210] Mitschke U. and Bauerle P., "The electroluminescence of organic materials", *Journal of Materials Chemistry* **10**, 1471-1507, 2000
- [211] Herguth P., Jiang X., Liu M.S. and Jen A.K.Y., "Highly Efficient Fluorene- and Benzothiadiazole-Based Conjugated Copolymers for Polymer Light-Emitting Diodes", *Macromolecules* **35**, 6094-6100, 2002
- [212] Torsi L., Malitesta C., Sabbatini L., Zambonin P.G., Dodabalapur A. and Katz H.E., "Schottky diodes and field-effect transistors based on conjugated thiophenes", *Materials Science & Engineering, C: Biomimetic Materials, Sensors and Systems* **C5**, 233-236, 1998
- [213] Torsi L., Malitesta C., Morea G., Sabbatini L. and Zambonin P.G., "Analytical investigation on electrosynthesized polymer/silicon interfaces", *Ann. Chim. (Rome)* **82**, 259-274, 1992
- [214] Horowitz G., Fichou D., Peng X., Xu Z. and Garnier F., "A field-effect transistor based on conjugated alpha-sexithienyl", *Solid State Commun.* **72**, 381-384, 1989
- [215] Sandifer J.R. and Voychek J.J., "A review of biosensor and industrial applications of pH-ISFETs and an evaluation of Honeywell's \"DuraFET\"", *Mikrochimica Acta* **131**, 91-98, 1999
- [216] Janata J., "Twenty years of ion-selective field-effect transistors", *Analyst (Cambridge, United Kingdom)* **119**, 2275-2278, 1994
- [217] Van der Schoot B.H. and Bergveld P., "ISFET based enzyme sensors", *Biosensors* **3**, 161-186, 1988

9 List of abbreviations

2B	Relay switch configuration (two normally closed contacts)
2W / 3W	Two-way valve / three-way valve
3-ABA	3-Aminobenzoic acid
3-ABBA	3-Aminobenzoboric acid
3-ABSA	3-Aminobenzenesulfonic acid
4A	relay switch configuration (four normally open contacts)
4-ABA	4-Aminobenzoic acid
A/D	Analog / Digital
AA	Anthranilic acid
ACK	Acknowledge signal
ARYMS	ARraY MeaSurement software
Au	Gold
BNC	British Naval Connector or Bayonet Nut Connector
CEP	Combinatorial Electro-Polymerization software
CL1, CL2	Reservoirs for cleaning solvents
D/A	Digital / Analog
DIP	Dual Inline Package
DNA	Deoxyribonucleic acid
DP	Dosing pump
DS	Dosing Station
EA	Electrode Array
EC	Electrochemical Cell
EP	Electropolymerization
FT-IR	Furrier transformation Infrared spectroscopy
GC	Gas Cell
GP-IB	General Purpose Interface Bus
HCl	Hydrogen Chloride
HF	Hydrogenfluoric acid
IB	Interface Board
IDT	Interdigital electrode
IDT2	Interdigital electrode, two-strips (for two-point conductance measurement)
IDT4	Interdigital electrode, four-strips (for four-point conductance measurement)

List of abbreviations

ISA	Industry Standard Architecture
ISP	In-System programming
LCD	Liquid crystal display
MALDI-TOF	Matrix Assisted Laser Desorption Ionization Time-of-flight Mass Spectrometry
MB	Main Board of the MX96
MC	Mixing Chamber
MCU	Microcontroller Unit
MX96	Multiplexer 96
NMR	Nuclear magnetic resonance
OLED	Organic Light Emitting diode
opto-MOSFET	Optical Metal-Oxide-Semiconductor Field Effect Transistor
P(ANI-3ABA)	Poly(aniline-3-aminobenzoic acid)
P(ANI-3ABBA)	Poly(aniline-3-aminobenzoboric acid)
PANI	Polyaniline
PC	Personal Computer
PCB	Printed Circuit Board
PCI	Peripheral Component Interconnect
PCV	Polymerization Constant Voltage
PES	Polyethersulphone
PLED	Polymeric Light Emitting diode
Pt	Platinum
PTFE	polytetrafluoroethylene (Teflon)
SCE	Saturated calomel reference electrode
SiO ₂	Silicone dioxide
SMC	Straight plug connector
SMU	Source monitor unit
SUP	Support
TH	Thermostat
TR	Thermo-reservoir for thermostat
USB	Universal serial bus
UV lamp	Ultraviolet lamp
VEE	Visual engineering environment (Agilent)
V _p	Polymerization potential
V _x	Protection potential

10 Appendix

- Multiplexer 96 - Assembler source code
- Thermostat for electrochemical cell
- Library file description (CEP)
- Procedure file description (ARYMS)
- Combinatorial results
 - Results based on P(ANI+4ABA), library: 04-06-03-4ABA-5
 - Results based on P(ANI+3ABSA), library: 09-06-03-3ABSA
 - Results based on P(ANI+3ABA), library: 09-07-03-3ABA
 - Results based on P(ANI+AA), library: 24-05-03-AA1

10.1 Multiplexer 96 - Assembler source code

Application name: Multiplexer 96

Project: Kombisens

Author: Valentin Kulikov

Software version: 0.13 evaluation

Date: April 2003

Note: This is evaluation software for ATMEL AVR microcontroller, written under AVR assembler for prototype of Multiplexer 96 instrument supported by KOMBISENS project BOSCH BMBF Germany. This software is written for evaluation purposes of University Regensburg only not determined for sale.

Content:

main.asm	-	main assembler AVR source file
4414def.inc	-	definition file for AT90S4414 micro-controller
96chan.inc	-	procedure set channel
HD44780.inc	-	procedure display
pout.inc	-	procedure Power Out
main.apr	-	Project file (AVR Studio 3.22 [155])
DOCs folder	-	documentation files in PDF and DOC formats
tuned folder	-	first application tuned for main.asm

Used Hardware:

ATMEGA Programmer - ISP Serial programmer for ATMEL AT90S4414 [156]

Used Software:

AVR Studio 3.2 (freeware [155])

ATMEGA 3.71 (free support for ATMEL programmer AT Mega [156])

Source files and others:

included in [152]

The Assembler code follows...

10.1.1 Assembler code, main.asm

```

;**** A P P L I C A T I O N   MAIN MX96 *****
;*
;* Title:                MULTIPLEXER 96
;* Version:              0.12
;* Last Updated:         13.06.03
;* Target:               AT90S4414/8MHz
;*
;* Support E-mail:      kulikov@elf.stuba.sk
;*
;* DESCRIPTION
;* Main program
;* Registers:
;*           XH = IDATA (change only after idata sampling-strobe)
;*
;* Subroutines:
;*
;* 22.11.02 VKU: changed EP and Measurement mode level
;* 13.06.03 VKU: added short circuit test activated by char "s"
;*           HW upgraded, Measurement voltage max 5V to protect EA
;* 19.06.03 VKU: Added "Zero" offset compensation mode (includes
;*           together short circuit and EP mode, Source and sense
;*           connections shortcuted, warning high voltage and current
;*           may damage the MX96 instrument!)
;*           Changed: HW, Rel remotd by B4 (PD4-MCU), instead of B6
;*           result independent remoting of Rel (interconnec-
;*           relay for EP process, shared with zero offset)
;*****

; Interrupt service routines -----
; 1 Byte each:

.ORG $0000

; Reset-vector to Address 0000

        rjmp    main

        rjmp    data_sample ; Int0-Interrupt
        reti    ; Int1-Interrupt
        reti    ; TC1-Capture
        reti    ; TC1-Compare A
        reti    ; TC1-Compare B
        reti    ; TC1-Overflow
        reti    ; Timer/Counter 0 Overflow
        reti    ; Serial Transfer complete
        reti    ; UART Rx complete
        reti    ; UART Data register empty
        reti    ; UART Tx complete
        reti    ; Analog Comparator

.NOLIST
.include "4414def.inc"
.include "HD44780.inc"
.include "96chan.inc"
.include "pout.inc"
.LIST

;**** Register used by all programs, global variable used by all routines

;.def    temp    =r18
;.def    temp1   =r21

;.def    fine    =r18 ;loop delay counters
;.def    medium  =r19
;.def    coarse  =r17

;***** Def of the trigger signal ;*****

.EQU    trig_bit    =0

```

```

.EQU   trig_port      =PORTC

.EQU   SCUT_bit       =5      ;shortcut test 13.06.03 VKU
.EQU   EP_MEAS_bit    =6      ;electropolymerisation / measurement bit
.EQU   EP_INTC_bit    =4      ;electropolymerisation - interconnection of IDT
.EQU   EP_MEAS_port   =PORTC ;electropolymerisation / measurement port

;*****
;***** Interrupt-Service-Routine for the INTO *****

data_sample:  in      XH,PINB          ;Read Bite from PORTC

               set                          ;set T in SREG (status register)
               ;po nastaveni sa porovnaava ci
               ;prebehlo prerusenie - power out
               ;modul (jedna z moznosti)
               reti                       ;Return from interrupt
               ;Nacitanie riadiaceho znaku,
               ;pri jeho zmene prebehne
               ;kompletna procedura v main

;***** main program *****

main:         ldi      temp,high(RAMEND)    ;Initialise STACK
               out     SPH,temp            ;High byte only req. if
               ldi     temp,low(RAMEND)    ;RAM is bigger than 256B
               out     SPL,temp            ;imp. for rcall jumps def

;***** set direction of all PORTs *****

               ldi     temp,0xFF           ;initialise port A
               out     DDRA,temp

               ldi     temp,0x00           ;initialise port B as in I/O
               out     DDRB,temp

               ldi     temp,0xFF           ;initialise port C
               out     DDRC,temp

               ldi     temp,0xF3           ;initialise port D
               out     DDRD,temp

;***** RESET all PORTs *****

               ldi     temp,0x00           ;enable pull up on PD2 and
               out     PORTA,temp          ;PORT A
               out     PORTB,temp          ;PORT B
               out     PORTC,temp          ;PORT C
               out     PORTD,temp          ;PORT D

               ;sbi    trig_port,trig_bit  ;set trigger signal to 0
               ;efekt na zaciatku blikne LED
LCD_init      clt                          ;LCD init. - Software RESET
               ;clear T in SREG

               ;cbi    trig_port,trig_bit  ;set trigger signal to 1

;***** SET interrupts *****

               ldi     temp,0x03           ;in Timer Interrupt Mask Reg.
               out     MCUCR,temp

               ldi     temp,0x40           ;rising edge
               out     GIMSK,temp

               ldi     temp,0xC0           ;write 11000000 into GIFR
               out     GIFR,temp          ;tymto sa zmazu INTF0 a1
               ;a neprebehne zbztocne
               ;prerusenie, zapis 1 je

```

Appendix

```
                                ;stand. postup...

sei                                ;enable global interupts

;***** Display LOGO *****
LCD_clear                          ;Clear LCD
LCD_string logo1                    ;write first line to LCD
nextline                          ;go to next line (2) of LCD
LCD_string logo2                    ;write second line to LCD

;***** loop - waiting for interupt T flag checked *****

ldi    XH,0x00

again:    brtc    again                ;if T cleared repeat (nastavi sa
                                ;na 1 po vykonani preeusenia
                                ;prebehne program a usku-
                                ;tocnia sa pozadovane nastavenia
                                ;po skonceni procedury sa musi
                                ;vynulovat!

cli                                ;disable global interupts

;***** IDATA == 0x00 All channels switch off *****

IDATA0:    ldi    temp,0x00
cp        XH,temp                    ;compare XH with 0x00
brne     off_end                    ;if IDATA (XH != 0x00) then skip

SET_off    ;switch all 96 outputs to off

cbi    trig_port,trig_bit            ;set triger signal to 1

nextline    ;Warning message
LCD_string chan_off                ;Command not supported
rjmp    quit

off_end:    ;continue in fol. coparision

;***** 0 < IDATA <= 96 switch on one channel *****

cbi    trig_port,trig_bit            ;set triger signal to 1

ldi    temp,97
cp        XH,temp                    ;compre XH with 97
brsh    chan_end                    ;if IDATA (XH >= 97) then skip

mov    temp,XH                      ;XH copy to temp
rcall  SET_channel                  ;switch on required channel

rcall  dly_start                    ;start timer

mov    temp,XH                      ;XH copy to temp
nextline    ;skip to next line of LCD
LCD_string channel                  ;write string to LCD
cursor_position                    ;set cursor on channel poss.
display_channel                    ;display set channel

rcall  dly_finish                    ;wait until delay is reached

sbi    trig_port,trig_bit            ;set triger signal to 0

rcall  delay_2ms

rjmp    quit

chan_end:

;***** IDATA == 0x70 'p' set epolym. mode *****

EPOLYM0:    ldi    temp,0x70
cp        XH,temp                    ;compare XH with 0x70
brne     ep_end                    ;if IDATA (XH != 0x70) then skip
```

```

sbi    EP_MEAS_port,EP_MEAS_bit ;1 = Electropolymerisation mode
sbi    EP_MEAS_port,EP_INTC_bit ;1 = IDT interconnection on
cbi    EP_MEAS_port,SCUT_bit  ;0 = Short circuit test mode off

firstline                ;set cursor to 0 position

LCD_string epolym        ;display epolym message
rjmp   quit

ep_end:                  ;continue in fol. coparision

;***** IDATA == 0x6D 'm' set measurement mode *****
MEAS0:    ldi    temp,0x6D
          cp     XH,temp                ;compare XH with 0x6D
          brne  meas_end                ;if IDATA (XH != 0x6D) then skip

          cbi    EP_MEAS_port,EP_MEAS_bit ;0 = Measurement mode
          cbi    EP_MEAS_port,EP_INTC_bit ;0 = IDT interconnect off
          cbi    EP_MEAS_port,SCUT_bit  ;0 = Short circuit test mode off

          firstline                ;set cursor to 0 position

          LCD_string meas            ;display epolym message
          rjmp   quit

meas_end:                ;continue in fol. coparision

;***** IDATA == 0x73 's' set shortcut test mode *****
; updated 13.06.03 VKU
SCUT0:    ldi    temp,0x73
          cp     XH,temp                ;compare XH with 0x6D
          brne  scut_end                ;if IDATA (XH != 0x6D) then skip
          cbi    EP_MEAS_port,EP_MEAS_bit ;0 = Measurement mode
          sbi    EP_MEAS_port,SCUT_bit  ;1 = Short circuit test mode on
          cbi    EP_MEAS_port,EP_INTC_bit ;0 = IDT interconnect off
          firstline                ;set cursor to 0 position

          LCD_string scut            ;write 2nd string to LCD
          rjmp   quit

scut_end:                ;continue in fol. coparision

;***** IDATA == 0x7A 'z' set "zero" offset mode *****
; updated 19.06.03 VKU
ZERO:     ldi    temp,0x7A
          cp     XH,temp                ;compare XH with 0x6D
          brne  zero_end                ;if IDATA (XH != 0x6D) then skip
          cbi    EP_MEAS_port,EP_MEAS_bit ;0 = Measurement mode
          sbi    EP_MEAS_port,EP_INTC_bit ;1 = IDT interconnect on
          sbi    EP_MEAS_port,SCUT_bit  ;1 = Short circuit test mode on

          firstline                ;set cursor to 0 position

          LCD_string zero1            ;write 1st string to LCD

          nextline                    ;skip to next line of LCD

          LCD_string zero2            ;write 2nd string to LCD

          rjmp   quit

zero_end:                ;continue in fol. coparision

;***** IDATA == 0x6F 'o' Power out *****
          ldi    temp,0x6F                ;Power Out 'o' 0x6F
          cp     XH,temp
          brne  out_end

          LCD_clear
          LCD_string pout1            ;write string to LCD

          sei
          clt                            ;clear T in SREG

againo:   brtc   againo                ;branch if T flag cleared

```

Appendix

```
                                ;ak sa objavi int potom
                                ;bude nastaveny T <- 1

cli
mov    temp,XH
rcall  POUT_WRITE

nextline                ;skip to next line of LCD
LCD_string pout2        ;write string to LCD
rcall  out_status
rjmp   quit

out_end:

;***** IDATA == 0x72 'r' software RESET *****
                                ;RESET 'r' 0x72
                                ;need about 55ms
ldi    temp,0x72
cp     XH,temp
brne   reset_end
LCD_clear                ;clear LCD
rjmp   main

reset_end:

;***** IDATA == 0x69 'i' info *****
                                ;info 'i' 0x69
                                ;need about 55ms
ldi    temp,0x69
cp     XH,temp
brne   info_end

LCD_clear                ;Clear LCD
LCD_string info1        ;write first line to LCD
nextline                ;go to next line (2) of LCD
LCD_string info2        ;write second line to LCD

rjmp   quit

info_end:

;***** IDATA == not defined warning message *****

comm_nsup:  firstline        ;set cursor on position 0
LCD_string cmns1        ;Command not supported
nextline        ;! last check
LCD_string cmns2

;***** before repeat *****

quit:      mov temp,XH        ;nast. zhod. hod. do tempu !
           clt                ;clear T in SREG
           sei                ;enable global interrupts
           rjmp again        ;tempu !

;***** Sobroutines *****

;*****
;* Exact timer 45ms
;* do prescaler registru sa zapise preddefinovany stav pocitadla ku ktoremu
;* sa po spusteni casovaca priratava. Tot sa deje pokzmn nastane
;* pretecenie a citac sa nevznuluje v TIFR registre sa nastavý overflow
;* flag ktory sa detekuje pomocou dly_finish subrutiny. V podstate bezi
;* samotny program a v pozadi je spusteny casovac. po skonceni programu
;* sa caka def. cas... (pouzite pre trigger signal - oneskorenie)
;*****

dly_start:  ldi    temp,0x00        ;OC1A,B outputs set off      !
           out    TCCR1A,temp

           ldi    temp,0x0D        ;Start triger with prescaller
           out    TCCR1B,temp        ;prescaler = 1024

           ldi    temp,0xFE        ;prescaled value high bit
           out    TCNT1H,temp        ;delay(us) = 2^16-1024*0,temp

           ldi    temp,0xA0        ;prescaled value low bit
           out    TCNT1L,temp
```

```

ret

dly_finish:  in    temp,TIFR
             sbrs  temp,7
             rjmp  dly_finish
             ldi   temp,0x00           ;Stop counter
             out   TCCR1B,temp
             ldi   temp,0x80           ;Stop counter
             out   TIFR,temp          ;clear int T1 flag (jedna z moznosti
                                     ;je prepisat jednotku jednotkou

             ret

; source END

```

10.1.2 MX96 assembler code, HD44780.inc

```

;**** A P P L I C A T I O N   HD44780 *****
;*
;* Title:                HD44780 subroutine
;* Version:              1.0
;* Last Updated:        15.3.01, 13.06.03
;* Target:              4414
;*
;* Support E-mail:     kulikov@elf.stuba.sk
;*
;* DESCRIPTION
;* This Application remotes the HD44780 LCD display
;* 13.06.03 short circuit test mode message, ver of MX96 0.12
;* 19.06.03 "Zero" offset mode messages, ver of MX96 0.13
;*****

;**** Register used by all programs, global variable used by all routines

.def    temp    =r16    ;general scratch space
;.def    temp1   =r17    ;interchange space
;.def    temp2   =r18

.def    short   =r24    ;delay template
.def    long    =r25    ;delay template
;.include "4414def.inc"

;**** LCD signal & instruction definition for 4 bit operation *****

.equ    LCD_RS  =0      ;LCD H=data input, L=instruction code input
;.equ    LCD_RW  =6      ;LCD H=data read, L=data write - not used default: L
.equ    LCD_E   =1      ;LCD H, H->L=enable signal

.equ    LCD_DB4 =0      ;LCD data bit 4
.equ    LCD_DB5 =1      ;LCD data bit 5
.equ    LCD_DB6 =2      ;LCD data bit 6
.equ    LCD_DB7 =3      ;LCD data bit 7

.equ    CLDISP  =\$01    ;Clear display
.equ    CHOME   =\$02    ;LCD data bit 4
.equ    CH_ADR  =\$C6    ;cursor address for No of channel
                       ;(chan: XXX). Moznosti: 0=Off, 1-96

logo1:   .db    " MULTIPLEXER 96 ",0
logo2:   .db    "Ver.0.13 VKU2001",0

info1:   .db    "Design & Real.by",0
info2:   .db    "V.Kulikov VKU01",0

epolym:  .db    "El-Polymer. mode",0
meas:    .db    "Measurement mode",0
pout1:   .db    "Output: 12345678",0
pout2:   .db    "status: ",0

channel: .db    "Chan:          ",0

```

Appendix

```
cmns1:      .db    "Warning: Command",0
cmns2:      .db    "not supported  ",0

chan_off:   .db    "Chan: all off  ",0

scut:       .db    "Short circ. test",0

zerol:      .db    "Zero offset mode",0

zero2:      .db    "HIGH I,V damage!",0

rjmp lcd_qiut

.MACRO display_channel
;*****
;* MACRO
;* send number of channel into LCD in dec by two digits
;*
;* Input:
;*     XH register - value of the channel from 0 to 96
;*****
        mov     ZL,XH
        clr     ZH                ;Clear ZL (pouziije sa na vypocet
                                ;desiatkoveho digitu)
decade:   cpi     ZL,10           ;Compare ZH with 10
          brlt   single          ;Branch if Less Than, Signed
                                ;if ZH < 10 then skip to last_digit
          inc    ZH                ;ZL=ZL+1 (desiatky)
          subi   ZL,10           ;ZH=ZH-10
          rjmp   decade          ;jump to decade (zopakuj cyklus)
single:   cbi     PORTD,LCD_RS    ;RS to 0 => input instructions
          ldi    temp,CH_ADR      ;Set cursor position
          rcall  LCD_WRITE
          sbi    PORTD,LCD_RS    ;RS to 1 => input data

          ldi    YH,0x30          ;LCD shift 30=0...39=9
          add    ZH,YH
          mov    temp,ZH
          rcall  LCD_write        ;first digit

          ldi    YL,0x30          ;LCD shift 30=0...39=9
          add    ZL,YL
          mov    temp,ZL
          rcall  LCD_write        ;second digit

.ENDMACRO

.MACRO LCD_init
;*****
;* MACRO
;* HD44780 initialisation MACRO- software RESET
;* Standrd procedure described in operational manual
;*****
back:     ldi    temp,25          ;wait 50ms
          rcall  delay_2ms       ;until VCC is reached
          dec    temp
          brne  back

          ldi    temp,0x30        ;set 4b com
          rcall  LCD_WRITE
back3:    ldi    temp,4           ;wait >4.1 ms
          rcall  delay_2ms
          dec    temp
          brne  back3

          ldi    temp,0x30        ;standard software RESET
          rcall  LCD_WRITE        ;procedura pre HD44780
          rcall  delay_2ms

          ldi    temp,0x30
          rcall  LCD_WRITE

          ldi    temp,0x30        ;set 4b com
          rcall  LCD_WRITE
```

```

        ldi    temp,0x28            ;LCD parameters
        rcall LCD_WRITE

        ldi    temp,CLDISP        ;clear LCD
        rcall LCD_WRITE
        rcall delay_2ms          ;! delay !>1.7ms

        ldi    temp,0x06          ;set cursor move direction
        rcall LCD_WRITE

        ldi    temp,0x0C          ;LCD on, cursor off
        rcall LCD_WRITE

        ldi    temp,0x06          ;set cursor move dirrection
        rcall LCD_WRITE

.ENDMACRO

.MACRO LCD_string
;*****
;* MACRO
;* Load word from data memory
;* Load the address of 'message' into the Z register. Multiplies
;* word address with 2 to achieve the byte address, and uses the
;* functions high() and low() to calculate high and low address byte.
;*   USAGE: Call macro
;*   LCD_string <message address> (ex. logol)
;*   MEANING:
;*   ldi    ZH,high(2*message1)    ;Load high part of byte address into ZH
;*   ldi    ZL,low(2*message1)    ;Load low part of byte address into ZL
;*   byte, stored in SRAM in specified address is stored into r0 register
;*
;*****

        sbi    PORTD,LCD_RS        ;RS to 1 => input data
        ldi    ZH,high(2*@0)      ;Load high part of byte address into ZH
        ldi    ZL,low(2*@0)      ;Load low part of byte address into ZL
        ;Syntax MACRO @0 - prva premenna za naz
        ;macra pri volani (LCD_string logol))
LCD_STR:    lpm                    ;Load byte from program memory into r0
            tst    r0              ;Check if we've reached the end of the
;message
            breq   STREND          ;If so, quit
            mov    temp,r0         ;copy r0 to temp
            rcall LCD_WRITE        ;send byte into LCD
            adiw  ZL,1             ;Increase Z registers
            rjmp  LCD_STR

STREND:
.ENDMACRO

.MACRO nextline
;*****
;* MACRO
;*
;* Shift cursor of the LCD display on to second line
;*****

        cbi    PORTD,LCD_RS        ;RS to 0 => input instructions
        ldi    temp,0xC0
        rcall LCD_WRITE
        sbi    PORTD,LCD_RS        ;RS to 1 => input data

.ENDMACRO

.MACRO firstline
;*****
;* MACRO
;*
;* Shift cursor of the LCD display on to 0 position of LCD
;*****

        cbi    PORTD,LCD_RS        ;RS to 0 => input instructions
        ldi    temp,0x80
        rcall LCD_WRITE
        sbi    PORTD,LCD_RS        ;RS to 1 => input data

```

Appendix

```
.ENDMACRO

.MACRO cursor_position
;*****
;* MACRO - cur. not used
;*
;* Shift cursor of the LCD display on to position given by CH_ADR
;* pre prepisovanie hodnoty kanalu 2-3 cislice v texte na LCD
;*****

        cbi    PORTD,LCD_RS        ;RS to 0 => input instructions
        ldi    temp,CH_ADR
        rcall  LCD_WRITE
        sbi    PORTD,LCD_RS        ;RS to 1 => input data

.ENDMACRO

.MACRO LCD_clear
;*****
;* MACRO
;* Clear LCD Display and shift onto first position
;*****

        cbi    PORTD,LCD_RS        ;RS to 0 => input instructions
        ldi    temp,CLDISP        ;clear LCD
        rcall  LCD_WRITE
        rcall  delay_2ms          ;! delay !>1.7ms

        ldi    temp,0x06          ;set cursor move direction
        rcall  LCD_WRITE

        ldi    temp,0x0C          ;LCD on, cursor off
        rcall  LCD_WRITE

        ldi    temp,0x06          ;set cursor move direction
        rcall  LCD_WRITE
        sbi    PORTD,LCD_RS        ;RS to 1 => input data

.ENDMACRO

.LISTMAC

LCD_WRITE:

        cbi    PORTD,7            ;RESET of 4 LCD data bit on PORTD
        cbi    PORTD,6
        cbi    PORTD,5
        cbi    PORTD,4
        sbrc   temp,7
        sbi    PORTD,7
        sbrc   temp,6
        sbi    PORTD,6
        sbrc   temp,5
        sbi    PORTD,5
        sbrc   temp,4
        sbi    PORTD,4

        sbi    PORTD,LCD_E
        nop
        nop
        cbi    PORTD,LCD_E

        cbi    PORTD,7            ;RESET of 4 LCD data bit on PORTD
        cbi    PORTD,6
        cbi    PORTD,5
        cbi    PORTD,4
        sbrc   temp,3
        sbi    PORTD,7
        sbrc   temp,2
        sbi    PORTD,6
        sbrc   temp,1
        sbi    PORTD,5
        sbrc   temp,0
        sbi    PORTD,4

        sbi    PORTD,LCD_E
        nop
```

```

nop
cbi PORTD,LCD_E

back1:    ldi long,180      ;wait 45us
         dec long
         brne back1

         ret

delay_2ms: ldi long,48      ;clock 6 = 1us
again1:   ldi short,111    ;delay app. 2ms
again2:   dec short
         brne again2
         dec long
         brne again1      ;if temp!=0 then repeat agin
         clz              ;clear Z (inak po navrate Z=1)

         sbi PORTD,LCD_E   ;19.06.03 Noise immunity better when E=1

;(strobe H->L)
         ret

lcd_qiut:

; source END

```

10.1.3 MX96 assembler code, 96chann.inc

```

;**** A P P L I C A T I O N   96 channels *****
;*
;* Title:           Remote 96 channels
;* Version:         1.0
;* Last Updated:    2.4.01
;* Target:          4414
;*
;* Support E-mail:  kulikov@elf.stuba.sk
;*
;* DESCRIPTION
;* This remotes 96 channels
;* Subroutines:
;*     SET_channel (temp)
;*     SET_off
;*****

rjmp ch_quit

SET_channel:
;*****
;* Name: SET_channel (MACRO)
;*
;* Input: temp (0<temp<97) obsah sa nezachovava
;* Vyber a nastavenie jedneho kanalu z 96
;* pomocou nastvaenia stlpca 1 z 8 a riadku 1 z 12
;* po vykonani navrat RET
;*****

;*****
;* Name: Column setting 1 of 8
;*
;* Input: temp (0<temp<97) obsah sa nezachovava
;* Vyber a nastavenie jedneho stlpca z 8 pomocou Dekoderu 1 z 8 - 74138
;* MX96 obsahuje 8 analogovych dosiek, na kazdej z nich je 12 Rele
;*****
C7:
         sbi PORTA,6      ;column 7 (value: 96-85) / 12 lines
         clc             ;enable demx 138 (G1) (zarad na koniec!)
         cpi temp,85     ;clear Carry (C<-0)
         brcs C6        ;comp. if temp<85 then C is set
         sbi PORTA,0     ;branch if carry bit cleared
         sbi PORTA,1     ;set demx 138 address b111 - out7:
         sbi PORTA,2     ;PORT A : 0 1 2
         subi temp,84    ;input 138: A B C
         rjmp LINE      ;subtract 84 dec from temp (zo zvisku
                        ;sa urcuje riadok 1 z 12 v rutine LINE)

```

Appendix

```
C6:          cpi temp,73 ;column 6 (value: 84-73) / 12 lines
            brcs C5
            cbi PORTA,0
            sbi PORTA,1
            sbi PORTA,2
            subi temp,72
            rjmp LINE

C5:          cpi temp,61 ;column 5 (value: 72-61) / 12 lines
            brcs C4
            sbi PORTA,0
            cbi PORTA,1
            sbi PORTA,2
            subi temp,60
            rjmp LINE

C4:          cpi temp,49 ;column 4 (value: 60-49) / 12 lines
            brcs C3
            cbi PORTA,0
            cbi PORTA,1
            sbi PORTA,2
            subi temp,48
            rjmp LINE

C3:          cpi temp,37 ;column 3 (value: 48-37) / 12 lines
            brcs C2
            sbi PORTA,0
            sbi PORTA,1
            cbi PORTA,2
            subi temp,36
            rjmp LINE

C2:          cpi temp,25 ;column 2 (value: 36-25) / 12 lines
            brcs C1
            cbi PORTA,0
            sbi PORTA,1
            cbi PORTA,2
            subi temp,24
            rjmp LINE

C1:          ;column 1 (value: 24-13) / 12 lines
            cpi temp,13
            brcs C0
            sbi PORTA,0
            cbi PORTA,1
            cbi PORTA,2
            subi temp,12
            rjmp LINE

C0:          cbi PORTA,0 ;column 0 (value: 12-1) / 12 lines
            cbi PORTA,1
            cbi PORTA,2
            nop

;*****
;* Name: Line setting 1 of 12
;*
;* Input: temp (0<temp<13) obsah sa nemeni
;* Vyber a nastavenie jedneho riadku z 12 pomocou Dekoderov 1 z 8 - 74238
;*****
LINE:          ;line set
L0:          cpi temp,1
            brne L1 ;if Z!=1 (Z==0) then branch to L1
            cbi PORTA,3 ;input A of 74238 cleared
            cbi PORTA,4 ;input B of 74238 cleared
            cbi PORTA,5 ;input C of 74238 cleared
            ;set 000 -> Decode bit 0 of 74238
            sbi PORTA,7 ;enable decoder 1 (prvych 8 riadkov)
            cbi PORTC,7 ;disable decoder 2 (posledne 4 riadky)

L1:          cpi temp,2
            brne L2
            sbi PORTA,3
            cbi PORTA,4
```

```

cbi PORTA,5

sbi PORTA,7
cbi PORTC,7

L2:    cpi temp,3
       brne L3
       cbi PORTA,3
       sbi PORTA,4
       cbi PORTA,5

       sbi PORTA,7
       cbi PORTC,7

L3:    cpi temp,4
       brne L4
       sbi PORTA,3
       sbi PORTA,4
       cbi PORTA,5

       sbi PORTA,7
       cbi PORTC,7

L4:    cpi temp,5
       brne L5
       cbi PORTA,3
       cbi PORTA,4
       sbi PORTA,5

       sbi PORTA,7
       cbi PORTC,7

L5:    cpi temp,6
       brne L6
       sbi PORTA,3
       cbi PORTA,4
       sbi PORTA,5

       sbi PORTA,7
       cbi PORTC,7

L6:    cpi temp,7
       brne L7
       cbi PORTA,3
       sbi PORTA,4
       sbi PORTA,5

       sbi PORTA,7
       cbi PORTC,7

L7:    cpi temp,8
       brne L8
       sbi PORTA,3
       sbi PORTA,4
       sbi PORTA,5

       sbi PORTA,7
       cbi PORTC,7

L8:    cpi temp,9    ;Decoder 74238 No 2 (1 of 4)
       brne L9
       cbi PORTA,3    ;input A of 74238 cleared
       cbi PORTA,4    ;input A of 74238 cleared
       cbi PORTA,5    ;Not used set to 0

       cbi PORTA,7
       sbi PORTC,7    ;enable Decoder 74238 - 2

L9:    cpi temp,10
       brne L10
       sbi PORTA,3
       cbi PORTA,4
       cbi PORTA,5

       cbi PORTA,7
```

Appendix

```
                sbi PORTC,7
L10:            cpi temp,11
                brne L11
                cbi PORTA,3
                sbi PORTA,4
                cbi PORTA,5

                cbi PORTA,7
                sbi PORTC,7

L11:            cpi temp,12
                brne LEND
                sbi PORTA,3
                sbi PORTA,4
                cbi PORTA,5

                cbi PORTA,7
                sbi PORTC,7
                nop
LEND:           ret

.MACRO SET_off
;*****
;* Name: SET_off (MACRO)
;*
;* Input: NA
;* Vypne vsetky kanaly
;*****
                cbi PORTA,6 ;disable dec 138 (G1)
                cbi PORTA,7 ;disable dec 238-1
                cbi PORTC,7 ;disable dec 138-2

.ENDMACRO
ch_quit:
; source END
```

10.1.4 *MX96 assembler code, pout.inc*

```
;**** A P P L I C A T I O N   POWER_OUT *****
;*
;* Title:                74164 utility
;* Version:              1.0
;* Last Updated:        15.3.01
;* Target:              4414
;*
;* Support E-mail:     kulikov@elf.stuba.sk
;*
;* DESCRIPTION
;* This Application send parallel data into 74164 shift register
;* Subroutines:
;*          POUT_WRITE (temp)
;*****

;**** Register used by all programs, global variable used by all routines

.def temp =r16

.include "4414def.inc"

;**** 74164 pin setting

.equ POUT_RESET    =1
.equ POUT_DATA     =3
.equ POUT_CLK      =2

rjmp out_quit

;main:
;          ldi temp,high(RAMEND) ;High byte only required if
;          out SPH,temp         ;RAM is bigger than 256 Bytes
;          ldi temp,low(RAMEND) ;important for rcall jumps definition
```



```

;          out SPL,temp
;          ldi temp,0x00
;          out MCUCR,temp          ;configuration of MCU, MCU controll register

;          ldi temp,0xFF          ;initialise port C as out O/I
;          out DDRC,temp          ;all OUT

;start:    ldi temp,0x00
;          out PORTC,temp          ;set all 0 on port C
;          ldi temp,0x01          ;data to send
;          rcall POUT_WRITE        ;send data

;end:      rjmp end

;*****
;* POUT_WRITE (temp): parallel to serial converter 8bit *
;* *
;* POUT_WRITE procedure sends the content from the temp register on the *
;* POUT_DATA pin on port C in serial mode. This is synchronised by POUT_CLK *
;* signal. The synchronisation is sensitive on ascending edge. Signal *
;* POUT_RESET enables data transfer into the 74HC164 circuit (8b shift register)*
;* *
;* Used registers: temp          (parallel data) *
;* postupnost D7-D0 oznacenie zodpoveda napisom na DPS *
;*****

POUT_WRITE:    sbi PORTC,POUT_RESET ;disable reset of 74164

               cbi PORTC,POUT_DATA ;set 0 - serial data output
               cbi PORTC,POUT_CLK  ;set CLK to Low
               sbrnc temp,7        ;skip if Bit 7 from temp cleared
               sbi PORTC,POUT_DATA ;set 1 - serial data output
               sbi PORTC,POUT_CLK  ;set CLK to high (sampling)

               cbi PORTC,POUT_DATA ;set 0 - serial data output
               cbi PORTC,POUT_CLK  ;set CLK to Low
               sbrnc temp,6        ;skip if Bit 6 from temp cleared
               sbi PORTC,POUT_DATA ;set 1 - serial data output
               sbi PORTC,POUT_CLK  ;set CLK to high (sampling)

               cbi PORTC,POUT_DATA ;set 0 - serial data output
               cbi PORTC,POUT_CLK  ;set CLK to Low
               sbrnc temp,5        ;skip if Bit 5 from temp cleared
               sbi PORTC,POUT_DATA ;set 1 - serial data output
               sbi PORTC,POUT_CLK  ;set CLK to high (sampling)

               cbi PORTC,POUT_DATA ;set 0 - serial data output
               cbi PORTC,POUT_CLK  ;set CLK to Low
               sbrnc temp,4        ;skip if Bit 4 from temp cleared
               sbi PORTC,POUT_DATA ;set 1 - serial data output
               sbi PORTC,POUT_CLK  ;set CLK to high (sampling)

               cbi PORTC,POUT_DATA ;set 0 - serial data output
               cbi PORTC,POUT_CLK  ;set CLK to Low
               sbrnc temp,3        ;skip if Bit 3 from temp cleared
               sbi PORTC,POUT_DATA ;set 1 - serial data output
               sbi PORTC,POUT_CLK  ;set CLK to high (sampling)

               cbi PORTC,POUT_DATA ;set 0 - serial data output
               cbi PORTC,POUT_CLK  ;set CLK to Low
               sbrnc temp,2        ;skip if Bit 2 from temp cleared
               sbi PORTC,POUT_DATA ;set 1 - serial data output
               sbi PORTC,POUT_CLK  ;set CLK to high (sampling)

               cbi PORTC,POUT_DATA ;set 0 - serial data output
               cbi PORTC,POUT_CLK  ;set CLK to Low
               sbrnc temp,1        ;skip if Bit 1 from temp cleared
               sbi PORTC,POUT_DATA ;set 1 - serial data output
               sbi PORTC,POUT_CLK  ;set CLK to high (sampling)

               cbi PORTC,POUT_DATA ;set 0 - serial data output
               cbi PORTC,POUT_CLK  ;set CLK to Low
               sbrnc temp,0        ;skip if Bit 0 from temp cleared

```

Appendix

```
        sbi  PORTC,POUT_DATA  ;set 1 - serial data output
        sbi  PORTC,POUT_CLK   ;set CLK to high (sampling)

        ret

out_status:    mov   YL,XH           ;copy XH (IDATA) into YL
               ldi   YH,0x00       ;reset YH - used for count.-8bits

incbit:       ldi   temp,0xFF      ;temp = '1'
               sbrs  YL,0          ;if bit 0 of YL is set then skip
               ldi   temp,0xDB     ;temp = '0'

               rcall  LCD_write     ;write '0' or '1' to LCD

               inc   YH             ;increment YH
               lsr   YL             ;right logical rotate of YL
               ldi   temp,8        ;
               cp    YH,temp        ;comp if compl. out status reached
               brlt  incbit         ;if not do it again
               ret

out_quit:
; source END
```

10.2 Thermostat for electrochemical cell

Electrical specifications:

- Power supply: 230 V AC, 50 Hz
 - Power consumption: max 50 VA
 - Operation temperature: 0- 50°C
 - Heating element: foil 75 Ω (\approx 15 W)
 - Initial temperature error: \pm 1°C
 - Temperature stabilization \pm 0,05°C
-
- Temperature adjustment range: Room temp. (min 0°C) to 125°C
 - Cooling PC microprocessor fan 12 V:
 - Temperature stabilization: better than \pm 0,1°C
 - Analog remote input: 0 – 1250 mV (0 V=0°C, 10 mV/ °C), input current less than 500 μ A
 - Digital remote temperature adjustment: 0 – 2048 mV, step: 0,5 mV, interface ISP
 - Analog output from D/A converter: 0 – 2048 mV (via serial 1 k Ω resistor)



Fig. 93. Thermostat hardware (top view)

10.3 Electropolymerization library file description (CEP)

Voltametric electropolymerization (EP), library file structure

(1st line: description of columns, 2nd line value type (int = integer). 3rd value dimension)

line	ID	cln	C1	C2	C3	C4	temp	eqtime	Vp	lcomp	eptime	charge	chann
Int16	string	string	real64	real64	real64	real64	real64	int16	real64	real64	int16	real64	int16
0000	PCV	10 char		0.00			000.0	0000	000.000E+00		0000	000.000E+00	00

Note: Columns delimiter LF ("\n") (Line feed), Number of columns: up to 1000 (limited in the CEP software)

Symbol meanings:

line	line number 1 to 1000, (each number can be used only once), number 0 presents label line, not currently used in CEP program
ID	Identification string, is used to define EP method: PCV - Polymerization under Constant Voltage (possible upgrades to cyclic voltammetry, pulse voltammetry etc.)
cln	Additional cleaning procedures C1 or C2 before EP step, where combinations of the strings C1 and C2, gives required cleaning procedures (maximum procedures in one EP step is 5) and symbols mean: C1 - Cleaning procedure where solvent from the reservoir number 1 (inorganic: MQ water) is used C2 - Cleaning procedure where solvent from the reservoir number 2 (organic: e.g. ethanol) is used example: C1C2C1 (will apply first C1, then C2 and finally C1)
C1 – C4	Concentrations of additives for target reagent preparation in ml (resolution 10ul), limitations: 2 ml < C1+C2+C3+C4 < 4 ml Note: if C1 = C2 = C3 = C4 = 0, then just cleaning procedures are performed
temp	Temperature in °C of the EC (electrochemical cell) <0.0, 80.0>
eqtime	Equilibrium time (s), for temperature and electrochemical stabilization after transport of target reagent into the EC <0, 7200>
Vp	EP potential (V) <-5, 5>, digit resolution is 0.000E00
lcomp	Current compliance limit (A), definition of the maximal current through the work electrode <1 n; 0,1 A>
eptime	Electropolymerization time (s), where the sample rate is 2 samples / s (specifies time limit for EP step), <0, 7200>
charge	Final EP charge (C) < 0, 10>, (specifies charge limit for EP), "zero" charge means disabled charge limit
chann	Channel number <1, 96> corresponding to the specific work electrode, The channel ordering must be specified

Library file supported by CEP software, written by V. Kulikov 2003

Ver.0.9, last update: 12.09.03 VKU03RG

1 / 5

Galvanostatic polymerization, file structure

(1st line: description of column, 2nd line value type (int = integer). 3rd value dimension)

line	ID	cln	C1	C2	C3	C4	temp	eqtime	Ig	Vcomp	eptime	charge	chann
Int16	string	string	real64	real64	real64	real64	real64	int16	real64	real64	int16	real64	int16
0000	PCI	10 char		0.00			000.0	0000	000.000E+00		0000	000.000E+00	00

Note: Columns delimiter LF ("\n") (Line feed), Number of columns: up to 1000

Symbol meanings:

line	line number 1 to 1000, (each number can be used only once), number 0 presents label line, not currently used in CEP program
ID	Identification string, is used to define electropolymerization method, where current available is: PCI - Polymerization under Constant current (possible upgrades for cyclic voltammetry, pulse voltammetry etc.)
cln	Additional cleaning procedures C1 or C2 before EP step, where combinations of the strings C1 and C2, gives required cleaning procedures (maximum procedures in one EP step is 5) and symbols mean: C1 - Cleaning procedure where solvent from the reservoir number 1 (inorganic: MQ water) is used C2 - Cleaning procedure where solvent from the reservoir number 2 (organic: e.g. ethanol) is used example: C1C2C1 (will apply first C1, then C2 and finally C1)
C1 – C4	Concentrations of additives for target reagent preparation in ml (resolution 10ul), limitations: 2 ml < C1+C2+C3+C4 < 4 ml Note: if C1 = C2 = C3 = C4 = 0, then just cleaning procedures are performed
temp	Temperature in °C of the EC (electrochemical cell) <0.0, 80.0>
eqtime	Equilibrium time (s), for temperature and electrochemical stabilization after transport of target reagent into the EC <0, 7200>
Ig	Galvanostatic current (A) <-10 mA, 10 mA>, higher range is available please refer to the K2400 manual [1]
Vcomp	Voltage compliance limit (V) <+200 mV, +200 V>
eptime	EP time (s), where the sample rate is 2 samples / s (specifies time limit for EP step), <0, 7200>
charge	Final EP charge (C) < 0, 10>, (specifies charge limit for EP), "zero" charge means disabled charge limit
chann	Channel number <1, 96> corresponding to the specific work electrode, The channel ordering must be specified

Library file supported by CEP software, written by V. Kulikov 2003

Ver.0.9, last update: 12.09.03 VKU03RG

2 / 5

Additional procedures (1st line: description of column, 2nd line value type (int = integer), 3rd value dimension)

line	ID	cln	C1	C2	C3	C4	temp
Int16	string	string	real64	real64	real64	real64	real64
0000	SOLPRP	10 char			0.00		000.0

line	ID	cln	temp
Int16	string	string	real64
0000	CLN	10 char	000.0

line	ID	temp	bdelay	sdelay
Int16	string	real64	int16	int16
0000	POTMET	000.0	0000	0000

Note: Columns delimiter LF ("n") (Line feed),
Number of columns: up to 1000

Symbol meanings:

line	line umber 1 to 1000, (each number can be used only once), number 0 presents label line, not currently used in CEP program
ID	Identification string, SOLPRP - Solvent preparation (the target solvent (CLN or C1-C4 mixture) is prepared and transferred into EC) POTMET – Potentiometric measurement involving all 96 channels (work electrodes) – not confirmed SW feature CLN – independent cleaning phase, please refer to the cln below
cln	- For ID=CLN: Independent cleaning procedures formed by C1 or C2, where combinations of the strings C1 and C2, gives required cleaning advance (maximum procedures: 5), meaning of symbols: C1 - Cleaning procedure where solvent from the reservoir number 1 (inorganic: MQ water) is used C2 - Cleaning procedure where solvent from the reservoir number 2 (organic: e.g. ethanol) is used example: C1C2C1 (will apply first C1, then C2 and finally C1) - For ID=SOLPRP, The solvents from the reservoirs 1 and 2 can be used as analyte for potentiometric measurements, there are two allowed combinations C1 or C2, please note that C1-C4 are ignored after involving C1 or C2.
C1 – C4	Concentrations of additives for target reagent preparation in ml (resolution 10ul), limitations: 2 ml < C1+C2+C3+C4 < 4 ml Note: if C1 = C2 = C3 = C4 = 0, then just cleaning procedures are performed
temp	Temperature in °C of the EC (electrochemical cell) <0.0, 80.0>
bdelay	Begin delay for amperometric measurement in seconds
sdelay	step delay for potentiometric measurement in seconds

Library file supported by CEP software, written by V. Kulikov 2003

Ver.0.9, last update: 12.09.03 VKU03RG

3 / 5

Example

library file – line	description
0 label line	(for user notes) program ignores these lines (not tested)
1 SOLPRP C2 0 0 0 0 40	Solvent preparation, a solvent from reservoir number 2 is transported into electrochemical cell and staying there until following new library line is executed. (temperature = 40°C)
2 POTMET 41 5 1	Potentiometric measurement, data acquisition of potentiometric signal of all single work electrodes to check their modifications after previous EP steps (temperature 40°C, Begin delay 5 s, step delay 1 s)
3 PCVE XX 0 0 0 0 25.0 10 3.500E-001 1.000E-003 5 0.000E+000 85 (3 PCV XX 0 0 0 0 25.0 10 3.500E-001 1.000E-003 5 0.000E+000 85)	Polymerization by constant voltage – external - without changing of analytes, previous analytes, used previously in the line Nr. 2 (above) are used XX – no cleaning procedures involved C1-C4 are ignored, possible any value (temperature 25,0°C, equilibrium time 10 s etc) When ID=PCE, then the content of EC is replaced by a new mixture (defined in the actual library line).
4 SOLPRP XX 1 1 0 0 30	Pre-flashing with target analyte, After first transport into EC, the content is removed and the same step repeated. At the end the content is kept in the reaction cell. It can be used to decrease the error caused by dead volume of the EC.

Note: PCVE and POTMET commands disables removing of reagents from the electrochemical cell. The reagents are removed after execution next library line r at the end of the library content.

Library file supported by CEP software, written by V. Kulikov 2003

Ver.0.9, last update: 12.09.03 VKU03RG

4 / 5

Example

library file – line	description
0 label line	(for user notes) program ignores these lines (not tested)
1 SOLPRP C2 0 0 0 0 40	Solvent preparation, a solvent from reservoir number 2 is transported into electrochemical cell and staying there until following new library line is executed. (temperature = 40°C)
2 POTMET 41 5 1	Potentiometric measurement, data acquisition of potentiometric signal of all single work electrodes to check their modifications after previous EP steps (temperature 40°C, Begin delay 5 s, step delay 1 s)
3 PCVE XX 0 0 0 0 25.0 10 3.500E-001 1.000E-003 5 0.000E+000 85 (3 PCV XX 0 0 0 0 25.0 10 3.500E-001 1.000E-003 5 0.000E+000 85)	Polymerization by constant voltage – external - without changing of analytes, previous analytes, used previously in the line Nr. 2 (above) are used XX – no cleaning procedures involved C1-C4 are ignored, possible any value (temperature 25,0°C, equilibrium time 10 s etc) When ID=PCE, then the content of EC is replaced by a new mixture (defined in the actual library line).
4 SOLPRP XX 1 1 0 0 30	Pre-flashing with target analyte, After first transport into EC, the content is removed and the same step repeated. At the end the content is kept in the reaction cell. It can be used to decrease the error caused by dead volume of the EC.

Note: PCVE and POTMET commands disables removing of reagents from the electrochemical cell. The reagents are removed after execution next library line r at the end of the library content.

10.4 Measurement procedure file description (ARYMS)

Measurement procedure file description Version 1.02

21.01.04 VKU03RG

File structure (1st line: description of column, 2nd line value type (int= Integer), 3rd value dimension)

line	ID	GC1	GC2	GC3	delay	chann	Vstart	Vstop	np	lcomp	sdelay	temp	NPLC	note
Int16	string	int16	int16	int16	int32	int16	real64	real64	int16	real64	int32	rela64	int16	string
0000	7 char	000			000000	00	000.000E+00		0000	000.000E+00	000000	00.0	0	16 char

Note: Columns delimiter LF ("n") (Line feed), Number of columns: up to 1000, Line 0 of the procedure is used as columns label

Symbol description:

line	unique line number 1 to 1000, (each number can be used only once)
ID	Identification string, defines measurement mode: LINVSW4 – simultaneous two- and four-point linear voltage sweep measurement
GC1–GC3	Three different gas flow rates in ml/min (for details refer to the gas set-up characterization) (GC1: 0 – 5000 ml/min, GC2: 0 – 200 ml/min, GC3: 0 – 1000 ml/min)
delay	Time, during the gas content (GC1+GC2+GC3) flows through the gas cell (Flash time) in seconds
chann	Channel number <1, 96>, 97 sequential switching from 1 to 96 (involves all channels)
Vstart	start voltage of the linear sweep [1]
Vstop	stop voltage of the linear sweep [1]
np	Number of points in linear sweep <-2500, 2500> [1], NOTE: when np<0 then hysteresis measurement is allowed
lcomp	Compliance (current protection) in A <-1, 1> [1]
sdelay	Source delay time used to set the settling time for the source. This source delay is the delay phase of the Source-Delay-Measure (SDM) cycle [1]. Manually setting the delay disables auto delay, <10ms, 5s>
temp	Temperature of the thermo-reservoir contacted to the electrode array, <room temp., 125°C>, if temp=0 => tem control disabled
NPLC	Presents average value from NPLC time measurements [1], appropriate for low current measurements
note	User note, max 16 ASCII characters

Procedure file supported by ARYMS, written by V. Kulikov 2003

Ver.1.02, last update: 21.01.04 VKU04RG

1 / 4

line	ID	GC1	GC2	GC3	delay	chann	Vstart	Vstop	np	lcomp	sdelay	temp	NPLC	note
Int16	string	int16	int16	int16	int32	int16	real64	real64	int16	real64	int32	rela64	int16	string
0000	7 char	000			000000	97	50 mV	-50 mV	2	000.000E+00	000000	000.0	1	16 char

Note: Columns delimiter LF ("n") (Line feed), Number of columns: up to 1000, Line 0 of the procedure is used as columns label

Symbol description:

line	Number of line possible 1 to 1000, (each number can be used just once)
ID	Identification string, defines measurement mode: PULSIM1 – 2P & 4P pulse-simultaneous measurement (required K2000 instrument) with temperature pulse 125°C [3] PULSIM2 – 2P & 4P pulse-simultaneous measurement (required K2000 instrument [2])
GC1–GC3	Three different gas flow rates in ml/min (for details refer to the gas set-up characterization) (GC1: 0 – 5000 ml/min, GC2: 0 – 200 ml/min, GC3: 0 – 1000 ml/min)
delay	Time, during the gas content (GC1+GC2+GC3) flows through the gas cell (Flash time) in seconds
chann	Channel number <1, 96>, 97 sequential switching from 1 to 96 (involves all channels)
Vstart	positive pulse voltage, recommended and tested 50 mV (other not tested !)
Vstop	negative pulse voltage, recommended and tested -50 mV (other not tested !)
np	=2 !
lcomp	Compliance (current protection) in A <-1, 1> [1]
sdelay	Source delay time used to set the settling time for the source. This source delay is the delay phase of the Source-Delay-Measure (SDM) cycle [1]. Manually setting the delay disables auto delay, <10ms, 5s>
temp	Temperature of the thermo-reservoir contacted to the electrode array, <room temp., 125°C>, if temp=0 => tem control disabled
NPLC	=1 !
note	User note, max 16 ASCII characters

Reference

[1] Keithley, "Model 2400 Series SourceMeter User's Manual" Rev.F, 2001

[2] Keithley, "Model 2000 Multimeter User's manual" Rev.G, 2003

[3] V. Kulikov, Ph.D. Thesis (Measurement protocol), 2004

Procedure file supported by ARYMS, written by V. Kulikov 2003

Ver.1.02, last update: 21.01.04 VKU04RG

2 / 4

Appendix

Directory structure

General root directory of the combinatorial project (default setting): *D:\kombisens*

Note: It could be changed in the CEP "Set-up and Options" window, the ARYMS software follows the directory previously created by the CEP software. So the measurement can be only based on previously created electropolymerization library.

all files are situated in the library directory (example for library name: 01-01-02AB): *D:\kombisens\01-01-02AB*

settings.dat settings of the EP set-up – electronic part in record VEE format (used only by ARYMS software)
 result.dat state of the electrode array – of each electrode (used not used, defected, working, etc.), could be modified by the ARYMS software

Subfolder: meas (*D:\kombisens\01-01-02AB\meas*)

procedure.dat measurement procedure file in record VEE format
 procedure.txt measurement procedure file in ASCII format corresponding to specifications in this document
 status.txt status of the measurement set-up recorded during the measurement (back control of the execution of all procedure steps recorded with time here, offset values, measurement times etc.)

Subfolder of meas: txt (*D:\kombisens\01-01-02AB\meas\txt*)

17_97.txt pulse measurement (PULSIM) of all 96IDT electrodes in one ASCII format (X_Y.txt, where X – procedure number, 97=all sensors measures sequentially), app. for import in to Microcalc Origin, etc., (column : parameter - 1:avr1(A), 2:avrV4(V), 3:-I(A), 4:+I(A), 5:-V4(V), 6:+V4(V))
 1_1.txt...1_96.txt sweep measurement data in ASCII format (X_Y.txt, where X – procedure number, Y= sensors number), app. for import in to Microcalc Origin, etc., (first column = I(A), second = V4(V), third = V2(V))

Subfolder of meas: backup (*D:\kombisens\01-01-02AB\meas\backup*)

1.bak ... Y.bak corresponding procedure steps (Y) involving all 96 IDT electrode, recorded in record VEE format (used by analysis SW)

Procedure file supported by ARYMS, written by V. Kulikov 2003

Ver.1.02, last update: 21.01.04 VKU04RG

3 / 4

Kombisens procedure file Ver 1.3

0	ID	N2	HCl	NU	delay	ch	Vstart	Vstop	np	compl	sdelay	temp	NL	note
1	LINVSW 2	600	0	0	120	97	-5.00E-02	5.00E-02	40	1.50E-03	0	40	1	sweep 0ppm
2	PULSIM1	10	0	0	0	97	-5.00E-02	5.00E-02	2	1.50E-03	0	40	1	ref 0ppm
2	PULSIM2	592	8	0	120	97	-5.00E-02	5.00E-02	2	1.50E-03	0	40	1	A11 2.5ppm
3	PULSIM2	592	8	0	480	97	-5.00E-02	5.00E-02	2	1.50E-03	0	40	1	A12 2.5ppm
4	PULSIM2	592	8	0	480	97	-5.00E-02	5.00E-02	2	1.50E-03	0	40	1	A13 2.5ppm
5	PULSIM1	600	0	0	0	97	-5.00E-02	5.00E-02	2	1.50E-03	0	40	1	D11 0ppm
6	PULSIM1	600	0	0	0	97	-5.00E-02	5.00E-02	2	1.50E-03	0	40	1	D12 0ppm
7	PULSIM1	600	0	0	0	97	-5.00E-02	5.00E-02	2	1.50E-03	0	40	1	D13 0ppm
8	PULSIM2	592	8	0	120	97	-5.00E-02	5.00E-02	2	1.50E-03	0	40	1	A21 2.5ppm
9	PULSIM2	592	8	0	480	97	-5.00E-02	5.00E-02	2	1.50E-03	0	40	1	A22 2.5ppm
10	PULSIM2	592	8	0	480	97	-5.00E-02	5.00E-02	2	1.50E-03	0	40	1	A23 2.5ppm
11	PULSIM1	600	0	0	0	97	-5.00E-02	5.00E-02	2	1.50E-03	0	40	1	D21 0PPM
12	PULSIM1	600	0	0	0	97	-5.00E-02	5.00E-02	2	1.50E-03	0	40	1	D22 0ppm
13	PULSIM1	600	0	0	0	97	-5.00E-02	5.00E-02	2	1.50E-03	0	40	1	D23 0PPM
14	PULSIM2	592	8	0	120	97	-5.00E-02	5.00E-02	2	1.50E-03	0	40	1	FA1 2.5ppm
15	PULSIM1	600	0	0	0	97	-5.00E-02	5.00E-02	2	1.50E-03	0	40	1	FD1 0ppm
16	PULSIM2	592	8	0	120	97	-5.00E-02	5.00E-02	2	1.50E-03	0	40	1	FA2 2.5ppm
17	PULSIM1	600	0	0	0	97	-5.00E-02	5.00E-02	2	1.50E-03	0	40	1	FD2 0PPM
18	PULSIM2	589	11	0	120	97	-5.00E-02	5.00E-02	2	1.50E-03	0	40	1	G 3.5ppm
19	PULSIM2	585	15	0	120	97	-5.00E-02	5.00E-02	2	1.50E-03	0	40	1	G 5ppm
20	PULSIM2	579	21	0	120	97	-5.00E-02	5.00E-02	2	1.50E-03	0	40	1	G 7ppm
21	PULSIM2	570	30	0	120	97	-5.00E-02	5.00E-02	2	1.50E-03	0	40	1	G 10ppm
22	PULSIM2	558	42	0	120	97	-5.00E-02	5.00E-02	2	1.50E-03	0	40	1	G 14ppm
23	PULSIM2	540	60	0	120	97	-5.00E-02	5.00E-02	2	1.50E-03	0	40	1	G 20ppm
24	PULSIM2	516	84	0	120	97	-5.00E-02	5.00E-02	2	1.50E-03	0	40	1	G 28ppm
25	PULSIM2	480	120	0	120	97	-5.00E-02	5.00E-02	2	1.50E-03	0	40	1	A31 40ppm
26	PULSIM2	480	120	0	480	97	-5.00E-02	5.00E-02	2	1.50E-03	0	40	1	A32 40ppm
27	PULSIM2	480	120	0	480	97	-5.00E-02	5.00E-02	2	1.50E-03	0	40	1	A33 40ppm
28	PULSIM1	600	0	0	0	97	-5.00E-02	5.00E-02	2	1.50E-03	0	40	1	D31 0ppm
29	PULSIM1	600	0	0	0	97	-5.00E-02	5.00E-02	2	1.50E-03	0	40	1	D32 0ppm
30	PULSIM1	600	0	0	0	97	-5.00E-02	5.00E-02	2	1.50E-03	0	40	1	D33 0ppm
31	PULSIM2	480	120	0	120	97	-5.00E-02	5.00E-02	2	1.50E-03	0	40	1	A41 40ppm
32	PULSIM2	480	120	0	480	97	-5.00E-02	5.00E-02	2	1.50E-03	0	40	1	A42 40ppm
33	PULSIM2	480	120	0	480	97	-5.00E-02	5.00E-02	2	1.50E-03	0	40	1	A43 40ppm
34	PULSIM1	600	0	0	0	97	-5.00E-02	5.00E-02	2	1.50E-03	0	40	1	D41 0ppm
35	PULSIM1	600	0	0	0	97	-5.00E-02	5.00E-02	2	1.50E-03	0	40	1	D42 0ppm
36	PULSIM1	600	0	0	0	97	-5.00E-02	5.00E-02	2	1.50E-03	0	40	1	D43 0ppm
37	PULSIM2	480	120	0	120	97	-5.00E-02	5.00E-02	2	1.50E-03	0	40	1	FA3 40ppm
38	PULSIM1	600	0	0	0	97	-5.00E-02	5.00E-02	2	1.50E-03	0	40	1	FD3 0ppm
39	PULSIM2	480	120	0	120	97	-5.00E-02	5.00E-02	2	1.50E-03	0	40	1	FA4 40ppm
40	PULSIM1	600	0	0	0	97	-5.00E-02	5.00E-02	2	1.50E-03	0	40	1	FD4 0ppm
41	LINVSW 4	480	120	0	120	97	-2.50E-02	2.50E-02	40	1.50E-03	0	40	1	sweep 40ppm

Procedure file supported by ARYMS, written by V. Kulikov 2003

Ver.1.02, last update: 21.01.04 VKU04RG

4 / 4

10.5 Combinatorial results

- Results based on P(ANI+4ABA), library: 04-06-03-4ABA-5
- Results based on P(ANI+3ABSA), library: 09-06-03-3ABSA
- Results based on P(ANI+3ABA), library: 09-07-03-3ABA
- Results based on P(ANI+AA), library: 24-05-03-AA1

10.5.1 Results on $P(\text{ANI} + 4\text{ABA})$, library: 04-06-03-4ABA-5

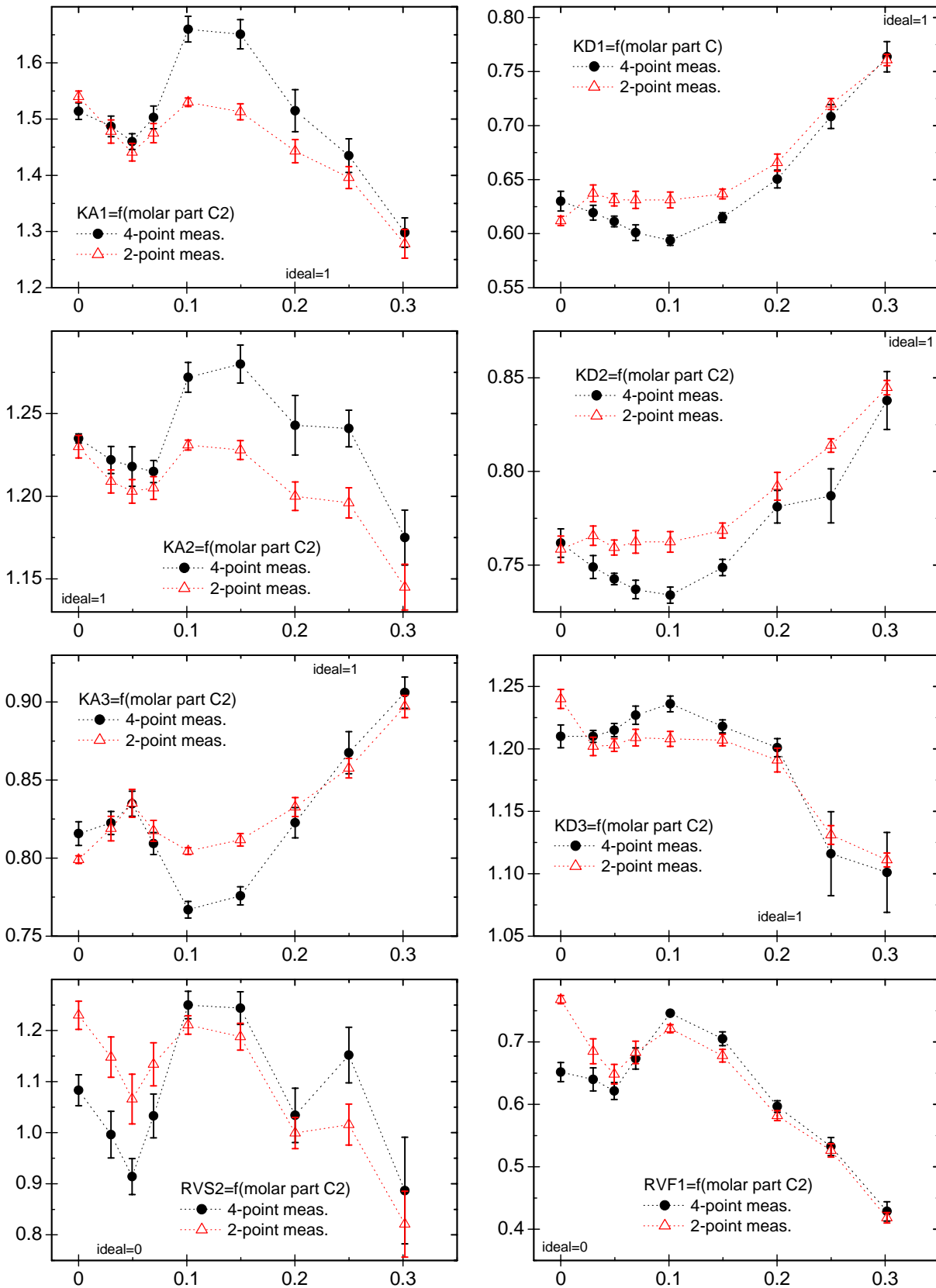

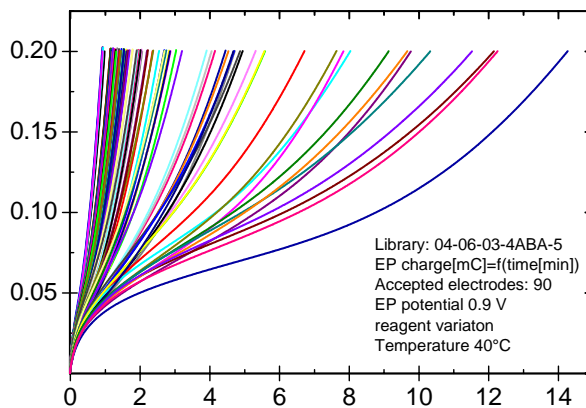
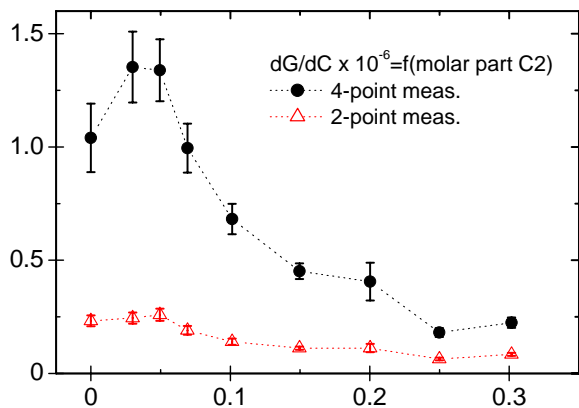
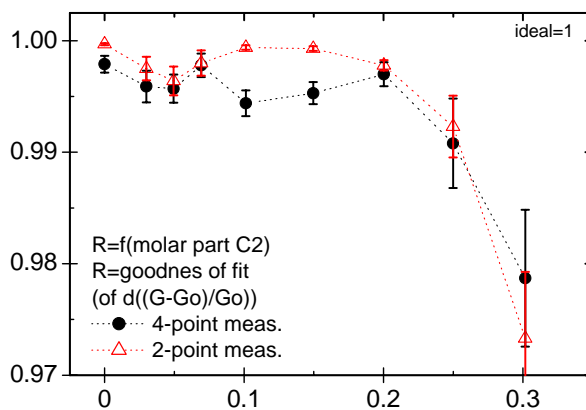
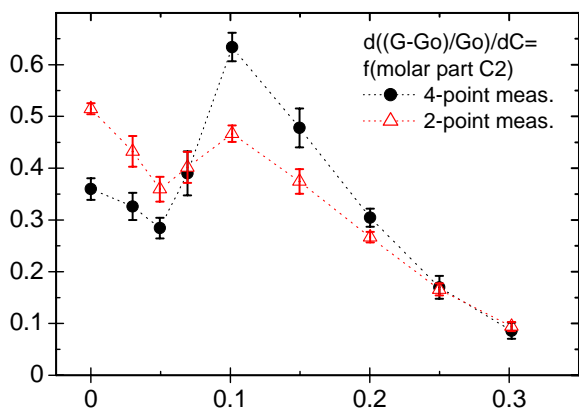
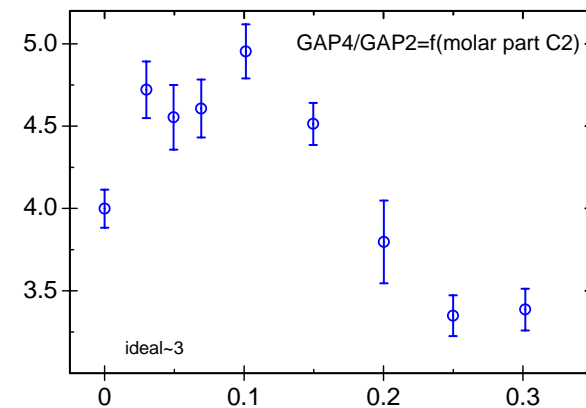
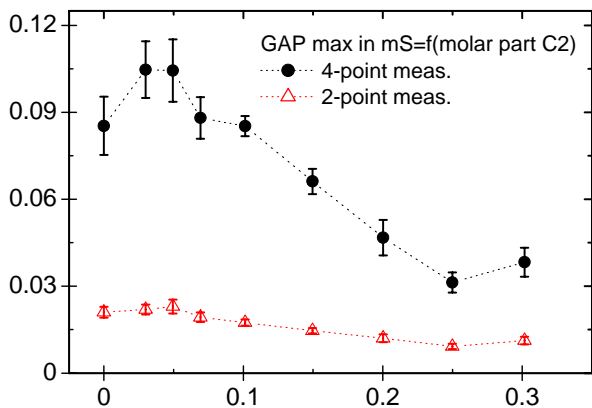
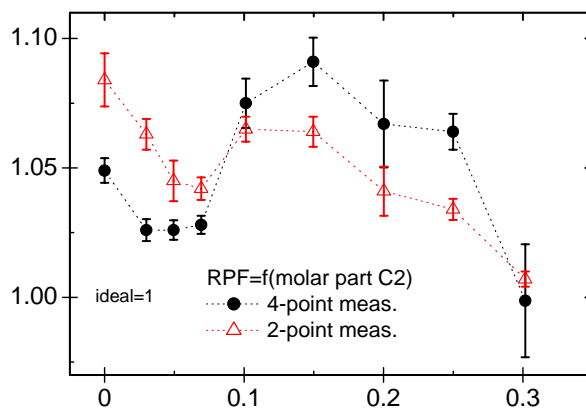
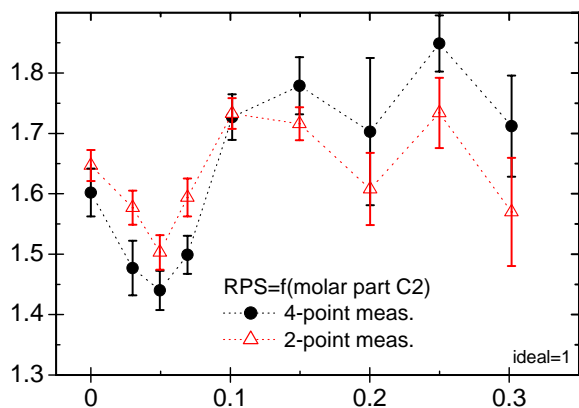

10.5.2 Results on P(ANI + 3ABSA), library: 09-06-03-3ABSA

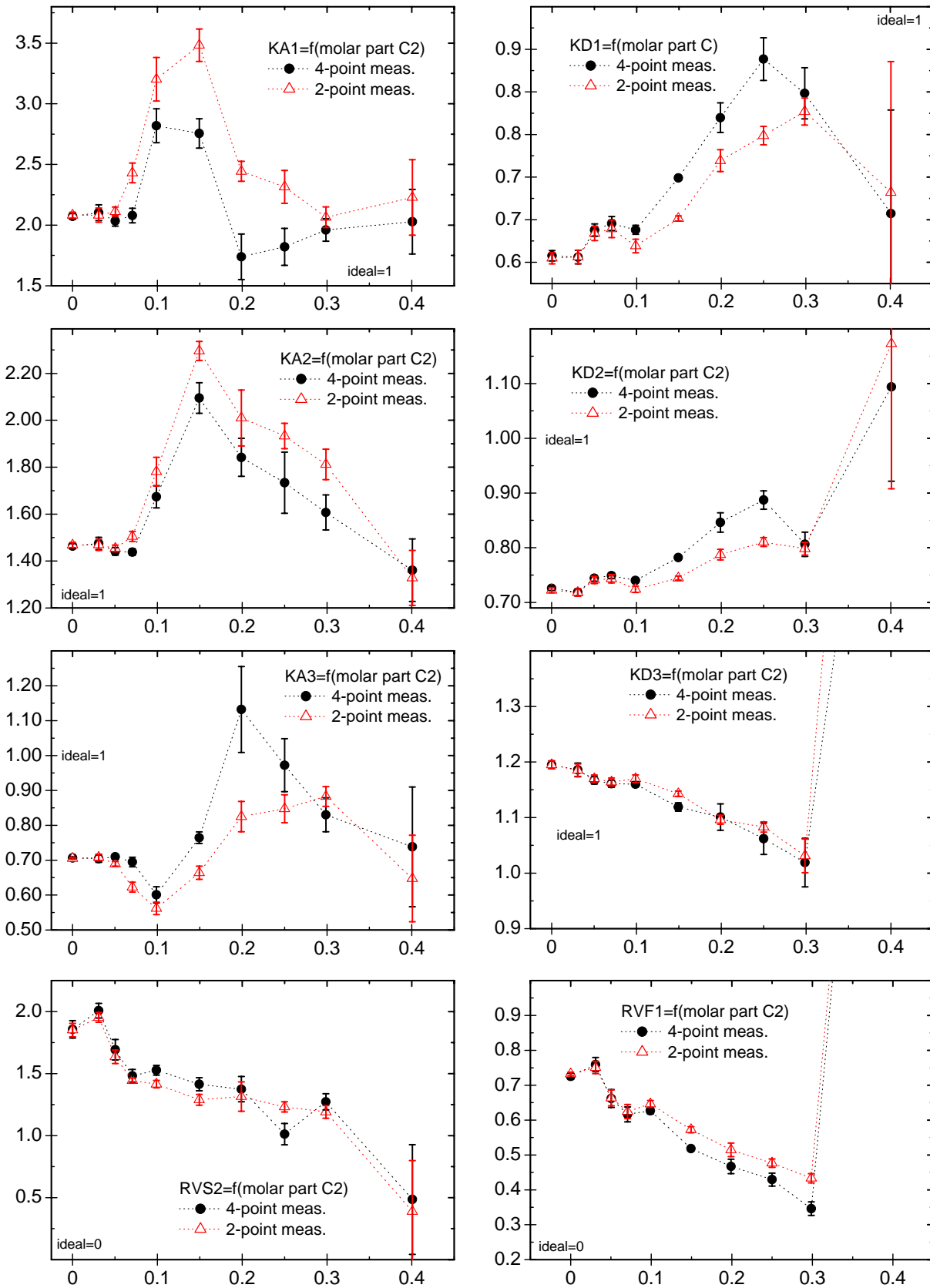

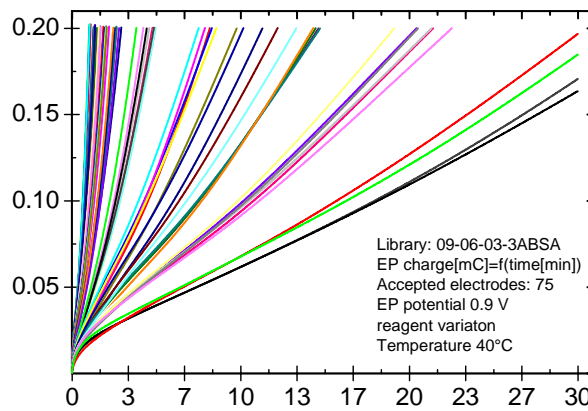
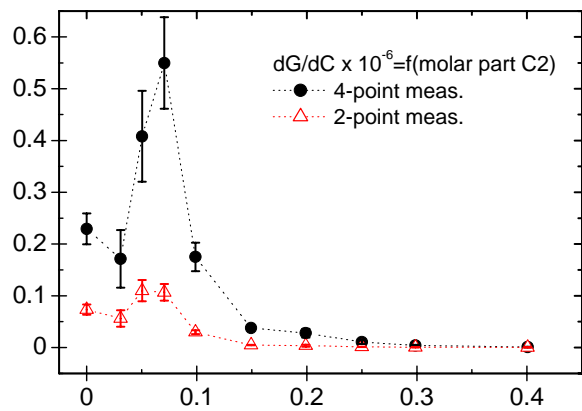
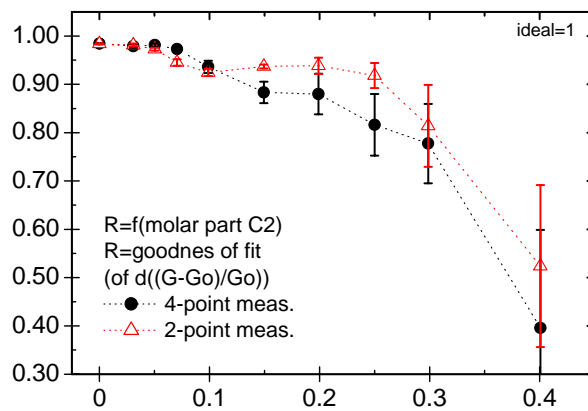
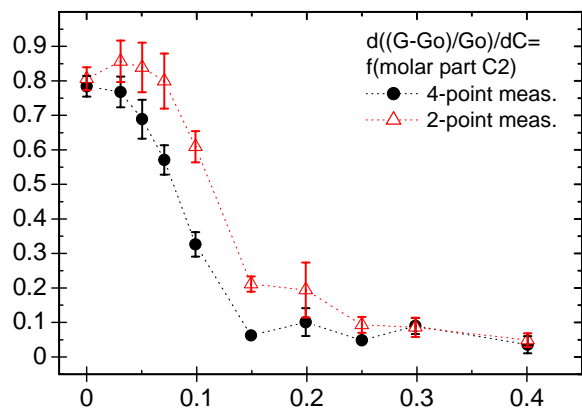
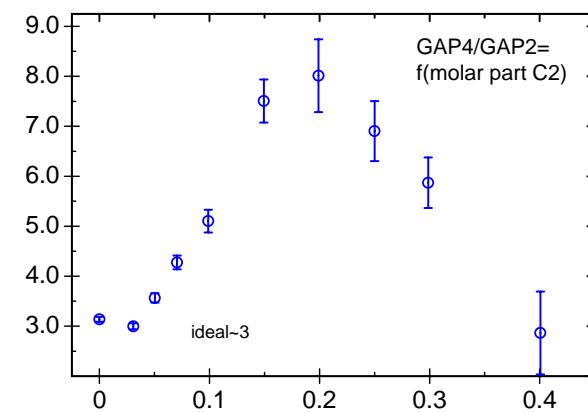
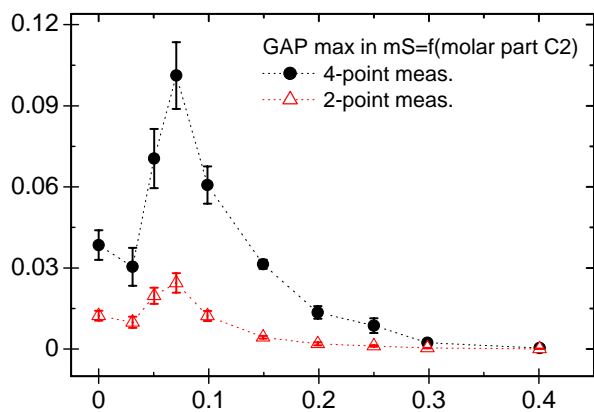
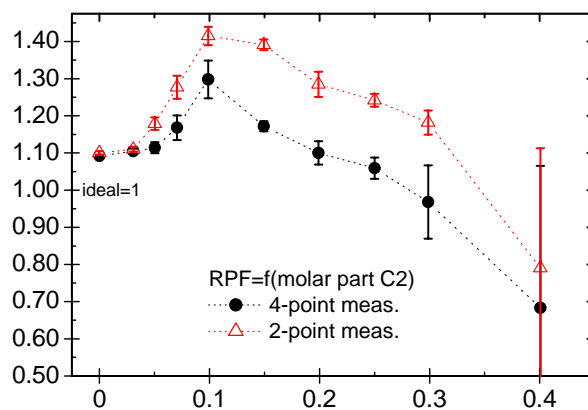
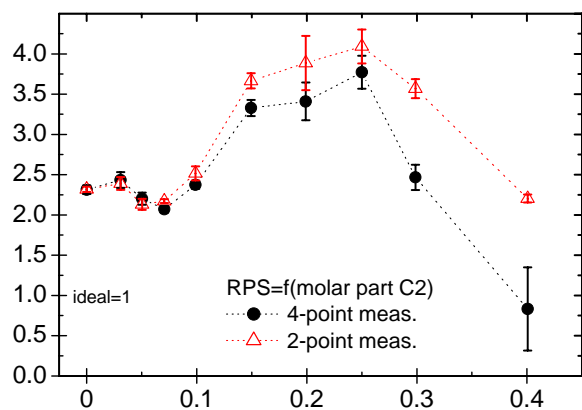

10.5.3 Results on $P(\text{ANI} + 3\text{ABA})$, library: 09-07-03-3ABA

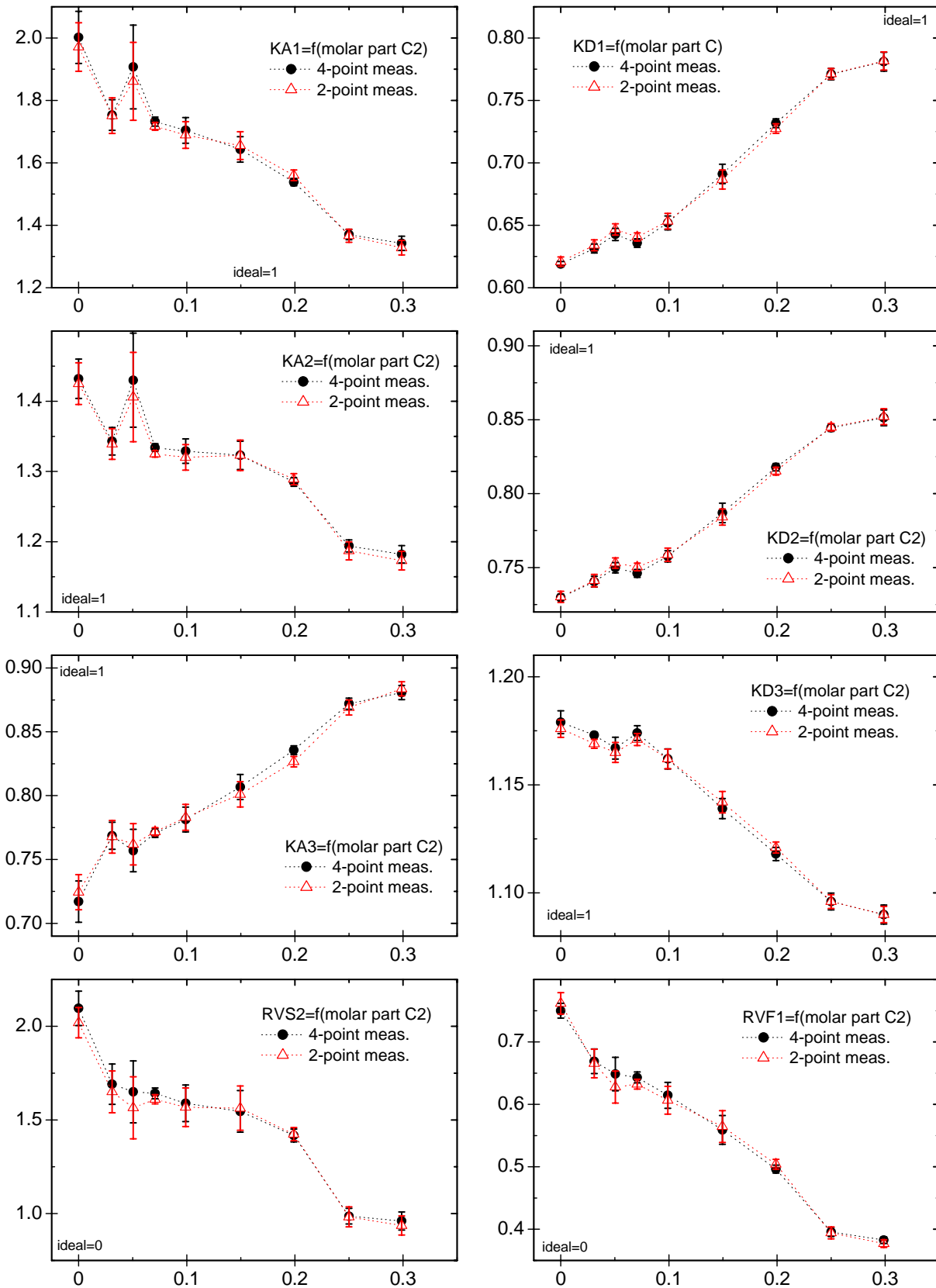

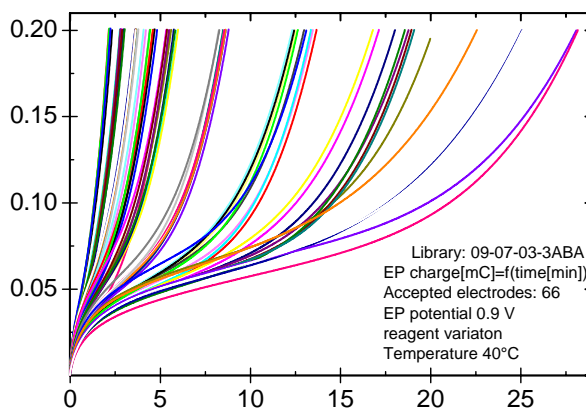
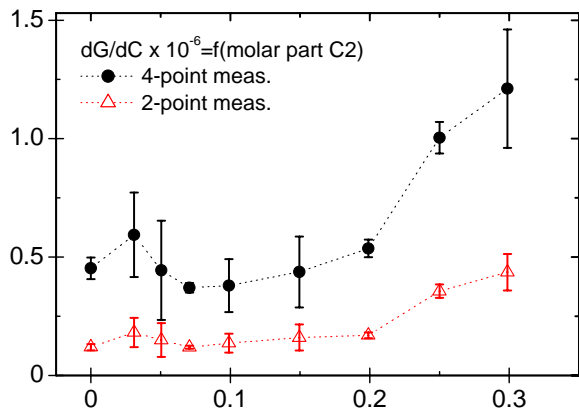
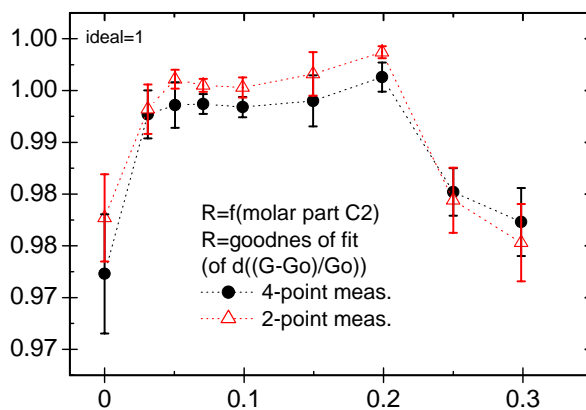
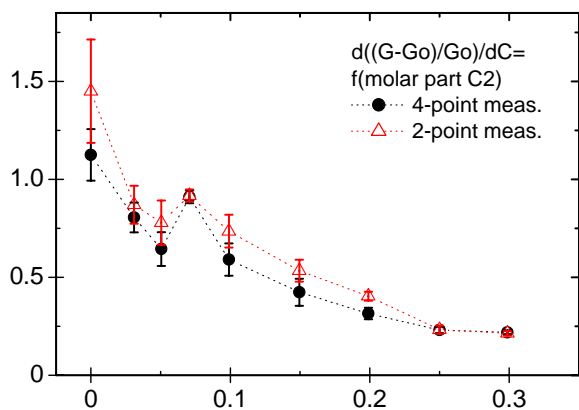
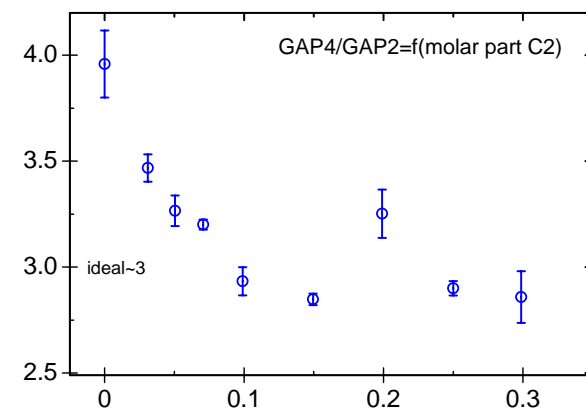
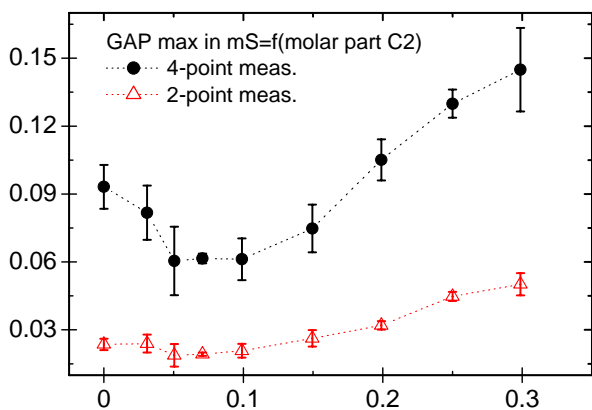
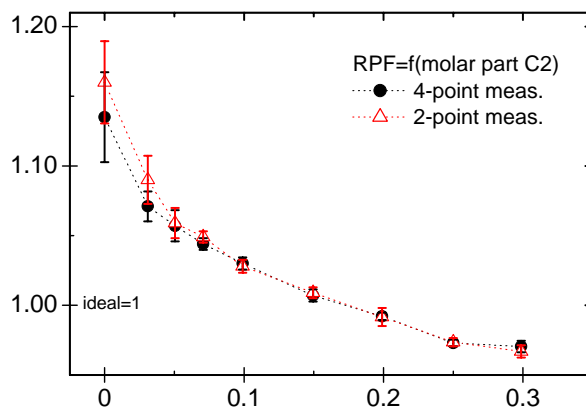
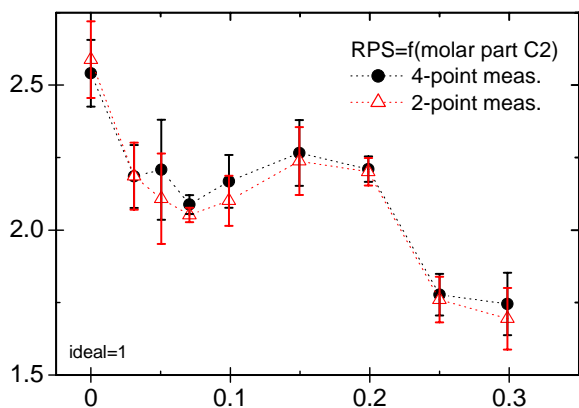

10.5.4 Results on $P(\text{ANI} + \text{AA})$, library: 24-05-03-AA1

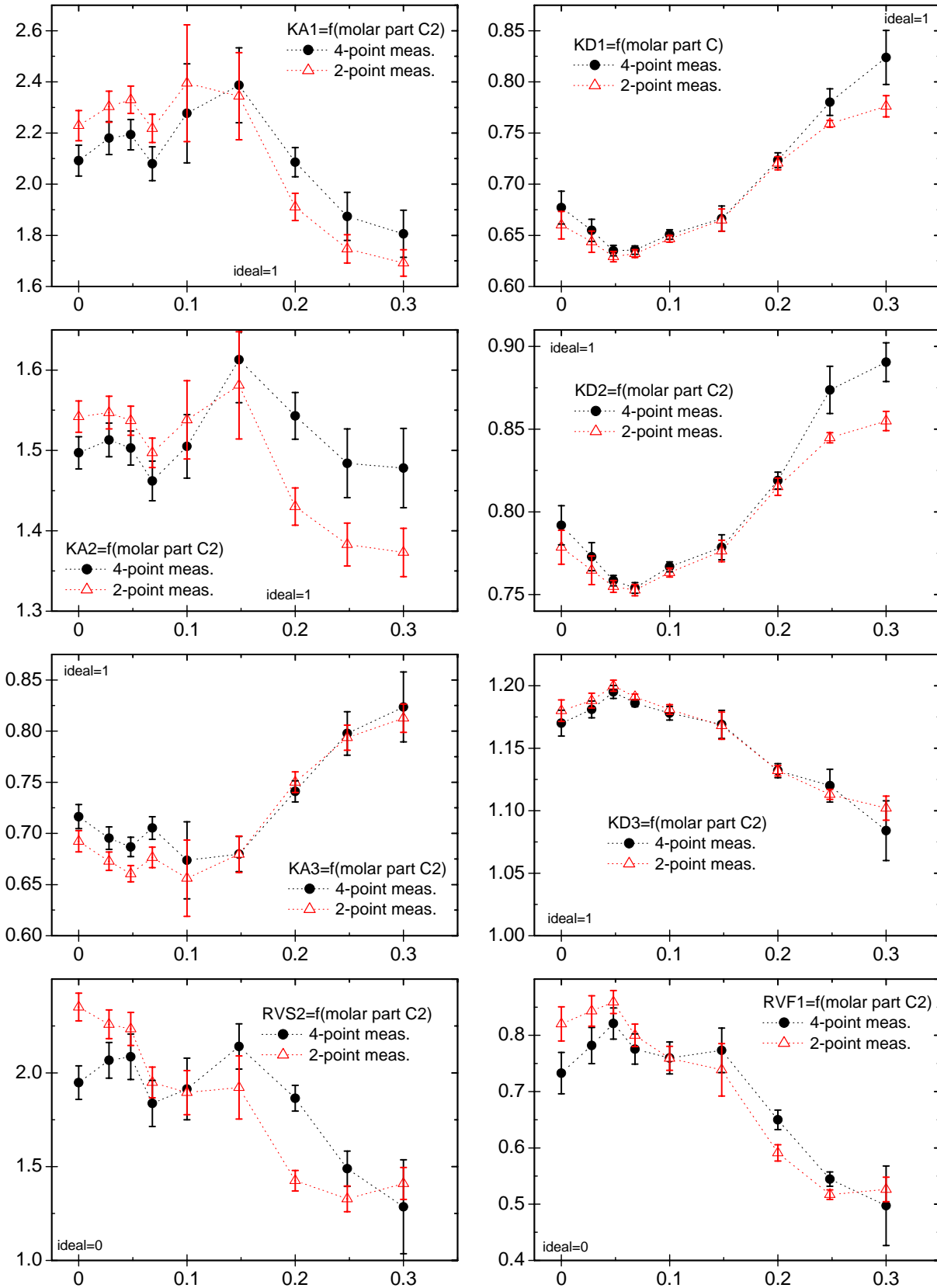

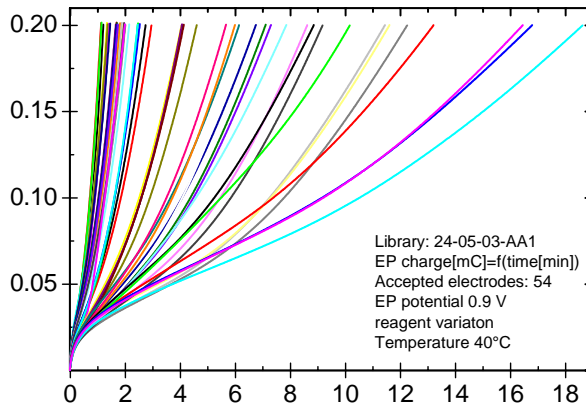
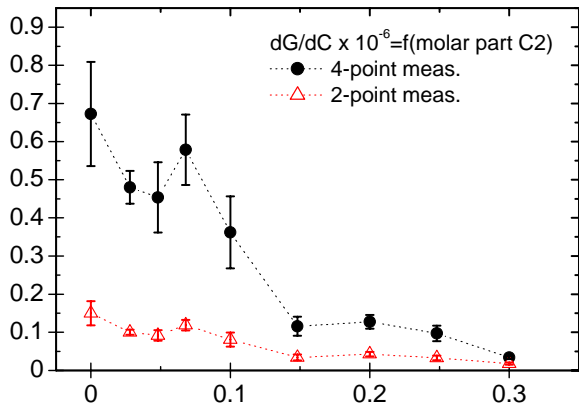
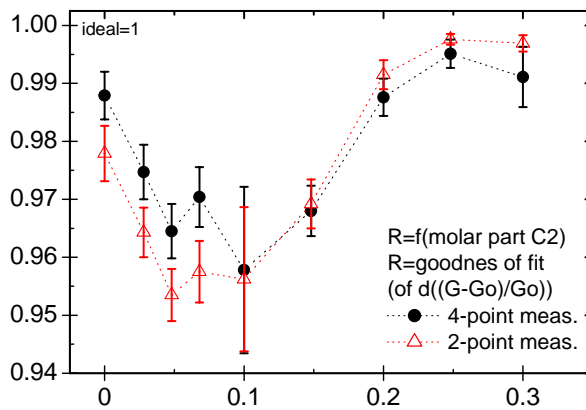
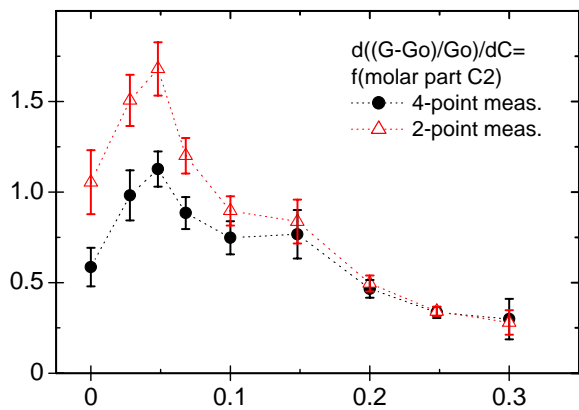
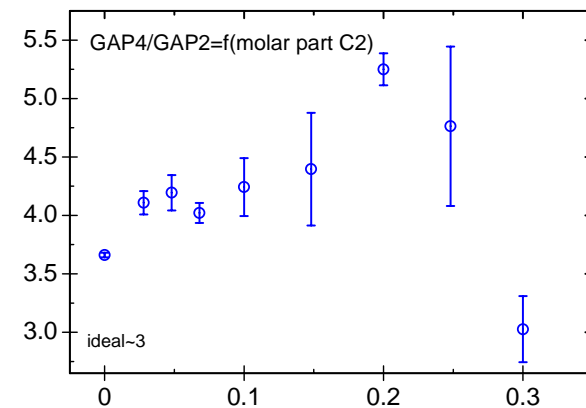
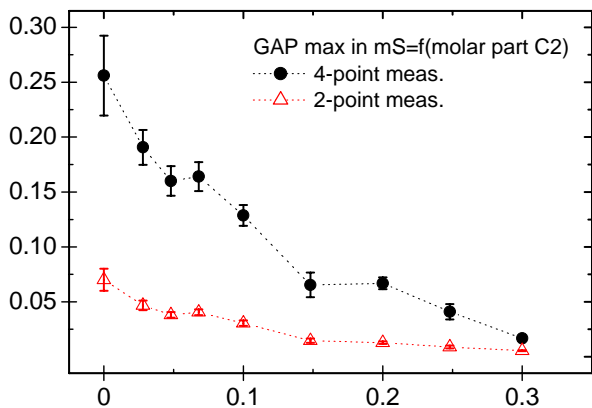
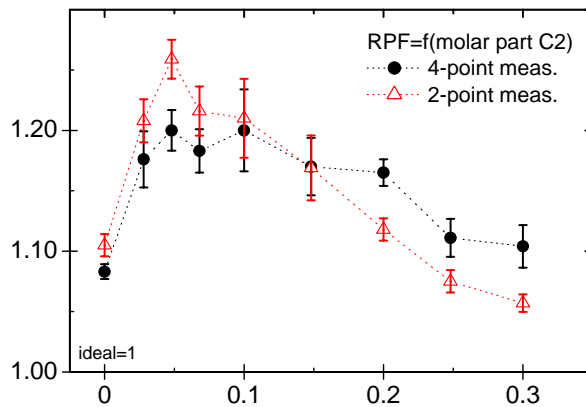
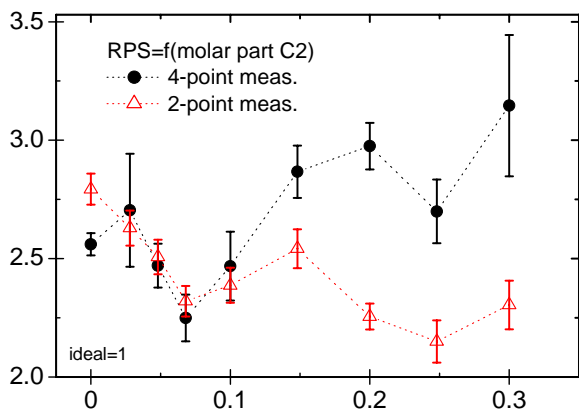

11 Acknowledgment

I would like to thank all people who contributed to this work, especially to:

- Prof. Alexander Koch** for his supervising, fruitful discussions, numerous comments and suggestions
- Prof. Otto. S. Wolfbeis** for giving me the opportunity to study and work in the department of Analytical Chemistry, Chemo- and Bio-sensors at University Regensburg and for his useful comments and continual support
- PD. Dr. Vladimir M. Mirsky** for his supervising (according the design and realization of the electropolymerization and measurement set-up), for his valuable suggestions, fruitful discussions and comments
- Prof. Daniel Donoval** for introducing me into the world of microelectronics, offering me possibility to interrupt my studies in Bratislava and work for University in Regensburg, for his helpful advice, suggestions and fruitful discussions
- Dr. Qingli Hao** for her help on chemical part of this work, for her experiments, suggestions, advice and especially for her friendship
- Dipl. Chem. Claudia Swart** for her initial experiments on electropolymerization
- Dr. O. Lossen** for his valuable help during technical design of the EP set-up
- Gisela Emmert** for her help with computer-based problems
- Dr. D. Andrzejewski** for adjustment of gas mixer and programming of gas valves
Dipl. Chem. A. Apostolidis (mentioned in this work as Gas flow system)
- MAXIM**, producer of ANALOG & MIXED SIGNAL ICs for their great sample support for the prototype of special thermostate for our electrochemical cell

Acknowledgment

ON semiconductor (Motorola)	for their flexible sample support (for the prototype of general parts of the electropolymerization set-up)
Joe Zukowski	for making the written form of this document smooth, for his grateful suggestions concerning English language and especially for his friendship
Dr. Tanya Delaney, Angela Haberkern, Dipl. Chem. Thomas Hirsch MSc. Hana Breznova	for their valuable help, friendly atmosphere in the team, their friendships and many other things
Electronic and mechanic workshops of the chemical department of University Regensburg, especially to: Dr. K. Mayer, J. Steinberger, J. Birner, P. Fuchs and others	for their work on the components, circuits which were really necessary for the realization of the EP equipment.
Mrs. J. Schwanengel, Mrs. Hiller, Dr. M. Jakobi	for her very kind help with all administrative tasks connected with preparation of this work and my defense at TUM
Mrs. E. Schmidt	Secretary of Prof. Wolfbeis, for her help with administrative tasks
To others	which are not listed here and contributed by their piece to this work

Last but not least, thanks to Bibiana who has given up her career in Slovakia to follow me to Germany, and finally many thanks to my whole family.

The work was supported by the project "KOMBISENS" from German Ministry for Science and Technology.

Rev. 25.12.2004