

TECHNISCHE UNIVERSITÄT MÜNCHEN
ZENTRUM MATHEMATIK

**HOMOGENIZATION OF MANY-BODY STRUCTURES SUBJECT
TO LARGE DEFORMATIONS AND NONINTERPENETRATION**

Philipp Emanuel Stelzig

Vollständiger Abdruck der von der Fakultät für Mathematik der Technischen Universität München zur Erlangung des akademischen Grades eines

Doktors der Naturwissenschaften (Dr. rer. nat.)

genehmigten Dissertation.

Vorsitzende: Univ.-Prof. Dr. Simone Warzel
Prüfer der Dissertation: 1. Univ.-Prof. Dr. Martin Brokate
2. Univ.-Prof. Dr. Hans-Dieter Alber
(Technische Universität Darmstadt)

Die Dissertation wurde am 9. Juli 2009 bei der Technischen Universität München eingereicht und durch die Fakultät für Mathematik am 25. November 2009 angenommen.

CONTENTS

1	Introduction	1
1.1	State of the art	3
1.2	From application to the thesis' matter	5
1.2.1	Some structural elements of pneumatic tires	5
1.2.2	The thesis' matter	7
1.3	Outline of the thesis	11
2	Problem and model	13
2.1	Geometry	13
2.1.1	The 2D-structure	14
2.1.2	The 3D-structure	15
2.2	Material, kinematics and loads	16
2.2.1	Constitutive assumptions	21
2.2.2	Mechanical contact in nonlinear elasticity	27
2.2.3	Kinematic assumptions	35
2.2.4	External loads	37
2.2.5	Total energy and Euler-Lagrange-equations	38
3	Methodology and mathematical concepts	47
3.1	Variational homogenization	47
3.2	Asymptotics of minimum problems: Γ -convergence	48
3.3	SBV and its calculus	52
3.3.1	(Special) Functions of bounded variation	53
3.3.2	Compactness and lower semicontinuity in SBV^p	63
3.3.3	Imposing additional regularity within SBV^p	67
4	Analysis of the mathematical model	75
4.1	Existence of minimizers	75
4.2	Asymptotic analysis: homogenization by Γ -convergence	76
4.3	Homogenization of the 2D-structure	78
4.3.1	Heuristic derivation and Γ -convergence statement	78

4.3.2	Proof of the Γ -lim inf-inequality	81
4.3.3	Proof of the Γ -lim sup-inequality	82
4.3.4	Improving Γ -convergence to more general deformations	115
4.3.5	Mathematical discussion and mechanical interpretation	119
4.4	Homogenization of the 3D-structure: $\gamma = 0$	121
4.4.1	Heuristic derivation and Γ -convergence statement	121
4.4.2	Proof of the Γ -lim inf-inequality	125
4.4.3	Proof of the Γ -lim sup-inequality	125
4.4.4	Improving Γ -convergence to more general deformations	132
4.4.5	Mathematical discussion and mechanical interpretation	133
4.5	Homogenization of the 3D-structure: $\gamma \neq 0$	134
4.5.1	Heuristic derivation and Γ -convergence statement	134
4.5.2	Proof of the Γ -lim inf-inequality	137
4.5.3	Proof of the Γ -lim sup-inequality	143
4.5.4	Mathematical discussion and mechanical interpretation	145
A	Mathematical definitions and notation	149
A.1	Denomination of convergence	149
A.2	Domains, balls, spheres	149
A.3	Polyhedral sets	150
A.4	Regularity of domains	151
A.5	Vectors and matrices	151
A.5.1	Vector-calculus	151
A.5.2	Matrix-calculus	152
A.6	Terms from measure theory	153
A.7	Continuous and continuously differentiable functions	153
A.7.1	Spaces of continuous and continuously differentiable functions	153
A.7.2	Differential calculus for continuously differentiable functions	154
A.8	L^p -spaces, distributional derivatives, Sobolev-spaces	154
A.8.1	L^p -spaces	154
A.8.2	Distributional derivatives	155
A.8.3	Sobolev-spaces	155

CHAPTER 1

INTRODUCTION

In this thesis the author rigorously derives mathematical models describing the mechanics of some specific many-body structures under large deformations, for the case that the structures are composed of a very large number of identical continuous elastic bodies. The reader will appreciate the importance of this type of question, just after having searched his present environment for objects formed by many identical elastic items. For example the woven clothes the reader most probably wears when going through this work are composed of many small identical fibres, i.e. one dimensional objects forming two-dimensional shirts, trousers... Perhaps he is currently sitting on a chair partially made of plywood, which consists of a large number of thin sheets of wood, laminated on top of each other. Presumably the reader is also surrounded by masonry walls built from bricks and mortar in between (which hopefully do not undergo large deformations while reading the manuscript). Before continuing the list of examples by further moving away from the reader, he should note that also all larger organic objects are formed by many small (but not necessarily all identical) cells. Hence, the reader himself is at least in parts (e.g. organs, muscles) mechanically nothing else than a many-body structure composed of very many, more or less identical elastic cells.

Of course, one should not expect the thesis to contain mathematical models covering the huge variety of the above mentioned examples. Instead, the author will concentrate on some specific space-filling, laminated many-body structures similar to those that can be found in tire reinforcement technology, namely the so-called cord-belts. The nature of this application as a motivation for the thesis' considerations will be characterized later in the introduction, see Subsection 1.2.1.

Common for the thesis' matter and all the previously given examples for many-body structures is the fact, that the scientists' or engineers' main interest focusses on their behaviour on the application-relevant length scale, i.e. on the scale on which one actually interacts with a many-body structure. This should come along with the observation, that the characteristic size of the structure's

subbodies is far smaller than the relevant length scale. Furthermore, many-body structures like the above mentioned can consist of thousands of subbodies, which may come into mechanical contact, but not interpenetrate each other. As a vital phenomenon in the mechanics of many-body structures, noninterpenetration of matter has to be accounted for in every reasonable mechanical model. Regarding the complexity of a single contact problem in a numerical treatment though, one is highly interested in alternative descriptions of many-body structures, which do not pay attention to every single possible contact problem. The just described issues are illustrated by the following example. A common brick has a diagonal of about 0.3 m, whereas the outer dimensions of large brick walls can be 20 m or more. Thus such a wall is built from about $10^3 \div 10^4$ bricks, with the relevant length scales for the bricks on the one hand and for the masonry wall on the other hand differing by nearly two orders of magnitude.

Yet, a method to reduce the description of many-body structures consisting of large numbers of identical elastic bodies to the application-relevant length scale and to simultaneously decrease the number of contact problems to be treated is to average out in whatever sense the scale of the subbodies. The suchlike approach commonly employed in modern mathematics is to depart from a mathematical description of a many-body structure that accounts for all of its subbodies and global noninterpenetration, and to study the asymptotics of the description as the structure composes of more and more bodies, i.e. as the characteristic size of the subbodies vanishes. This passage is what mathematicians call homogenization of the many-body structure.

In order to provide a simplified model for some special many-body structures resembling the mentioned cord-belts, the author applies the strategy of homogenization and studies the asymptotics of the associated mathematical description by means of Γ -convergence. Mathematically, in doing so the author enters the challenging field of variational homogenization of many-body structures in geometrically nonlinear elasticity subject to global noninterpenetration constraints.

Before giving an outline of the thesis' matter and results, the author includes a rough classification of many-body structures, accompanied by a short literature review of the most important contributions to the homogenization of the respective types of many-body structures. In view of the various techniques and approaches corresponding to different many-body structures and mechanical regimes, the reader will then find it easier to comprehend the author's mechanical modelling and his mathematical strategy for the homogenization thereof.

1.1 HOMOGENIZATION OF MANY-BODY STRUCTURES: STATE OF THE ART

Real-life many-body structures involving large numbers of identical elastic bodies can be roughly classified into two categories. The first one is of what the author calls the matrix-inclusion type, in which a connected matrix material surrounds the many identical subbodies of the structure, assigning them the role of inclusions. This type is usually encountered in reinforced materials like steel-reinforced concrete or fibre-reinforced composites, wherein the reinforcement compensates for a lack of stiffness in the surrounding matrix. The second type of many-body structures summarizes those, in which there is no surrounding object keeping the many identical subbodies together. Instead, the subbodies are free to move. They may however be initially glued together along their surfaces or parts thereof – which though poses no kinematic restriction, if the bonds can be broken. In this thesis' context the second type is referred to as free many-body structures. Examples therefor are the already cited masonry walls or the cord-belt resembling structures (see the next Subsection 1.2.2) as they are studied in the thesis.

A major difference between the two types of many-body structures is, that the deformed shape of a matrix-inclusion type many-body structure is governed by the matrix material. Note, that its inclusions are in general not even visible to the observer, like in the case of most fibre-reinforced composites. Consequently, the deformed shapes of the matrix-inclusion type are far more regular compared to free many-body structures, which can completely fall apart into their constituents.

Subsequent to this mechanical classification, one has then to decide, whether the respective many-body structures are exposed to small deformations and can because of this be treated in a geometrically and constitutively linear setting. Or they undergo large deformations and have therefore to be modelled in a geometrically and possibly also constitutively nonlinear setting.

Surprisingly, regarding the importance and the widespread use of the described many-body structures in applications, there is very little mathematical literature available on their homogenization. Most of the related works have been written in recent years. Moreover, in the few existing the therein (and also in this thesis) considered geometries and assumptions on the mechanics remain on an academic level.

For the geometrically and constitutively linear setting, there exist contributions for the homogenization of both the matrix-inclusion type and the free-many body structures, provided the subbodies are arranged periodically within the structures. The restriction of noninterpenetration of matter in the respective mathematical models is accounted for by means of a boundary condition – the so-called Sig-

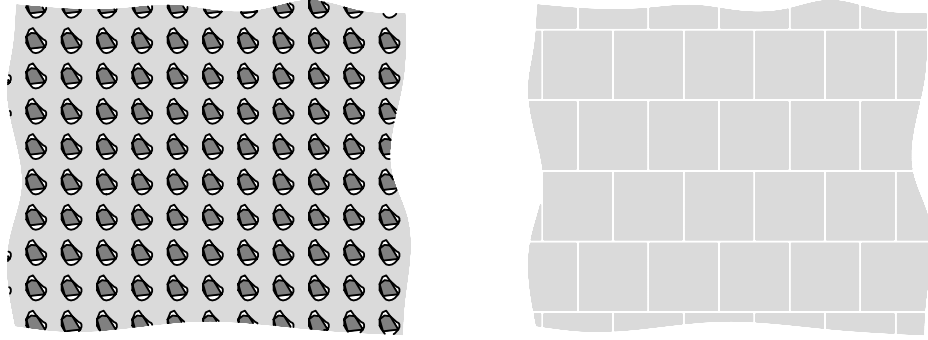

Figure 1.1: Matrix-inclusion type (left) and free many-body structures (right)

norini condition – imposed on subbodies, which potentially contact as the many-body structure deforms. However, the Signorini condition itself describes in a variational context only frictionless mechanical contact. Details on this linearized formulation of noninterpenetration of matter can be found in the original work Signorini [1933] or [Kikuchi and Oden, 1988, Chapter 2]. For the homogenization of matrix-inclusion like many-body structures, illustrated in Figure 1.1 (left), the reader might give a look to Mikelić et al. [1998] for soft inclusions, and to Iosif'yan [2004] for the case of rigid inclusions. In both works, the authors used methods related to two-scale convergence (cf. Allaire [1992]) to study the asymptotics of the corresponding mathematical models of the many-body structures. Another very interesting recent contribution of Scardia [2008] deals with the situation of brittle inclusions, periodically embedded into an elastic matrix. As concerns the homogenization of free many-body structures in the linear setting, there are even less related articles available than for the matrix-inclusion type. However, the main advance herein is due to Braides and Chiadò Piat [2006]. They use Γ -convergence to describe the asymptotic behaviour of the total energy associated with a periodic, space-filling structure, in which the subbodies are *not* glued together. Such model comprises the homogenization of masonry-like structures (cf. the right of Figure 1.1) without mortar between the bricks. Evident from the given literature is the previously mentioned fact, that the matrix-inclusion type behaves far more regular than a free many-body structure. Indeed, in all the cited works on the homogenization of matrix-inclusion type many-body structures the homogenization limits admit only Sobolev-, i.e. H^1 -regular deformations. Remembering that the nonhomogenized descriptions allowed for jumps of the deformations across contact boundaries within the many-body structures, the homogenization process for the matrix-inclusion type results in a gain of regularity. In contrast, because of the fact that the constituents of free-many body structures are completely free to move, the homogenization limit in Braides and Chiadò Piat [2006] acts on

a space of far more irregular deformations, that is on the space of functions of bounded deformation BD (see Temam and Strang [1980] for the latter). Hence, the homogenization of free many-body structures is expected to come along with a loss of regularity.

For many-body structures on the other hand, which are exposed to large deformations and therefore have to be treated in a geometrically and maybe also constitutively nonlinear context, there is no homogenization approach available in the mathematical literature yet. Neither for the matrix-inclusion type nor for free many-body structures.

With the present thesis the author gives a first contribution to the homogenization of free many-body structures in a geometrically and constitutively nonlinear setting by studying some specific application-related free many-body structures, which will be motivated in the upcoming section. However, the reader should be aware, that the thesis' goal is to provide a homogenization result for these structures and does – due to the difficult nature of the problem – not come up with a general theory. Although some of the tools and ideas developed or effects studied for the thesis' purposes might also be useful for a generalization of the matter.

1.2 FROM APPLICATION TO THE THESIS' MATTER

The geometry of the many-body structures analyzed in this thesis goes back to the following application in tire reinforcement technology.

1.2.1 Some structural elements of pneumatic tires

Pneumatic tires like they are used today for cars, motorcycles, trucks or airplanes derive their outer shape and in particular their mechanical stability from their inner reinforcements, the essential part of which is the carcass. As concerns the various components of a pneumatic tire and their denomination in engineering usage, the reader probably finds Figure 1.2 a valuable source of information; an introductory exposition of the matter is furthermore given in Wong [2001]. The carcass as the basic structural element consists of a number of layers of flexible cords, themselves made from material of high elastic modulus (e.g. steel, nylon,...). Its main task is to compensate for the surrounding rubber's lack of stiffness. A cord is a type of wire-rope, in which a small number of wires (typically $\lesssim 10$) are twisted together; its main characteristic is its high tensile strength. Inside the carcass, one distinguishes different structural elements, each of which consists itself of cord-layers and performs a specific task. The carcass plies for example give the tire its outer shape, and act as a support for both the other structural elements of the carcass and the rubber. Generally, the design of the carcass varies

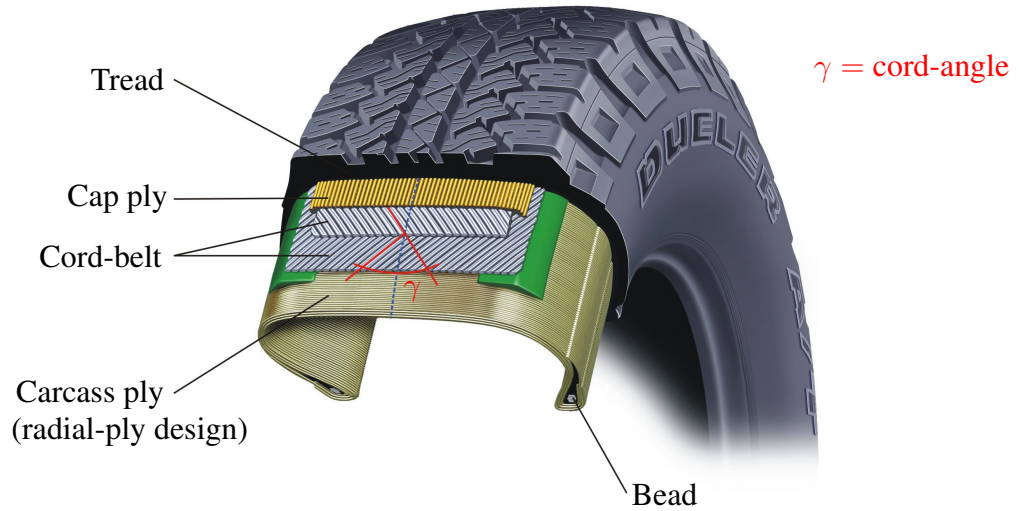

Figure 1.2: Structural elements of a pneumatic tire (courtesy of the Bridgestone Corporation)

strongly with the intended use of the tire. Important design parameters are the cord-orientations in single layers of the various structural elements. To this end, engineers call the angle between the circumferential center-line of the tire and the cord-orientation within a single layer crown-angle. Whereas the angle enclosed by the cord-orientations in two subsequent layers within one structural element is referred to as the cord-angle and denoted γ (cf. Figure 1.2). Indeed, depending on the cord-orientations in the carcass plies one distinguishes two major carcass designs, namely what is publicly known as radial-ply (radial tire) and bias-ply (diagonal tire) design.

In the bias-ply configuration, which is employed for heavy load tires or offroad tires, the carcass plies consists of several layers of cords running from bead to bead. Herein, the cord-orientation w.r.t. the circumferential center-line of the tire alternates in adjacent layers between the angles $\frac{\gamma}{2}$ and $-\frac{\gamma}{2}$, $0^\circ < \frac{\gamma}{2} < 90^\circ$. According to Wong [2001], in bias-ply tires the cord-angle is usually about 80° , and the number of cord-layers composing the carcass again highly depends on the scope of use of the tire – heavy load tires may come up with as many as 20 layers or more.

Nowadays, the dominant carcass-design is the radial-ply configuration, which corresponds to a bias-ply design for 180° cord-angle, i.e. all cords within the carcass-ply are oriented parallelly and extend radially from bead to bead, as for instance seen in Figure 1.2. The radial-ply usually consists of less layers than the

bias-ply. Apart from the all parallelly oriented cord-layers within the carcass-ply, also the radial-ply design commonly features the previous sandwich-structure of cord-layers running alternately in opposite directions w.r.t. the circumferential center-line of the tire. It is found beneath the tread and rests upon the radial carcass-ply, where it forms what is named cord-belt or simply belt. Usually, the belt is made up from several (up to four) layers of cords, with the cord-orientations in two subsequent layers enclosing an angle of approximately 40° citing Wong [2001].

Evident from the just presented extensive use of layered structures of parallelly or non-parallelly oriented cords is the need for a mathematical model describing their mechanical response to externally applied loads or deformations. Calling any attempt to write down a model accounting for all possible effects within cord-belt like structures challenging is at best an understatement, since it comprises all the “worst nightmares” of three-dimensional continuum mechanics. Not only has such structure to be modelled in terms of geometrically nonlinear continuum mechanics as it is exposed to large deformations, it also combines materials of highly nonlinear response, which differ moreover strongly in their modulus of elasticity (low values for rubber versus high values for cords from steel, nylon. . .). It is multi-scale, ranging from the wires within a cord over single cord-layers to the whole belt structure. In particular, the author now returns to the context of the previous section by emphasizing that cord-belts are many-body structures.

1.2.2 The thesis’ matter

Goal of this thesis is to analyze, how the fact of being composed of a large number of layers of slender elastic bodies enters the mechanical response of cord-belt like structures to large deformations. This led the author to study idealized cord-belt like many-body structures consisting of identical, straight elastic beams with quadratic cross-section and being arranged like in the geometry

$$\mathcal{D}_3 := \bigcup \{(0, a_2, 2a_3) + \mathcal{B} : a_2, a_3 \in \mathbb{Z}\} \\ \cup R_\gamma \left(\bigcup \{(0, a_2, 2a_3 - 1) + \mathcal{B} : a_2, a_3 \in \mathbb{Z}\} \right).$$

Herein, $\mathcal{B} = \mathbb{R} \times (0, 1)^2$ and R_γ is the rotation about the vertical axis through the cord-angle γ , which takes a value $0^\circ \leq \gamma \leq 90^\circ$. Figure 1.3 depicts the geometry of the set \mathcal{D}_3 . More specifically, the author investigates the free many-body structures

$$\Omega_\varepsilon := \Omega \cap \varepsilon \mathcal{D}_3,$$

$\varepsilon \mathcal{D}_3$ being the ε -homothety of \mathcal{D}_3 . The macroscopic shape Ω of the many-body structure Ω_ε may in case of zero cord-angle γ be a beam-like object $\Omega = (0, \ell) \times \omega$,

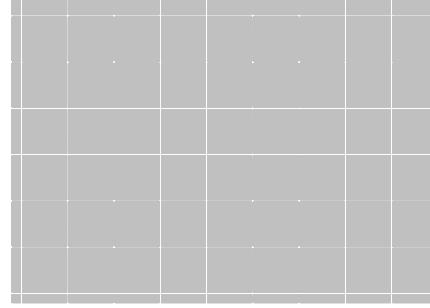
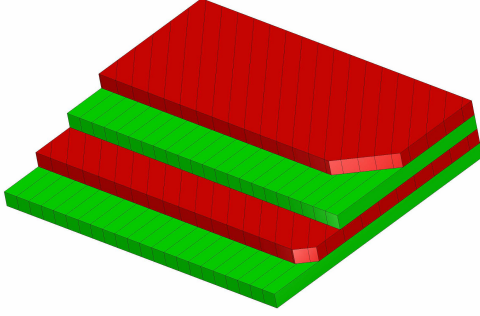

Figure 1.3: A geometry mimicking the cord-belt characteristic layered structure
 Figure 1.4: Model geometry for a free many-body structure

or in case of nonzero cord-angle a plate like $\Omega = \omega \times (-a, a)$. In both cases ω is assumed to be a sufficiently regular bounded domain in \mathbb{R}^2 . Whereas ε is a small positive parameter, to be interpreted as the ratio of the linear size of the subbodies of the many-body structure Ω_ε relative to its macroscopic shape Ω . As a simple but still nontrivial model problem for free many-body structures, the author furthermore studies a two-dimensional many-body structure

$$\Omega_\varepsilon := \Omega \cap \varepsilon \mathcal{D}_2, \quad \mathcal{D}_2 := \bigcup_{a \in \mathbb{Z}^2} (a + (0, 1)^2),$$

the subbodies of which are according to \mathcal{D}_2 (cf. Figure 1.4) periodically arranged unit cells. In this two-dimensional case, the macroscopic shape Ω is some bounded domain with smooth enough boundary. It is no coincidence though that \mathcal{D}_2 is the cross-section of \mathcal{D}_3 for zero cord-angle γ .

In compliance with the thesis' goal to study the mechanical response of the just introduced many-body structures to large deformations $\varphi : \Omega_\varepsilon \rightarrow \mathbb{R}^3$, their kinematics have to reflect the needs of geometrically nonlinear continuum mechanics. Besides the for all deformations obligatory requirement to preserve the local orientation (i.e. the determinant of the deformation gradient $\det \nabla \varphi$ has to be positive), this implies first of all the need for a reasonable noninterpenetration constraint that is compatible with large deformations. As an appropriate formulation the author finds the Ciarlet-Nečas condition

$$\text{vol } \varphi(\Omega_\varepsilon) \geq \int_{\Omega_\varepsilon} |\det \nabla \varphi| \, dx,$$

which together with the principle of local orientation preservation turns out to be an injectivity statement for the deformation φ . Moreover, the author demands the

deformed configurations of the above many-body structures Ω_ε to be confined in a rigid environment \mathbf{Box} . Based upon the fact that the many-body structures Ω_ε are space-filling, i.e. fill their macroscopic shape Ω up to a set of zero volume, any deformation φ of the many-body structure Ω_ε can be identified with a deformation of the macroscopic shape Ω . In this work's context then, a deformation φ of a many-body structure Ω_ε is kinematically admissible (and guarantees indeed noninterpenetration of matter), if its identification with a deformation of the macroscopic shape Ω lies in the set $\text{Kin}(\Omega; \mathbf{Box})$ of all deformations of Ω preserving the local orientation, obeying the Ciarlet-Nečas condition and deforming Ω into the rigid environment \mathbf{Box} .

From a constitutive point of view, the subbodies of the many-body structures are assumed to be of a homogeneous, hyperelastic material with some polyconvex elastic energy density $W : \mathbb{M}^N \rightarrow [0, \infty]$, the prototype of which is the compressible neo-Hookean material

$$W(F) = \begin{cases} \alpha_1 |F|^p + \alpha_2 (\det F)^{\frac{p}{N}} + \alpha_3 \frac{1}{(\det F)^\sigma} & \text{if } \det F > 0, \\ \infty & \text{else} \end{cases}$$

with p larger than the space dimension $N = 2$ or 3 and $\sigma > 0$. Furthermore, the subbodies within the free many-body structures Ω_ε are assumed to be initially glued together along the inner contact boundary $\Omega \cap \partial\Omega_\varepsilon$, in that neighbouring subbodies within Ω_ε exhibit a brittle bond across their common surface, described by some surface energy density $\theta : [0, \infty) \rightarrow [0, \infty)$. Prototypical for this is a variant of Griffith's surface energy density

$$\theta(t) = \begin{cases} 0 & \text{if } t = 0, \\ \alpha_{\text{Griffith}} + \alpha_{\text{ad}} t^\rho & \text{if } t > 0 \end{cases}$$

with $0 < \rho < 1$. The total energy stored in a by $\varphi \in W^{1,p}(\Omega_\varepsilon; \mathbb{R}^N) \cap \text{Kin}(\Omega; \mathbf{Box})$ deformed many-body structure Ω_ε is

$$\mathcal{F}_\varepsilon(\varphi) = \int_{\Omega_\varepsilon} W(\nabla\varphi) \, dx + \int_{\Omega \cap \partial\Omega_\varepsilon} \theta(|\varphi^+ - \varphi^-|) \, d\mathcal{H}^{N-1},$$

φ^+ and φ^- denoting the values of φ on the inner contact boundary $\Omega \cap \partial\Omega_\varepsilon$ when approaching it from opposite sides. Whereas \mathcal{H}^{N-1} is the $(N - 1)$ -dimensional Hausdorff-measure.

In order to obtain an effective description of the mechanical response of the free many-body structures Ω_ε to large deformations, the author applies the homogenization approach, i.e. he studies the asymptotic behaviour of the associated total energy \mathcal{F}_ε as the characteristic size ε of the subbodies vanishes. Indeed, upon extending the total energy \mathcal{F}_ε by ∞ to the set $SBV^p(\Omega; \mathbb{R}^N) \cap \text{Kin}(\Omega; \mathbf{Box})$,

for the two-dimensional model problem as well as for the cord-belt like three-dimensional many-body structures the author identifies in the sense of Γ -convergence a homogenization limit

$$\mathcal{F}_{\text{Hom}} : SBV^p(\Omega; \mathbb{R}^N) \cap \text{Kin}(\Omega; \mathbf{Box}) \rightarrow [0, \infty].$$

The set $SBV^p(\Omega; \mathbb{R}^N)$ is the subspace of the special functions of bounded variation in Ω , the elements of which have p -integrable approximate differential and a discontinuity set of finite \mathcal{H}^{N-1} -measure.

In case of the two-dimensional many-body structure, one observes increasingly anisotropic fracture behaviour as the size ε of the constituents vanishes. This effects becomes manifest in the two-dimensional homogenization limit, as the total energy stored in the by $\varphi \in SBV^p(\Omega; \mathbb{R}^2) \cap \text{Kin}(\Omega; \mathbf{Box})$ deformed homogenized body is

$$\mathcal{F}_{\text{Hom}}(\varphi) = \int_{\Omega} W(\nabla\varphi) \, dx + \int_{S_{\varphi}} (|\nu_{\varphi,1}| + |\nu_{\varphi,2}|) \theta(|\varphi^+ - \varphi^-|) \, d\mathcal{H}^1,$$

ν_{φ} being the normal onto the crack S_{φ} generated by φ , φ^+ and φ^- the values of φ thereon when approaching it from opposite sides.

A similar behaviour is observed in the cord-belt like three-dimensional many-body structure with zero cord-angle. Again the fracture behaviour becomes increasingly anisotropic as one employes more and more subbodies in Ω_{ε} , the anisotropy effect being the same as seen in the two-dimensional model problem. Mathematically, the corresponding homogenization limit \mathcal{F}_{Hom} reads in a deformation $\varphi \in SBV^p(\Omega; \mathbb{R}^3) \cap \text{Kin}(\Omega; \mathbf{Box})$

$$\mathcal{F}_{\text{Hom}}(\varphi) := \begin{cases} \int_{\Omega} W(\nabla\varphi) \, dx + \int_{S_{\varphi}} (|\nu_{\varphi,2}| + |\nu_{\varphi,3}|) \theta(|\varphi^+ - \varphi^-|) \, d\mathcal{H}^2 & \text{if } \nu_{\varphi,1} = 0 \text{ } \mathcal{H}^2\text{-a.e. on } S_{\varphi}, \\ \infty & \text{else} \end{cases}$$

Like in the many-body structures Ω_{ε} due to the zero cord-angle, also in the homogenization limit only cracks parallel to the original cord-orientation are attainable.

In the situation of the two-dimensional many-body structure and the three-dimensional many-body structure with zero cord-angle, the by \mathcal{F}_{Hom} described homogenized bodies have more degrees of freedom (in fracture) than the respective many-body structures Ω_{ε} . In particular, the homogenized body undergoes all deformations $\varphi \in W^{1,p}(\Omega_{\varepsilon}; \mathbb{R}^N) \cap \text{Kin}(\Omega; \mathbf{Box})$ of the respective many-body structures Ω_{ε} with the same energy. In contrast, the homogenization limit of the cord-belt like many-body structure with nonzero cord-angle $0^\circ < \gamma \leq 90^\circ$ is found to admit only horizontal cracks, i.e. cracks parallel to the beam layers in

the geometry \mathcal{D}_3 . Mathematically, the homogenization limit \mathcal{F}_{Hom} is in a deformation $\varphi \in SBV^p(\Omega; \mathbb{R}^3) \cap \text{Kin}(\Omega; \mathbf{Box})$ for all cord-angles $0^\circ < \gamma \leq 90^\circ$ the same

$$\mathcal{F}_{\text{Hom}}(\varphi) := \begin{cases} \int_{\Omega} W(\nabla\varphi) \, dx + \int_{S_{\varphi}} \theta(|\varphi^+ - \varphi^-|) \, d\mathcal{H}^2 & \text{if } \nu_{\varphi,1} = \nu_{\varphi,2} = 0 \text{ } \mathcal{H}^2\text{-a.e. on } S_{\varphi}, \\ \infty & \text{else} \end{cases}$$

The by \mathcal{F}_{Hom} described homogenized body has less degrees of freedom (in fracture) than the cord-belt like many-body structure with nonzero cord-angle, which allowed for vertical cracks also, meaning that new kinematic restrictions arise as one employes more and more subbodies in the many-body structure.

During the Γ -convergence analysis of the total energies $(\mathcal{F}_{\varepsilon})_{\varepsilon}$, the author was confronted with the task to provide approximative deformations for certain $\varphi \in SBV^p(\Omega; \mathbb{R}^N) \cap \text{Kin}(\Omega; \mathbf{Box})$ while conserving the kinematic restrictions formulated in $\text{Kin}(\Omega; \mathbf{Box})$, i.e. a.e.-positivity of the determinant of the deformation gradient, the thereby and the Ciarlet-Nečas condition implied a.e.-injectivity and the confinement condition to attain values in \mathbf{Box} only. Since these constraints exclude traditional arguments like reflection and setting a deformation's values to 0 on sets of positive volume, the author made instead use of what he calls *pre-deformations*. A bijective function $\Phi : \Omega \setminus K \rightarrow \Omega'$, where K is empty or a compact subset of \mathbb{R}^N with finite \mathcal{H}^{N-1} -mass and Ω' an open subset of Ω , is said to be a pre-deformation, if

$$\begin{aligned} \Phi &\in W^{1,\infty}(\Omega; \mathbb{R}^N), \\ \Phi^{-1} &\in W^{1,\infty}(\Omega'; \mathbb{R}^N) \text{ and } \Phi^{-1} \text{ is Lipschitz,} \\ \det D\Phi &> 0 \text{ a.e.} \end{aligned}$$

By modification and combination of known results for $SBV^p(\Omega; \mathbb{R}^N)$, it is proved that pre-deformations conserve the kinematic restrictions $\text{Kin}(\Omega; \mathbf{Box})$ in the sense that

$$\begin{aligned} \varphi &\in SBV^p(\Omega; \mathbb{R}^N) \cap \text{Kin}(\Omega; \mathbf{Box}) \\ &\Rightarrow \varphi \circ \Phi \in SBV^p(\Omega; \mathbb{R}^N) \cap \text{Kin}(\Omega; \mathbf{Box}). \end{aligned}$$

This insight might also be useful for other than the thesis' purposes.

1.3 OUTLINE OF THE THESIS

The thesis is organized as follows. In Chapter 2 the author establishes in full detail the in the last section roughly sketched mathematical models. A large part

of the chapter is devoted to the discussion of the Ciarlet-Nečas condition as a formulation of noninterpenetration of matter. At the end of Chapter 2 the author includes the Euler-Lagrange equations for the total energies associated with the many-body structures and discusses them from a mechanical point of view.

Chapter 3 introduces the concept of Γ -convergence and some of its basic properties as far as they are needed throughout the work. It also features a short exposition of the theory of (special) functions of bounded variation, strictly fitted to the thesis' needs. Therein the reader finds known compactness and lower semi-continuity results for bulk and surface integral functionals, the by Alessandro Giacomini and Marcello Ponsiglione recently proved stability of the Ciarlet-Nečas condition under a suitable convergence notion and some existence results for energy functionals related to the ones of Chapter 2, as well as some slightly but usefully generalized technical propositions.

Subject of Chapter 4 is finally the homogenization of the many-body structures as they were defined previously; it is however preceded by guidelines of how to use pre-deformations. The homogenization results themselves are then separately presented, according to the two-dimensional many-body structure (Section 4.3), the cord-belt like many-body structure with zero cord-angle (Section 4.4) and the cord-belt like many-body structure with nonzero cord-angle (Section 4.5). The homogenization results are in every case accompanied by a discussion, on both their mathematical and mechanical quality.

For the mathematical notation or to the reader unfamiliar concepts he might turn to Appendix A, where some frequently encountered symbols and notation, vector- and matrix-calculus, the domain regularity of being nonoscillating, polyhedral sets and the in the thesis employed function spaces are presented clearly.

CHAPTER 2

PHYSICAL PROBLEM AND MATHEMATICAL MODEL

After the explanations in the introduction, the goal of the present chapter is to define rigorously the geometries of the many-body structures studied in the thesis and to establish in full detail a mathematical model describing their mechanics. The latter comprises apart from the characterization of the material properties and the load situation a comprehensive discussion of the many-body structures' kinematics. Emphasis rests therein on how one can mathematically guarantee noninterpenetration of matter within a many-body structure, which is exposed to large deformations. Subsequent to the statement of the total energies completely describing the mechanical response of the respective many-body structures, the end of the modelling part is marked by the computation and the following interpretation of the Euler-Lagrange equations. The latter will be appreciated by the reader, who deems himself rather a mechanician than a mathematician.

2.1 GEOMETRY

In this section the author introduces the geometries of the specific many-body structures motivated in the introduction and henceforth studied in this work.

To fix the nomenclature used in this work, a *many-body structure* in $N \in \{2, 3\}$ space dimensions is the finite union of pairwise disjoint domains, called the *subbodies*. It is associated with a *macroscopic shape* Ω , itself a bounded domain in \mathbb{R}^N containing the many-body structure and being filled by it up to a set of negligible volume, which is called the *inner contact boundary* Γ_C . In the present situation, many-body structures are assumed to be composed by congruent bodies (up to some few near the boundary of Ω) in the following sense. Let \mathcal{D} denote a tiling of the \mathbb{R}^N (up to a set of negligible volume) that can be written as the

union of countably many pairwise disjoint congruent domains. Call such \mathcal{D} the *microstructure* of the many-body structure Ω_ε , which is now given by

$$\Omega_\varepsilon := \Omega \cap \varepsilon\mathcal{D}.$$

Herein $\varepsilon > 0$ is the (small) *ratio of the linear size of the subbodies relative to the size of the macroscopic shape Ω* .

2.1.1 The 2D-structure

The following two-dimensional microstructure \mathcal{D}_2 , which is a simple collection of open unit squares arranged along the \mathbb{Z}^2 -grid, is to be understood as a model problem. In mathematical notation

$$\mathcal{D}_2 := \bigcup_{a \in \mathbb{Z}^2} (a + (0, 1)^2), \quad (2.1)$$

see also Figure 2.1.

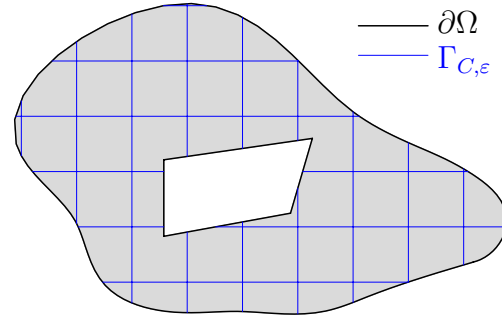

Figure 2.1: The two-dimensional microstructure \mathcal{D}_2

Figure 2.2: The two-dimensional many-body structure Ω_ε

One now considers the many-body structure Ω_ε as given in Definition of Geometry 2.1 (see also Figure 2.2 for visual help).

Definition of Geometry 2.1 (2D many-body structure). Let $\Omega \subseteq \mathbb{R}^2$ be a bounded nonoscillating Lipschitzian domain. Then the many-body structure Ω_ε with macroscopic shape Ω and microstructure \mathcal{D}_2 , and the associated inner contact boundary $\Gamma_{C,\varepsilon}$ are respectively defined as

$$\Omega_\varepsilon := \Omega \cap \varepsilon\mathcal{D}_2, \quad \text{and} \quad \Gamma_{C,\varepsilon} := \Omega \cap \partial\Omega_\varepsilon.$$

Note, that the author introduced the microstructure \mathcal{D}_2 mainly in order to test and develop new techniques and to detect possible effects arising in the (asymptotic) analysis of many-body structures of more general geometry.



Figure 2.3: Cord-belt of a tire (courtesy of the Bridgestone Corporation)

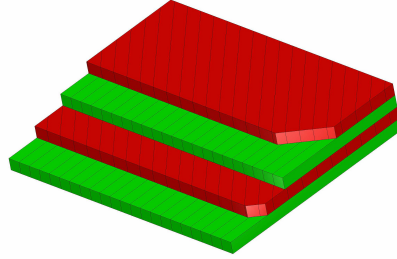

Figure 2.4: The three-dimensional microstructure \mathcal{D}_3

2.1.2 The 3D-structure

More oriented towards the application in reinforcement technology described in the introduction, i.e. cord-belts, is the geometry given below. A main geometrical characteristic of such cord-belts is that they consist of layers of parallelly oriented cords, with the cord-orientations of two subsequent layers enclosing the so-called *cord-angle* γ , see Figure 2.3. Reducing each cord's geometry to a beam with square cross section, an idealized model for a cord-belt's geometry accounting for its layered structure and its nature of being composed of a large number of slender elastic bodies is depicted in Figure 2.4. Adopting the in Section 2.1 introduced notation for many-body structures, one defines a three-dimensional microstructure \mathcal{D}_3 , parametrized by the cord-angle γ , that describes the geometry seen in Figure 2.4. Let $\mathcal{B} := \mathbb{R} \times (0, 1)^2$ temporarily denote an infinitely long straight beam in \mathbb{R}^3 , the cross section of which is the unit square. Now set

$$\mathcal{D}_3 := \bigcup \{ (0, a_2, 2a_3) + \mathcal{B} : a_2, a_3 \in \mathbb{Z} \} \\ \cup R_\gamma \left(\bigcup \{ (0, a_2, 2a_3 - 1) + \mathcal{B} : a_2, a_3 \in \mathbb{Z} \} \right).$$

Herein, R_γ is the rotation about the vertical axis through γ , i.e.

$$R_\gamma(x) = \begin{bmatrix} \cos \gamma & -\sin \gamma & 0 \\ \sin \gamma & \cos \gamma & 0 \\ 0 & 0 & 1 \end{bmatrix} x, \quad x \in \mathbb{R}^3.$$

For symmetry reasons, it suffices to consider cord-angles $0 \leq \gamma \leq \frac{\pi}{2}$.

One is told by mechanical intuition that many-body structures with microstructure \mathcal{D}_3 of nonzero cord-angle behave qualitatively differently from such of zero cord-angle. In the forthcoming studies, one therefore treats these two cases separately.

Definition of Geometry 2.2 (3D many-body structure with zero cord-angle). Let $\omega \subseteq \mathbb{R}^2$ be a bounded nonscillating Lipschitzian domain, $\ell > 0$ and a beam-like cylinder $\Omega := (0, \ell) \times \omega$ be given. Then the many-body structure Ω_ε with macroscopic shape Ω and microstructure \mathcal{D}_3 with zero cord-angle $\gamma = 0$, and the associated inner contact boundary $\Gamma_{C,\varepsilon}$ are respectively defined as

$$\Omega_\varepsilon := \Omega \cap \varepsilon \mathcal{D}_3, \quad \text{and} \quad \Gamma_{C,\varepsilon} := \Omega \cap \partial \Omega_\varepsilon.$$

Definition of Geometry 2.3 (3D many-body structure with nonzero cord-angle). Let $\omega \subseteq \mathbb{R}^2$ be a bounded Lipschitzian domain, $a > 0$ and a plate-like cylinder $\Omega := \omega \times (-a, a)$ be given. Then the many-body structure Ω_ε with macroscopic shape Ω and microstructure \mathcal{D}_3 with nonzero cord-angle $0 < \gamma \leq \frac{\pi}{2}$, and the associated inner contact boundary $\Gamma_{C,\varepsilon}$ are respectively defined as

$$\Omega_\varepsilon := \Omega \cap \varepsilon \mathcal{D}_3, \quad \text{and} \quad \Gamma_{C,\varepsilon} := \Omega \cap \partial \Omega_\varepsilon.$$

Remark 2.1. The restriction to beam-like macroscopic shapes in Definition of Geometry 2.2 and to plate-like macroscopic shapes in Definition of Geometry 2.3 is due to technical reasons. However, these or “derivatives” thereof are the geometries in which one would employ microstructures such as \mathcal{D}_3 (in the respective cases of zero and nonzero cord-angle).

2.2 CONSTITUTIVE REGIME, KINEMATICS AND EXTERNAL LOADS

Having in the last section specified the geometry of the structures to be studied, it remains to do so with the constitutive regime and the corresponding assumptions, and moreover with the kinematics.

The reader not familiar with basic concepts of (nonlinear) elasticity might find the monograph Ciarlet [1988] a valuable source of information. Since also the notation used by the author throughout the thesis was influenced by this monograph, the reader can easily use it as a reference for the present chapter.

As concerns the constitutive regime, both the two- and the three-dimensional many-body structures Ω_ε defined in the preceding subsection are assumed to be occupied by a *homogeneous material*, elastic in the sense of *Cauchy-elasticity*. This means, that the Cauchy-stress field $T^\varphi : \varphi(\Omega_\varepsilon) \rightarrow \mathbb{M}^N$ generated by a sufficiently smooth *deformation* $\varphi : \Omega_\varepsilon \rightarrow \mathbb{R}^N$ is in each point $\varphi(x)$ of the deformed configuration $\varphi(\Omega_\varepsilon)$ a material-dependent response function $\hat{T}^D(\nabla \varphi(x))$ of the *deformation gradient* $\nabla \varphi(x)$ only. Hence, also the first Piola-Kirchhoff-stress $T : \Omega_\varepsilon \rightarrow \mathbb{M}^N$ is a material-dependent response function $\hat{T}(\nabla \varphi(x))$ of the deformation gradient $\nabla \varphi(x)$ only. In addition to the Cauchy-elasticity hypothesis, the

author assumes the material occupying the many-body structures Ω_ε to be *hyper-elastic*, i.e. there shall exist an *elastic energy density*

$$W : \mathbb{M}^N \rightarrow [0, \infty] \quad \text{such that} \quad \hat{T}(F) = DW(F)$$

for all $F \in \mathbb{M}^N$ in which $\hat{T}(F)$ is defined. Note, that the value ∞ is explicitly allowed for an elastic energy density W , a fact which is exploited as follows. Setting W to ∞ on the subset of \mathbb{M}^N , on which the response function \hat{T} is not defined, renders deformations with gradients in this subset “energetically unattainable”. To conclude, one can state that the *elastic energy* $\mathcal{E}_{\varepsilon,\text{elast}}(\varphi)$ caused by some sufficiently smooth deformation $\varphi : \Omega_\varepsilon \rightarrow \mathbb{M}^N$ and stored in the deformed configuration $\varphi(\Omega_\varepsilon)$ is

$$\mathcal{E}_{\varepsilon,\text{elast}}(\varphi) := \int_{\Omega_\varepsilon} W(\nabla\varphi(x)) \, dx. \quad (2.2)$$

Detailed assumptions on the elastic energy density W are provided in the corresponding Subsection 2.2.1.

The inner contact boundary $\Gamma_{C,\varepsilon}$ of the many-body structures Ω_ε however is supposed to be covered with an infinitesimally thin layer of homogeneous adhesive material, initially glueing neighbouring subbodies together. One moreover assumes that the adhesive material is sufficiently weak, in that it forms a brittle bond between opposite surfaces. Thus in particular a bond that can be broken. Hereby, the adhesive shall be described by some *surface energy density* $\theta : \mathbb{R}^N \times \mathbb{R}^N \rightarrow [0, \infty)$ as follows. Let $\varphi : \Omega_\varepsilon \rightarrow \mathbb{R}^N$ be a deformation of the many-body structure Ω_ε , $x \in \Gamma_{C,\varepsilon}$ and $\varphi^+(x), \varphi^-(x)$ be the limits of the deformation φ in x when approaching it from opposite sides of $\Gamma_{C,\varepsilon}$. Then the *surface energy* caused by φ and stored in the deformed configuration $\varphi(\Omega_\varepsilon)$ shall be given by

$$\mathcal{E}_{\varepsilon,\text{surf}}(\varphi) := \int_{\Gamma_{C,\varepsilon}} \theta(\varphi^+(x), \varphi^-(x)) \, d\mathcal{H}^{N-1}(x), \quad (2.3)$$

wherein \mathcal{H}^{N-1} denotes the $(N - 1)$ -dimensional Hausdorff-measure. Precise assumptions on the surface energy density can also be found in Subsection 2.2.1.

Remark 2.2. The author emphasizes that the above introduced lamination poses *no restriction to the kinematics* of the many-body structures. Any “physically observable” deformation of a non-laminated many-body structure Ω_ε can also be undergone by its laminated counterpart.

As concerns the load situation, the author restricts himself to *applied (follower-) body loads*. This means that he assumes the applied body load field $f^\varphi : \varphi(\Omega_\varepsilon) \rightarrow \mathbb{R}^N$ in a point $\varphi(x)$ of the deformed many-body structure $\varphi(\Omega_\varepsilon)$ to be

described by a *density* $\hat{f}(x, \varphi(x))$ of the applied body load per undeformed unit volume. This density is a function of the mass point x and its position $\varphi(x)$ in the deformed configuration only. Furthermore he assumes the applied body load to be *conservative*, this is, there shall exist a *potential of the applied body load*

$$\hat{F} : \Omega \times \mathbb{R}^N \rightarrow \mathbb{R} \quad \text{such that} \quad \hat{f}(x, v) = \frac{\partial \hat{F}}{\partial v}(x, v)$$

for all $x \in \Omega$ and $v \in \mathbb{R}^N$. Thus the work done by the applied body load in deformed many-body structure $\varphi(\Omega_\varepsilon)$ is

$$\mathcal{E}_{\varepsilon, \text{extern}}(\varphi) := \int_{\Omega_\varepsilon} \hat{F}(x, \varphi(x)) \, dx. \quad (2.4)$$

As before the reader is referred to the corresponding Subsection 2.2.4 for further details on the potential of the applied body load.

Combining (2.2), (2.3) and (2.4), the *total energy* of a deformed many-body structure $\varphi(\Omega_\varepsilon)$ amounts to

$$\begin{aligned} \mathcal{E}_\varepsilon(\varphi) &= \mathcal{E}_{\varepsilon, \text{elast}}(\varphi) + \mathcal{E}_{\varepsilon, \text{surf}}(\varphi) - \mathcal{E}_{\varepsilon, \text{extern}}(\varphi) \\ &= \int_{\Omega_\varepsilon} W(\nabla \varphi(x)) \, dx + \int_{\Gamma_{C, \varepsilon}} \theta(\varphi^+(x), \varphi^-(x)) \, d\mathcal{H}^{N-1}(x) \\ &\quad - \int_{\Omega_\varepsilon} \hat{F}(x, \varphi(x)) \, dx, \end{aligned} \quad (2.5)$$

wherein φ is taken from a set of admissible deformations, call it V . Concerning V , the author again refers the reader to a forthcoming Subsection 2.2.3, stating so far only that V shall be a set of deformations of the many-body structure that accounts mathematically for the in (2.5) required regularity and physically for the kinematics of the many-body structure. Without going into details at this stage of the modelling, the author emphasizes that a deformation of a many-body structure is kinematically admissible, only if it guarantees *noninterpenetration of matter*.

One now calls a deformation $\varphi \in V$, such that the total energy of the deformed many-body structure $\varphi(\Omega_\varepsilon)$ is minimal, an equilibrium state of the many-body structure under the externally applied loads given above, that is

$$\varphi \text{ is an equilibrium state} \quad :\Leftrightarrow \quad \varphi \in \arg \min_V \mathcal{E}_\varepsilon.$$

Prior to returning to the energy densities W , θ and \hat{F} as well as to the set of admissible deformations, the author will shortly address the question of existence of an equilibrium state in an abstract setting. In doing so he will moreover introduce some basic concepts that will from then on be frequently encountered throughout the thesis.

Definition 2.4 (Sequential lower semicontinuity). Let (V, \mathcal{T}) be a topological space, $\mathcal{I} : V \rightarrow (-\infty, \infty]$ a function.

One says that \mathcal{I} is *sequentially lower semicontinuous in* $v \in V$, if for all sequences $(v_k)_k$ in V converging to v it is

$$\mathcal{I}(v) \leq \liminf_{k \rightarrow \infty} \mathcal{I}(v_k).$$

The function \mathcal{I} is said to be *sequentially lower semicontinuous*, if \mathcal{I} is sequentially lower semicontinuous in all $v \in V$.

This concepts comes along with the main advantage, that sequential lower semicontinuity together with some compactness is sufficient to guarantee the existence of minimizers.

Proposition 2.5. *Let (V, \mathcal{T}) be a topological space and $\mathcal{I} : V \rightarrow (-\infty, \infty]$ be a function that*

- (i) *is bounded from below,*
- (ii) *is sequentially lower semicontinuous,*
- (iii) *has sequentially precompact sublevels, i.e. for all $C \in \mathbb{R}$, every sequence in the set $L_C := \{v : v \in V, \mathcal{I}(v) \leq C\}$ contains an in V convergent subsequence.*

Then \mathcal{I} attains its minimum.

Proof. By the direct method of the calculus of variations. □

In the classical situation of V being a reflexive Banach-space, the above proposition in combination with coercivity and either weak sequential lower semicontinuity, or strong sequential lower semicontinuity together with convexity immediately entails the existence of minimizers.

Corollary 2.6. *Let $(V, \|\cdot\|)$ be a reflexive Banach-space, $\mathcal{I} : V \rightarrow (-\infty, \infty]$ be bounded from below and coercive, i.e. $\mathcal{I}(v_k) \rightarrow \infty$ for all sequences $(v_k)_k$ with $\|v_k\| \rightarrow \infty$. Then from*

- (i) *sequential lower semicontinuity of \mathcal{I} w.r.t. the weak topology in V*

or from

- (ii) *convexity and sequential lower semicontinuity of \mathcal{I} w.r.t. the norm topology in V*

follows the existence of a minimizer of \mathcal{I} .

In order to eventually specify the energy densities W, θ and \hat{F} , one needs to decide about the *geometric regime* in which the above described problem shall be treated. In other words, one has to decide, whether the many-body structures Ω_ε are exposed to *small deformations* and can thus be treated within the classical context of *geometrically linearized elasticity*, or are exposed to *large deformations* and consequently have to be treated in at least *geometrically nonlinear elasticity*. Regarding the engineering origin of the three-dimensional many-body structures Ω_ε of Section 2.1, one has at minimum to expect large rotations of parts of the many-body structures and therefore to use geometrically nonlinear elasticity. Again, the with geometrically nonlinear elasticity unfamiliar reader is encouraged to turn to the monograph Ciarlet [1988]. Yet the use of geometrically nonlinear elasticity restricts the above mathematical model by the following conditions. From a constitutive point of view, one has to incorporate

- (i) *frame indifference* of the energy densities W and θ , i.e. for all $Q \in \text{SO}(N)$ and $b \in \mathbb{R}^N$

$$\begin{aligned} W(QF) &= W(F) && \text{for all } F \in \mathbb{M}^N, \\ \theta(Qv + b, Qw + b) &= \theta(v, w) && \text{for all } v, w \in \mathbb{R}^N \end{aligned}$$

and concerning kinematics one has to restrict oneself to deformations, which

- (ii) guarantee *noninterpenetration of matter* in its very sense, hence to *injective* ones
 (iii) *preserve the local orientation*, i.e. have a *positive Jacobian determinant*.

An important mathematical consequence of the *geometrical* restriction frame-indifference is, that frame-indifferent elastic and surface energy densities exhibit a particularly simple structure.

Proposition 2.7 (Frame-indifferent energy densities). *Let $W : \mathbb{M}_>^N \rightarrow \mathbb{R}$ and $\theta : \mathbb{R}^N \times \mathbb{R}^N \rightarrow \mathbb{R}$ be functions. Then*

- (i) *W is frame-indifferent, i.e. $W(QF) = W(F)$ for all $F \in \mathbb{M}_>^N$, $Q \in \text{SO}(N)$, if and only if there is a function $\tilde{W} : \mathbb{S}_>^N \rightarrow \mathbb{R}$ such that*

$$W(F) = \tilde{W}(F^T F)$$

for all $F \in \mathbb{M}_>^N$,

- (ii) *θ is frame-indifferent, i.e. $\theta(Qv + b, Qw + b) = \theta(v, w)$ for all $v, w \in \mathbb{R}^N$ and all $Q \in \text{SO}(N)$, $b \in \mathbb{R}^N$, if and only if there is a function $\tilde{\theta} : [0, \infty) \rightarrow \mathbb{R}$ such that*

$$\theta(v, w) = \tilde{\theta}(|v - w|)$$

for all $v, w \in \mathbb{R}^N$.

Proof. For the proof of statement (i), the reader is referred to [Ciarlet, 1988, Theorem 4.2-1].

Turning to the second statement of the proposition, one immediately realizes the triviality of the “if”-implication. To prove the other implication, let θ be frame-indifferent and first realize that this implies

$$\theta(v, w) = \theta(v - w, w - w) = \theta(v - w, 0) = \bar{\theta}(v - w) \quad (2.6)$$

for the function $\bar{\theta} : \mathbb{R}^N \rightarrow \mathbb{R}$, $\bar{\theta}(x) := \theta(x, 0)$. Obviously by the frame-indifference of θ there also holds $\bar{\theta}(Qx) = \bar{\theta}(x)$ for all $x \in \mathbb{R}^N$, $Q \in \text{SO}(N)$. Since for every $x \in \mathbb{R}^N$ one can choose a rotation $Q_x \in \text{SO}(N)$ mapping $Q_x x = |x|e_1$, one now defines $\tilde{\theta} : [0, \infty) \rightarrow \mathbb{R}$, $\tilde{\theta}(\lambda) := \bar{\theta}(\lambda e_1)$ and arrives at

$$\bar{\theta}(x) = \bar{\theta}(Q_x x) = \bar{\theta}(|x|e_1) = \tilde{\theta}(|x|).$$

Inserting this into (2.6) finishes the proof. \square

Keeping the above imposed restrictions (i), (ii) and (iii) on the mathematical model in mind, the author now specifies the previously declared energy densities and the kinematic restrictions imposed on the many-body structures.

2.2.1 Constitutive assumptions

Elastic energy density

Qualitatively, one demands the elastic energy density W to obey the basic properties of all real-life hyperelastic materials. These are the behaviours under

$$\text{large strain: } W(F) \rightarrow \infty \text{ as } |F| \rightarrow \infty, \quad (2.7)$$

$$\text{large compression: } W(F) \rightarrow \infty \text{ as } \det F \searrow 0, \quad (2.8)$$

$$\text{local self-interpenetration: } W(F) = \infty \text{ if } \det F \leq 0. \quad (2.9)$$

However, the singular behaviour of an elastic energy density under large compression implies its *nonconvexity*, see [Ciarlet, 1988, Theorem 4.8-1], with severe consequences regarding the desirable sequential lower semicontinuity of the associated elastic energy (2.2). In fact, assuming for the time being some little regularity on W , namely sequential lower semicontinuity, the singular behaviour (2.8) under large compression implies that the mapping

$$L^r(\Omega; \mathbb{M}^N) \ni M \mapsto \int_{\Omega} W(M(x)) \, dx$$

is *not* sequentially lower semicontinuous w.r.t. the weak topology in $L^r(\Omega; \mathbb{M}^N)$, $1 \leq r \leq \infty$. This insight is stated in [Fonseca and Leoni, 2007, Theorem 5.14]. Thus, in order to deduce sequential lower semicontinuity of $\varphi \mapsto \int_{\Omega} W(\nabla \varphi) dx$ it is not sufficient to rely on some weak L^r -convergence of the deformation gradients only. A way out of this dilemma was shown up by John M. Ball in his fundamental contribution Ball [1977], wherein he created the notion of *polyconvexity*.

Definition 2.8 (Polyconvexity). A function $W : \mathbb{M}^N \rightarrow [0, \infty]$ is said to be *polyconvex*, if there exists a convex function $\mathbb{W} : \mathbb{M}^N \times (0, \infty) \rightarrow [0, \infty)$ such that

$$W(F) = \begin{cases} \mathbb{W}(F, \det F) & \text{if } \det F > 0, \\ \infty & \text{else} \end{cases}$$

holds for all $F \in \mathbb{M}^N$.

Remark 2.3 (on Definition 2.8). Since the set $\mathbb{M}^N \times (0, \infty)$ is open in $\mathbb{M}^N \times \mathbb{R}$ and \mathbb{W} is convex on $\mathbb{M}^N \times (0, \infty)$, one infers *continuity* of \mathbb{W} . This one obtains from the general result of convex analysis, that every convex function $J : V \rightarrow (-\infty, \infty]$ defined on a finite-dimensional vector space V is continuous on the interior of the set $\{v : v \in V, J(v) < \infty\}$, see Ekeland and Temam [1976].

The attentive reader will probably already have noticed that the concept of polyconvexity is compatible with the singular behaviour of $W(F)$ as $\det F \searrow 0$. How polyconvexity can provide a solution to the above described issue of sequential lower semicontinuity in the elastic energy is now revealed by the next lemma.

Lemma 2.9. *Let $W : \mathbb{M}^N \rightarrow [0, \infty]$ be polyconvex, i.e. suppose there exists a convex function $\mathbb{W} : \mathbb{M}^N \times (0, \infty) \rightarrow [0, \infty)$ such that for all $F \in \mathbb{M}^N$*

$$W(F) = \begin{cases} \mathbb{W}(F, \det F) & \text{if } \det F > 0, \\ \infty & \text{else} \end{cases}$$

and assume moreover that $\lim_{\det F \searrow 0} \mathbb{W}(F, \det F) = \infty$. Let $1 \leq r, s < \infty$ and Ω be a bounded open set in \mathbb{R}^N , $N \in \mathbb{N}$. Declare the functional

$$\mathcal{I} : L^r(\Omega; \mathbb{M}^N) \rightarrow [0, \infty], \quad \mathcal{I}(M) := \int_{\Omega} W(M(x)) dx.$$

If $M_k, M \in L^r(\Omega; \mathbb{M}^N)$ are such that $M_k \rightharpoonup M$ in $L^r(\Omega; \mathbb{M}^N)$ and $\det M_k \rightharpoonup \det M$ in $L^s(\Omega)$, then

$$\mathcal{I}(M) \leq \liminf_{k \rightarrow \infty} \mathcal{I}(M_k). \tag{2.10}$$

In case the right hand side is finite, there holds $\det M > 0$ a.e. in Ω .

Proof. The proof follows the lines of an exposition given in [Ciarlet, 1988, Theorem 7.7-1], although the original idea of the proof dates back to the work [Ball et al., 1981, Theorem 6.2]. Since the adaption is simple, the author will not carry it out here, but refers the reader to the literature. \square

Remark 2.4 (on Lemma 2.9). Let $V \ni \varphi_k, \varphi$ be a normed space of sufficiently smooth deformations, in which $\varphi_k \rightharpoonup \varphi$ in V entails $\nabla \varphi_k \rightharpoonup \nabla \varphi$ in $L^r(\Omega; \mathbb{M}^N)$ and $\det \nabla \varphi_k \rightharpoonup \det \nabla \varphi$ in $L^s(\Omega)$, for some $1 \leq r, s < \infty$. Then for polyconvex W like in Lemma 2.9 the functional

$$\mathcal{I} : V \rightarrow [0, \infty], \quad \mathcal{I}(\varphi) := \int_{\Omega} W(\nabla \varphi(x)) \, dx$$

is sequentially lower semicontinuous w.r.t. the weak topology in V . Examples for such spaces V are for $p > N$ the Sobolev-space $W^{1,p}(\Omega; \mathbb{R}^N)$ (see Ball [1977]) and $SBV^p(\Omega; \mathbb{R}^N)$ (see Section 3.3).

Remark 2.5. In the Definition 2.8 of polyconvexity, the author gave a simplified definition of the original one by John M. Ball, which states, that an energy density $W : \mathbb{M}^N \rightarrow [0, \infty]$ is polyconvex, if it can for all $F \in \mathbb{M}^N$ be written in the form

$$W(F) = \begin{cases} \mathbb{W}(F, \text{Cof } F, \det F) & \text{if } \det F > 0, \\ \infty & \text{else} \end{cases}$$

wherein $\mathbb{W} : \mathbb{M}^N \times \mathbb{M}^N \times (0, \infty) \rightarrow [0, \infty)$ is a convex function and $\text{Cof } F = (\det F)F^{-T}$ denotes the *cofactor matrix* of F . Lemma 2.9 remains valid in an analogous sense. Also the weak sequential lower semicontinuity statement of Remark 2.4 for integral functionals with polyconvex integrands still holds when posed over function spaces, in which weak convergence entails weak L^r -convergences of the deformation gradient, the cofactor of the deformation gradient and the Jacobian determinant. This is the case for the examples given in Remark 2.4, cf. Ball [1977] for $W^{1,p}(\Omega; \mathbb{R}^N)$ and [Ambrosio et al., 2000, Corollary 5.31] for $SBV^p(\Omega; \mathbb{R}^N)$.

However, the variant stated in Definition 2.8 is completely sufficient for the thesis' purposes.

Relying on the concept of polyconvexity in the sense of Definition 2.8, the author now formulates the **assumptions on the elastic energy density** $W : \mathbb{M}^N \rightarrow [0, \infty]$ as follows.

There is a convex function $\mathbb{W} : \mathbb{M}^N \times (0, \infty) \rightarrow [0, \infty)$ such that

$$W(F) = \begin{cases} \mathbb{W}(F, \det F) & \text{if } \det F > 0, \\ \infty & \text{else} \end{cases} \quad (W1)$$

holds for all $F \in \mathbb{M}^N$.

Moreover, the function W shall obey for all $F, M \in \mathbb{M}_{>}^N$ the growth conditions

$$W(F, \det F) \geq \alpha_1 |F|^p - \alpha_2 \quad (W2)$$

for $p > N$ and some positive constants α_1, α_2 ,

$$W(F, \det F) \rightarrow \infty \quad \text{as } \det F \searrow 0, \quad (W3)$$

$$W(F \cdot M, \det(F \cdot M)) \leq c_W(M) \cdot (W(F, \det F) + 1) \quad (W4)$$

for some function $c_W \in C(\mathbb{M}_{>}^N)$.

The author reminds the reader of the fact, that an energy density W with the properties (W1), \dots , (W3) satisfies the necessary physical behaviours under large strain (2.7), large compression (2.8) and local self-interpenetration (2.9) as they were stated at the beginning of this section. Also the reader should notice well, that the growth condition (W2) comprises the restriction on the order p of the polynomial lower bound to be larger than the space dimension N . Frame-indifference is not explicitly demanded, although it is not contradicted by any of the above stated assumptions.

Indeed, the following prototypical example of an energy density W satisfying (W1), \dots , (W4) is frame-indifferent.

Example 2.1 (for the elastic energy density). Let $W : \mathbb{M}^N \rightarrow [0, \infty]$ be the elastic energy density of a *compressible neo-Hookean material*, that is

$$W(F) = \begin{cases} W(F, \det F) & \text{if } \det F > 0, \\ \infty & \text{else} \end{cases}$$

with the function $W : \mathbb{M}^N \times (0, \infty) \rightarrow [0, \infty)$ given as

$$W(F, \delta) = \alpha_1 |F|^p + \alpha_2 \delta^{\frac{p}{N}} + \alpha_3 \frac{1}{\delta^\sigma}$$

for $p > N$, some positive constants $\alpha_1, \dots, \alpha_3$ and $\sigma > 0$. Obviously W is polyconvex and satisfies (W1), as well as it satisfies (W2) and (W3). One observes in addition the validity of (W4) with a function $c_W \in C(\mathbb{M}_{>}^N)$ like e.g.

$$c_W(M) = |M|^p + (\det M)^{\frac{p}{N}} + \frac{1}{(\det M)^\sigma}.$$

Moreover, W is isotropic, i.e. $W(FQ) = W(F)$ for all $Q \in \text{SO}(N)$ and all $F \in \mathbb{M}^N$, and frame-indifferent. Also note that W can on $\mathbb{M}_{>}^N$ be written in terms of the *right Cauchy-Green strain-tensor* $C = F^T F$, $F \in \mathbb{M}^N$, only (see Proposition 2.7).

$$W(F) = \begin{cases} \alpha_1 (\text{tr } C)^{\frac{p}{2}} + \alpha_2 (\det C)^{\frac{p}{2N}} + \alpha_3 \frac{1}{(\det C)^{\sigma/2}} & \text{if } \det F > 0, \\ \infty & \text{else} \end{cases}$$

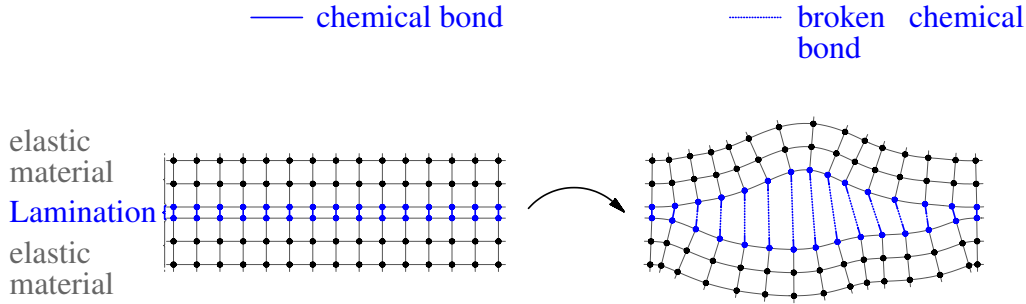

Figure 2.5: Griffith-theory based fracture model

Surface energy density

Before turning to concrete mathematical assumptions on the surface energy density θ , it again proves useful to specify the desired qualitative properties first. Those are

$$\text{brittle fracture behaviour along laminated surfaces,} \quad (2.11)$$

$$\begin{aligned} &\text{decreasing interaction between the crack lips} \\ &\text{as the lamination is broken and the resulting crack widens.} \end{aligned} \quad (2.12)$$

The author now explains a simple prototypical model that incorporates the above mentioned features.

Starting with the required brittle fracture behaviour, he falls back to Griffith’s studies from the early 20th century, published in Griffith [1920], which can be motivated the following way. The energy needed to create a crack in a brittle material is assumed to be proportional to the number of chemical bonds that are to be broken (see also Figure 2.5). Under material homogeneity assumptions, this number is itself proportional to the crack surface area in the undeformed configuration. One then arrives at Griffith’s theory, in which the energy needed to create a crack is proportional to the undeformed crack surface area. In terms of the surface energy density $\theta : \mathbb{R}^N \times \mathbb{R}^N \rightarrow [0, \infty)$, this means that there has to be an initial jump in θ (to be read as “initial energy”) from the “no crack scenario” to the “crack scenario”, i.e.

$$\theta(v, v) = 0 \quad \text{and} \quad \theta(v, w) \geq \alpha_{\text{Griffith}} \quad (2.13)$$

for some positive constant α_{Griffith} and all $v, w \in \mathbb{R}^N, v \neq w$.

To deal with the second requirement (2.12), the author makes use of a simple local notion of interaction. He assumes that two molecules or atoms on opposite crack lips, which in the undeformed configuration formed a chemical bond across the (undeformed) crack surface, exhibit a backdriving interaction, the strength of

which decreases as the distance between the molecules grows. See also Figure 2.5, where this effect is depicted by the dotted lines between formerly bonded molecules/atoms. In the spirit of this model, the author now assumes that

$$\theta \text{ is a function of the distance of its arguments only,} \quad (2.14)$$

i.e. in considerable abuse of notation $\theta(v, w) = \theta(|v - w|)$ for all $v, w \in \mathbb{R}^N$, and in view of the requirement of decreasing interaction the condition

$$\theta : [0, \infty) \rightarrow [0, \infty) \text{ is monotone increasing and concave.} \quad (2.15)$$

In accordance with the conditions (2.13), (2.14) and (2.15) the author now states the **assumptions on the surface energy density** $\theta : [0, \infty) \rightarrow [0, \infty)$ as follows. It is supposed that

$$\theta \text{ is lower semicontinuous,} \quad (\theta 1)$$

$$\theta \text{ is monotone increasing and concave,} \quad (\theta 2)$$

$$\theta(0) = 0 \text{ and } \lim_{t \searrow 0} \theta(t) = \alpha_{\text{Griffith}} \quad (\theta 3)$$

for some positive constant α_{Griffith} .

Herein, the little regularity imposed by condition ($\theta 1$) is purely due to mathematical reasons. In summary a surface energy density θ with the properties ($\theta 2$) and ($\theta 3$) is suitable to describe the in (2.11) required brittle fracture behaviour, if modelled in the sense of Griffith (see (2.13)). By ($\theta 2$), it also shows the desired decreasing interaction between the crack lips as the lamination is broken and the crack widens.

Remark 2.6. Although assumption (2.14) on the structure of the surface energy density θ is apparently very restrictive, Proposition 2.7 reveals that *every* frame-indifferent surface energy density is a function of the distance of its arguments only. Hence, in geometrically nonlinear elasticity, one cannot choose other than (2.14) for the surface energy density.

To conclude the section, one again is given a prototypical example of a surface energy density θ that satisfies the assumptions ($\theta 1$), \dots , ($\theta 3$).

Example 2.2 (for the surface energy density). Let $\theta : [0, \infty) \rightarrow [0, \infty)$ be of the form

$$\theta(t) = \begin{cases} 0 & \text{if } t = 0, \\ \theta_{\text{short}}(t) & \text{if } 0 < t \leq t_{\text{crit}}, \\ \alpha_{\text{const}} & \text{if } t > t_{\text{crit}} \end{cases}$$

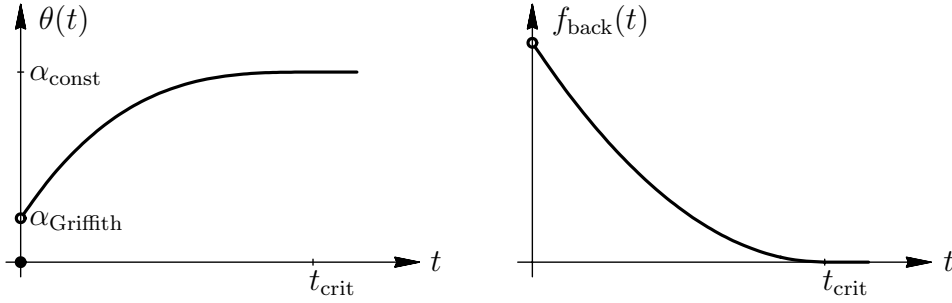

Figure 2.6: θ as in example 2.2 (left) and its derivative $f_{\text{back}} = \frac{d\theta}{dt}$ (right)

Herein $t_{\text{crit}} > 0$, $\theta_{\text{short}} \in C^1([0, t_{\text{crit}}])$ such that θ_{short} is monotone increasing and concave, $\theta_{\text{short}}(0) = \alpha_{\text{Griffith}}$ and $\theta_{\text{short}}(t_{\text{crit}}) = \alpha_{\text{const}}$. Confer also Figure 2.6 where a cubic θ_{short} is shown,

$$\theta_{\text{short}}(t) = (\alpha_{\text{const}} - \alpha_{\text{Griffith}}) \left(\frac{t}{t_{\text{crit}}} - 1 \right)^3 + \alpha_{\text{const}}.$$

Obviously such θ fulfills the requirements $(\theta 1), \dots, (\theta 3)$. Appealing to the reader's intuition, for a surface energy density of this form the energy needed to create a crack of (infinitesimal) area da and opening width $t > 0$ reads as

$$\theta(t) da = (\alpha_{\text{Griffith}} + (\theta(t) - \alpha_{\text{Griffith}})) da,$$

wherein α_{Griffith} is the energy needed to form the crack, and $(\theta(t) - \alpha_{\text{Griffith}})$ the energy needed to overcome the backdriving force generated by θ over the distance $t > 0$. As will be revealed by the computation of the Euler-Lagrange equations for the total energy (2.5) in Subsection 2.2.5, the magnitude of the backdriving force on two formerly bonded molecules/atoms on opposite crack lips at a distance $t > 0$ is $f_{\text{back}}(t) = \frac{d\theta}{dt}(t)$. In the present simple example then, these two molecules/atoms exhibit a decreasing backdriving force with limited range t_{crit} , as seen in the diagram depicting f_{back} in Figure 2.6.

2.2.2 Mechanical contact in nonlinear elasticity

The goal of this section is to address the important issue of mechanical contact between continuous (elastic) bodies and to provide the unfamiliar reader with basic knowledge of the topic. During a deformation process, two continuous bodies (or parts of the same body) may come into contact with each other along their surfaces, but they may not overlap. Inherent in any reasonable mathematical modelling of this phenomenon is thus the task to provide a sufficiently good statement of *noninterpenetration of matter*. Since mechanical contact is a phenomenon that

occurs in the *deformed configuration* of continuous bodies, formulating noninterpenetration of matter proves to be particularly difficult for large deformations, which though is the context of the thesis.

Despite being one of the most common phenomena observed in the mechanics of solid materials, mechanical contact, i.e. noninterpenetration of matter has gained little more than few attention in the mathematical literature. Even nowadays in most articles on static elasticity or fracture mechanics such considerations are not taken into account, mostly because they are quite delicate to handle. Therefore, what follows in this section is to be understood as an introduction into a contemporary method used to describe noninterpenetration of matter in geometrically nonlinear elasticity.

Until returning in the next Subsection 2.2.3 to the study of the many-body structures introduced in Section 2.1, Ω shall denote an arbitrary open and bounded set in \mathbb{R}^N , where $N \in \mathbb{N}$, in particular Ω is *not necessarily connected*.

Noninterpenetration of matter in its very sense means, that two different mass points may never occupy the same spatial position. Hence, for a smooth deformation $\varphi : \Omega \rightarrow \mathbb{R}^N$ of the body Ω , there holds *noninterpenetration of matter in the by φ deformed body, if and only if φ is injective*. Accounting for the fact, that in the mathematical treatment of elasticity one deals only with a.e.-defined deformations, one makes instead use of the concept of *a.e.-injectivity*.

Definition 2.10. Let $\varphi \in L^1(\Omega; \mathbb{R}^N)$. One calls φ *a.e.-injective in Ω* or simply *a.e.-injective*, if there is a representative $\bar{\varphi}$ of φ and a measurable subset N of Ω with $\text{vol } N = 0$ such that $\bar{\varphi}$ is injective on $\Omega \setminus N$.

Remark 2.7. If a deformation $\varphi \in L^1(\Omega; \mathbb{R}^N)$ is a.e.-injective, then *every* representative is injective up to a set of zero volume.

Although a.e.-injectivity is an appropriate statement for noninterpenetration of matter, it feels mathematically unhandy, especially when questioning its stability under (weak) convergence in the spaces of weakly differentiable deformations commonly used in elasticity, such as for instance Sobolev-spaces. Moreover a.e.-injectivity seems to be hard to verify in the context of elasticity, because the elasticity-governing terms, for instance like (2.5), seemingly do not provide any useful control mechanism.

The following mechanically intuitive notion of noninterpenetration of matter in geometrically nonlinear elasticity is due to Philippe G. Ciarlet and Jindřich Nečas. To motivate their formulation, for the moment think of Ω as a two-dimensional elastic straight beam, like shown on the left of Figure 2.7, and of $\varphi : \Omega \rightarrow \mathbb{R}^2$ as a sufficiently smooth deformation, which satisfies the principle of local orientation preservation, that is $\det \nabla \varphi > 0$ in Ω . Utilizing an instructive idea of Philippe G. Ciarlet (see [Ciarlet, 1988, Figure 5.5-1]), suppose the beam to

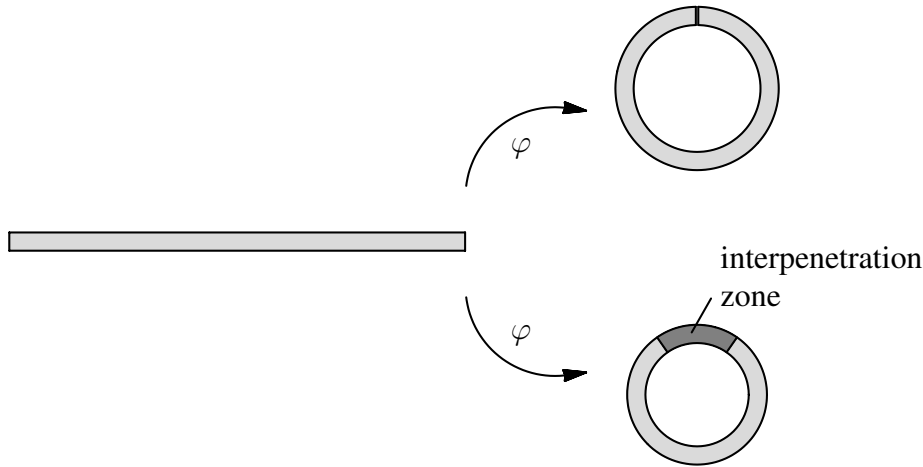

Figure 2.7: Deformation of a straight beam: contact and self-interpenetration

be bended like on the right of Figure 2.7 forming a circular ring. The deformation φ can be constructed such that in both the illustrated cases in Figure 2.7, where the beam ends touch or interpenetrate each other, the *volume occupied by the material in the deformed configuration*, that is $\int_{\Omega} \det \nabla \varphi \, dx$, is the same. In case there is no interpenetration, it equals the *volume of the deformed body* $\text{vol } \varphi(\Omega)$. However, as soon as the body interpenetrates itself and many mass-points occupy the same spatial position, the volume of the deformed body is *less* than the volume occupied by the material in the deformed configuration. This gedankenexperiment finally leads to the formulation of Ciarlet and Nečas [1987], demanding that *the volume of the deformed body may not be less than the volume the material occupies in the deformed configuration*, i.e. $\text{vol } \varphi(\Omega) \geq \int_{\Omega} \det \nabla \varphi \, dx$.

Before turning this condition into a manageable notion of noninterpenetration of matter, one faces the problem of defining the image of a set under only a.e.-defined deformations. In their original work, Ciarlet and Nečas [1987] dealt with deformations $\varphi \in W^{1,p}(\Omega; \mathbb{R}^N)$, where $p > N$ and Ω was a bounded Lipschitzian domain. By the Sobolev-embedding theorem they could thus define the image $\varphi(\Omega)$ as the image of Ω under the continuous representative. A recently introduced notion of a *measure theoretical image*, which fits the present more general context, is due to Alessandro Giacomini and Marcello Ponsiglione. Before giving a definition in their spirit, one needs the following tools.

Definition 2.11. Let $\varphi \in L^1(\Omega; \mathbb{R}^M)$, $M \in \mathbb{N}$, and $x_0 \in \Omega$.

- (i) One says that φ is *approximately continuous in* x_0 , if there is some $z \in \mathbb{R}^M$

such that

$$\lim_{r \rightarrow 0} \frac{1}{\text{vol } B_r(x_0)} \int_{B_r(x_0)} |\varphi(x) - z| \, dx = 0.$$

In this case, z is called the *approximate limit of φ in x_0* , in symbols $z = \text{ap } \lim_{y \rightarrow x_0} \varphi(y)$. Moreover, one defines the *set of all approximate continuity points of φ* by setting $\Omega_{\varphi, \text{L}} := \{x_0 : x_0 \in \Omega, \text{ap } \lim_{y \rightarrow x_0} \varphi(y) \text{ exists}\}$.

- (ii) One calls φ *approximately differentiable in x_0* , if φ is approximately continuous in x_0 and there is some $M \in \mathbb{R}^{M \times N}$ satisfying

$$\lim_{r \rightarrow 0} \frac{1}{\text{vol } B_r(x_0)} \int_{B_r(x_0)} \frac{|\varphi(x) - \text{ap } \lim_{y \rightarrow x_0} \varphi(y) - M(x - x_0)|}{r} \, dx = 0.$$

In case this holds true, M is called the *approximate differential of φ in x_0* and is denoted $\text{ap } D\varphi(x_0)$. The *set of all approximate differentiability points of φ* is defined as $\Omega_{\varphi, \text{D}} := \{x_0 : x_0 \in \Omega, \text{ap } D\varphi(x_0) \text{ exists}\}$.

Remark 2.8 (on Definition 2.11). The quantities $\text{ap } \lim_{y \rightarrow x_0} \varphi(y)$ and $\text{ap } D\varphi(x_0)$ do not depend on the specific choice of the representative of φ , hence also $\Omega_{\varphi, \text{L}}$ and $\Omega_{\varphi, \text{D}}$ do not. Furthermore it is known from classical measure theory, that the *Lebesgue-representative* defined as

$$\varphi_{\text{L}} : \Omega \rightarrow \mathbb{R}^M, \quad \varphi(x) := \begin{cases} \text{ap } \lim_{y \rightarrow x} \varphi(y) & \text{if } x \in \Omega_{\varphi, \text{L}}, \\ 0 & \text{else} \end{cases}$$

is indeed a representative of φ , and $\text{vol}(\Omega \setminus \Omega_{\varphi, \text{L}}) = 0$, see [Evans and Gariepy, 1992, Section 1.7, Corollary 1].

Definition 2.12 (Measure theoretical image, cf. [Giacomini and Ponsiglione, 2008, Definition 3.4]). Let $\varphi \in L^1(\Omega; \mathbb{R}^N)$ be approximately differentiable a.e. in Ω and define the representative

$$\varphi_{\text{D}} : \Omega \rightarrow \mathbb{R}^N, \quad \varphi(x) := \begin{cases} \text{ap } \lim_{y \rightarrow x} \varphi(y) & \text{if } x \in \Omega_{\varphi, \text{D}} \\ 0 & \text{else} \end{cases}$$

Then, for a subset E of Ω the set

$$[\varphi(E)] := \varphi_{\text{D}}(E)$$

is called the *measure theoretical image of E under φ* .

Remark 2.9 (on Definition 2.12). For E a measurable subset of Ω , its measure theoretical image $[\varphi(E)]$ is also measurable, see [Giacomini and Ponsiglione, 2008, Section 2].

Having the definition of a measure theoretical image at hand, one can finally adopt the notion of Ciarlet and Nečas [1987] of noninterpenetration of matter to a.e.-defined deformations, as did Giacomini and Ponsiglione [2008] in a way similar to the following (see their Definition 4.3).

Definition 2.13 (Ciarlet-Nečas condition). Let $\varphi \in L^1(\Omega; \mathbb{R}^N)$ be approximately differentiable a.e. in Ω . One says that φ satisfies the *Ciarlet-Nečas condition*, if there holds

$$\text{vol} [\varphi(\Omega)] \geq \int_{\Omega} |\det(\text{ap } D\varphi)| \, dx. \quad (2.16)$$

Remark 2.10. Let $\varphi \in L^1(\Omega; \mathbb{R}^N)$ be approximately differentiable a.e. in Ω . Then for all measurable subsets E of Ω

$$\text{vol} [\varphi(E)] \leq \int_E |\det(\text{ap } D\varphi)| \, dx, \quad (2.17)$$

see the area-formula in [Giaquinta et al., 1998, Chapter 3, Section 1.5, Theorem 1]. From this insight one derives two consequences.

- (i) The deformation φ satisfies the Ciarlet-Nečas condition, if and only if

$$\text{vol} [\varphi(E)] \geq \int_E |\det(\text{ap } D\varphi)| \, dx$$

holds for all measurable subsets E of Ω .

- (ii) The deformation φ satisfies the Ciarlet-Nečas condition, if and only if

$$\text{vol} [\varphi(\Omega)] = \int_{\Omega} |\det(\text{ap } D\varphi)| \, dx.$$

In other words, a deformation satisfies the Ciarlet-Nečas condition, if and only if the volume of the deformed body *equals* the volume occupied by the material in the deformed configuration.

The second statement is an easy corollary of (2.17). Turn now to the first one, in which the “if”-implication is trivial. As concerns the “only if”-implication,

assume the existence of a measurable subset E of Ω such that $\text{vol}[\varphi(E)] < \int_E |\det(\text{ap } D\varphi)| dx$. But then by (2.17)

$$\begin{aligned} \text{vol}[\varphi(\Omega)] &= \text{vol } \varphi_D(\Omega) = \text{vol}(\varphi_D(E) \cup \varphi_D(\Omega \setminus E)) \\ &\leq \text{vol}[\varphi(E)] + \text{vol}[\varphi(\Omega \setminus E)] \\ &< \int_E |\det(\text{ap } D\varphi)| dx + \int_{\Omega \setminus E} |\det(\text{ap } D\varphi)| dx \\ &= \int_{\Omega} |\det(\text{ap } D\varphi)| dx \end{aligned}$$

contradicting the Ciarlet-Nečas condition and finishing the proof. \square

One still lacks a statement, which reveals how noninterpenetration of matter in its “pure sense”, i.e. a.e.-injectivity of the deformation, and the above discussed Ciarlet-Nečas condition are related. Indeed, in case the determinant of the approximate differential is nonzero a.e., then they turn out to be *equivalent*.

Proposition 2.14 ([Giacomini and Ponsiglione, 2008, Proposition 2.5]). *Let $\varphi \in L^1(\Omega; \mathbb{R}^N)$ be approximately differentiable a.e. in Ω and assume $\det(\text{ap } D\varphi) \neq 0$ a.e. in Ω . Then*

$$\varphi \text{ is a.e.-injective in } \Omega \quad \Leftrightarrow \quad \varphi \text{ satisfies the Ciarlet-Nečas condition.}$$

Remark 2.11. The question of stability of the Ciarlet-Nečas condition under weak convergence in elasticity-relevant function spaces will (for the thesis’ purposes only) be answered in Section 3.3. Readers seeking more extensive discussion of this issue are referred to the original work Ciarlet and Nečas [1987] and to its recent generalization Giacomini and Ponsiglione [2008].

Criticism

Prior to returning to the subject of the thesis, the author closes this introduction into the treatment of mechanical contact in geometrically nonlinear elasticity with a criticism of the above concepts. That is, he will provide some examples that show, how the notion of noninterpenetration of matter by means of a.e.-injectivity can be tricked, giving the unexperienced reader a feeling of the formulation’s limitations.

A first problem case is seen in Figure 2.8. Note, that the deformation therein, i.e. translations of the respective bodies, certainly is injective, thus guarantees noninterpenetration of matter in the sense of a.e.-injectivity, although it contradicts the physical experience. In a static context with a static applied body load one would expect the bodies to maintain their relative positions, rather squeezing

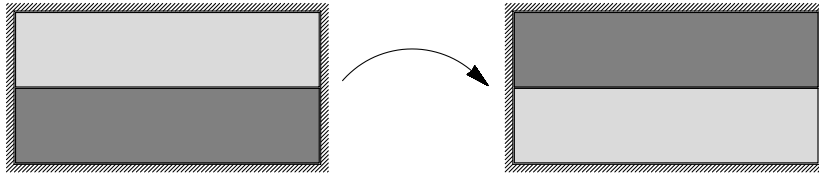

Figure 2.8: Rigid body motion exchanging the position of two bodies, which are enclosed in a rigid environment

each other than interchanging their positions. Nevertheless, in the context of a dynamic applied body load one can easily imagine a deformation shrinking the bodies, interchanging their positions and afterwards relaxing them to the equilibrium state seen on the right of Figure 2.8. This though reveals the present problem case as inevitable in *static* elasticity.

More fundamental is the aspect, that *almost everywhere*-injectivity as a non-interpenetration criterion is indeed an adequate formulation to ensure *nonoverlapping* in the deformed configuration, but (*self-*) *intersection* may still occur in a.e.-injective deformations. See Figure 2.9 for an example of an a.e.-injective deformation of the two-body system already used before, in which the deformed bodies intersect each other. This example is due to [Pantz, 2008, Figure 4]. Of

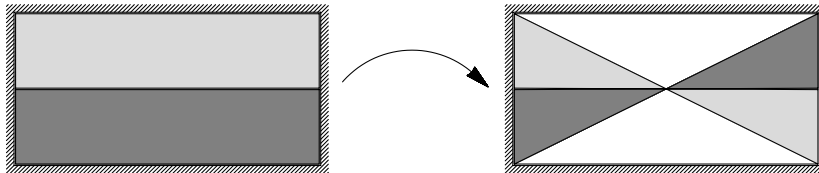

Figure 2.9: An a.e.-injective deformation showing self-intersection

course, such deformation cannot be observed in real life, revealing that almost-everywhere injectivity as a noninterpenetration criterion is anything but perfect. Another consequence of the example given in Figure 2.9 is a “rule of the thumb”, that goes like “The thinner a body is, the less reliable is Ciarlet-Nečas’ condition”. This stems from the fact, that the energetic costs of squeezing a body’s cross section to a single point (like in Figure 2.9) – thus making (self-) intersections in this point possible – decrease with the body’s thickness. Yet in some situations, the Ciarlet-Nečas condition can be turned into an equivalent statement for injectivity *everywhere* in the deformation’s domain, thus preventing Pantz-like effects that contradict the physical reality.

Proposition 2.15. *Let $\varphi \in L^1(\Omega; \mathbb{R}^N)$ be approximately differentiable a.e. in Ω and suppose $\det(\text{ap } D\varphi) \neq 0$ a.e. in Ω . Furthermore assume the existence of a*

representative $\bar{\varphi}$ such that

- (i) $\bar{\varphi}$ is open, i.e. for all open subsets U of Ω the set $\bar{\varphi}(U)$ is open,
- (ii) $\bar{\varphi}$ has the N -property, that is $\text{vol } \bar{\varphi}(N) = 0$ for all measurable subsets N of Ω with $\text{vol } N = 0$.

Then

$$\varphi \text{ satisfies the Ciarlet-Nečas condition} \iff \bar{\varphi} \text{ is injective in } \Omega.$$

Proof. According to Proposition 2.14, the Ciarlet-Nečas condition for φ is equivalent to a.e.-injectivity of φ . Hence, it suffices to show

$$\varphi \text{ is a.e.-injective in } \Omega \iff \bar{\varphi} \text{ is injective in } \Omega.$$

The implication “ \Leftarrow ” being trivial, one turns to “ \Rightarrow ”, which will be proved by contradiction.

Suppose that $\bar{\varphi}$ is not injective, i.e. there exist $x_1, x_2 \in \Omega$, $x_1 \neq x_2$ with $\bar{\varphi}(x_1) = \bar{\varphi}(x_2)$. Choose $r > 0$ such that $B_r(x_1) \cap B_r(x_2) = \emptyset$. Since $\bar{\varphi}$ is open, the sets $\bar{\varphi}(B_r(x_1))$ and $\bar{\varphi}(B_r(x_2))$ are open, and moreover have nonempty intersection. Hence, the set $V := \bar{\varphi}(B_r(x_1)) \cap \bar{\varphi}(B_r(x_2))$ is open, too. From the disjointness of $B_r(x_1), B_r(x_2)$ one deduces that for all $y \in V$ the cardinality of its inverse image is

$$\text{card}\{x : x \in \Omega, \bar{\varphi}(x) = y\} \geq 2.$$

In particular, $\bar{\varphi}$ is not injective on $\bar{\varphi}^{-1}(V)$. But there cannot hold $\text{vol } \bar{\varphi}^{-1}(V) = 0$, since by the assumed N -property of $\bar{\varphi}$ this would imply

$$0 = \text{vol } \bar{\varphi}(\bar{\varphi}^{-1}(V)) = \text{vol } V > 0$$

as V is open (note $\bar{\varphi}(\bar{\varphi}^{-1}(V)) = V$ because $V \subseteq \bar{\varphi}(\Omega)$). One infers that $\bar{\varphi}$ is not injective on a set of positive volume, contradicting the a.e.-injectivity of φ by Remark 2.7. \square

Example 2.3 (for Proposition 2.15). Although the assumptions in Proposition 2.15 seem to be exotic, the author provides an example for an important class of deformations meeting these requirements. Let Ω be a bounded Lipschitzian domain in \mathbb{R}^N and $\varphi \in W^{1,p}(\Omega; \mathbb{R}^N)$, $p > N$, with $\det D\varphi > 0$ a.e. in Ω . According to [Evans and Gariepy, 1992, Theorem 6.2-1], φ is differentiable a.e. in Ω in the classical sense and its derivative equals the weak derivative $D\varphi$ a.e. in Ω . In particular, φ is approximately differentiable a.e. in Ω and $\text{ap } D\varphi = D\varphi$ a.e. in Ω . Moreover, for the continuous representative $\bar{\varphi}$ (the existence of which is ensured by the Sobolev-embedding theorem) one obtains, that

- (i) $\bar{\varphi}$ is open, provided the quantity $\frac{|D\varphi|^N}{\det D\varphi}$ is sufficiently integrable, see [Vodop'yanov, 2000, Theorem 1],
- (ii) $\bar{\varphi}$ has the N -property according to Marcus and Mizel [1973].

Hence, in case φ satisfies the Ciarlet-Nečas condition, $\bar{\varphi}$ is injective.

To put it in a nutshell, one can say that the Ciarlet-Nečas condition is a good way to ensure noninterpenetration of matter in the deformed configuration of “non-thin” structures, but it does not take into account the geometry of the undeformed configuration.

2.2.3 Kinematic assumptions

In the present section, the author states the kinematic constraints imposed on the many-body structures Ω_ε of Section 2.1, taking into account the therein mentioned principles of noninterpenetration of matter and preservation of local orientation.

As concerns the noninterpenetration criterion, regarding the geometrically non-linear context in which the many-body structures Ω_ε are to be studied, one makes use of the in the preceding section introduced Ciarlet-Nečas condition. Note, that in the case of the many-body structures Ω_ε one would in particular have to struggle with the criticized unphysical, but with the Ciarlet-Nečas condition still compatible interchange of subbodies. This though is generally energetically unfavourable, since the author assumed the subbodies to be initially glued together. Before interchanging their positions, two subbodies would have to break the bonds to their neighbours. Nevertheless, despite coming at some energetic costs, the described interchange of two subbodies remains compatible with the Ciarlet-Nečas condition, see Remark 2.2.

In addition to the up to now mentioned kinematic restrictions, the author introduces a *confinement condition*, stating that the deformed configuration of each many-body structure Ω_ε has to be contained in a rigid environment \mathbf{Box} , which from now on is assumed to be a compact subset of \mathbb{R}^N with nonempty interior. The mechanical reason behind this additional restriction is, that even in the presence of Dirichlet boundary conditions on the whole boundary $\partial\Omega$, for many-body structures one still has no control on subbodies, the closures of which are contained in Ω . Simply, because there are no Dirichlet boundary conditions imposed on them, and consequently a Poincaré-type estimate controlling the position of a subbody by means of the deformation gradient does not hold true. Referring to Figure 2.10, in absence of a confinement condition but with Dirichlet boundary conditions imposed on all $\partial\Omega$, a subbody in the gravitation-loaded two-dimensional many-body structure Ω_ε could break itself free and in accordance with the Ciarlet-Nečas condition be moved out of the many-body structure.

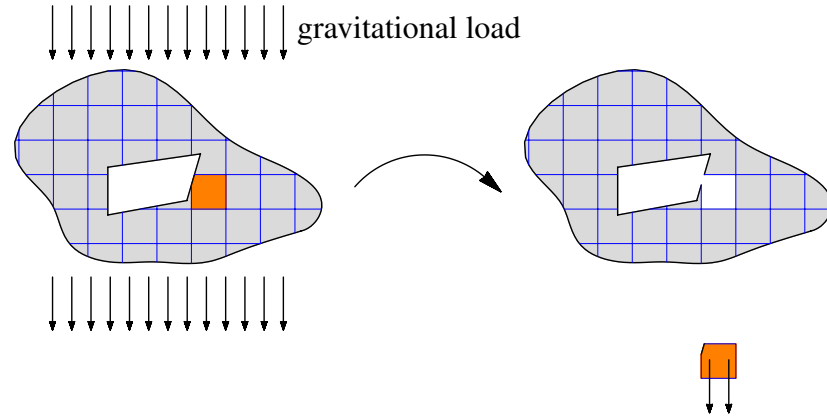

Figure 2.10: No minimum of the total energy in absence of a confinement condition

Following gravitation, this subbody would release arbitrarily much work leading to the nonexistence of an equilibrium configuration (i.e. a minimum of the total energy) for this system.

One can now finally state the **kinematic assumptions** on the deformations of the many-body structures Ω_ε as follows. A deformation $\varphi \in L^1(\Omega_\varepsilon; \mathbb{R}^N)$ of Ω_ε – which can be identified with an element of $L^1(\Omega; \mathbb{R}^N)$ – is kinematically admissible, if it is an element of the set

$$\text{Kin}(\Omega; \mathbf{Box}) := \left\{ \varphi : \varphi \in L^1(\Omega; \mathbb{R}^N) \text{ such that} \right. \\
\left. \begin{aligned} &\varphi \text{ is approximately differentiable a.e. in } \Omega, \\ &\det(\text{ap } D\varphi) > 0 \text{ a.e. in } \Omega, \\ &\text{vol}[\varphi(\Omega)] \geq \int_{\Omega} \det(\text{ap } D\varphi) \, dx, \\ &\text{and } \varphi(x) \in \mathbf{Box} \text{ a.e. in } \Omega \end{aligned} \right\}. \quad (2.18)$$

The author emphasizes, that this set is indeed nonempty in view of the fact that \mathbf{Box} has nonempty interior.

Remark 2.12 (On Dirichlet boundary conditions). The reader will have observed, that the author did not impose any Dirichlet (i.e. displacement) boundary conditions on the many-body structures Ω_ε . This is due to the fact, that the construction of deformations under the kinematic restrictions a.e.-injectivity, preservation of local orientation and confinement is for general Dirichlet boundary conditions extraordinarily difficult. In applications however, in which the deformation of an elastic body is not determined by the position of its boundary, but by its (elastic or often) rigid environment instead, one can model such rigid environment

by exploiting the confinement condition **Box**. Situations of this type are often encountered, when the elastic object under consideration is “small” and “soft” compared to its environment. Examples are rubber shock absorbers or springs being compressed between structural elements, tires being deformed between the wheel and the road/obstacle etc.

2.2.4 External loads

Concerning the conservative applied (follower-) body loads the many-body structures Ω_ε are exposed to as said in Section 2.2, the author prefers to remain quite general with the assumptions on the load potential $\hat{F} : \Omega \times \mathbb{R}^N \rightarrow \mathbb{R}$.

Since all kinematically admissible deformed configurations $\varphi(\Omega_\varepsilon)$ of a many-body structure Ω_ε ($\varphi \in \text{Kin}(\Omega; \mathbf{Box})$) are contained in the rigid environment **Box**, it suffices to declare the potential of the follower-body loads thereon, hence $\hat{F} : \Omega \times \mathbf{Box} \rightarrow \mathbb{R}$. A first natural assumption on the load potential is its boundedness, since a mass particle should only do finite work along finite paths in the by \hat{F} generated force field. Moreover, the author demands that the works done by the potential-generated force field along two only marginally deviating deformations also show only little deviation.

Translating this into mathematical notation, the **assumptions on the potential of the applied body load** $\hat{F} : \Omega \times \mathbf{Box} \rightarrow \mathbb{R}$ are stated below.

The mapping

$$\{\varphi : \varphi \in L^1(\Omega; \mathbb{R}^N), \varphi(x) \in \mathbf{Box} \text{ a.e.}\} \ni \varphi \mapsto \int_{\Omega} \hat{F}(x, \varphi(x)) \, dx \quad (\hat{F}1)$$

is well-defined and continuous w.r.t. the strong $L^1(\Omega; \mathbb{R}^N)$ -topology.

$$|\hat{F}(x, v)| \leq \alpha_{\text{force}} \quad \text{for all } x \in \Omega, v \in \mathbf{Box} \quad (\hat{F}2)$$

and some positive constant α_{force} .

As the author did for the elastic energy density and for the surface energy density, he will give an illustrative example for a conservative applied (follower-) body load, the potential of which satisfies $(\hat{F}1)$, $(\hat{F}2)$.

Example 2.4 (for the applied body load). The classical example for a conservative follower body load in nonlinear elasticity are centrifugal forces, which act on a body as the result of a rotation about a fixed axis $A = \{a + \lambda w : \lambda \in \mathbb{R}\}$, $a \in \mathbb{R}^N$, $w \in S^{N-1}$, with constant angular velocity ω_{rot} . Assuming the mass density in the reference configuration of the many-body structures Ω_ε to be quantified by some measurable, uniformly bounded $\rho : \Omega \rightarrow (0, \infty)$, the rotation-induced force density $\hat{f}_{\text{rot}}(x, \varphi(x))$ in a point $\varphi(x)$ of the by some $\varphi \in \text{Kin}(\Omega; \mathbf{Box})$ deformed configuration $\varphi(\Omega_\varepsilon)$ reads as

$$\hat{f}_{\text{rot}}(x, \varphi(x)) = \rho(x) \omega_{\text{rot}}^2 (I - w \otimes w) (\varphi(x) - a).$$

Thus one arrives at the potential of the centrifugal force $\hat{F}_{\text{rot}} : \Omega \times \mathbf{Box} \rightarrow \mathbb{R}$,

$$\hat{F}_{\text{rot}}(x, v) = \frac{1}{2} \rho(x) \omega_{\text{rot}}^2 (v - a)^T (I - w \otimes w) (v - a),$$

and it is easily checked that $\frac{\partial \hat{F}_{\text{rot}}}{\partial v}(x, v) = \hat{f}_{\text{rot}}(x, v)$ for all $x \in \Omega$, $v \in \mathbf{Box}$ and $(\hat{F}1)$, $(\hat{F}2)$ are satisfied.

Remark 2.13 (On Neumann boundary conditions). For the same reason, for which the author omitted Dirichlet boundary conditions in his studies, he also did not take into account Neumann (i.e. force) boundary conditions.

2.2.5 Total energy and Euler-Lagrange-equations

Given the precise mathematical assumptions on the elastic energy density, the surface energy density and on the potential of the applied body load, together with the assumptions on the kinematics of the many-body structures Ω_ε , one is finally in a position to reformulate the total energy (2.5) of the system in a mathematically precise manner. Observe, that in view of the elasticity assumption on the subbodies of Ω_ε and the growth condition (W2), the adequate class of deformations for a many-body structure Ω_ε is the Sobolev-space $W^{1,p}(\Omega_\varepsilon; \mathbb{R}^N)$. Hence, the **total energy stored in the deformed configuration of a many-body structure** Ω_ε is rigorously written down as follows.

For the elastic energy density $W : \mathbb{M}^N \rightarrow [0, \infty]$ assume (W1), \dots , (W3), for the surface energy density $\theta : [0, \infty) \rightarrow [0, \infty)$ assume $(\theta1)$, \dots , $(\theta3)$, for the potential of the applied body load $\hat{F} : \Omega \times \mathbf{Box} \rightarrow \mathbb{R}$ suppose $(\hat{F}1)$, $(\hat{F}2)$ and let there be given the set $\text{Kin}(\Omega; \mathbf{Box})$ of all kinematically admissible deformations. Then the total energy

$$\mathcal{E}_\varepsilon : W^{1,p}(\Omega_\varepsilon; \mathbb{R}^N) \cap \text{Kin}(\Omega; \mathbf{Box}) \rightarrow (-\infty, \infty]$$

stored in the by $\varphi \in W^{1,p}(\Omega_\varepsilon; \mathbb{R}^N) \cap \text{Kin}(\Omega; \mathbf{Box})$ deformed many-body structure Ω_ε is

$$\begin{aligned} \mathcal{E}_\varepsilon(\varphi) = & \int_{\Omega_\varepsilon} W(\nabla \varphi(x)) \, dx + \int_{\Gamma_{C,\varepsilon}} \theta(|\varphi^+(x) - \varphi^-(x)|) \, d\mathcal{H}^{N-1}(x) \\ & - \int_{\Omega_\varepsilon} \hat{F}(x, \varphi(x)) \, dx. \end{aligned} \quad (2.19)$$

When asking for minimal energy configurations of the many-body structures Ω_ε , which are exposed to the applied body loads given by \hat{F} , one can state a positive answer.

Theorem 2.16 (Existence of minimizers for the total energy \mathcal{E}_ε). *Let Ω_ε be one of the many-body structures Ω_ε as in Definition of Geometry 2.1, 2.2 or 2.3. Assume that the elastic energy density W satisfies (W1), ..., (W3), the surface energy density θ the conditions (θ 1), ..., (θ 3) and the potential \hat{F} of the applied body load (\hat{F} 1), (\hat{F} 2). The associated total energy \mathcal{E}_ε shall be given as in (2.19). Then the total energy \mathcal{E}_ε has a minimizer.*

Because at this stage one will encounter a lack of tools needed to show the statement of the theorem, the author has moved its proof into Section 4.1.

Remember that in Section 2.2 the author called a minimizer of the total energy an equilibrium state, without further reflecting how this nomenclature is related to the *balance of forces* within the loaded body. An answer to this question provides the next proposition, in which the Euler-Lagrange equations for a minimizer of the total energy \mathcal{E}_ε associated with a many-body structure Ω_ε are found.

Proposition 2.17 (Euler-Lagrange equations in the reference configuration). *Let Ω_ε be one of the many-body structures given in Definition of Geometry 2.1, 2.2 or 2.3, with the associated total energy (2.19). In the latter, the assumptions (W1), ..., (W3), (θ 1), ..., (θ 3) and (\hat{F} 1), (\hat{F} 2) shall be valid for the respective energy densities. Moreover assume the boundaries of Ω and \mathbf{Box} as well as the elastic energy density W , the surface energy density θ and the potential of the applied body load \hat{F} to be sufficiently regular (for instance like in the respective examples). Then any smooth enough minimizer φ of \mathcal{E}_ε satisfies the following boundary value problem.*

1. Confinement. *One has*

$$\varphi(\Omega_\varepsilon) \subseteq \mathbf{Box}.$$

2. Equilibrium in the reference configuration. *For all $x \in \Omega_\varepsilon$ there holds*

$$-\operatorname{div} \hat{T}(\nabla \varphi(x)) = \hat{f}(x, \varphi(x)), \quad (2.20)$$

where $\hat{T}(F) = DW(F)$, $F \in \mathbb{M}_{>}^N$, is the first Piola-Kirchhoff stress, and $\hat{f}(x, v) = \frac{\partial \hat{F}}{\partial v}(x, v)$, $(x, v) \in \Omega \times \mathbf{Box}$, the applied body load per undeformed unit volume.

3. Conditions on the outer boundary. *Let n denote the outer normal on $\partial\Omega$ and n^φ the outer normal on the deformed outer boundary $\varphi(\partial\Omega \cap \partial\Omega_\varepsilon)$. Then for all $x \in \partial\Omega \cap \partial\Omega_\varepsilon$ one has*

$$\hat{T}(\nabla \varphi(x))n(x) = \lambda(x)n^\varphi(\varphi(x)) \quad (2.21)$$

wherein $\lambda(x) \in \mathbb{R}$ results from one of the cases

- (i) $\varphi(x) \in \text{int } \mathbf{Box}$ and $\varphi^{-1}(\{\varphi(x)\}) = \{x\}$, then $\lambda(x) = 0$,
- (ii) $\varphi(x) \in \partial \mathbf{Box}$, then $\varphi^{-1}(\{\varphi(x)\}) = \{x\}$ and $\lambda(x) \leq 0$,
- (iii) $\varphi(x) \in \text{int } \mathbf{Box}$ and $\varphi^{-1}(\{\varphi(x)\}) = \{x, y\}$ for some $y \in \partial \Omega_\varepsilon$, then $\lambda(x) \leq 0$.

4. Conditions on the inner contact boundary. Let n be a normal field on $\Gamma_{C,\varepsilon} = \Omega \cap \partial \Omega_\varepsilon$ and adopt the following convention. Given a sufficiently regular function $term : \Omega_\varepsilon \rightarrow \mathbb{R}^M$ and some $x \in \Gamma_{C,\varepsilon}$, then $term^\pm(x)$ is the limit $\lim_n term(x_n)$, where the $(x_n)_n$ are taken from the side of $\Gamma_{C,\varepsilon}$, which $\pm n(x)$ points in, and are such that $\Omega_\varepsilon \ni x_n \rightarrow x$. In this sense let the deformed inner contact boundaries $\varphi^\pm(\Gamma_{C,\varepsilon})$ be given and $n^{\varphi,\pm}$ the deformed normal fields thereon. Then for all $x \in \Gamma_{C,\varepsilon}$ one considers the cases listed below.

If there is $r > 0$ such that $\varphi^+(z) = \varphi^-(z)$ for all $z \in B_r(x) \cap \Gamma_{C,\varepsilon}$, then

$$-\text{div } \hat{T}(\nabla \varphi(x)) = \hat{f}(x, \varphi(x)). \quad (2.22)$$

If $\varphi^+(x) \neq \varphi^-(x)$, then in $\varphi^+(x)$ there holds

$$\begin{aligned} & \hat{T}(\nabla \varphi(\cdot))^+(x) (-n(x)) \\ & + f_{\text{back}}(|\varphi^+(x) - \varphi^-(x)|) \frac{\varphi^+(x) - \varphi^-(x)}{|\varphi^+(x) - \varphi^-(x)|} \\ & = \lambda^+(x) (-n^{\varphi,+}(\varphi^+(x))), \end{aligned} \quad (2.23)$$

where $f_{\text{back}}(t) = \frac{d\theta}{dt}(t)$, $t > 0$. Again, $\lambda^+(x)$ is determined by one of the cases

- (i) $\varphi^+(x) \in \text{int } \mathbf{Box}$ and $\varphi^{-1}(\{\varphi^+(x)\}) = \{x\}$, then $\lambda^+(x) = 0$,
- (ii) $\varphi^+(x) \in \partial \mathbf{Box}$, then $\varphi^{-1}(\{\varphi^+(x)\}) = \{x\}$ and $\lambda^+(x) \leq 0$,
- (iii) $\varphi^+(x) \in \text{int } \mathbf{Box}$ and $\varphi^{-1}(\{\varphi^+(x)\}) = \{x, y\}$ for some $y \in \partial \Omega_\varepsilon$, then $\lambda^+(x) \leq 0$.

Similarly, in $\varphi^-(x)$ there holds

$$\begin{aligned} & \hat{T}(\nabla \varphi(\cdot))^{-}(x) (+n(x)) \\ & + f_{\text{back}}(|\varphi^+(x) - \varphi^-(x)|) \frac{\varphi^-(x) - \varphi^+(x)}{|\varphi^+(x) - \varphi^-(x)|} \\ & = \lambda^-(x) (+n^{\varphi,-}(\varphi^-(x))), \end{aligned} \quad (2.24)$$

and $\lambda^-(x)$ results analogously to $\lambda^+(x)$ from the cases (i),..., (iii), with $\varphi^-(x)$ taking the role of $\varphi^+(x)$.

The proof of Proposition 2.17 goes analogously to the one of [Ciarlet, 1988, Theorem 5.6-3] (with minor modifications due to the presence of a surface energy density and a follower body-load instead of a dead load). For this reason the author will not state it here.

Remark 2.14. In the situation of Proposition 2.17, let there be $x \in \Gamma_{C,\varepsilon}$ and consider a quantity $term : \Omega_\varepsilon \rightarrow \mathbb{R}^M$. Then by the convention of the proposition, the normal $n(x)$ points inwards the side of $\Gamma_{C,\varepsilon}$, from which $term^+(x)$ is approximated. In particular, $-n(x)$ is the outer normal in x on the subbody of Ω_ε , from the inside of which $term^+(x)$ is approximated. Whereas $+n(x)$ is the outer normal in x on the subbody, from the inside of which $term^-(x)$ is approximated.

With regard to the conditions on the inner contact boundary stated in case 4 of the above proposition, note that the tractions induced by the first Piola-Kirchhoff stress on the inner contact boundary $\Gamma_{C,\varepsilon}$ in x are therefore

$$\hat{T}(\nabla\varphi(\cdot))^+(x) (-n(x)) \quad \text{and} \quad \hat{T}(\nabla\varphi(\cdot))^- (x) (+n(x)), \quad \text{respectively.}$$

An analogous observation holds true in the deformed configuration. The vector $-n^{\varphi,+}(\varphi^+(x))$ is the outer normal in $\varphi^+(x)$ on the deformed subbody of Ω_ε , from the inside of which $term^+(x)$ is approximated, whereas $+n^{\varphi,-}(\varphi^-(x))$ is the outer normal in $\varphi^-(x)$ on the deformed subbody, from the inside of which $term^-(x)$ is approximated.

The author chose this in the present context slightly confusing convention in order to keep up consistency with the notation used in the calculus of functions of bounded variation, see Proposition 3.19 in Section 3.3.

Remark 2.15 (Euler-Lagrange equations in the deformed configuration). Let the assumptions and notational conventions of Proposition 2.17 hold, $\varphi \in W^{1,p}(\Omega_\varepsilon; \mathbb{R}^N) \cap \text{Kin}(\Omega; \text{Box})$ be the smooth minimizer of \mathcal{E}_ε studied therein. By employing properties of the *Piola-transformation*, one can transform the on the reference configuration Ω_ε valid Euler-Lagrange equations into equations, which are valid in the deformed configuration $\varphi(\Omega_\varepsilon)$. The Piola-transformation is a fundamental tool in nonlinear elasticity relating the physically relevant deformed configuration and the mathematically preferred reference configuration. For a detailed exposition of this tool the author suggests the unfamiliar reader to consult Ciarlet [1988], Section 1.7, 1.8 and Chapter 2. There he will also find the transformation's calculus, which will be used in the computations below.

In the upcoming notation, elements of the deformed configuration are referred to as follows. If U is the reference configuration Ω_ε or the outer boundary $\partial\Omega \cap \partial\Omega_\varepsilon$, then $x^\varphi \in \varphi(U)$ denotes the point $x^\varphi = \varphi(x)$ for $x \in U$. Moreover in the case $x^\varphi \in \varphi(\partial\Omega \cap \partial\Omega_\varepsilon)$, the term $da^\varphi(x^\varphi)$ denotes the area element on $\varphi(\partial\Omega \cap \partial\Omega_\varepsilon)$ around x^φ and there holds the relation (see [Ciarlet, 1988, Theorem 1.7-1])

$$da^\varphi(x^\varphi) = |\text{Cof } \nabla\varphi(x) n(x)| da(x). \quad (2.25)$$

Whereas the point $x^{\varphi,+} \in \varphi^+(\Gamma_{C,\varepsilon})$ is identified as $x^{\varphi,+} = \varphi^+(x)$ for $x \in \Gamma_{C,\varepsilon}$. Again, one writes $da^{\varphi,+}(x^{\varphi,+})$ for the area element on $\varphi^+(\Gamma_{C,\varepsilon})$ around $x^{\varphi,+}$, which is related to $da(x)$ analogously to (2.25). In the same way are declared $x^{\varphi,-} \in \varphi^-(\Gamma_{C,\varepsilon})$ and $da^{\varphi,-}(x^{\varphi,-})$.

For $x^\varphi \in \varphi(\Omega_\varepsilon)$ and $M : \varphi(\Omega_\varepsilon) \rightarrow \mathbb{M}^N$ some smooth matrix-valued function, by $\operatorname{div}^\varphi M(x^\varphi)$ one denotes the usual divergence of M in the point x^φ (not to be confused with $\operatorname{div}(M(\varphi(x)))$).

Let $x^\varphi = \varphi(x) \in \varphi(\Omega_\varepsilon)$. Recall that by the Piola-transformation, the Cauchy-stress $T^\varphi(x^\varphi)$ and the first Piola-Kirchhoff stress $\hat{T}(\nabla\varphi(x))$ are related by

$$T^\varphi(x^\varphi) = \hat{T}(\nabla\varphi(x))(\operatorname{Cof} \nabla\varphi(x))^{-1}.$$

Moreover, the applied body load $f^\varphi(x^\varphi)$ in the deformed configuration $\varphi(\Omega_\varepsilon)$ is

$$f^\varphi(x^\varphi) = \frac{1}{\det \nabla\varphi(x)} \hat{f}(x, \varphi(x)).$$

Eventually applying the Piola-transformation's calculus to Proposition 2.17, one infers from (2.20), (2.21), (2.22), (2.23) and (2.24) the validity of the following statements.

1. *Confinement.* One has

$$\varphi(\Omega_\varepsilon) \subseteq \mathbf{Box}$$

2. *Equilibrium in the deformed configuration.* For all $x^\varphi \in \varphi(\Omega_\varepsilon)$ there holds

$$-\operatorname{div}^\varphi T^\varphi(x^\varphi) = f^\varphi(x^\varphi).$$

3. *Conditions on the deformed outer boundary.* For all $x^\varphi \in \varphi(\partial\Omega \cap \partial\Omega_\varepsilon)$ one has

$$T^\varphi(x^\varphi)n^\varphi(x) = \lambda^\varphi(x^\varphi)n^\varphi(x^\varphi)$$

wherein $\lambda^\varphi(x^\varphi) = \lambda(x) \frac{da(x)}{da^\varphi(x^\varphi)}$ and $\lambda(x)$ is determined by the considerations

- (i) $x^\varphi \in \operatorname{int} \mathbf{Box}$ and $\varphi^{-1}(\{x^\varphi\}) = \{x\}$, then $\lambda(x) = 0$,
- (ii) $x^\varphi \in \partial\mathbf{Box}$, then $\varphi^{-1}(\{x^\varphi\}) = \{x\}$ and $\lambda(x) \leq 0$,
- (iii) $x^\varphi \in \operatorname{int} \mathbf{Box}$ and $\varphi^{-1}(\{x^\varphi\}) = \{x, y\}$ for some $y \in \partial\Omega_\varepsilon$, then $\lambda(x) \leq 0$.

4. *Conditions on the deformed inner contact boundary.* One distinguishes for all $x^{\varphi, \pm} \in \varphi^{\pm}(\Gamma_{C, \varepsilon})$ the instances listed below.

If there is $r > 0$ such that $z^{\varphi, +} = z^{\varphi, -}$ for all $z \in B_r(x) \cap \Gamma_{C, \varepsilon}$, then

$$-\operatorname{div}^{\varphi} T^{\varphi}(x^{\varphi}) = f^{\varphi}(x^{\varphi}).$$

If $x^{\varphi, +} \neq x^{\varphi, -}$, then in $x^{\varphi, +}$ there holds

$$\begin{aligned} & T^{\varphi, +}(x^{\varphi, +}) (-n^{\varphi, +}(x^{\varphi, +})) \\ & + f_{\text{back}}(|x^{\varphi, +} - x^{\varphi, -}|) \frac{x^{\varphi, +} - x^{\varphi, -}}{|x^{\varphi, +} - x^{\varphi, -}|} \frac{da(x)}{da^{\varphi, +}(x^{\varphi, +})} \\ & = \lambda^{\varphi, +}(x^{\varphi, +}) (-n^{\varphi, +}(x^{\varphi, +})). \end{aligned}$$

Herein, $\lambda^{\varphi, +}(x^{\varphi, +}) = \lambda^+(x) \frac{da(x)}{da^{\varphi, +}(x^{\varphi, +})}$ and $\lambda^+(x)$ is specified like

- (i) $x^{\varphi, +} \in \operatorname{int} \mathbf{Box}$ and $\varphi^{-1}(\{x^{\varphi, +}\}) = \{x\}$, then $\lambda^+(x) = 0$,
- (ii) $x^{\varphi, +} \in \partial \mathbf{Box}$, then $\varphi^{-1}(\{x^{\varphi, +}\}) = \{x\}$ and $\lambda^+(x) \leq 0$,
- (iii) $x^{\varphi, +} \in \operatorname{int} \mathbf{Box}$ and $\varphi^{-1}(\{x^{\varphi, +}\}) = \{x, y\}$ for some $y \in \partial \Omega_{\varepsilon}$, then $\lambda^+(x) \leq 0$.

Similarly, in $x^{\varphi, -}$ one has

$$\begin{aligned} & T^{\varphi, -}(x^{\varphi, -}) (+n^{\varphi, -}(x^{\varphi, -})) \\ & + f_{\text{back}}(|x^{\varphi, +} - x^{\varphi, -}|) \frac{x^{\varphi, -} - x^{\varphi, +}}{|x^{\varphi, +} - x^{\varphi, -}|} \frac{da(x)}{da^{\varphi, -}(x^{\varphi, -})} \\ & = \lambda^{\varphi, -}(x^{\varphi, -}) (+n^{\varphi, -}(x^{\varphi, -})). \end{aligned}$$

and $\lambda^{\varphi, -}(x^{\varphi, -}) = \lambda^-(x) \frac{da(x)}{da^{\varphi, -}(x^{\varphi, -})}$, where $\lambda^-(x)$ is calculated analogously to $\lambda^+(x)$.

Before turning to the asymptotic analysis of the model described in this section, the author concludes this chapter by stating an interpretation of the Euler-Lagrange equations, highlighting the model's peculiarities.

Remark 2.16 (Interpretation of the Euler-Lagrange equations). Once again let the assumptions of Proposition 2.17 hold and φ be the smooth minimizer of $\mathcal{E}_{\varepsilon}$ studied therein. Relying on the insights of Remark 2.15, one interpretes the by φ deformed configuration as follows.

From case 2 one infers the validity of **static equilibrium in the deformed configuration** $\varphi(\Omega_{\varepsilon})$ in every point x^{φ} , that is $-\operatorname{div}^{\varphi} T^{\varphi}(x^{\varphi}) = f^{\varphi}(x^{\varphi})$.

On the deformed outer boundary $\varphi(\partial\Omega \cap \partial\Omega_\varepsilon)$, in each point x^φ there may occur two different situations according to case 3. Either there is no contact with the rigid environment and no contact with another deformed subbody and no self-contact in x^φ , i.e.

$$x^\varphi \in \text{int } \mathbf{Box} \quad \text{and} \quad \varphi^{-1}(\{x^\varphi\}) = \{x\},$$

in which the traction in x^φ is $T^\varphi(x^\varphi)n^\varphi(x^\varphi) = 0$. Or there is contact with the rigid environment, or contact with another deformed subbody, or self-contact in x^φ , i.e.

$$x^\varphi \in \partial\mathbf{Box} \quad \text{or} \quad \text{card } \varphi^{-1}(\{x^\varphi\}) > 1,$$

and the traction in x^φ is a pressure, $T^\varphi(x^\varphi)n^\varphi(x^\varphi) = \lambda^\varphi(x^\varphi)n^\varphi(x^\varphi)$, $\lambda^\varphi(x^\varphi) \leq 0$. That is, the traction has no component being tangential to the deformed outer boundary and is directed inwards the deformed body. Hence, there can only be **frictionless mechanical contact on the deformed outer boundary**.

The phenomenon of frictionless mechanical contact on a deformed body's boundary that rests in a deformed configuration of minimal energy among those accounting for noninterpenetration, was in the context of geometrically nonlinear elasticity first studied by Philippe G. Ciarlet and Jindřich Nečas. Both in their earlier work on unilateral contact Ciarlet and Nečas [1985], as well as in Ciarlet and Nečas [1987], which the reader already encountered in Section 2.2.2.

Finally, by case 4, on the deformed inner contact boundaries $\varphi^\pm(\Gamma_{C,\varepsilon})$ one first observes that around a point $x^\varphi = x^{\varphi,\pm} \in \varphi^+(\Gamma_{C,\varepsilon}) \cap \varphi^-(\Gamma_{C,\varepsilon})$, **where the lamination is not broken**, i.e.

$$\text{there is } r > 0 \text{ such that } z^{\varphi,+} = z^{\varphi,-} \text{ for all } z \in B_r(x) \cap \Gamma_{C,\varepsilon},$$

stresses are transferred across the deformed inner contact boundary like in the solid body, that is $-\text{div}^\varphi T^\varphi(x^\varphi) = f^\varphi(x^\varphi)$. If however the lamination is broken, i.e. $x^{\varphi,+} \neq x^{\varphi,-}$, then like in the case of the deformed outer boundary, different geometrical situations can occur in $x^{\varphi,+}$ and $x^{\varphi,-}$. The author confines himself with characterizing the case of $x^{\varphi,+}$, the one of $x^{\varphi,-}$ being analogously inferred from Remark 2.15. Either there is no contact with the rigid environment and no contact with another deformed subbody and no self-contact in $x^{\varphi,+}$, i.e.

$$x^{\varphi,+} \in \text{int } \mathbf{Box} \quad \text{and} \quad \varphi^{-1}(\{x^{\varphi,+}\}) = \{x\},$$

in which the traction in $x^{\varphi,+}$ is

$$\begin{aligned} & T^{\varphi,+}(x^{\varphi,+}) (-n^{\varphi,+}(x^{\varphi,+})) \\ &= f_{\text{back}} \left(|x^{\varphi,+} - x^{\varphi,-}| \right) \frac{x^{\varphi,-} - x^{\varphi,+}}{|x^{\varphi,+} - x^{\varphi,-}|} \frac{da(x)}{da^{\varphi,+}(x^{\varphi,+})}, \end{aligned}$$

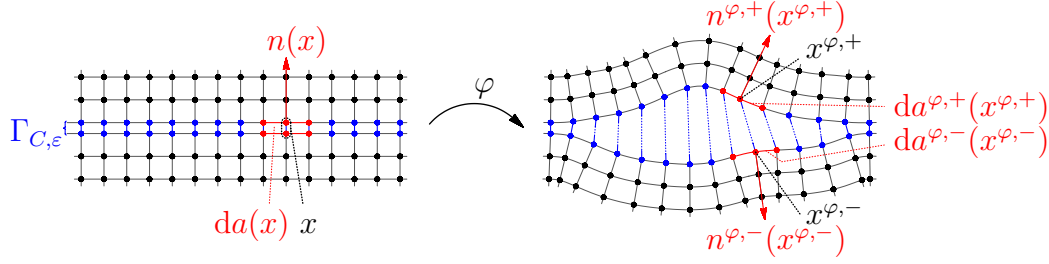

Figure 2.11: The backdriving force in the deformed configuration

hence it equals a *backdriving force resulting from the broken lamination*. Recall, that $f_{\text{back}}(t) = \frac{d\theta}{dt}(t)$, $t > 0$. Regarding the backdriving force, the author states the following properties.

- (i) The backdriving force acting in $x^{\varphi,+}$ is oriented towards the originally with $x^{\varphi,+}$ laminated point $x^{\varphi,-}$ and
- (ii) is weighted with $\frac{da(x)}{da^{\varphi,+}(x^{\varphi,+})}$. Physically this means, that if on the area element $da(x) \subseteq \Gamma_{C,\varepsilon}$ a number of K atomic bonds are broken, then the backdriving force acting on the deformed area element $da^{\varphi,+}(x^{\varphi,+})$ is the one generated by these K broken bonds, see Figure 2.11.

In the other situation, where there is contact with the rigid environment, or contact with another deformed subbody, or self-contact in $x^{\varphi,+}$, i.e.

$$x^{\varphi,+} \in \partial\mathbf{Box} \quad \text{or} \quad \text{card } \varphi^{-1}(\{x^{\varphi,+}\}) > 1,$$

the superposition of traction and backdriving force in $x^{\varphi,+}$,

$$\begin{aligned} & T^{\varphi,+}(x^{\varphi,+}) (-n^{\varphi,+}(x^{\varphi,+})) \\ & + f_{\text{back}} (|x^{\varphi,+} - x^{\varphi,-}|) \frac{x^{\varphi,+} - x^{\varphi,-}}{|x^{\varphi,+} - x^{\varphi,-}|} \frac{da(x)}{da^{\varphi,+}(x^{\varphi,+})} \\ & = \lambda^{\varphi,+}(x^{\varphi,+}) (-n^{\varphi,+}(x^{\varphi,+})), \quad \lambda^{\varphi,+}(x^{\varphi,+}) \leq 0, \end{aligned}$$

is again a pressure, hence has no component being tangential to the deformed inner contact boundary and is directed inwards the deformed body. Like before one deduces, that also **on the deformed inner contact boundary only frictionless mechanical contact** can occur.

CHAPTER 3

METHODOLOGY AND MATHEMATICAL CONCEPTS

The main objective of the thesis is the rigorous analysis of the mathematical model for the many-body structures, as it was established in the last chapter. Since this analysis requires also some sophisticated results from the calculus of variations and the theory of functions of bounded variation, in this chapter the author will give a short synopsis of all the results needed in the sequel. Their presentation will be self-contained, while the proofs of some particular statements might require secondary results from the literature. Being intended for the unexperienced reader, experts in the field of Γ -convergence and the theory of special functions of bounded variation can skip this chapter and directly proceed with the mathematical analysis of the model from Chapter 2. Doing so, due to the use of standard notation the expert will not find it difficult to occasionally fall back to this chapter in order to look up specific results.

Prior to the statement of the preparatory results, the author will in the next section motivate and decide about the method, by means of which the analysis of the mathematical model from Chapter 2 will be carried out.

3.1 VARIATIONAL HOMOGENIZATION

In the situation of the many-body structures Ω_ε from Section 2.1, one is in view of their practical use generally not interested in the deformation of one single subbody, but in the “overall” or “macroscopic” behaviour of the structure. This idea arises from the fact, that a single subbody is small compared to the overall size of the many-body structure and therefore supposed to contribute only little to the mechanical response of the structure. Recall, that we denoted the ratio of the sizes by the parameter ε . Regarding the smallness of this ratio, a natural way to ac-

count for the macroscopic behaviour of the structure without further distinguishing single subbodies within, is to let the relative size ε of the constituents of the many-body structure Ω_ε tend to zero and to simultaneously study the asymptotics of the associated mathematical model, namely \mathcal{E}_ε . This procedure of eliminating a microstructure by performing the limit as its characteristic size ε vanishes, is what mathematicians call *homogenization*, the limit of the governing terms or equations itself being called *homogenization limit*.

In the present case, in which one is confronted with the task to study the asymptotics of the sequence of functionals $(\mathcal{E}_\varepsilon)_\varepsilon$, one has to decide about a suitable convergence notion. Since each of the \mathcal{E}_ε poses as a minimum problem (cf. Theorem 2.16), the adequate notion appears to be Γ -convergence, being introduced in the next section. One refers to homogenization by means of Γ -convergence also as *variational homogenization*.

3.2 ASYMPTOTICS OF MINIMUM PROBLEMS: Γ -CONVERGENCE

Introduced in the 1970s by Ennio De Giorgi, Γ -convergence as a notion of convergence of minimum problems has proven to be a valuable tool within the calculus of variations and its application to topics such as structural mechanics, phase transitions and homogenization, only to name a few. As the definitions and results in the sequel cover only the author's mathematical needs, the inclined reader will find in Braides [2002] and Dal Maso [1993] more detailed and comprehensive expositions of the matter.

Throughout this section, (X, d) shall denote a metric space, with the common convention

$$x_k \rightarrow x \quad :\Leftrightarrow \quad d(x_k, x) \rightarrow 0$$

for sequences $(x_k)_k$ and x in X .

The definition of Γ -convergence reads as follows.

Definition 3.1 (Γ -convergence). For each $k \in \mathbb{N}$ let $\mathcal{F}_k : X \rightarrow [-\infty, \infty]$ be a function, $x \in X$ and $f_\infty \in [-\infty, \infty]$. The sequence $(\mathcal{F}_k)_k$ is said to Γ -converge in x to f_∞ with respect to the metric d , in symbols $(\Gamma(d)\text{-lim}_k \mathcal{F}_k)(x) = f_\infty$, if there hold the

Γ -lim inf-inequality: for all sequences $(x_k)_k$ in X with $x_k \rightarrow x$ there holds

$$f_\infty \leq \liminf_{k \rightarrow \infty} \mathcal{F}_k(x_k)$$

and the

Γ -lim sup-*inequality*: there exists a sequence, a so-called *recovery sequence* $(x_k)_k$, such that $x_k \rightarrow x$ and

$$f_\infty \geq \limsup_{k \rightarrow \infty} \mathcal{F}_k(x_k).$$

Moreover, the sequence $(\mathcal{F}_k)_k$ is said to Γ -converge to a function $\mathcal{F}_\infty : X \rightarrow [-\infty, \infty]$ with respect to the metric d , in symbols $\Gamma(d)\text{-}\lim_k \mathcal{F}_k = \mathcal{F}_\infty$, if

$$\left(\Gamma(d)\text{-}\lim_{k \rightarrow \infty} \mathcal{F}_k \right) (x) = \mathcal{F}_\infty(x)$$

holds for every $x \in X$.

Remark 3.1. In case the metric d has been explicitly stated once, it will be dropped in the above notation.

A notion or motivation of Γ -convergence the author will use in the heuristic arguments found in the next chapter is the one of *energetic attainability*. Suppose (X, d) represents a set of physical states and the functions $\mathcal{F}_k : X \rightarrow [-\infty, \infty]$ correspond to a hierarchy of physical realities indexed by k , in each of which the state $x \in X$ has energy $\mathcal{F}_k(x)$. If $(\Gamma\text{-}\lim_k \mathcal{F}_k)(x) = f_\infty$, then f_∞ is the minimal energy at which one can arrive in x when approximating it with physical states $(x_k)_k$, respectively interpreted in the physical realities $(\mathcal{F}_k)_k$.

Remark 3.2. Whenever one establishes a mathematical model for a physical problem, the choice of the set of admissible states, i.e. the domain of the mathematical model, is an essential step of the modelling procedure and therefore determined by the problem, but by the scientist as well.

The principal strength of Γ -convergence is its interpretation as *convergence of minimum problems*. This is, under suitable coercivity assumptions on a Γ -convergent sequence of functions $(\mathcal{F}_k)_k$, any cluster point of a sequence of minimizers $(\arg \min_X \mathcal{F}_k)_k$ is a minimizer of the Γ -limit.

Theorem 3.2 (Convergence of minimizers, [Braides, 2002, Theorem 1.21]). *Let $\mathcal{F}_k : X \rightarrow [-\infty, \infty]$, $k \in \mathbb{N}$, be a sequence of functions such that there exists a nonempty compact set $K \subseteq X$ satisfying $\inf_{x \in X} \mathcal{F}_k(x) = \inf_{x \in K} \mathcal{F}_k(x)$ for all k , and suppose moreover that $\Gamma\text{-}\lim_k \mathcal{F}_k = \mathcal{F}_\infty$ for some $\mathcal{F}_\infty : X \rightarrow [-\infty, \infty]$. Then there exists a minimizer of \mathcal{F}_∞ and*

$$\min_{x \in X} \mathcal{F}_\infty(x) = \lim_{k \rightarrow \infty} \left(\inf_{x \in X} \mathcal{F}_k(x) \right).$$

If $(x_k)_k$ is a precompact sequence such that $\lim_k \mathcal{F}_k(x_k) = \lim_k (\inf_{x \in X} \mathcal{F}_k(x))$, then every cluster point of the sequence $(x_k)_k$ is a minimizer for \mathcal{F}_∞ .

Whereas for an arbitrary sequence of functions $(\mathcal{F}_k)_k$ in general a Γ -limit does not exist, the following two helpful quantities always do.

Definition 3.3 (Γ -lim inf and Γ -lim sup). Let $\mathcal{F}_k : X \rightarrow [-\infty, \infty]$, $k \in \mathbb{N}$, be a sequence of functions. The quantities

$$\Gamma\text{-lim inf}_{k \rightarrow \infty} \mathcal{F}_k, \quad \Gamma\text{-lim sup}_{k \rightarrow \infty} \mathcal{F}_k : X \rightarrow [-\infty, \infty],$$

respectively called the *lower Γ -limit* and *upper Γ -limit* of the sequence $(\mathcal{F}_k)_k$, are in every $x \in X$ defined by

$$\begin{aligned} (\Gamma\text{-lim inf}_{k \rightarrow \infty} \mathcal{F}_k)(x) &:= \inf \left\{ \liminf_{k \rightarrow \infty} \mathcal{F}_k(x_k) : (x_k)_k \text{ in } X \text{ such that } x_k \rightarrow x \right\} \\ (\Gamma\text{-lim sup}_{k \rightarrow \infty} \mathcal{F}_k)(x) &:= \inf \left\{ \limsup_{k \rightarrow \infty} \mathcal{F}_k(x_k) : (x_k)_k \text{ in } X \text{ such that } x_k \rightarrow x \right\}. \end{aligned}$$

The next theorem provides a series of both fundamental and useful properties of lower and upper Γ -limits, and states how they can be used for an equivalent characterization of Γ -convergence.

Theorem 3.4 (Properties of Γ -lim inf and Γ -lim sup). *Let there be given the sequence of functions $\mathcal{F}_k : X \rightarrow [-\infty, \infty]$ for $k \in \mathbb{N}$, some $\mathcal{F}_\infty : X \rightarrow [-\infty, \infty]$ and $f_\infty \in [-\infty, \infty]$. Then*

(i) *for all $x \in X$ there is a sequence $(\underline{x}_k)_k$ converging to x such that*

$$(\Gamma\text{-lim inf}_{k \rightarrow \infty} \mathcal{F}_k)(x) = \liminf_{k \rightarrow \infty} \mathcal{F}_k(\underline{x}_k)$$

as well as a sequence $(\bar{x}_k)_k$ converging to x with

$$(\Gamma\text{-lim sup}_{k \rightarrow \infty} \mathcal{F}_k)(x) = \limsup_{k \rightarrow \infty} \mathcal{F}_k(\bar{x}_k),$$

(ii) $\Gamma\text{-lim inf}_k \mathcal{F}_k$ and $\Gamma\text{-lim sup}_k \mathcal{F}_k$ are sequentially lower semicontinuous,

(iii) *for a continuous $\mathcal{G} : X \rightarrow [-\infty, \infty]$*

$$\begin{aligned} \Gamma\text{-lim inf}_{k \rightarrow \infty} (\mathcal{F}_k + \mathcal{G}) &= (\Gamma\text{-lim inf}_{k \rightarrow \infty} \mathcal{F}_k) + \mathcal{G} \\ \Gamma\text{-lim sup}_{k \rightarrow \infty} (\mathcal{F}_k + \mathcal{G}) &= (\Gamma\text{-lim sup}_{k \rightarrow \infty} \mathcal{F}_k) + \mathcal{G}, \end{aligned}$$

(iv) *for all $x \in X$ there holds*

$$(\Gamma\text{-lim}_{k \rightarrow \infty} \mathcal{F}_k)(x) = f_\infty \quad \Leftrightarrow \quad (\Gamma\text{-lim inf}_{k \rightarrow \infty} \mathcal{F}_k)(x) = f_\infty = (\Gamma\text{-lim sup}_{k \rightarrow \infty} \mathcal{F}_k)(x),$$

(v) one has

$$\Gamma\text{-}\lim_{k \rightarrow \infty} \mathcal{F}_k = \mathcal{F}_\infty \Leftrightarrow \Gamma\text{-}\liminf_{k \rightarrow \infty} \mathcal{F}_k = \mathcal{F}_\infty = \Gamma\text{-}\limsup_{k \rightarrow \infty} \mathcal{F}_k.$$

Proof. Statement (i) and (ii) can be found in Braides [2002], Remark 1.26 and Proposition 1.28. The definition of $\Gamma\text{-}\liminf$ and $\Gamma\text{-}\limsup$ immediately entails (iii), as well as (iv) upon taking into account the validity of statement (i). Finally, (v) follows immediately from (iv) by the definition of Γ -convergence. \square

Immediate but utmost important consequences of Theorem 3.4 are the *sequential lower semicontinuity of the Γ -limit* and the *stability of Γ -convergence under continuous perturbations*.

Corollary 3.5. *Let $\mathcal{F}_k : X \rightarrow [-\infty, \infty]$ be functions, $k \in \mathbb{N}$, and suppose the Γ -limit of the sequence $(\mathcal{F}_k)_k$ exists. Then*

(i) $\Gamma\text{-}\lim_k \mathcal{F}_k$ is sequentially lower semicontinuous,

(ii) for a continuous $\mathcal{G} : X \rightarrow [-\infty, \infty]$ there holds

$$\Gamma\text{-}\lim_{k \rightarrow \infty} (\mathcal{F}_k + \mathcal{G}) = \left(\Gamma\text{-}\lim_{k \rightarrow \infty} \mathcal{F}_k \right) + \mathcal{G}.$$

Note, that the sequential lower semicontinuity of the Γ -limit is another major advantage of Γ -convergence, in that Γ -limits usually need not to be relaxed. On the other hand, the stability of Γ -convergence under continuous perturbations implies that any additive continuous component \mathcal{G} , which all the functions \mathcal{F}_k have in common, can be omitted in the Γ -convergence study of $(\mathcal{F}_k)_k$.

In practical applications one gets often stuck when trying to prove the $\Gamma\text{-}\limsup$ -inequality, i.e. when constructing recovery sequences for some alleged Γ -limit. However, in certain situations by using abstract arguments, one can show instead, that some alleged Γ -limit is bounded from below by the upper Γ -limit. But as the next corollary reveals, these two tasks are indeed *equivalent*.

Corollary 3.6. *For every $k \in \mathbb{N}$ let $\mathcal{F}_k : X \rightarrow [-\infty, \infty]$ be a function and $f_\infty \in [-\infty, \infty]$, $x \in X$. Then the $\Gamma\text{-}\limsup$ -inequality holds for $(\mathcal{F}_k)_k$ and f_∞ in x , i.e.*

$$\text{there is a sequence } (x_k)_k \text{ such that } x_k \rightarrow x \text{ and } f_\infty \geq \limsup_{k \rightarrow \infty} \mathcal{F}_k(x_k)$$

if and only if

$$f_\infty \geq \left(\Gamma\text{-}\limsup_{k \rightarrow \infty} \mathcal{F}_k \right)(x).$$

Proof. The implication “ \Rightarrow ” is clear, whereas “ \Leftarrow ” follows from Theorem 3.4, statement (i). \square

In another situation often encountered when constructing recovery sequences for some supposed Γ -limit, one is not able to construct recovery sequences for all elements of the set X , but for a subset only. This though can be sufficient in order to have the Γ -lim sup-inequality on the whole of X , provided the subset is dense in X and some continuity of the alleged Γ -limit on this subset holds true. A precise answer to this issue is given by the next proposition.

Proposition 3.7. *Let $\mathcal{F}_k, \mathcal{F}_\infty : X \rightarrow [-\infty, \infty]$ for $k \in \mathbb{N}$, let $x \in X$ and suppose there exists a sequence $(z_j)_j$ in X such that*

$$(i) \quad z_j \rightarrow x$$

$$(ii) \quad \mathcal{F}_\infty(x) \geq \liminf_{j \rightarrow \infty} \mathcal{F}_\infty(z_j)$$

$$(iii) \quad \text{for all } j \in \mathbb{N} \text{ there holds } \mathcal{F}_\infty(z_j) \geq (\Gamma\text{-lim sup}_k \mathcal{F}_k)(z_j).$$

Then

$$\mathcal{F}_\infty(x) \geq (\Gamma\text{-lim sup}_{k \rightarrow \infty} \mathcal{F}_k)(x).$$

Proof. Taking into account the sequential lower semicontinuity of $\Gamma\text{-lim sup}_k \mathcal{F}_k$ according to Theorem 3.4, one arrives at

$$(\Gamma\text{-lim sup}_{k \rightarrow \infty} \mathcal{F}_k)(x) \leq \liminf_{j \rightarrow \infty} (\Gamma\text{-lim sup}_{k \rightarrow \infty} \mathcal{F}_k)(z_j) \stackrel{(iii)}{\leq} \liminf_{j \rightarrow \infty} \mathcal{F}_\infty(z_j) \stackrel{(ii)}{\leq} \mathcal{F}_\infty(x).$$

\square

Remark 3.3 (On Proposition 3.7). In view of the equivalence of existence of a recovery sequence and boundedness from below by the upper Γ -limit stated in Corollary 3.6, in the situation of Proposition 3.7 the conditions (i) and (ii) together with the existence of a recovery sequence for every z_j imply the existence of a recovery sequence for x .

3.3 SBV AND ITS CALCULUS

In this section the author closely follows the standard reference Ambrosio et al. [2000] on functions of bounded variation, but refers any reader seeking an extensive treatment of the topic also to Evans and Gariepy [1992]. Although in large parts self-contained, when reading the following section it might be useful to keep both monographs handy.

3.3.1 (Special) Functions of bounded variation

From now on until the end of this chapter, the author assumes Ω to be an open and bounded subset of \mathbb{R}^N , where N is some natural number, as are some fixed M and K throughout the section.

Since the use of vector- or matrix-valued Radon-measures is not too widespread among analysts, the author starts his collection of results on functions of bounded variation with the basic definitions and also fixes some notation.

Definition 3.8 (Radon-measures and total variation measure). Let $\mathcal{B}(\Omega)$ be the Borel σ -algebra on Ω , i.e. the σ -algebra generated by the in Ω open sets. A mapping $\mu : \mathcal{B}(\Omega) \rightarrow \mathbb{R}^{M \times K}$ is called a *finite $\mathbb{R}^{M \times K}$ -valued Radon-measure on Ω* , if $\mu(\emptyset) = 0$ and for every countable family $\{E_1, E_2, \dots\}$ of pairwise disjoint $\mathcal{B}(\Omega)$ -measurable sets holds

$$\mu \left(\bigcup_{k=1}^{\infty} E_k \right) = \sum_{k=1}^{\infty} \mu(E_k).$$

For every finite $\mathbb{R}^{M \times K}$ -valued Radon-measure μ on Ω , its *total variation measure* $|\mu|$ is defined as

$$|\mu|(E) := \sup \left\{ \sum_{k=1}^{\infty} |\mu(E_k)| : E_1, E_2, \dots \in \mathcal{B}(\Omega) \text{ pairwise disjoint, } E = \bigcup_{k=1}^{\infty} E_k \right\}$$

where E is $\mathcal{B}(\Omega)$ -measurable.

In case μ is real-valued, its *positive* and *negative parts* are respectively defined as

$$\mu^+ := \frac{|\mu| + \mu}{2} \quad \text{and} \quad \mu^- := \frac{|\mu| - \mu}{2}.$$

Based upon the common Lebesgue-integral, the author uses the following convention for integration w.r.t. finite matrix-valued Radon-measures.

Definition 3.9 (Integrals). Let μ be a finite real-valued Radon-measure on Ω and $u : \Omega \rightarrow [-\infty, \infty]$ be $|\mu|$ -measurable and such that $\int_{\Omega} |u| d|\mu| < \infty$ in the usual Lebesgue-sense. Then one defines

$$\int_{\Omega} u d\mu := \int_{\Omega} u d\mu^+ - \int_{\Omega} u d\mu^-.$$

Now let μ be a finite $\mathbb{R}^{M \times K}$ -valued Radon-measure on Ω . For a $|\mu|$ -measurable $u : \Omega \rightarrow [-\infty, \infty]$ satisfying $\int_{\Omega} |u| d|\mu| < \infty$ one declares the integral

$\int_{\Omega} u \, d\mu$ componentwise, i.e.

$$\int_{\Omega} u \, d\mu := \left(\int_{\Omega} u \, d\mu_{ij} \right)_{i=1, \dots, M, j=1, \dots, K}.$$

Whereas for $u : \Omega \rightarrow \mathbb{R}^{M \times K}$ with $|\mu|$ -measurable components such that all $\int_{\Omega} |u_{ij}| \, d|\mu| < \infty$ one defines

$$\int_{\Omega} u : d\mu := \sum_{i=1}^M \sum_{j=1}^K \int_{\Omega} u_{ij} \, d\mu_{ij}.$$

Evident from the next theorem is, that every bounded linear functional on the space $C_c(\Omega; \mathbb{R}^{M \times K})$ equipped with the supremum norm can be identified to be an integral w.r.t. some finite $\mathbb{R}^{M \times K}$ -valued Radon-measure.

Theorem 3.10 (Riesz representation theorem, [Ambrosio et al., 2000, Theorem 1.54]). *Let $L : C_0(\Omega; \mathbb{R}^{M \times K}) \rightarrow \mathbb{R}$ be a bounded linear functional, $C_0(\Omega; \mathbb{R}^{M \times K})$ being the closure of $C_c(\Omega; \mathbb{R}^{M \times K})$ w.r.t. the supremum norm. Then there exists a unique finite $\mathbb{R}^{M \times K}$ -valued Radon-measure μ on Ω such that*

$$L(u) = \int_{\Omega} u : d\mu$$

for all $u \in C_0(\Omega; \mathbb{R}^{M \times K})$.

Having identified the dual of $C_0(\Omega; \mathbb{R}^{M \times K})$ by Riesz' theorem as the set of all finite $\mathbb{R}^{M \times K}$ -valued Radon-measures, one can define weak*-convergence for finite Radon-measures.

Definition 3.11 (Weak*-convergence for Radon-measures). Let μ, μ_k be finite $\mathbb{R}^{M \times K}$ -valued Radon-measures on Ω , $k \in \mathbb{N}$. The sequence $(\mu_k)_k$ is said to weakly* converge in the sense of Radon-measures to μ , if

$$\lim_{k \rightarrow \infty} \int_{\Omega} u : d\mu_k = \int_{\Omega} u : d\mu$$

holds for all $u \in C_0(\Omega; \mathbb{R}^{M \times K})$.

With respect to weak*-convergence, sequences of finite Radon-measures $(\mu_k)_k$ with a uniform bound on their total variations $(|\mu_k|(\Omega))_k$ are compact.

Theorem 3.12 (Weak*-compactness for Radon-measures, [Ambrosio et al., 2000, Theorem 1.59]). *If $(\mu_k)_k$ is a sequence of finite $\mathbb{R}^{M \times K}$ -valued Radon-measures on Ω such that $\sup_k |\mu_k|(\Omega) < \infty$, then there exists a subsequence $(k(m))_m$ and a finite $\mathbb{R}^{M \times K}$ -valued Radon-measure μ on Ω such that $(\mu_{k(m)})_m$ weakly* converges to μ .*

One is now ready to introduce the space of *functions of bounded variation* $BV(\Omega; \mathbb{R}^M)$ as a natural extension of the Sobolev-space $W^{1,1}(\Omega; \mathbb{R}^M)$. The latter is the space of all $L^1(\Omega; \mathbb{R}^M)$ -functions u , the distributional derivative of which is representable by a $L^1(\Omega; \mathbb{R}^{M \times N})$ -function Du , i.e.

$$\int_{\Omega} u \cdot \operatorname{div} \psi \, dx = - \int_{\Omega} \psi : Du \, dx \quad \text{for all } \psi \in C_c^\infty(\Omega; \mathbb{R}^{M \times N}).$$

Equivalently, $W^{1,1}(\Omega; \mathbb{R}^M)$ can be introduced as the space of all $L^1(\Omega; \mathbb{R}^M)$ -functions u having a distributional derivative, which is representable by a *finite* $\mathbb{R}^{M \times N}$ -valued Radon measure of the form $\tilde{D}u \llcorner \lambda^N \llcorner \Omega$ for some $\tilde{D}u \in L^1(\Omega; \mathbb{R}^{M \times N})$. Now, when dropping any further restriction on the structure of the finite Radon-measure, one arrives at the space of functions of bounded variation.

Definition 3.13 (Functions of bounded variation). A function $u \in L^1(\Omega; \mathbb{R}^M)$ is called a *function of bounded variation in Ω* , if the distributional derivative of u can be represented by a finite $\mathbb{R}^{M \times N}$ -valued Radon-measure Du , i.e. if

$$\int_{\Omega} u \cdot \operatorname{div} \psi \, dx = - \int_{\Omega} \psi : dDu$$

holds for all $\psi \in C_c^\infty(\Omega; \mathbb{R}^{M \times N})$. The space of all functions of bounded variation in Ω is denoted $BV(\Omega; \mathbb{R}^M)$.

Remark 3.4. Although $BV(\Omega; \mathbb{R}^M)$ is a *Banach space* when equipped with the norm

$$\|u\|_{BV(\Omega; \mathbb{R}^M)} := \|u\|_{L^1(\Omega; \mathbb{R}^M)} + |Du|(\Omega),$$

in applications this norm turns out to be too strong in various respects. See also [Ambrosio et al., 2000, Chapter 3] for a discussion of the issue.

In view of Remark 3.4 one seeks a weaker but still manageable convergence notion in $BV(\Omega; \mathbb{R}^M)$, like the one of *weak* convergence in $BV(\Omega; \mathbb{R}^M)$* .

Definition 3.14. Let $u, u_k \in BV(\Omega; \mathbb{R}^M)$, $k \in \mathbb{N}$. The sequence $(u_k)_k$ is said to weakly* converge in $BV(\Omega; \mathbb{R}^M)$ to u , in symbols $u_k \overset{*}{\rightharpoonup} u$ in $BV(\Omega; \mathbb{R}^M)$, if $u_k \rightarrow u$ in $L^1(\Omega; \mathbb{R}^M)$ and Du_k weakly* converges to Du in the sense of Radon-measures.

An equivalent but somewhat simpler characterization of weak* convergence in $BV(\Omega; \mathbb{R}^M)$ is given by the following statement.

Proposition 3.15 ([Ambrosio et al., 2000, Proposition 3.13]). *Let $u, u_k \in BV(\Omega; \mathbb{R}^M)$, $k \in \mathbb{N}$. Then $(u_k)_k$ weakly* converges in $BV(\Omega; \mathbb{R}^M)$ to u if and only if*

$$u_k \rightarrow u \text{ in } L^1(\Omega; \mathbb{R}^M) \quad \text{and} \quad \sup_{k \in \mathbb{N}} |Du_k|(\Omega) < \infty.$$

Like $W^{1,1}(\Omega; \mathbb{R}^M)$ -functions need not to be continuous (cf. the effect of *cavitation*), this observation extends also to $BV(\Omega; \mathbb{R}^M)$, where the effect indeed poses as an essential feature. As it will become evident from the upcoming results, the subset of Ω on which a $BV(\Omega; \mathbb{R}^M)$ -function is *not continuous* (in whatever sense) is vital in the description of the structure of its derivative.

Definition 3.16 (Approximate discontinuity set). Let $u \in BV(\Omega; \mathbb{R}^M)$. The *approximate discontinuity set* S_u of u is defined as the set, in which u is not approximately continuous, i.e. the set of all $x \in \Omega$ such that there is no $z \in \mathbb{R}^M$ satisfying $z = \text{ap lim}_{y \rightarrow x} u(y)$.

Recall the fact, that any $u \in W^{1,1}(\Omega; \mathbb{R}^M)$ with weak derivative $\tilde{D}u \in L^1(\Omega; \mathbb{R}^{M \times N})$ is also in $BV(\Omega; \mathbb{R}^M)$ with derivative $Du = \tilde{D}u \llcorner \lambda^N \llcorner \Omega$. Thus one is naturally interested in the absolutely continuous part of the derivative of a $BV(\Omega; \mathbb{R}^M)$ -function w.r.t. the Lebesgue-measure.

Definition and Theorem 3.17 (Decomposition of the derivative I, cf. [Ambrosio et al., 2000, Theorem 1.28]). *For any $u \in BV(\Omega; \mathbb{R}^M)$ the derivative Du can be decomposed in*

$$Du = D^a u + D^s u,$$

where $D^a u$ is absolutely continuous w.r.t. the Lebesgue-measure $\lambda^N \llcorner \Omega$ and $D^s u$ is singular w.r.t. $\lambda^N \llcorner \Omega$. The density of $D^a u$ w.r.t. $\lambda^N \llcorner \Omega$ is denoted $\nabla u \in L^1(\Omega; \mathbb{R}^{M \times N})$.

For any $BV(\Omega; \mathbb{R}^M)$ -function u , the absolutely continuous part $\nabla u \llcorner \lambda^N \llcorner \Omega$ in Du has a very nice interpretation in regard of the result obtained by Alberto P. Calderón and Antoni Zygmund.

Theorem 3.18 (Calderón-Zygmund, [Ambrosio et al., 2000, Theorem 3.83]). *Any function $u \in BV(\Omega; \mathbb{R}^M)$ is approximately differentiable in λ^N -a.e. point of Ω and the approximate differential $\text{ap } Du$ is the density of the absolutely continuous part $D^a u$ w.r.t. the Lebesgue-measure $\lambda^N \llcorner \Omega$.*

Remark 3.5. Since all the functions the reader will encounter in the sequel, have at least BV -regularity, in view of the preceding theorem the author will henceforth identify the operators $\text{ap } D(\cdot)$ and $\nabla(\cdot)$.

Other than in the Sobolev-context, BV -functions may have jumps across hypersurfaces of positive area, i.e. of positive \mathcal{H}^{N-1} -measure. Indeed, the next proposition reveals that in \mathcal{H}^{N-1} -a.e. point of approximate discontinuity there is a jump across a “measure-theoretical hypersurface”.

Proposition 3.19 (Approximate jumps and approximate normal, [Ambrosio et al., 2000, Proposition 3.69 and Theorem 3.78]). *For any $u \in BV(\Omega; \mathbb{R}^M)$ there exists a Borel subset J_u of S_u and a triplet of Borel functions*

$$(u^+, u^-, \nu_u) : J_u \rightarrow \mathbb{R}^M \times \mathbb{R}^M \times S^{N-1}$$

such that for all $x_0 \in J_u$ with $B_r^\pm(x_0, \nu_u(x_0)) := \{x : x \in B_r(x_0), \pm \nu_u(x_0) \cdot (x - x_0) > 0\}$ there holds

$$\lim_{r \rightarrow 0} \frac{1}{\lambda^N(B_r^\pm(x_0, \nu_u(x_0)))} \int_{B_r^\pm(x_0, \nu_u(x_0))} |u(x) - u^\pm(x_0)| dx = 0.$$

The triplet is for every $x_0 \in J_u$ unique up to permutation of $u^+(x_0)$ and $u^-(x_0)$ and a simultaneous change of the sign of $\nu(x_0)$.

Furthermore, $\mathcal{H}^{N-1}(S_u \setminus J_u) = 0$ and J_u is countably \mathcal{H}^{N-1} -rectifiable, i.e. up to a \mathcal{H}^{N-1} -negligible subset contained in a countable union of Lipschitz-hypersurfaces in \mathbb{R}^N .

Given some $u \in BV(\Omega; \mathbb{R}^M)$, J_u is named the *set of approximate jumps of u* , the vector ν_u *approximate normal on J_u* and u^+, u^- are called the respective *approximate traces on J_u* .

Now taking into account the knowledge about the approximate discontinuity set and the approximate jump set, one can further refine the decomposition of the derivative in $BV(\Omega; \mathbb{R}^M)$ stated in Definition and Theorem 3.17.

Definition and Theorem 3.20 (Decomposition of the derivative II, [Ambrosio et al., 2000, Section 3.9]). *Let $u \in BV(\Omega; \mathbb{R}^M)$ and set*

$$D^j u := D^s u \llcorner J_u \quad \text{and} \quad D^c u := D^s u \llcorner (\Omega \setminus S_u),$$

where $D^j u$ is called the jump part of Du and $D^c u$ the Cantor part of Du . Then one has

$$Du = D^a u + D^s u = D^a u + D^j u + D^c u,$$

and there hold

$$D^a u = \text{ap } Du \llcorner \Omega \quad \text{and} \quad D^j u = (u^+ - u^-) \otimes \nu_u \llcorner J_u.$$

Despite being a very general concept, the space $BV(\Omega; \mathbb{R}^M)$ turns out to be too large for numerous applications like e.g. the treatment of the Mumford-Shah-functional in image segmentation or the treatment of Griffith- and Barenblatt-materials in fracture mechanics. The main reasons are the following. First, the singular part $D^s u$ of the derivative Du of some $BV(\Omega; \mathbb{R}^M)$ -function u is in general not concentrated on a “measure-theoretic hypersurface” as is $D^j u$, but may be “smeared” all over the domain by the cantor part $D^c u$. The latter effect makes $BV(\Omega; \mathbb{R}^M)$ unsuitable for the mentioned applications, also because the respective mathematical models do not provide any control on Cantor parts. And second, one lacks suitable compactness, weak* convergence in $BV(\Omega; \mathbb{R}^M)$ not being sufficient.

In order to overcome these difficulties, Luigi Ambrosio introduced in Ambrosio [1989] a by now widely used function space.

Definition 3.21 (Special functions of bounded variation). A function $u \in BV(\Omega; \mathbb{R}^M)$ is called a *special function of bounded variation in Ω* , if the Cantor part $D^c u$ in its derivative vanishes, in symbols, if

$$Du = D^a u + D^j u = \nabla u \lambda^N \llcorner \Omega + (u^+ - u^-) \otimes \nu_u \mathcal{H}^{N-1} \llcorner J_u. \quad (3.1)$$

The space of all special functions of bounded variation in Ω is denoted $SBV(\Omega; \mathbb{R}^M)$.

Remark 3.6. $SBV(\Omega; \mathbb{R}^M)$ is a closed subspace of $BV(\Omega; \mathbb{R}^M)$ when equipped with the norm topology $\|\cdot\|_{BV(\Omega; \mathbb{R}^M)}$, see [Ambrosio et al., 2000, Corollary 4.3], thus itself a Banach space. Nevertheless, like already in the case of $BV(\Omega; \mathbb{R}^M)$, the norm topology is too strong for most applications.

Remark 3.7. Let u be in $SBV(\Omega; \mathbb{R}^M)$. In order to keep the already complicated notation as simple as possible, the author will exploit the fact that S_u and J_u differ only by a \mathcal{H}^{N-1} -negligible set, thus try to avoid the term J_u . Indeed, by extending the triplet (u^+, u^-, ν_u) to S_u by e.g. $(0, 0, e_1)$, one has

$$(u^+ - u^-) \otimes \nu_u \mathcal{H}^{N-1} \llcorner J_u = (u^+ - u^-) \otimes \nu_u \mathcal{H}^{N-1} \llcorner S_u$$

in the sense of Radon-measures, hence a “ J_u -free” representation of $D^j u$. In the sequel, whenever referring to the jump part $D^j u$ of Du , the author will make use of the above simplified notation. However, the reader will notice that this comes at the cost of loosing some mathematical precision in the notation.

Thinking of applications to fracture mechanics, the author will often denominate the approximate discontinuity set S_u (or the set of approximate jumps J_u) as the *crack generated by u* or simply as the *crack*.

Indeed, the first mentioned problem of “smeared” derivatives of functions of bounded variation is completely ruled out for special functions of bounded variation. That is, a function $u \in BV(\Omega; \mathbb{R}^M)$ belongs to $SBV(\Omega; \mathbb{R}^M)$, if and only if its singular part $D^s u$ is concentrated on a Borel set, which is σ -finite w.r.t. \mathcal{H}^{N-1} (see [Ambrosio et al., 2000, Proposition 4.2]). Also some application-suited compactness holds true in $SBV(\Omega; \mathbb{R}^M)$, in which the reader will be introduced in Subsection 3.3.2.

Since $SBV(\Omega; \mathbb{R}^M)$ consists by definition of functions being weakly differentiable up to a measure theoretical hypersurface at which there may be jumps, one would intuitively expect $SBV(\Omega; \mathbb{R}^M)$ to contain “piecewise Sobolev”-functions. In fact, given a compact subset K of \mathbb{R}^N with $\mathcal{H}^{N-1}(K) < \infty$, any function $u \in W^{1,1}(\Omega \setminus K; \mathbb{R}^M) \cap L^\infty(\Omega \setminus K; \mathbb{R}^M)$ belongs to $SBV(\Omega; \mathbb{R}^M)$ and has its discontinuity set contained in K up to a \mathcal{H}^{N-1} -negligible set, cf. [Ambrosio et al., 2000, Proposition 4.4]. A little more general is the next proposition.

Proposition 3.22. *Let K be a compact subset of \mathbb{R}^N such that $\mathcal{H}^{N-1}(K) < \infty$, and $u \in SBV(\Omega \setminus K; \mathbb{R}^M) \cap L^\infty(\Omega \setminus K; \mathbb{R}^M)$. Write $\bar{u} \in L^1(\Omega; \mathbb{R}^M)$ for the identification of u in $L^1(\Omega; \mathbb{R}^M)$. Then*

$$\bar{u} \in SBV(\Omega; \mathbb{R}^M), \quad \nabla \bar{u} = \nabla u \text{ a.e. in } \Omega \quad \text{and} \quad S_{\bar{u}} \subseteq S_u \cup K.$$

Proof. First one shows by the same technique employed in the proof of the recently cited [Ambrosio et al., 2000, Proposition 4.4] that $\bar{u} \in BV(\Omega; \mathbb{R}^M)$. Now recall that, as said subsequent to Remark 3.7,

$$\bar{u} \in SBV(\Omega; \mathbb{R}^M) \quad \Leftrightarrow \quad D^s \bar{u} \text{ is concentrated on a } \mathcal{H}^{N-1}\text{-}\sigma\text{-finite Borel set.}$$

But $D^s \bar{u}$ is clearly concentrated on $S_u \cup K$, which is a Borel set σ -finite w.r.t. \mathcal{H}^{N-1} . Indeed, S_u is countably \mathcal{H}^{N-1} -rectifiable (see Proposition 3.19), K is compact and $\mathcal{H}^{N-1}(K) < \infty$. Thus $\bar{u} \in SBV(\Omega; \mathbb{R}^M)$ as claimed and $S_{\bar{u}} \subseteq S_u \cup K$.

Moreover, taking into account that \bar{u} is the identification of u in $L^1(\Omega; \mathbb{R}^M)$, one infers $\text{ap } Du = \text{ap } D\bar{u}$ a.e. in Ω and by Theorem 3.18 the identity $\nabla u = \nabla \bar{u}$ a.e. in Ω . \square

Another elementary but important feature of $SBV(\Omega; \mathbb{R}^M)$ the author will make use of, is its behaviour under Lipschitz-regular coordinate-transformations: The chain rule known from classical calculus remains valid in an intuitive sense, confer in particular [Ambrosio et al., 2000, Exercise 4.5].

Proposition 3.23 (Coordinate transformations in SBV). *Let G be an open and bounded subset of \mathbb{R}^N , $\Phi : G \rightarrow \Omega$ be invertible and such that*

$$(i) \quad \Phi \in W^{1,\infty}(G; \mathbb{R}^N),$$

(ii) $\Phi^{-1} \in W^{1,\infty}(\Omega; \mathbb{R}^N)$ and Φ^{-1} is Lipschitz,

(iii) $\det D\Phi > 0$ a.e. in G .

Then for all $u \in SBV(\Omega; \mathbb{R}^M)$ the function $v := u \circ \Phi$ is in $SBV(G; \mathbb{R}^M)$ and there holds

$$\nabla v = (\nabla u \circ \Phi) \cdot D\Phi \text{ a.e. in } G \quad \text{and} \quad S_v = \Phi^{-1}(S_u).$$

Proof. The proof follows a hint given in [Ambrosio et al., 2000, Exercise 4.5]. Nevertheless, it is a minor but very useful generalization of it. Because of its technical character, it will be split into several steps.

Step 1. According to [Ambrosio et al., 2000, Theorem 3.16] one has first $v \in BV(G; \mathbb{R}^M)$ and moreover the estimate

$$|Dv| \leq \text{Lip}(\Phi^{-1})^{N-1} |Du|(\Phi(\cdot)). \quad (3.2)$$

Step 2. Consider $x \in G$ such that u is approximately continuous in $y = \Phi(x)$ with approximate limit $\text{ap lim}_{\zeta \rightarrow y} u(\zeta) = L$. Let $r > 0$ be small enough to have $B_r(x) \subseteq G$. Then, with the help of the change of variables formula for Lipschitz-transformations (see [Evans and Gariepy, 1992, Section 3.4, Theorem 2]),

$$\begin{aligned} \frac{1}{\text{vol } B_r(x)} \int_{B_r(x)} |v(z) - L| \, dz &= \frac{1}{\text{vol } B_r(x)} \int_{B_r(x)} |u(\Phi(z)) - L| \, dz \\ &= \frac{1}{\text{vol } B_r(x)} \int_{\Phi(B_r(x))} |u(z) - L| |\det D(\Phi^{-1})(z)| \, dz. \end{aligned} \quad (3.3)$$

Upon recalling $\Phi \in W^{1,\infty}(G; \mathbb{R}^N)$, one infers its Lipschitz-regularity on the convex set $B_r(x)$ (see [Ambrosio et al., 2000, Proposition 2.13]). Thus, for all $\zeta = \Phi(\xi) \in \Phi(B_r(x))$ there holds

$$\begin{aligned} |\zeta - \Phi(x)| &= |\Phi(\xi) - \Phi(x)| \leq \text{Lip}(\Phi, B_r(x)) |\xi - x| \\ &\leq \|D\Phi\|_{L^\infty(G; \mathbb{R}^N)} \cdot r, \end{aligned}$$

from which one immediately deduces

$$\Phi(B_r(x)) \subseteq B_{r \cdot \|D\Phi\|_{L^\infty}}(\Phi(x)). \quad (3.4)$$

Inserting this into (3.3) results in

$$\begin{aligned} &\frac{1}{\text{vol } B_r(x)} \int_{B_r(x)} |v(z) - L| \, dz \\ &\leq \frac{\|D\Phi\|_{L^\infty}^N \|D(\Phi^{-1})\|_{L^\infty}^N}{\text{vol } B_{r \cdot \|D\Phi\|_{L^\infty}}(y)} \int_{B_{r \cdot \|D\Phi\|_{L^\infty}}(y)} |u(z) - L| \, dz \xrightarrow[r \rightarrow 0]{} 0, \end{aligned}$$

showing that v is approximately continuous in x with approximate limit

$$\operatorname{ap\,lim}_{\xi \rightarrow x} v(\xi) = L = \operatorname{ap\,lim}_{\zeta \rightarrow \Phi(x)} u(\zeta). \quad (3.5)$$

One then furthermore obtains

$$\Phi^{-1}(\Omega \setminus S_u) \subseteq G \setminus S_v, \quad \text{thus} \quad \Phi^{-1}(S_u) \supseteq S_v. \quad (3.6)$$

Interchanging the roles of u and v and simultaneously of Φ and Φ^{-1} , the very same computation gives $\Phi(S_v) \supseteq S_u$. A combination of this with (3.6) entails

$$S_v = \Phi^{-1}(S_u). \quad (3.7)$$

Step 3. Now let $x \in G$ such that Φ is differentiable in x in the classical sense and u is approximately differentiable in $y = \Phi(x)$. These properties hold true for a.a. $x \in G$, by Rademacher's Theorem and Theorem 3.18. Set

$$L := \operatorname{ap\,lim}_{\zeta \rightarrow \Phi(x)} u(\zeta) \stackrel{(3.5)}{=} \operatorname{ap\,lim}_{\xi \rightarrow x} v(\xi) \quad \text{and} \quad M := \nabla u(\Phi(x)) \operatorname{D}\Phi(x)$$

and consider the quantity

$$\frac{1}{\operatorname{vol} B_r(x)} \int_{B_r(x)} \frac{|v(z) - L - M(z - x)|}{r} \, dz =: \textit{term}.$$

Furthermore write

$$\begin{aligned} |v(z) - L - M(z - x)| &\leq |v(z) - L - \nabla u(y)(\Phi(z) - y)| \\ &\quad + |\nabla u(y)(\Phi(z) - y) - M(z - x)|. \end{aligned}$$

Hence, one can estimate *term* like

$$\begin{aligned} \textit{term} &\leq \frac{1}{\operatorname{vol} B_r(x)} \int_{B_r(x)} \frac{|u(\Phi(z)) - L - \nabla u(y)(\Phi(z) - y)|}{r} \, dz \\ &\quad + \frac{1}{\operatorname{vol} B_r(x)} \int_{B_r(x)} \frac{|\nabla u(y)(\Phi(z) - y) - M(z - x)|}{r} \, dz \\ &=: \textit{term}_1 + \textit{term}_2. \end{aligned}$$

As concerns *term*₁, there holds by the change of variables formula

$$\begin{aligned} \textit{term}_1 &= \frac{1}{\operatorname{vol} B_r(x)} \int_{\Phi(B_r(x))} \frac{|u(z) - L - \nabla u(y)(z - y)|}{r} |\det \operatorname{D}(\Phi^{-1})(z)| \, dz \\ &\stackrel{(3.4)}{\leq} \frac{\|\operatorname{D}\Phi\|_{L^\infty}^{N+1} \|\operatorname{D}(\Phi^{-1})\|_{L^\infty}^N}{\operatorname{vol} B_{r \cdot \|\operatorname{D}\Phi\|_{L^\infty}}(y)} \\ &\quad \int_{B_{r \cdot \|\operatorname{D}\Phi\|_{L^\infty}}(y)} \frac{|u(z) - L - \nabla u(y)(z - y)|}{r \|\operatorname{D}\Phi\|_{L^\infty}} \, dz \xrightarrow{r \rightarrow 0} 0. \end{aligned}$$

In $term_2$ one has

$$term_2 \leq \frac{1}{\text{vol } B_r(x)} \int_{B_r(x)} |\nabla u(y)| \frac{|\Phi(z) - \Phi(x) - D\Phi(x)(z-x)|}{r} dz \xrightarrow{r \rightarrow 0} 0$$

because of the differentiability of Φ in x . In conclusion, one infers now that $term \rightarrow 0$ as r vanishes. Thus v is approximately differentiable in x and one has the identity

$$\nabla v(x) = M = \nabla u(\Phi(x)) D\Phi(x).$$

Step 4. One eventually turns to the proof of the claim $v \in SBV(G; \mathbb{R}^M)$; recall, that by the first step one already knows $v \in BV(G; \mathbb{R}^M)$. The start will make the following definition. For every $w \in BV(U; \mathbb{R}^M)$, where U is some open and bounded subset of \mathbb{R}^N , one defines the set

$$S^w := \left\{ x : x \in U, \lim_{r \rightarrow 0} \frac{1}{r^N} |Dw|(B_r(x)) = \infty \right\}.$$

From [Ambrosio et al., 2000, Proposition 3.92], it is easily inferred, that

$$D^c w = Dw \llcorner (S^w \setminus S_w). \quad (3.8)$$

Now let $x \in S^v$, i.e. $\lim_{r \rightarrow 0} \frac{1}{r^N} |Dv|(B_r(x)) = \infty$. From (3.2) one then infers

$$\lim_{r \rightarrow 0} \frac{1}{r^N} |Du|(\Phi(B_r(x))) = \infty. \quad (3.9)$$

By means of (3.4) one furthermore deduces therefrom

$$\lim_{r \rightarrow 0} \frac{1}{r^N} |Du|(B_{r \cdot \|D\Phi\|_{L^\infty}}(\Phi(x))) = \infty,$$

thus $\Phi(x) \in S^u$. Therefore $\Phi(S^v) \subseteq S^u$, or equivalently $S^v \subseteq \Phi^{-1}(S^u)$. With the help of the above established identity (3.7), this leads to

$$S^v \setminus S_v \subseteq \Phi^{-1}(S^u \setminus S_u). \quad (3.10)$$

Hence, by characterization (3.8) of the Cantor part $D^c v$, for all $B \in \mathcal{B}(G)$ there holds

$$\begin{aligned} |D^c v(B)| &= |Dv((S^v \setminus S_v) \cap B)| \leq |Dv|((S^v \setminus S_v) \cap B) \\ &\leq \text{Lip}(\Phi^{-1})^{N-1} |Du|(\Phi((S^v \setminus S_v) \cap B)) \quad \text{by (3.2)} \\ &\leq \text{Lip}(\Phi^{-1})^{N-1} |Du|((S^u \setminus S_u) \cap \Phi(B)) \quad \text{by (3.10)} \\ &= \text{Lip}(\Phi^{-1})^{N-1} |D^c u|(\Phi(B)) \quad \text{by (3.8)} \\ &= 0, \end{aligned}$$

because $u \in SBV(\Omega; \mathbb{R}^M)$ has by definition vanishing Cantor part. Consequently, $D^c v = 0$ and $v \in SBV(G; \mathbb{R}^M)$. In view of assertions of step 2 and step 3, the proof of the proposition is now complete. \square

The concept of $SBV(\Omega; \mathbb{R}^M) \ni u$ is further adapted by imposing higher integrability on ∇u and finiteness on $\mathcal{H}^{N-1}(S_u)$ as they are required by numerous applications. Following the notation used in recent works like Giacomini and Ponsiglione [2008], the author also introduces a notion of “weak convergence” in the following variant of $SBV(\Omega; \mathbb{R}^M)$.

Definition 3.24. Let $1 < p < \infty$. The space $SBV^p(\Omega; \mathbb{R}^M)$ is defined as

$$SBV^p(\Omega; \mathbb{R}^M) := \left\{ u : u \in SBV(\Omega; \mathbb{R}^M), \right. \\ \left. \nabla u \in L^p(\Omega; \mathbb{R}^{M \times N}), \mathcal{H}^{N-1}(S_u) < \infty \right\}.$$

Let $(u_k)_k$ and u be in $SBV^p(\Omega; \mathbb{R}^M)$. The sequence $(u_k)_k$ is said to weakly converge in $SBV^p(\Omega; \mathbb{R}^M)$ to u , in symbols $u_k \rightharpoonup u$ in $SBV^p(\Omega; \mathbb{R}^M)$, if

$$\begin{aligned} u_k &\rightharpoonup u && \text{in } L^1(\Omega; \mathbb{R}^M), \\ \nabla u_k &\rightharpoonup \nabla u && \text{in } L^p(\Omega; \mathbb{R}^{M \times N}) \\ &&& \text{and } \sup_{k \in \mathbb{N}} \mathcal{H}^{N-1}(S_{u_k}) < \infty. \end{aligned}$$

Remark 3.8. Let $(u_k)_k$ and u be in $SBV^p(\Omega; \mathbb{R}^M)$ such that $u_k \rightharpoonup u$ in $SBV^p(\Omega; \mathbb{R}^M)$ and $\sup_k \|u_k\|_{L^\infty(\Omega; \mathbb{R}^M)} < \infty$. Since these conditions imply $\sup_k |Du_k|(\Omega) < \infty$, from Proposition 3.15 one obtains

$$u_k \xrightarrow{*} u \quad \text{in } BV(\Omega; \mathbb{R}^N).$$

3.3.2 Compactness and lower semicontinuity in SBV^p

The suitability of the above introduced concept $SBV^p(\Omega; \mathbb{R}^M)$ for applications within the calculus of variations – such as e.g. the mentioned Mumford-Shah-functional in image segmentation or Griffith- and Barenblatt-materials in fracture mechanics – also derives from its compactness and sequential lower semicontinuity properties for a wide variety of integral functionals, both w.r.t. what the author calls weak convergence in $SBV^p(\Omega; \mathbb{R}^M)$.

Having in mind the application to the physical problem posed in Chapter 2, the author already adopted the prerequisites for the statements listed here to this very application. In particular, *from now on until the end of the chapter the author imposes* $p > N$, in accordance with the growth-assumption (W2) made on the

elastic energy density W in Subsection 2.2.1. Moreover, the author sets $M = N$, thus restricts himself in the presentation of the following theorems to functions in $SBV^p(\Omega; \mathbb{R}^N)$, also called *deformations*.

It should be noticed though, that nearly all results cited in this section usually hold under less restrictive assumptions. For a more detailed discussion of the matter, the reader is referred to the corresponding references.

The start will make a compactness theorem, which is due to Luigi Ambrosio.

Theorem 3.25 (Compactness, cf. [Ambrosio et al., 2000, Theorems 4.7,4.8]). *Let $(\varphi_k)_k$ be a sequence in $SBV^p(\Omega; \mathbb{R}^N)$ satisfying*

$$\sup_{k \in \mathbb{N}} \left\{ \|\varphi_k\|_{L^\infty(\Omega; \mathbb{R}^N)} + \|\nabla \varphi_k\|_{L^p(\Omega; \mathbb{M}^N)} + \mathcal{H}^{N-1}(S_{\varphi_k}) \right\} < \infty.$$

Then there is a subsequence $(k(m))_m$ and a $\varphi \in SBV^p(\Omega; \mathbb{R}^N)$ such that

$$\varphi_{k(m)} \rightharpoonup \varphi \quad \text{in } SBV^p(\Omega; \mathbb{R}^N).$$

In analogy to the situation in the Sobolev-space $W^{1,p}(\Omega; \mathbb{R}^N)$, the Jacobian determinant turns out to be continuous w.r.t. weak convergence.

Theorem 3.26 (Weak continuity of the Jacobian determinant, cf. [Ambrosio et al., 2000, Corollary 5.31]). *Let $(\varphi_k)_k$ and φ be in $SBV^p(\Omega; \mathbb{R}^N)$ such that $\varphi_k \rightharpoonup \varphi$ in $SBV^p(\Omega; \mathbb{R}^N)$. Then for every $1 \leq r < \frac{p}{N}$ there holds*

$$\det \nabla \varphi_k \rightharpoonup \det \nabla \varphi \quad \text{in } L^r(\Omega).$$

The next quite recent result established by Alessandro Giacomini and Marcello Ponsiglione poses as a major step in adopting the SBV^p -calculus to geometrically nonlinear continuum mechanics.

Theorem 3.27 (Stability of the Ciarlet-Nečas condition). *Let $(\varphi_k)_k$ and φ be in $SBV^p(\Omega; \mathbb{R}^N)$ such that φ_k satisfies the Ciarlet-Nečas condition for every $k \in \mathbb{N}$, and $\varphi_k \rightharpoonup \varphi$ in $SBV^p(\Omega; \mathbb{R}^N)$. Then φ satisfies the Ciarlet-Nečas condition.*

Proof. Theorem 3.26 entails $\det \nabla \varphi_k \rightharpoonup \det \nabla \varphi$ in $L^1(\Omega)$ and with the help of [Giacomini and Ponsiglione, 2008, Theorem 4.4] one now infers the validity of the above statement. \square

As said in the introductory comment of this subsection, for a large class of integral functionals one has sequential lower semicontinuity w.r.t. weak convergence in $SBV^p(\Omega; \mathbb{R}^N)$. This holds in particular true for integral functionals with densities like the ones used in the description of the physical problem of Chapter 2, see Subsection 2.2.1.

Theorem 3.28 (Sequential lower semicontinuity for surface integrals, cf. [Ambrosio et al., 2000, Theorem 5.22, Example 5.23]). *Let K be a compact subset of \mathbb{R}^N and θ satisfy $(\theta 1), \dots, (\theta 3)$. Moreover let $\phi : \mathbb{R}^N \rightarrow [0, \infty)$ be even, positively 1-homogeneous, convex and have a positive uniform bound from below on S^{N-1} . Then for $(\varphi_k)_k$ and φ in $SBV^p(\Omega; \mathbb{R}^N)$, satisfying for all $k \in \mathbb{N}$ the confinement condition $\varphi_k(x) \in K$ for a.e. $x \in \Omega$ and being such that $\varphi_k \rightharpoonup \varphi$ in $SBV^p(\Omega; \mathbb{R}^N)$, there holds*

$$\int_{S_\varphi} \phi(\nu_\varphi) \theta(|\varphi^+ - \varphi^-|) d\mathcal{H}^{N-1} \leq \liminf_{k \rightarrow \infty} \int_{S_{\varphi_k}} \phi(\nu_{\varphi_k}) \theta(|\varphi_k^+ - \varphi_k^-|) d\mathcal{H}^{N-1}.$$

Theorem 3.29 (Sequential lower semicontinuity for bulk integrals). *Let W satisfy the assumptions $(W1), \dots, (W3)$. Then for $(\varphi_k)_k$ and φ in $SBV^p(\Omega; \mathbb{R}^N)$ such that $\varphi_k \rightharpoonup \varphi$ in $SBV^p(\Omega; \mathbb{R}^N)$ there holds*

$$\int_{\Omega} W(\nabla \varphi) dx \leq \liminf_{k \rightarrow \infty} \int_{\Omega} W(\nabla \varphi_k) dx.$$

In case the right hand side is finite, one infers $\det \nabla \varphi > 0$ a.e. in Ω .

Proof. Regarding the assumptions on W , the proof follows from the continuity of the Jacobian determinant w.r.t. weak convergence in $SBV^p(\Omega; \mathbb{R}^N)$ and the sequential lower semicontinuity property of polyconvex integral functionals stated in Lemma 2.9. \square

As an important corollary of these lower semicontinuity results one can now conclude the following.

Corollary 3.30 (Existence of minimizers). *Let \mathbf{Box} be a compact subset of \mathbb{R}^N with nonempty interior and $M \subseteq SBV^p(\Omega; \mathbb{R}^N)$ be closed w.r.t. weak convergence in $SBV^p(\Omega; \mathbb{R}^N)$ and such that $\text{Kin}(\Omega; \mathbf{Box}) \cap M$ is nonempty. Let W satisfy $(W1), \dots, (W3)$, θ be in accordance with $(\theta 1), \dots, (\theta 3)$ and ϕ like in Theorem 3.28. Moreover, the functional \hat{F} shall satisfy $(\hat{F}1), (\hat{F}2)$. Set $\mathcal{F} : SBV^p(\Omega; \mathbb{R}^N) \cap \text{Kin}(\Omega; \mathbf{Box}) \rightarrow (-\infty, \infty]$,*

$$\mathcal{F}(\varphi) := \begin{cases} \int_{\Omega} W(\nabla \varphi) dx + \int_{S_\varphi} \phi(\nu_\varphi) \theta(|\varphi^+ - \varphi^-|) d\mathcal{H}^{N-1} \\ \quad - \int_{\Omega} \hat{F}(x, \varphi(x)) dx & \text{if } \varphi \in M, \\ \infty, & \text{otherwise} \end{cases}$$

Then

- (i) \mathcal{F} is sequentially lower semicontinuous w.r.t. the strong $L^1(\Omega; \mathbb{R}^N)$ -topology,

(ii) *there is a minimizer of \mathcal{F} .*

Proof. Let $(\varphi_k)_k$ and φ be in $SBV^p(\Omega; \mathbb{R}^N) \cap \text{Kin}(\Omega; \mathbf{Box})$ such that $\varphi_k \rightharpoonup \varphi$ in $L^1(\Omega; \mathbb{R}^N)$. Without loss of generality assume

$$\infty > \liminf_{k \rightarrow \infty} \mathcal{F}(\varphi_k) = \lim_{m \rightarrow \infty} \mathcal{F}(\varphi_{k(m)}),$$

where $(k(m))_m$ is an appropriate subsequence. Hence one has $\varphi_{k(m)} \in M$ for all $m \in \mathbb{N}$. Then (W1), (W2) and the **Box**-constraint, the boundedness of \hat{F} by $(\hat{F}2)$, $(\theta2)$, $(\theta3)$ and the uniform lower bound of ϕ on S^{N-1} imply

$$\infty > \sup_{m \in \mathbb{N}} \left\{ \|\varphi_{k(m)}\|_{L^\infty(\Omega; \mathbb{R}^N)} + \|\nabla \varphi_{k(m)}\|_{L^p(\Omega; \mathbb{M}^N)} + \mathcal{H}^{N-1}(S_{\varphi_{k(m)}}) \right\}.$$

From Theorem 3.25 one obtains the existence of a subsequence (here not relabeled) such that $\varphi_{k(m)} \rightharpoonup \varphi$ in $SBV^p(\Omega; \mathbb{R}^N)$, and by the closedness of M w.r.t. weak convergence in $SBV^p(\Omega; \mathbb{R}^N)$ one also infers $\varphi \in M$. Hence for $\mathcal{F}(\varphi)$ there applies the integral representation in the definition of \mathcal{F} . Now thanks to the sequential lower semicontinuity results in Theorems 3.29 and 3.28 and the L^1 -continuity of $\psi \mapsto \int_\Omega \hat{F}(x, \psi(x))$ according to $(\hat{F}1)$ one arrives at

$$\mathcal{F}(\varphi) \leq \liminf_{m \rightarrow \infty} \mathcal{F}(\varphi_{k(m)}) = \liminf_{k \rightarrow \infty} \mathcal{F}(\varphi_k),$$

which proves the first statement of the corollary.

In order to prove the second one, one first observes that \mathcal{F} is bounded from below thanks to the boundedness of \hat{F} . Moreover, since weak convergence in $SBV^p(\Omega; \mathbb{R}^N)$ implies by definition strong convergence in $L^1(\Omega; \mathbb{R}^N)$, the first statement of the corollary entails that \mathcal{F} is sequentially lower semicontinuous w.r.t. weak convergence in $SBV^p(\Omega; \mathbb{R}^N)$. One now shows, that sublevels of \mathcal{F} are sequentially precompact w.r.t. weak convergence in $SBV^p(\Omega; \mathbb{R}^N)$. Let $(\varphi_k)_k$ be a sequence in $SBV^p(\Omega; \mathbb{R}^N) \cap \text{Kin}(\Omega; \mathbf{Box})$ and suppose that for some real number C there holds $C \geq \mathcal{F}(\varphi_k)$ for all $k \in \mathbb{N}$. An application of the previous arguments results once more in

$$\infty > \sup_{k \in \mathbb{N}} \left\{ \|\varphi_k\|_{L^\infty(\Omega; \mathbb{R}^N)} + \|\nabla \varphi_k\|_{L^p(\Omega; \mathbb{M}^N)} + \mathcal{H}^{N-1}(S_{\varphi_k}) \right\},$$

and the Compactness-Theorem 3.25 again provides the existence of a subsequence $(k(m))_m$ and a $\varphi \in SBV^p(\Omega; \mathbb{R}^N)$ such that $\varphi_{k(m)} \rightharpoonup \varphi$ in $SBV^p(\Omega; \mathbb{R}^N)$. It remains to show that $\varphi \in \text{Kin}(\Omega; \mathbf{Box})$. By the compactness of **Box** there obviously holds $\varphi(x) \in \mathbf{Box}$ for a.e. $x \in \Omega$. Whereas Theorem 3.27 gives that φ satisfies the Ciarlet-Nečas condition. Finally, from the uniform boundedness of $(\mathcal{F}(\varphi_k))_k$ one also infers the uniform boundedness of $(\int_\Omega W(\nabla \varphi_k) dx)_k$. Recalling that $\varphi_{k(m)} \rightharpoonup \varphi$ in $SBV^p(\Omega; \mathbb{R}^N)$, from Theorem 3.29 one obtains $\det \nabla \varphi > 0$ a.e. in Ω . Hence $\varphi \in \text{Kin}(\Omega; \mathbf{Box})$. The claimed existence of a minimizer of \mathcal{F} is now an immediate consequence of Proposition 2.5. \square

To conclude the section, the author remarks that weak convergence in $SBV^p(\Omega; \mathbb{R}^N)$ conserves the orientation of the approximate normal, hence the orientation of the set of approximate jumps, in the following sense.

Proposition 3.31 (Conservation of crack orientation). *Let $(\varphi_k)_k$ be a sequence in $SBV^p(\Omega; \mathbb{R}^N)$ satisfying $\sup_k \|\varphi_k\|_{L^\infty(\Omega; \mathbb{R}^N)} < \infty$ and for an $i \in \{1, \dots, N\}$*

$$\nu_{\varphi_k, i} = 0 \quad \mathcal{H}^{N-1}\text{-a.e. on } S_{\varphi_k}$$

for all $k \in \mathbb{N}$. In case there is $\varphi \in SBV^p(\Omega; \mathbb{R}^N)$ such that $\varphi_k \rightharpoonup \varphi$ in $SBV^p(\Omega; \mathbb{R}^N)$ one has

$$\nu_{\varphi, i} = 0 \quad \mathcal{H}^{N-1}\text{-a.e. on } S_\varphi.$$

Proof. By Remark 3.8 there holds $D\varphi_k \xrightarrow{*} D\varphi$ in the sense of Radon-measures, which together with $\nabla\varphi_k \rightharpoonup \nabla\varphi$ in $L^p(\Omega; \mathbb{M}^N)$ implies $D^j\varphi_k \xrightarrow{*} D^j\varphi$ in the sense of Radon-measures, i.e.

$$\int_{S_{\varphi_k}} \psi : (\varphi_k^+ - \varphi_k^-) \otimes \nu_{\varphi_k} d\mathcal{H}^{N-1} \rightarrow \int_{S_\varphi} \psi : (\varphi^+ - \varphi^-) \otimes \nu_\varphi d\mathcal{H}^{N-1}$$

for all $\psi \in C_0(\Omega; \mathbb{M}^N)$. In particular

$$\int_{S_{\varphi_k}} \psi \cdot \nu_{\varphi_k, i} (\varphi_k^+ - \varphi_k^-) d\mathcal{H}^{N-1} \rightarrow \int_{S_\varphi} \psi \cdot \nu_{\varphi, i} (\varphi^+ - \varphi^-) d\mathcal{H}^{N-1}$$

for all $\psi \in C_0(\Omega; \mathbb{R}^N)$. Since $\nu_{\varphi_k, i} = 0$ for all $k \in \mathbb{N}$, one infers

$$\int_{S_\varphi} \psi \cdot \nu_{\varphi, i} (\varphi^+ - \varphi^-) d\mathcal{H}^{N-1} = 0 \quad \text{for all } \psi \in C_0(\Omega; \mathbb{R}^N).$$

By the uniqueness statement in Riesz' theorem 3.10 this implies $\nu_{\varphi, i} (\varphi^+ - \varphi^-) \mathcal{H}^{N-1} \llcorner S_\varphi = 0$ in the sense of Radon-measures, hence $\nu_{\varphi, i} (\varphi^+ - \varphi^-) = 0$ on S_φ up to a \mathcal{H}^{N-1} -negligible set. But since $\varphi^+ - \varphi^- \neq 0$ \mathcal{H}^{N-1} -a.e. on S_φ one must have $\nu_{\varphi, i} = 0$ \mathcal{H}^{N-1} -a.e. on S_φ . \square

3.3.3 Imposing additional regularity within SBV^p

Despite being suitable for many applications, having good compactness properties and providing sequential lower semicontinuity for various types of integral functionals, the elements of $SBV^p(\Omega; \mathbb{R}^N)$ themselves are sometimes very delicate to handle. This is especially the case when dealing with their approximate discontinuity set, which might be any arbitrary countably \mathcal{H}^{N-1} -rectifiable set (see [Ambrosio et al., 2000, Theorem 4.6]), hence even be *dense* in Ω . In some situations it is because of this inevitable to restrict oneself to the study of $SBV^p(\Omega; \mathbb{R}^N)$ -functions with more regular discontinuity sets.

Definition 3.32. The vector space $\mathcal{V}^p(\Omega; \mathbb{R}^N)$ is defined to be the set of functions $\varphi \in L^p(\Omega; \mathbb{R}^N)$, for each of which there exists a polyhedral set P such that $\varphi \in W^{1,p}(\Omega \setminus P; \mathbb{R}^N)$.

Even more regularity is demanded for the next subspace of $SBV^p(\Omega; \mathbb{R}^N)$, which was introduced in Cortesani [1997].

Definition 3.33. The space $\mathcal{W}(\Omega; \mathbb{R}^N)$ is defined to be the set of all functions $w \in SBV(\Omega; \mathbb{R}^N)$ which enjoy the following properties:

- (i) S_w is essentially closed, i.e. $\mathcal{H}^{N-1}(\overline{S_w} \setminus S_w) = 0$,
- (ii) $\overline{S_w}$ is the intersection of Ω with a polyhedral set,
- (iii) $w \in W^{k,\infty}(\Omega \setminus \overline{S_w}; \mathbb{R}^N)$ for every $k \in \mathbb{N}$.

It was then proved in 1999 by Guido Cortesani and Rodica Toader that $\mathcal{W}(\Omega; \mathbb{R}^N)$ exhibits indeed excellent density properties in $SBV^p(\Omega; \mathbb{R}^N)$.

Theorem 3.34 (Density in SBV^p , cf. [Cortesani and Toader, 1999, Theorem 3.1, Remark 3.2]). *Assume that Ω is Lipschitzian and let $\varphi \in SBV^\alpha(\Omega; \mathbb{R}^N) \cap L^\infty(\Omega; \mathbb{R}^N)$, $1 < \alpha < \infty$. Then there exists a sequence $(w_k)_k$ in $\mathcal{W}(\Omega; \mathbb{R}^N)$ such that*

$$\begin{aligned} w_k &\rightarrow \varphi && \text{in } L^1(\Omega; \mathbb{R}^N), \\ \nabla w_k &\rightarrow \nabla \varphi && \text{in } L^\alpha(\Omega; \mathbb{M}^N) \end{aligned} ,$$

$$\text{and } \|\varphi\|_{L^\infty(\Omega; \mathbb{R}^N)} \geq \limsup_{k \rightarrow \infty} \|w_k\|_{L^\infty(\Omega; \mathbb{R}^N)}.$$

Moreover, for every upper semicontinuous and bounded function $\phi : \Omega \times \mathbb{R}^N \times \mathbb{R}^N \times S^{N-1} \rightarrow [0, \infty)$ which is even in its last argument there holds

$$\int_{S_\varphi} \phi(x, \varphi^+, \varphi^-, \nu_\varphi) d\mathcal{H}^{N-1} \geq \limsup_{k \rightarrow \infty} \int_{S_{w_k}} \phi(x, w_k^+, w_k^-, \nu_{w_k}) d\mathcal{H}^{N-1}.$$

Interpreted differently, the theorem states that the closure of the piecewise smooth functions, i.e. the closure of $\mathcal{W}(\Omega; \mathbb{R}^N)$ in an application-suited convergence-notion, like the one given in the theorem, is $SBV^p(\Omega; \mathbb{R}^N)$.

Remark 3.9. By definition, obviously $\mathcal{W}(\Omega; \mathbb{R}^N) \subseteq \mathcal{V}^p(\Omega; \mathbb{R}^N)$. Hence $\mathcal{V}^p(\Omega; \mathbb{R}^N)$ inherits all the density properties of $\mathcal{W}(\Omega; \mathbb{R}^N)$ within $SBV^p(\Omega; \mathbb{R}^N)$.

Remark 3.10. Let \mathbf{Box} be a compact superset of Ω . A to the knowledge of the author still open and challenging problem is to determine, whether $\mathcal{W}(\Omega; \mathbb{R}^N) \cap \text{Kin}(\Omega; \mathbf{Box})$ is dense in $SBV^p(\Omega; \mathbb{R}^N) \cap \text{Kin}(\Omega; \mathbf{Box})$ in a sense similar to the one of Theorem 3.34.

For the rest of the section, the author is concerned with the study of $SBV^p(\Omega; \mathbb{R}^N)$ -deformations having their crack set contained in a “piecewise C^1 ”-hypersurface. Before sharpening this notion, the author recalls a geometrical property of domains in \mathbb{R}^N .

Definition 3.35 (Cone condition). An open subset U of \mathbb{R}^N is said to satisfy the *cone condition*, if there is a finite cone

$$C = \left\{ x : x \in \mathbb{R}^N, x = 0 \text{ or } 0 < |x| \leq r, \angle(x, v) \leq \frac{\kappa}{2} \right\}$$

for some $r > 0$, $0 < \kappa \leq \pi$ and $v \in S^{N-1}$, such that each $x \in U$ is the vertex of a finite cone C_x contained in U and congruent to C .

Definition 3.36 (Piecewise C^1). Let S be a closed subset of \mathbb{R}^N . Then S is said to be a *piecewise C^1 -hypersurface of simply piecewise C^1* , if there are finitely many bounded Lipschitzian domains $U_1, \dots, U_k \subseteq \mathbb{R}^{N-1}$, $g_i \in C^1(\overline{U_i})$, $Q_i \in \text{SO}(N)$ and $b_i \in \mathbb{R}^N$ such that upon setting

$$S_i := \left\{ Q_i \begin{bmatrix} \hat{\xi} \\ g_i(\hat{\xi}) \end{bmatrix} + b_i : \hat{\xi} \in \overline{U_i} \right\}$$

there hold

$$(i) \quad S = \bigcup_{i=1}^k S_i,$$

$$(ii) \quad \text{rel int } S_i \cap \text{rel int } S_j = \emptyset \text{ for } i \neq j,$$

$$(iii) \quad \mathbb{R}^N \setminus S \text{ satisfies the cone condition.}$$

Remark 3.11. According to this definition, every polyhedral set is also piecewise C^1 . Moreover, for every piecewise C^1 -subset S of \mathbb{R}^N a unit normal ν_S exists \mathcal{H}^{N-1} -a.e. (and is determined up to its sign).

Let $S \subseteq \mathbb{R}^N$ be piecewise C^1 and S_i, U_i, g_i, Q_i and b_i like in Definition 3.36, $i = 1, \dots, k$. Then

$$\mathcal{H}^{N-1}(S_i \cap S_j) = 0 \quad \text{for } i \neq j. \quad (3.11)$$

In order to see this, first note that as a consequence of the disjoint relative interiors of S_i and S_j one has

$$S_i \cap S_j \subseteq (Q_i \text{ Graph}(g_i, \partial U_i) + b_i) \cup (Q_j \text{ Graph}(g_j, \partial U_j) + b_j), \quad (3.12)$$

where $\text{Graph}(g_\ell, A) := \{[\hat{\xi}, g_\ell(\hat{\xi})]^T : \hat{\xi} \in A\}$ for some $A \subseteq \overline{U_\ell}$ and $1 \leq \ell \leq k$. Recall that U_ℓ is Lipschitzian and bounded, hence its boundary is the union of finitely many rotated Lipschitz-graphs $(Q_{\ell,m} \text{Graph}(f_{\ell,m}, \text{dom } f_{\ell,m}))_m$ where $\text{dom } f_{\ell,m} \subseteq \mathbb{R}^{N-2}$ is bounded and $Q_{\ell,m} \in \text{SO}(N-1)$. Thus one obtains

$$\text{Graph}(g_\ell, \partial U_\ell) = \bigcup_m \tilde{Q}_{\ell,m} \text{Graph}((f_{\ell,m}(\cdot), g_\ell(Q_{\ell,m}[\cdot, f_{\ell,m}(\cdot)]^T)), \text{dom } f_{\ell,m}),$$

where

$$\tilde{Q}_{\ell,m} = \left[\begin{array}{c|c} Q_{\ell,m} & \\ \hline & 1 \end{array} \right] \in \text{SO}(N).$$

Now from [Evans and Gariepy, 1992, Section 2.4, Theorem 2] one infers that the Hausdorff-dimension of $\text{Graph}(g_\ell, \partial U_\ell)$ is $N-2$, thus by [Evans and Gariepy, 1992, Section 2.1, Lemma 2] this results in

$$0 = \mathcal{H}^{N-1}(\text{Graph}(g_\ell, \partial U_\ell)) = \mathcal{H}^{N-1}(Q_\ell \text{Graph}(g_\ell, \partial U_\ell) + b_\ell),$$

with the help of which (3.11) becomes an immediate consequence of (3.12).

Another consequence of (3.11) is

$$\mathcal{H}^{N-1} \left(S \setminus \bigcup_{i=1}^k \text{rel int } S_i \right) = 0. \quad (3.13)$$

□

In order to prevent technicalities as cusps occur when Ω is being “sliced” by some piecewise C^1 -set S , one defines the concept of being piecewise C^1 in Ω .

Definition 3.37 (Piecewise C^1 in Ω). Let $\mathbb{R}^N \setminus \partial\Omega$ satisfy the cone condition. A subset S of $\overline{\Omega}$ is called *piecewise C^1 in Ω* , if S is piecewise C^1 and $\mathbb{R}^N \setminus (\partial\Omega \cup S)$ satisfies the cone condition.

Coming now to the study of $SBV^p(\Omega; \mathbb{R}^N)$ -functions with piecewise C^1 -regular discontinuity set, one will at first realize that in this case the notions of approximate normal and approximate traces become remarkably simple.

Proposition 3.38. *Let $\varphi \in SBV^p(\Omega; \mathbb{R}^N)$ be such that S_φ is contained in a piecewise C^1 -subset S of \mathbb{R}^N . Then for \mathcal{H}^{N-1} -a.e. $x_0 \in S_\varphi$ there holds*

$$(\varphi^+(x_0), \varphi^-(x_0), \nu_\varphi(x_0)) = (\mathbb{T}^+ \varphi(x_0), \mathbb{T}^- \varphi(x_0), \nu_S(x_0)),$$

in which

$$\begin{aligned} \nu_S(x_0) & \text{ is a unit normal on } S \text{ in } x_0, \\ \mathbb{T}^\pm \varphi(x_0) &= \lim_{n \rightarrow \infty} \varphi(x_n), \quad (x_n)_n \text{ in } \Omega \setminus S \text{ on the side of } S \\ & \text{ which } \pm \nu_S(x_0) \text{ points to, and} \\ & x_n \rightarrow x_0. \end{aligned}$$

Proof. For $x \in \mathbb{R}^N$ write $x = [\hat{x}, x_N]^T$. Regarding the fact that S is piecewise C^1 , let S_i, U_i, g_i, Q_i and b_i be like in Definition 3.36, $i = 1, \dots, k$.

Let $x_0 \in S_\varphi$. By (3.13), one can without loss of generality assume that $x_0 \in \text{rel int } S_1$. Furthermore assume (upon possibly choosing another coordinate frame) $S_1 = \{[\hat{\xi}, g_1(\hat{\xi})]^T : \hat{\xi} \in \overline{U_1}\}$ and $Dg_1(\hat{x}_0) = 0$. Thus $\nu_S(x_0) = e_N$. Finally, let $R > 0$ be sufficiently small such that S_1 separates $B_R(x_0)$ in two disjoint parts and moreover $B_R(x_0) \cap S_i = \emptyset$ for all $i \geq 2$. Thus the index in S_1, U_1 and g_1 will henceforth be dropped.

Consider

$$U^+ := B_R(x_0) \cap \{x : x_N > g(\hat{x})\} \quad \text{and} \quad U^- := B_R(x_0) \cap \{x : x_N < g(\hat{x})\}$$

and observe the Lipschitz-regularity of their boundaries (for sufficiently small R). Since $\varphi \in W^{1,p}(U^\pm; \mathbb{R}^N)$ and $p > N$, the Sobolev-embedding theorem gives $\varphi \in C(\overline{U^\pm}; \mathbb{R}^N)$, from which one infers the uniform boundedness of φ on $B_R(x_0)$ and in particular that $\mathbb{T}^\pm \varphi(x_0)$ is well-defined.

Recall the notation of Proposition 3.19

$$B_r^\pm(x_0, v) := \{x : x \in B_r(x_0), \pm(x - x_0) \cdot v > 0\}, \quad v \in S^{N-1}.$$

According to the uniqueness of the triplet $(\varphi^+(x_0), \varphi^-(x_0), \nu_\varphi(x_0))$ stated in Proposition 3.19, it suffices to show

$$\lim_{r \rightarrow 0} \frac{1}{\text{vol } B_r^\pm(x_0, \nu_S(x_0))} \int_{B_r^\pm(x_0, \nu_S(x_0))} |\varphi(x) - \mathbb{T}^\pm \varphi(x_0)| \, dx = 0.$$

Let $\eta > 0$ be arbitrary. Choose an $r_0 > 0$ sufficiently small such that

$$|\varphi(x) - \mathbb{T}^+ \varphi(x_0)| < \eta \quad \text{for all } x \in \mathbb{R}^N \text{ with } x_N > g(\hat{x}), |x - x_0| < r_0$$

and furthermore

$$\frac{|g(\hat{x}) - g(\hat{x}_0)|}{|\hat{x} - \hat{x}_0|} < \eta \quad \text{for all } x \in \mathbb{R}^N \text{ with } |\hat{x} - \hat{x}_0| < r_0.$$

One now writes for any $r \leq r_0$

$$\begin{aligned}
& \int_{B_r^+(x_0, \nu_S(x_0))} |\varphi(x) - T^+ \varphi(x_0)| \, dx \\
&= \int_{B_r^+(x_0, \nu_S(x_0)) \cap U^+} |\varphi(x) - T^+ \varphi(x_0)| \, dx \\
&\quad + \int_{B_r^+(x_0, \nu_S(x_0)) \cap U^-} |\varphi(x) - T^+ \varphi(x_0)| \, dx \\
&\leq \eta \operatorname{vol} (B_r^+(x_0, \nu_S(x_0)) \cap U^+) \\
&\quad + 2 \|\varphi\|_{L^\infty(B_R(x_0); \mathbb{R}^N)} \operatorname{vol} (B_r^+(x_0, \nu_S(x_0)) \cap U^-) \tag{3.14}
\end{aligned}$$

and estimates the second term in (3.14) like

$$\begin{aligned}
B_r^+(x_0, \nu_S(x_0)) \cap U^- &= \{x : |x - x_0| < r, \\
&\quad 0 < x_N - g(\hat{x}_0) < g(\hat{x}) - g(\hat{x}_0)\} \\
&\subseteq \{x : |\hat{x} - \hat{x}_0| < r, \\
&\quad 0 < x_N - g(\hat{x}_0) < \eta |\hat{x} - \hat{x}_0|\} =: V_\eta. \tag{3.15}
\end{aligned}$$

A simple computation gives

$$\operatorname{vol} V_\eta = \eta r^N \frac{N-1}{N} \omega_{N-1}, \tag{3.16}$$

where ω_K denotes the volume of the K -dimensional unit ball. Thus for all $r \leq r_0$ one obtains from (3.14) by means of (3.15) and (3.16)

$$\begin{aligned}
& \frac{1}{\operatorname{vol} B_r^+(x_0, \nu_S(x_0))} \int_{B_r^+(x_0, \nu_S(x_0))} |\varphi(x) - T^+ \varphi(x_0)| \, dx \\
&\leq \eta + 2 \|\varphi\|_{L^\infty(B_R(x_0); \mathbb{R}^N)} \frac{\eta r^N \frac{N-1}{N} \omega_{N-1}}{\frac{1}{2} r^N \omega_N} = C \eta
\end{aligned}$$

where C depends on N and φ only. One proceeds analogously to show

$$\frac{1}{\operatorname{vol} B_r^-(x_0, \nu_S(x_0))} \int_{B_r^-(x_0, \nu_S(x_0))} |\varphi(x) - T^- \varphi(x_0)| \, dx \leq C \eta$$

for all $r \leq r_0$ and the same constant C . The proof is now finished. \square

Remark 3.12. Let $\varphi \in SBV^p(\Omega; \mathbb{R}^N)$ be such that there exists a piecewise C^1 -subset S of \mathbb{R}^N containing S_φ .

First, by the same arguments like the ones used in Proposition 3.38, one realizes that the triplet $(T^+ \varphi, T^- \varphi, \nu_S)$ is \mathcal{H}^{N-1} -a.e. defined on $S \cap \Omega$. Moreover,

on S_φ it can be identified with $(\varphi^+, \varphi^-, \nu_\varphi)$. Hence, whenever it appears to be convenient, the author will for such φ extend the triplet $(\varphi^+, \varphi^-, \nu_\varphi)$ to *the whole* of $S \cap \Omega$ by identification with $(T^+\varphi, T^-\varphi, \nu_S)$.

Moreover, the insight that $T^+\varphi - T^-\varphi = 0$ in \mathcal{H}^{N-1} -a.e. point of $(S \cap \Omega) \setminus S_\varphi$ leads to the representation

$$D^j\varphi = (\varphi^+ - \varphi^-) \otimes \nu_\varphi \mathcal{H}^{N-1} \llcorner S_\varphi = (T^+\varphi - T^-\varphi) \otimes \nu_S \mathcal{H}^{N-1} \llcorner (S \cap \Omega),$$

or by the above identification simply written as

$$D^j\varphi = (\varphi^+ - \varphi^-) \otimes \nu_S \mathcal{H}^{N-1} \llcorner (S \cap \Omega).$$

Exploiting the result of Proposition 3.38, one can further simplify the chain rule formula of Proposition 3.23, namely in the case of $SBV^p(\Omega; \mathbb{R}^N)$ -deformations with piecewise C^1 -regular discontinuity set that undergo Lipschitz-coordinate transformations, which map piecewise C^1 -sets onto piecewise C^1 -sets.

Corollary 3.39. *Let G be a domain, $S, H \subseteq \mathbb{R}^N$ be piecewise C^1 , and $\Phi : G \rightarrow \Omega$ in the sense of Proposition 3.23, such that $\Phi^{-1}(S \cap \Omega) = H \cap G$ and such that Φ maps the side of H which $\pm\nu_H$ points to onto the side of S which $\pm\nu_S$ points to. Let $\varphi \in SBV^p(\Omega; \mathbb{R}^N)$ with $S_\varphi \subseteq S$. Then $\psi := \varphi \circ \Phi \in SBV^p(G; \mathbb{R}^N)$, $S_\psi \subseteq H$ and there holds*

$$D\psi = (\nabla\varphi \circ \Phi) \cdot D\Phi \lambda^N \llcorner G + (\varphi^+ - \varphi^-) \circ \Phi \otimes \nu_H \mathcal{H}^{N-1} \llcorner (H \cap G).$$

Proof. From Proposition 3.23 one obtains $\varphi \in SBV(G; \mathbb{R}^N)$ as well as $\nabla\psi = (\nabla\varphi \circ \Phi) \cdot D\Phi$ and $S_\psi \subseteq \Phi^{-1}(S \cap \Omega) = H \cap G$. Then clearly $\nabla\psi \in L^p(G; \mathbb{M}^N)$ and $\mathcal{H}^{N-1}(S_\psi) < \infty$, resulting in $\psi \in SBV^p(G; \mathbb{R}^N)$. In addition one realizes that \mathcal{H}^{N-1} -a.e. on $H \cap G$ there holds

$$(T^+\psi, T^-\psi, \nu_H) = ((T^+\varphi) \circ \Phi, (T^-\varphi) \circ \Phi, \nu_H).$$

Utilizing Remark 3.12 one arrives at

$$\begin{aligned} D^j\psi &= (\psi^+ - \psi^-) \otimes \nu_H \mathcal{H}^{N-1} \llcorner (H \cap G) \\ &= (T^+\psi - T^-\psi) \otimes \nu_H \mathcal{H}^{N-1} \llcorner (H \cap G) \\ &= ((T^+\varphi) \circ \Phi - (T^-\varphi) \circ \Phi) \otimes \nu_H \mathcal{H}^{N-1} \llcorner (H \cap G) \\ &= (\varphi^+ - \varphi^-) \circ \Phi \otimes \nu_H \mathcal{H}^{N-1} \llcorner (H \cap G). \end{aligned}$$

The corollary is now proved. \square

To conclude the section, the proposition below finally states how $W^{1,p}$ -functions on a “piecewise C^1 -sliced Ω ” are to be interpreted within $SBV^p(\Omega; \mathbb{R}^N)$.

Proposition 3.40. *Let $\varphi \in W^{1,p}(\Omega \setminus S; \mathbb{R}^N) \cap L^\infty(\Omega; \mathbb{R}^N)$ where S is a piecewise C^1 -subset of \mathbb{R}^N . Then $\varphi \in SBV^p(\Omega; \mathbb{R}^N)$ and*

$$D\varphi = \tilde{D}\varphi \lambda^N \llcorner \Omega + (T^+\varphi - T^-\varphi) \otimes \nu_S \mathcal{H}^{N-1} \llcorner (S \cap \Omega), \quad (3.17)$$

in which $\tilde{D}\varphi$ is the weak derivative of φ in $W^{1,p}(\Omega \setminus S; \mathbb{R}^N)$. In addition there holds $S_\varphi \subseteq S$.

On the other hand, if $\varphi \in SBV^p(\Omega; \mathbb{R}^N)$ and S is a piecewise C^1 -subset of \mathbb{R}^N containing S_φ , then $\varphi \in W^{1,p}(\Omega \setminus S; \mathbb{R}^N)$ and (3.17) holds.

Proof. First consider $\varphi \in W^{1,p}(\Omega \setminus S; \mathbb{R}^N) \cap L^\infty(\Omega; \mathbb{R}^N)$ with S piecewise C^1 and notice $\mathcal{H}^{N-1}(S) < \infty$. Referring the reader to [Ambrosio et al., 2000, Proposition 4.4], one obtains $\varphi \in SBV(\Omega; \mathbb{R}^N)$ and $\mathcal{H}^{N-1}(S_\varphi \setminus S) = 0$. However, from the Sobolev-embedding theorem and $p > N$ one deduces that $S_\varphi \cap (\Omega \setminus S) = \emptyset$, thus the stronger condition $S_\varphi \subseteq S$. In particular, $\mathcal{H}^{N-1}(S_\varphi) < \infty$. Regarding the fact that elements of $W^{1,p}(\Omega \setminus S; \mathbb{R}^N)$ are differentiable in the classical sense a.e. in $\Omega \setminus S$ and the differential equals the weak derivative, see [Evans and Garipey, 1992, Section 6.2, Theorem 1], one realizes by Theorem 3.18 that $\nabla\varphi = \text{ap } D\varphi = \tilde{D}\varphi$. Hence $\nabla\varphi \in L^p(\Omega; \mathbb{M}^N)$ and eventually $\varphi \in SBV^p(\Omega; \mathbb{R}^N)$. Finally with the help of Remark 3.12

$$\begin{aligned} D\varphi &= \nabla\varphi \lambda^N \llcorner \Omega + (\varphi^+ - \varphi^-) \otimes \nu_\varphi \mathcal{H}^{N-1} \llcorner S_\varphi \\ &= \tilde{D}\varphi \lambda^N \llcorner \Omega + (T^+\varphi - T^-\varphi) \otimes \nu_S \mathcal{H}^{N-1} \llcorner (S \cap \Omega). \end{aligned}$$

Letting $\varphi \in SBV^p(\Omega; \mathbb{R}^N)$ and S piecewise C^1 containing S_φ , one obviously has $\varphi \in W^{1,p}(\Omega \setminus S; \mathbb{R}^N)$ and by the very same arguments used in the first part of the proof one infers the validity of (3.17) for $D\varphi$. \square

CHAPTER 4

ANALYSIS OF THE MATHEMATICAL MODEL

In this chapter the author presents the main results of the thesis, namely the analysis of the mathematical model for the many-body structures Ω_ε like introduced in Chapter 2. For this reason he returns to the conventions and notation used therein. Recall those were

the many-body structures Ω_ε with macroscopic shape Ω , microstructure \mathcal{D}_i , $i = 2$ or 3 (see Definition of Geometry 2.1, 2.2 and 2.3) and inner contact boundary $\Gamma_{C,\varepsilon}$,

the elastic energy density W and the surface energy density θ , cf. Subsection 2.2.1, as well as the potential \hat{F} of the applied body load, see Subsection 2.2.4,

the set of all kinematically admissible deformations $\text{Kin}(\Omega; \mathbf{Box})$ of the many-body structures Ω_ε , found in Subsection 2.2.3,

the total energy \mathcal{E}_ε stored in the many-body structures Ω_ε when deformed by kinematically admissible deformations of adequate regularity, see Subsection 2.2.5.

4.1 EXISTENCE OF MINIMIZERS

Before performing an asymptotic analysis of the many-body structures Ω_ε as their constituents become smaller and smaller, the author will first return to the claimed existence of deformations of minimal energy like stated in Theorem 2.16.

Proof of Theorem 2.16. The proof is an easy consequence of Corollary 3.30. Indeed, first note that in fact $W^{1,p}(\Omega_\varepsilon; \mathbb{R}^N) \cap \text{Kin}(\Omega; \mathbf{Box})$ is a subset of

$SBV^p(\Omega; \mathbb{R}^N) \cap \text{Kin}(\Omega; \mathbf{Box})$ by Proposition 3.40 and then extend the total energy \mathcal{E}_ε like,

$$\begin{aligned} \bar{\mathcal{E}}_\varepsilon &: SBV^p(\Omega; \mathbb{R}^N) \cap \text{Kin}(\Omega; \mathbf{Box}) \rightarrow (-\infty, \infty], \\ \bar{\mathcal{E}}_\varepsilon(\varphi) &:= \begin{cases} \mathcal{E}_\varepsilon(\varphi) & \text{if } \varphi \in W^{1,p}(\Omega_\varepsilon; \mathbb{R}^N), \\ \infty & \text{else} \end{cases} \end{aligned}$$

By assumption, \mathbf{Box} has nonempty interior, hence there is an affine, kinematically admissible deformation shrinking Ω_ε into an open ball contained in \mathbf{Box} , and the energy stored in this configuration is clearly finite. In particular, the infimum of $\bar{\mathcal{E}}_\varepsilon$ is finite. Consequently, any minimizer of $\bar{\mathcal{E}}_\varepsilon$ is also a minimizer of \mathcal{E}_ε .

It is easily checked that $W^{1,p}(\Omega_\varepsilon; \mathbb{R}^N)$ is w.r.t. weak convergence in $SBV^p(\Omega; \mathbb{R}^N)$ a closed subset of $SBV^p(\Omega; \mathbb{R}^N)$. An application of Corollary 3.30 (in which one sets $\phi(v) := |v|$) now provides the existence of a minimizer of $\bar{\mathcal{E}}_\varepsilon$ and finishes the proof. \square

4.2 ASYMPTOTIC ANALYSIS: HOMOGENIZATION BY Γ -CONVERGENCE

Like indicated in Section 3.1, the thesis is from now on concerned with the study of the asymptotic behaviour of the total energy \mathcal{E}_ε as the characteristic size ε of the constituents of the many-body structures Ω_ε tends to zero. In view of its motivation in Section 3.2 as “energetic” convergence, Γ -convergence seems to be the natural criterion for the asymptotic analysis of the $(\mathcal{E}_\varepsilon)_\varepsilon$. However, with the domains of the \mathcal{E}_ε – namely $W^{1,p}(\Omega_\varepsilon; \mathbb{R}^N) \cap \text{Kin}(\Omega; \mathbf{Box})$ – varying with ε , one first seeks an appropriate extension of the total energies $(\mathcal{E}_\varepsilon)_\varepsilon$ to some metric space, on which possible Γ -convergence can be studied. A good candidate is $SBV^p(\Omega; \mathbb{R}^N) \cap \text{Kin}(\Omega; \mathbf{Box})$ equipped with the strong $L^1(\Omega; \mathbb{R}^N)$ -topology, since by Proposition 3.22 and the identity $\Omega_\varepsilon = \Omega \setminus \Gamma_{C,\varepsilon}$ one has $W^{1,p}(\Omega_\varepsilon; \mathbb{R}^N) \subseteq SBV^p(\Omega; \mathbb{R}^N)$ for all $\varepsilon > 0$. Of course, since a many-body structure Ω_ε can only undergo deformations with jumps across the inner contact boundary $\Gamma_{C,\varepsilon}$, one would have to extend \mathcal{E}_ε to $SBV^p(\Omega; \mathbb{R}^N) \cap \text{Kin}(\Omega; \mathbf{Box})$ by ∞ . Moreover, under hypothesis $(\hat{F}1)$ the load term $\varphi \mapsto \int_\Omega \hat{F}(x, \varphi(x)) dx$ can according to Corollary 3.5 be omitted in the a Γ -convergence study of the extended $(\mathcal{E}_\varepsilon)_\varepsilon$ when carried out w.r.t. the strong $L^1(\Omega; \mathbb{R}^N)$ -topology. To conclude, it suffices to study the asymptotic behaviour of

$$\mathcal{F}_\varepsilon : SBV^p(\Omega; \mathbb{R}^N) \cap \text{Kin}(\Omega; \mathbf{Box}) \rightarrow [0, \infty],$$

defined as

$$\mathcal{F}_\varepsilon(\varphi) := \begin{cases} \int_{\Omega} W(\nabla\varphi) dx + \int_{\Gamma_{C,\varepsilon}} \theta(|\varphi^+ - \varphi^-|) d\mathcal{H}^{N-1} \\ \infty \end{cases} \quad \begin{array}{l} \text{if } \varphi \in W^{1,p}(\Omega_\varepsilon; \mathbb{R}^N), \\ \text{else} \end{array} \quad (4.1)$$

in the sense of Γ -convergence w.r.t. the strong $L^1(\Omega; \mathbb{R}^N)$ -topology as ε vanishes.

Remark 4.1. Note, that for a surface energy density θ under hypothesis $(\theta 1), \dots, (\theta 3)$, \mathcal{F}_ε can equivalently be written as

$$\mathcal{F}_\varepsilon(\varphi) = \begin{cases} \int_{\Omega} W(\nabla\varphi) dx + \int_{S_\varphi} \theta(|\varphi^+ - \varphi^-|) d\mathcal{H}^{N-1} \\ \infty \end{cases} \quad \begin{array}{l} \text{if } \varphi \in W^{1,p}(\Omega_\varepsilon; \mathbb{R}^N), \\ \text{else} \end{array}$$

where the surface integral is taken solely over S_φ instead of $\Gamma_{C,\varepsilon}$. To see this, let $\varphi \in W^{1,p}(\Omega_\varepsilon; \mathbb{R}^N) \cap \text{Kin}(\Omega; \mathbf{Box})$. Indeed, by Proposition 3.40 one has $S_\varphi \subseteq \Gamma_{C,\varepsilon}$ and thanks to $(\theta 3)$ the identity $\theta(|\varphi^+ - \varphi^-|) = 0$ in \mathcal{H}^{N-1} -a.e. point of $\Gamma_{C,\varepsilon} \setminus S_\varphi$. For the latter recall the notational convention of Remark 3.12 and that $\mathbb{T}^+ \varphi - \mathbb{T}^- \varphi = 0$ holds \mathcal{H}^{N-1} -a.e. on $\Gamma_{C,\varepsilon} \setminus S_\varphi$.

More specifically, the author will study the Γ -convergence behaviour of the sequence $(\mathcal{F}_{\varepsilon_k})_k$, where $(\varepsilon_k)_k$ **is from now on chosen to be a refining, vanishing sequence of positive real numbers**. By refining the author means, that $\frac{\varepsilon_k}{\varepsilon_{k+1}} \in \mathbb{N}$ for all $k \in \mathbb{N}$. As the reader will discover in the sequel, the refinement property of the sequence $(\varepsilon_k)_k$ significantly reduces the still considerable technical efforts in the construction of recovery sequences. This is actually the only reason for the restriction to refining sequences in the considerations to come.

To give a short exposition of what follows, the author will for the two-dimensional many-body structure and both the three-dimensional many-body structures Ω_{ε_k} from Section 2.1 identify a homogenized limit energy $\mathcal{F}_{\text{Hom}} : SBV^p(\Omega; \mathbb{R}^N) \cap \text{Kin}(\Omega; \mathbf{Box}) \rightarrow [0, \infty]$. More precisely, he will show that the functionals $\mathcal{F}_{\varepsilon_k}$ associated with each many-body structure Ω_{ε_k} Γ -converge w.r.t. the strong $L^1(\Omega, \mathbb{R}^N)$ -topology to \mathcal{F}_{Hom} in at least all deformations $\varphi \in SBV^p(\Omega; \mathbb{R}^N) \cap \text{Kin}(\Omega; \mathbf{Box})$ having their discontinuity set contained in an in Ω piecewise C^1 -hypersurface. Hence, there holds Γ -convergence of the sequence $(\mathcal{F}_{\varepsilon_k})_k$ in all physically relevant deformations.

Remark 4.2. The reader should be aware of the fact, that the results obtained by the author are mathematically “incomplete”, in that he did not prove Γ -convergence of the $(\mathcal{F}_{\varepsilon_k})_k$ on the whole of $SBV^p(\Omega; \mathbb{R}^N) \cap \text{Kin}(\Omega; \mathbf{Box})$, but on a subclass only. This is mainly due to the lack of appropriate density results in $SBV^p(\Omega; \mathbb{R}^N) \cap \text{Kin}(\Omega; \mathbf{Box})$, see Remark 3.10.

However, in each case the homogenized limit energy \mathcal{F}_{Hom} does not need to be relaxed, since it turns out to be sequentially lower semicontinuous w.r.t. the strong $L^1(\Omega; \mathbb{R}^N)$ -topology and possesses a minimizer.

4.3 HOMOGENIZATION OF THE 2D-STRUCTURE

Before going through the steps found below, the reader might find it helpful to recall the geometry of the two-dimensional many-body structure and the corresponding notation, which were given in Definition of Geometry 2.1 and depicted in Figures 2.1 and 2.2. Moreover, the author calls up the definition of the energy functionals $\mathcal{F}_{\varepsilon_k}$, see (4.1), and directs the reader's attention to Remark 4.1.

4.3.1 Heuristic derivation and Γ -convergence statement

Let $(\varepsilon_k)_k$ be a refining, vanishing sequence of positive real numbers, $\mathcal{F}_{\varepsilon_k}$ be associated with the two-dimensional many-body structure Ω_{ε_k} and given as in (4.1). When looking for the Γ -limit of the sequence $(\mathcal{F}_{\varepsilon_k})_k$, according to the motivation of Γ -convergence as energetic convergence (again see Section 3.2) one asks, which is the smallest energy the deformations in $SBV^p(\Omega; \mathbb{R}^2) \cap \text{Kin}(\Omega; \mathbf{Box})$ can be approximated with along the sequence $(\mathcal{F}_{\varepsilon_k})_k$. The author will answer this question by means of the *heuristics* below. Therefore, let first $\varphi \in SBV^p(\Omega; \mathbb{R}^2) \cap \text{Kin}(\Omega; \mathbf{Box})$ be a deformation with sufficiently regular discontinuity set S_φ and then perform a local consideration in the following sense.

Homogenized elastic energy. Consider a $x_0 \in \Omega \setminus \overline{S_\varphi}$. Thus in an environment of x_0 the deformation φ is $W^{1,p}$ -smooth. Being in this environment around x_0 also a deformation, which all of the many-body structures Ω_{ε_k} can actually undergo, φ causes in the volume element dx_0 in all many-body structures Ω_{ε_k} the same elastic energy $W(\nabla\varphi(x_0)) dx_0$. Consequently, the least elastic energy one can approximate the deformation φ with when passing through the domains of $(\mathcal{F}_{\varepsilon_k})_k$ is again

$$\int_{\Omega} W(\nabla\varphi) dx. \quad (4.2)$$

Homogenized surface energy. Now consider a $x_0 \in S_\varphi$ and a plane arc element of S_φ around x_0 of length $d\mathcal{H}^1(x_0)$ oriented by $\nu_\varphi(x_0)$, see Figure 4.1. One now arrives at the question, how much energy is needed to approximate the jump of φ in x_0 with deformations of the many-body structures Ω_{ε_k} that can be undergone with finite energy, i.e. with deformations in $W^{1,p}(\Omega_{\varepsilon_k}; \mathbb{R}^2) \cap \text{Kin}(\Omega; \mathbf{Box})$? Hence, in view of the fact that $W^{1,p}(\Omega_{\varepsilon_k}; \mathbb{R}^2)$ -deformations can only jump across the inner contact boundary Γ_{C,ε_k} , how to approximate the sufficiently smooth discontinuity

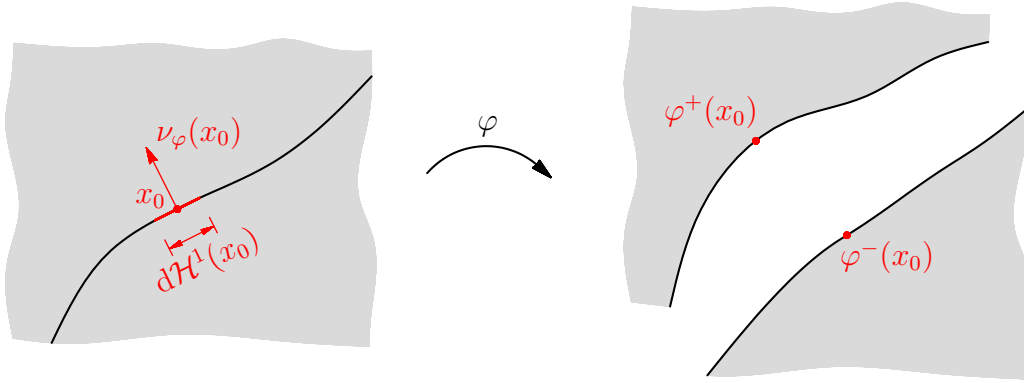

Figure 4.1: Geometry of the discontinuity set S_φ , locally around x_0

set S_φ along $\Gamma_{C,\varepsilon_k} \subseteq \varepsilon_k \partial \mathcal{D}_2$? Or even simpler, how to approximate a line segment along the refiningly scaled mesh $\partial \mathcal{D}_2$? To this end, let $K_1, K_2 \in \mathbb{Z}^2$ and $L := \text{conv}\{K_1, K_2\}$ be the line segment between K_1 and K_2 , and let $\nu \in S^1$ be a unit normal on L . Referring to Figure 4.2, a simple computation shows that the

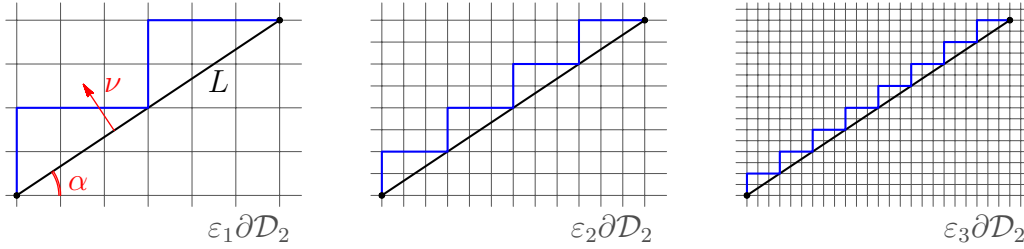

Figure 4.2: Approximation of a line segment along the scaled mesh $\partial \mathcal{D}_2$

polygon imitating L on a refiningly scaled down mesh \mathcal{D}_2 has a length of

$$(|\sin \alpha| + |\cos \alpha|) \cdot \text{“length of } L\text{”} = (|\nu_1| + |\nu_2|) \cdot \text{“length of } L\text{”}. \quad (4.3)$$

In the many-body structure Ω_{ε_k} the opening of a crack on Γ_{C,ε_k} of width t and length $d\ell$ costs according to the mathematical model of Subsection 2.2.1 an amount of $\theta(t) d\ell$ energy. Hence, the approximation of the jump $(\varphi^+(x_0), \varphi^-(x_0), \nu_\varphi(x_0))$ across the plane arc element of S_φ around x_0 of length $d\mathcal{H}^1(x_0)$ and orientation $\nu_\varphi(x_0)$ comes by (4.3) at an energetic cost of

$$\theta(|\varphi^+(x_0) - \varphi^-(x_0)|) \cdot (|\nu_{\varphi,1}(x_0)| + |\nu_{\varphi,2}(x_0)|) d\mathcal{H}^1(x_0).$$

Thus, the smallest surface energy at which one can approximate the discontinuity set S_φ with deformations taken from the domains of $(\mathcal{F}_{\varepsilon_k})_k$ is

$$\int_{S_\varphi} (|\nu_{\varphi,1}| + |\nu_{\varphi,2}|) \cdot \theta(|\varphi^+ - \varphi^-|) d\mathcal{H}^1. \quad (4.4)$$

Homogenized total energy. Further assuming heuristically, that the additive decomposition of the total energy in an elastic energy and a surface energy transfers into a possible Γ -limit of the $(\mathcal{F}_{\varepsilon_k})_k$, the above heuristics (4.2) and (4.4) motivate the author to introduce the *homogenized total energy*

$$\mathcal{F}_{\text{Hom}} : SBV^p(\Omega; \mathbb{R}^2) \cap \text{Kin}(\Omega; \mathbf{Box}) \rightarrow [0, \infty],$$

defined as

$$\mathcal{F}_{\text{Hom}}(\varphi) := \int_{\Omega} W(\nabla\varphi) \, dx + \int_{S_{\varphi}} \phi(\nu_{\varphi}) \theta(|\varphi^+ - \varphi^-|) \, d\mathcal{H}^1. \quad (4.5)$$

Herein, the author calls

$$\phi : S^1 \rightarrow [0, \infty), \quad \phi(v) := |v_1| + |v_2|$$

the *anisotropy factor generated by the microstructure* \mathcal{D}_2 .

The above heuristic considerations are rigorously justified by the next theorem, stating the main homogenization result for the two-dimensional many-body structure considered in the thesis.

Theorem 4.1 (Homogenization of the 2D-structure I). *Let $(\varepsilon_k)_k$ be a refining, vanishing sequence of positive real numbers and $\Omega, \Omega_{\varepsilon_k}, \Gamma_{C, \varepsilon_k}$ like in Definition of Geometry 2.1. Suppose the elastic energy density W to satisfy (W1), \dots , (W4) and the surface energy density to obey $(\theta 1), \dots, (\theta 3)$. Then for the sequence $(\mathcal{F}_{\varepsilon_k})_k$ as in (4.1) and the homogenized total energy \mathcal{F}_{Hom} given in (4.5) there holds*

- (i) *on $SBV^p(\Omega; \mathbb{R}^2) \cap \text{Kin}(\Omega; \mathbf{Box})$ the Γ -lim inf-inequality w.r.t. the strong $L^1(\Omega; \mathbb{R}^2)$ -topology. That is, for all φ and $(\varphi_k)_k$ in $SBV^p(\Omega; \mathbb{R}^2) \cap \text{Kin}(\Omega; \mathbf{Box})$ such that $\varphi_k \rightarrow \varphi$ in $L^1(\Omega; \mathbb{R}^2)$ one has*

$$\mathcal{F}_{\text{Hom}}(\varphi) \leq \liminf_{k \rightarrow \infty} \mathcal{F}_{\varepsilon_k}(\varphi_k).$$

- (ii) *on $\mathcal{V}^p(\Omega; \mathbb{R}^2) \cap \text{Kin}(\Omega; \mathbf{Box})$ the Γ -lim sup-inequality w.r.t. the strong $L^1(\Omega; \mathbb{R}^2)$ -topology, i.e. for all $\varphi \in \mathcal{V}^p(\Omega; \mathbb{R}^2) \cap \text{Kin}(\Omega; \mathbf{Box})$ there is a sequence $(\varphi_k)_k$ in $SBV^p(\Omega; \mathbb{R}^2) \cap \text{Kin}(\Omega; \mathbf{Box})$ that converges strongly to φ in $L^1(\Omega; \mathbb{R}^2)$ and satisfies*

$$\mathcal{F}_{\text{Hom}}(\varphi) \geq \limsup_{k \rightarrow \infty} \mathcal{F}_{\varepsilon_k}(\varphi_k).$$

Remark 4.3. In particular there holds $\mathcal{F}_{\text{Hom}}(\varphi) = (\Gamma\text{-lim}_k \mathcal{F}_{\varepsilon_k})(\varphi)$ for every $\varphi \in \mathcal{V}^p(\Omega; \mathbb{R}^2) \cap \text{Kin}(\Omega; \mathbf{Box})$ (w.r.t. the strong $L^1(\Omega; \mathbb{R}^2)$ -topology).

The two statements of Theorem 4.1 will be proved separately. Whereas the short proof of the Γ -lim inf-inequality is the subject of the next Subsection 4.3.2, the Γ -lim sup-inequality will be proved in Subsection 4.3.3. The latter contains the author's main ideas, how to approach the general topic of homogenization in geometrically nonlinear elasticity under global noninterpenetration constraints. A slight improvement of Theorem 4.1 is given in Subsection 4.3.4, where it will be shown that Γ -convergence holds indeed true for all $SBV^p(\Omega; \mathbb{R}^2) \cap \text{Kin}(\Omega; \mathbf{Box})$ -deformations having their discontinuity set contained in an in Ω piecewise C^1 -hypersurface. The analysis of the two-dimensional many-body structure will be concluded by a mathematical and mechanical discussion of the result obtained, see Subsection 4.3.5.

4.3.2 Proof of the Γ -lim inf-inequality

Let φ and $(\varphi_k)_k$ be in $SBV^p(\Omega; \mathbb{R}^2) \cap \text{Kin}(\Omega; \mathbf{Box})$ such that $\varphi_k \rightarrow \varphi$ in $L^1(\Omega; \mathbb{R}^2)$. Assume without loss of generality $\liminf_k \mathcal{F}_{\varepsilon_k}(\varphi_k) < \infty$. Thus, there is a subsequence $(k(m))_m$ such that $\liminf_k \mathcal{F}_{\varepsilon_k}(\varphi_k) = \lim_m \mathcal{F}_{\varepsilon_{k(m)}}(\varphi_{k(m)})$ and moreover $\varphi_{k(m)} \in W^{1,p}(\Omega_{\varepsilon_{k(m)}}; \mathbb{R}^2)$ (by the structure (4.1) of $\mathcal{F}_{\varepsilon_k}$).

Falling back to Corollary 3.30 – in which one sets $M := SBV^p(\Omega; \mathbb{R}^2)$, $\hat{F} := 0$ and extends $\phi : \mathbb{R}^2 \rightarrow [0, \infty)$, $\phi(v) := |v_1| + |v_2|$ – one realizes that \mathcal{F}_{Hom} is indeed sequentially lower semicontinuous w.r.t. the strong $L^1(\Omega; \mathbb{R}^2)$ -topology, thus

$$\begin{aligned} \mathcal{F}_{\text{Hom}}(\varphi) &\leq \liminf_{m \rightarrow \infty} \mathcal{F}_{\text{Hom}}(\varphi_{k(m)}) = \liminf_{m \rightarrow \infty} \left(\int_{\Omega} W(\nabla \varphi_{k(m)}) \, dx \right. \\ &\quad \left. + \int_{S_{\varphi_{k(m)}}} \phi(\nu_{\varphi_{k(m)}}) \theta(|\varphi_{k(m)}^+ - \varphi_{k(m)}^-|) \, d\mathcal{H}^1 \right). \end{aligned} \quad (4.6)$$

But from $\varphi_{k(m)} \in W^{1,p}(\Omega_{\varepsilon_{k(m)}}; \mathbb{R}^2)$ and $\Omega_{\varepsilon_{k(m)}} = \Omega \setminus \Gamma_{C, \varepsilon_{k(m)}}$ one deduces with the help of Proposition 3.38, that $\nu_{\varphi_{k(m)}}$ coincides \mathcal{H}^1 -a.e. on $S_{\varphi_{k(m)}}$ with a unit normal on $\Gamma_{C, \varepsilon_{k(m)}}$. That is,

$$\nu_{\varphi_{k(m)}} \in \{\pm e_1, \pm e_2\} \quad \text{and consequently} \quad \phi(\nu_{\varphi_{k(m)}}) = 1$$

in \mathcal{H}^1 -a.e. point of $S_{\varphi_{k(m)}}$. Inserting this into (4.6) and recalling Remark 4.1, one arrives at

$$\begin{aligned} \mathcal{F}_{\text{Hom}}(\varphi) &\leq \liminf_{m \rightarrow \infty} \left(\int_{\Omega} W(\nabla \varphi_{k(m)}) \, dx + \int_{S_{\varphi_{k(m)}}} \theta(|\varphi_{k(m)}^+ - \varphi_{k(m)}^-|) \, d\mathcal{H}^1 \right) \\ &= \liminf_{m \rightarrow \infty} \mathcal{F}_{\varepsilon_{k(m)}}(\varphi_{k(m)}) = \liminf_{k \rightarrow \infty} \mathcal{F}_{\varepsilon_k}(\varphi_k), \end{aligned}$$

what completes the proof. \square

4.3.3 Proof of the Γ -lim sup-inequality

Let there be $\varphi \in \mathcal{V}^p(\Omega; \mathbb{R}^2) \cap \text{Kin}(\Omega; \mathbf{Box})$ and P denote a polyhedral set that contains S_φ . Without loss of generality assume $\mathcal{F}_{\text{Hom}}(\varphi) < \infty$.

One now seeks a sequence $(\varphi_k)_k$ in $SBV^p(\Omega; \mathbb{R}^2) \cap \text{Kin}(\Omega; \mathbf{Box})$ that strongly converges to φ in $L^1(\Omega; \mathbb{R}^2)$ and satisfies $\mathcal{F}_{\text{Hom}}(\varphi) \geq \limsup_k \mathcal{F}_{\varepsilon_k}(\varphi_k)$. Regarding the fact that $\mathcal{F}_{\varepsilon_k} \equiv \infty$ on $(SBV^p(\Omega; \mathbb{R}^2) \cap \text{Kin}(\Omega; \mathbf{Box})) \setminus W^{1,p}(\Omega_{\varepsilon_k}; \mathbb{R}^2)$, for all but finitely many k one must have $\varphi_k \in W^{1,p}(\Omega_{\varepsilon_k}; \mathbb{R}^2) \cap \text{Kin}(\Omega; \mathbf{Box})$.

Before turning to the construction of the recovery sequence $(\varphi_k)_k$, the author first introduces an appropriate new method to construct approximations for deformations in $SBV^p(\Omega; \mathbb{R}^2) \cap \text{Kin}(\Omega; \mathbf{Box})$, which in particular has to conserve the kinematic restrictions formulated in $\text{Kin}(\Omega; \mathbf{Box})$.

Manipulations conserving kinematics: pre-deformations

Let for the time being Ω denote some open and bounded subset of \mathbb{R}^N , $N \in \mathbb{N}$, \mathbf{Box} a compact subset of \mathbb{R}^N with nonempty interior and let φ be some element of $SBV^p(\Omega; \mathbb{R}^N) \cap \text{Kin}(\Omega; \mathbf{Box})$. Think of being confronted with the task to provide a sequence $(\varphi_k)_k$ in $SBV^p(\Omega; \mathbb{R}^N) \cap \text{Kin}(\Omega; \mathbf{Box})$, in which each φ_k shall possess certain properties Prop_k and approximate φ in a sense Approx . For instance, one may think of Prop_k to contain restrictions on the geometry of the discontinuity set S_{φ_k} or of Approx to denote the $L^1(\Omega; \mathbb{R}^N)$ -distance to φ .

The *main difficulty* in constructing such φ_k is to maintain the conditions of kinematic admissibility $\varphi_k \in \text{Kin}(\Omega; \mathbf{Box})$, i.e. to ensure the a.e.-positivity of its Jacobian determinant, the validity of the Ciarlet-Nečas condition and that it takes values in \mathbf{Box} only. To conclude, any method to obtain φ_k by a posteriori “by hand” manipulations of the values of φ seems at best to be extremely delicate. In particular, up to now extensively used tools to approximate a deformation φ by means of manipulations like reflection arguments or defining a deformation to be zero on a set of positive volume (see e.g. the widely known works Cortesani and Toader [1999] and Francfort and Larsen [2003]), are incompatible with the positivity of the Jacobian determinant and a.e.-injectivity. Recall, that the latter follows from the Ciarlet-Nečas condition in conjunction with positivity of the Jacobian determinant, see Proposition 2.14. Hence, these tools are *not allowed within the context of geometrically nonlinear elasticity*. This in other words results in the need for a new technique allowing for manipulations of φ , which are compatible with the present kinematic constraints.

The author’s novel approach to this problem, which he used first in February 2008, is to employ what he calls *pre-deformations*.

Definition 4.2 (Pre-deformations). Let U and G be open and bounded subsets of \mathbb{R}^N . A bijective mapping $\Phi : G \rightarrow U$ is called a *pre-deformation*, if

- (i) $\Phi \in W^{1,\infty}(G; \mathbb{R}^N)$,
- (ii) $\Phi^{-1} \in W^{1,\infty}(U; \mathbb{R}^N)$ and Φ^{-1} is Lipschitz,
- (iii) $\det D\Phi > 0$ a.e. in G .

Remark 4.4. Note, that pre-deformations are supposed to have exactly the same regularity like the coordinate transformations from Proposition 3.23, for which the validity of the chain rule in SBV has been established.

The terminology of Definition 4.2 stems from the following idea. Instead of hoping to obtain approximations φ_k of φ by a posteriori “by hand” manipulations of the deformation φ itself, one deforms in advance its underlying domain Ω by some bijective $\Phi_k : \Omega \rightarrow \Omega$ of the regularity stated in Definition 4.2 – justifying its denomination as a pre-deformation. Herein, every Φ_k shall be such that

- each $\varphi_k := \varphi \circ \Phi_k$ has the properties Prop_k ,
- φ_k approximates φ in the sense Approx .

Such pre-deformation-based manipulations $\varphi_k := \varphi \circ \Phi_k$ of deformations φ derive their compatibility with the kinematic restrictions $\text{Kin}(\Omega; \mathbf{Box})$ from the following observations. First, by Proposition 3.23 there holds the chain-rule formula $\nabla \varphi_k = (\nabla \varphi \circ \Phi_k) D\Phi_k$, thus the a.e.-positivity of $\det \nabla \varphi$ and $\det D\Phi_k$ is likely to imply the positivity of $\det \nabla \varphi_k$. Secondly, as φ is a.e.-injective by Proposition 2.14, its composition with the injective pre-deformation Φ_k will be a.e.-injective, too. And last, since φ takes a.a. values in \mathbf{Box} only, also φ_k will have a.a. of its values contained in \mathbf{Box} . Indeed, Proposition 4.3 reveals the validity of these claims, and Proposition 4.4 provides an analogous result for a special class of pre-deformations.

Example 4.1. An example demonstrating the usefulness of this method is illustrated in Figure 4.3, where a pre-deformation Φ_k , pulling a piecewise C^1 -hyper-surface S back onto a polyhedral set P_k is shown. In case $\varphi \in SBV^p(\Omega; \mathbb{R}^2) \cap \text{Kin}(\Omega; \mathbf{Box})$ and $S_\varphi \subseteq S$, by Proposition 4.3 below one infers first that $\varphi_k := \varphi \circ \Phi_k$ lies in $SBV^p(\Omega; \mathbb{R}^2) \cap \text{Kin}(\Omega; \mathbf{Box})$. Whereas Proposition 3.23 reveals, that $S_{\varphi_k} = \Phi_k^{-1}(S_\varphi)$, and thus that φ_k has its discontinuity set contained in the polyhedral set $P_k = \Phi_k^{-1}(S)$. If moreover the volume of the set, on which the pre-deformation Φ_k differs from the identity mapping, vanishes as k tends to ∞ , then $\varphi_k \rightarrow \varphi$ in $L^1(\Omega; \mathbb{R}^2)$.

Remark 4.5. By the time unknown to the author, a similar idea was independently used in [Dal Maso and Lazzaroni, 2008, Lemma 4.1] in the treatment of quasi-static crack growth in finite continuum mechanics. Also their motivation was to maintain the kinematic restrictions of positivity of the Jacobian determinant and

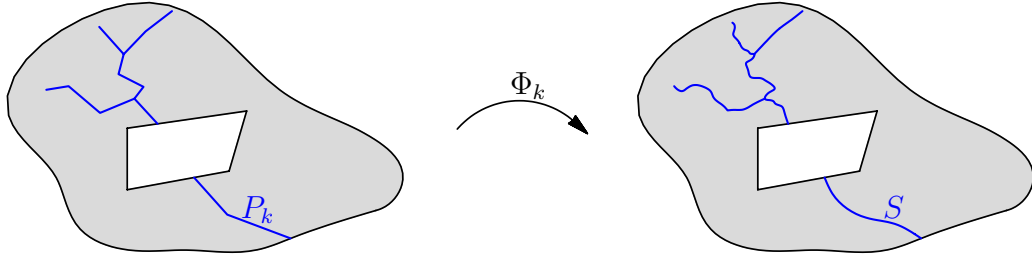

Figure 4.3: A pre-deformation Φ_k , pulling a piecewise C^1 -hypersurface back onto a polyhedral set

a.e.-injectivity while manipulating a given deformation by means of local “stretching” of the underlying domain with affine transformations. According Giuliano Lazzaroni, with whom the author met in February 2009 at the XIX Convegno Nazionale di Calcolo delle Variazioni held in Levico Terme (Trento), the work Dal Maso and Lazzaroni [2008] was available to the public first in December 2008 – in electronic form on the preprint-server of the Scuola Normale Superiore di Pisa – and came to the knowledge of the author in January 2009. However, the author’s above described technique of pre-deformations and its application to the homogenization problem treated in the present section was first presented to his supervisor Martin Brokate in April 2008 at the Technische Universität München. In addition, a preprint with the title “Homogenization of laminated many-body structures under global injectivity constraints”, exposing the technique of pre-deformations and the homogenization results presented in this thesis, was first spread to the author’s supervisors Martin Brokate and Augusto Visintin (Università degli Studi di Trento) on 11 and 12 November 2008, respectively.

Proposition 4.3. *Let Ω_1, Ω_2 be open subsets of Ω and $\Phi : \Omega_1 \rightarrow \Omega_2$ be a pre-deformation. Then for every $\varphi \in SBV^p(\Omega; \mathbb{R}^N) \cap \text{Kin}(\Omega; \mathbf{Box})$ there holds*

$$\varphi \circ \Phi \in SBV^p(\Omega_1; \mathbb{R}^N) \cap \text{Kin}(\Omega_1; \mathbf{Box}).$$

Proof. Set $\psi := \varphi \circ \Phi$. First note, that $\varphi|_{\Omega_2} \in SBV^p(\Omega_2; \mathbb{R}^N) \cap \text{Kin}(\Omega_2; \mathbf{Box})$. Indeed, obviously $\varphi|_{\Omega_2} \in SBV^p(\Omega_2; \mathbb{R}^N)$ and since φ satisfies the Ciarlet-Nečas condition, by Remark 2.10 one infers that the Ciarlet-Nečas condition is valid on Ω_2 , too.

From Proposition 3.23 one obtains $\psi \in SBV(\Omega_1; \mathbb{R}^N)$, as well as the validity of $\nabla \psi = (\nabla \varphi \circ \Phi) D\Phi$ and $S_\psi = \Phi^{-1}(S_\varphi \cap \Omega_2)$. As a consequence of this and the fact that $D\Phi \in L^\infty(\Omega_1; \mathbb{R}^N)$ and Φ^{-1} is Lipschitz, a simple application of the change of variables formula for Lipschitz-transformations [Evans and Gariepy, 1992, Section 3.4, Theorem 2] reveals $\nabla \psi \in L^p(\Omega_1; \mathbb{M}^N)$. Moreover, by [Evans and Gariepy, 1992, Section 2.4, Theorem 1], there holds $\mathcal{H}^{N-1}(S_\psi) \leq$

$\text{Lip}(\Phi^{-1})^{N-1} \mathcal{H}^{N-1}(S_\varphi \cap \Omega_2) < \infty$. Putting everything together results in $\psi \in SBV^p(\Omega_1; \mathbb{R}^N)$.

In order to show the missing inclusion $\psi \in \text{Kin}(\Omega_1; \mathbf{Box})$, choose a representative $\bar{\varphi}$ of φ and obtain the representative $\bar{\psi} := \bar{\varphi} \circ \Phi$ of ψ . Let $N \subseteq \Omega$ be of negligible volume and such that $\bar{\varphi}$ is injective on $\Omega \setminus N$. Recall, that $\varphi \in \text{Kin}(\Omega; \mathbf{Box})$ is a.e.-injective according to Proposition 2.14. By the injectivity of Φ , clearly $\bar{\psi}$ is injective too on $\Phi^{-1}(\Omega_2 \setminus N) = \Omega_1 \setminus \Phi^{-1}(N)$. Again referring to [Evans and Garipey, 1992, Section 2.4, Theorem 1] and recalling $\lambda^N = \mathcal{H}^N$ on \mathbb{R}^N , one deduces $\lambda^N(\Phi^{-1}(N)) \leq \text{Lip}(\Phi^{-1})^N \lambda^N(N) = 0$. Hence, $\bar{\psi}$ is a.e.-injective. Similarly one shows that $\psi(x) \in \mathbf{Box}$ and $\det(\nabla \psi \circ \Phi) > 0$ a.e. in Ω_1 . The latter together with $\det D\Phi > 0$ and $\nabla \psi = (\nabla \varphi \circ \Phi) D\Phi$ a.e. in Ω_1 implies the positivity of the Jacobian determinant of ψ . Eventually combining the before established a.e.-injectivity of ψ with the a.e.-positivity of its Jacobian determinant, Proposition 2.14 gives the validity of the Ciarlet-Nečas condition for ψ . To conclude, $\psi \in \text{Kin}(\Omega_1; \mathbf{Box})$ and the proof is finished. \square

In some situations it may happen that a deformation $\varphi \in SBV^p(\Omega; \mathbb{R}^N) \cap \text{Kin}(\Omega; \mathbf{Box})$ may possess certain undesirable properties, which are concentrated on a subset E of Ω of Hausdorff-dimension $N-1$. An adequate method to approximate φ with deformations φ_k that are still kinematically admissible in the sense of $\text{Kin}(\Omega; \mathbf{Box})$ but do not possess the undesirable properties of φ concentrated on E , is as follows (see Figure 4.4). To this end, assume that E can be covered with

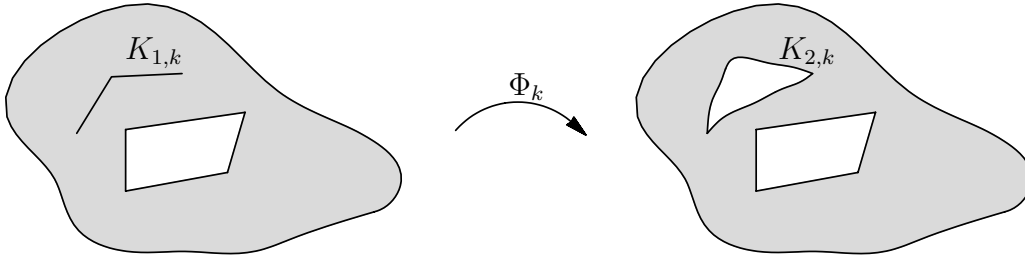

Figure 4.4: A pre-deformation Φ_k that “slices” Ω

some compact subset $K_{2,k}$ of Ω . Suppose one is able to construct the inverse Φ_k^{-1} of a pre-deformation such that it “closes” the hole in Ω – resulting from taking out $K_{2,k}$ – by stretching $\Omega \setminus K_{2,k}$ to some $\Omega \setminus K_{1,k}$, see Figure 4.4. Here, $K_{1,k}$ shall be a compact set with $\mathcal{H}^{N-1}(K_{1,k}) < \infty$. Hence, the function $\varphi_k := \varphi \circ \Phi_k$, which can be shown to be an element of $SBV^p(\Omega \setminus K_{1,k}; \mathbb{R}^N) \cap \text{Kin}(\Omega \setminus K_{1,k}; \mathbf{Box})$, does not exhibit the undesirable properties of φ , since $E \cap \Phi_k(\Omega \setminus K_{1,k}) = \emptyset$. Upon realizing, that $SBV^p(\Omega \setminus K_{1,k}; \mathbb{R}^N) \cap \text{Kin}(\Omega \setminus K_{1,k}; \mathbf{Box})$ can be identified with $SBV^p(\Omega; \mathbb{R}^N) \cap \text{Kin}(\Omega; \mathbf{Box})$, the $SBV^p(\Omega; \mathbb{R}^N)$ -deformation φ_k is kinematically admissible in the sense of $\text{Kin}(\Omega; \mathbf{Box})$. In case that the volume of the

set, on which the pre-deformation Φ_k differs from the identity mapping vanishes as k tends to ∞ , φ_k strongly converges to φ in $L^1(\Omega; \mathbb{R}^N)$. The mathematical justification of the just said is provided in the proposition below.

Remark 4.6. As it is clear from Figure 4.4, a pre-deformation as described just before is *not* Lipschitz, because of its behaviour across the “seam” K_1 . This is why the regularity “Lipschitz with Lipschitz-inverse”, as it is usually assumed in Ambrosio et al. [2000] for coordinate transformations, is too strong for the use as pre-deformations.

Proposition 4.4. *Let K be a compact subset of \mathbb{R}^N such that $\mathcal{H}^{N-1}(K) < \infty$, and let Ω' be an open subset of Ω . Moreover, $\Phi : \Omega \setminus K \rightarrow \Omega'$ shall be a pre-deformation. Then for $\varphi \in SBV^p(\Omega; \mathbb{R}^N) \cap \text{Kin}(\Omega; \mathbf{Box})$, the function $\psi := \varphi \circ \Phi \in L^1(\Omega \setminus K; \mathbb{R}^N)$ can be identified with some $\bar{\psi} \in L^1(\Omega; \mathbb{R}^N)$ and there holds*

$$\bar{\psi} \in SBV^p(\Omega; \mathbb{R}^N) \cap \text{Kin}(\Omega; \mathbf{Box}) \quad \text{and} \quad S_{\bar{\psi}} \subseteq \Phi^{-1}(S_\varphi \cap \Omega') \cup K.$$

Proof. From Proposition 4.3 one first infers the validity of $\psi \in SBV^p(\Omega \setminus K) \cap \text{Kin}(\Omega \setminus K; \mathbf{Box})$, from Proposition 3.23 moreover the inclusion $S_\psi = \Phi^{-1}(S_\varphi \cap \Omega')$. However, Proposition 3.22 implies that $\bar{\psi} \in SBV^p(\Omega; \mathbb{R}^N)$ with $S_{\bar{\psi}} \subseteq S_\psi \cup K$, hence $S_{\bar{\psi}} \subseteq \Phi^{-1}(S_\varphi \cap \Omega') \cup K$.

Finally, the fact that $\text{vol } K = 0$ allows an identification of $\text{Kin}(\Omega \setminus K; \mathbf{Box})$ and $\text{Kin}(\Omega; \mathbf{Box})$, and one obtains $\bar{\psi} \in \text{Kin}(\Omega; \mathbf{Box})$. \square

Proving the Γ -lim sup-inequality

Return to the previously chosen $\varphi \in SBV^p(\Omega; \mathbb{R}^2) \cap \text{Kin}(\Omega; \mathbf{Box})$, for which one seeks a recovery sequence $(\varphi_k)_k$, such that each $\varphi_k \in W^{1,p}(\Omega_{\varepsilon_k}; \mathbb{R}^2) \cap \text{Kin}(\Omega; \mathbf{Box})$ and $\mathcal{F}_{\text{Hom}}(\varphi) \geq \limsup_k \mathcal{F}_{\varepsilon_k}(\varphi_k)$.

The author will exploit the properties of pre-deformations stated in Proposition 4.3 and 4.4 to first state in Lemma 4.5, that φ can be approximated with deformations $\varphi_m \in \mathcal{V}^p(\Omega; \mathbb{R}^2) \cap \text{Kin}(\Omega; \mathbf{Box})$, satisfying $\varphi_m \rightarrow \varphi$ in $L^1(\Omega; \mathbb{R}^2)$ and $\mathcal{F}_{\text{Hom}}(\varphi) = \lim_m \mathcal{F}_{\text{Hom}}(\varphi_m)$. In particular, the $(\varphi_m)_m$ are such that for each of them one can easily construct a recovery sequence.

Lemma 4.5. *There are a subsequence $(\varepsilon_{k(m)})_m$, and for every $m \in \mathbb{N}$ a deformation $\varphi_m \in \mathcal{V}^p(\Omega; \mathbb{R}^2) \cap \text{Kin}(\Omega; \mathbf{Box})$ and a polyhedral set P_m containing S_{φ_m} , such that*

$$(i) \quad \text{Knot}(P_m) \cap \Omega \subseteq \varepsilon_{k(m)} \mathbb{Z}^2,$$

$$(ii) \quad \text{for all } L \in \text{Face}(P_m) \text{ with } \text{dist}(L, \partial\Omega) = 0 \text{ there holds } L \subseteq \varepsilon_{k(m)} \partial\mathcal{D}_2,$$

(iii) for every $K \in \text{Knot}(P_m) \cap \Omega$ there are at most four elements $L_1, \dots, L_4 \in \text{Face}(P_m)$ containing K and there holds either

for every $I \in \{[0, \frac{\pi}{2}), [\frac{\pi}{2}, \pi), [\pi, \frac{3\pi}{2}), [\frac{3\pi}{2}, 2\pi)\}$ there is at maximum one i such that angle between half-line $K + \mathbb{R}_{>0}e_1$ and L_i is in I

or

for every $I \in \{(0, \frac{\pi}{2}], (\frac{\pi}{2}, \pi], (\pi, \frac{3\pi}{2}], (\frac{3\pi}{2}, 2\pi]\}$ there is at maximum one i such that angle between half-line $K + \mathbb{R}_{>0}e_1$ and L_i is in I .

Moreover, one has

$$\varphi_m \rightarrow \varphi \quad \text{in } L^1(\Omega; \mathbb{R}^2), \quad (4.7)$$

and

$$\lim_{m \rightarrow \infty} \int_{\Omega} W(\nabla \varphi_m) \, dx = \int_{\Omega} W(\nabla \varphi) \, dx, \quad (4.8)$$

$$\lim_{m \rightarrow \infty} \int_{S_{\varphi_m}} \phi(\nu_{\varphi_m}) \theta(|\varphi_m^+ - \varphi_m^-|) \, d\mathcal{H}^1 = \int_{S_{\varphi}} \phi(\nu_{\varphi}) \theta(|\varphi^+ - \varphi^-|) \, d\mathcal{H}^1. \quad (4.9)$$

While postponing the very technical proof of the lemma to the end of this section and appealing to the reader's patience, the proof of the Γ -lim sup-inequality would be in reach in view of Lemma 4.5 and Proposition 3.7, if one could only find a recovery sequence for each of the φ_m from Lemma 4.5. This indeed is true as reveals the next result.

Lemma 4.6. *Let $\psi \in \mathcal{V}^p(\Omega; \mathbb{R}^2) \cap \text{Kin}(\Omega; \mathbf{Box})$ with $\mathcal{F}_{\text{Hom}}(\psi) < \infty$. Let P_{ψ} be a polyhedral set containing S_{ψ} and such that it satisfies the assumptions (i), ..., (iii) from Lemma 4.5 (with some ε_m replacing $\varepsilon_{k(m)}$ in (i) and (ii)). Then there exists a sequence $(\psi_k)_k$ with $\psi_k \in W^{1,p}(\Omega_{\varepsilon_k}; \mathbb{R}^2) \cap \text{Kin}(\Omega; \mathbf{Box})$ for every $k \in \mathbb{N}$, which satisfies*

$$\psi_k \rightarrow \psi \quad \text{in } L^1(\Omega; \mathbb{R}^2), \quad (4.10)$$

and

$$\lim_{k \rightarrow \infty} \int_{\Omega} W(\nabla \psi_k) \, dx = \int_{\Omega} W(\nabla \psi) \, dx, \quad (4.11)$$

$$\lim_{k \rightarrow \infty} \int_{S_{\psi_k}} \theta(|\psi_k^+ - \psi_k^-|) \, d\mathcal{H}^1 = \int_{S_{\psi}} \phi(\nu_{\psi}) \theta(|\psi^+ - \psi^-|) \, d\mathcal{H}^1. \quad (4.12)$$

Proof. The outline of the proof is the following. First, for all but finitely many k one constructs some pre-deformation $\Phi_k : \Omega \rightarrow \Omega$, which

- only differs from the identity mapping in a certain ε_k -environment \mathcal{T}_k of the polyhedral set P_ψ ,
- is such that $\Phi_k^{-1}(P_\psi) \cap \Omega \subseteq \varepsilon_k \partial \mathcal{D}_2$,
- satisfies for some k -independent positive constants c_1, c_2, c_3 the estimate

$$\begin{aligned} c_1 &\leq \det D\Phi_k \leq c_2 \\ |D\Phi_k| &\leq c_3 \end{aligned} \quad (4.13)$$

uniformly on Ω .

Like in the motivation for the use of pre-deformations, one now obtains the desired sequence of deformations ψ_k by composition of ψ with the pre-deformations Φ_k , i.e. $\psi_k := \psi \circ \Phi_k$. After having inferred $\psi_k \in SBVP(\Omega; \mathbb{R}^2) \cap \text{Kin}(\Omega; \mathbf{Box})$ and furthermore $S_{\psi_k} \subseteq \varepsilon_k \partial \mathcal{D}_2$, one realizes $\psi_k \in W^{1,p}(\Omega_{\varepsilon_k}; \mathbb{R}^2) \cap \text{Kin}(\Omega; \mathbf{Box})$. The claimed convergences (4.10) and (4.11) then follow from $\text{vol } \mathcal{T}_k \rightarrow 0$ and the uniform estimates on $D\Phi_k$ in conjunction with assumption (W4), respectively. Whereas the proof of (4.12) requires some additional computation. To improve readability, each of the mentioned steps will be treated individually.

Step 1. One starts by noting, that assumption (i) states the inclusion $\text{Knot}(P_\psi) \cap \Omega \subseteq \varepsilon_m \mathbb{Z}^2$. Since the sequence $(\varepsilon_k)_k$ was assumed to be refining, i.e. $\frac{\varepsilon_k}{\varepsilon_{k+1}} \in \mathbb{N}$ for all $k \in \mathbb{N}$, it holds for all $k \geq m$ that $\varepsilon_k \mathbb{Z}^2 = \varepsilon_m \mathbb{Z}^2$, hence $\text{Knot}(P_\psi) \cap \Omega \subseteq \varepsilon_k \mathbb{Z}^2$ for all $k \geq m$. From now on, the index k is supposed to be larger or equal m . Now let $K_1, K_2 \in \text{Knot}(P_\psi) \cap \Omega$ such that $L := \text{conv} \{K_1, K_2\} \in \text{Face}(P_\psi)$ and $\text{dist}(L, \partial \Omega) > 0$, and denote by α_i the angle between the half-line $K_i + \mathbb{R}_{>0} e_1$ and L , $i \in \{1, 2\}$. Obviously there holds $\alpha_2 = (\pi + \alpha_1) \bmod 2\pi$. According to assumption (iii), one of the following 16 distinct geometrical situations occurs in K_1 and K_2 . Either

$$\begin{aligned} \alpha_1 &\in \left[\ell \frac{\pi}{2}, (\ell + 1) \frac{\pi}{2} \right) \quad \text{and} \\ &\left(\alpha_2 \in \left[\left(\ell \frac{\pi}{2} + \pi \right) \bmod 2\pi, \left((\ell + 1) \frac{\pi}{2} + \pi \right) \bmod 2\pi \right) \right. \\ &\left. \text{or } \alpha_2 \in \left(\left(\ell \frac{\pi}{2} + \pi \right) \bmod 2\pi, \left((\ell + 1) \frac{\pi}{2} + \pi \right) \bmod 2\pi \right] \right) \end{aligned}$$

or

$$\begin{aligned} \alpha_1 &\in \left(\ell \frac{\pi}{2}, (\ell + 1) \frac{\pi}{2} \right] \quad \text{and} \\ &\left(\alpha_2 \in \left[\left(\ell \frac{\pi}{2} + \pi \right) \bmod 2\pi, \left((\ell + 1) \frac{\pi}{2} + \pi \right) \bmod 2\pi \right) \right. \\ &\left. \text{or } \alpha_2 \in \left(\left(\ell \frac{\pi}{2} + \pi \right) \bmod 2\pi, \left((\ell + 1) \frac{\pi}{2} + \pi \right) \bmod 2\pi \right] \right), \end{aligned}$$

where ℓ can be 0, 1, 2 or 3. Since all these cases are treated completely analogously, the author exemplarily considers the following one. The angle α_1 is supposed to lie in $[0, \frac{\pi}{2})$ and to be positive – if $\alpha_1 = 0$, there holds $L \subseteq \varepsilon_k \partial \mathcal{D}_2$ and there is nothing to do. Moreover there shall be no other element in $\text{Face}(P_\psi)$ containing K_1 , which with $K_1 + \mathbb{R}_{>e_1}$ encloses an angle in $[0, \frac{\pi}{2})$. Whereas for α_2 , which as a consequence of the assumptions on α_1 is an element of $(\pi, \frac{3\pi}{2})$, one assumes, that there is no other element in $\text{Face}(P_\psi)$ containing K_2 and enclosing with $K_2 + \mathbb{R}_{>e_1}$ an angle in $[\pi, \frac{3\pi}{2})$. Furthermore, in order to keep the number of indices as small as possible, the author assumes for simplicity $K_1 = 0$ (which shall not restrict the upcoming arguments) and drops the index in K_2 (thus $L = \text{conv}\{0, K\}$) and in α_1 , since α_2 will not be used any more.

One now constructs an environment $\mathcal{T}_{k,L}$ consisting of two closed trapezoids over L like shown in Figure 4.5. Taking property (iii) of P_ψ into account as

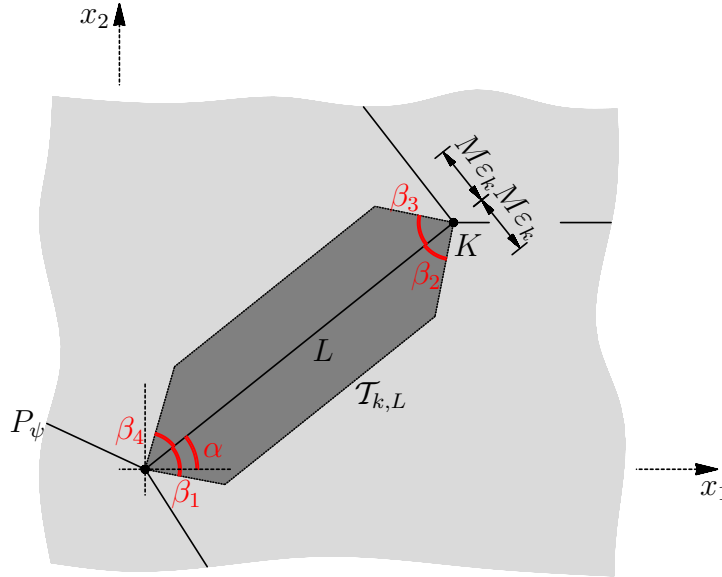

Figure 4.5: The trapezoidal environment $\mathcal{T}_{k,L}$

well as the geometry of P_ψ in 0 and K as described above, one can find angles $\beta_1, \dots, \beta_4 \in (0, \frac{\pi}{2})$ and a, for what follows sufficiently large, fixed number $M \in \mathbb{N}$ depending on β_1, \dots, β_4 and L only, such that

- the closed set $\mathcal{T}_{k,L}$ does not intersect any other element of $\text{Face}(P_\psi)$, except in 0 or K ,
- the line segments $\varepsilon_k \text{conv}\{0, K, {}_1e_1\} + 0$ and $-\varepsilon_k \text{conv}\{0, K, {}_1e_1\} + K$ are contained in the interior of $\mathcal{T}_{k,L}$.

Therein, $K_{,1}, K_{,2} \in \mathbb{Z}$ are chosen such that $\varepsilon_m \mathbb{Z}^2 \ni K = \varepsilon_m [K_{,1}, K_{,2}]^T$. The comma $K_{,i}$ in the index has simply been introduced to avoid notational confusion with the K_1, K_2 used before. Clearly, for ε_k sufficiently small, $\mathcal{T}_{k,L}$ becomes a subset of Ω .

Step 2. One again writes $K = \varepsilon_m [K_{,1}, K_{,2}]^T$, with $K_{,1}, K_{,2} \in \mathbb{Z}$. Observe, that by the refinement-property $\frac{\varepsilon_m}{\varepsilon_k} \in \mathbb{N}$. Consequently, there holds

$$K = \left. \begin{aligned} & \left(\varepsilon_k \begin{bmatrix} K_{,1} \\ 0 \end{bmatrix} + \varepsilon_k \begin{bmatrix} 0 \\ K_{,2} \end{bmatrix} \right) \\ & + \dots \\ & + \left(\varepsilon_k \begin{bmatrix} K_{,1} \\ 0 \end{bmatrix} + \varepsilon_k \begin{bmatrix} 0 \\ K_{,2} \end{bmatrix} \right) \\ & + \left(\varepsilon_k \begin{bmatrix} 0 \\ K_{,2} \end{bmatrix} + \varepsilon_k \begin{bmatrix} K_{,1} \\ 0 \end{bmatrix} \right). \end{aligned} \right\} \left(\frac{\varepsilon_m}{\varepsilon_k} - 1 \right) \text{ times}$$

Like seen in Figure 4.6, from this representation one can construct a rectangular polygon $P_{k,L}$ in an obvious way, which indeed is a subset of $\varepsilon_k \partial \mathcal{D}_2$. By the second

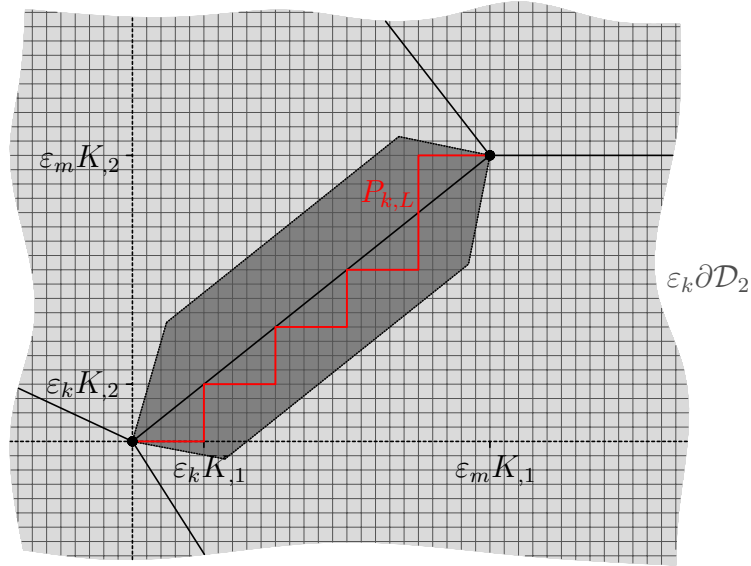

Figure 4.6: The Polygon $P_{k,L}$

property of $\mathcal{T}_{k,L}$ mentioned at the end of the first step, one has $P_{k,L} \subseteq \mathcal{T}_{k,L}$. One now defines a pre-deformation $\Phi_{k,L} : \mathcal{T}_{k,L} \rightarrow \mathcal{T}_{k,L}$, which maps $P_{k,L}$ onto L , equals the identity mapping on $\partial \mathcal{T}_{k,L}$ and admits k -independent bounds c_1, c_2, c_3 ,

such that $D\Phi_{k,L}$ satisfies the estimate (4.13) uniformly on $\mathcal{T}_{k,L}$. Indeed, $\Phi_{k,L}$ can be chosen piecewise affine as follows. By taking the perpendiculars on L in every kink of $P_{k,L}$, one divides $\mathcal{T}_{k,L}$ into $\kappa := 2\frac{\varepsilon_m}{\varepsilon_k}$ disjoint stripes $\mathcal{S}_1, \dots, \mathcal{S}_\kappa$, each being itself divided by $P_{k,L}$ into an upper part \mathcal{S}_i^+ and a lower part \mathcal{S}_i^- , see Figure 4.7. Upon declaring $\Phi_{k,L}$ to be in every \mathcal{S}_i^\pm the continuous piecewise affine function,

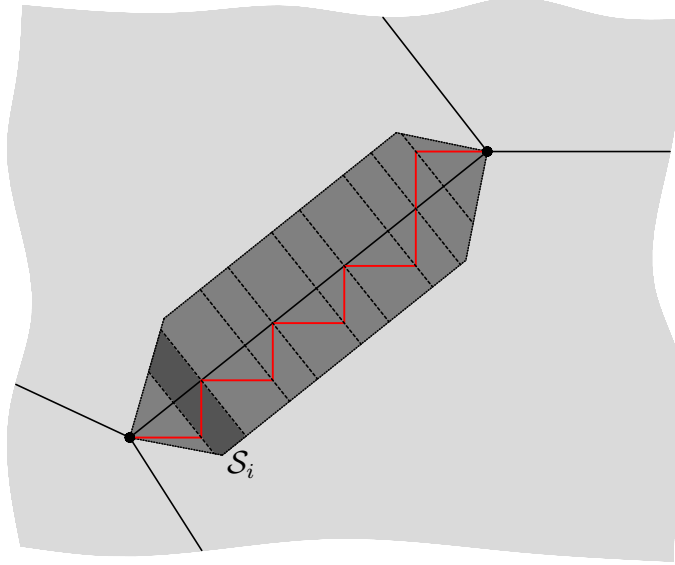

Figure 4.7: The subdomains \mathcal{S}_i of $\mathcal{T}_{k,L}$

mapping

the triangle described by *the intersection point of the outer boundary $\partial\mathcal{S}_i^\pm \cap \partial\mathcal{T}_{k,L}$ with the perpendicular on L through the endpoint of $P_{k,L} \cap \mathcal{S}_i$, which is **not** on L and the line segment $P_{k,L} \cap \mathcal{S}_i$*

onto

the triangle given by *the intersection point of the outer boundary $\partial\mathcal{S}_i^\pm \cap \partial\mathcal{T}_{k,L}$ with the perpendicular on L through the endpoint of $P_{k,L} \cap \mathcal{S}_i$, which is **not** on L and the intersection point of the same perpendicular with L and the intersection point of $P_{k,L}$ with L*

and leaving the rest of \mathcal{S}_i^\pm unchanged. The reader is encouraged to consult Figure 4.8 for an illustration of the just given definition of $\Phi_{k,L}|_{\mathcal{S}_i^\pm}$. It is an exercise of elementary geometry to show that the k -uniform estimate (4.13) holds for $\Phi_{k,L}$ on every \mathcal{S}_i^\pm for positive constants c_1, c_2, c_3 depending on M, L and β_1, \dots, β_4 only. Also, $\Phi_{k,L}$ is according to its construction certainly a pre-deformation.

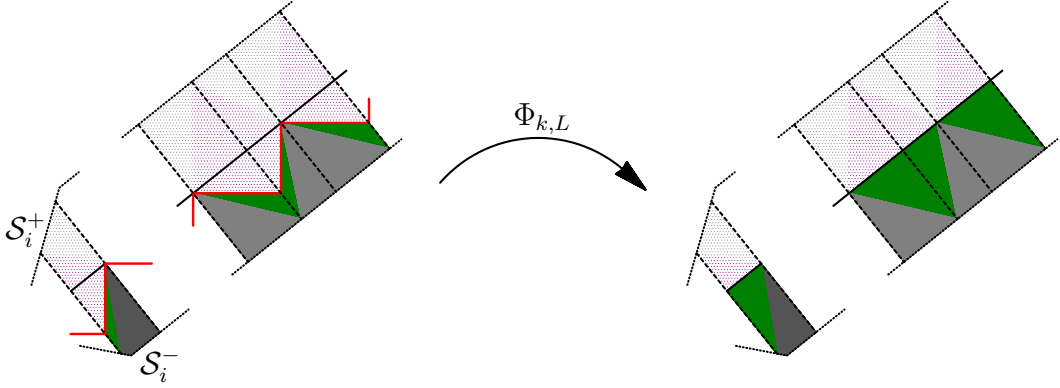

Figure 4.8: Constructing $\Phi_{k,L}$ on each S_i^\pm

Step 3. Since the construction of $\Phi_{k,L}$ over $L \in \text{Face}(P_\psi)$ does not interfere with any other element of $\text{Face}(P_\psi)$, one can assume $\Phi_{k,L}$ to be analogously constructed for all elements $L \in \text{Face}(P_\psi)$ with $\text{dist}(L, \partial\Omega) > 0$ and contained in Ω . Note again, that any $L \in \text{Face}(P_\psi)$ with $\text{dist}(L, \partial\Omega) = 0$ is by assumption (ii) already subset of $\varepsilon_m \partial\mathcal{D}_2$, itself subset of $\varepsilon_k \partial\mathcal{D}_2$ for any $k \geq m$. Thus, on

$$\mathcal{T}_k := \bigcup \{ \mathcal{T}_{k,L} : L \in \text{Face}(P_\psi), \text{dist}(L, \partial\Omega) > 0 \text{ and } L \subseteq \Omega \}$$

one defines the desired pre-deformation Φ_k piecewise to be $\Phi_k|_{\mathcal{T}_{k,L}} := \Phi_{k,L}$. Regarding the fact, that $\Phi_{k,L}$ maps every $\mathcal{T}_{k,L}$ onto itself and equals the identity on $\partial\mathcal{T}_{k,L}$, one extends Φ_k to Ω by the identity mapping. Note, that \mathcal{T}_k is compactly contained in Ω . Consequently, Φ_k maps Ω onto Ω . Another consequence of this definition and the procedure of step 2 is the validity of an estimate like (4.13) uniformly on Ω , with some k -independent constants. Finally, extending Φ_k temporarily to the whole \mathbb{R}^2 by the identity and denoting the extension $\overline{\Phi}_k$, set $P_k := \overline{\Phi}_k^{-1}(P_\psi)$ and note, that by construction its intersection with Ω is subset of $\varepsilon_k \partial\mathcal{D}_2$.

Step 4. One is now in a position to define the sequence $(\psi_k)_k$ claimed in the lemma. To this end, one declares for every k , sufficiently large in the sense of the previous steps, say $k \geq k_0$, the deformation $\psi_k := \psi \circ \Phi_k$, and infers by Proposition 4.3 the inclusion $\psi_k \in SBV^p(\Omega; \mathbb{R}^2) \cap \text{Kin}(\Omega; \mathbf{Box})$. Since by Proposition 3.23 there holds $S_{\psi_k} = \Phi_k^{-1}(S_\psi)$, with the help of $\Phi_k^{-1}(S_\psi) \subseteq \Phi_k^{-1}(P_\psi) = P_k \cap \Omega \subseteq \varepsilon_k \partial\mathcal{D}_2$ and Proposition 3.40 one eventually infers

$$\psi_k \in W^{1,p}(\Omega \setminus \varepsilon_k \partial\mathcal{D}_2; \mathbb{R}^2) = W^{1,p}(\Omega_{\varepsilon_k}; \mathbb{R}^2).$$

For the finitely many remaining $k < k_0$ one defines ψ_k for instance as follows. First one recalls that by assumption there exists an open ball $B_r(z)$ contained in \mathbf{Box} , and then defines ψ_k to be of the form $\Omega \ni x \mapsto \lambda x + z$, where $\lambda > 0$ is

small enough so that ψ_k maps Ω into $B_r(z)$. Obviously $\psi_k \in \text{Kin}(\Omega; \mathbf{Box})$ and $\psi_k \in W^{1,p}(\Omega_{\varepsilon_k}; \mathbb{R}^2)$.

To conclude, for every $k \in \mathbb{N}$ one has $\psi_k \in W^{1,p}(\Omega_{\varepsilon_k}; \mathbb{R}^2) \cap \text{Kin}(\Omega; \mathbf{Box})$. The L^1 -convergence (4.10) of $(\psi_k)_k$ to ψ is now easily inferred. For all $k \geq k_0$, the pre-deformation Φ_k equals the identity on $\Omega \setminus \mathcal{T}_k$, hence $\psi_k \equiv \psi$ on $\Omega \setminus \mathcal{T}_k$. One eventually employs the uniform $L^\infty(\Omega; \mathbb{R}^2)$ -bound on $(\psi_k)_k$ and ψ obtained from the \mathbf{Box} -constraint, and $\text{vol } \mathcal{T}_k \rightarrow 0$ to show $\psi_k \rightarrow \psi$ in $L^1(\Omega; \mathbb{R}^2)$.

Step 5. In order to prove (4.11), one again observes for $k \geq k_0$ the identity $\psi_k \equiv \psi$ on $\Omega \setminus \mathcal{T}_k$. One can therefore write

$$\int_{\Omega} W(\nabla \psi_k) \, dx = \int_{\Omega \setminus \mathcal{T}_k} W(\nabla \psi) \, dx + \int_{\mathcal{T}_k} W(\nabla \psi_k) \, dx. \quad (4.14)$$

Whereas the first term on the right-hand side of (4.14) apparently converges to $\int_{\Omega} W(\nabla \psi) \, dx$ because $\text{vol } \mathcal{T}_k \rightarrow 0$, the second term vanishes as k tends to ∞ as it is revealed by the arguments to come.

By assumption (W1), the definition of ψ_k and Proposition 3.23 one writes

$$\begin{aligned} \int_{\mathcal{T}_k} W(\nabla \psi_k) \, dx &= \int_{\mathcal{T}_k} \mathbb{W}((\nabla \psi \circ \Phi_k) \cdot D\Phi_k, \det((\nabla \psi \circ \Phi_k) \cdot D\Phi_k)) \, dx \\ &\leq \int_{\mathcal{T}_k} c_{\mathbb{W}}(D\Phi_k) (\mathbb{W}(\nabla \psi \circ \Phi_k, \det(\nabla \psi \circ \Phi_k)) + 1) \, dx, \end{aligned}$$

where the estimate results from (W4). Since $c_{\mathbb{W}} \in C(\mathbb{M}_{>}^2)$ is nonnegative by (W4) and attains its maximum on the compact set $\{F : F \in \mathbb{M}_{>}^2, c_1 \leq \det F \leq c_2, |F| \leq c_3\}$, from (4.13) one deduces that $\|c_{\mathbb{W}}(D\Phi_k)\|_{L^\infty(\Omega)}$ is uniformly bounded in k by some positive constant c_4 . Hence, one further estimates

$$\begin{aligned} \int_{\mathcal{T}_k} W(\nabla \psi_k) \, dx &\leq c_4 \int_{\mathcal{T}_k} \mathbb{W}(\nabla \psi \circ \Phi_k, \det(\nabla \psi \circ \Phi_k)) + 1 \, dx \\ &= c_4 \int_{\Phi_k(\mathcal{T}_k)} (\mathbb{W}(\nabla \psi, \det \nabla \psi) + 1) \det D(\Phi_k^{-1}) \, dx \\ &\leq \frac{c_4}{c_1} \int_{\mathcal{T}_k} \mathbb{W}(\nabla \psi, \det \nabla \psi) + 1 \, dx \rightarrow 0, \end{aligned}$$

having performed a change of variables, identified $\Phi_k(\mathcal{T}_k) = \mathcal{T}_k$ and estimated $\det D(\Phi_k^{-1}) = (\det D\Phi_k(\Phi_k^{-1}))^{-1}$ uniformly on Ω from above by means of (4.13).

Step 6. It remains to show (4.12), for which one first writes for $k \geq k_0$ with

the help of $S_{\psi_k} \subseteq P_k \cap \Omega$ and assumption ($\theta 3$)

$$\begin{aligned}
& \int_{S_{\psi_k}} \theta(|\psi_k^+ - \psi_k^-|) d\mathcal{H}^1 = \int_{P_k \cap \Omega} \theta(|\psi_k^+ - \psi_k^-|) d\mathcal{H}^1 \\
&= \sum_{L \in \text{Face}(P_\psi)} \int_{\Phi_k^{-1}(L)} \theta(|\psi_k^+ - \psi_k^-|) d\mathcal{H}^1 \\
&= \sum_{L \in \text{Face}(P_\psi)} \int_{\Phi_k^{-1}(L)} \theta(|\psi^+ \circ \Phi_k - \psi^- \circ \Phi_k|) d\mathcal{H}^1,
\end{aligned} \tag{4.15}$$

wherein the last equality is a consequence of Corollary 3.39. Hence, it suffices to study the convergence of $\int_{\Phi_k^{-1}(L)} \theta(|\psi^+ \circ \Phi_k - \psi^- \circ \Phi_k|) d\mathcal{H}^1$ for some $L \in \text{Face}(P_\psi)$. Since by definition Φ_k equals the identity over all $L \in \text{Face}(P_\psi)$ with $\text{dist}(L, \partial\Omega) = 0$, one has for such L first the equality

$$\int_{\Phi_k^{-1}(L)} \theta(|\psi^+ \circ \Phi_k - \psi^- \circ \Phi_k|) d\mathcal{H}^1 = \int_{L \cap \Omega} \theta(|\psi^+ - \psi^-|) d\mathcal{H}^1.$$

Moreover, according to the assumptions of the lemma it is $L \subseteq \varepsilon_m \partial\mathcal{D}_2 \subseteq \varepsilon_k \partial\mathcal{D}_2$, hence a normal ν_L on L is necessarily $\pm e_1$ or $\pm e_2$. Then $\phi(\nu_L) = 1$ and one arrives at

$$\int_{\Phi_k^{-1}(L)} \theta(|\psi^+ \circ \Phi_k - \psi^- \circ \Phi_k|) d\mathcal{H}^1 = \int_{L \cap \Omega} \phi(\nu_L) \theta(|\psi^+ - \psi^-|) d\mathcal{H}^1 \tag{4.16}$$

for all $L \in \text{Face}(P_\psi)$ with $\text{dist}(L, \partial\Omega) = 0$. One now turns to the convergence study of $L \in \text{Face}(P_\psi)$ with $\text{dist}(L, \partial\Omega) > 0$ and $L \subseteq \Omega$. Again for simplicity, the author explains the procedure for the $L = \text{conv}\{0, K\}$ studied in the first two steps.

Recalling from these steps $\Phi_k^{-1}(L) = P_{k,L}$, one now seeks parametrization of the polygonal set $P_{k,L}$. To this end, define a zig-zag-function $\tau_k : [0, \ell] \rightarrow \mathbb{R}$, where ℓ stands for the length of L . Write $\eta_k := \varepsilon_k(\varepsilon_m)^{-1}\ell$ and set for $b = 0, \eta_k, 2\eta_k, \dots, \ell - 2\eta_k$

$$\tau_k(s) := \begin{cases} -\tan \alpha \cdot (s - b) & \text{if } s \in b + [0, (\cos \alpha)^2 \eta_k], \\ \frac{1}{\tan \alpha} \cdot (s - (b + \eta_k)) & \text{if } s \in b + [(\cos \alpha)^2 \eta_k, \eta_k], \\ \frac{1}{\tan \alpha} \cdot (s - (\ell - \eta_k)) & \text{if } s \in (\ell - \eta_k) + [0, \eta_k - (\cos \alpha)^2 \eta_k], \\ -\tan \alpha \cdot (s - \ell) & \text{if } s \in (\ell - \eta_k) + [\eta_k - (\cos \alpha)^2 \eta_k, \eta_k] \end{cases}$$

where α was the angle between L and the half-line $0 + \mathbb{R}_{>}e_1$, see Figure 4.5. Denote further by R_α the rotation about 0 through α , in matrix notation

$$R_\alpha = \begin{bmatrix} \cos \alpha & -\sin \alpha \\ \sin \alpha & \cos \alpha \end{bmatrix}.$$

Then, the function

$$\lambda_k : [0, \ell] \rightarrow \mathbb{R}^2, \quad \lambda_k(s) := R_\alpha \begin{bmatrix} s \\ \tau_k(s) \end{bmatrix}$$

is indeed a parametrization of $P_{k,L}$, cf. Figure 4.6 for visual help. With this parametrization at hand, one can now explicitly compute the surface integral

$$\begin{aligned} & \int_{\Phi_k^{-1}(L)} \theta(|\psi^+ \circ \Phi_k - \psi^- \circ \Phi_k|) \, d\mathcal{H}^1 \\ &= \int_{(0,\ell)} \theta(|\psi^+ \circ \Phi_k \circ \lambda_k(s) - \psi^- \circ \Phi_k \circ \lambda_k(s)|) \cdot \sqrt{D\lambda_k^T(s)D\lambda_k(s)} \, ds. \end{aligned} \quad (4.17)$$

As it is easily seen, according to the construction of the piecewise linear mapping Φ_k one obtains

$$\Phi_k \circ \lambda_k(s) = R_\alpha \begin{bmatrix} s \\ 0 \end{bmatrix}. \quad (4.18)$$

In order to have reasonably short notation, the author sets $I_1 := [0, (\cos \alpha)^2]$, $I_2 := [(\cos \alpha)^2, 1]$ and $J_1 := [0, 1 - (\cos \alpha)^2]$, $J_2 := [1 - (\cos \alpha)^2, 1]$. Computing $D\tau_k$ now results in

$$D\tau_k(s) = \begin{cases} -\tan \alpha & \text{if } s \in b + \eta_k I_1, \\ \frac{1}{\tan \alpha} & \text{if } s \in b + \eta_k I_2, \\ \frac{1}{\tan \alpha} & \text{if } s \in (\ell - \eta_k) + \eta_k J_1, \\ -\tan \alpha & \text{if } s \in (\ell - \eta_k) + \eta_k J_2, \end{cases}$$

where $b = 0, \eta_k, 2\eta_k, \dots, \ell - 2\eta_k$, and from this it is seen that

$$D\lambda_k(s)^T D\lambda_k(s) = 1 + (D\tau_k(s))^2 = \begin{cases} \frac{1}{(\cos \alpha)^2} & \text{if } s \in b + \eta_k I_1, \\ \frac{1}{(\sin \alpha)^2} & \text{if } s \in b + \eta_k I_2, \\ \frac{1}{(\sin \alpha)^2} & \text{if } s \in (\ell - \eta_k) + \eta_k J_1, \\ \frac{1}{(\cos \alpha)^2} & \text{if } s \in (\ell - \eta_k) + \eta_k J_2 \end{cases}$$

Herein, the simple identities $1 + (\tan \alpha)^2 = (\cos \alpha)^{-2}$ and $1 + (\tan \alpha)^{-2} = (\sin \alpha)^{-2}$ were used. Now one arrives at

$$\begin{aligned} \sqrt{D\lambda_k^T D\lambda_k} &= \sum \left\{ \frac{1}{|\cos \alpha|} \mathbb{1}_{b+\eta_k I_1} + \frac{1}{|\sin \alpha|} \mathbb{1}_{b+\eta_k I_2} : b = 0, \eta_k, 2\eta_k, \dots, \ell - \eta_k \right\} \\ &\quad + \frac{1}{|\sin \alpha|} \mathbb{1}_{(\ell-\eta_k)+\eta_k J_1} + \frac{1}{|\cos \alpha|} \mathbb{1}_{(\ell-\eta_k)+\eta_k J_2} \\ &\quad - \frac{1}{|\cos \alpha|} \mathbb{1}_{(\ell-\eta_k)+\eta_k I_1} - \frac{1}{|\sin \alpha|} \mathbb{1}_{(\ell-\eta_k)+\eta_k I_2}. \end{aligned}$$

Denoting the first object in this equation as $f_{1,k}$ and the sum consisting of the four rest terms as $f_{2,k}$ ($f_{1,k}, f_{2,k} : (0, \ell) \rightarrow \mathbb{R}$), one immediately notices that $f_{2,k} \rightarrow 0$

strongly in $L^2((0, \ell))$. Moreover it is easily seen that $f_{1,k}$ is η_k -periodic and can in particular be written as $f_{1,k} = f_{\text{per}}(\cdot/\eta_k)$ with

$$f_{\text{per}}(s) = \frac{1}{|\cos \alpha|} \mathbb{1}_{I_1}(s) + \frac{1}{|\sin \alpha|} \mathbb{1}_{I_2}(s), \quad s \in (0, 1),$$

assumed to be extended to \mathbb{R} by 1-periodicity. Since $\eta_k = \varepsilon_k(\varepsilon_m)^{-1}\ell$ vanishes as k tends to ∞ , one obtains with the help of a classical two-scale convergence argument (see e.g. [Lukkassen et al., 2002, Theorem 15])

$$\begin{aligned} f_{1,k} &\rightharpoonup \int_{(0,1)} f_{\text{per}}(s) \, ds = \frac{1}{|\cos \alpha|} \text{vol } I_1 + \frac{1}{|\sin \alpha|} \text{vol } I_2 \\ &= |\cos \alpha| + |\sin \alpha| \end{aligned}$$

weakly in $L^2((0, \ell))$. Notice herein, that a normal on L (cf. Figure 4.5) is $\nu_L = \pm[\cos \alpha, -\sin \alpha]^T$, consequently $\phi(\nu_L) = |\cos \alpha| + |\sin \alpha|$. Putting everything together amounts in

$$\sqrt{D\lambda_k^T D\lambda_k} \rightharpoonup \phi(\nu_L) \quad \text{in } L^2((0, \ell)). \quad (4.19)$$

Recalling (4.17) and (4.18), the convergence (4.19) above implies

$$\begin{aligned} &\int_{\Phi_k^{-1}(L)} \theta(|\psi^+ \circ \Phi_k - \psi^- \circ \Phi_k|) \, d\mathcal{H}^1 \\ \rightarrow &\int_{(0,\ell)} \theta \left(|\psi^+ - \psi^-| \circ R_\alpha \begin{bmatrix} s \\ 0 \end{bmatrix} \right) \cdot \phi(\nu_L) \, ds = \int_L \phi(\nu_L) \theta(|\psi^+ - \psi^-|) \, d\mathcal{H}^1. \end{aligned}$$

After inserting this insight into (4.15), with the help of (4.16) one arrives at

$$\begin{aligned} \int_{S_{\psi_k}} \theta(|\psi_k^+ - \psi_k^-|) \, d\mathcal{H}^1 &\rightarrow \sum_{L \in \text{Face}(P_\psi)} \int_{L \cap \Omega} \phi(\nu_L) \theta(|\psi^+ - \psi^-|) \, d\mathcal{H}^1 \\ &= \int_{S_\psi} \phi(\nu_\psi) \theta(|\psi^+ - \psi^-|) \, d\mathcal{H}^1 \end{aligned}$$

which proves the last claim (4.12). \square

To finally conclude the proof of the Γ -lim sup-inequality, Lemma 4.6 implies that for every element of the sequence $(\varphi_m)_m$ found in Lemma 4.5, there is a sequence $(\varphi_{m,k})_k$ in $SBV^p(\Omega; \mathbb{R}^2) \cap \text{Kin}(\Omega; \mathbf{Box})$ that strongly converges to φ_m in $L^1(\Omega; \mathbb{R}^2)$ and satisfies $\mathcal{F}_{\text{Hom}}(\varphi_m) = \lim_k \mathcal{F}_{\varepsilon_k}(\varphi_{m,k})$. Since by Lemma 4.5 there hold $\varphi_m \rightarrow \varphi$ in $L^1(\Omega; \mathbb{R}^2)$ and $\mathcal{F}_{\text{Hom}}(\varphi) = \lim_m \mathcal{F}_{\text{Hom}}(\varphi_m)$, the validity of the Γ -lim sup-inequality now follows from Proposition 3.7 and Remark 3.3. \square

Proving Lemma 4.5

In this last part of Subsection 4.3.3, the author will provide the remaining proof of Lemma 4.5. As a diagonalization argument based on the two Lemmas 4.7 and 4.8 to come, its proof is not difficult, but requires some lengthy preliminary work.

The start will make Lemma 4.7, stating that the deformation φ chosen at the beginning of the proof of the Γ -lim sup-inequality can be approximated by a sequence $(\psi_j)_j$ in $\mathcal{V}^p(\Omega; \mathbb{R}^2) \cap \text{Kin}(\Omega; \mathbf{Box})$, which strongly converges to φ in $L^1(\Omega; \mathbb{R}^2)$ and satisfies $\lim_j \mathcal{F}_{\text{Hom}}(\psi_j) = \mathcal{F}_{\text{Hom}}(\varphi)$. In particular, each ψ_j has its discontinuity set contained in a polyhedral set P_j , which is in accordance with condition (iii) from Lemma 4.5.

Lemma 4.7. *There exist a sequence $(\psi_j)_j$ in $\mathcal{V}^p(\Omega; \mathbb{R}^2) \cap \text{Kin}(\Omega; \mathbf{Box})$ and polyhedral sets P_j , which contain S_{ψ_j} and moreover satisfy condition (iii) from Lemma 4.5. In addition one has*

$$\psi_j \rightarrow \varphi \quad \text{in } L^1(\Omega; \mathbb{R}^2), \quad (4.20)$$

and

$$\lim_{j \rightarrow \infty} \int_{\Omega} W(\nabla \psi_j) \, dx = \int_{\Omega} W(\nabla \varphi) \, dx, \quad (4.21)$$

$$\lim_{j \rightarrow \infty} \int_{S_{\psi_j}} \phi(\nu_{\psi_j}) \theta(|\psi_j^+ - \psi_j^-|) \, d\mathcal{H}^1 = \int_{S_{\varphi}} \phi(\nu_{\varphi}) \theta(|\varphi^+ - \varphi^-|) \, d\mathcal{H}^1. \quad (4.22)$$

Proof. Again like in the case of Lemma 4.6, the proof will be based on the construction of appropriate pre-deformations Φ_j . This time however, the author will construct pre-deformations in the sense of Proposition 4.4.

Step 1. Let $K \in \text{Knot}(P) \cap \Omega$ be arbitrary, and $j \in \mathbb{N}$ sufficiently large, e.g. $j \geq j_0$, in order to have the open ball of radius $\frac{1}{j}$ w.r.t. the maximum-norm and midpoint K compactly contained in Ω , call this cube $Q_{j,K}$. Furthermore, let j_0 also be large enough, such that the cubes $Q_{j_0,K}$, $K \in \text{Knot}(P) \cap \Omega$, are pairwise disjoint. One can for j_0 find an open triangle $\Delta_{j_0,K} \subseteq Q_{j_0,K} \setminus P$ with $\Delta_{j_0,K} \Subset Q_{j_0,K}$ and K as a vertex, and a bijective continuous piecewise affine function $\Phi_{j_0,K} : Q_{j_0,K} \rightarrow \Delta_{j_0,K}$ with positive Jacobian determinant, which maps the cube $Q_{j_0,K}$ onto the triangle $\Delta_{j_0,K}$. See also Figure 4.9. Declare the quantities

$$c_1 := \min_{Q_{j_0,K}} \det D\Phi_{j_0,K}, \quad c_2 := \max_{Q_{j_0,K}} \det D\Phi_{j_0,K} \quad \text{and} \quad c_3 := \max_{Q_{j_0,K}} |D\Phi_{j_0,K}|.$$

Now for $j \geq j_0$ a simple rescaling w.r.t K of the triangle $\Delta_{j_0,K}$,

$$\Delta_{j,K} := \frac{j_0}{j} (\Delta_{j_0,K} - K) + K$$

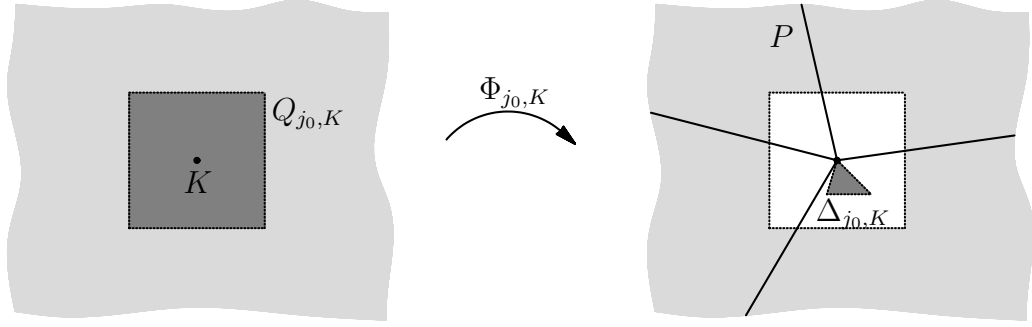
Figure 4.9: The mapping $\Phi_{j_0, K}$

and the function $\Phi_{j_0, K}$,

$$\Phi_{j, K} : Q_{j, K} \rightarrow \Delta_{j, K}, \quad \Phi_{j, K} := \frac{j_0}{j} \left(\Phi_{j_0, K} \left(\frac{j}{j_0} (\cdot - K) + K \right) - K \right) + K$$

provides again a bijective continuous piecewise affine function $\Phi_{j, K} : Q_{j, K} \rightarrow \Delta_{j, K}$ with positive Jacobian determinant, which maps the cube $Q_{j, K}$ onto the triangle $\Delta_{j, K}$. By construction, for the j -independent positive constants c_1, c_2, c_3 there holds the estimate

$$\begin{aligned} c_1 &\leq \det D\Phi_{j, K} \leq c_2 \\ |D\Phi_{j, K}| &\leq c_3 \end{aligned} \quad (4.23)$$

uniformly on $Q_{j, K}$. Since $K \in \text{Knot}(P) \cap \Omega$ was chosen arbitrarily, one can without loss of generality assume estimate (4.23) to hold with the same constants c_1, c_2, c_3 for all $K \in \text{Knot}(P) \cap \Omega$. Thanks to the formulas

$$D(\Phi_{j, K}^{-1}) = (D\Phi_{j, K} \circ (\Phi_{j, K}^{-1}))^{-1} \quad \text{and} \quad F^{-1} = \frac{1}{\det F} \begin{bmatrix} F_{22} & -F_{12} \\ -F_{21} & F_{11} \end{bmatrix}$$

from (4.23) one infers in particular

$$|D(\Phi_{j, K}^{-1})| \leq \frac{c_3}{c_1} \quad (4.24)$$

uniformly on $\Delta_{j, K}$.

Step 2. In order to have reasonably short notation, the author introduces for the proof's purposes the following objects. First, the set of all inner knots

$$\mathcal{K}(P) := \text{Knot}(P) \cap \Omega$$

as well as the open sets

$$\Omega_{j,\text{sliced}} := \Omega \setminus \bigcup_{K \in \mathcal{K}(P)} \partial Q_{j,K},$$

$$\Omega_{j,\text{perf}} := \left(\Omega \setminus \bigcup_{K \in \mathcal{K}(P)} \overline{Q_{j,K}} \right) \cup \bigcup_{K \in \mathcal{K}(P)} \Delta_{j,K}$$

which are depicted in Figure 4.10 and the polyhedral set

$$P_j := \left(P \setminus \bigcup_{K \in \mathcal{K}(P)} \overline{Q_{j,K}} \right) \cup \bigcup_{K \in \mathcal{K}(P)} \partial Q_{j,K}.$$

Note well, that the knots inside Ω of the polyhedral set P_j are in accordance with the assertion of the lemma.

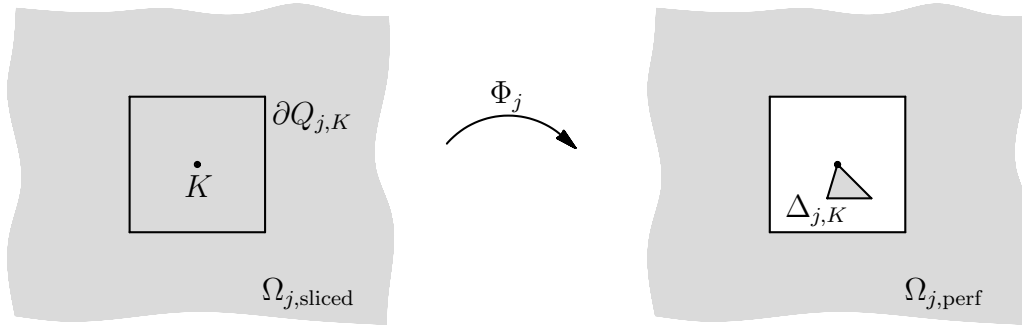

Figure 4.10: The sets $\Omega_{j,\text{sliced}}$ and $\Omega_{j,\text{perf}}$ around $K \in \mathcal{K}(P)$

One defines the function $\Phi_j : \Omega_{j,\text{sliced}} \rightarrow \Omega_{j,\text{perf}}$ by setting

$$\Phi_j(x) := \begin{cases} \Phi_{j,K}(x) & \text{if } x \in Q_{j,K} \text{ for some } K \in \mathcal{K}(P), \\ x & \text{else,} \end{cases}$$

which by construction is certainly bijective. Since it is continuous and piecewise affine on $\Omega_{j,\text{sliced}}$, one has $\Phi_j \in W^{1,\infty}(\Omega_{j,\text{sliced}}; \mathbb{R}^2)$. Being continuous and piecewise affine on $\Omega_{j,\text{perf}}$, there also holds $\Phi_j^{-1} \in W^{1,\infty}(\Omega_{j,\text{perf}}; \mathbb{R}^2)$. Actually, an elementary computation shows that Φ_j^{-1} is Lipschitz-continuous, its Lipschitz-constant being bounded from above by

$$c_4 := \left(1 + \frac{c_3}{c_1} \right) \left(1 + \frac{4\sqrt{2}}{j_0 \min_{K \in \mathcal{K}(P)} \text{dist}(\partial Q_{j_0,K}, \partial \Delta_{j_0,K})} \right).$$

To see this, let $x, y \in \Omega_{j,\text{perf}}$ and distinguish the four following possible cases.

case (a) If $x, y \in \Omega \setminus \bigcup_{K \in \mathcal{K}(P)} \overline{Q_{j,K}}$, then $|\Phi_j^{-1}(x) - \Phi_j^{-1}(y)| = |x - y| \leq c_4|x - y|$.

case (b) If $x, y \in \Delta_{j,K}$ for some $K \in \mathcal{K}(P)$, then there holds $|\Phi_j^{-1}(x) - \Phi_j^{-1}(y)| \leq \|D(\Phi_{j,K}^{-1})\|_{L^\infty(\Delta_{j,K}; \mathbb{M}^2)}|x - y|$ and one estimates $\|D(\Phi_{j,K}^{-1})\|_{L^\infty(\Delta_{j,K}; \mathbb{M}^2)}$ by means of (4.24), concluding $|\Phi_j^{-1}(x) - \Phi_j^{-1}(y)| \leq c_4|x - y|$.

case (c) If $x \in \Omega \setminus \bigcup_{K \in \mathcal{K}(P)} \overline{Q_{j,K}}$ and $y \in \Delta_{j,K_1}$ for some $K_1 \in \mathcal{K}(P)$, let $z_1 \in \partial Q_{j,K_1}$ and $z_2 \in \partial \Delta_{j,K_1}$ such that

$$\Phi_j^{-1}(z_1) = \Phi_j^{-1}(z_2)$$

upon properly extending Φ_j^{-1} onto $\partial Q_{j,K_1}$ (or $\partial \Delta_{j,K_1}$) by approximation from the inside of $\Omega \setminus \bigcup_{K \in \mathcal{K}} \overline{Q_{j,K}}$ (or Δ_{j,K_1}). Note, that in this fashion $\Phi_j^{-1}(z_1) = z_1$. But then

$$\begin{aligned} & |\Phi_j^{-1}(x) - \Phi_j^{-1}(y)| \\ &= |\Phi_j^{-1}(x) - \Phi_j^{-1}(z_1) + \Phi_j^{-1}(z_2) - \Phi_j^{-1}(y)| \\ &\leq |x - z_1| + \|D(\Phi_{j,K_1}^{-1})\|_{L^\infty(\Delta_{j,K_1}; \mathbb{M}^2)}|z_2 - y|. \end{aligned} \quad (4.25)$$

However, one first writes

$$\begin{aligned} |x - z_1| &\leq |x - y| + |y - z_1| \\ &\leq |x - y| + \text{diam } Q_{j,K_1} = |x - y| + 2\sqrt{2}\frac{1}{j}, \\ |z_2 - y| &\leq \text{diam } Q_{j,K_1} = 2\sqrt{2}\frac{1}{j}. \end{aligned} \quad (4.26)$$

Eventually, let $\{z_3\} = \partial Q_{j,K} \cap \text{conv}\{x, y\}$, hence $|x - y| = |x - z_3| + |z_3 - y| \geq |z_3 - y|$. As concerns $|z_3 - y|$, one recalls $y \in \Delta_{j,K_1}$ as well as the construction of Δ_{j,K_1} , whence it is easy to see that

$$|z_3 - y| = \frac{j_0}{j} \cdot \frac{|z_3 - y|}{\frac{1}{j}} \frac{1}{j_0} \geq \frac{j_0}{j} \cdot \text{dist}(\partial Q_{j_0,K_1}, \partial \Delta_{j_0,K_1}).$$

One deduces

$$\frac{1}{j} \leq \frac{|x - y|}{j_0 \cdot \text{dist}(\partial Q_{j_0,K_1}, \partial \Delta_{j_0,K_1})}. \quad (4.27)$$

After having estimated (4.25) by means of (4.24) and (4.26), with the help of last established (4.27) one infers $|\Phi_j^{-1}(x) - \Phi_j^{-1}(y)| \leq c_4|x - y|$.

case (d) In the last case, let $x \in \Delta_{j,K_1}$ and $y \in \Delta_{j,K_2}$ for some different $K_1, K_2 \in \mathcal{K}(P)$. Choosing $z_1, z_2 \in \Omega \setminus \bigcup_{K \in \mathcal{K}(P)} \overline{Q_{j,K}}$ such that $z_1, z_2 \in \text{conv}\{x, y\}$ and $|x - y| = |x - z_1| + |z_1 - z_2| + |z_2 - y|$, one obtains by case (a) and (c)

$$\begin{aligned} & |\Phi_j^{-1}(x) - \Phi_j^{-1}(y)| \\ & \leq |\Phi_j^{-1}(x) - \Phi_j^{-1}(z_1)| + |\Phi_j^{-1}(z_1) - \Phi_j^{-1}(z_2)| + |\Phi_j^{-1}(z_2) - \Phi_j^{-1}(y)| \\ & \leq c_4|x - z_1| + |z_1 - z_2| + c_4|z_2 - y| \leq c_4|x - y|. \end{aligned}$$

One concludes, that $\Phi_j : \Omega_{j,\text{sliced}} \rightarrow \Omega_{j,\text{perf}}$ is indeed a pre-deformation, and thanks to (4.23) there holds for some j -independent constants, again denoted c_1, c_2, c_3 , the estimate

$$\begin{aligned} c_1 & \leq \det D\Phi_j \leq c_2 \\ & |D\Phi_j| \leq c_3 \end{aligned} \quad (4.28)$$

uniformly on $\Omega_{j,\text{sliced}}$, hence uniformly a.e. on Ω .

Step 3. One now defines for all $j \geq j_0$ the sequence $(\psi_j)_j$ by composition $\psi_j := \varphi \circ \Phi_j$ (for $j < j_0$ one could declare ψ_j like e.g. in step 4 of the proof of Lemma 4.6). Then, because of $\Omega_{j,\text{sliced}} = \Omega \setminus \bigcup_{K \in \mathcal{K}(P)} \partial Q_{j,K}$, where

$$\bigcup_{K \in \mathcal{K}(P)} \partial Q_{j,K} \text{ is compact, } \quad \mathcal{H}^1 \left(\bigcup_{K \in \mathcal{K}(P)} \partial Q_{j,K} \right) = \text{card}(\mathcal{K}(P)) \cdot \frac{8}{j} < \infty$$

and the openness of $\Omega_{j,\text{perf}}$, Proposition 4.4 provides $\psi_j \in SBV^p(\Omega; \mathbb{R}^2) \cap \text{Kin}(\Omega; \mathbf{Box})$ and

$$S_{\psi_j} \subseteq \Phi_j^{-1}(S_\varphi \cap \Omega_{j,\text{perf}}) \cup \bigcup_{K \in \mathcal{K}(P)} \partial Q_{j,K}. \quad (4.29)$$

Since by assumption $S_\varphi \subseteq P$, one deduces

$$\Phi_j^{-1}(S_\varphi \cap \Omega_{j,\text{perf}}) \subseteq \Phi_j^{-1}(P \cap \Omega_{j,\text{perf}}) = P \setminus \bigcup_{K \in \mathcal{K}(P)} \overline{Q_{j,K}}.$$

Inserting this into (4.29) and recalling the definition of P_j , one arrives at the inclusion

$$S_{\psi_j} \subseteq \left(P \setminus \bigcup_{K \in \mathcal{K}(P)} \overline{Q_{j,K}} \right) \cup \bigcup_{K \in \mathcal{K}(P)} \partial Q_{j,K} = P_j.$$

In particular, one has $\psi_j \in \mathcal{V}^p(\Omega; \mathbb{R}^2) \cap \text{Kin}(\Omega; \mathbf{Box})$. It is also important to note, that by construction Φ_j equals the identity mapping on $\Omega \setminus \bigcup_{K \in \mathcal{K}(P)} \overline{Q_{j,K}}$, which in turn implies

$$\varphi \equiv \psi_j \quad \text{on } \Omega \setminus \bigcup_{K \in \mathcal{K}(P)} \overline{Q_{j,K}} \quad (4.30)$$

for all $j \geq j_0$.

Step 4. In view of $\text{vol} \left(\bigcup_{K \in \mathcal{K}(P)} Q_{j,K} \right) \rightarrow 0$ and the validity of estimate (4.28), one proves the convergences (4.20) and (4.21) analogously to the procedure presented in steps 4 and 5 of the proof of Lemma 4.6.

Turning to the proof of (4.22), one writes with the help of $S_{\psi_j} \subseteq P_j$ and (θ3), as well as by means of the identity (4.30)

$$\begin{aligned} & \int_{S_{\psi_j}} \phi(\nu_{\psi_j}) \theta(|\psi_j^+ - \psi_j^-|) \, d\mathcal{H}^1 = \int_{P_j \cap \Omega} \phi(\nu_{P_j}) \theta(|\psi_j^+ - \psi_j^-|) \, d\mathcal{H}^1 \\ & = \int_{(P \cap \Omega) \setminus \mathcal{Q}_j} \phi(\nu_P) \theta(|\varphi^+ - \varphi^-|) \, d\mathcal{H}^1 + \int_{(P_j \cap \Omega) \cap \mathcal{Q}_j} \phi(\nu_{P_j}) \theta(|\psi_j^+ - \psi_j^-|) \, d\mathcal{H}^1. \end{aligned} \quad (4.31)$$

Herein, the author set for the convenience of the reader $\mathcal{Q}_j := \bigcup_{K \in \mathcal{K}(P)} \overline{Q_{j,K}}$. Upon realizing the fact that $\mathcal{H}^1(P_j \cap \mathcal{Q}_j) \rightarrow 0$, for the first term in (4.31) there holds

$$\begin{aligned} & \int_{(P \cap \Omega) \setminus \mathcal{Q}_j} \phi(\nu_P) \theta(|\varphi^+ - \varphi^-|) \, d\mathcal{H}^1 \\ & \rightarrow \int_{P \cap \Omega} \phi(\nu_P) \theta(|\varphi^+ - \varphi^-|) \, d\mathcal{H}^1 = \int_{S_\varphi} \phi(\nu_\varphi) \theta(|\varphi^+ - \varphi^-|) \, d\mathcal{H}^1, \end{aligned}$$

whereas in the second term of (4.31) one estimates

$$\int_{(P_j \cap \Omega) \cap \mathcal{Q}_j} \phi(\nu_{P_j}) \theta(|\psi_j^+ - \psi_j^-|) \, d\mathcal{H}^1 \leq \sup_{\nu \in S^1} \phi(\nu) \cdot \theta(\text{diam } \mathbf{Box}) \cdot \mathcal{H}^1(P_j \cap \mathcal{Q}_j) \rightarrow 0.$$

Hence, from (4.31) one also infers the validity of (4.22) and finishes the proof of the lemma. \square

In the next result on the way to a proof of Lemma 4.5, the author shows that every deformation in the sequence $(\psi_j)_j$ can itself be approximated by another sequence of deformations $(\psi_{j,\ell})_\ell$ in $\mathcal{V}^p(\Omega; \mathbb{R}^2) \cap \text{Kin}(\Omega; \mathbf{Box})$, strongly converging to ψ_j in $L^1(\Omega; \mathbb{R}^2)$ and providing the continuity $\mathcal{F}_{\text{Hom}}(\psi_j) = \lim_\ell \mathcal{F}_{\text{Hom}}(\psi_{j,\ell})$. The main feature of the $\psi_{j,\ell}$ is, that they have their discontinuity set contained in a polyhedral set $P_{j,\ell}$, which satisfies all three conditions (i), (ii), (iii) imposed in Lemma 4.5.

Lemma 4.8. *Let $\psi \in \mathcal{V}^p(\Omega; \mathbb{R}^2) \cap \text{Kin}(\Omega; \mathbf{Box})$ be such that $\mathcal{F}_{\text{Hom}}(\psi) < \infty$, and such that there is a polyhedral set P_ψ containing S_ψ and satisfying condition (iii) from Lemma 4.5. Then there are a sequence $(\psi_\ell)_\ell$ in $\mathcal{V}^p(\Omega; \mathbb{R}^2) \cap \text{Kin}(\Omega; \mathbf{Box})$, a subsequence $(\varepsilon_{q(\ell)})_\ell$ and polyhedral sets P_ℓ , each of which contains S_{ψ_ℓ} and satisfies the conditions (i) and (ii) from Lemma 4.5 (w.r.t. the subsequence $(\varepsilon_{q(\ell)})_\ell$) as well as condition (iii) from the same lemma. Moreover, there hold the convergences*

$$\psi_\ell \rightarrow \psi \quad \text{in } L^1(\Omega; \mathbb{R}^2), \quad (4.32)$$

and

$$\lim_{\ell \rightarrow \infty} \int_{\Omega} W(\nabla \psi_\ell) \, dx = \int_{\Omega} W(\nabla \psi) \, dx, \quad (4.33)$$

$$\lim_{\ell \rightarrow \infty} \int_{S_{\psi_\ell}} \phi(\nu_{\psi_\ell}) \theta(|\psi_\ell^+ - \psi_\ell^-|) \, d\mathcal{H}^1 = \int_{S_\psi} \phi(\nu_\psi) \theta(|\psi^+ - \psi^-|) \, d\mathcal{H}^1. \quad (4.34)$$

Proof. Like in the case of the preceding lemmas, the proof rests upon the construction of certain pre-deformations. This time however, the construction of the latter is split into two stages. In the first one, the author will construct a pre-deformation Φ_{1,η_1} in the sense of Proposition 4.4, that depends on a small parameter η_1 , operates only near the boundary of Ω and manipulates the polyhedral set P_ψ , such that its inverse image under Φ_{1,η_1} meets the conditions (ii) (w.r.t. $\eta_1 \partial \mathcal{D}_2$) and (iii) stated in Lemma 4.5. A second stage will provide the construction of a pre-deformation Φ_{2,η_2} in the sense of Proposition 4.3, which features another small, η_1 -dependent parameter η_2 . The second pre-deformation will be such that its inverse operates only in a small environment of $\Phi_{1,\eta_1}^{-1}(P_\psi)$ and maps the latter on yet another polyhedral set, the knots inside Ω of which lie on the by η_2 scaled down \mathbb{Z}^2 -grid. Thus it satisfies the remaining condition (i) of Lemma 4.5 w.r.t. $\eta_2 \mathbb{Z}^2$. Since the second pre-deformation Φ_{2,η_2} is defined such that it conserves the properties (ii) and (iii) of $\Phi_{1,\eta_1}^{-1}(P_\psi)$, by composing Φ_{1,η_1} and Φ_{2,η_2} one obtains a pre-deformation, which is eventually used to prove the claim of the present lemma.

Step 1. Denote by $\mathcal{K}_{\partial\Omega}(P_\psi)$ the set of all intersection points of P_ψ with $\partial\Omega$, which is finite since Ω was assumed to be nonoscillating, and let $K \in \mathcal{K}_{\partial\Omega}(P_\psi)$ be arbitrary. Since Ω is a Lipschitzian domain, by [Adams and Fournier, 2003, Section 4.11] it satisfies the cone condition from Definition 3.35. Thus there is a finite cone C_K with vertex K , in 2D spanned by two vectors $v_1, v_2 \in S^1$ with $0 < \angle(v_1, v_2) \leq \frac{\pi}{2}$, i.e.

$$C_K = \{K + w : 0 < |w| \leq r, 0 \leq \angle(v_1, w) \leq \angle(v_1, v_2)\}$$

for some $r > 0$,

contained in Ω . Let B_K be some small enough closed ball around K , such that it separates K from all other elements of $\mathcal{K}_{\partial\Omega}(P_\psi)$, and all elements in $\text{Face}(P_\psi \cap B_K)$ contain K (i.e. all lines in P_ψ that enter B_K shall actually run into K). Let η_1 be sufficiently small, such that there is an open cube $Q_{\eta_1, K}$ with edge length $8\eta_1$ such that

$$Q_{\eta_1, K} \Subset \text{int } B_K, \partial Q_{\eta_1, K} \subseteq \eta_1 \partial \mathcal{D}_2 \text{ and the distance between the center of } Q_{\eta_1, K} \text{ and } K \text{ in the supremum norm is less equal } \eta_1.$$

The author encourages the reader to turn to Figure 4.11 in order to have a visual impression of the above said. Solely for the purpose of explaining the construction

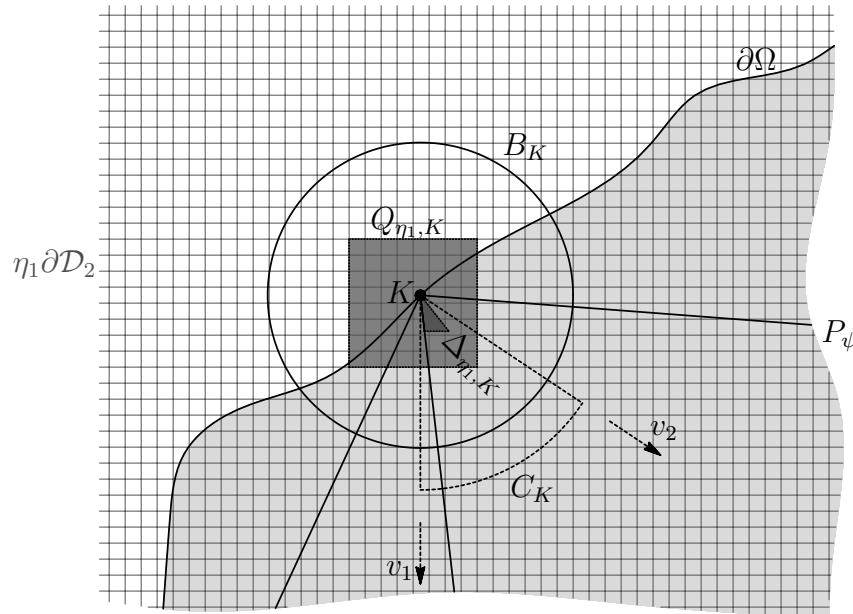

Figure 4.11: The geometrical situation of P_ψ in $K \in \mathcal{K}_{\partial\Omega}(P_\psi)$

of the pre-deformation Φ_{1, η_1} it proves helpful to introduce the polyhedral set

$$P_{\text{temp}} := (P_\psi \cup (K + \mathbb{R}_{>} v_1) \cup (K + \mathbb{R}_{>} v_2)) \cap C_K$$

and one notices that ψ has no jumps on $C_K \setminus P_{\text{temp}}$, hence is $W^{1,p}$ -regular hereon. Like in the first step of the proof of Lemma 4.7, the goal is now to find an open triangle $\Delta_{\eta_1, K} \subseteq C_K \setminus P_{\text{temp}}$, $\Delta_{\eta_1, K} \Subset Q_{\eta_1, K}$ and a bijective continuous piecewise affine function $\Phi_{1, \eta_1, K} : Q_{\eta_1, K} \rightarrow \Delta_{\eta_1, K}$ with positive Jacobian determinant, which maps the cube $Q_{\eta_1, K}$ onto the triangle $\Delta_{\eta_1, K}$.

As concerns the triangle $\Delta_{\eta_1, K}$, let $L_i = (K + \mathbb{R}_{>} u_i) \cap C_K$, $u_i \in S^1$ and $i = 1, 2$, be neighbouring elements in $\text{Face}(P_{\text{temp}})$, and α be the positive angle between them. One distinguishes the following two distinct cases – recall, that

$L_1, L_2 \subseteq C_K$, which has by assumption an aperture angle not larger than $\frac{\pi}{2}$, thus $0 < \alpha \leq \frac{\pi}{2}$.

case (a) L_1 and L_2 intersect the same side of $Q_{\eta_1, K}$. Then take $\Delta_{\eta_1, K}$ to be the triangle between L_1, L_2 and the intersected edge of $Q_{\eta_1, K}$, but scaled w.r.t. K by a factor of $\frac{1}{2}$. Note, that the scaling is to ensure $\Delta_{\eta_1, K} \subseteq Q_{\eta_1, K}$.

case (b) L_1 and L_2 intersect neighbouring edges of $Q_{\eta_1, K}$. Then the intersection of the cone spanned by L_1 and L_2 with $Q_{\eta_1, K}$ is the union of two triangles with common vertex K , one of them has an aperture angle in K greater or equal $\frac{\alpha}{2}$. Choose $\Delta_{\eta_1, K}$ to be this triangle, but again scaled w.r.t. K by a factor of $\frac{1}{2}$.

Hence, in any case the triangle $\Delta_{\eta_1, K}$ is of the form $\Delta_{\eta_1, K} = \text{conv} \{K, K + w_1, K + w_2\}$ for some vectors w_1, w_2 , which can be estimated like

$$\begin{aligned} \alpha_0 &\leq \angle(w_1, w_2) \leq \alpha_1 \\ \frac{3}{2}\eta_1 &\leq |w_1|, |w_2| \leq \frac{5}{\sqrt{2}}\eta_1, \end{aligned} \quad (4.35)$$

for some angles $0 < \alpha_0 < \alpha_1 \leq \frac{\pi}{2}$ depending solely on P_{temp} , i.e. P_ψ and $\partial\Omega$. Whereas the estimate on $|w_1|, |w_2|$ results from the assumption, that the distance between the center of $Q_{\eta_1, K}$ and K in the supremum norm is less equal η_1 .

The mapping $\Phi_{1, \eta_1, K} : Q_{\eta_1, K} \rightarrow \Delta_{\eta_1, K}$ is now constructed as the composition of the following two bijective continuous piecewise affine mappings with positive Jacobian determinant. The first of which maps the cube $Q_{\eta_1, K}$ onto one of the triangles obtained by dividing $Q_{\eta_1, K}$ along a diagonal. Whereas the second one shrinks this triangle down to $\Delta_{\eta_1, K}$. By means of the estimates (4.35) it is an elementary computation to show that the such constructed $\Phi_{1, \eta_1, K}$ admits positive constants c_1, c_2, c_3 depending on P_ψ and $\partial\Omega$ only, such that there holds

$$\begin{aligned} c_1 &\leq \det D\Phi_{1, \eta_1, K} \leq c_2 \\ |D\Phi_{1, \eta_1, K}| &\leq c_3 \end{aligned} \quad (4.36)$$

uniformly on $Q_{\eta_1, K}$.

Prior to introducing the first pre-deformation Φ_{1, η_1} , one defines similarly to the proof of Lemma 4.7 the open sets

$$\begin{aligned} \Omega_{\eta_1, \text{sliced}} &:= \Omega \setminus \bigcup_{K \in \mathcal{K}_{\partial\Omega}(P_\psi)} \partial Q_{\eta_1, K}, \\ \Omega_{\eta_1, \text{perf}} &:= \left(\Omega \setminus \bigcup_{K \in \mathcal{K}_{\partial\Omega}(P_\psi)} \overline{Q_{\eta_1, K}} \right) \cup \bigcup_{K \in \mathcal{K}_{\partial\Omega}(P_\psi)} \Phi_{1, \eta_1, K} (Q_{\eta_1, K} \cap \Omega) \end{aligned}$$

depicted in Figure 4.12 and the polyhedral set

$$P_{1,\eta_1} := \left(P_\psi \setminus \bigcup_{K \in \mathcal{K}_{\partial\Omega}(P_\psi)} \overline{Q_{\eta_1,K}} \right) \cup \bigcup_{K \in \mathcal{K}_{\partial\Omega}(P_\psi)} \partial Q_{\eta_1,K}.$$

In particular, all elements $L \in \text{Face}(P_{1,\eta_1})$ with $\text{dist}(L, \partial\Omega) = 0$ satisfy $L \subseteq \eta_1 \partial\mathcal{D}_2$, which is to be compared with the condition (ii) in Lemma 4.5. Since P_ψ satisfies condition (iii) from Lemma 4.5, by construction this holds also true for P_{1,η_1} . Finally, one declares $\Phi_{1,\eta_1} : \Omega_{\eta_1,\text{sliced}} \rightarrow \Omega_{\eta_1,\text{perf}}$ by setting

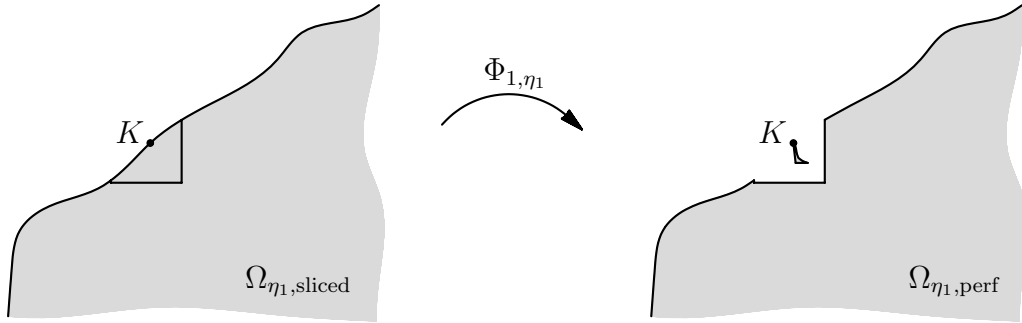

Figure 4.12: The sets $\Omega_{\eta_1,\text{sliced}}$ and $\Omega_{\eta_1,\text{perf}}$ around $K \in \mathcal{K}_{\partial\Omega}(P_\psi)$

$$\Phi_{1,\eta_1}(x) := \begin{cases} \Phi_{1,\eta_1,K}(x) & \text{if } x \in Q_{\eta_1,K} \cap \Omega \text{ for some } K \in \mathcal{K}_{\partial\Omega}(P_\psi), \\ x & \text{else.} \end{cases}$$

Clearly Φ_{1,η_1} is of regularity $W^{1,\infty}(\Omega_{\eta_1,\text{sliced}}; \mathbb{R}^2)$, and has by (4.36) a positive Jacobian determinant. By performing similar computations like done in step 2 of the proof of Lemma 4.7, one realizes in addition that Φ_{1,η_1}^{-1} is Lipschitz-continuous, its Lipschitz-constant being bounded from above by

$$c_4 := \left(1 + \frac{c_3}{c_1} \right) \left(1 + \frac{32\sqrt{2}}{7 - 4\sqrt{2}} \right),$$

where c_4 depends on P_ψ and $\partial\Omega$ (through c_1 and c_3) only. Thus Φ_{1,η_1} is indeed a pre-deformation. In addition, with the help of (4.36) one deduces without loss of generality for the same positive, only P_ψ - and $\partial\Omega$ -dependent constants c_1, c_2, c_3 the validity of

$$\begin{aligned} c_1 &\leq \det D\Phi_{1,\eta_1} \leq c_2 \\ &|D\Phi_{1,\eta_1}| \leq c_3 \end{aligned} \tag{4.37}$$

uniformly on $\Omega_{\eta_1, \text{sliced}}$, thus uniformly a.e. on Ω . Note moreover that by construction

$$\Phi_{1, \eta_1}^{-1}(P_\psi \cap \Omega_{\eta_1, \text{perf}}) = P_\psi \setminus \bigcup_{K \in \mathcal{K}_{\partial\Omega}(P_\psi)} \overline{Q_{\eta_1, K}}. \quad (4.38)$$

and Φ_{1, η_1} equals the identity mapping on $\Omega \setminus \bigcup_{K \in \mathcal{K}_{\partial\Omega}(P_\psi)} \overline{Q_{\eta_1, K}}$.

Step 2. In this step one is first concerned with the construction of a bijective Lipschitz-continuous function Ψ_{2, η_2} that maps the set P_{1, η_1} onto another polyhedral set P_{2, η_2} (parametrized by some small, positive real number η_2) that shows the following three properties. First, $\text{Knot}(P_{2, \eta_2}) \cap \Omega \subseteq \eta_2 \mathbb{Z}^2$, secondly $L \subseteq \eta_2 \partial \mathcal{D}_2$ for all $L \in \text{Face}(P_{2, \eta_2})$ with $\text{dist}(L, \partial\Omega) = 0$, and last satisfies condition (iii) from Lemma 4.5.

Let η_2 be a positive real number such that $\frac{\eta_1}{\eta_2} \in \mathbb{N}$, and suppose it is small enough for the following computations to make sense. Note that by the refinement assumption $\frac{\eta_1}{\eta_2} \in \mathbb{N}$ there hold

$$\eta_1 \mathbb{Z}^2 \subseteq \eta_2 \mathbb{Z}^2 \quad \text{and} \quad \eta_1 \partial \mathcal{D}_2 \subseteq \eta_2 \partial \mathcal{D}_2. \quad (4.39)$$

Thus by the properties of P_{1, η_1} discussed in the first step, one has already $L \subseteq \eta_2 \partial \mathcal{D}_2$ for all $L \in \text{Face}(P_{1, \eta_1})$ with $\text{dist}(L, \partial\Omega) = 0$, as well as the validity of condition (iii) from Lemma 4.5. The only thing that remains to be accomplished by the mapping Ψ_{2, η_2} , is to slightly deform the set P_{1, η_1} in order to move its knots inside Ω onto the gridpoints $\eta_2 \mathbb{Z}^2$.

To this end one defines a tube \mathcal{T}_{η_2} around P_{1, η_1} by taking parallels to both sides of all $L \in \text{Face}(P_{1, \eta_1})$ with $L \cap \Omega \neq \emptyset$ at a distance of $M\eta_2$, the intersections of which form the tube \mathcal{T}_{η_2} . Herein, η_2 shall be so small, that \mathcal{T}_{η_2} does not overlap itself, and $M \in \mathbb{N}$ some large enough, but fixed number. In case $L \in \text{Face}(P_{1, \eta_1})$ with $L \cap \Omega \neq \emptyset$ such that either L intersects $\partial\Omega$ or L contains an endpoint of P_{1, η_1} , the tube \mathcal{T}_{η_2} is completed by adding a certain right isosceles triangle as shown in Figure 4.13. It is clear that in this manner $\mathcal{T}_{\eta_2} \Subset \Omega$ and \mathcal{T}_{η_2} contains $\text{Knot}(P_{1, \eta_1}) \cap \Omega$. The mapping Ψ_{2, η_2} is now constructed as a continuous, piecewise affine function in a way, that it differs from the identity mapping on \mathcal{T}_{η_2} only.

Let $L \in \text{Face}(P_{1, \eta_1})$ be arbitrary. Then $L \cap \mathcal{T}_{\eta_2}$ together with the boundary of \mathcal{T}_{η_2} describes a trapezoid to every side of L like shown in Figure 4.14 below, call one of them $ABCD$ after its vertices. On $ABCD$ shall act Ψ_{2, η_2} as follows. One bisects $ABCD$ along one of its diagonals, e.g. $[BD]$, in two subtriangles ABD and DBC . Then, those triangles will be affinely mapped onto the triangles $AB(D + \Delta D)$ and $(D + \Delta D)B(C + \Delta C)$, where $C + \Delta C$ and $D + \Delta D$ are the next gridpoints to C and D on $\eta_2 \mathbb{Z}^2$, respectively. It is an exercise of elementary calculus and geometry to show that there are positive constants c_5, c_6, c_7 , only

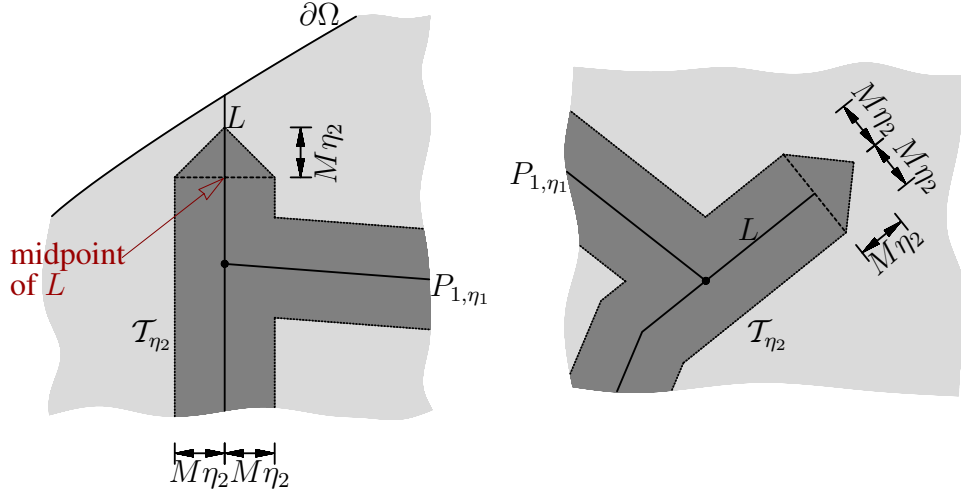

Figure 4.13: The tube \mathcal{T}_{η_2} and its construction over endpoints of P_{1,η_1} inside Ω and near $\partial\Omega$

depending on P_ψ and M , such that for the piecewise affine mapping $\Psi_{2,\eta_2}|_{ABCD} : ABCD \rightarrow AB(C + \Delta C)(D + \Delta D)$ there holds

$$\begin{aligned} c_5 &\leq \det D\Psi_{2,\eta_2} \leq c_6 \\ |D\Psi_{2,\eta_2}| &\leq c_7 \end{aligned} \quad (4.40)$$

uniformly on $ABCD$ (upon choosing $M \in \mathbb{N}$ once and for all large enough). Successively applying this construction to every $L \cap \mathcal{T}_{\eta_2}$, $L \in \text{Face}(P_{1,\eta_1})$, and both of its sides, one obtains a bijective continuous piecewise affine function Ψ_{2,η_2} , for which (4.40) holds uniformly on the whole of \mathcal{T}_{η_2} . In addition one observes, that by the above construction Ψ_{2,η_2} equals the identity on $\partial\mathcal{T}_{\eta_2}$. Hence, one can assume Ψ_{2,η_2} to be extended by the identity to \mathbb{R}^2 . In particular note, that Ψ_{2,η_2} maps Ω onto itself. Moreover, the estimates (4.40) remain valid uniformly on \mathbb{R}^2 .

Eventually, one declares the polyhedral set

$$P_{2,\eta_2} := \Psi_{2,\eta_2}(P_{1,\eta_1}).$$

By construction of Ψ_{2,η_2} there holds

$$\text{Knot}(P_{2,\eta_2}) \cap \Omega \subseteq \eta_2 \mathbb{Z}^2. \quad (4.41)$$

Another close look to its construction reveals that

$$\Psi_{2,\eta_2} \left(\bigcup_{K \in \mathcal{K}_{\partial\Omega}(P_\psi)} \partial Q_{\eta_1,K} \right) = \bigcup_{K \in \mathcal{K}_{\partial\Omega}(P_\psi)} \partial Q_{\eta_1,K}. \quad (4.42)$$

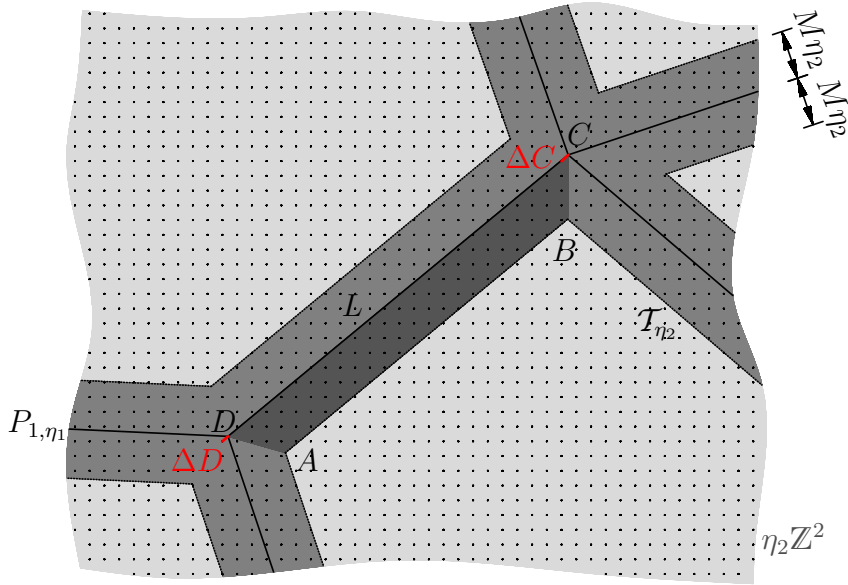
Figure 4.14: The mapping Ψ_{2,η_2} on \mathcal{T}_{η_2}

Indeed, let $N \in \text{Knot}(P_{1,\eta_1}) \cap \Omega$ be such that $N \in \partial Q_{\eta_1,K}$ for some $K \in \mathcal{K}_{\partial\Omega}(P_\psi)$. By assumption, $\partial Q_{\eta_1,K} \subseteq \eta_1 \partial \mathcal{D}_2$, which in turn is a subset of $\eta_2 \partial \mathcal{D}_2$, cf. (4.39). Thus, for η_2 sufficiently small w.r.t. η_1 , the next gridpoint to N on $\eta_2 \mathbb{Z}^2$ is also an element of $\partial Q_{\eta_1,K}$. The construction of Ψ_{2,η_2} then reveals the claim (4.42). As a consequence of (4.42), P_{2,η_2} inherits the property of P_{1,η_1} , that

$$\begin{aligned} &\text{all elements } L \in \text{Face}(P_{2,\eta_2}) \text{ with } \text{dist}(L, \partial\Omega) = 0 \text{ satisfy} \\ &L \subseteq \eta_1 \partial \mathcal{D}_2 \subseteq \eta_2 \partial \mathcal{D}_2. \end{aligned} \quad (4.43)$$

Yet another consequence of (4.42), the bijectivity of Ψ_{2,η_2} and the fact that it maps Ω onto Ω is

$$\Psi_{2,\eta_2}(\Omega_{\eta_1, \text{sliced}}) = \Omega_{\eta_1, \text{sliced}}. \quad (4.44)$$

Last, note that also by construction Ψ_{2,η_2} conserves the property (iii) from Lemma 4.5, as it was fulfilled by P_{1,η_1} . One infers

$$P_{2,\eta_2} \text{ satisfies condition (iii) from Lemma 4.5.} \quad (4.45)$$

The end of this step is marked by the insight, that Ψ_{2,η_2} as a bijective continuous piecewise affine mapping on \mathbb{R}^2 that equals the identity outside Ω is certainly Lipschitz and has a Lipschitz-inverse, called

$$\Phi_{2,\eta_2} := (\Psi_{2,\eta_2})^{-1}.$$

By exploiting the identities

$$D\Phi_{2,\eta_2} = (D\Psi_{2,\eta_2} \circ (\Psi_{2,\eta_2}^{-1}))^{-1} \quad \text{and} \quad F^{-1} = \frac{1}{\det F} \begin{bmatrix} F_{22} & -F_{12} \\ -F_{21} & F_{11} \end{bmatrix}$$

one deduces from (4.40), that for some positive constants c_8, c_9, c_{10} , which depend on P_ψ and the fixed natural number M only

$$\begin{aligned} c_8 &\leq \det D\Phi_{2,\eta_2} \leq c_9 \\ |D\Phi_{2,\eta_2}| &\leq c_{10} \end{aligned} \tag{4.46}$$

uniformly on \mathbb{R}^2 .

Step 3. Let $\ell \in \mathbb{N}$ be such that ε_ℓ is small enough to take the role of η_1 , and for every such ℓ let $q(\ell)$ be a large enough index such that $\varepsilon_{q(\ell)}$ can take the role η_2 . Assume without loss of generality, that $q : \mathbb{N} \rightarrow \mathbb{N}$ is some strictly increasing function, thus $q(\ell) \geq \ell$. Note also, that by the refinement property of $(\varepsilon_k)_k$ there holds $\frac{\varepsilon_\ell}{\varepsilon_{q(\ell)}} \in \mathbb{N}$ for all ℓ (recall that the author demanded $\frac{\eta_1}{\eta_2} \in \mathbb{N}$). For all but finitely many $\ell \in \mathbb{N}$ one can now define a function

$$\Phi_\ell : \Omega_{\varepsilon_\ell, \text{sliced}} \rightarrow \Omega_{\varepsilon_\ell, \text{perf}}, \quad \Phi_\ell := \Phi_{1,\varepsilon_\ell} \circ \Phi_{2,\varepsilon_{q(\ell)}}.$$

With the help of (4.44) one obtains, that $\Phi_{2,\varepsilon_{q(\ell)}}(\Omega_{\varepsilon_\ell, \text{sliced}}) = \Omega_{\varepsilon_\ell, \text{sliced}}$. Remembering, that by construction $\Phi_{1,\varepsilon_\ell}(\Omega_{\varepsilon_\ell, \text{sliced}}) = \Omega_{\varepsilon_\ell, \text{perf}}$, one infers, that Φ_ℓ is well-defined. It furthermore inherits the bijectivity property from $\Phi_{1,\varepsilon_\ell}$ and $\Phi_{2,\varepsilon_{q(\ell)}}$, and it is again continuous, piecewise affine, thus of the regularity $W^{1,\infty}(\Omega_{\varepsilon_\ell, \text{sliced}}; \mathbb{R}^2)$. By step 1, $\Phi_{1,\varepsilon_\ell}^{-1}$ is Lipschitz, as is $\Phi_{2,\varepsilon_{q(\ell)}}^{-1}$ by step 2, resulting in the Lipschitz-continuity of $\Phi_\ell^{-1} = \Phi_{2,\varepsilon_{q(\ell)}}^{-1} \circ \Phi_{1,\varepsilon_\ell}^{-1}$. A combination of (4.37) and (4.46) reveals

$$\begin{aligned} c_{11} &\leq \det D\Phi_\ell \leq c_{12} \\ |D\Phi_\ell| &\leq c_{13} \end{aligned} \tag{4.47}$$

uniformly on $\Omega_{\varepsilon_\ell, \text{sliced}}$, where c_{11}, c_{12}, c_{13} are some positive constants depending on $\partial\Omega, P_\psi$ and the fixed natural number M only. Recall, that by definition

$$\Omega_{\varepsilon_\ell, \text{sliced}} = \Omega \setminus \partial\mathcal{Q}_\ell,$$

where the author defined for convenience $\mathcal{Q}_\ell := \bigcup_{K \in \mathcal{K}_{\partial\Omega}(P_\psi)} \overline{Q_{\varepsilon_\ell, K}}$. One immediately realizes

$$\partial\mathcal{Q}_\ell \text{ is compact} \quad \text{and} \quad \mathcal{H}^1(\partial\mathcal{Q}_\ell) = \text{card}(\mathcal{K}_{\partial\Omega}(P_\psi)) \cdot 32\varepsilon_\ell < \infty.$$

To conclude, $\Phi_\ell : \Omega_{\varepsilon_\ell, \text{sliced}} \rightarrow \Omega_{\varepsilon_\ell, \text{perf}}$ is a pre-deformation in the sense of Proposition 4.4. From the very same Proposition one obtains, that for all but finitely many $\ell \in \mathbb{N}$ (i.e. all ℓ for which Φ_ℓ is defined), say $\ell \geq \ell_0$,

$$\psi_\ell := \psi \circ \Phi_\ell \in SBV^p(\Omega; \mathbb{R}^2) \cap \text{Kin}(\Omega; \mathbf{Box}).$$

In addition, Proposition 4.4 states, that

$$S_{\psi_\ell} \subseteq \Phi_\ell^{-1}(S_\psi \cap \Omega_{\varepsilon_\ell, \text{perf}}) \cup \partial \mathcal{Q}_\ell.$$

To further specify the discontinuity set S_{ψ_ℓ} , recall that by assumption $S_\psi \subseteq P_\psi$, thus

$$\begin{aligned} S_{\psi_\ell} &\subseteq \Phi_\ell^{-1}(P_\psi \cap \Omega_{\varepsilon_\ell, \text{perf}}) \cup \partial \mathcal{Q}_\ell \\ &= \Phi_{2, \varepsilon_{q(\ell)}}^{-1} \left(\Phi_{1, \varepsilon_\ell}^{-1} (P_\psi \cap \Omega_{\varepsilon_\ell, \text{perf}}) \right) \cup \partial \mathcal{Q}_\ell \\ &= \Phi_{2, \varepsilon_{q(\ell)}}^{-1} (P_\psi \setminus \mathcal{Q}_\ell) \cup \partial \mathcal{Q}_\ell \quad \text{by (4.38)} \\ &= \Phi_{2, \varepsilon_{q(\ell)}}^{-1} ((P_\psi \setminus \mathcal{Q}_\ell) \cup \partial \mathcal{Q}_\ell) \quad \text{by (4.42)} \\ &\stackrel{\text{Def}}{=} \Phi_{2, \varepsilon_{q(\ell)}}^{-1} (P_{1, \varepsilon_\ell}) \stackrel{\text{Def}}{=} P_{2, \varepsilon_{q(\ell)}}. \end{aligned}$$

Therefrom one infers first, that indeed $\psi_\ell \in \mathcal{V}^p(\Omega; \mathbb{R}^2) \cap \text{Kin}(\Omega; \mathbf{Box})$. Furthermore, for all $\ell \geq \ell_0$ one sets $P_\ell := P_{2, \varepsilon_{q(\ell)}}$ and obtains for P_ℓ the validity of

condition (i) from Lemma 4.5 w.r.t. the subsequence $(\varepsilon_{q(\ell)})_\ell$ by (4.41),

condition (ii) from Lemma 4.5 w.r.t. the subsequence $(\varepsilon_{q(\ell)})_\ell$ by (4.43),

condition (iii) from Lemma 4.5 by (4.45).

For the sake of completeness, for $\ell < \ell_0$ one could define ψ_ℓ like in step 4 of the proof of Lemma 4.6, with the three conditions above still being satisfied. Hence, in order to finish the proof, it remains to show that the above constructed sequence $(\psi_\ell)_\ell$ meets the convergences (4.32), (4.33) and (4.34). Before doing so in a fourth and final step, one should note that by construction $\Phi_\ell = \Phi_{1, \varepsilon_\ell} \circ \Phi_{2, \varepsilon_{q(\ell)}}$ equals the identity mapping on $\Omega \setminus (\mathcal{T}_{\varepsilon_{q(\ell)}} \cup \mathcal{Q}_\ell)$, resulting in

$$\psi_\ell \equiv \psi \quad \text{on } \Omega \setminus (\mathcal{T}_{\varepsilon_{q(\ell)}} \cup \mathcal{Q}_\ell). \quad (4.48)$$

Clearly, $\text{vol}(\mathcal{T}_{\varepsilon_{q(\ell)}} \cup \mathcal{Q}_\ell) \rightarrow 0$.

Step 4. As concerns the proof of (4.32) and (4.33), in view (4.48), estimate (4.47) and $\text{vol}(\mathcal{T}_{\varepsilon_{q(\ell)}} \cup \mathcal{Q}_\ell) \rightarrow 0$, one can proceed like in steps 4 and 5 of the proof of Lemma 4.6.

When proving the remaining convergence (4.34), one faces more difficulties, although they are mostly of notational nature. As a mean to partially overcome these, set

$$\Psi_\ell := \Psi_{2, \varepsilon_{q(\ell)}} \stackrel{\text{Def}}{=} \Phi_{2, \varepsilon_{q(\ell)}}^{-1}.$$

Now consider the surface integral

$$\begin{aligned}
& \int_{S_{\psi_\ell}} \phi(\nu_{\psi_\ell}) \cdot \theta(|\psi_\ell^+ - \psi_\ell^-|) d\mathcal{H}^1 = \int_{P_\ell \cap \Omega} \phi(\nu_{P_\ell}) \cdot \theta(|\psi_\ell^+ - \psi_\ell^-|) d\mathcal{H}^1 \\
& = \sum \left\{ \int_{\Psi_\ell(L) \cap \Omega} \phi(\nu_{\Psi_\ell(L)}) \cdot \theta(|\psi_\ell^+ - \psi_\ell^-|) d\mathcal{H}^1 : L \in \text{Face}(P_{1,\varepsilon_\ell}) \right\} \\
& = \sum \left\{ \int_{\Psi_\ell(L)} \phi(\nu_{\Psi_\ell(L)}) \cdot \theta(|\psi_\ell^+ - \psi_\ell^-|) d\mathcal{H}^1 : L \in \text{Face}(P_\psi \setminus \mathcal{Q}_\ell), L \subseteq \Omega \right\} \\
& + \sum \left\{ \int_{\Psi_\ell(L) \cap \Omega} \phi(\nu_{\Psi_\ell(L)}) \cdot \theta(|\psi_\ell^+ - \psi_\ell^-|) d\mathcal{H}^1 : L \in \text{Face}(\partial \mathcal{Q}_\ell) \right\} \\
& =: \text{Sum}_1 + \text{Sum}_2. \tag{4.49}
\end{aligned}$$

In order to deal with Sum_1 , one first realizes that $\Phi_{2,\varepsilon_{q(\ell)}}$ is by construction a coordinate transformation in the sense of Corollary 3.39 and obtains by means of the very same corollary the identity

$$\begin{aligned}
& \int_{\Psi_\ell(L)} \phi(\nu_{\Psi_\ell(L)}) \cdot \theta(|\psi_\ell^+ - \psi_\ell^-|) d\mathcal{H}^1 \\
& = \int_{\Psi_\ell(L)} \phi(\nu_{\Psi_\ell(L)}) \cdot \theta \left(\left| (\psi \circ \Phi_{1,\varepsilon_\ell})^+ \circ \Phi_{2,\varepsilon_{q(\ell)}} - (\psi \circ \Phi_{1,\varepsilon_\ell})^- \circ \Phi_{2,\varepsilon_{q(\ell)}} \right| \right) d\mathcal{H}^1
\end{aligned}$$

for all $L \in \text{Face}(P_\psi \setminus \mathcal{Q}_\ell)$, $L \subseteq \Omega$. Since Ψ_ℓ operates linearly on L , one easily writes further

$$\begin{aligned}
& \int_{\Psi_\ell(L)} \phi(\nu_{\Psi_\ell(L)}) \cdot \theta(|\psi_\ell^+ - \psi_\ell^-|) d\mathcal{H}^1 \\
& = \int_L \phi(\nu_{\Psi_\ell(L)} \circ \Psi_\ell) \cdot \theta \left(\left| (\psi \circ \Phi_{1,\varepsilon_\ell})^+ - (\psi \circ \Phi_{1,\varepsilon_\ell})^- \right| \right) \cdot \frac{\mathcal{H}^1(\Psi_\ell(L))}{\mathcal{H}^1(L)} d\mathcal{H}^1 \\
& = \int_L \phi(\nu_{\Psi_\ell(L)}) \cdot \theta(|\psi^+ - \psi^-|) \cdot \frac{\mathcal{H}^1(\Psi_\ell(L))}{\mathcal{H}^1(L)} d\mathcal{H}^1,
\end{aligned}$$

where one made use of the fact that $\nu_{\Psi_\ell(L)}$ is constant and $\Phi_{1,\varepsilon_\ell}$ equals the identity on $\Omega \setminus \mathcal{Q}_\ell \supseteq L$. Using this and the identity

$$\{L : L \in \text{Face}(P_\psi \setminus \mathcal{Q}_\ell), L \subseteq \Omega\} = \{L \setminus \mathcal{Q}_\ell : L \in \text{Face}(P_\psi), L \cap \Omega \neq \emptyset\},$$

one can write Sum_1 as

$$\begin{aligned}
\text{Sum}_1 = & \sum_{L \in \text{Face}(P_\psi), L \cap \Omega \neq \emptyset} \int_{L \setminus \mathcal{Q}_\ell} \phi(\nu_{\Psi_\ell(L \setminus \mathcal{Q}_\ell)}) \cdot \theta(|\psi^+ - \psi^-|) \\
& \cdot \frac{\mathcal{H}^1(\Psi_\ell(L \setminus \mathcal{Q}_\ell))}{\mathcal{H}^1(L \setminus \mathcal{Q}_\ell)} d\mathcal{H}^1.
\end{aligned}$$

Moreover, one realizes for any $L \in \text{Face}(P_\psi)$, $L \cap \Omega \neq \emptyset$

$$\begin{aligned} \nu_{\Psi_\ell(L \setminus \mathcal{Q}_\ell)} &\rightarrow \nu_L, \\ \frac{\mathcal{H}^1(\Psi_\ell(L \setminus \mathcal{Q}_\ell))}{\mathcal{H}^1(L \setminus \mathcal{Q}_\ell)} &\rightarrow 1, \\ \mathbb{1}_{L \setminus \mathcal{Q}_\ell} &\rightarrow \mathbb{1}_L \quad \text{pointwise.} \end{aligned}$$

Eventually in the limit ℓ tends to ∞ there holds for Sum_1

$$\text{Sum}_1 \rightarrow \sum_{L \in \text{Face}(P_\psi), L \cap \Omega \neq \emptyset} \int_L \phi(\nu_L) \theta(|\psi^+ - \psi^-|) d\mathcal{H}^1 \quad (4.50)$$

$$= \int_{S_\psi} \phi(\nu_\psi) \theta(|\psi^+ - \psi^-|) d\mathcal{H}^1. \quad (4.51)$$

The proof of (4.34) would be finished, if only $\text{Sum}_2 \rightarrow 0$. This though is easy to show, since by (4.42)

$$\Psi_\ell(\partial\mathcal{Q}_\ell) \cap \Omega \subseteq \partial\mathcal{Q}_\ell,$$

hence Sum_2 can be estimated like

$$\begin{aligned} \text{Sum}_2 &\leq \sup_{\nu \in S^1} |\phi(\nu)| \cdot \theta(\text{diam } \mathbf{Box}) \cdot \mathcal{H}^1(\Psi_\ell(\partial\mathcal{Q}_\ell) \cap \Omega) \\ &\leq \sup_{\nu \in S^1} |\phi(\nu)| \cdot \theta(\text{diam } \mathbf{Box}) \cdot \mathcal{H}^1(\partial\mathcal{Q}_\ell) \\ &= \sup_{\nu \in S^1} |\phi(\nu)| \cdot \theta(\text{diam } \mathbf{Box}) \cdot \text{card}(\mathcal{K}_{\partial\Omega}(P_\psi)) \cdot 32\varepsilon_\ell \\ &\rightarrow 0. \end{aligned}$$

All in all one obtains from (4.49), (4.51) and the last convergence

$$\int_{S_{\psi_\ell}} \phi(\nu_{\psi_\ell}) \theta(|\psi_\ell^+ - \psi_\ell^-|) d\mathcal{H}^1 \rightarrow \int_{S_\psi} \phi(\nu_\psi) \theta(|\psi^+ - \psi^-|) d\mathcal{H}^1,$$

as ℓ tends to ∞ , i.e. the continuity (4.34) and the lemma is eventually proved. \square

As indicated prior to the statement of the last lemma, one finally shows the claim of Lemma 4.5 by carefully diagonalizing the sequences obtained in Lemmas 4.7 and 4.8. The diagonalization argument being somewhat lengthy, the author splits it up into the three steps found below.

Step 1. Let $(\psi_j)_j$ be the φ -approximating sequence from Lemma 4.7. Since every ψ_j satisfies the assumption of Lemma 4.8, take in the sense of this lemma for every ψ_j an approximating sequence $(\psi_{j,\ell})_\ell$, associated with a subsequence $(\varepsilon_{q_j(\ell)})_\ell$ and polyhedral sets $(P_{j,\ell})_\ell$. Recall, that for every $j \in \mathbb{N}$ the $(P_{j,\ell})_\ell$ satisfy

the conditions (i), (ii), (iii) from Lemma 4.5 w.r.t. the sequence $(\varepsilon_{q_j(\ell)})_\ell$, where $q_j : \mathbb{N} \rightarrow \mathbb{N}$ is a strictly increasing index function, thus $q_j(\ell) \geq \ell$ for every $\ell \in \mathbb{N}$.

Define the quantity

$$\begin{aligned} c_{j,\ell} := & \|\psi_j - \varphi\|_{L^1(\Omega; \mathbb{R}^2)} + \left| \int_{\Omega} W(\nabla \psi_j) \, dx - \int_{\Omega} W(\nabla \varphi) \, dx \right| \\ & + \left| \int_{S_{\psi_j}} \phi(\nu_{\psi_j}) \theta(|\psi_j^+ - \psi_j^-|) \, d\mathcal{H}^1 - \int_{S_{\varphi}} \phi(\nu_{\varphi}) \theta(|\varphi^+ - \varphi^-|) \, d\mathcal{H}^1 \right| \\ & + \|\psi_{j,\ell} - \psi_j\|_{L^1(\Omega; \mathbb{R}^2)} + \left| \int_{\Omega} W(\nabla \psi_{j,\ell}) \, dx - \int_{\Omega} W(\nabla \psi_j) \, dx \right| \\ & + \left| \int_{S_{\psi_{j,\ell}}} \phi(\nu_{\psi_{j,\ell}}) \theta(|\psi_{j,\ell}^+ - \psi_{j,\ell}^-|) \, d\mathcal{H}^1 - \int_{S_{\psi_j}} \phi(\nu_{\psi_j}) \theta(|\psi_j^+ - \psi_j^-|) \, d\mathcal{H}^1 \right| \\ & + \varepsilon_{q_j(\ell)}. \end{aligned}$$

By Lemmas 4.7 and 4.8 one obtains

$$\lim_{j \rightarrow \infty} \left(\lim_{\ell \rightarrow \infty} c_{j,\ell} \right) = 0.$$

With the help of [Attouch, 1984, Corollary 1.18] one can now choose an index function $j : \mathbb{N} \rightarrow \mathbb{N}$, increasing to ∞ such that

$$\lim_{\ell \rightarrow \infty} c_{j(\ell),\ell} = 0.$$

Step 2. Since $q_j(\ell)(\ell) \geq \ell$ for every $\ell \in \mathbb{N}$, one infers $q_j(\ell)(\ell) \rightarrow \infty$ as ℓ increases. In particular, there is a subsequence $(\ell(m))_m$ such that

$$k(m) := q_j(\ell(m))(\ell(m))$$

is strictly increasing. The reader is asked to note the identity

$$\varepsilon_{k(m)} = \varepsilon_{q_j(\ell(m))(\ell(m))}, \quad (4.52)$$

which follows by definition.

Step 3. Declare for every $m \in \mathbb{N}$ the deformation

$$\varphi_m := \psi_{j(\ell(m)),\ell(m)} \in \mathcal{V}^p(\Omega; \mathbb{R}^2) \cap \text{Kin}(\Omega; \mathbf{Box}).$$

and the polyhedral set

$$P_m := P_{j(\ell(m)),\ell(m)}.$$

Now by Lemma 4.8 one infers first

$$\begin{aligned} \text{Knot}(P_m) \cap \Omega &\stackrel{\text{Def}}{=} \text{Knot}(P_{j(\ell(m)), \ell(m)}) \cap \Omega \\ &\subseteq \varepsilon_{q_j(\ell(m)), \ell(m)} \mathbb{Z}^2 \quad \text{by Lemma 4.8} \\ &= \varepsilon_{k(m)} \mathbb{Z}^2 \quad \text{by (4.52)}. \end{aligned}$$

Similarly one realizes by Lemma 4.8, that

$$\text{for all } L \in \text{Face}(P_m) \text{ with } \text{dist}(L, \partial\Omega) = 0 \text{ there holds } L \subseteq \varepsilon_{k(m)} \partial\mathcal{D}_2$$

and

$$P_m \text{ satisfies condition (iii) from Lemma 4.5.}$$

To conclude, the sequence of deformations $(\varphi_m)_m$ in $\mathcal{V}^p(\Omega; \mathbb{R}^2) \cap \text{Kin}(\Omega; \mathbf{Box})$ together with the subsequence $(\varepsilon_{k(m)})_m$ and the polyhedral sets $(P_m)_m$ satisfy the conditions (i), (ii), (iii) of Lemma 4.5. Finally, an application of the triangle inequality results in

$$\begin{aligned} &\|\varphi_m - \varphi\|_{L^1(\Omega; \mathbb{R}^2)} + \left| \int_{\Omega} W(\nabla \varphi_m) \, dx - \int_{\Omega} W(\nabla \varphi) \, dx \right| \\ &\quad + \left| \int_{S_{\varphi_m}} \phi(\nu_{\varphi_m}) \theta(|\varphi_m^+ - \varphi_m^-|) \, d\mathcal{H}^1 - \int_{S_{\varphi}} \phi(\nu_{\varphi}) \theta(|\varphi^+ - \varphi^-|) \, d\mathcal{H}^1 \right| \\ &\leq c_{j(\ell(m)), \ell(m)} \xrightarrow{m \rightarrow \infty} 0 \end{aligned}$$

and the proof of Lemma 4.5 is finished. \square

4.3.4 Improving Γ -convergence to more general deformations

Falling back to Proposition 3.7, an immediate consequence of Theorem 4.1 is, that the Γ -lim sup-inequality holds for every $\varphi \in SBV^p(\Omega; \mathbb{R}^2) \cap \text{Kin}(\Omega; \mathbf{Box})$, for which

there is a sequence $(\varphi_k)_k$ in $\mathcal{V}^p(\Omega; \mathbb{R}^2) \cap \text{Kin}(\Omega; \mathbf{Box})$ such that

$$\begin{aligned} \text{(i)} \quad &\varphi_k \rightarrow \varphi \quad \text{in } L^1(\Omega; \mathbb{R}^2), \\ \text{(ii)} \quad &\mathcal{F}_{\text{Hom}}(\varphi) \geq \liminf_{k \rightarrow \infty} \mathcal{F}_{\text{Hom}}(\varphi_k). \end{aligned} \tag{4.53}$$

In view of the unanswered density of $\mathcal{V}^p(\Omega; \mathbb{R}^2) \cap \text{Kin}(\Omega; \mathbf{Box})$ or of subclasses of even more regular deformations in $SBV^p(\Omega; \mathbb{R}^2) \cap \text{Kin}(\Omega; \mathbf{Box})$ (see Remark 3.10), it is up to now not clear to the author, which deformations in $SBV^p(\Omega; \mathbb{R}^2) \cap$

$\text{Kin}(\Omega; \mathbf{Box})$ satisfy (4.53). However, the next lemma will reveal that (4.53) holds true for the physically relevant, observable deformations. That is, for all deformations $\varphi \in SBV^p(\Omega; \mathbb{R}^2) \cap \text{Kin}(\Omega; \mathbf{Box})$ having their discontinuity set S_φ contained in an in Ω piecewise C^1 -hypersurface S (cf. Definition 3.37).

Lemma 4.9. *Suppose the assumptions of Theorem 4.1 to be valid. Let $\varphi \in SBV^p(\Omega; \mathbb{R}^2) \cap \text{Kin}(\Omega; \mathbf{Box})$ be such that S_φ is contained in an in Ω piecewise C^1 -hypersurface S , and furthermore $\mathcal{F}_{\text{Hom}}(\varphi) < \infty$. Then there is a sequence $(\varphi_k)_k$ in $\mathcal{V}^p(\Omega; \mathbb{R}^2) \cap \text{Kin}(\Omega; \mathbf{Box})$ such that*

$$\varphi_k \rightarrow \varphi \quad \text{in } L^1(\Omega; \mathbb{R}^2), \quad (4.54)$$

and

$$\lim_{k \rightarrow \infty} \int_{\Omega} W(\nabla \varphi_k) \, dx = \int_{\Omega} W(\nabla \varphi) \, dx, \quad (4.55)$$

$$\lim_{k \rightarrow \infty} \int_{S_{\varphi_k}} \phi(\nu_{\varphi_k}) \theta(|\varphi_k^+ - \varphi_k^-|) \, d\mathcal{H}^1 = \int_{S_\varphi} \phi(\nu_\varphi) \theta(|\varphi^+ - \varphi^-|) \, d\mathcal{H}^1. \quad (4.56)$$

Inferring therefrom by the arguments above the validity of the Γ -lim sup-inequality for all $SBV^p(\Omega; \mathbb{R}^2) \cap \text{Kin}(\Omega; \mathbf{Box})$ -deformations having their discontinuity set contained in an in Ω piecewise C^1 -hypersurface, one arrives at the following corollary.

Corollary 4.10 (Homogenization of the 2D-structure II). *Under the assumptions of Theorem 4.1, in all $\varphi \in SBV^p(\Omega; \mathbb{R}^2) \cap \text{Kin}(\Omega; \mathbf{Box})$, such that S_φ is contained in an in Ω piecewise C^1 -hypersurface, one has Γ -convergence of the $(\mathcal{F}_{\varepsilon_k})_k$ to \mathcal{F}_{Hom} w.r.t. the strong $L^1(\Omega; \mathbb{R}^2)$ -topology, i.e.*

$$\left(\Gamma\text{-}\lim_{k \rightarrow \infty} \mathcal{F}_{\varepsilon_k} \right) (\varphi) = \mathcal{F}_{\text{Hom}}(\varphi).$$

As concerns the missing proof of Lemma 4.9, the author will not go into its details, but only sketch it here. This is because it is again based on the use of pre-deformations in the sense of Proposition 4.3, and follows steps similar to the ones in the proof of Lemma 4.8.

Sketch of the proof of Lemma 4.9. For the sake of clarity, also the present proof will be two-stage.

Step 1. One constructs an appropriate pre-deformation $\Phi_\eta : \Omega \rightarrow \Omega$ in the sense of Proposition 4.3 and parametrized by a small parameter $\eta > 0$, with the property that it

- only differs in a small environment \mathcal{T}_η of S from the identity mapping, where $\text{vol } \mathcal{T}_\eta \rightarrow 0$ as η tends to zero,

- is such that $\Phi_\eta^{-1}(S) \subseteq P_\eta$ for some polyhedral set P_η ,
- satisfies for some η -independent positive constants c_1, c_2, c_3 the estimate

$$\begin{aligned} c_1 &\leq \det D\Phi_\eta \leq c_2 \\ |D\Phi_\eta| &\leq c_3 \end{aligned} \quad (4.57)$$

uniformly on Ω .

The construction of Φ_η is done as follows. Since S is piecewise C^1 in Ω , in the sense of Definition 3.36 let there be given finitely many bounded intervals $(0, a_i)$, as well as $g_i \in C^1([0, a_i])$, $Q_i \in \text{SO}(2)$ and $b_i \in \mathbb{R}^2$, $i = 1, \dots, \ell$. Let S_i be defined as in Definition 3.36, i.e.

$$S_i := \left\{ Q_i \begin{bmatrix} \xi_1 \\ g_i(\xi_1) \end{bmatrix} + b_i : \xi_1 \in [0, a_i] \right\}.$$

For sufficiently small $\delta > 0$, by $P_\delta g_i$ one denotes the piecewise linear interpolation of g_i for the set of nodes $\{0, \delta, 2\delta, \dots, a_i - \delta, a_i\}$. By Definition 3.37 of being piecewise C^1 in Ω , $\mathbb{R}^N \setminus (\partial\Omega \cup S)$ satisfies the cone condition, thus one finds positive constants $\lambda_{i,\pm,l}, \lambda_{i,\pm,r}$ only depending on S and $\partial\Omega$, such that for small enough $\eta > 0$ the environments $(i = 1, \dots, \ell)$

$$\begin{aligned} \mathcal{T}_{\eta,i} := & \left\{ (\xi_1, \xi_2) : \xi_1, \xi_2 \in \mathbb{R} \right. \\ & -\lambda_{i,-,l}\xi_1 + g_i(0) < \xi_2 < \lambda_{i,+,l}\xi_1 + g_i(0) \\ & g_i(a_i) + \lambda_{i,-,r}(\xi_1 - a_i) < \xi_2 < g_i(a_i) + \lambda_{i,+,r}(a_i - \xi_1) \\ & (P_{\eta^2}g_i)(\xi_1) - \eta < \xi_2 < (P_{\eta^2}g_i)(\xi_1) + \eta \left. \right\} \end{aligned}$$

satisfy $Q_i\mathcal{T}_{\eta,i} + b_i \subseteq \Omega$ and are pairwise disjoint. Since the pre-deformation Φ_η given below differs from the identity mapping only on the pairwise disjoint $Q_i\mathcal{T}_{\eta,i} + b_i$, its construction can be performed individually for every $\mathcal{T}_{\eta,i}$. Henceforth, the author will without loss of generality assume $\ell = 1$, $Q_1 = I$, $b_1 = 0$ and drop the index i .

The action of $\Phi_\eta|_{\mathcal{T}_\eta} : \mathcal{T}_\eta \rightarrow \mathcal{T}_\eta$ is now illustrated in Figure 4.15. Indeed, each vertical fibre connecting the upper (lower) boundary of \mathcal{T}_η and the graph of $P_{\eta^2}g$ is homogeneously stretched by Φ_η , such that afterwards it connects the upper (lower) boundary of \mathcal{T}_η and the graph of g . Constructed in this manner, Φ_η is certainly bijective and has a positive Jacobian determinant. Using elementary calculus, it is moreover not difficult to verify the existence of η -independent positive constants c_1, c_2, c_3 , such that one obtains the validity of estimate (4.57) uniformly on \mathcal{T}_η . Also apparent from the construction is, that Φ_η is a pre-deformation in the sense of Proposition 4.3 and that Φ_η equals the identity mapping on $\partial\mathcal{T}_\eta$. One

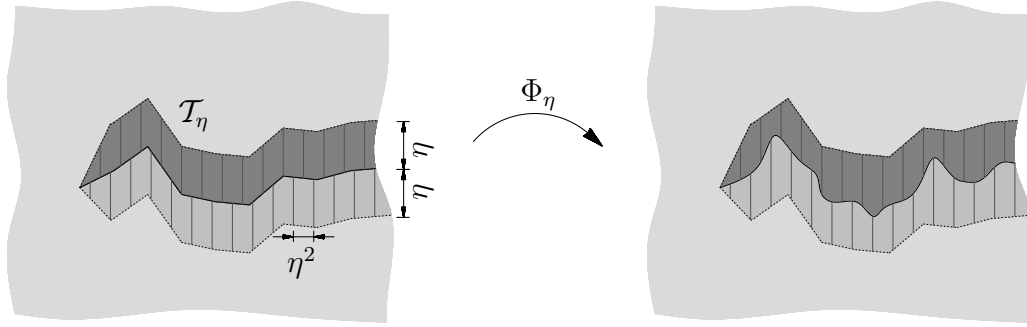

Figure 4.15: The pre-deformation $\Phi_\eta|_{\mathcal{T}_\eta} : \mathcal{T}_\eta \rightarrow \mathcal{T}_\eta$

therefore assumes Φ_η to be extended by the identity to the remaining parts of Ω , with estimate (4.57) remaining valid on the whole of Ω and Φ_η still being a pre-deformation mapping Ω onto Ω .

Step 2. For all but finitely many $k \in \mathbb{N}$, the quantity $\frac{1}{k}$ is small enough to take the role of η from the first step. Hence, for all but finitely many $k \in \mathbb{N}$ one sets

$$\varphi_k := \varphi \circ \Phi_{1/k} \quad \text{and} \quad P_k := \Phi_{1/k}^{-1}(S)$$

and infers by Proposition 4.3, that indeed $\varphi_k \in SBV^p(\Omega; \mathbb{R}^2) \cap \text{Kin}(\Omega; \mathbf{Box})$ as well as $S_{\varphi_k} = \Phi_{1/k}^{-1}(S_\varphi) \subseteq P_k$ by means of Proposition 3.23. By construction however $P_k = \Phi_{1/k}^{-1}(S)$ equals the graph of $P_{1/k^2}g$ over $[0, a]$, which is a polyhedral set. Hence P_k is polyhedral, and by definition $\varphi_k \in \mathcal{V}^p(\Omega; \mathbb{R}^2) \cap \text{Kin}(\Omega; \mathbf{Box})$.

In view of the validity of estimate (4.57) for $\Phi_{1/k}$ on Ω , one now proceeds like in step 4 and 5 of the proof of Lemma 4.6 to show (4.54) and (4.55).

In order to prove (4.56), one employs Corollary 3.39 and assumption ($\theta 3$) to first write

$$\int_{S_{\varphi_k}} \phi(\nu_{\varphi_k}) \theta(|\varphi_k^+ - \varphi_k^-|) d\mathcal{H}^1 = \int_{P_k} \phi(\nu_{P_k}) \theta(|(\varphi^+ - \varphi^-) \circ \Phi_{1/k}|) d\mathcal{H}^1. \quad (4.58)$$

Since P_k equals the graph of $P_{1/k^2}g$ over $[0, a]$, it is in particular parametrized by

$[0, a] \ni s \mapsto [s, (P_{1/k^2}g)(s)]^T$. Thus the latter integral reads as

$$\begin{aligned}
& \int_{P_k} \phi(\nu_{P_k}) \theta(|(\varphi^+ - \varphi^-) \circ \Phi_{1/k}|) \, d\mathcal{H}^1 \\
&= \int_{(0,a)} \phi(\nu_{P_k}(s, (P_{1/k^2}g)(s))) \\
&\quad \cdot \theta(|(\varphi^+ - \varphi^-) \circ \Phi_{1/k} \circ (s, (P_{1/k^2}g)(s))|) \\
&\quad \cdot \sqrt{1 + D(P_{1/k^2}g)(s)^2} \, ds. \tag{4.59}
\end{aligned}$$

Thanks to the C^1 -regularity of g one deduces $P_{1/k^2}g \rightarrow g$, $D(P_{1/k^2}g) \rightarrow Dg$ and $\nu_{P_k}(\cdot, (P_{1/k^2}g)(\cdot)) \rightarrow \nu_S(\cdot, g(\cdot))$ uniformly on $(0, a)$. This together with the continuity of ϕ and the construction-conditioned identity $\Phi_{1/k}(\cdot, (P_{1/k^2}g)(\cdot)) = (\cdot, g(\cdot))$ implies

$$\begin{aligned}
& \int_{(0,a)} \phi(\nu_{P_k}(s, (P_{1/k^2}g)(s))) \\
&\quad \cdot \theta(|(\varphi^+ - \varphi^-) \circ \Phi_{1/k} \circ (s, (P_{1/k^2}g)(s))|) \\
&\quad \cdot \sqrt{1 + D(P_{1/k^2}g)(s)^2} \, ds \\
&\rightarrow \int_{(0,a)} \phi(\nu_S(s, g(s))) \\
&\quad \cdot \theta(|(\varphi^+ - \varphi^-) \circ (s, g(s))|) \\
&\quad \cdot \sqrt{1 + Dg(s)^2} \, ds \\
&= \int_S \phi(\nu_S) \theta(|\varphi^+ - \varphi^-|) \, d\mathcal{H}^1 = \int_{S_\varphi} \phi(\nu_\varphi) \theta(|\varphi^+ - \varphi^-|) \, d\mathcal{H}^1.
\end{aligned}$$

Finally, (4.56) is easily inferred by combining (4.58), (4.59) and the just established convergence. \square

4.3.5 Mathematical discussion and mechanical interpretation

From a mathematical point of view, the main weakness of the Γ -convergence study performed in the preceding subsections is, that the author proved the validity of the Γ -lim sup-inequality for \mathcal{F}_{Hom} only for $SBV^p(\Omega; \mathbb{R}^2) \cap \text{Kin}(\Omega; \mathbf{Box})$ -deformations with in Ω piecewise C^1 -regular discontinuity sets. With \mathcal{F}_{Hom} satisfying the Γ -lim inf-inequality on the whole of $SBV^p(\Omega; \mathbb{R}^2) \cap \text{Kin}(\Omega; \mathbf{Box})$, this gives at least Γ -convergence of the $(\mathcal{F}_{\varepsilon_k})_k$ to \mathcal{F}_{Hom} on this subclass of deformations, see Corollary 4.10. On the remaining part of $SBV^p(\Omega; \mathbb{R}^2) \cap \text{Kin}(\Omega; \mathbf{Box})$, possible Γ -convergence is not understood yet. However, the homogenized total energy \mathcal{F}_{Hom} exhibits the following properties.

Proposition 4.11. *Let the assumptions of Theorem 4.1 hold and \mathcal{F}_{Hom} be given as in (4.5). Then*

- (i) \mathcal{F}_{Hom} is sequentially lower semicontinuous w.r.t. the strong $L^1(\Omega; \mathbb{R}^2)$ -topology,
- (ii) there is a minimizer of \mathcal{F}_{Hom} on $SBV^p(\Omega; \mathbb{R}^2) \cap \text{Kin}(\Omega; \mathbf{Box})$.

Proof. The assertion of the proposition immediately follows from Corollary 3.30, upon setting therein $M := SBV^p(\Omega; \mathbb{R}^2)$ and $\hat{F} := 0$. \square

First one deduces from this result, that the homogenized total energy \mathcal{F}_{Hom} does not need to be relaxed. Furthermore, with the sequential lower semicontinuity w.r.t. the strong $L^1(\Omega; \mathbb{R}^2)$ -topology, \mathcal{F}_{Hom} possesses a necessary feature any Γ -limit is supposed to have (see Corollary 3.5), rendering it even more a candidate for a Γ -limit of the sequence $(\mathcal{F}_{\varepsilon_k})_k$.

As said before, a Cortesani and Toader [1999]-like result, stating appropriate density of e.g. $SBV^p(\Omega; \mathbb{R}^2) \cap \text{Kin}(\Omega; \mathbf{Box})$ -deformations with in Ω piecewise C^1 -regular discontinuity sets within $SBV^p(\Omega; \mathbb{R}^2) \cap \text{Kin}(\Omega; \mathbf{Box})$, still remains to be proved. Because of this lack of information, it is not clear how to show the Γ -lim sup-inequality for \mathcal{F}_{Hom} on the whole of $SBV^p(\Omega; \mathbb{R}^2) \cap \text{Kin}(\Omega; \mathbf{Box})$, making the present Γ -convergence results for the sequence $(\mathcal{F}_{\varepsilon_k})_k$ in view of the current state of research more or less the best one can achieve, cf. Braides [2009].

However, the author finds it worth noting, that the homogenization of prescribed crack geometries performed in the present section is to his knowledge the first homogenization carried out in the setting of geometrically nonlinear elasticity under global noninterpenetration, i.e. injectivity constraints. To this end, an appropriate technique (pre-deformations) to manipulate or approximate given a.e.-injective deformations within $SBV^p(\Omega; \mathbb{R}^N)$ while conserving the kinematic constraints was introduced by the author.

Before turning to the mechanical interpretation of the obtained homogenization result, the author reminds the reader not to think of Ω_{ε_k} as a many-body structure, which engineers use in real life. If however one decides to build such an object Ω_{ε_k} , the present analysis states that as its constituents become smaller and smaller, the through \mathcal{F}_{Hom} characterized homogenized body of shape Ω could with finite energy undergo all $SBV^p(\Omega; \mathbb{R}^2) \cap \text{Kin}(\Omega; \mathbf{Box})$ -deformations with in Ω piecewise C^1 -regular discontinuity set. Thus, it may disintegrate and form fragments of nearly arbitrary shape, each of which possesses the same elastic properties like the constituents of the many-body structures Ω_{ε_k} . In accordance with the heuristic considerations at the beginning of this section, the surface energy density within the homogenized total energy \mathcal{F}_{Hom} is anisotropic, with the anisotropy being completely determined by the original microstructure \mathcal{D}_2 . The

magnitude of this effect is measured by the quantity (cf. [Negri, 1999, Remark 3.2])

$$a := \frac{\max\{\phi(\nu) : |\nu| = 1\}}{\min\{\phi(\nu) : |\nu| = 1\}} = \sqrt{2},$$

revealing the fracture behaviour in the homogenized body to be strongly anisotropic. Observe, that the horizontal and vertical cracks are those which are energetically privileged within the homogenized body ($\phi(\pm e_1) = \phi(\pm e_2) = 1$), whereas sloped cracks of the same length and opening width exhibit up to $\approx 41\%$ higher crack energy ($\phi(\sqrt{2}^{-1}[1, 1]^T) = \sqrt{2}$).

4.4 HOMOGENIZATION OF THE 3D-STRUCTURE: ZERO CORD-ANGLE

Again the reader might recall the geometry of the three-dimensional many-body structure with zero cord-angle and the corresponding notation, as they were introduced in Definition of Geometry 2.2 and depicted in Figure 2.4. The reader is also encouraged to remind himself of the definition of \mathcal{F}_ε as given in (4.1) and Remark 4.1.

4.4.1 Heuristic derivation and Γ -convergence statement

Let $(\varepsilon_k)_k$ be a refining, vanishing sequence of positive real numbers, $\mathcal{F}_{\varepsilon_k}$ be associated with the three-dimensional many-body structure Ω_{ε_k} with zero cord-angle and defined as in (4.1). Like in the heuristic derivation of the homogenization limit for the 2D many-body structure found in Subsection 4.3.1, on the search for the Γ -limit of the $(\mathcal{F}_{\varepsilon_k})_k$ one has to ask the following. Given a deformation in $SBV^p(\Omega; \mathbb{R}^3) \cap \text{Kin}(\Omega; \mathbf{Box})$, what is the smallest energy one can approximate this deformation with by means of deformations taken from the domains of $(\mathcal{F}_{\varepsilon_k})_k$.

To give an answer, one starts with the simple observation that deformations of the many-body structures Ω_{ε_k} can only exhibit crack surfaces, which are oriented parallelly to the beams Ω_{ε_k} is assembled of, all others causing infinite energy. Hence, one expects that only those deformations $\varphi \in SBV^p(\Omega; \mathbb{R}^3) \cap \text{Kin}(\Omega; \mathbf{Box})$ can be approximated with finite energy along $(\mathcal{F}_{\varepsilon_k})_k$, the discontinuity sets of which are also parallel to the beam orientations in Ω_{ε_k} . In view of Definition of Geometry 2.2, these are all $\varphi \in SBV^p(\Omega; \mathbb{R}^3) \cap \text{Kin}(\Omega; \mathbf{Box})$ with $\nu_{\varphi,1} = 0$ \mathcal{H}^2 -a.e. on S_φ .

Analogously to the heuristics in Subsection 4.3.1, in order to identify the homogenized energy densities the author performs a local consideration for a defor-

mation $\varphi \in SBV^p(\Omega; \mathbb{R}^3) \cap \text{Kin}(\Omega; \mathbf{Box})$ with sufficiently regular discontinuity set S_φ and – according to the just said – with $\nu_{\varphi,1} = 0$ on S_φ .

Homogenized elastic energy. By the same arguments that led the author in Subsection 4.3.1 to the homogenized elastic energy for the 2D many-body structure, one also realizes in the present case, that the least elastic energy one can approximate the deformation φ with when passing through the domains of $(\mathcal{F}_{\varepsilon_k})_k$ is again

$$\int_{\Omega} W(\nabla\varphi) \, dx. \quad (4.60)$$

Homogenized surface energy. Let $x_0 \in S_\varphi$ and consider a plane area element of S_φ around x_0 of area $d\mathcal{H}^2(x_0)$ and oriented by $\nu_\varphi(x_0)$, cf. Figure 4.16. Recall, that $\nu_{\varphi,1} = 0$ on S_φ . Again one poses the question, which is the minimal

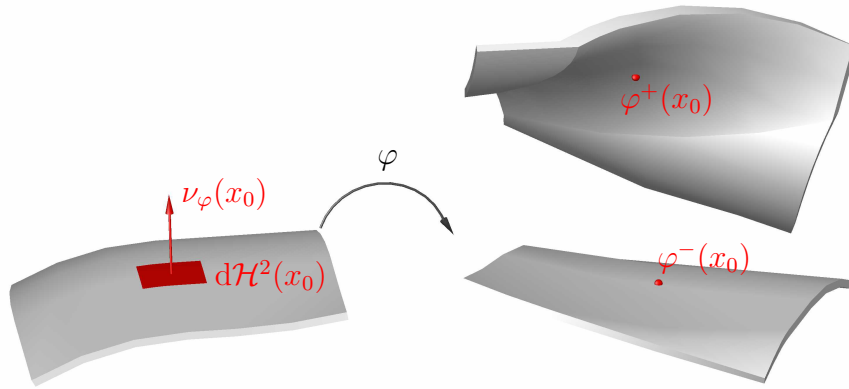

Figure 4.16: Geometry of the discontinuity set S_φ , locally around x_0

energy one can imitate the jump of φ around x_0 with, when approximating φ with deformations taken from the $W^{1,p}(\Omega_{\varepsilon_k}; \mathbb{R}^3) \cap \text{Kin}(\Omega; \mathbf{Box})$, $k \in \mathbb{N}$, i.e. with deformations that may only have jumps on $\varepsilon_k \partial\mathcal{D}_3 = \mathbb{R} \times \varepsilon_k \partial\mathcal{D}_2$. Again note, that these are the deformations, a many-body structure Ω_{ε_k} can undergo with finite energy. One falls back to the simpler question of how to approximate a plane rectangle A in \mathbb{R}^3 along the scaled down set $\partial\mathcal{D}_3$, when the first component of its normal ν is 0. Observe, that such A is parallel to $\partial\mathcal{D}_3 = \mathbb{R} \times \partial\mathcal{D}_2$. Let A be as shown in Figure 4.17. An approximation of its e_1 -orthogonal base line (which includes an angle α with the x_1x_2 -plane) like in the heuristic derivation of the homogenized surface energy for the 2D many-body structure (see Subsection 4.3.1) gives a folded surface on the scaled down set $\partial\mathcal{D}_3$ of area

$$(|\sin \alpha| + |\cos \alpha|) \cdot \text{“area of } A\text{”} = (|\nu_2| + |\nu_3|) \cdot \text{“area of } A\text{”}.$$

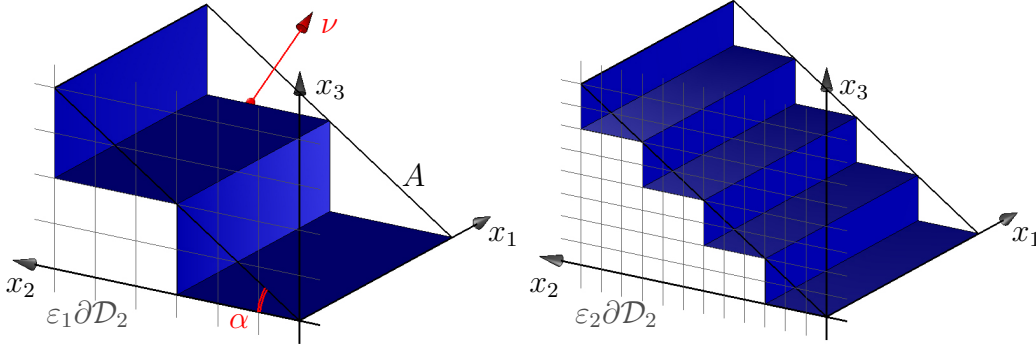

Figure 4.17: Approximation of an area element along the scaled mesh $\partial\mathcal{D}_3$

With the opening of a crack on Γ_{C,ε_k} of area da and opening width t coming at an energetic cost of $\theta(t) da$, one again infers that the least surface energy, with which one can approximate the jump $(\varphi^+(x_0), \varphi^-(x_0), \nu_\varphi(x_0))$ across the plane area element $d\mathcal{H}^2(x_0)$ around x_0 with orientation $\nu_\varphi(x_0)$ is

$$\theta(|\varphi^+(x_0) - \varphi^-(x_0)|) \cdot (|\nu_{\varphi,2}(x_0)| + |\nu_{\varphi,3}(x_0)|) d\mathcal{H}^2(x_0).$$

Consequently, the smallest surface energy needed to approximate the discontinuity set S_φ with deformations from the $W^{1,p}(\Omega_{\varepsilon_k}; \mathbb{R}^3) \cap \text{Kin}(\Omega; \mathbf{Box})$ can be expected to be

$$\int_{S_\varphi} (|\nu_{\varphi,2}| + |\nu_{\varphi,3}|) \cdot \theta(|\varphi^+ - \varphi^-|) d\mathcal{H}^2. \quad (4.61)$$

Homogenized total energy. Regarding the results of Theorem 4.1, one may expect that the additive decomposition of the total energy in an elastic energy and a surface energy transfers again into a possible Γ -limit of the $(\mathcal{F}_{\varepsilon_k})_k$. Then the above heuristics (4.60) and (4.61) give rise to introduce the *homogenized total energy*

$$\mathcal{F}_{\text{Hom}} : SBV^p(\Omega; \mathbb{R}^3) \cap \text{Kin}(\Omega; \mathbf{Box}) \rightarrow [0, \infty],$$

defined as

$$\mathcal{F}_{\text{Hom}}(\varphi) := \begin{cases} \int_{\Omega} W(\nabla\varphi) dx + \int_{S_\varphi} \phi(\nu_\varphi)\theta(|\varphi^+ - \varphi^-|) d\mathcal{H}^2 & \text{if } \nu_{\varphi,1} = 0 \text{ } \mathcal{H}^2\text{-a.e. on } S_\varphi, \\ \infty & \text{else} \end{cases} \quad (4.62)$$

The *anisotropy factor* ϕ generated by the microstructure \mathcal{D}_3 is therein given by

$$\phi : S^2 \rightarrow [0, \infty), \quad \phi(v) := |v_2| + |v_3|.$$

A rigorous justification of the heuristic above is now given in the sense of Γ -convergence in the next theorem, posing as the main homogenization result for the three-dimensional many-body structure with zero cord-angle.

Theorem 4.12 (Homogenization of the 3D-structure with zero cord-angle I). *Let $(\varepsilon_k)_k$ be a refining, vanishing sequence of positive real numbers and $\Omega, \Omega_{\varepsilon_k}, \Gamma_{C, \varepsilon_k}$ like in Definition of Geometry 2.2. Suppose the elastic energy density W to be in accordance with (W1), \dots , (W4) and the surface energy density to obey $(\theta 1), \dots, (\theta 3)$. Then for the sequence $(\mathcal{F}_{\varepsilon_k})_k$ as in (4.1) and the homogenized total energy \mathcal{F}_{Hom} given in (4.62) there holds*

- (i) *on $SBV^p(\Omega; \mathbb{R}^3) \cap \text{Kin}(\Omega; \mathbf{Box})$ the Γ -lim inf-inequality w.r.t. the strong $L^1(\Omega; \mathbb{R}^3)$ -topology, i.e. for all φ and $(\varphi_k)_k$ in $SBV^p(\Omega; \mathbb{R}^3) \cap \text{Kin}(\Omega; \mathbf{Box})$ such that $\varphi_k \rightarrow \varphi$ in $L^1(\Omega; \mathbb{R}^3)$ one has*

$$\mathcal{F}_{\text{Hom}}(\varphi) \leq \liminf_{k \rightarrow \infty} \mathcal{F}_{\varepsilon_k}(\varphi_k).$$

- (ii) *the Γ -lim sup-inequality w.r.t. the strong $L^1(\Omega; \mathbb{R}^3)$ -topology for all $\varphi \in SBV^p(\Omega; \mathbb{R}^3) \cap \text{Kin}(\Omega; \mathbf{Box})$ with $\nu_{\varphi, 1} \neq 0$ on a set of positive \mathcal{H}^2 -measure, and for all $\varphi \in \mathcal{V}^p(\Omega; \mathbb{R}^3) \cap \text{Kin}(\Omega; \mathbf{Box})$. That is, for all such φ there is a sequence $(\varphi_k)_k$ in $SBV^p(\Omega; \mathbb{R}^3) \cap \text{Kin}(\Omega; \mathbf{Box})$ that converges strongly to φ in $L^1(\Omega; \mathbb{R}^3)$ and is such that*

$$\mathcal{F}_{\text{Hom}}(\varphi) \geq \limsup_{k \rightarrow \infty} \mathcal{F}_{\varepsilon_k}(\varphi_k).$$

Remark 4.7. As an immediate consequence of the theorem one obtains that $\mathcal{F}_{\text{Hom}}(\varphi) = (\Gamma\text{-}\lim_k \mathcal{F}_{\varepsilon_k})(\varphi)$ for every $\varphi \in \mathcal{V}^p(\Omega; \mathbb{R}^3) \cap \text{Kin}(\Omega; \mathbf{Box})$ (w.r.t. the strong $L^1(\Omega; \mathbb{R}^3)$ -topology).

Remark 4.8. One observes that ϕ as defined in the derivation above does not meet the assumptions of the lower semicontinuity statement Theorem 3.28. For this technical reason the author introduces $\tilde{\phi} : \mathbb{R}^3 \rightarrow [0, \infty)$ with $\tilde{\phi}(v) := |v_1| + |v_2| + |v_3|$ for $v \in \mathbb{R}^3$. Then $\tilde{\phi}$ is in accordance with the assumptions on the anisotropy coefficient like in Theorem 3.28, and note $\tilde{\phi}(v) = \phi(v)$ for every $v \in S^2$ with $v_1 = 0$.

The author will split the proof of Theorem 4.12 into one part dealing with the Γ -lim inf-inequality, and another one containing the proof of the Γ -lim sup-inequality. In the latter, one will highly profit from the efforts made in the construction of recovery sequences for deformations of the homogenized 2D-body, see Subsection 4.3.3. Before discussing the result from both a mathematical and a mechanical point of view in Subsection 4.4.5, the Γ -convergence mentioned in Remark 4.7 will be slightly extended to $SBV^p(\Omega; \mathbb{R}^3) \cap \text{Kin}(\Omega; \mathbf{Box})$ -deformations with some piecewise C^1 -discontinuity set.

4.4.2 Proof of the Γ -lim inf-inequality

Choose φ and $(\varphi_k)_k$ in $SBVP(\Omega; \mathbb{R}^3) \cap \text{Kin}(\Omega; \mathbf{Box})$ arbitrarily with the restriction that $\varphi_k \rightarrow \varphi$ in $L^1(\Omega; \mathbb{R}^3)$. Without loss of generality one may assume $\infty > \liminf_k \mathcal{F}_{\varepsilon_k}(\varphi_k) = \lim_m \mathcal{F}_{\varepsilon_{k(m)}}(\varphi_{k(m)})$, thus for all (but finitely many) $m \in \mathbb{N}$ one has $\varphi_{k(m)} \in W^{1,p}(\Omega_{\varepsilon_{k(m)}}; \mathbb{R}^3)$. This implies $\nu_{\varphi_{k(m)}} \in \{\pm e_2, \pm e_3\}$ in \mathcal{H}^2 -a.e. point of $S_{\varphi_{k(m)}}$. In particular, one has \mathcal{H}^2 -a.e. $\nu_{\varphi_{k(m)},1} = 0$ and $\phi(\nu_{\varphi_{k(m)}}) = 1$.

From Proposition 3.31 one obtains the closedness of the set $M = \{\varphi \in SBVP(\Omega; \mathbb{R}^3) : \nu_{\varphi,1} = 0 \text{ a.e. on } S_\varphi\}$ w.r.t. weak convergence in $SBVP(\Omega; \mathbb{R}^3)$. By means of Corollary 3.30 (wherein one sets $\hat{F} := 0$) one infers the sequential lower semicontinuity w.r.t. the strong $L^1(\Omega; \mathbb{R}^3)$ -topology of $\tilde{\mathcal{F}} : SBVP(\Omega; \mathbb{R}^3) \cap \text{Kin}(\Omega; \mathbf{Box}) \rightarrow [0, \infty]$,

$$\tilde{\mathcal{F}}(\psi) := \begin{cases} \int_{\Omega} W(\nabla \psi) \, dx + \int_{S_\psi} \tilde{\phi}(\nu_\psi) \theta(|\psi^+ - \psi^-|) \, d\mathcal{H}^2 & \text{if } \psi \in M, \\ \infty & \text{else} \end{cases}$$

$$= \mathcal{F}_{\text{Hom}}(\psi).$$

Herein, $\tilde{\phi}$ is given as in Remark 4.8. Hence

$$\mathcal{F}_{\text{Hom}}(\varphi) = \tilde{\mathcal{F}}(\varphi) \leq \liminf_{m \rightarrow \infty} \tilde{\mathcal{F}}(\varphi_{k(m)}). \quad (4.63)$$

However, as for all $m \in \mathbb{N}$ there holds $\varphi_{k(m)} \in M$ and $\tilde{\phi}(\varphi_{k(m)}) = \phi(\varphi_{k(m)}) = 1$ in \mathcal{H}^2 -a.e. point of $S_{\varphi_{k(m)}}$, one deduces $\tilde{\mathcal{F}}(\varphi_{k(m)}) = \mathcal{F}_{\varepsilon_{k(m)}}(\varphi_{k(m)})$ and furthermore by (4.63)

$$\mathcal{F}_{\text{Hom}}(\varphi) \leq \liminf_{m \rightarrow \infty} \mathcal{F}_{\varepsilon_{k(m)}}(\varphi_{k(m)}) = \liminf_{k \rightarrow \infty} \mathcal{F}_{\varepsilon_k}(\varphi_k).$$

This finishes the proof of the Γ -lim inf-inequality. \square

4.4.3 Proof of the Γ -lim sup-inequality

By definition of \mathcal{F}_{Hom} , the Γ -lim sup-inequality is trivial for all $\varphi \in SBVP(\Omega; \mathbb{R}^3) \cap \text{Kin}(\Omega; \mathbf{Box})$ for which $\nu_{\varphi,1} \neq 0$ on a set of positive \mathcal{H}^2 -measure.

Before proceeding with the proof, the reader is encouraged to recall the geometry of $\Omega = (0, \ell) \times \omega$, see Definition of Geometry 2.2.

Now let $\varphi \in \mathcal{V}^p(\Omega; \mathbb{R}^3) \cap \text{Kin}(\Omega; \mathbf{Box})$ be such that $\nu_{\varphi,1} = 0$ in \mathcal{H}^2 -a.e. point of S_φ , and let P be a polyhedral set containing S_φ . Assume without loss of generality $\mathcal{F}_{\text{Hom}}(\varphi) < \infty$ (otherwise there is nothing to show). Because the

normals on S_φ and P coincide \mathcal{H}^2 -a.e. (see Proposition 3.38), one infers that P can be chosen such that the normals of all its faces have zero first component, hence are orthogonal to the x_2x_3 -coordinate plane. The projection of P onto the x_2x_3 -coordinate plane is again polyhedral, and in an obvious way identified with a subset of \mathbb{R}^2 , which one denotes P_ω . In particular $[0, \ell] \times P_\omega \supseteq P \supseteq S_\varphi$, thus one can without loss of generality assume that already $P = [0, \ell] \times P_\omega$.

In the spirit of the proof of the Γ -lim sup-inequality for the 2D many-body structure, one first states the following lemma (which ought to be compared with Lemma 4.5).

Lemma 4.13. *There are a subsequence $(\varepsilon_{k(m)})_m$, and for every $m \in \mathbb{N}$ a deformation $\varphi_m \in \mathcal{V}^p(\Omega; \mathbb{R}^3) \cap \text{Kin}(\Omega; \mathbf{Box})$ and a polyhedral set $P_{\omega, m} \subseteq \mathbb{R}^2$ with the property that $S_{\varphi_m} \subseteq [0, \ell] \times P_{\omega, m}$, and there hold*

$$(i) \text{Knot}(P_{\omega, m}) \cap \omega \subseteq \varepsilon_{k(m)} \mathbb{Z}^2,$$

$$(ii) \text{ for all } L \in \text{Face}(P_{\omega, m}) \text{ with } \text{dist}(L, \partial\omega) = 0 \text{ there holds } L \subseteq \varepsilon_{k(m)} \partial\mathcal{D}_2,$$

$$(iii) \text{ for every } K \in \text{Knot}(P_{\omega, m}) \cap \omega \text{ there are at most four elements } L_1, \dots, L_4 \in \text{Face}(P_{\omega, m}) \text{ containing } K \text{ and there holds either}$$

for every $I \in \{[0, \frac{\pi}{2}), [\frac{\pi}{2}, \pi), [\pi, \frac{3\pi}{2}), [\frac{3\pi}{2}, 2\pi)\}$ there is at maximum one i such that angle between half-line $K + \mathbb{R}_{>}[1, 0]^T$ and L_i is in I

or

for every $I \in \{(\frac{\pi}{2}, \pi], (\pi, \frac{3\pi}{2}], (\frac{3\pi}{2}, 2\pi]\}$ there is at maximum one i such that angle between half-line $K + \mathbb{R}_{>}[1, 0]^T$ and L_i is in I .

Moreover, one has

$$\varphi_m \rightarrow \varphi \quad \text{in } L^1(\Omega; \mathbb{R}^3), \quad (4.64)$$

and

$$\lim_{m \rightarrow \infty} \int_{\Omega} W(\nabla \varphi_m) \, dx = \int_{\Omega} W(\nabla \varphi) \, dx, \quad (4.65)$$

$$\lim_{m \rightarrow \infty} \int_{S_{\varphi_m}} \phi(\nu_{\varphi_m}) \theta(|\varphi_m^+ - \varphi_m^-|) \, d\mathcal{H}^2 = \int_{S_\varphi} \phi(\nu_\varphi) \theta(|\varphi^+ - \varphi^-|) \, d\mathcal{H}^2. \quad (4.66)$$

In particular, there holds $\mathcal{F}_{\text{Hom}}(\varphi) = \lim_m \mathcal{F}_{\text{Hom}}(\varphi_m)$ and, in order to find a recovery sequence for φ , again by Proposition 3.7 it suffices to find recovery sequences for every φ_m , which is easy though. Indeed, the next lemma provides the desired recovery sequences.

Lemma 4.14. *Let $\psi \in \mathcal{V}^p(\Omega; \mathbb{R}^3) \cap \text{Kin}(\Omega; \mathbf{Box})$ with $\mathcal{F}_{\text{Hom}}(\psi) < \infty$ and $P_{\omega, \psi} \subseteq \mathbb{R}^2$ be polyhedral, with the property that $S_\psi \subseteq [0, \ell] \times P_{\omega, \psi} =: P_\psi$. Moreover, $P_{\omega, \psi}$ shall satisfy the assumptions (i), ..., (iii) from Lemma 4.13 (with some ε_m replacing $\varepsilon_{k(m)}$ in (i) and (ii)). Then there exists a sequence $(\psi_k)_k$ with $\psi_k \in W^{1,p}(\Omega_{\varepsilon_k}; \mathbb{R}^3) \cap \text{Kin}(\Omega; \mathbf{Box})$ for every $k \in \mathbb{N}$, which satisfies*

$$\psi_k \rightarrow \psi \quad \text{in } L^1(\Omega; \mathbb{R}^3), \quad (4.67)$$

and

$$\lim_{k \rightarrow \infty} \int_{\Omega} W(\nabla \psi_k) \, dx = \int_{\Omega} W(\nabla \psi) \, dx, \quad (4.68)$$

$$\lim_{k \rightarrow \infty} \int_{S_{\psi_k}} \theta(|\psi_k^+ - \psi_k^-|) \, d\mathcal{H}^2 = \int_{S_\psi} \phi(\nu_\psi) \theta(|\psi^+ - \psi^-|) \, d\mathcal{H}^2. \quad (4.69)$$

Proof. The author starts with an outline of the proof. First he ensures the reader, that other than in the proof of Lemma 4.6 there will be no lengthy constructions of pre-deformations, since one is going to entirely reuse the ones of the proof of Lemma 4.6.

The principal goal is first to find a pre-deformation $\Phi_k : \Omega \rightarrow \Omega$, which

- only differs from the identity mapping in a certain ε_k -environment \mathcal{T}_k of the polyhedral set P_ψ ,
- is such that $\Phi_k^{-1}(P_\psi) \cap \Omega \subseteq \varepsilon_k \partial \mathcal{D}_3$,
- satisfies for some k -independent positive constants c_1, c_2, c_3 the estimate

$$\begin{aligned} c_1 &\leq \det D\Phi_k \leq c_2 \\ |D\Phi_k| &\leq c_3 \end{aligned} \quad (4.70)$$

uniformly on Ω .

Like done so often, one then defines the sequence $(\psi_k)_k$ by setting $\psi_k := \psi \circ \Phi_k$ for all (but perhaps finitely many) $k \in \mathbb{N}$. Proceeding exactly like in the proof of Lemma 4.6, one then proves $\psi_k \in SBV^p(\Omega; \mathbb{R}^3) \cap \text{Kin}(\Omega; \mathbf{Box})$, the convergence (4.67) and based on (4.70) moreover (4.68). As it will be evident from the construction of Φ_k – which will follow below – one can furthermore carry over the strategy to prove (4.69) from the proof of Lemma 4.6. In order to have a transparent exposition, the just described procedure is split into three steps.

Step 1. Let $\Phi_{\omega, k} : \omega \rightarrow \omega$ be the pre-deformation constructed in steps 1 until 3 of the proof of Lemma 4.6 (which exists for all but finitely many $k \in \mathbb{N}$). Herein, ω takes the role of the macroscopic shape Ω of the two-dimensional many-body structure, cf. Definition of Geometry 2.1, and $P_{\omega, \psi}$ takes the role of the P_ψ

assumed in Lemma 4.6. Furthermore, $\mathcal{T}_{\omega,k}$ shall act in place of the \mathcal{T}_k constructed in step 3 of the proof of Lemma 4.6. Recapitulating the steps of this proof, the pre-deformation $\Phi_{\omega,k}$ shows the following properties.

$\Phi_{\omega,k}$ equals the identity on $\omega \setminus \mathcal{T}_{\omega,k}$,

$\text{vol}_2 \mathcal{T}_{\omega,k} \rightarrow 0$,

$\Phi_{\omega,k}^{-1}(P_{\omega,\psi}) \cap \omega \subseteq \varepsilon_k \partial \mathcal{D}_2$,

and for some k -independent positive constants c_1, c_2, c_3 the estimate

$$\begin{aligned} c_1 &\leq \det D\Phi_{\omega,k} \leq c_2 \\ |D\Phi_{\omega,k}| &\leq c_3 \end{aligned}$$

is valid uniformly on ω .

Step 2. The desired pre-deformation $\Phi_k : \Omega \rightarrow \Omega$ is now obtained by defining it to equal $\Phi_{\omega,k} : \omega \rightarrow \omega$ on every cross-section of the beam-like domain $\Omega = (0, \ell) \times \omega$. That is

$$\Phi_k(x) := \begin{bmatrix} x_1 \\ \Phi_{\omega,k}(x_2, x_3) \end{bmatrix}$$

for every $x \in (0, \ell) \times \omega$. Upon setting $\mathcal{T}_k := (0, \ell) \times \mathcal{T}_{\omega,k}$, from the above listed properties of $\Phi_{\omega,k}$ and the definition of Φ_k one immediately deduces

that Φ_k equals the identity mapping on $\Omega \setminus \mathcal{T}_k$,

$\text{vol} \mathcal{T}_k \rightarrow 0$,

the inclusion

$$\begin{aligned} \Phi_k^{-1}(P_\psi) \cap \Omega &= (\Phi_k^{-1}([0, \ell] \times P_{\omega,\psi})) \cap \Omega \\ &= (0, \ell) \times (\Phi_{\omega,k}^{-1}(P_{\omega,\psi}) \cap \omega) \\ &\subseteq (0, \ell) \times (\varepsilon_k \partial \mathcal{D}_2) \subseteq \varepsilon_k \partial \mathcal{D}_3, \end{aligned}$$

the validity of estimate (4.70).

Step 3. As announced before, for all but finitely many $k \in \mathbb{N}$ one defines $\psi_k := \psi \circ \Phi_k$, and deduces first by Proposition 4.3 the inclusion $\psi_k \in SBV^p(\Omega; \mathbb{R}^3) \cap \text{Kin}(\Omega; \mathbf{Box})$. Moreover, by means of Proposition 3.23 one obtains $S_{\psi_k} = \Phi_k^{-1}(S_\psi)$, and infers from $S_\psi \subseteq P_\psi$ and the properties of Φ_k above the inclusion $S_{\psi_k} \subseteq \varepsilon_k \partial \mathcal{D}_3$. Employing Proposition 3.40, one arrives at

$$\psi_k \in W^{1,p}(\Omega \setminus \varepsilon_k \partial \mathcal{D}_3; \mathbb{R}^3) = W^{1,p}(\Omega_{\varepsilon_k}; \mathbb{R}^3).$$

Afterwards, one can prove the convergences (4.67) and (4.68) like in step 4 and step 5 of the proof of Lemma 4.6.

As concerns the remaining convergence of the surface energy (4.69), one proceeds as follows. First, by construction every face A of the polyhedral set P_ψ is of the form $A = [0, \ell] \times L$ where $L \in \text{Face}(P_{\omega, \psi})$. Following the lines of the proof of Lemma 4.6, the author may assume for simplicity $L = \text{conv}\{0, K\}$ and $0, K \in \text{Knot}(P_{\omega, \psi}) \cap \omega$. Referring to Figure 4.18 below, let $\nu_L = [\cos \alpha, -\sin \alpha]^T$ be a unit normal on L , hence $\nu_A = [0, \cos \alpha, -\sin \alpha]^T$ is a unit normal on A .

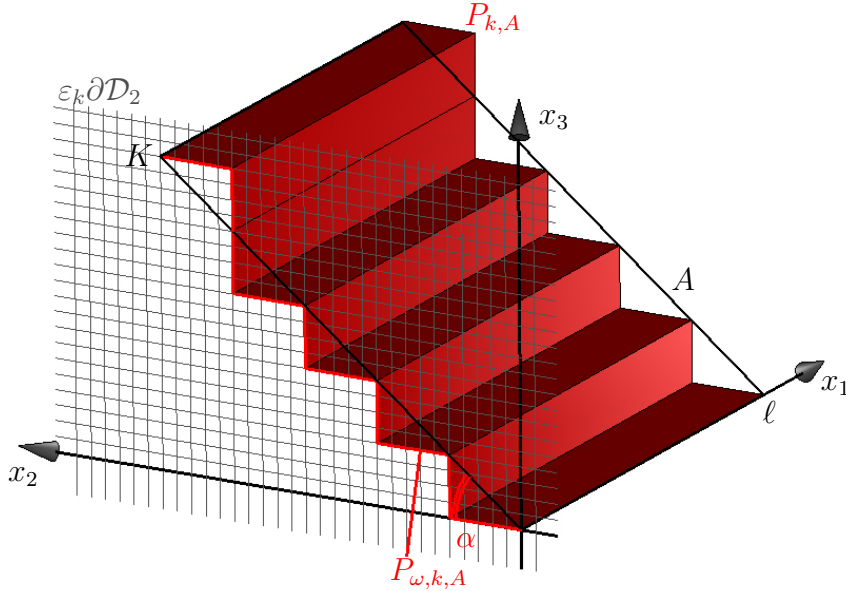

Figure 4.18: The face A and the polyhedral set $P_{k,A}$

Setting $P_{k,A} := \Phi_k^{-1}(A)$ one notes that this polyhedral set is of the form $P_{k,A} = (0, \ell) \times P_{\omega,k,A}$, where $P_{\omega,k,A} \subseteq \varepsilon_k \partial \mathcal{D}_2$ is also depicted in Figure 4.18. Recalling the parametrization $\lambda_k : [0, \mathcal{H}^1(L)] \rightarrow \mathbb{R}^2$ of $P_{\omega,k,A}$, which was used in step 6 of the proof of Lemma 4.6, a parametrization of $P_{k,A}$ is

$$\tilde{\lambda}_k : (0, \ell) \times [0, \mathcal{H}^1(L)] \rightarrow \mathbb{R}^3, \quad \tilde{\lambda}_k(r, s) := \begin{bmatrix} r \\ \lambda_k(s) \end{bmatrix}.$$

Upon realizing by Corollary 3.39 the identity $\psi_k^\pm = \psi^\pm \circ \Phi_k$ on $P_{k,A}$ one can write

$$\begin{aligned} & \int_{\Phi_k^{-1}(A)} \theta(|\psi_k^+ - \psi_k^-|) d\mathcal{H}^2 = \int_{\Phi_k^{-1}(A)} \theta(|\psi^+ \circ \Phi_k - \psi^- \circ \Phi_k|) d\mathcal{H}^2 \\ & = \int_{(0,\ell) \times [0,\mathcal{H}^1(L)]} \theta \left(\left| \psi^+ \circ \Phi_k \circ \tilde{\lambda}_k(r,s) - \psi^- \circ \Phi_k \circ \tilde{\lambda}_k(r,s) \right| \right) \\ & \quad \cdot \sqrt{\det \left(D\tilde{\lambda}_k^T(r,s) D\tilde{\lambda}_k(r,s) \right)} d(r,s). \end{aligned} \quad (4.71)$$

A simple computation shows that

$$\det \left(D\tilde{\lambda}_k^T(r,s) D\tilde{\lambda}_k(r,s) \right) = D\lambda_k^T(s) D\lambda_k(s) \quad (4.72)$$

and by construction there holds ($R_\alpha \in \text{SO}(2)$) was the rotation matrix describing the rotation in \mathbb{R}^2 about the origin through α)

$$\Phi_k \circ \tilde{\lambda}_k(r,s) = \begin{bmatrix} r \\ R_\alpha \begin{bmatrix} s \\ 0 \end{bmatrix} \end{bmatrix}. \quad (4.73)$$

Regarding the last identity, the author refers to step 6 of the proof of Lemma 4.6. Inserting (4.72) and (4.73) into (4.71) leads to

$$\begin{aligned} & \int_{\Phi_k^{-1}(A)} \theta(|\psi_k^+ - \psi_k^-|) d\mathcal{H}^2 \\ & = \int_{(0,\ell) \times [0,\mathcal{H}^1(L)]} \theta \left(\left| \psi^+ \circ \begin{bmatrix} r \\ R_\alpha[s, 0]^T \end{bmatrix} - \psi^- \circ \begin{bmatrix} r \\ R_\alpha[s, 0]^T \end{bmatrix} \right| \right) \\ & \quad \cdot \sqrt{D\lambda_k^T(s) D\lambda_k(s)} d(r,s). \end{aligned} \quad (4.74)$$

In (4.19) there has been already established

$$\sqrt{D\lambda_k^T D\lambda_k} \rightarrow |\cos \alpha| + |\sin \alpha| = \phi(\nu_A) \quad \text{in } L^2((0, \ell)),$$

where $\phi : S^2 \rightarrow [0, \infty)$ is the anisotropy coefficient within the surface term of \mathcal{F}_{Hom} (see (4.62)). With this at hand, one continues (4.74) and arrives at

$$\begin{aligned} & \int_{\Phi_k^{-1}(A)} \theta(|\psi_k^+ - \psi_k^-|) d\mathcal{H}^2 \\ & \rightarrow \int_{(0,\ell) \times [0,\mathcal{H}^1(L)]} \theta \left(\left| \psi^+ \circ \begin{bmatrix} r \\ R_\alpha[s, 0]^T \end{bmatrix} \right. \right. \\ & \quad \left. \left. - \psi^- \circ \begin{bmatrix} r \\ R_\alpha[s, 0]^T \end{bmatrix} \right| \right) \cdot \phi(\nu_A) d(r,s) \\ & = \int_A \phi(\nu_A) \theta(|\psi^+ - \psi^-|) d\mathcal{H}^2. \end{aligned}$$

Finally, from an argument similar to the one employed in (4.15) one deduces the validity of (4.69). \square

Proving Lemma 4.13

The reader will have noticed the absence of a proof for Lemma 4.13. Indeed, it can be proved by the very same two-step procedure employed in the proof of its two-dimensional analogon Lemma 4.5. To be more specific, each of the two lemmas stated below is to be proved in the same way like Lemma 4.14 by falling back to the pre-deformations constructed for the two-dimensional counterparts, i.e. Lemma 4.7 and Lemma 4.8.

First the author will state the analogon of Lemma 4.7.

Lemma 4.15. *There exists a sequence $(\psi_j)_j$ in $\mathcal{V}^p(\Omega; \mathbb{R}^3) \cap \text{Kin}(\Omega; \mathbf{Box})$ and polyhedral sets $P_{\omega,j} \subseteq \mathbb{R}^2$ with the property that $S_{\psi_j} \subseteq [0, \ell] \times P_{\omega,j}$, and each of it satisfies condition (iii) from Lemma 4.13. In addition one has*

$$\psi_j \rightarrow \varphi \quad \text{in } L^1(\Omega; \mathbb{R}^3), \quad (4.75)$$

and

$$\lim_{j \rightarrow \infty} \int_{\Omega} W(\nabla \psi_j) \, dx = \int_{\Omega} W(\nabla \varphi) \, dx, \quad (4.76)$$

$$\lim_{j \rightarrow \infty} \int_{S_{\psi_j}} \phi(\nu_{\psi_j}) \theta(|\psi_j^+ - \psi_j^-|) \, d\mathcal{H}^2 = \int_{S_{\varphi}} \phi(\nu_{\varphi}) \theta(|\varphi^+ - \varphi^-|) \, d\mathcal{H}^2. \quad (4.77)$$

Also Lemma 4.8 has its natural counterpart for the present three-dimensional case.

Lemma 4.16. *Let $\psi \in \mathcal{V}^p(\Omega; \mathbb{R}^3) \cap \text{Kin}(\Omega; \mathbf{Box})$ with $\mathcal{F}_{\text{Hom}}(\psi) < \infty$, and such that there is a polyhedral set $P_{\omega,\psi} \subseteq \mathbb{R}^2$ satisfying $S_{\psi} \subseteq [0, \ell] \times P_{\omega,\psi}$ and condition (iii) from Lemma 4.13. Then there are a sequence $(\psi_{\ell})_{\ell}$ in $\mathcal{V}^p(\Omega; \mathbb{R}^3) \cap \text{Kin}(\Omega; \mathbf{Box})$, a subsequence $(\varepsilon_{q(\ell)})_{\ell}$ and polyhedral sets $P_{\omega,\ell} \subseteq \mathbb{R}^2$ with the following properties. Each of the polyhedral sets $P_{\omega,\ell}$ satisfies $S_{\psi_{\ell}} \subseteq [0, \ell] \times P_{\omega,\ell}$ and the conditions (i) and (ii) from Lemma 4.13 (w.r.t. the subsequence $(\varepsilon_{q(\ell)})_{\ell}$) as well as condition (iii) from the same lemma. Moreover, there hold the convergences*

$$\psi_{\ell} \rightarrow \psi \quad \text{in } L^1(\Omega; \mathbb{R}^3), \quad (4.78)$$

and

$$\lim_{\ell \rightarrow \infty} \int_{\Omega} W(\nabla \psi_{\ell}) \, dx = \int_{\Omega} W(\nabla \psi) \, dx, \quad (4.79)$$

$$\lim_{\ell \rightarrow \infty} \int_{S_{\psi_{\ell}}} \phi(\nu_{\psi_{\ell}}) \theta(|\psi_{\ell}^+ - \psi_{\ell}^-|) \, d\mathcal{H}^2 = \int_{S_{\psi}} \phi(\nu_{\psi}) \theta(|\psi^+ - \psi^-|) \, d\mathcal{H}^2. \quad (4.80)$$

Having verified these statements, the claim of Lemma 4.13 follows by diagonalizing the sequences obtained from Lemma 4.15 and Lemma 4.16, with the diagonalization argument in the proof of Lemma 4.5 applying literally. \square

4.4.4 Improving Γ -convergence to more general deformations

Again, with Proposition 3.7 at hand, the second statement in Theorem 4.12 implies the validity of the Γ -lim sup-inequality for all deformations $\varphi \in SBV^p(\Omega; \mathbb{R}^3) \cap \text{Kin}(\Omega; \mathbf{Box})$, for which

there is a sequence $(\varphi_k)_k$ in $\mathcal{V}^p(\Omega; \mathbb{R}^3) \cap \text{Kin}(\Omega; \mathbf{Box})$ such that

$$\begin{aligned} \text{(i)} \quad & \varphi_k \rightarrow \varphi \quad \text{in } L^1(\Omega; \mathbb{R}^3), \\ \text{(ii)} \quad & \mathcal{F}_{\text{Hom}}(\varphi) \geq \liminf_{k \rightarrow \infty} \mathcal{F}_{\text{Hom}}(\varphi_k). \end{aligned} \tag{4.81}$$

For the reasons explained in Subsection 4.3.4, it is not clear, which deformations actually fulfill (4.81). In regard of the next statement, one can at least say that (4.81) is met by a large class of physically relevant deformations.

Lemma 4.17. *Suppose the assumptions of Theorem 4.12 to be valid. Let $\varphi \in SBV^p(\Omega; \mathbb{R}^3) \cap \text{Kin}(\Omega; \mathbf{Box})$ be such that S_φ is contained in a piecewise C^1 -hypersurface S , the projection of which on the x_2x_3 -coordinate plane is an in ω piecewise C^1 -hypersurface. Assume furthermore $\mathcal{F}_{\text{Hom}}(\varphi) < \infty$. Then there is a sequence $(\varphi_k)_k$ in $\mathcal{V}^p(\Omega; \mathbb{R}^3) \cap \text{Kin}(\Omega; \mathbf{Box})$ such that*

$$\varphi_k \rightarrow \varphi \quad \text{in } L^1(\Omega; \mathbb{R}^3),$$

and

$$\begin{aligned} \lim_{k \rightarrow \infty} \int_{\Omega} W(\nabla \varphi_k) \, dx &= \int_{\Omega} W(\nabla \varphi) \, dx, \\ \lim_{k \rightarrow \infty} \int_{S_{\varphi_k}} \phi(\nu_{\varphi_k}) \theta(|\varphi_k^+ - \varphi_k^-|) \, d\mathcal{H}^2 &= \int_{S_\varphi} \phi(\nu_\varphi) \theta(|\varphi^+ - \varphi^-|) \, d\mathcal{H}^2. \end{aligned}$$

Proof. The proof is carried out analogously to Lemma 4.14 by falling back to the pre-deformations constructed in the two-dimensional counterpart of the present statement, see Lemma 4.9. \square

Of course, the assertion of Lemma 4.17 could be easily extended to slightly more irregular deformations. Nevertheless, for the sake of brevity and sparing the reader more lengthy constructions of pre-deformations, the author confined himself to a simple version like the present.

Corollary 4.18 (Homogenization of the 3D-structure with zero cord-angle II). *Under the assumptions of Theorem 4.12, in all $\varphi \in SBV^p(\Omega; \mathbb{R}^3) \cap \text{Kin}(\Omega; \mathbf{Box})$, such that*

$$\nu_{\varphi,1} \neq 0 \text{ on a set of positive } \mathcal{H}^2\text{-measure}$$

or

S_φ is contained in a piecewise C^1 -hypersurface, the projection of which on the x_2x_3 -coordinate plane is an in ω piecewise C^1 -hypersurface

one has Γ -convergence of the $(\mathcal{F}_{\varepsilon_k})_k$ to \mathcal{F}_{Hom} w.r.t. the strong $L^1(\Omega; \mathbb{R}^3)$ -topology, in symbols

$$\left(\Gamma\text{-}\lim_{k \rightarrow \infty} \mathcal{F}_{\varepsilon_k} \right) (\varphi) = \mathcal{F}_{\text{Hom}}(\varphi).$$

4.4.5 Mathematical discussion and mechanical interpretation

As concerns the mathematical significance of the Γ -convergence study carried out for the 3D many-body structure with zero cord-angle, the author once more points out, that the principal drawback is the ensured existence of recovery sequences only for deformations with additional regularity. Whether Γ -convergence of the $(\mathcal{F}_{\varepsilon_k})_k$ to \mathcal{F}_{Hom} holds true on the whole of $SBV^p(\Omega; \mathbb{R}^3) \cap \text{Kin}(\Omega; \mathbf{Box})$ is a question still to be answered. But again, apart from its coincidence with the mechanical intuition, the homogenization limit \mathcal{F}_{Hom} shows the desirable properties listed in the proposition below.

Proposition 4.19. *Let the assumptions of Theorem 4.12 hold and \mathcal{F}_{Hom} be given as in (4.62). Then*

- (i) \mathcal{F}_{Hom} is sequentially lower semicontinuous w.r.t. the strong $L^1(\Omega; \mathbb{R}^3)$ -topology,
- (ii) there is a minimizer of \mathcal{F}_{Hom} on $SBV^p(\Omega; \mathbb{R}^3) \cap \text{Kin}(\Omega; \mathbf{Box})$.

Proof. Setting $M := \{\varphi : \varphi \in SBV^p(\Omega; \mathbb{R}^3), \nu_{\varphi,1} = 0 \text{ } \mathcal{H}^2\text{-a.e. on } S_\varphi\}$ and remembering the closedness of M w.r.t. weak convergence in $SBV^p(\Omega; \mathbb{R}^3)$ according to Proposition 3.31, the assertion becomes an immediate consequence of Corollary 3.30 (wherein one sets $\hat{F} := 0$ and utilizes Remark 4.8). \square

Like already observed in homogenization of the 2D many-body structure, there is no need to relax the homogenization limit \mathcal{F}_{Hom} , and its sequential lower semicontinuity w.r.t. the strong $L^1(\Omega; \mathbb{R}^3)$ -topology poses as another indicator that \mathcal{F}_{Hom} might indeed be the Γ -limit of the sequence $(\mathcal{F}_{\varepsilon_k})_k$.

In accordance with the mechanical expectation one finds, that in the homogenization limit \mathcal{F}_{Hom} only cracks parallel to the original beam-orientation in the many-body structures Ω_{ε_k} can be of finite energy. Yet in view of Corollary 4.18, cross-sections of the homogenized body can with finite energy be sliced by the crack surfaces into fragments of (physically) arbitrary shape. Again, the elastic properties of the homogenized body off the cracks are the same as of the many-body structures Ω_{ε_k} .

Nevertheless, also like in the case of the many-body structures Ω_{ε_k} , the homogenized body can parallel to the beam orientation in the Ω_{ε_k} be penetrated or even broken through. The crack behaviour on the other hand is again anisotropic, the anisotropy effects being the same as for the two-dimensional many-body structure.

4.5 HOMOGENIZATION OF THE 3D-STRUCTURE: NONZERO CORD-ANGLE

The author now studies the remaining case of the three-dimensional many-body structures with nonzero cord-angle as they were introduced in Definition of Geometry 2.3. For the associated total energy \mathcal{F}_ε he refers to (4.1) and Remark 4.1.

4.5.1 Heuristic derivation and Γ -convergence statement

Assume $(\varepsilon_k)_k$ to be a refining, vanishing sequence of positive real numbers, $\mathcal{F}_{\varepsilon_k}$ shall be given as in (4.1) and associated with the three-dimensional many-body structure Ω_{ε_k} with nonzero cord-angle $0 < \gamma \leq \frac{\pi}{2}$. For the last time in this thesis, the author looks for an energetic limit, i.e. a limit in the sense of Γ -convergence of the sequence $(\mathcal{F}_{\varepsilon_k})_k$. Thus he has to investigate, which is the smallest energy one can approximate a given deformation in $SBV^p(\Omega; \mathbb{R}^3) \cap \text{Kin}(\Omega; \mathbf{Box})$ with, when passing through the domains of the $(\mathcal{F}_{\varepsilon_k})_k$.

The first question in this spirit is, which are the deformations that can be approximated with finite energy? Or more specific, which are the crack geometries one expects to cause finite energy in a homogenization limit of the $(\mathcal{F}_{\varepsilon_k})_k$? To this end, consider a $\varphi \in SBV^p(\Omega; \mathbb{R}^3) \cap \text{Kin}(\Omega; \mathbf{Box})$ with a locally sufficiently regular discontinuity set S_φ , and assume that it is in a local environment $U \cap S_\varphi$ nonparallel to the beam layers in \mathcal{D}_3 , i.e. $\nu_{\varphi,1} \neq 0$ or $\nu_{\varphi,2} \neq 0$ on $U \cap S_\varphi$. But then ν_φ is on $U \cap S_\varphi$ also nonparallel to at least one of the two beam-directions that occur in \mathcal{D}_3 , due to the nonzero cord-angle. Consult Figure 4.19 for a visual impression. In particular, such crack can not be approximated with finite energy by deformations of the many-body structures Ω_{ε_k} , since the beam layers to which

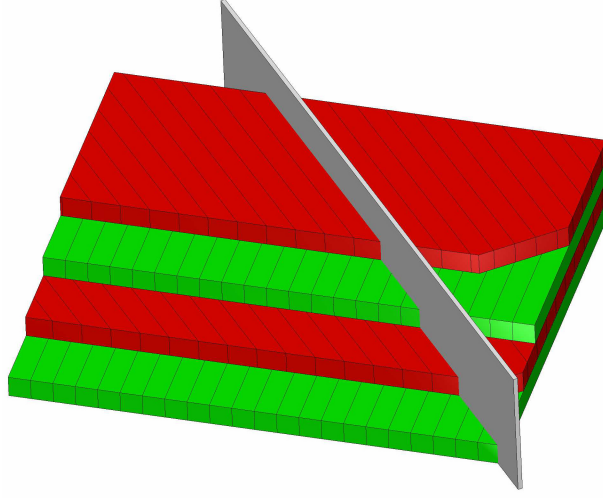

Figure 4.19: A crack in Ω nonparallel to the beam layers in \mathcal{D}_3

it is nonparallel prevent a “propagation” of the crack. The reason is, that all those beam layers would have to stretch enormously across the crack as they approximate it, what in turn would cost more and more elastic energy as ε_k vanishes. Consequently, one expects that in a homogenized many-body structure only horizontal cracks, i.e. cracks parallel to the beam layers in \mathcal{D}_3 can be observed.

Eventually, let φ be in $SBV^p(\Omega; \mathbb{R}^3) \cap \text{Kin}(\Omega; \text{Box})$ with sufficiently regular discontinuity set S_φ , and assume the latter to be parallel to the beam layers in \mathcal{D}_3 , thus $\nu_{\varphi,1} = \nu_{\varphi,2} = 0$ on S_φ .

Homogenized elastic energy. Repeating the arguments in the heuristic derivation of the homogenization limit for the 2D many-body structure, the least elastic energy, one can approximate the deformation φ with when passing through the domains of $(\mathcal{F}_{\varepsilon_k})_k$, can be assumed to be

$$\int_{\Omega} W(\nabla\varphi) \, dx.$$

Homogenized surface energy. One considers some $x_0 \in S_\varphi$ and a plane area element $d\mathcal{H}^2(x_0)$ around it, which is by assumption oriented by $\nu_\varphi(x_0) = e_3$ or $-e_3$. Now as ε_k decreases, one finds in every environment of x_0 a (horizontal) boundary of a beam layer in Ω_{ε_k} . Consequently, one can simply approximate the jump of φ in x_0 by deformations of the many-body structures Ω_{ε_k} , which show the same jump, but on the w.r.t. x_0 nearest boundary of a beam layer in Ω_{ε_k} . With each of these approximations causing a surface energy of $\theta(|\varphi^+ - \varphi^-|) d\mathcal{H}^2(x_0)$ to open the crack on the inner contact boundary of the many-body structure Ω_{ε_k} , the least energy one can approximate the jump of φ across the plane area element

$d\mathcal{H}^2(x_0)$ around x_0 is again

$$\theta(|\varphi^+ - \varphi^-|) d\mathcal{H}^2(x_0).$$

Therefore, the smallest surface energy needed when approximating the discontinuity set S_φ with deformations taken from the domains of the $(\mathcal{F}_{\varepsilon_k})_k$ is likely to be

$$\int_{S_\varphi} \theta(|\varphi^+ - \varphi^-|) d\mathcal{H}^2.$$

Note, that this surface energy is exactly the same as it was employed in the $(\mathcal{F}_{\varepsilon_k})_k$ to describe the brittle fracture behaviour along the inner contact boundaries of the many-body structures Ω_{ε_k} .

Homogenized total energy. Once more the author assumes that the additive decomposition of the total energy in elastic energy and surface energy transfers into a possible Γ -limit of the $(\mathcal{F}_{\varepsilon_k})_k$. Hence, the above considerations result in the heuristic definition of the *homogenized total energy*

$$\mathcal{F}_{\text{Hom}} : SBV^p(\Omega; \mathbb{R}^3) \cap \text{Kin}(\Omega; \mathbf{Box}) \rightarrow [0, \infty],$$

defined as

$$\mathcal{F}_{\text{Hom}}(\varphi) := \begin{cases} \int_{\Omega} W(\nabla\varphi) dx + \int_{S_\varphi} \theta(|\varphi^+ - \varphi^-|) d\mathcal{H}^2 & \text{if } \nu_{\varphi,1} = \nu_{\varphi,2} = 0 \text{ } \mathcal{H}^2\text{-a.e. on } S_\varphi, \\ \infty & \text{else} \end{cases} \quad (4.82)$$

Mathematically, the above said can be confirmed rigorously by means of Γ -convergence, as will reveal the next statement.

Theorem 4.20 (Homogenization of the 3D-structure with nonzero cord-angle). *Let $(\varepsilon_k)_k$ be a refining, vanishing sequence of positive real numbers and $\Omega, \Omega_{\varepsilon_k}, \Gamma_{C,\varepsilon_k}$ like in Definition of Geometry 2.3. Suppose the elastic energy density W to be in accordance with (W1), . . . , (W4) and the surface energy density to obey $(\theta_1), \dots, (\theta_3)$. Then for the sequence $(\mathcal{F}_{\varepsilon_k})_k$ as in (4.1) and the homogenized total energy \mathcal{F}_{Hom} given in (4.82) there holds*

$$\left(\Gamma\text{-}\lim_{k \rightarrow \infty} \mathcal{F}_{\varepsilon_k} \right) (\varphi) = \mathcal{F}_{\text{Hom}}(\varphi) \quad \text{w.r.t. the strong } L^1(\Omega; \mathbb{R}^3)\text{-topology}$$

for all $\varphi \in SBV^p(\Omega; \mathbb{R}^3) \cap \text{Kin}(\Omega; \mathbf{Box})$ such that S_φ is contained in a piecewise C^1 -hypersurface.

When concerned with the proof, this time – other than in the preceding cases – the main difficulty will be to show the Γ -lim inf-inequality, what is going to be addressed in Subsection 4.5.2. After the simple proof of the Γ -lim sup-inequality, the author is going to conclude the thesis by analyzing the statement of Theorem 4.20 from a mathematical and also a mechanical point of view.

4.5.2 Proof of the Γ -lim inf-inequality

The main task in the proof of the Γ -lim inf-inequality is to strictly justify the heuristic, that only deformations with cracks parallel to the beam layers in \mathcal{D}_3 are energetically attainable. Lemma 4.21 below provides the desired statement.

Lemma 4.21. *Consider an arbitrary subsequence $(\varepsilon_{k(m)})_m$ of $(\varepsilon_k)_k$. Let $\varphi \in SBV^p(\Omega; \mathbb{R}^3)$ be such that S_φ is contained in a piecewise C^1 -hypersurface S and $\nu_{\varphi,1} \neq 0$ or $\nu_{\varphi,2} \neq 0$ on a subset of S_φ of positive \mathcal{H}^2 -measure. Then for every sequence $(\varphi_m)_m$ such that $\varphi_m \in W^{1,p}(\Omega_{\varepsilon_{k(m)}}; \mathbb{R}^3)$ and $\varphi_m \rightarrow \varphi$ in $L^1(\Omega; \mathbb{R}^3)$ one has*

$$\liminf_{m \rightarrow \infty} \int_{\Omega} |\nabla \varphi_m|^p dx = \infty.$$

Proof. By assumption, there is $x_0 \in S_\varphi \subseteq S$ such that $\nu_{\varphi,1}(x_0) \neq 0$ or $\nu_{\varphi,2}(x_0) \neq 0$, in particular $\varphi^+(x_0) - \varphi^-(x_0) \neq 0$.

The idea of the proof is the following. As a consequence of the form of $\nu_\varphi(x_0)$, due to the nonzero cord-angle γ it is nonperpendicular to at least one of the beam directions occurring in the microstructure \mathcal{D}_3 . Remember first $\nu_\varphi = \nu_S$ \mathcal{H}^2 -a.e. on S_φ by Proposition 3.38. Hence, also S is in an environment of x_0 nonparallel to one of the beam directions. But this means that for small enough $\varepsilon_{k(m)}$, in an environment of x_0 the set S would “cut through” all those beams in $\varepsilon_{k(m)}\mathcal{D}_3$ to which it is nonparallel. Recall that the $\varphi_m \in W^{1,p}(\Omega_{\varepsilon_{k(m)}}; \mathbb{R}^3)$ can only jump across the inner contact boundaries $\Gamma_{C,\varepsilon_{k(m)}}$, but not in beam direction. Thus, as the φ_m imitate φ and in particular its jumps, in an environment of x_0 the φ_m have to extremely stretch the fibres of the beams being “cut through” by S , resulting in higher and higher values of $\int_{\Omega} |\nabla \varphi_m|^p dx$.

According to the Definition 3.36 there are bounded Lipschitzian domains $U_1, \dots, U_\ell \subseteq \mathbb{R}^2$, $g_i \in C^1(\overline{U_i})$, $Q_i \in \text{SO}(3)$ and $b_i \in \mathbb{R}^3$ such that upon setting

$$S_i := \left\{ Q_i \begin{bmatrix} \hat{\xi} \\ g_i(\hat{\xi}) \end{bmatrix} + b_i : \hat{\xi} \in \overline{U_i} \right\}$$

there holds $S = \bigcup_{i=1}^{\ell} S_i$. Without loss of generality one may assume $x_0 \in \text{rel int } S_1$.

To simplify the presentation, the author temporarily introduces some notation. Let v_1, v_2 denote the beam directions occurring in \mathcal{D}_3 , i.e. $v_1 = [1, 0, 0]^T$ and $v_2 = [\cos \gamma, \sin \gamma, 0]^T$. The collection of all beams in \mathcal{D}_3 oriented in v_1 shall be denoted as

$$\mathcal{D}_{3,v_1} := \bigcup \{ (0, a_2, 2a_3) + \mathbb{R} \times (0, 1)^2 : a_2, a_3 \in \mathbb{Z} \},$$

similarly

$$\mathcal{D}_{3,v_2} := R_\gamma \left(\bigcup \{ (0, a_2, 2a_3 - 1) + \mathbb{R} \times (0, 1)^2 : a_2, a_3 \in \mathbb{Z} \} \right)$$

contains all those oriented in v_2 -direction. Herein, R_γ again stands for the rotation about the x_3 -axis through γ , see Subsection 2.1.2. As $\gamma \neq 0$, one can always choose $v \in \{v_1, v_2\}$ such that $\nu_\varphi(x_0) \not\perp v$. To further clarify the presentation, one may assume the coordinate frame to be translated and rotated, such that afterwards the origin lies in x_0 and the vertical axis (the axis of the third component) is oriented like v . To distinguish this from the coordinate frame used so far, the author denotes coordinates in this new frame as $\xi = (\xi_1, \xi_2, \xi_3)$ instead of the $x = (x_1, x_2, x_3)$ used in the original frame. **For the rest of the proof, every object is assumed to be represented in the new coordinate system.**

Since $\nu_\varphi(0) \not\perp v$, by the implicit function theorem and the fact that S_1 is a C^1 -manifold, one can find an open environment $U \subset \mathbb{R}^2$ containing 0 and a $g \in C^1(U)$ such that $g(0) = 0$ and

$$S_1 \cap (U \times \mathbb{R}) = \{ (\hat{\xi}, g(\hat{\xi})) : \hat{\xi} \in U \}.$$

Let $r > 0$ be sufficiently small, such that S_1 divides $B_r(0)$ in two parts B_r^\pm . Furthermore – possibly upon choosing a smaller r to ensure $B_r(0) \cap S_i = \emptyset$ for any $i \geq 2$ – one has $\varphi \in W^{1,p}(B_r^\pm; \mathbb{R}^3)$. Moreover, by the fact that $p > 3$, the Lipschitz-regularity of ∂B_r^\pm for small enough r and the Sobolev-embedding theorem there holds also $\varphi \in C(\overline{B_r^\pm}; \mathbb{R}^3)$. Having realized this, one can find an open set $V \subseteq U$ containing 0 and a $h_0 > 0$ such that

$$\left| \varphi \left((\hat{\xi}, g(\hat{\xi})) + h_+ v \right) - \varphi \left((\hat{\xi}, g(\hat{\xi})) - h_- v \right) \right| \geq c_1 \quad (4.83)$$

for all $0 < h_\pm \leq h_0$, $\hat{\xi} \in V$ and some positive constant c_1 .

Step 1. Consider the set $A_m := \{ \hat{\xi} : \hat{\xi} \in U, (\hat{\xi}, 0) \in \varepsilon_{k(m)} \mathcal{D}_{3,v} \}$, then $\mathbb{1}_{A_m} \rightharpoonup \frac{1}{2}$ in $L^2(U)$. Set $Q_m := A_m \cap V$, then its two-dimensional volume $\text{vol}_2 Q_m = \int_U \mathbb{1}_{A_m} \cdot \mathbb{1}_V d\hat{\xi} \rightarrow \frac{1}{2} \text{vol}_2 V$. Without loss of generality one may therefore assume that for all elements of the sequence $(\varepsilon_{k(m)})_m$ there holds

$$c_2 \text{vol}_2 V \leq \text{vol}_2 Q_m \leq c_3 \text{vol}_2 V \quad (4.84)$$

with the special choice $c_2 = \frac{3}{8}$, $c_3 = \frac{5}{8}$.

Step 2. Call moreover, for real numbers $a_1 < a_2$, $Z_m(a_1, a_2)$ the set of all points

$$Z_m(a_1, a_2) := \left\{ (\hat{\xi}, \xi_3) : \hat{\xi} \in Q_m, g(\hat{\xi}) + a_1 \leq \xi_3 \leq g(\hat{\xi}) + a_2 \right\},$$

and let $0 < h_{\pm} \leq h_0$.

Claim. There holds

$$\begin{aligned} & \int_{Z_m(-h_-, h_+)} |\nabla \varphi_m|^p d\xi \\ & \geq \frac{1}{(h_+ + h_-)^{p-1}} \int_{Q_m} \left| \varphi_m \left((\hat{\xi}, g(\hat{\xi})) + h_+ v \right) - \varphi_m \left((\hat{\xi}, g(\hat{\xi})) - h_- v \right) \right|^p d\hat{\xi}. \end{aligned} \quad (4.85)$$

Proof of the claim. Take a sequence $(\psi_n)_n$ in $C^\infty(\Omega_{\varepsilon_{k(m)}}; \mathbb{R}^3)$ such that $\psi_n \rightarrow \varphi_m$ in $W^{1,p}(\Omega_{\varepsilon_{k(m)}}; \mathbb{R}^3)$. From the Rellich-Kondrachov-embedding theorem, the fact that $p > 3$ and the regularity of the subbodies forming $\Omega_{\varepsilon_{k(m)}}$, one obtains $\psi_n \rightarrow \varphi_m$ uniformly on the closure of each of the subbodies, hence $\psi_n \rightarrow \varphi_m$ uniformly on $\bar{\Omega}$. For a $\hat{\xi} \in Q_m$ set $\alpha : (-h_-, h_+) \rightarrow \mathbb{R}^3$, $\alpha(t) := \psi_n((\hat{\xi}, g(\hat{\xi})) + t v)$. Then, since $t \mapsto (\hat{\xi}, g(\hat{\xi})) + t v$ describes a fibre in a beam of $\varepsilon_{k(m)} \mathcal{D}_{3,v}$ and ψ_n is smooth on $\Omega_{\varepsilon_{k(m)}} = \Omega \cap \varepsilon_{k(m)} \mathcal{D}_3$, α is a smooth curve in \mathbb{R}^3 connecting $\psi_n((\hat{\xi}, g(\hat{\xi})) - h_- v)$ and $\psi_n((\hat{\xi}, g(\hat{\xi})) + h_+ v)$. One obtains now

$$\begin{aligned} & \left| \psi_n \left((\hat{\xi}, g(\hat{\xi})) + h_+ v \right) - \psi_n \left((\hat{\xi}, g(\hat{\xi})) - h_- v \right) \right| \\ & \leq \text{“length of } \alpha \text{”} = \int_{-h_-}^{h_+} |\dot{\alpha}(t)| dt \\ & = \int_{-h_-}^{h_+} \left| \nabla \psi_n \left((\hat{\xi}, g(\hat{\xi})) + t v \right) \cdot v \right| dt. \end{aligned} \quad (4.86)$$

Using the change of variables formula and Fubini’s theorem one can write

$$\int_{Z_m(-h_-, h_+)} |\nabla \psi_n|^p d\xi = \int_{Q_m} \int_{-h_-}^{h_+} \left| \nabla \psi_n \left((\hat{\xi}, g(\hat{\xi})) + t v \right) \right|^p dt d\hat{\xi}. \quad (4.87)$$

Furthermore, recall that the matrix norm $|\cdot|$ can be estimated from below by

$|M| \geq \sup_{|w|=1} |Mw| \geq |Mv|$. This together with (4.87) and (4.86) gives

$$\begin{aligned}
& \int_{Z_m(-h_-, h_+)} |\nabla \psi_n|^p \, d\xi \\
& \geq \int_{Q_m} \int_{-h_-}^{h_+} \left| \nabla \psi_n \left((\hat{\xi}, g(\hat{\xi})) + tv \right) \cdot v \right|^p \, dt \, d\hat{\xi} \\
& \geq \int_{Q_m} \frac{1}{(h_+ + h_-)^{p-1}} \left(\int_{-h_-}^{h_+} \left| \nabla \psi_n \left((\hat{\xi}, g(\hat{\xi})) + tv \right) \cdot v \right|^p \, dt \right)^p \, d\hat{\xi} \\
& \geq \int_{Q_m} \frac{1}{(h_+ + h_-)^{p-1}} \left| \psi_n \left((\hat{\xi}, g(\hat{\xi})) + h_+ v \right) - \psi_n \left((\hat{\xi}, g(\hat{\xi})) - h_- v \right) \right|^p \, d\hat{\xi},
\end{aligned} \tag{4.88}$$

wherein one made also use of Jensen's inequality. Now taking the limit $n \rightarrow \infty$ on both sides of the inequality resulting from (4.88) proves the claim.

Step 3. Choose an $\eta \leq \frac{1}{M} c_2 \text{vol}_2 V \cdot h_0$, wherein $M \in \mathbb{N}$ is fixed and will be specified later. From Egorov's theorem one infers the existence of a $\Omega' \subseteq \Omega$ such that $\text{vol}(\Omega \setminus \Omega') < \eta$ and $\varphi_m \rightarrow \varphi$ uniformly on Ω' . By step 2 one realizes

$$\begin{aligned}
& \text{vol}(Z_m(0, h_0) \cap \Omega') \geq \text{vol} Z_m(0, h_0) - \text{vol}(\Omega \setminus \Omega') \\
& = \text{vol}_2 Q_m \cdot h_0 - \text{vol}(\Omega \setminus \Omega') \\
& \geq c_2 \text{vol}_2 V \cdot h_0 - \frac{1}{M} c_2 \text{vol}_2 V \cdot h_0 = \frac{M-1}{M} c_2 \text{vol}_2 V \cdot h_0.
\end{aligned} \tag{4.89}$$

Moreover, there is a special $H_+ \in (0, h_0)$ such that

$$P_m^+ := \left\{ \hat{\xi} : \hat{\xi} \in Q_m, (\hat{\xi}, g(\hat{\xi})) + H_+ v \in Z_m(0, h_0) \cap \Omega' \right\}$$

has volume $\text{vol}_2 P_m^+ \geq \frac{M-2}{M} c_2 \text{vol}_2 V$. This follows from the above inequality (4.89) and further

$$\begin{aligned}
& \frac{M-1}{M} c_2 \text{vol}_2 V \cdot h_0 \leq \text{vol}(Z_m(0, h_0) \cap \Omega') \\
& = \int_0^{h_0} \int_{Q_m} \mathbb{1}_{Z_m(0, h_0) \cap \Omega'} \left((\hat{\xi}, g(\hat{\xi})) + tv \right) \, d\hat{\xi} \, dt \\
& \leq h_0 \cdot \sup_{t \in (0, h_0)} \text{vol}_2 \left(\left\{ \hat{\xi} : \hat{\xi} \in Q_m, (\hat{\xi}, g(\hat{\xi})) + tv \in Z_m(0, h_0) \cap \Omega' \right\} \right),
\end{aligned}$$

which implies the existence of such H_+ . Analogously, there is an $H_- \in (0, h_0)$ such that

$$P_m^- := \left\{ \hat{\xi} : \hat{\xi} \in Q_m, (\hat{\xi}, g(\hat{\xi})) - H_- v \in Z_m(-h_0, 0) \cap \Omega' \right\}$$

has volume $\text{vol}_2 P_m^- \geq \frac{M-2}{M} c_2 \text{vol}_2 V$. Now set $P_m := P_m^+ \cap P_m^-$, remember (4.84) and obtain

$$\begin{aligned}
\text{vol}_2 P_m & = \text{vol}_2 P_m^+ + \text{vol}_2 P_m^- - \text{vol}_2 (P_m^+ \cup P_m^-) \\
& \geq \text{vol}_2 P_m^+ + \text{vol}_2 P_m^- - \text{vol}_2 Q_m \\
& \geq 2 \frac{M-2}{M} c_2 \text{vol}_2 V - c_3 \text{vol}_2 V = \left(2 \frac{M-2}{M} c_2 - c_3 \right) \text{vol}_2 V.
\end{aligned}$$

Having in mind $c_2 = \frac{3}{8}$ and $c_3 = \frac{5}{8}$, setting e.g. $M = 13$ gives the estimate

$$\text{vol}_2 P_m \geq \frac{1}{104} \text{vol}_2 V, \quad (4.90)$$

which is independent of m .

Step 4. In the estimate (4.85) of step 2 choose now $h_{\pm} := H_{\pm}$. One then arrives at

$$\begin{aligned} & \int_{\Omega} |\nabla \varphi_m|^p \, d\xi \geq \int_{Z_m(-H_-, H_+)} |\nabla \varphi_m|^p \, d\xi \\ & \geq \frac{1}{(H_+ + H_-)^{p-1}} \int_{Q_m} \left| \varphi_m \left((\hat{\xi}, g(\hat{\xi})) + H_+ v \right) - \varphi_m \left((\hat{\xi}, g(\hat{\xi})) - H_- v \right) \right|^p \, d\hat{\xi} \\ & \geq \frac{1}{(H_+ + H_-)^{p-1}} \int_{P_m} \left| \varphi_m \left((\hat{\xi}, g(\hat{\xi})) + H_+ v \right) - \varphi \left((\hat{\xi}, g(\hat{\xi})) + H_+ v \right) \right. \\ & \quad \left. + \varphi \left((\hat{\xi}, g(\hat{\xi})) + H_+ v \right) - \varphi \left((\hat{\xi}, g(\hat{\xi})) - H_- v \right) \right. \\ & \quad \left. + \varphi \left((\hat{\xi}, g(\hat{\xi})) - H_- v \right) - \varphi_m \left((\hat{\xi}, g(\hat{\xi})) - H_- v \right) \right|^p \, d\hat{\xi}. \end{aligned}$$

By construction one has for every $\hat{\xi} \in P_m$ the inclusion $(\hat{\xi}, g(\hat{\xi})) + H_{\pm} v \in Z_m(0, \pm h_0) \cap \Omega' \subseteq \Omega'$. Thus for all but finitely many m one infers from the uniform convergence of $\varphi_m \rightarrow \varphi$ on Ω' and (4.83)

$$\left| \varphi_m \left((\hat{\xi}, g(\hat{\xi})) \pm H_{\pm} v \right) - \varphi \left((\hat{\xi}, g(\hat{\xi})) \pm H_{\pm} v \right) \right| \leq \frac{c_1}{4}$$

for all $\hat{\xi} \in P_m$. From this, together with (4.83) one further deduces

$$\begin{aligned} \int_{\Omega} |\nabla \varphi_m|^p \, d\xi & \geq \frac{1}{(H_+ + H_-)^{p-1}} \int_{P_m} \left(c_1 - \frac{c_1}{4} - \frac{c_1}{4} \right)^p \, d\hat{\xi} \\ & = \frac{1}{(H_+ + H_-)^{p-1}} \frac{c_1^p}{2^p} \text{vol}_2 P_m \\ & \stackrel{(4.90)}{\geq} \frac{1}{104} \frac{c_1^p}{2^p} \text{vol}_2 V \frac{1}{(2h_0)^{p-1}} \end{aligned}$$

for all but finitely many m . But h_0 can be chosen arbitrarily small, whence one infers

$$\liminf_{m \rightarrow \infty} \int_{\Omega} |\nabla \varphi_m|^p \, d\xi = \infty,$$

finishing the proof of the lemma. \square

With Lemma 4.21 at hand, it is no longer difficult to prove the Γ -lim inf-inequality for the Γ -convergence stated in Theorem 4.20. Therefore, let $\varphi \in$

$SBV^p(\Omega; \mathbb{R}^3) \cap \text{Kin}(\Omega; \mathbf{Box})$ such that S_φ is contained in a piecewise C^1 -hypersurface, and $(\varphi_k)_k$ be a sequence in $SBV^p(\Omega; \mathbb{R}^3) \cap \text{Kin}(\Omega; \mathbf{Box})$, which strongly converges to φ in $L^1(\Omega; \mathbb{R}^3)$.

In the first case, where $\nu_{\varphi,1} = \nu_{\varphi,2} = 0$ in \mathcal{H}^2 -a.e. point of S_φ , by definition of \mathcal{F}_{Hom} one has $\mathcal{F}_{\text{Hom}}(\varphi) = \int_{\Omega} W(\nabla\varphi) dx + \int_{S_\varphi} \theta(|\varphi^+ - \varphi^-|) d\mathcal{H}^2$. If $\liminf_k \mathcal{F}_{\varepsilon_k}(\varphi_k) = \infty$, there is nothing to show. Now let

$$\infty > \liminf_{k \rightarrow \infty} \mathcal{F}_{\varepsilon_k}(\varphi_k) = \lim_{m \rightarrow \infty} \mathcal{F}_{\varepsilon_{k(m)}}(\varphi_{k(m)}). \quad (4.91)$$

for some subsequence $(k(m))_m$. By the form of $(\mathcal{F}_{\varepsilon_k})_k$ – see (4.1) – one may then assume that

$$\varphi_{k(m)} \in W^{1,p}(\Omega_{\varepsilon_{k(m)}}; \mathbb{R}^3) \cap \text{Kin}(\Omega; \mathbf{Box}) \quad \text{for all } m \in \mathbb{N}. \quad (4.92)$$

From the first statement in Corollary 3.30 (wherein one sets $M := SBV^p(\Omega; \mathbb{R}^3)$, $\phi := |\cdot|$ and $\hat{F} := 0$) one then infers

$$\begin{aligned} \mathcal{F}_{\text{Hom}}(\varphi) &\leq \liminf_{m \rightarrow \infty} \left(\int_{\Omega} W(\nabla\varphi_{k(m)}) dx + \int_{S_{\varphi_{k(m)}}} \theta(|\varphi_{k(m)}^+ - \varphi_{k(m)}^-|) d\mathcal{H}^2 \right) \\ &= \liminf_{m \rightarrow \infty} \mathcal{F}_{\varepsilon_{k(m)}}(\varphi_{k(m)}) = \liminf_{k \rightarrow \infty} \mathcal{F}_{\varepsilon_k}(\varphi_k), \end{aligned}$$

cf. Remark 4.1 for the first equality. For the present situation one infers then the validity of the Γ -lim inf-inequality in φ .

In the remaining case where $\nu_{\varphi,1} \neq 0$ or $\nu_{\varphi,2} \neq 0$ on a subset of S_φ of positive \mathcal{H}^2 -measure, the definition of the homogenized total energy states $\mathcal{F}_{\text{Hom}}(\varphi) = \infty$. Assume $\infty > \liminf_k \mathcal{F}_{\varepsilon_k}(\varphi_k)$. Consequently, there hold (4.91) and (4.92) for an appropriate subsequence $(k(m))_m$. However, one is told by Lemma 4.21 that

$$\liminf_{m \rightarrow \infty} \int_{\Omega} |\nabla\varphi_{k(m)}|^p dx = \infty.$$

With the help of condition (W2) one concludes

$$\begin{aligned} \infty &> \liminf_{k \rightarrow \infty} \mathcal{F}_{\varepsilon_k}(\varphi_k) = \lim_{m \rightarrow \infty} \mathcal{F}_{\varepsilon_{k(m)}}(\varphi_{k(m)}) \\ &\geq \liminf_{m \rightarrow \infty} \left(\alpha_1 \int_{\Omega} |\nabla\varphi_{k(m)}|^p dx - \alpha_2 \text{vol } \Omega \right) = \infty, \end{aligned}$$

which provides a contradiction. Therefore one must have $\infty = \liminf_k \mathcal{F}_{\varepsilon_k}(\varphi_k)$ and again the Γ -lim inf-inequality holds true in φ . \square

4.5.3 Proof of the Γ -lim sup-inequality

Consider a deformation $\varphi \in SBV^p(\Omega; \mathbb{R}^3) \cap \text{Kin}(\Omega; \mathbf{Box})$ such that S_φ is contained in a piecewise C^1 -hypersurface S .

In case $\nu_{\varphi,1} \neq 0$ or $\nu_{\varphi,2} \neq 0$ on a subset of S_φ of positive \mathcal{H}^2 -measure, by definition one has $\mathcal{F}_{\text{Hom}}(\varphi) = \infty$ and there remains nothing to show.

Now suppose $\nu_{\varphi,1} = \nu_{\varphi,2} = 0$ in \mathcal{H}^2 -a.e. point of S_φ , assume without loss of generality $\mathcal{F}_{\text{Hom}}(\varphi) < \infty$. A recovery-sequence for φ will be constructed in the following two-stage procedure.

Step 1. By definition of being piecewise C^1 , S can like in Definition 3.36 be written as the finite union of C^1 -hypersurfaces S_1, \dots, S_ℓ . Exploiting the inclusion $S_\varphi \subseteq S$ and Proposition 3.38, one obtains that on every S_i there holds $\nu_{S_i} = e_3$ or $-e_3$. Thus for every $i \in \{1, \dots, \ell\}$, S_i is contained in a plane $H_i = \{(\hat{x}, x_3) \in \mathbb{R}^3 : x_3 = a_i\}$ parallel to the x_1x_2 -coordinate plane, for some $a_i \in (-a, a)$ (recall $\Omega = \omega \times (-a, a)$ according to Definition of Geometry 2.3). Without loss of generality assume the a_1, \dots, a_ℓ to be pairwise disjoint. Then for small enough ε_k , the environments

$$\mathcal{T}_{k,i} := \{x : x \in \Omega, x_3 \in [a_i - 3\varepsilon_k, a_i + 3\varepsilon_k]\}$$

separate the hyperplanes $H_1 \cap \Omega, \dots, H_\ell \cap \Omega$ from each other. Specifying the heuristical argument for the homogenized surface energy given in subsection 4.5.1, one proceeds as follows. For each $\mathcal{T}_{k,i}$, one constructs a pre-deformation $\Phi_{k,i} : \mathcal{T}_{k,i} \rightarrow \mathcal{T}_{k,i}$, which equals the identity on the upper and lower boundary of $\mathcal{T}_{k,i}$ and lifts the nearest plane $\{(\hat{x}, x_3) \in \Omega : x_3 = z\} \subseteq \varepsilon_k \partial \mathcal{D}_3$ (some $z \in \varepsilon_k \mathbb{Z}$) onto $H_i \cap \Omega$. Indeed, this can be easily achieved as follows: Let $z_{k,i} \in \varepsilon_k \mathbb{Z}$ be such that $|z_{k,i} - a_i| \leq \frac{\varepsilon_k}{2}$. Set

$$\Phi_{k,i}(\hat{x}, x_3) := \begin{cases} \left[\hat{x}, \frac{3\varepsilon_k}{a_i + 3\varepsilon_k - z_{k,i}} (x_3 - (a_i + 3\varepsilon_k)) + a_i + 3\varepsilon_k \right]^T & \text{if } (\hat{x}, x_3) \in \mathcal{T}_{k,i}, x_3 \geq z_{k,i}, \\ \left[\hat{x}, \frac{3\varepsilon_k}{z_{k,i} - (a_i - 3\varepsilon_k)} (x_3 - (a_i - 3\varepsilon_k)) + a_i - 3\varepsilon_k \right]^T & \text{if } (\hat{x}, x_3) \in \mathcal{T}_{k,i}, x_3 \leq z_{k,i}, \end{cases}$$

then it is easy to see that $\Phi_{k,i}$ is a coordinate transformation in the sense of Corollary 3.39 and there are k -independent positive constants c_1, c_2, c_3 such that

$$\begin{aligned} c_1 &\leq \det D\Phi_{k,i} \leq c_2 \\ |D\Phi_{k,i}| &\leq c_3 \end{aligned} \tag{4.93}$$

uniformly on $\mathcal{T}_{k,i}$. After declaring $\Phi_k : \Omega \rightarrow \Omega$ to equal $\Phi_{k,i}$ on $\mathcal{T}_{k,i}$ for all $i = 1, \dots, \ell$ and extending it to the remaining parts of Ω by the identity mapping,

one obtains again a coordinate transformation in the sense of Corollary 3.39 and a (4.93)-type estimate holds for Φ_k uniformly on Ω with k -independent constants. Moreover, by construction one has

$$\begin{aligned}\Phi_k^{-1}(S) &= \Phi_k^{-1} \left(\bigcup_{i=1}^{\ell} S_i \right) \subseteq \bigcup_{i=1}^{\ell} \Phi_k^{-1}(H_i \cap \Omega) \\ &\subseteq \bigcup_{i=1}^{\ell} \{(\hat{x}, x_3) \in \Omega : x_3 = z_{k,i}\} \subseteq \varepsilon_k \partial \mathcal{D}_3.\end{aligned}$$

Step 2. One declares for all by finitely many $k \in \mathbb{N}$ the sequence $(\varphi_k)_k$ by composition $\varphi_k := \varphi \circ \Phi_k$. First, by means of Proposition 4.3 one deduces $\varphi \in SBV^p(\Omega; \mathbb{R}^3) \cap \text{Kin}(\Omega; \mathbf{Box})$. Secondly, with the help of Proposition 3.23 and the last inclusion established in step 1 one obtains $S_{\varphi_k} = \Phi_k^{-1}(S_{\varphi}) \subseteq \varepsilon_k \partial \mathcal{D}_3$, and an application of Proposition 3.40 eventually gives

$$\varphi_k \in W^{1,p}(\Omega \setminus \varepsilon_k \partial \mathcal{D}_3; \mathbb{R}^3) = W^{1,p}(\Omega_{\varepsilon_k}; \mathbb{R}^3).$$

Like in step 4 and step 5 of the proof of Lemma 4.6 one then shows

$$\varphi_k \rightarrow \varphi \quad \text{in } L^1(\Omega; \mathbb{R}^3) \quad \text{and} \quad \int_{\Omega} W(\nabla \varphi_k) \, dx \rightarrow \int_{\Omega} W(\nabla \varphi) \, dx. \quad (4.94)$$

Furthermore, it holds true that

$$\begin{aligned}& \int_{S_{\varphi_k}} \theta(|\varphi_k^+ - \varphi_k^-|) \, d\mathcal{H}^2 = \sum_{i=1}^{\ell} \int_{\omega} \theta(|\varphi_k^+(\hat{x}, z_{k,i}) - \varphi_k^-(\hat{x}, z_{k,i})|) \, d\hat{x} \\ &= \sum_{i=1}^{\ell} \int_{\omega} \theta(|(\varphi^+ - \varphi^-) \circ \Phi_k(\hat{x}, z_{k,i})|) \, d\hat{x} \\ &= \sum_{i=1}^{\ell} \int_{\omega} \theta(|\varphi^+(\hat{x}, a_i) - \varphi^-(\hat{x}, a_i)|) \, d\hat{x} = \sum_{i=1}^{\ell} \int_{H_i \cap \Omega} \theta(|\varphi^+ - \varphi^-|) \, d\mathcal{H}^2 \\ &= \int_{S_{\varphi}} \theta(|\varphi^+ - \varphi^-|) \, d\mathcal{H}^2.\end{aligned}$$

This together with (4.94) results in

$$\lim_{k \rightarrow \infty} \mathcal{F}_{\varepsilon_k}(\varphi_k) = \mathcal{F}(\varphi)$$

and consequently, $(\varphi_k)_k$ is indeed a recovery sequence. The Γ -lim sup-inequality for the convergence stated in Theorem 4.20 is proved. \square

4.5.4 Mathematical discussion and mechanical interpretation

Mathematically, the author advises the reader that the Γ -convergence result for the sequence $(\mathcal{F}_{\varepsilon_k})_k$ is partial in the sense that Γ -convergence towards the homogenization limit \mathcal{F}_{Hom} was shown only on the subset of $SBV^p(\Omega; \mathbb{R}^3) \cap \text{Kin}(\Omega; \mathbf{Box})$, the elements of which have their discontinuity set contained in a piecewise C^1 -hypersurface. Yet, the reader should also notice that this class contains all the physically relevant deformations. Furthermore, the homogenization limit \mathcal{F}_{Hom} exhibits again the property of being sequentially lower semicontinuous (which a Γ -limit necessarily needs to have) and admits a minimizer.

Proposition 4.22. *Let the assumptions of Theorem 4.20 hold and \mathcal{F}_{Hom} be given as in (4.82). Then*

- (i) \mathcal{F}_{Hom} is sequentially lower semicontinuous w.r.t. the strong $L^1(\Omega; \mathbb{R}^3)$ -topology,
- (ii) there is a minimizer of \mathcal{F}_{Hom} on $SBV^p(\Omega; \mathbb{R}^3) \cap \text{Kin}(\Omega; \mathbf{Box})$.

Proof. Define $M := \{\varphi : \varphi \in SBV^p(\Omega; \mathbb{R}^3), \nu_{\varphi,1} = \nu_{\varphi,2} = 0 \text{ } \mathcal{H}^2\text{-a.e. on } S_\varphi\}$ and deduce with the help of Proposition 3.31 its closedness w.r.t. weak convergence in $SBV^p(\Omega; \mathbb{R}^3)$. The assertion now follows from Corollary 3.30 (upon setting therein $\phi := |\cdot|$ and $\hat{F} := 0$). \square

Fare more interesting is the mechanical interpretation of the homogenization result obtained for the three-dimensional many-body structure with nonzero cord-angle. Recall, that according to the definition of $\mathcal{F}_{\varepsilon_k}$, cracks along vertical adherends are energetically attainable in every many-body structure Ω_{ε_k} . In particular it can in thickness-direction be penetrated by foreign objects up to every depth, even be broken through. In the homogenization limit \mathcal{F}_{Hom} in contrast, only deformations with horizontal, i.e. to the beam layers in Ω_{ε_k} parallel crack surfaces can be of finite energy. Hence, the homogenized body possesses less kinematic degrees of freedom than the many-body structures Ω_{ε_k} , it is subject to *new kinematic constraints, which have been derived rigorously in the sense of Γ -convergence*. Since nonhorizontal crack surfaces are energetically unattainable in the homogenization limit, the homogenized body can – other than the many-body structures Ω_{ε_k} – not be penetrated vertically. Consequently, one infers that *many-body structures of microstructure \mathcal{D}_3 with nonzero cord-angle protect against penetration as the structure composes of more and more subbodies*. In this respect the present result obtained by the author poses as one of the occasions on which homogenization gives a strict justification of functional design.

Like in the cases of the many-body structures studied before, off the crack sites the homogenized body shows the same elastic properties as did the constituents

of the many-body structures Ω_{ε_k} . Also the surface energy in \mathcal{F}_{Hom} is the same as in the total energies $\mathcal{F}_{\varepsilon_k}$ of the many-body structures Ω_{ε_k} . Thus, the energetic cost for crack-opening in the homogenized body is exactly the same as in a many-body structure Ω_{ε_k} .

Another noteworthy feature of the homogenized body is its isotropy w.r.t. bending about horizontal axis. To this end, the author emphasizes that *the homogenization limit is independent of the cord-angle* $0 < \gamma \leq \frac{\pi}{2}$. In order to illustrate the mentioned bending-isotropy of the homogenized body, suppose the material occupying the many-body structures Ω_{ε_k} to be isotropic, i.e. $W(FQ) = W(F)$ for all $Q \in \text{SO}(3)$ and all $F \in \mathbb{M}^3$. Moreover, let the macroscopic shape $\Omega = \omega \times (-a, a)$ of the many-body structures Ω_{ε_k} be a circular cylinder, centered at the origin, cf. Figure 4.20, and let X be an arbitrary line in the x_1x_2 -plane. It is clear, that the resistance a many-body structure Ω_{ε_k} offers to bending about the axis X highly depends on the one hand on the cord-angle, and on the other hand on the angular position of X . For example, a many-body structure with very small cord-angle will resist bending about the x_2 -axis much stronger, than bending w.r.t. x_1 -axis (see also Figure 4.20). However, the homogenization limit \mathcal{F}_{Hom} is

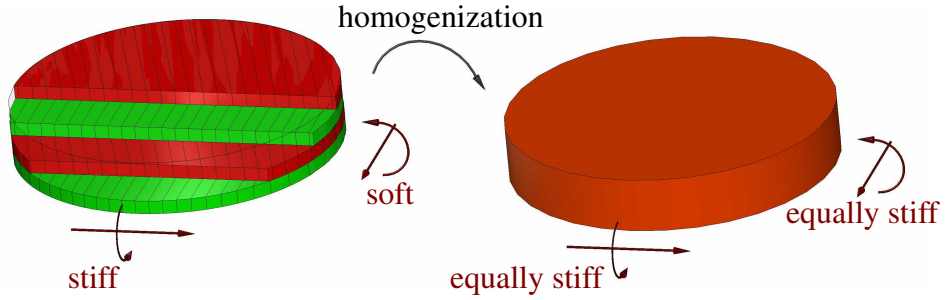

Figure 4.20: Nonzero cord-angle: Bending-isotropy through homogenization

invariant under rotations of the coordinate frame describing the undeformed configuration about the x_3 -axis. This is due to isotropy of the elastic energy density, the symmetry of Ω w.r.t. the x_3 -axis and the invariance of the set

$$\{\varphi : \varphi \in SBV^p(\Omega; \mathbb{R}^3) \cap \text{Kin}(\Omega; \mathbf{Box}), \nu_{\varphi,1} = \nu_{\varphi,2} = 0 \mathcal{H}^2\text{-a.e. on } S_{\varphi}\}$$

under rotations of the coordinate frame describing the undeformed configuration about the x_3 -axis (φ belongs to this set if and only if $\varphi(Q \cdot)$ does, where Q is an arbitrary rotation about the x_3 -axis). Consequently, the bending behaviour of the homogenized body is the same for all bending-axis X in the x_1x_2 -plane, which are equal up to rotation about the x_3 -axis. It depends only on the distance of the bending axis from the origin, is thus in this sense isotropic w.r.t. bending about horizontal axis. Other than the many-body structures Ω_{ε_k} . The author's homogenization result for the 3D many-body structures with nonzero cord-angle

can therefore be viewed as an example, where *homogenization results in a gain of isotropy*. This should in particular be compared with the earlier homogenization of the 2D-structure or the 3D-structure with zero cord-angle, where the author observed a loss of isotropy.

As a last interesting property of the homogenization result, the author would like to highlight, that the by \mathcal{F}_{Hom} described homogenized body behaves like a laminate of thin horizontal plates, i.e. like a laminate of *two-dimensional* objects. This observation should be compared with the geometry of the present many-body structures Ω_{ε_k} , which are composed of laminated beams, that is, from a mechanical point of view, only of *one-dimensional* objects. Hence, the present result gives evidence, that an appropriate geometric arrangement of low dimensional, laminated bodies shows – as one employes more and more bodies – the same mechanical properties like a laminate of higher dimensional objects.

APPENDIX A

MATHEMATICAL DEFINITIONS AND NOTATION

In the sequel, for the sake of completeness the author states several basic mathematical definitions and notational conventions, which were used throughout the thesis on various occasions. Since being intended as a quick reference for the main part of the thesis, they are given in form of a list.

A.1 DENOMINATION OF CONVERGENCE

In a metric space (X, d) , $x_k, x \in X$ ($k \in \mathbb{N}$) convergence is denoted

$$x_k \rightarrow x \quad :\Leftrightarrow \quad d(x_k, x) \rightarrow 0 \quad \text{in } \mathbb{R}.$$

In a normed vector space $(V, \|\cdot\|)$, $v_k, v \in V$ ($k \in \mathbb{N}$) one uses the notation

$$v_k \rightarrow v \quad :\Leftrightarrow \quad \|v_k - v\| \rightarrow 0 \quad \text{in } \mathbb{R}.$$

$$v_k \rightharpoonup v \quad :\Leftrightarrow \quad v_k \text{ converges to } v \text{ in the weak topology of } V \text{ (if not explicitly defined otherwise, cf. Definition 3.24 for the use in } SBV^p).$$

A.2 DOMAINS, BALLS, SPHERES

Let $(V, \|\cdot\|)$ be a normed vector space, M a subset of V , $\lambda \in \mathbb{R}$ and $b \in V$.

A domain in V is an open and connected subset of V .

∂M denotes the boundary of M .

λM := $\{\lambda v : v \in M\}$ is the λ -homothety of M .

- $M + b$:= $\{v + b : v \in M\}$ denominates the translation of M by the vector b .
- $B_r(x)$:= $\{v : v \in V, \|v - x\| < r\}$ is the open ball centered at $x \in V$ with radius $r > 0$.
- S_V := $\{v : v \in V, \|v\| = 1\}$ is the unit sphere in V .
- S^{N-1} denotes the unit sphere in the with the Euclidean norm equipped \mathbb{R}^N .
- $\mathbb{1}_M$ is the set indicator function of M , i.e. $\mathbb{1}_M(v) = 1$ for $v \in M$ and 0 elsewhere in V .

A.3 POLYHEDRAL SETS

A k -dimensional simplex in \mathbb{R}^N is the convex hull of $(k + 1)$ points, which are not contained in a $(k - 1)$ -dimensional hyperplane of \mathbb{R}^N .

A polyhedral set in \mathbb{R}^N is the union of finitely many $(N - 1)$ -dimensional simplexes.

Consider a polyhedral set P in \mathbb{R}^2 .

$\text{Knot}(P)$ denotes the set of all knots of P and is defined as

$$\text{Knot}(P) := \left\{ K : K \in P \text{ such that} \right. \\ \left. \begin{array}{l} \exists v_1, v_2 \in S^1 \text{ linearly independent} \\ \text{and } \exists \delta > 0 : \\ K + tv_i \in P \forall t \in (0, \delta), i = 1, 2 \\ \text{or} \\ \exists v \in S^1, \exists \delta > 0 : \\ K + tv \in P \text{ and } K - tv \notin P \forall t \in (0, \delta) \end{array} \right\}.$$

A face of P is a subset L of P , such that there exist $K_1, K_2 \in \text{Knot}(P)$, $K_1 \neq K_2$, with $L = \text{conv}\{K_1, K_2\}$ and for all $K \in \text{Knot}(P)$ with $K \in L$ there holds either $K = K_1$ or $K = K_2$.

$\text{Face}(P) := \{L : L \text{ is a face of } P\}$ is the set of all faces of P . In particular $P = \bigcup \text{Face}(P)$, and $\mathcal{H}^1(L_1 \cap L_2) = 0$ for all unequal pair of faces $L_1, L_2 \in \text{Face}(P)$.

A.4 REGULARITY OF DOMAINS

Let Ω be a domain in \mathbb{R}^N .

Ω is Lipschitzian, if for every point $x \in \partial\Omega$ there is $r > 0$ and a Lipschitz-continuous function $f : \mathbb{R}^{N-1} \rightarrow \mathbb{R}$ such that – upon rotating and relabeling the coordinate axis if necessary – there holds

$$\Omega \cap Q_r(x) = \{y : f(y_1, \dots, y_{N-1}) < y_N\} \cap Q_r(x),$$

where $Q_r(x) = \{y : |y_i - x_i| < r, i = 1, \dots, N\}$. See [Evans and Gariepy, 1992, Section 4.2] for this definition.

Ω is nonoscillating, if the intersection of Ω with an arbitrary $(N - 1)$ -dimensional simplex has a finite number of connected components. In particular, the intersection of a two-dimensional nonoscillating domain with a line segment is a finite union of lines segments.

Remark A.1 (On nonoscillating domains). The property of being nonoscillating is *not* connected with the smoothness of a domain's boundary. Indeed, suppose Ω to be two-dimensional and contained in the upper half space $\{x : x \in \mathbb{R}^2, x_2 > 0\}$. Assume furthermore that its boundary can in an environment of the origin be parametrized by the function

$$f : \mathbb{R} \rightarrow \mathbb{R}, \quad f(x) := \begin{cases} x^m \sin\left(\frac{1}{x}\right) & \text{if } x > 0, \\ 0 & \text{if } x \leq 0, \end{cases}$$

with m a natural number not smaller than 3. Some elementary analysis reveals that $f \in C^\kappa(\mathbb{R})$, where $\kappa = \max\{k \in \mathbb{N} : k < \frac{m}{2}\}$. One may assume also the rest of the boundary of Ω to be of class C^κ . Hence, by choosing m large enough $\partial\Omega$ reaches every arbitrary level of smoothness. However, for every $m \in \mathbb{N}, m \geq 3$, it oscillates across the horizontal axis, making the intersection of Ω with the line segment $\text{conv}\{(0, 0), (1, 0)\}$ the union of infinitely many disjoint line segments. Obviously then, Ω does not satisfy the property of being nonoscillating.

A.5 VECTORS AND MATRICES

A.5.1 Vector-calculus

For every vector u in \mathbb{R}^N one refers to its components as $u_i, i \in \{1, \dots, N\}$. In case a vector already carries another index, e.g. u_{index} , one denotes its i th

component as $u_{\text{index},i}$. When writing $u \in \mathbb{R}^N$ by means of its components, the author either uses the notation $u = (u_1, \dots, u_N)$, or $u = [u_1, \dots, u_N]^T$ in order to emphasize its nature as a column vector.

e_i is the i th unit vector in \mathbb{R}^N ($i \in \{1, \dots, N\}$), that is $e_{i,i} = 1$ and $e_{i,j} = 0$ for all $j \neq i$.

Let u, v be elements of \mathbb{R}^N .

$u \cdot v := \sum_{i=1}^N u_i v_i$ denotes the standard scalar product in \mathbb{R}^N .

$|u| := \sqrt{u \cdot u}$ is the Euclidean norm in \mathbb{R}^N .

A.5.2 Matrix-calculus

The components of a matrix $A \in \mathbb{R}^{M \times N}$ are denoted as A_{ij} , $i \in \{1, \dots, M\}$, $j \in \{1, \dots, N\}$, the matrix itself is by means of its components written as

$$A = \begin{bmatrix} A_{11} & \cdots & A_{1N} \\ \vdots & & \vdots \\ A_{M1} & \cdots & A_{MN} \end{bmatrix} = (A_{ij})_{i=1, \dots, M, j=1, \dots, N}.$$

Let A, B be in $\mathbb{R}^{M \times N}$, $u \in \mathbb{R}^M$ and $v \in \mathbb{R}^N$.

$A : B := \sum_{i=1}^M \sum_{j=1}^N A_{ij} B_{ij}$ denotes the standard scalar product in $\mathbb{R}^{M \times N}$.

$|A| := \sqrt{A : A}$ stands for the Euclidean norm in $\mathbb{R}^{M \times N}$.

$u \otimes v \in \mathbb{R}^{M \times N}$ is the outer product of u and v , i.e. $(u \otimes v)_{ij} = u_i v_j$.

Moreover, one denotes with

I the identity matrix in $\mathbb{R}^{N \times N}$.

Now consider some F in $\mathbb{R}^{N \times N}$.

$\det F$ is the determinant of F .

$\text{Cof } F := (\det F) F^{-T}$ is, for invertible F , called the cofactor matrix of F .

Because of their importance and frequent use in continuum mechanics, the following subsets of $\mathbb{R}^{N \times N}$ are denoted by special symbols.

$\mathbb{M}^N \equiv \mathbb{R}^{N \times N}$ is the set of all real $(N \times N)$ -matrices.

$\mathbb{M}_{>}^N$ contains all matrices in \mathbb{M}^N with positive determinant.

\mathbb{S}^N is the set of all symmetric \mathbb{M}^N -matrices.

- $\mathbb{S}_{>}^N$ denotes the set of all symmetric, positive definite matrices in \mathbb{M}^N .
- $\text{SO}(N)$ contains all rotations in \mathbb{M}^N , i.e. all $Q \in \mathbb{M}^N$ such that $Q^T Q = I$ and $\det Q = 1$.

A.6 TERMS FROM MEASURE THEORY

- λ^N is the N -dimensional Lebesgue-measure on \mathbb{R}^N .
- $\text{vol} := \lambda^N$,
- $\text{vol}_k := \lambda^k$ for some $k \in \mathbb{N}$.
- \mathcal{H}^{N-1} denotes the $(N - 1)$ -dimensional Hausdorff-measure (in \mathbb{R}^N).

Let Ω be an open and bounded subset of \mathbb{R}^N , μ a finite $\mathbb{R}^{M \times K}$ -valued Radon-measure on Ω , $\mathcal{B}(\Omega)$ be the Borel- σ -algebra on Ω (cf. Definition 3.8 for these concepts) and M be a $\mathcal{B}(\Omega)$ -measurable subset of Ω .

- $\mu \llcorner M$ is the restriction of μ to M , that is $(\mu \llcorner M)(A) := \mu(M \cap A)$ for all $A \in \mathcal{B}(\Omega)$.

Recall the definition of the total variation measure $|\mu|$ of μ (see again Definition 3.8). Moreover, ν shall be a positive Radon-measure on Ω , i.e. an \mathbb{R} -valued Radon-measure on Ω that attains only positive values.

- Absolute continuity: μ is absolutely continuous w.r.t. ν , if for every $A \in \mathcal{B}(\Omega)$ with $\nu(A) = 0$ there holds $|\mu|(A) = 0$.
- Singularity: μ and ν are mutually singular, if there is a set $E \in \mathcal{B}(\Omega)$ such that $\nu(E) = 0$ and $|\mu|(\Omega \setminus E) = 0$.

A.7 CONTINUOUS AND CONTINUOUSLY DIFFERENTIABLE FUNCTIONS

Choose Ω as an open and bounded subset of \mathbb{R}^N .

A.7.1 Spaces of continuous and continuously differentiable functions

The spaces $C(\Omega; \mathbb{R}^{M \times K})$, $C_c(\Omega; \mathbb{R}^{M \times K})$ and $C^k(\Omega; \mathbb{R}^{M \times K})$, $C_c^k(\Omega; \mathbb{R}^{M \times K})$ and $C^\infty(\Omega; \mathbb{R}^{M \times K})$, $C_c^\infty(\Omega; \mathbb{R}^{M \times K})$ denote respectively the usual spaces of functions

with continuous or k times continuously differentiable ($k \in \mathbb{N}$) or smooth components. The index c indicates, that all elements of the respective space have compact support.

$C_0(\Omega; \mathbb{R}^{M \times K})$ is defined as the closure of $C_c(\Omega; \mathbb{R}^{M \times K})$ in the supremum norm (cf. Theorem 3.10).

Assume the function $u : \Omega \rightarrow \mathbb{R}^M$ to be Lipschitz-continuous, and let V be a subset of Ω .

$\text{Lip}(u, V)$ is the Lipschitz-constant of u on V , that is, the smallest $M \geq 0$ such that $|u(x) - u(y)| \leq M |x - y|$ holds for all $x, y \in V$.

$\text{Lip}(u) := \text{Lip}(u, \Omega)$.

A.7.2 Differential calculus for continuously differentiable functions

Consider some $u \in C^1(\Omega; \mathbb{R}^{M \times N})$.

$D_k u_{ij}$ denotes the classical partial derivative of the component u_{ij} w.r.t. the k th argument.

$\text{div } u$ is pointwise in Ω defined as the vector

$$\text{div } u := \left[\sum_{j=1}^N D_j u_{1j}, \dots, \sum_{j=1}^N D_j u_{Mj} \right]^T.$$

A.8 L^p -SPACES, DISTRIBUTIONAL DERIVATIVES AND SOBOLEV-SPACES

Again let Ω denote some open and bounded subset of \mathbb{R}^N .

A.8.1 L^p -spaces

The author uses standard notation for the Lebesgue-spaces $L^p(\Omega; \mathbb{R}^{M \times K})$ ($1 \leq p \leq \infty$) equipped with the standard norm $\|\cdot\|_{L^p(\Omega; \mathbb{R}^{M \times K})}$. That is

$L^p(\Omega; \mathbb{R}^{M \times K})$ is the space of all $\mathcal{B}(\Omega)$ -measurable functions $u : \Omega \rightarrow \mathbb{R}^{M \times K}$ with $\int_{\Omega} |u|^p dx < \infty$ ($1 \leq p < \infty$). Two functions, which agree a.e. in Ω , are identified as one element therein.

$L^\infty(\Omega; \mathbb{R}^{M \times K})$ denotes the space of all $\mathcal{B}(\Omega)$ -measurable functions $u : \Omega \rightarrow \mathbb{R}^{M \times K}$, for which there exists a bound $M \in [0, \infty)$ such

that $|u(x)| \leq M$ for a.a. $x \in \Omega$. Again, two functions, which agree a.e. in Ω , are identified as one element therein.

The corresponding norms are in every element u of the respective spaces given as

$$\|u\|_{L^p(\Omega; \mathbb{R}^{M \times K})} := \left(\int_{\Omega} |u|^p dx \right)^{1/p}$$

for $1 \leq p < \infty$,

$$\|u\|_{L^\infty(\Omega; \mathbb{R}^{M \times K})} := \inf \{M : M \in [0, \infty), |u(x)| \leq M \text{ for a.a. } x \in \Omega\}.$$

A.8.2 Distributional derivatives

Consider some $u \in L^1(\Omega; \mathbb{R}^M)$.

Du denotes the distributional derivative of u , i.e. the distribution Du such that

$$\int_{\Omega} u \cdot \operatorname{div} \psi dx = -Du(\psi)$$

holds for all $\psi \in C_c^\infty(\Omega; \mathbb{R}^{M \times N})$.

A.8.3 Sobolev-spaces

Like in the case of L^p -spaces, the author employs standard notation for the Sobolev-spaces $W^{1,p}(\Omega; \mathbb{R}^M)$ ($1 \leq p \leq \infty$) and denotes the standard norm therein with $\|\cdot\|_{W^{1,p}(\Omega; \mathbb{R}^M)}$. More specifically, the definition reads

$W^{1,p}(\Omega; \mathbb{R}^M)$ is the space of all $u \in L^p(\Omega; \mathbb{R}^M)$, the distributional derivative of which can be represented by some $Du \in L^p(\Omega; \mathbb{R}^{M \times N})$.

The corresponding norms are given as

$$\|u\|_{W^{1,p}(\Omega; \mathbb{R}^M)} := \left(\|u\|_{L^p(\Omega; \mathbb{R}^M)}^p + \|Du\|_{L^p(\Omega; \mathbb{R}^{M \times N})}^p \right)^{1/p}$$

for $1 \leq p < \infty$,

$$\|u\|_{W^{1,\infty}(\Omega; \mathbb{R}^M)} := \|u\|_{L^\infty(\Omega; \mathbb{R}^M)} + \|Du\|_{L^\infty(\Omega; \mathbb{R}^{M \times N})}.$$

LIST OF FIGURES

1.1	Matrix-inclusion type (left) and free many-body structures (right) .	4
1.2	Structural elements of a pneumatic tire (courtesy of the Bridgestone Corporation)	6
1.3	A geometry mimicking the cord-belt characteristic layered structure	8
1.4	Model geometry for a free many-body structure	8
2.1	The two-dimensional microstructure \mathcal{D}_2	14
2.2	The two-dimensional many-body structure Ω_ε	14
2.3	Cord-belt of a tire (courtesy of the Bridgestone Corporation) . . .	15
2.4	The three-dimensional microstructure \mathcal{D}_3	15
2.5	Griffith-theory based fracture model	25
2.6	θ as in example 2.2 (left) and its derivative $f_{\text{back}} = \frac{d\theta}{dt}$ (right) . . .	27
2.7	Deformation of a straight beam: contact and self-interpenetration .	29
2.8	Rigid body motion exchanging the position of two bodies, which are enclosed in a rigid environment	33
2.9	An a.e.-injective deformation showing self-intersection	33
2.10	No minimum of the total energy in absence of a confinement condition	36
2.11	The backdriving force in the deformed configuration	45
4.1	Geometry of the discontinuity set S_φ , locally around x_0	79
4.2	Approximation of a line segment along the scaled mesh $\partial\mathcal{D}_2$. . .	79
4.3	A pre-deformation Φ_k , pulling a piecewise C^1 -hypersurface back onto a polyhedral set	84
4.4	A pre-deformation Φ_k that “slices” Ω	85
4.5	The trapezoidal environment $\mathcal{T}_{k,L}$	89
4.6	The Polygon $P_{k,L}$	90
4.7	The subdomains \mathcal{S}_i of $\mathcal{T}_{k,L}$	91
4.8	Constructing $\Phi_{k,L}$ on each \mathcal{S}_i^\pm	92
4.9	The mapping $\Phi_{j_0,K}$	98
4.10	The sets $\Omega_{j,\text{sliced}}$ and $\Omega_{j,\text{perf}}$ around $K \in \mathcal{K}(P)$	99

4.11	The geometrical situation of P_ψ in $K \in \mathcal{K}_{\partial\Omega}(P_\psi)$	104
4.12	The sets $\Omega_{\eta_1, \text{sliced}}$ and $\Omega_{\eta_1, \text{perf}}$ around $K \in \mathcal{K}_{\partial\Omega}(P_\psi)$	106
4.13	The tube \mathcal{T}_{η_2} and its construction over endpoints of P_{1, η_1} inside Ω and near $\partial\Omega$	108
4.14	The mapping Ψ_{2, η_2} on \mathcal{T}_{η_2}	109
4.15	The pre-deformation $\Phi_\eta _{\mathcal{T}_\eta} : \mathcal{T}_\eta \rightarrow \mathcal{T}_\eta$	118
4.16	Geometry of the discontinuity set S_φ , locally around x_0	122
4.17	Approximation of an area element along the scaled mesh $\partial\mathcal{D}_3$	123
4.18	The face A and the polyhedral set $P_{k, A}$	129
4.19	A crack in Ω nonparallel to the beam layers in \mathcal{D}_3	135
4.20	Nonzero cord-angle: Bending-isotropy through homogenization	146

BIBLIOGRAPHY

- Adams, R. A. and Fournier, J. J. F. (2003). *Sobolev spaces*, volume 140 of *Pure and Applied Mathematics (Amsterdam)*. Elsevier/Academic Press, Amsterdam, second edition.
- Allaire, G. (1992). Homogenization and two-scale convergence. *SIAM J. Math. Anal.*, 23(6):1482–1518.
- Ambrosio, L. (1989). A compactness theorem for a new class of functions of bounded variation. *Boll. Un. Mat. Ital. B (7)*, 3(4):857–881.
- Ambrosio, L., Fusco, N., and Pallara, D. (2000). *Functions of bounded variation and free discontinuity problems*. Oxford Mathematical Monographs. Oxford University Press, Oxford.
- Attouch, H. (1984). *Variational convergence for functions and operators*. Applicable Mathematics Series. Pitman (Advanced Publishing Program), Boston, MA.
- Ball, J. M. (1977). Convexity conditions and existence theorems in nonlinear elasticity. *Arch. Rational Mech. Anal.*, 63(4):337–403.
- Ball, J. M., Currie, J. C., and Olver, P. J. (1981). Null Lagrangians, weak continuity, and variational problems of arbitrary order. *J. Funct. Anal.*, 41(2):135–174.
- Braides, A. (2002). Γ -convergence for beginners, volume 22 of *Oxford Lecture Series in Mathematics and its Applications*. Oxford University Press, Oxford.
- Braides, A. (2009). Private communication.
- Braides, A. and Chiadò Piat, V. (2006). Another brick in the wall. In *Variational problems in materials science*, volume 68 of *Progr. Nonlinear Differential Equations Appl.*, pages 13–24. Birkhäuser, Basel.

- Ciarlet, P. G. (1988). *Mathematical elasticity. Vol. I. Three-dimensional elasticity*, volume 20 of *Studies in Mathematics and its Applications*. North-Holland Publishing Co., Amsterdam.
- Ciarlet, P. G. and Nečas, J. (1985). Unilateral problems in nonlinear, three-dimensional elasticity. *Arch. Rational Mech. Anal.*, 87(4):319–338.
- Ciarlet, P. G. and Nečas, J. (1987). Injectivity and self-contact in nonlinear elasticity. *Arch. Rational Mech. Anal.*, 97(3):171–188.
- Cortesani, G. (1997). Strong approximation of GSBV functions by piecewise smooth functions. *Ann. Univ. Ferrara Sez. VII (N.S.)*, 43:27–49 (1998).
- Cortesani, G. and Toader, R. (1999). A density result in SBV with respect to non-isotropic energies. *Nonlinear Anal.*, 38(5, Ser. B: Real World Appl.):585–604.
- Dal Maso, G. (1993). *An introduction to Γ -convergence*. Progress in Nonlinear Differential Equations and their Applications, 8. Birkhäuser Boston Inc., Boston, MA.
- Dal Maso, G. and Lazzaroni, G. (2008). Quasistatic crack growth in finite elasticity with non-interpenetration. Preprint available electronically at <http://cvgmt.sns.it/papers/dallaz08/DM-Laz-08pre2.pdf>.
- Ekeland, I. and Temam, R. (1976). *Convex analysis and variational problems*, volume 1 of *Studies in Mathematics and its Applications*. North-Holland Publishing Co., Amsterdam. Translated from the French.
- Evans, L. C. and Gariepy, R. F. (1992). *Measure theory and fine properties of functions*. Studies in Advanced Mathematics. CRC Press, Boca Raton, FL.
- Fonseca, I. and Leoni, G. (2007). *Modern methods in the calculus of variations: L^p spaces*. Springer Monographs in Mathematics. Springer, New York.
- Francfort, G. A. and Larsen, C. J. (2003). Existence and convergence for quasistatic evolution in brittle fracture. *Comm. Pure Appl. Math.*, 56(10):1465–1500.
- Giacomini, A. and Ponsiglione, M. (2008). Non-interpenetration of matter for SBV deformations of hyperelastic brittle materials. *Proc. Roy. Soc. Edinburgh Sect. A*, 138(5):1019–1041.
- Giaquinta, M., Modica, G., and Souček, J. (1998). *Cartesian currents in the calculus of variations. I*, volume 37 of *Ergebnisse der Mathematik und ihrer Grenzgebiete. 3. Folge. A Series of Modern Surveys in Mathematics*. Springer-Verlag, Berlin.

- Griffith, A. A. (1920). The phenomena of rupture and flow in solids. *Philos. Trans. Roy. Soc. London Ser. A*, 221:163–198.
- Iosif'yan, G. A. (2004). Homogenization of problems in the theory of elasticity with Signorini boundary conditions. *Mat. Zametki*, 75(6):818–833.
- Kikuchi, N. and Oden, J. T. (1988). *Contact problems in elasticity: a study of variational inequalities and finite element methods*, volume 8 of *SIAM Studies in Applied Mathematics*. Society for Industrial and Applied Mathematics (SIAM), Philadelphia, PA.
- Lukkassen, D., Nguetseng, G., and Wall, P. (2002). Two-scale convergence. *Int. J. Pure Appl. Math.*, 2(1):35–86.
- Marcus, M. and Mizel, V. J. (1973). Transformations by functions in Sobolev spaces and lower semicontinuity for parametric variational problems. *Bull. Amer. Math. Soc.*, 79:790–795.
- Mikelić, A., Shillor, M., and Tapiéro, R. (1998). Homogenization of an elastic material with inclusions in frictionless contact. *Math. Comput. Modelling*, 28(4-8):287–307.
- Negri, M. (1999). The anisotropy introduced by the mesh in the finite element approximation of the Mumford-Shah functional. *Numer. Funct. Anal. Optim.*, 20(9-10):957–982.
- Pantz, O. (2008). The modeling of deformable bodies with frictionless (self-)contacts. *Arch. Ration. Mech. Anal.*, 188(2):183–212.
- Scardia, L. (2008). Damage as gamma-limit of microfractures in linearized elasticity under the non-interpenetration constraint. Preprint available electronically at http://www.mis.mpg.de/preprints/2008/preprint2008_27.pdf.
- Signorini, A. (1933). Sopra alcune questioni di statica dei sistemi continui. *Ann. Scuola Norm. Sup. Pisa Cl. Sci. (2)*, 2(2):231–251.
- Temam, R. and Strang, G. (1980). Functions of bounded deformation. *Arch. Rational Mech. Anal.*, 75(1):7–21.
- Vodop'yanov, S. K. (2000). Topological and geometric properties of mappings with an integrable Jacobian in Sobolev classes. I. *Sibirsk. Mat. Zh.*, 41(1):23–48, i.
- Wong, J. Y. (2001). *Theory of ground vehicles*. John Wiley & Sons Inc., New York.